



XMTC

Thermal conductivity binary gas transmitter

User's manual

[no content intended for this page]

XMTC

Thermal conductivity binary gas transmitter

User's manual

**910-217 Rev. G
October 2013**



[no content intended for this page]

Information paragraphs

NOTE: These paragraphs provide information that provides a deeper understanding of the situation, but is not essential to the proper completion of the instructions.

IMPORTANT:

These paragraphs provide information that emphasizes instructions that are essential to proper setup of the equipment. Failure to follow these instructions carefully may cause unreliable performance.



CAUTION!

text omitted, not replaced - remove caution?



WARNING!

This symbol indicates a risk of potential serious personal injury, unless these instructions are followed carefully.

Safety issues

WARNING!



It is the responsibility of the user to make sure all local, county, state and national codes, regulations, rules and laws related to safety and safe operating conditions are met for each installation.

Auxiliary equipment

Local safety standards

The user must make sure that he operates all auxiliary equipment in accordance with local codes, standards, regulations, or laws applicable to safety.

Working Area

WARNING!



Auxiliary equipment may have both manual and automatic modes of operation. As equipment can move suddenly and without warning, do not enter the work cell of this equipment during automatic operation, and do not enter the work envelope of this equipment during manual operation. If you do, serious injury can result.

WARNING!



Make sure that power to the auxiliary equipment is turned OFF and locked out before you perform maintenance procedures on the equipment.

Qualification of personnel

Make sure that all personnel have manufacturer-approved training applicable to the auxiliary equipment.

Personal safety equipment

Make sure that operators and maintenance personnel have all safety equipment applicable to the auxiliary equipment. Examples include safety glasses, protective headgear, safety shoes, etc.

Unauthorized operation

Make sure that unauthorized personnel cannot gain access to the operation of the equipment.

Environmental compliance

Waste Electrical and Electronic Equipment (WEEE) directive

Panametrics is an active participant in Europe's Waste Electrical and Electronic Equipment (WEEE) take-back initiative, directive 2012/19/EU.

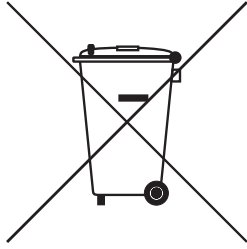

The equipment that you bought has required the extraction and use of natural resources for its production. It may contain hazardous substances that could impact health and the environment.

In order to avoid the dissemination of those substances in our environment and to diminish the pressure on the natural resources, we encourage you to use the appropriate take-back systems. Those systems will reuse or recycle most of the materials of your end life equipment in a sound way.

The crossed-out wheeled bin symbol invites you to use those systems.

If you need more information on the collection, reuse and recycling systems, please contact your local or regional waste administration.

Visit <https://www.bakerhughesds.com/health-safety-and-environment-hse> for take-back instructions and more information about this initiative.

Contents

Chapter 1. Features and capabilities	1
1.1 Introduction	1
1.2 Basic features	2
1.3 Theory of operation	2
1.4 System description	3
1.4.1 Packaging and temperature rating	3
1.4.2 2-port (sealed reference gas) version	3
1.4.4 Sample system	4
1.4.5 Extra cable (optional)	4
1.4.6 Power supply (optional)	4
1.4.7 TMO2D-TC display (optional)	4
1.4.8 XDP display (optional)	4
1.5 Typical Applications	5
Chapter 2. Installation	7
2.1 Introduction	7
2.2 Mounting the XMTC transmitter	7
2.3 Mounting the sample system	8
2.3.1 Manual, 2-port (sealed reference gas) sample system	8
2.3.2 Manual, 4-port (flowing reference gas) sample system	8
2.3.3 Sample systems with automatic switching	8
2.4 Wiring the XMTC transmitter	9
2.4.1 Grounding the enclosure	9
2.4.2 CE Mark compliance	9
2.4.3 Cable specifications	9
2.4.4 Wiring the signal connections	10
2.5 Connecting to other components	12
2.5.1 PS5R-C24 power Supply	12
2.5.2 TMO2D display	12
2.5.3 XDP display	12
2.5.4 Moisture series analyzers	12
Chapter 3. Operation and programming	13
3.1 Introduction	13
3.2 Powering up the XMTC	14
3.3 Starting the sample gas	14
3.4 Programming with IDM™	14

3.5	The edit functions menu	14
3.6	Field cal.	15
3.6.1	Perform cal.	15
3.6.2	Configure cal	16
3.6.3	Calibration drifts	17
3.6.4	Clear calibration	17
3.6.5	Hold last value	17
3.7	4-20 mA output	18
3.7.1	4-20 mA range	18
3.7.2	4 and 20 mA cal.	19
3.7.3	4-20 mA% test.	19
3.7.4	% gas test	19
3.8	Error handler	20
3.8.1	Total drift error	20
3.8.2	Drift/cal error.	21
3.8.3	Gas mV under/over range	21
3.8.4	Gas % under/over range	21
3.9	Factory cal.	22
3.9.1	Edit # of points	22
3.9.2	Edit point X	22
3.10	The advanced option	23
3.10.1	Fast response	23
3.10.2	Language	24
3.10.3	Meter ID	24
Chapter 4	Calibration	27
4.1	Introduction	27
4.2	Gas ranges and types	28
4.3	Required equipment and materials	28
4.4	Preparing the transmitter for calibration	29
4.5	2-port (sealed reference gas) calibration	29
4.6	4-port (flowing reference gas) calibration	29
Chapter 5	Specifications	31
5.1	Performance	31
5.2	Functional	31
5.3	Physical	32
5.4	Accessories	32

Appendix A. Supplemental information	33
A.1 Ordering information	33
A.2 Calibration specification ordering information	34
A.3 XMTC PCB subassemblies	34
A.4 Sample calibration sheet	35
A.5 Relative thermal conductivity of common gases	36
Appendix B. Typical applications	37
B.1 H₂ in N₂ in heat treat furnace atmospheres	37
B.1.1 Problem	37
B.1.2 Equipment	38
B.1.3 Basic operating procedure	38
B.1.4 Permanent installation	39
B.1.5 Specifications	39
B.1.6 Detailed operating procedure	39
B.2 H₂ purity in H₂-cooled electricity generator	40
B.2.1 Problem	40
B.2.2 Equipment	40
B.2.3 Basic operating procedure	41
B.2.4 How previously handled	41
B.2.5 Permanent installation	41
B.2.6 Specifications	41
B.2.7 Detailed operating procedure	42
Appendix C. Installation and wiring diagrams	43
Appendix D. The enhanced advanced option	57
D.1 Entering the enhanced advanced option	57
D.2 Heater	58
D.3 Balance bridge	59
D.4 Factory settings	59
D.5 Temperature comp.	60
Appendix E. CE Mark compliance	61
E.1 CE Mark requirements	61
E.2 EMI filter board	62
E.3 Wiring the signal connections for the weatherproof version	63
E.4 Wiring the signal connections for the explosion/flameproof version	64

[no content intended for this page]

Chapter 1. Features and capabilities

1.1 Introduction

This chapter introduces you to the features and capabilities of the Panametrics *XMTC thermal conductivity transmitter*. The following topics are discussed:

- Basic features of the XMTC thermal conductivity transmitter
- Theory of operation
- A system description of the XMTC, available options, and sample systems information on optional components is also provided, including a 24 VDC power supply, extra cable, and the TMO2D-TC display.
- A brief discussion of typical XMTC applications

XMTC technical specifications can be found in *Chapter 5. Specifications on page 31*. Ordering information can be found in *Appendix A. Supplemental information on page 33*.

1.2 Basic features

- The XMTC is a transmitter that measures the thermal conductivity of a binary (or pseudo-binary) gas mixture containing hydrogen, carbon dioxide, methane or helium, and provides a 4-20 mA signal proportional to the concentration of one of the gases in the mixture. It offers several unique design features:
- Ultra-stable thermistors and a temperature-controlled measuring cell (55°C/131°F standard, 70°C/158°F optional) provide excellent zero and span stability, as well as tolerance of ambient temperature variations.
- The measuring cell design makes it highly resistant to contamination and flow vibrations. Since it has no moving parts, the transmitter can handle the shock and vibration found in many industrial applications.
- A 2-port version for measurement of zero-based gas mixtures using a sealed reference gas (air or nitrogen) and a 4-port version for measurement of zero-suppressed gas mixtures (and some other special calibrations) using a flowing reference gas are available.
- The XMTC modular construction means that the unit can be field-calibrated quickly and easily. If desired, the plug-in measuring cell can be replaced with a pre-calibrated spare in minutes.
- The XMTC transmitter, with weatherproof or explosion-proof packaging, is designed to be installed as close as possible to the process sample point. It can be located up to 4000 ft (1200 m) from a display or recorder, using inexpensive unshielded cable.

1.3 Theory of operation

The XMTC measures the concentration of a gas in a binary gas mixture by measuring the thermal conductivity of the sample gas and comparing it to the thermal conductivity of a selected reference gas.

Two ultra-stable, glass-coated thermistors are used: one in contact with the sample gas, and the other in contact with a selected reference gas. The thermistors are mounted so that they are in close proximity to the stainless steel walls of the sample chamber. The entire sensor is heated to 55°C/131°F, (or 70°C/158°F) and the thermistors are heated above the sensor temperature using a constant current source. The thermistors lose heat to the walls of the sample chamber at a rate that is proportional to the thermal conductivity of the gas surrounding them. Thus, each thermistor will reach a different equilibrium temperature. The temperature difference between the two thermistors is detected in an electrical bridge circuit. It is then amplified and converted to a 4-20 mA output proportional to the concentration of one of the constituents of the binary gas mixture. For example:

- To measure 0 to 25% H₂ in N₂, the reference gas would be air (2-port version, sealed reference gas), and for calibration, the zero gas would be 100% N₂ (i.e. 0% H₂) and the span gas would be 25% H₂ in N₂.
- To measure 90-100% H₂ in N₂, the reference gas would be 100% H₂ (4-port version, flowing reference gas), the zero gas would be 90% H₂ in N₂, and the span gas would be 100% H₂ (the same as the reference gas).

NOTE: The XMTC has polarity adjustment jumpers which permit the measurement of gases (such as CO₂) that have a relative thermal conductivity less than air/nitrogen.

Appendix A. Supplemental information on page 33, contains a table of relative thermal conductivity of common gases. Figure 1 below shows some of these values graphically.

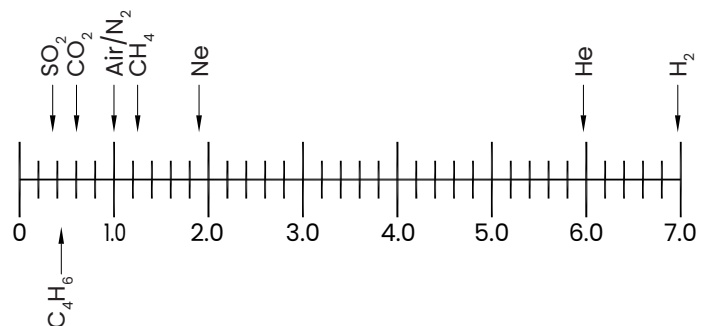

Figure 1: Relative thermal conductivity of Some common gases

1.4 System description

The basic XMTC measurement system consists of an XMTC transmitter mounted in a sample system. The sample system is mandatory, and can either be provided by Panametrics or constructed according to Panametrics recommendations. The XMTC is supplied with a standard 10 ft (3 m), 4-wire cable for power and output connections, with lengths up to 4000 ft (1200 m) available. Optionally available from Panametrics are a 24-VDC power supply to power the XMTC, a remote display with programming and control capabilities, and several analyzers which can be interfaced with the XMTC.

1.4.1 Packaging and temperature rating

The XMTC transmitter is self-contained, consisting of the thermal conductivity sensor and associated electronics. It requires 24 VDC power (1.2 A maximum at power-up), and provides a 4-20 mA output signal proportional to the concentration of one of the gases in the binary sample gas mixture.

The XMTC is designed to be installed in a sample system as close as possible to the process sample point. Thus, it is available in two environmental packages:

- Weatherproof
- Explosion-proof (with the addition of flame arrestors to the sample/reference gas inlet and outlet)

Each environmental package is available in a standard 2-port (sealed reference gas) version, or an optional 4-port (flowing reference gas) version.

The XMTC is supplied with a standard measurement cell operating temperature of 55°C (131°F). An optional 70°C (158°F) cell operating temperature is available.

NOTE: The 70°C (158°F) operating temperature should be selected only for high temperature applications, because it results in reduced sensitivity.

1.4.2 2-port (sealed reference gas) version

This standard configuration (see *Figure 2* below) is used for zero-based ranges with air or nitrogen at atmospheric pressure as the balance or background gas. It utilizes air with desiccant in a factory sealed chamber as the reference gas. The following standard ranges and gases are available:

Ranges:	Gases:
0-2%	H ₂ in N ₂ or air
0-5%	CO ₂ in N ₂ or air (min. range 0-5% CO ₂)
0-10%	SO ₂ in air (min. range 0-2% SO ₂)
0-25%	He in N ₂ or air
0-50%	Argon in N ₂ or air
0-100%	
50-100%	
80-100%	
90-100%	
95-100%	
98-100%	

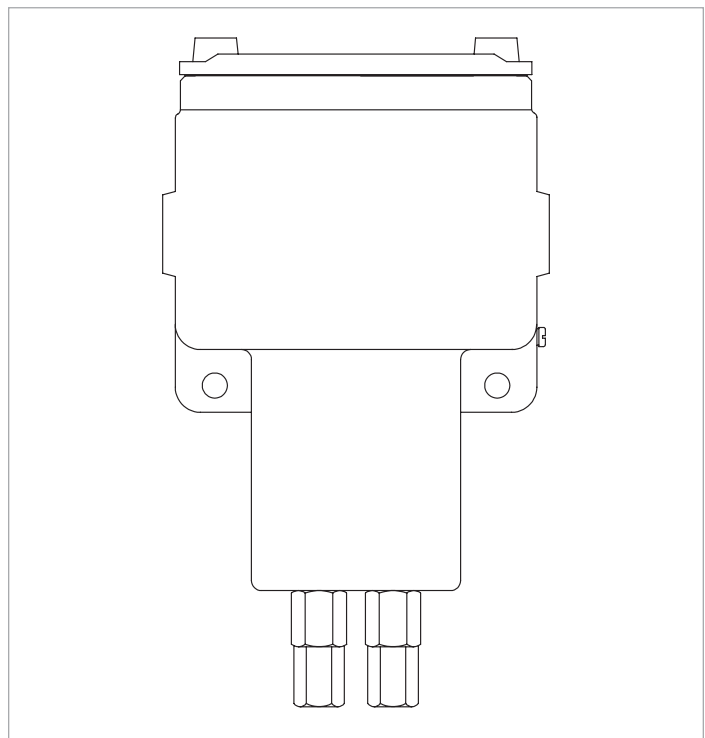

Figure 2: 2-port (sealed reference gas) XMTC

1.4.3 4-port (flowing reference gas) version

This optional configuration shown in *Figure 3* below is used for zero-suppressed ranges and some other special applications. Typically, a flowing reference gas of 100% H₂ or CO₂ is used. The following standard ranges and gases are available:

Ranges:	Gases:
90 to 100%	H ₂ in N ₂
80 to 100%	CO ₂ in N ₂ or air
	He in N ₂ or air

NOTE: For factory calibration pricing on the standard ranges and gases, or for pricing on other zero-suppressed ranges and gases, please consult the factory.

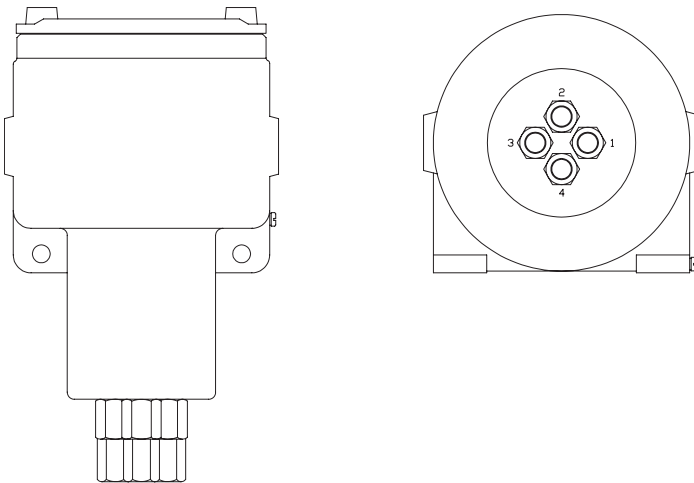

Figure 3: 4-port (flowing reference gas) XMTC

1.4.4 Sample system

Use of a sample system is mandatory with the XMTC. The design of the sample system depends on the conditions of the sample gas and the requirements of the application. In general, a sample system must deliver a clean, representative sample to the XMTC at a temperature, pressure and flow rate that are within acceptable limits. Standard XMTC sample conditions are as follows:

- Temperature less than 50°C (122°F) for 55°C cell operating temperature
- Atmospheric pressure
- Flow rate 0.5 SCFH (250 cc/min)

Panametrics offers sample systems for a wide variety of applications. Two standard sample systems for the XMTC are shown in *Chapter 2. Installation on page 7*. For assistance in designing your own sample system, please consult the factory.

1.4.5 Extra cable (optional)

Panametrics provides a 10 ft (3 m) length of 4-wire, color-coded cable with each XMTC to connect the power and outputs. Optional cables are available in lengths up to 4000 ft (1200 m). If you are using your own cable, refer to *Table 1: Panametrics 4-wire XMTC cable on page 9* for recommendations.

1.4.6 Power supply (optional)

The XMTC requires 24 VDC at a maximum start-up current of 1.2 A. The Panametrics PS5R-C24 power supply converts 100/120/220/240 VAC to the required 24 VDC for the XMTC.

1.4.7 TMO2D-TC display (optional)

The Panametrics TMO2D-TC display provides a two-line x 24 character back-lit LCD. It also features display and option programming, recorder outputs, alarm relays, and relays for driving sample system solenoids for automatic zero and span calibration of the XMTC. For information on the TMO2D-TC, please contact Panametrics.

1.4.8 XDP display (optional)

The Panametrics XDP explosion-proof display provides an integral, voltage-stabilized 24 VDC power supply, a 3-digit display with adjustable 4-20 mA input range, two SPDT alarm relays rated for 1 A/250 VAC, and a 4-20 mA output that is isolated from the input and adjustable to a second independent range if required. For information on the XDP, please contact Panametrics.

1.5 Typical Applications

The XMTC can be used in a wide variety of industrial applications where it is necessary to measure the concentration of one component of a binary gas mixture. It can also be used in pseudo-binary gas mixtures where the ratio of concentrations of the background gas components remains constant, and in gaseous mixtures where the thermal conductivity of the gas of interest is significantly different from that of the background gas. Some typical industries and applications include:

- **Metals industry**
H₂ in heat treat furnace atmospheres
- **Electric power industry**
H₂ in generator cooling systems
- **Gas production industry**
Purity monitoring of argon, hydrogen, nitrogen, helium
- **Chemical industry**
H₂ in ammonia synthesis gas
H₂ in methanol synthesis gas
H₂ in chlorine plants
- **Food industry**
CO₂ in fermentation processes
Ethylene Oxide (ETO) sterilization
- **Steel industry**
H₂ in blast furnace top gas
- **Petroleum industry**
H₂ in hydrocarbon streams

Two very common applications are:

- **H₂ in N₂ in heat treat furnace atmospheres:**
Zero-based 0-25% H₂, 2-port
(sealed reference gas, air)
- **H₂ purity in H₂ electricity generator cooling:**
Zero-suppressed, 80-100% H₂, 4-port
(flowing reference gas, 100% H₂)

For more details on these applications, refer to *Appendix B. Typical applications on page 37*. For details on applications not shown in *Appendix B*, or if you wish to discuss your own application, please contact Panametrics.

[no content intended for this page]

Chapter 2. Installation

2.1 Introduction

This chapter describes how to install the XMTC transmitter and its sample system. It also contains information on connecting the XMTC to optional system components.

The following topics are discussed:

- Mounting the XMTC transmitter
- Installing a Panametrics sample system
- Wiring the XMTC transmitter
- Connecting the XMTC transmitter to optional components

2.2 Mounting the XMTC transmitter

This section applies only if you are mounting the XMTC transmitter in a sample system that has not been supplied by Panametrics.

Your sample system should deliver a clean, representative sample to the XMTC at the proper temperature, pressure and flow rate. This usually means a clean, dry sample (free of solid and liquid particulates) at atmospheric pressure; a temperature no greater than 50°C (122°F); and a flow rate of approximately 0.5 SCFH (250 cc/min). Since factory calibration of the sensor is at atmospheric pressure and 0.5 SCFH, higher or lower operating pressure may necessitate field-calibration adjustment.

A simple sample system for a 2-port XMTC might have inlet and outlet flow-regulating needle valves, a flow meter, and a pressure gauge, in addition to the XMTC transmitter.

The XMTC transmitter should be mounted in the sample system so that it is upright and level to within $\pm 15^\circ$. Also, provide at least 9 in. (230 mm) of clearance above the top cover of the transmitter to allow access to the transmitter printed circuit board (PCB) for calibration and maintenance. For a 2-port XMTC, connect the sample system sample inlet and sample outlet ports to the appropriate XMTC port. For a 4-port system, also connect the reference inlet and reference outlet ports to the appropriate XMTC ports.

NOTE: Refer to *Appendix C. Installation and wiring diagrams on page 43*, for port locations and other information.



WARNING!

Be sure your installation conforms to all safety and electrical code requirements.

2.3 Mounting the sample system

You can order a complete sample system from the factory. This includes the XMTC transmitter and all necessary components and sample tubing mounted on a metal panel. Several standard sample systems are available, and custom-designed sample systems can be built to your exact specifications.

Mount the sample system as close to the process sample point as possible. Once the sample system is mounted, connect all inlet and outlet lines via the 1/4" compression fittings on the sample system. The sample line leading from the process to the sample system should be of 1/4" stainless steel tubing, and should be as short as possible in order to ensure a representative sample.

Following are descriptions of two standard sample systems:

2.3.1 Manual, 2-port (sealed reference gas) sample system

Figure 4 below shows a basic sample system for a 2-port (sealed reference gas) XMTC. This sample system consists of inlet needle valves for sample, zero, and span gases; a ball valve; a 2-port XMTC; a pressure gauge; and a flowmeter. All components are mounted on a painted steel plate. Other components could be added for filtration (filter/coalescer), pressure control (regulator), or flow control (pump).

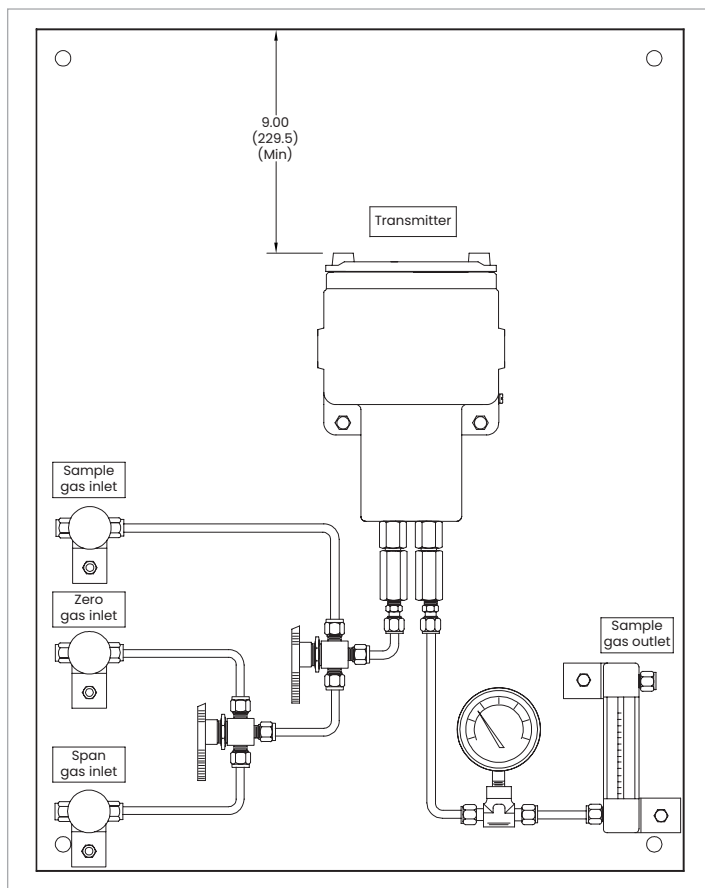

Figure 4: Basic 2-port sample system (732-164)

2.3.2 Manual, 4-port (flowing reference gas) sample system

Figure 5 below shows a basic sample system for a 4-port (flowing reference gas) XMTC. This sample system consists of inlet needle valves for sample, reference, and calibration gases; a 4-port XMTC; two pressure gauges; and two flow meters. All components are mounted on a painted steel plate. Other components could be added for filtration (filter/coalescer), pressure control (regulator), or flow control (pump).

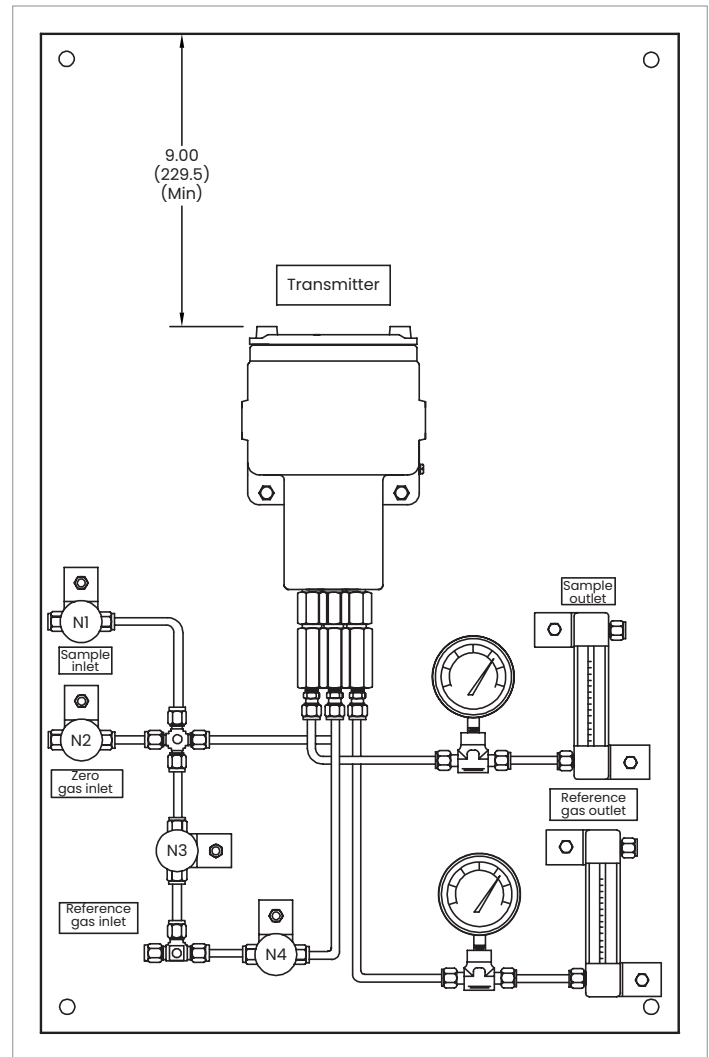

Figure 5: Basic 4-port sample system (732-028)

2.3.3 Sample systems with automatic switching

Also available from Panametrics are sample systems with electrically-actuated, three-way solenoid valves. When used in conjunction with a TMO2D or XDP display (with the auto cal option), these systems allow automatic switching of sample, zero, span, and reference gases during operation and calibration. Refer to *Appendix B. Typical applications on page 37*, for details on sample systems designed by Panametrics for specific applications.

2.4 Wiring the XMTC transmitter



CAUTION!

Always apply power to the XMTC immediately after installation, especially when it is mounted outdoors or in a humid area.

This section describes how to wire the XMTC for 24 VDC power, RS232 communication, 4–20 mA output, and optional devices.

2.4.1 Grounding the enclosure



WARNING!

The XMTC transmitter enclosure must be properly grounded.

Connect the external ground screw on the XMTC enclosure (see *Figure 6* below) to a suitable earth ground.

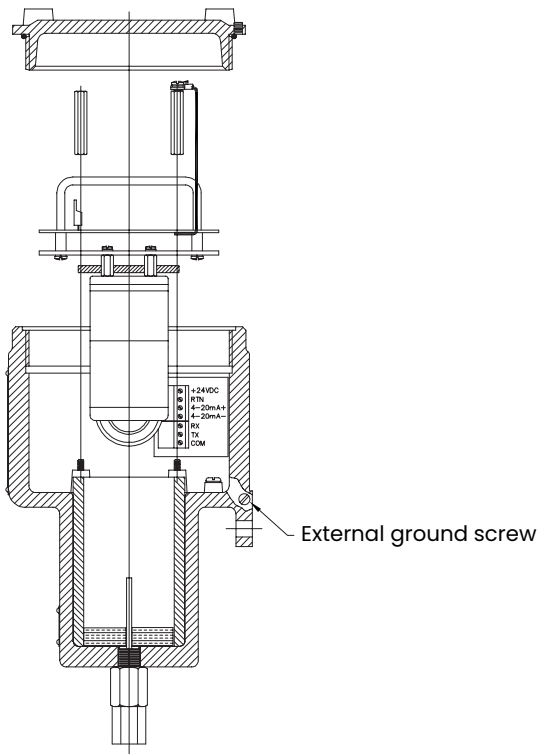

Figure 6: Ground screw location

2.4.2 CE Mark compliance



WARNING!

To meet CE Mark requirements, you must shield and ground all electrical cables as described in *Appendix E. CE Mark compliance on page 61*.



WARNING!

CE Mark compliance is required for all units installed in EU countries.



WARNING!

Cable entries of an approved flameproof design are required. These must be installed according to the manufacturer's instructions the choice of cable entry device may limit the overall installation category achieved.

2.4.3 Cable specifications

Table 1 below shows the transmitter wiring connections for the standard Panametrics XMTC cable, P/N X4(10). This cable can be used for distances up to 4000 ft (1200 m).

Table 1: Panametrics 4-wire XMTC cable			
Lead	Color	AWG	Terminal
+24 VDC line	Red	22	TB1-1
24 VDC return	Black	22	TB1-2
4–20 mA (+)	White	22	TB1-3
4–20 mA (–)	Green	22	TB1-4

If you are using your own cable to wire the XMTC, refer to *Table 2* below for the cable requirements.

Table 2: Non-Panometrics 4-wire XMTC cable			
Maximum cable length		Wire size	
ft	m	AWG	mm ₂
450	130	22	0.35
700	200	20	0.60
1,050	320	18	1.00
1,700	500	16	1.20
2,800	850	14	2.00
4,000	1,200	12	3.00

Table 3 below shows the connections for the Panometrics standard 3-wire RS232 cable (P/N 704-668), which is available with a male or female DB-9 or a DB-25 connector. This cable is available in standard lengths of 6 ft (2 m) and 12 ft (4 m).

Table 3: Panometrics 3-wire RS232 cable			
Lead	Color	AWG	Terminal
RX	Red	226.	TB2-1
TX	White	22	TB2-2
GND	Green	22	TB2-3

NOTE: See *EIA-RS serial communications* (document 916-054) for detailed RS232 wiring instructions.

2.4.4 Wiring the signal connections

The XMTC power input, analog output, and RS232 connections are made to terminal blocks TB1 and TB2, which are accessed by removing the XMTC cover. See *Figure 7* below for the location and pin designations for terminal blocks TB1 and TB2. Also refer to *Appendix C. Installation and wiring diagrams on page 43.*

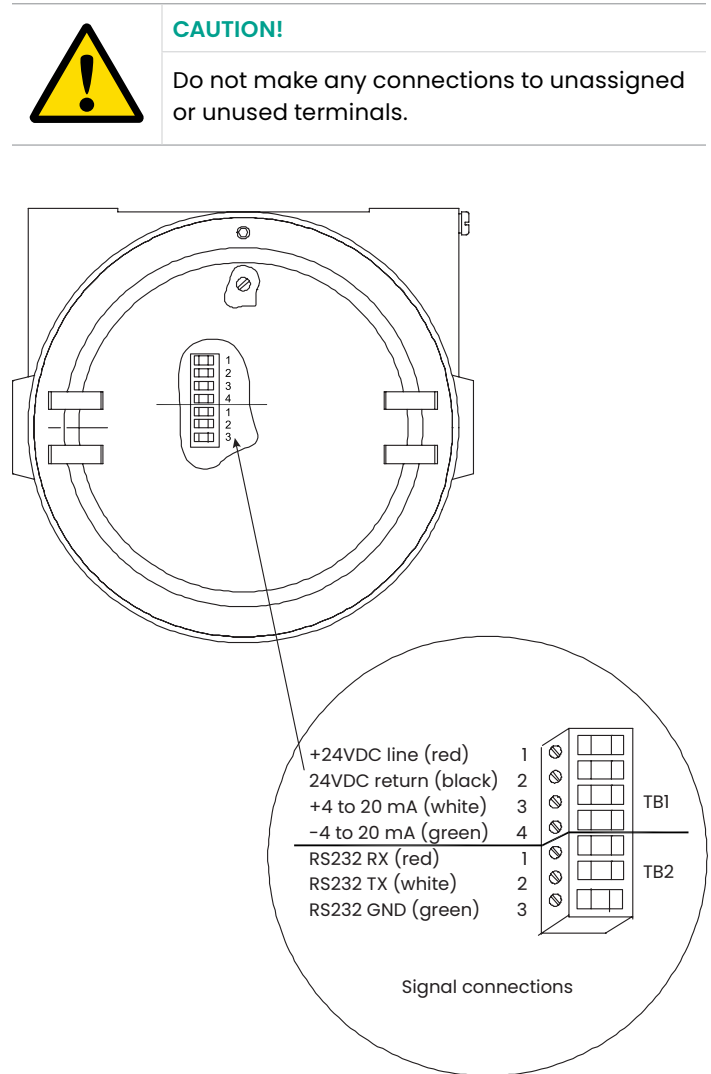

Figure 7: XMTC Signal wiring connections

Use the following steps to make the proper wiring connections:



WARNING!

Cable entries of an approved explosion-proof design are required. These must be installed according to the manufacturer's instructions. The choice of cable entry device may limit the overall installation category achieved.

1. Install the selected cable entry device, such as conduit or seal-off, in accordance with the manufacturer's instructions.

NOTE: If installation of the cable entry device is only partially complete, Panametrics recommends tagging the device to ensure the safety of subsequent users.

2. Route the cable into the XMTC.
3. Unplug the TB1 and TB2 connectors by pulling them straight off the PCB, and loosen the screws on the sides of the connectors.
4. Connect the power leads:



CAUTION!

Connecting the +24 VDC line (red) lead to any terminal except TBI-1 will damage the XMTC.

- a. Insert the 4-wire cable +24 VDC line (red) lead into pin TBI-1 and tighten the screw.
 - b. Insert the 4-wire cable 24 VDC return (black) lead into pin TBI-2 and tighten the screw.
5. Connect the analog output leads:
 - a. Insert the 4-wire cable + 4-20 mA (white) lead into pin TBI-3 and tighten the screw.
 - b. Insert the 4-wire cable - 4-20 mA (green) lead into pin TBI-4 and tighten the screw.

IMPORTANT:

You can use either an RS232 serial port (discussed in step 6) or an RS485 serial port (discussed in step 7), but not both.

6. Connect the RS232 serial port leads:
 - a. Insert the 3-wire cable RX (red) lead into pin TB2-1 and tighten the screw.
 - b. Insert the 3-wire cable TX (white) lead into pin TB2-2 and tighten the screw.
 - c. Insert the 3-wire cable GND (green) lead into pin TB2-3 and tighten the screw.
7. Connect the RS485 serial port leads.
 - a. Locate the jumpers J7 and J8 on the main PCB, using *Figure 8* below as a guide. Move the jumpers from the left (RS232) side to the right (RS485) side.
 - b. Connect the other end of the cable to the RS485 converter, as shown in *Figure 8* below.

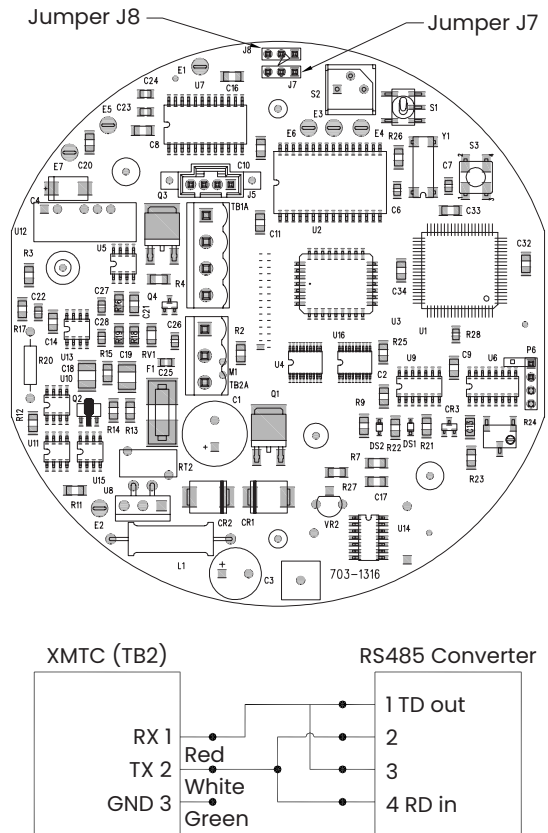

Figure 8: Jumper locations and RS485 connections

8. Carefully plug the TB1 and TB2 connectors back onto the PCB, and reinstall the cover on the XMTC.
9. Connect the other ends of the cables to the 24 VDC power supply, the 4-20 mA input of the display device, and the serial port of the computer or terminal (see the instruction manuals for those devices for details).

2.5 Connecting to other components

This section gives interconnection details for using other Panametrics devices in conjunction with your XMTC.

2.5.1 PS5R-C24 power Supply

The Panametrics 24-Volt power supply converts 100/120/220/240 VAC to 24 VDC for use with the XMTC. *Figure 9* below shows an interconnection diagram for the XMTC and the PS5R-C24 power supply.

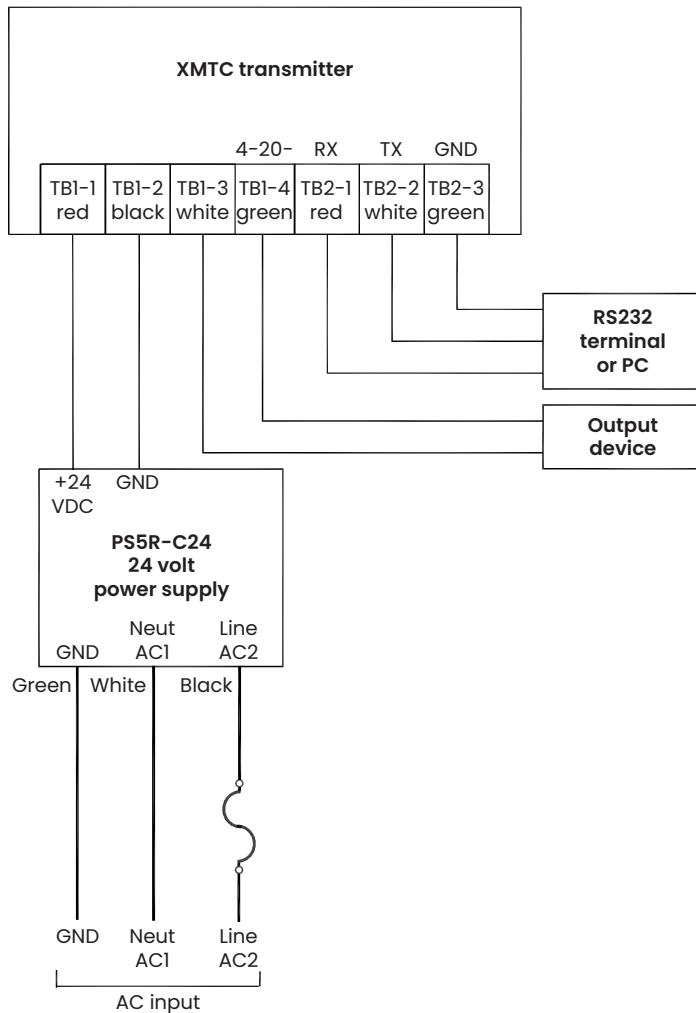

Figure 9: Interconnection diagram

2.5.2 TMO2D display

The Panametrics TMO2D display provides a two-line x 24 character back-lit LCD. It also features display and option programming, recorder outputs, alarm relays, and optional relays for driving sample system solenoids for automatic zero and span calibration of the XMTC. See *Figure 72 on page 56* for an interconnection diagram for the XMTC and the TMO2D, and refer to the ***TMO2D User's manual (910-084)*** for details on its operation.

2.5.3 XDP display

The XDP explosion-proof display package provides an integral, voltage-stabilized 24 VDC power supply, a 3-digit display with adjustable 4-20 mA input range, two SPDT alarm relays rated for 1 A/250 VAC, and a 4-20 mA output that is isolated from the input and adjustable to a second independent range if required. The XDP is supplied in a weatherproof and explosion-proof enclosure that is rated for EEx d IIC T6 and IP66. See *Figure 72 on page 56* for interconnection diagrams for the XMTC and the MIS-1, MIS-2 and MMS-3 analyzers, and refer to the ***XDP User's manual (910-204)*** for details on its operation.

2.5.4 Moisture series analyzers

The Panametrics moisture image series 1 (MIS-1) and Moisture monitor series 3 (MMS-3) analyzers accept inputs from a variety of sensors (including the XMTC) and offer new graphical and digital user interfaces, improved performance, and low range calibration. See *Figure 72 on page 56* for interconnection diagrams for the XMTC and the MIS-1 and MMS-3 analyzers, and refer to the appropriate ***User's manual*** for details on operating the MIS-1 (910-108) or MMS-3 (910-110) analyzer.

Chapter 3. Operation and programming

3.1 Introduction

This chapter provides information on operating the XMTC transmitter. The following topics are discussed:

- Powering up the XMTC
- Basic sample gas considerations
- Programming the XMTC with Panametrics instrument data manager (IDM™) software

If you have not already done so, please read *Chapter 2. Installation on page 7*, for details on mounting and wiring the XMTC and the sample system.

3.2 Powering up the XMTC



WARNING!

It is the responsibility of the user to ensure that all cable entry devices and covers are properly installed and secure prior to applying power to the XMTC.

The XMTC does not have a power switch. It begins operating as soon as it is connected to a 24 VDC power source. Because the XMTC is controlled at a constant 55°C (131°F) operating temperature, allow 30 minutes for the unit to warm up and reach temperature stability. During this time, you can establish a sample gas flow through the sample system.

3.3 Starting the sample gas

Open the necessary valves to establish a sample gas flow of 0.5 SCFH (250 cc/min) at atmospheric pressure. Make sure that nothing obstructs the flow of sample gas, thereby causing a pressure buildup in the sensing chamber. For proper operation, the XMTC should be vented to atmosphere.

NOTE: Unless otherwise specified, the XMTC is factory calibrated at atmospheric pressure and 0.5 SCFH (250 cc/min) and should therefore be operated at atmospheric pressure. Operating the XMTC at any other pressure will necessitate a field calibration at that pressure in order to maintain accuracy. See *Chapter 4. Calibration on page 27*, for more information.

If you are using the 4-port (flowing reference gas) configuration, open the necessary valves to establish a reference gas flow of 0.5 SCFH (250 cc/min) at atmospheric pressure.

NOTE: If desired, you can use a reference gas flow as low as 5 cc/min to conserve gas.

3.4 Programming with IDM™

The XMTC is factory-programmed and ready for immediate use. However, if you wish to check or change the calibration, you can access the XMTC programming from your PC, using Panametrics instrument data manager (IDM) software. IDM also allows you to upload or download site files, display data, and log and view real-time data and diagnostic data in numeric, bar chart or line chart formats. For further information on the display and logging functions, refer to the *Instrument data manager user's manual* (910-185).

NOTE: Be sure to install instrument data manager on your PC before attempting to program the XMTC.

3.5 The edit functions menu

To access the XMTC calibration, you must open the *edit functions* menu in the instrument window. See *Chapter 5, Using the instrument menu*, in the *Instrument data manager user's manual* for more information on the instrument menu. The menu consists of the five commands shown in *Figure 10* below. To access a command, select it from the list of options.

NOTE: While following the programming instructions, refer to *Figure 51 on page 25* and *Figure 52 on page 26*.

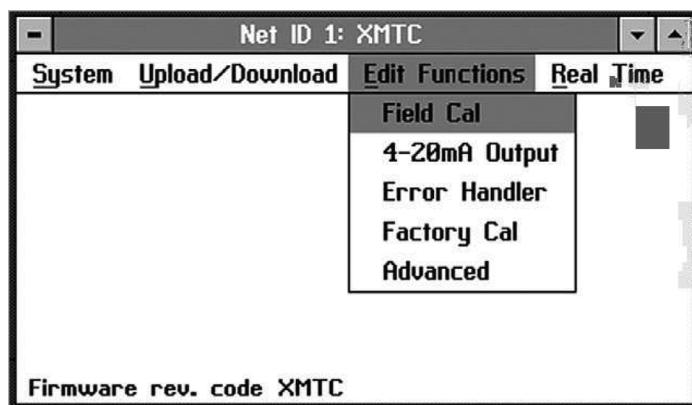

Figure 10: Edit functions menu

Three buttons appear on the right side of all menu windows: *previous item*, *next item/enter*, and *exit page* (see *Figure 11 on page 15*):

- Clicking on *previous item* returns you to the previous window (either the command menu or the previous parameter entered).
- *Next item/enter* confirms the selection or data entered, and either opens the next window or returns you to the command menu (depending on your position in the program).
- *Exit page* returns you to the command menu.

3.6 Field cal

When you select the *field cal* command, a window similar to the one in *Figure 11* below opens.

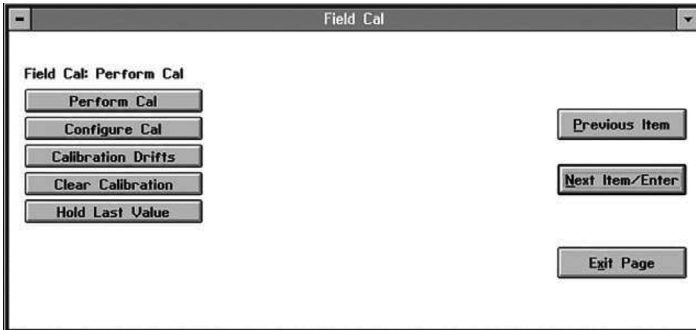

Figure 11: Field cal window

The field cal command offers five options:

- **Perform cal** – enables you to calibrate the XMTC with IDM
- **Configure cal** – enables you to set the calibration type and parameters
- **Calibration drifts** – indicates drift percentages for the zero and span gases
- **Clear calibration** – enables you to clear the last calibration
- **Hold last value** – causes the XMTC to hold the last value calibrated.

Clicking on any option opens that option, while clicking on *next item/enter* opens the menu listed on the status line above the options.

3.6.1 Perform cal

Click on *perform cal* to open a window similar to *Figure 12* below.

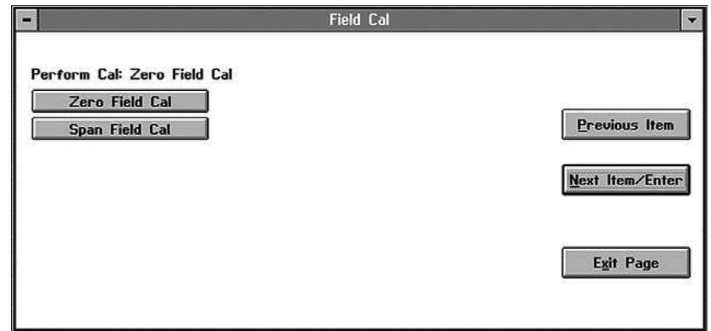

Figure 12: Perform cal window

Click on *zero field cal* to calibrate the zero value, or on *span field cal* to calibrate the span value. In either case, a window similar to *Figure 13* below opens.

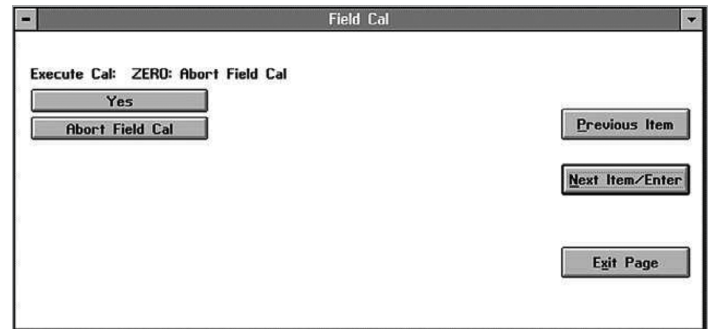

Figure 13: Field cal execution window

Click *yes* to calibrate, or *abort field cal* to stop the calibration and return to the previous menu. The result of a completed calibration is shown in *Figure 14* below.

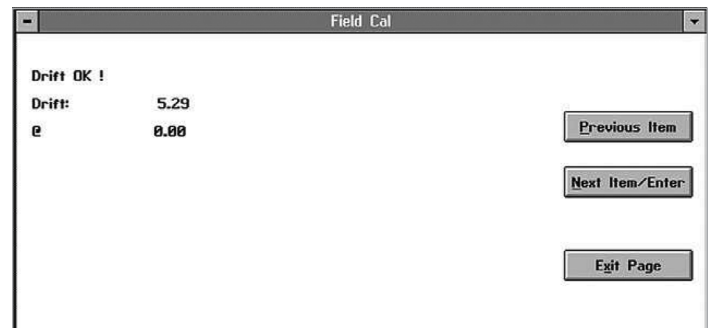

Figure 14: Field cal results window

Click on *previous item* or on *next item/enter* to return to the previous window, or on *exit page* to return to the instrument menu.

3.6.2 Configure cal

The *configure cal* command enables you to change the field calibration type and parameters: the percentage of zero or span gas, delay time before or after, and maximum total drift and drift of calibration. When you click on *configure cal*, a window similar to *Figure 15* below opens. Clicking on any option opens the window for that option, while clicking on *next item/enter* opens the menu listed on the status line above the options.

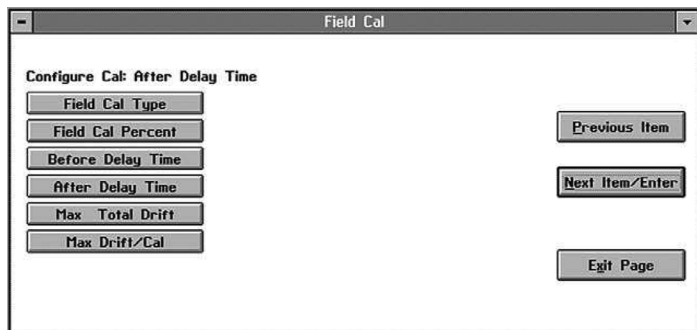

Figure 15: Configure cal window

3.6.2a Field cal type

The window for *field cal type* is similar to *Figure 16* below.

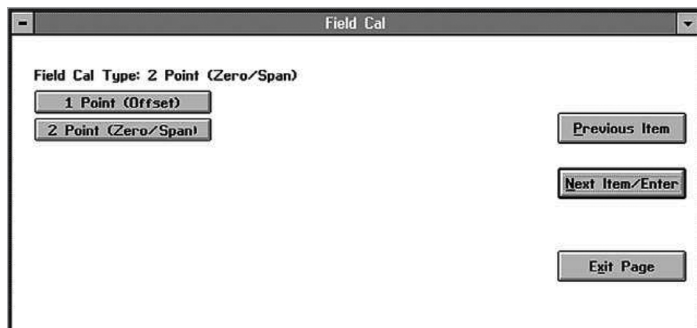

Figure 16: Field cal type window

Click on *1 point* to select 1-point (offset, or 1-gas) calibration, or on *2-point* to select 2-point (zero/span, or 2-gas) calibration. Then, click on any button on the right to return to the *configure cal* window.

3.6.2b Field cal percent

The window for *field cal percent* is similar to *Figure 17* below.

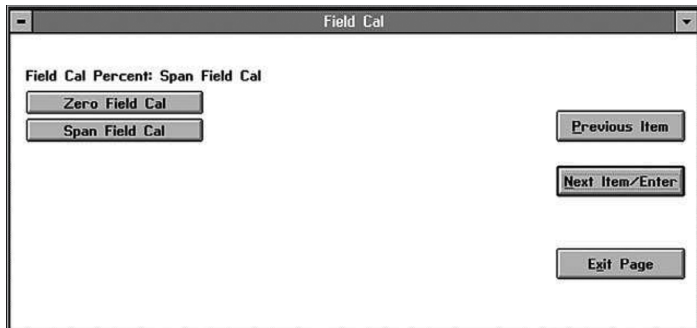

Figure 17: Field cal percent window

Click on *zero field cal* to enter the zero percentage, or on *span field cal* to enter the span percentage. In either case, a window similar to *Figure 18* below opens.

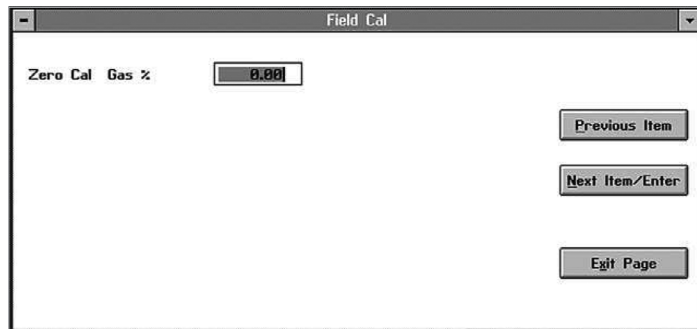

Figure 18: Gas percentage entry window

Type the desired percentage in the text box, and click *next item/enter* to confirm the entry. (Click *previous item* or *exit page* to close the window without changing the percentage.)

3.6.2c Before delay time and after delay time

The windows for both *before delay time* and *after delay time* are similar to *Figure 19* below.

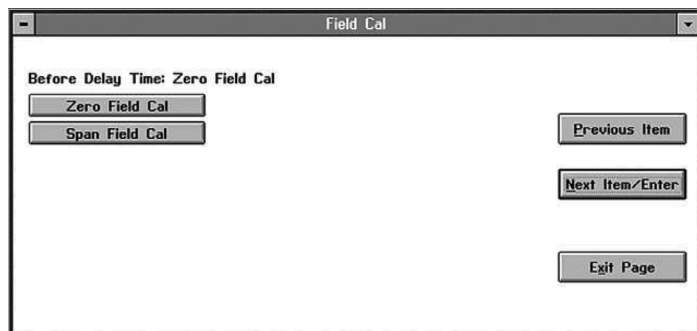

Figure 19: Before delay time window

For either time, click on *zero field cal* to enter the delay time for the zero calibration, or on *span field cal* to enter the time for the span calibration. A window similar to *Figure 20* below opens.

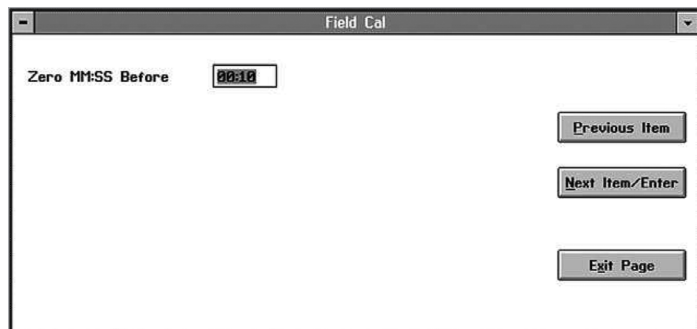

Figure 20: Delay time entry window

Enter the desired number of minutes and seconds in the text box, and click *next item/enter* to confirm the entry. (Click *previous item* or *exit page* to close the window without changing the percentage.) You are then returned to the *configure cal* window.

3.6.2d Max total drift and max drift/cal

Max total drift is the maximum total drift allowable as a percentage of full scale, while max drift/cal is the maximum drift allowable per calibration as a percentage of full scale. The windows for both max total drift and max drift/cal are similar to Figure 21 below.

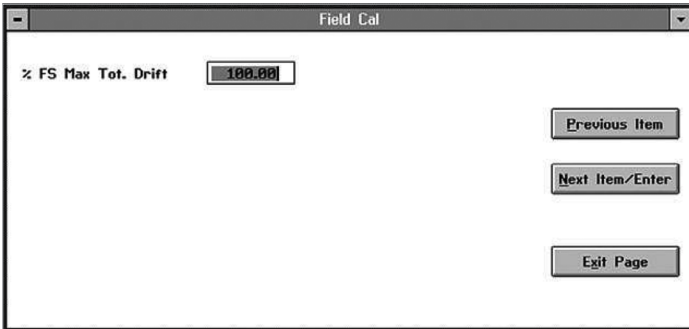

Figure 21: Max Total drift entry window

Enter the desired percentage of full scale in the text box, and click next item/enter to confirm the entry. (Click previous item or exit page to close the window without changing the percentage.) You are then returned to the configure cal window.

3.6.3 Calibration drifts

The calibration drifts command enables you to view the drift of both zero and span gases since the last calibration. A window similar to Figure 22 below opens.

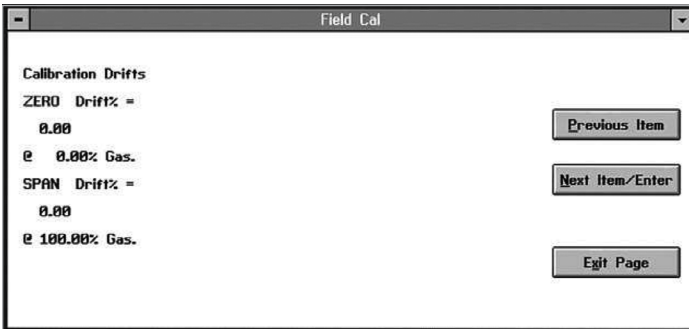

Figure 22: Calibration drifts window

Click on any button to return to the field cal window.

3.6.4 Clear calibration

The window for the clear calibration command is similar to Figure 23 below.

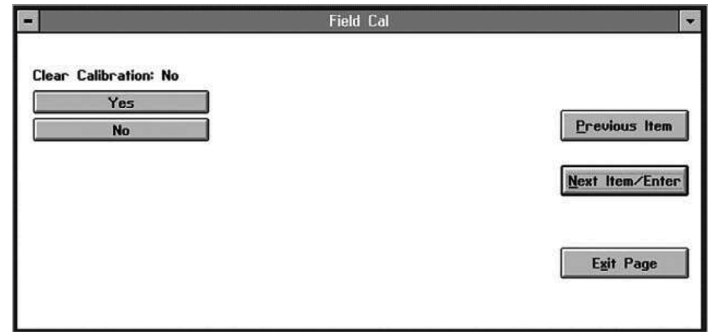

Figure 23: Clear calibration window

Click on yes to clear the most recent calibration, or on no, previous item or exit page to close the window without clearing the calibration. If you click on yes and then on next item/enter, a window similar to Figure 24 below opens.

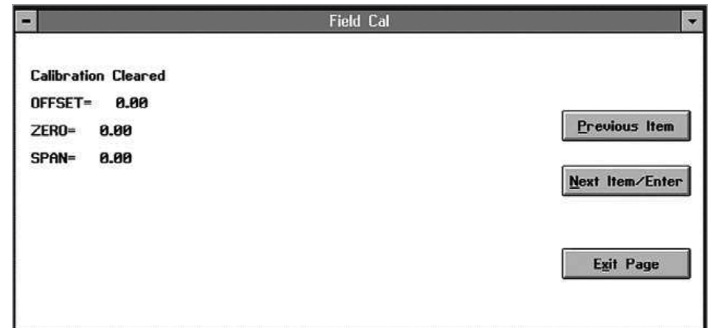

Figure 24: Typical cleared calibration window

Click on previous item to return to the clear calibration window, or on next item/enter or exit page to return to the field cal window.

3.6.5 Hold last value

Besides performing a calibration or configuring values, you can program the XMTC to hold the last calibrated value. From the field cal window (see Figure 11 on page 15), click on hold last value. The window remains the same, except that the button changes to disable hold last. Click next item/enter to confirm the entry, or previous item or exit page to close the window without changing the value.

3.7 4-20 mA output

The *4-20 mA output* command enables you to modify the output that the XMTC sends to an external device such as a recorder or digital multimeter. When you click on the *4-20 mA output* command from the *edit functions* menu (Figure 10 on page 14), a window similar to Figure 25 below opens. Clicking on any option opens the window for that option, while clicking on *next item/enter* opens the menu listed on the status line above the options.

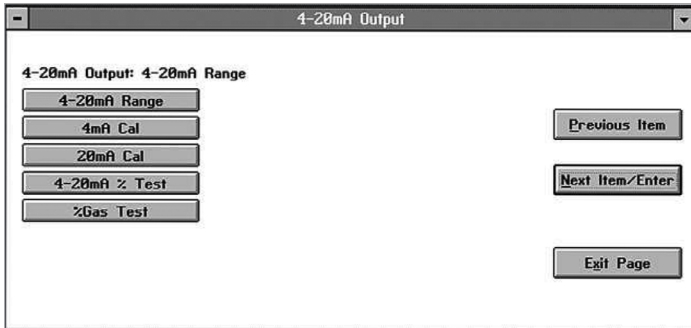

Figure 25: 4-20 mA output window

3.7.1 4-20 mA range

The window for *4-20 mA range* is similar to Figure 26 below.

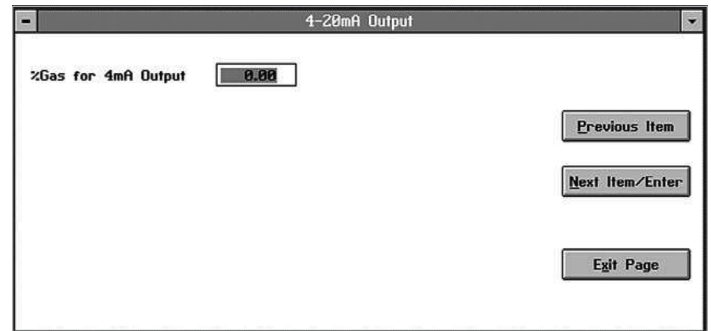

Figure 26: 4 mA output gas percentage window

Enter the desired percentage of gas for the 4 mA output in the text box. Clicking on *next item/enter* opens the window for the 20 mA output, shown in Figure 27 on page 18.

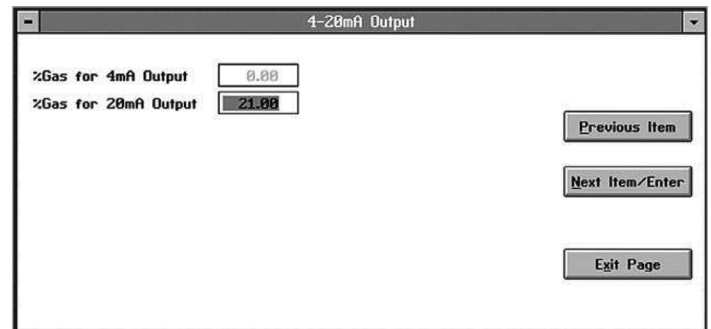

Figure 27: 20 mA output gas percentage window

Enter the desired percentage of gas for the 20 mA output, and click *next item/enter* to confirm the entry. The next prompt is: "Clamp 4-20 mA output?" Click on either *no* or *yes* from the drop-down menu. A clamped reading never exceeds the programmed 4-20 mA output range, while a reading that is not clamped can display measurements outside the programmed range. (Click *previous item* to return to the previous parameter or on *exit page* to close the window without changing the percentage.) You are then returned to the *4-20 mA output* window.

3.7.2 4 and 20 mA cal

To calibrate the 4 and 20 mA output signals, click on the *4 mA cal* and *20 mA cal* commands respectively. In either case, a window similar to *Figure 28* below opens.

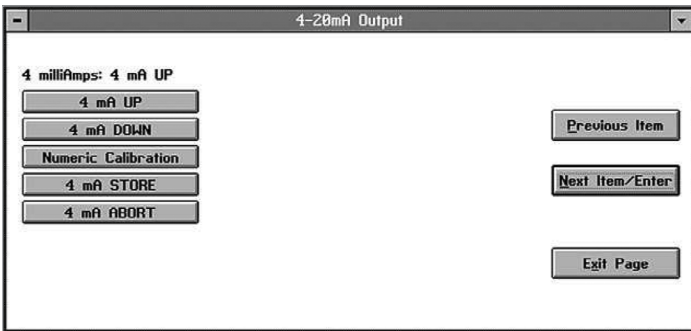

Figure 28: 4 mA Signal calibration window

Clicking on the *up* command increases the signal incrementally, while clicking on the *down* command decreases it incrementally. Clicking on *numeric calibration* opens a window similar to the one shown in *Figure 29* on page 19.

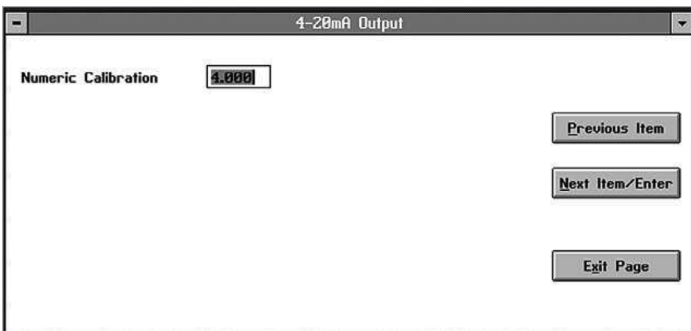

Figure 29: Numeric calibration window

Enter the desired number in the text box and click on *next item/enter*. (Click on *previous item* or *exit page* to close the window without changing the signal.) You are then returned to the previous window. After you have calibrated the desired input signal, click on *store* to save the entry, and on *next item/enter* to confirm it. If the signal is not satisfactory, click on *abort*. (Click *previous item* or *exit page* to close the window without changing the signal.) You are then returned to the *4-20 mA output* window (see *Figure 25* on page 18).

3.7.3 4-20 mA% test

The window for *4-20 mA% test* is similar to *Figure 30* below.

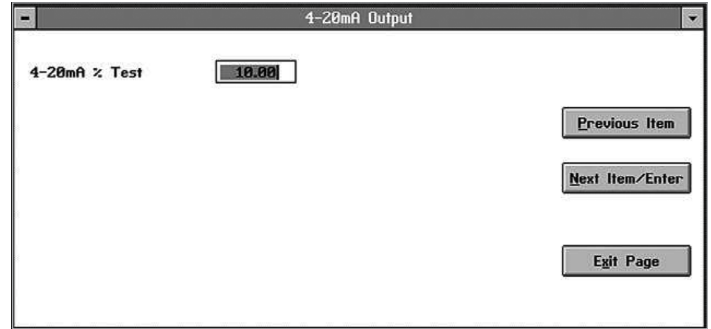

Figure 30: 4-20 mA% test window

Enter the desired percentage, and click on *next item/enter* to confirm the entry. A second text box opens, enabling you to test at another percentage if desired. Repeat the procedure until you have entered all desired test values. Then click *exit page* to close the window.

3.7.4 % gas test

The window for % gas test is similar to *Figure 31* below.

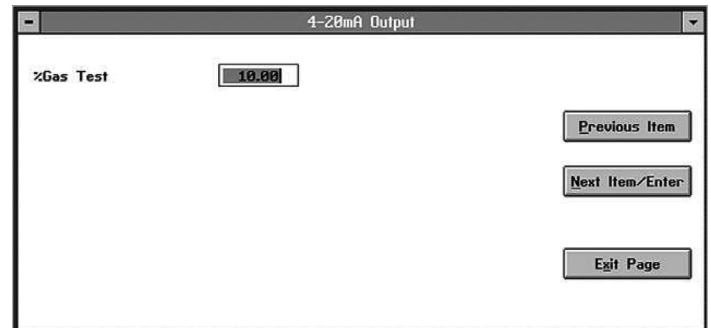

Figure 31: % gas test window

Enter the desired percentage, and click on *next item/enter* to confirm the entry. A second text box opens, enabling you to test at another percentage if desired. Repeat the procedure until you have entered all desired values. Then click *exit page* to close the window.

3.8 Error handler

The *error handler* command allows you to enable or disable error handling for specific error conditions for the XMTc. When you click on the *error handler* command from the *edit functions* menu (Figure 10 on page 14), a window similar to Figure 32 below opens. Clicking on any option opens the window for that option.

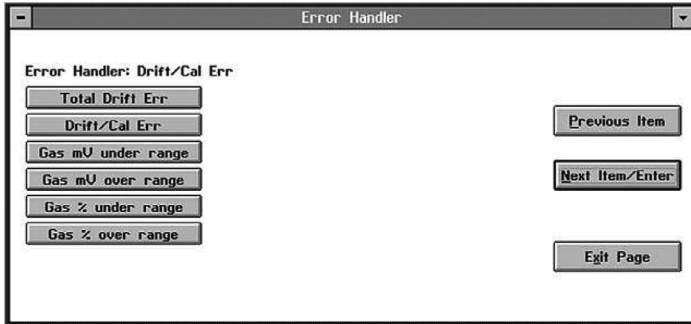

Figure 32: Error handler window

3.8.1 Total drift error

The *total drift error* option lets you enable or disable error handling for total drift error. The window is similar to Figure 33 below.

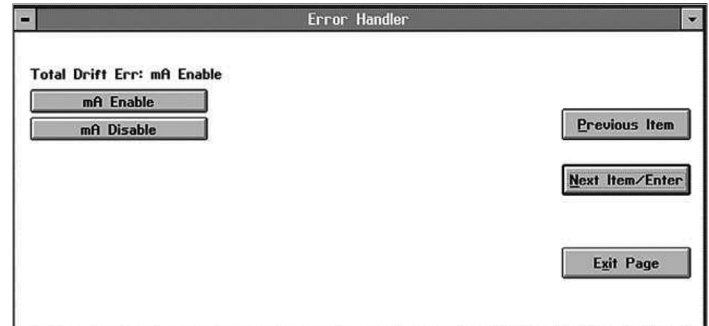

Figure 33: Total drift error window

If you click on *mA enable*, a window similar to Figure 34 below opens.

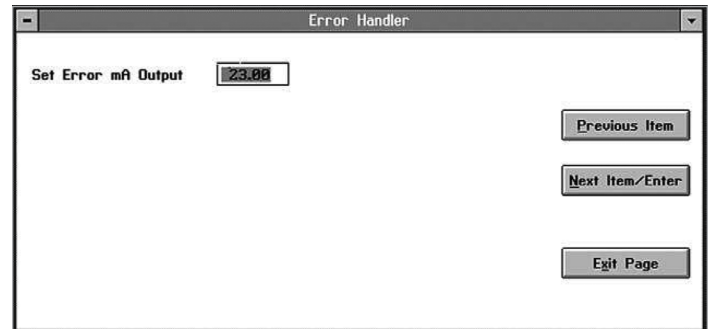

Figure 34: Error mA output window

Enter the desired error mA output in the text box, and click on *next item/enter* to confirm the entry. You are then asked for confirmation, as shown in Figure 35 on page 20.

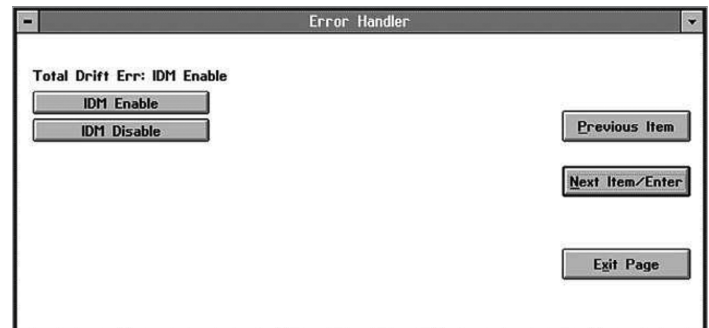

Figure 35: IDM enable/disable window

Click on *IDM enable* to enable drift error. (Click *previous item* or *exit page* to close the window without changing the output.) However, if you click on *mA disable*, you are also asked for confirmation. Click on *IDM disable* to disable the drift error. You are then returned to the *error handler* window.

3.8.2 Drift/cal error

The *DriftCal* error option lets you enable or disable error handling for DriftCal, generated when an error occurs during calibration. The window is similar to *Figure 36* below.

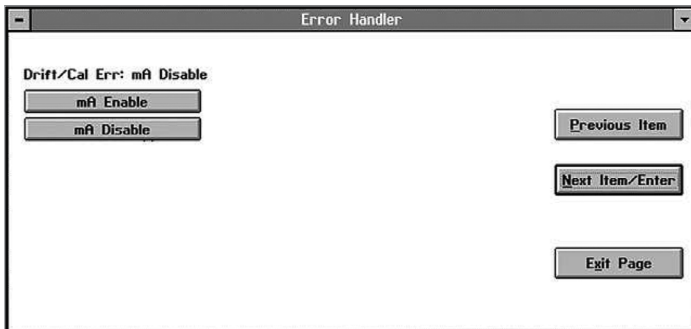

Figure 36: DriftCal error window

If you click on *mA enable*, the window displays a text box similar to that in *Figure 34 on page 20*. Enter the desired error mA output in the text box, and click on *next item/enter* to confirm the entry. You are then asked for confirmation, as shown in a window similar to *Figure 35 on page 20*. Click on *IDM enable* to enable drift error. (Click *previous item* or *exit page* to close the window without changing the output.) However, if you click on *mA disable*, you are also asked for confirmation. Click on *IDM disable* to disable the drift error. You are then returned to the *error handler* window.

3.8.3 Gas mV under/over range

The *gas mV under range* and *gas mV over range* options let you enable or disable error handling for the main gas signal. The window is similar to *Figure 37* below.

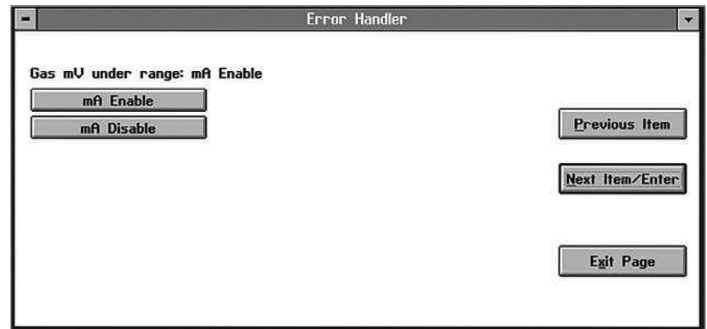

Figure 37: Gas mV under range window

If you click on *mA enable*, the window displays a text box. Enter the desired error mA output in the text box, and click on *next item/enter* to confirm the entry. You are then asked for confirmation. Click on *IDM enable* to enable the under or over-range error. (Click *previous item* or *exit page* to close the window without changing the output.) However, if you click on *mA disable*, you must confirm the choice in a second window. Click on *IDM disable* to disable the under or over-range error. You are then returned to the *error handler* window.

3.8.4 Gas % under/over range

The *gas % under range* and *gas % over range* options let you enable or disable error handling for the main gas percentage. The window is similar to *Figure 38* below.

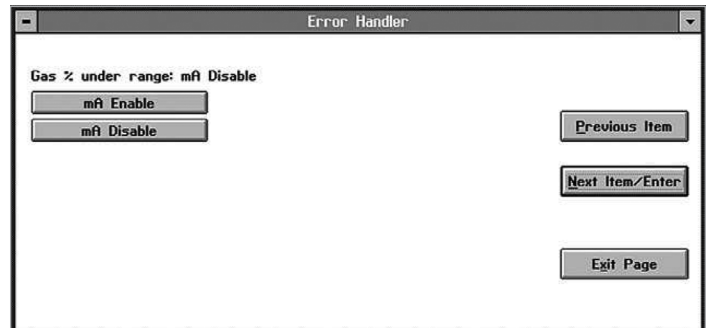

Figure 38: Gas % under range window

If you click on *mA enable*, the window displays a text box. Enter the desired error mA output in the text box, and click on *next item/enter* to confirm the entry. Then click on *IDM enable* to enable the under or over-range error. (Click *previous item* or *exit page* to close the window without changing the output.) However, if you click on *mA disable*, you must confirm the choice in a second window. Click on *IDM disable* to disable the under or over-range error. You are then returned to the *error handler* window.

3.9 Factory cal

The XMTC comes completely preprogrammed from the factory for your particular application. Should it become necessary to reprogram the meter, you can use the *factory cal* option.

IMPORTANT:

Do not use the factory cal option without referring to the *calibration data sheet* enclosed with your XMTC. Varying from the parameters on the sheet can result in problems with the XMTC and other equipment.

From the *edit functions* menu (shown in *Figure 10* on *page 14*), click on the *factory cal* option. A window similar to *Figure 39* below opens.

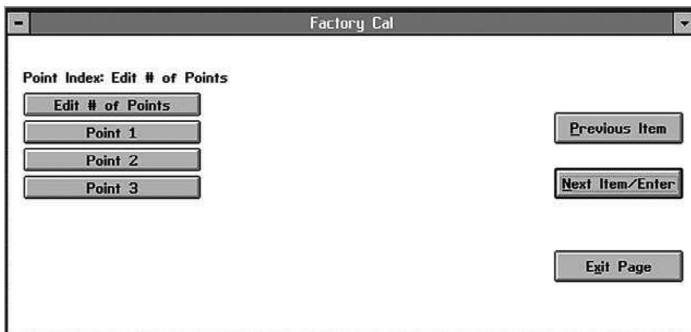

Figure 39: Factory cal window

The option permits you to edit the number of points and the value of each individual point.

3.9.1 Edit # of points

To edit the number of available points, click on *edit # of points*. A window similar to *Figure 40* below opens.

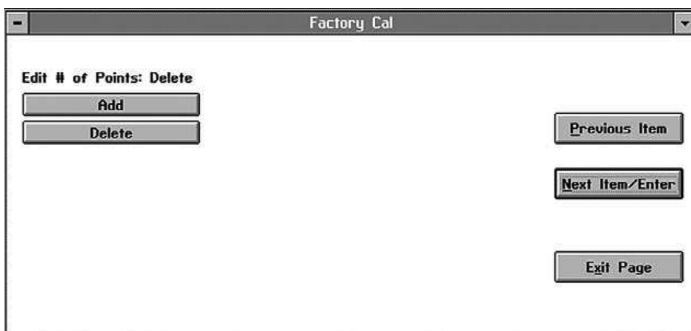

Figure 40: Edit # of points window

Click on *add* once for each point you wish to add, or on *delete* once for each point you wish to remove. Then click on *next item/enter* to confirm the entry. (Click *previous item* or *exit page* to close the window without changing the number of points.) You are then returned to the *factory cal* window, which displays the new number of points.

3.9.2 Edit point X

To edit the value for any particular point, click on that point in the *factory cal* window. A window similar to *Figure 41* below opens.

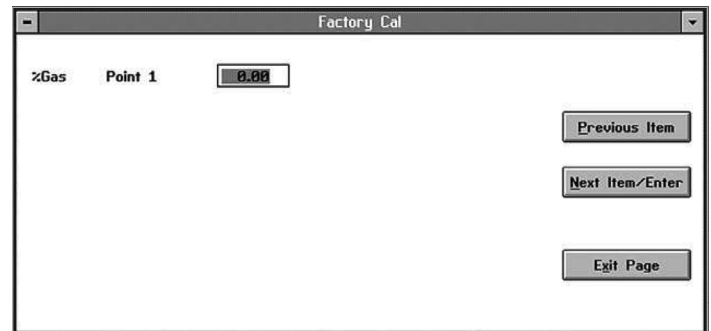

Figure 41: Point editing window

Enter the gas percentage in the text box, and click on *next item/enter* to confirm the entry. (Click *previous item* or *exit page* to close the window without changing the value.) Then, enter the next value, as shown in *Figure 42* below.

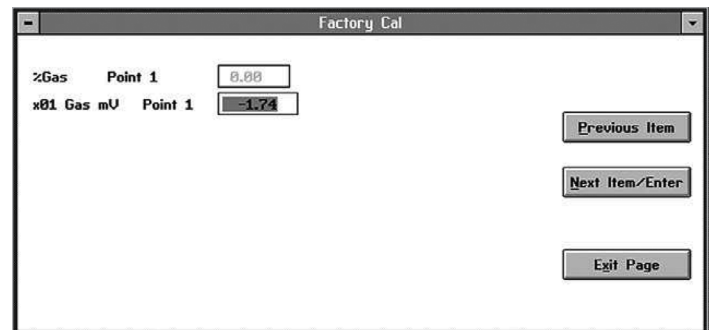

Figure 42: Additional values for point 1

Enter the *x01* and *x10 gas mV* values, and click on *next item/enter* after each entry. After you have completed entering values, you are returned to the *factory cal* window.

3.10 The advanced option

IMPORTANT:

Access to this menu is password-protected. Your assigned default **password = 2719**.

The final option on the *edit functions* menu is *advanced*, an option that allows you to choose between *fast response* and *language response*. In addition, you can add or change the meter identification number.

NOTE: For other available commands in the *advanced option*, refer to *Appendix D. The enhanced advanced option on page 57*.

From the edit functions menu (*Figure 10 on page 14*), click on *advanced* to open a window similar to *Figure 43* below. Then, enter your password.



Figure 43: Password window

After you have entered the password, an *advanced* window similar to *Figure 44* below opens.

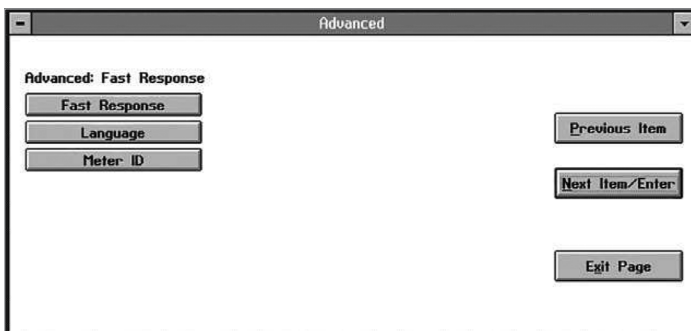

Figure 44: Advanced window

Fast response is software-enhanced response for faster performance under certain conditions, while *language response* enables you to upload data to or download data from a PC. *Meter ID* enables you to enter or change a meter network identification number. Click on the desired command. (Click *previous item* or *exit page* to close the window without entering any commands.)

3.10.1 Fast response

If you click on *fast response*, confirm the choice to open a window similar to *Figure 45* below.

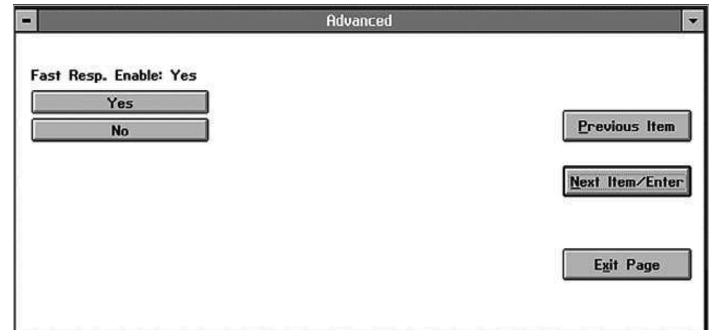

Figure 45: Fast response confirmation window

Click *yes* to enable *fast response*. In the series of three text boxes that follow, enter values for the *fast Tau up*, *fast Tau down*, and *fast threshold % FS* parameters. Then, click on *next item/enter* to confirm the entry and open the next window.

IMPORTANT:

Do not change the default values for these parameters without consulting the factory.

3.10.2 Language

If you click on *language*, a window similar to *Figure 46* below opens.

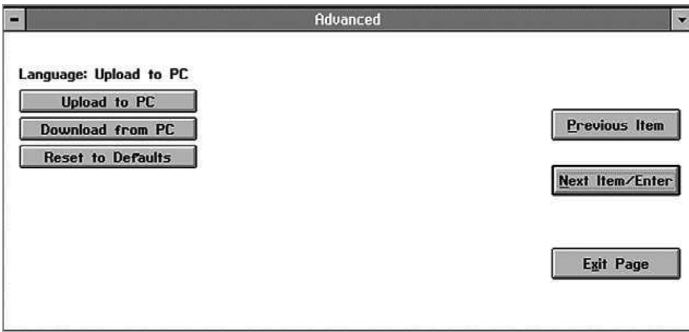

Figure 46: Language window

If you click on *upload to PC*, you are prompted to create a file, as shown in *Figure 47* below.

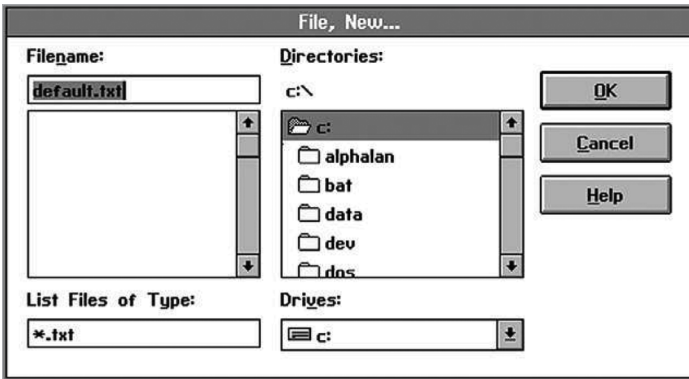

Figure 47: Creating a data File

If you click on *download from PC*, you are asked for a file name, as shown in *Figure 48* below.

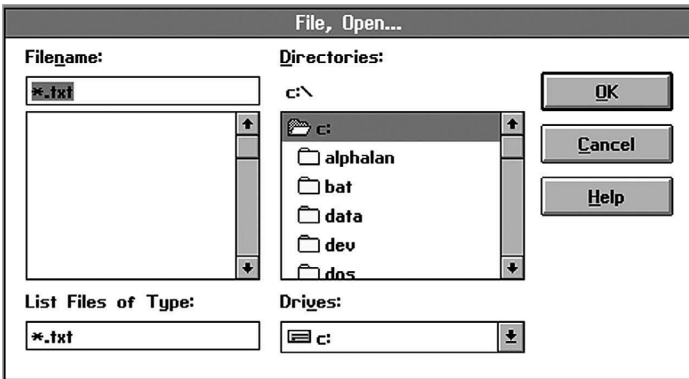

Figure 48: Downloading a data File

However, if you click on *reset to defaults*, the status is displayed in the *language* window. Click on *next item/enter* to confirm the entry. (Click *previous item* or *exit page* to close the window without changing the status.)

3.10.3 Meter ID

The *meter ID* window is similar to *Figure 49* below.

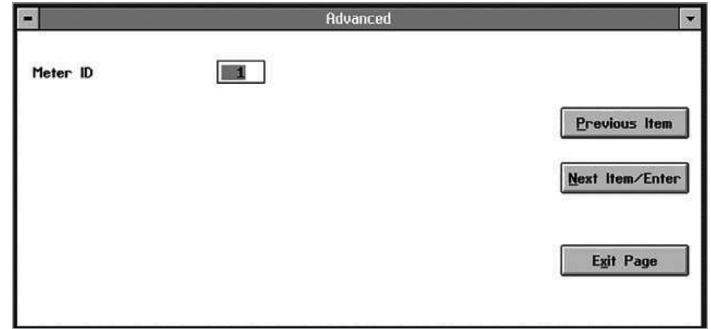

Figure 49: Meter ID window

Either leave the existing number without change, or enter a new meter ID number. In either case, click *next item/enter* to confirm the entry. (Click *previous item* or *exit page* to close the window without changing the number.) If you have changed an existing ID number, a window similar to *Figure 50* below opens.

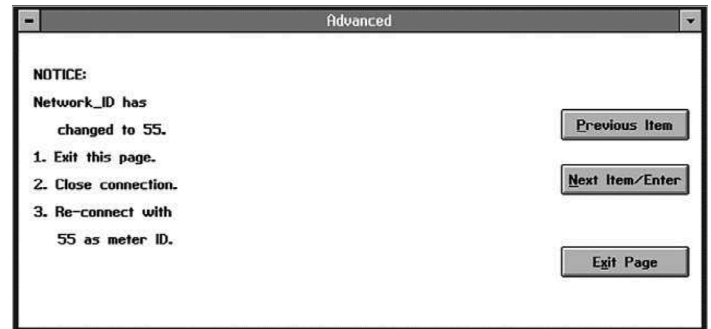

Figure 50: Revised Meter ID window

IMPORTANT:

After you have entered a new ID number, you cannot reverse the change. You must exit the page, close the connection, and reconnect the meter using the new number.

Click on *next item/enter* or *exit page* to return to the advanced window.

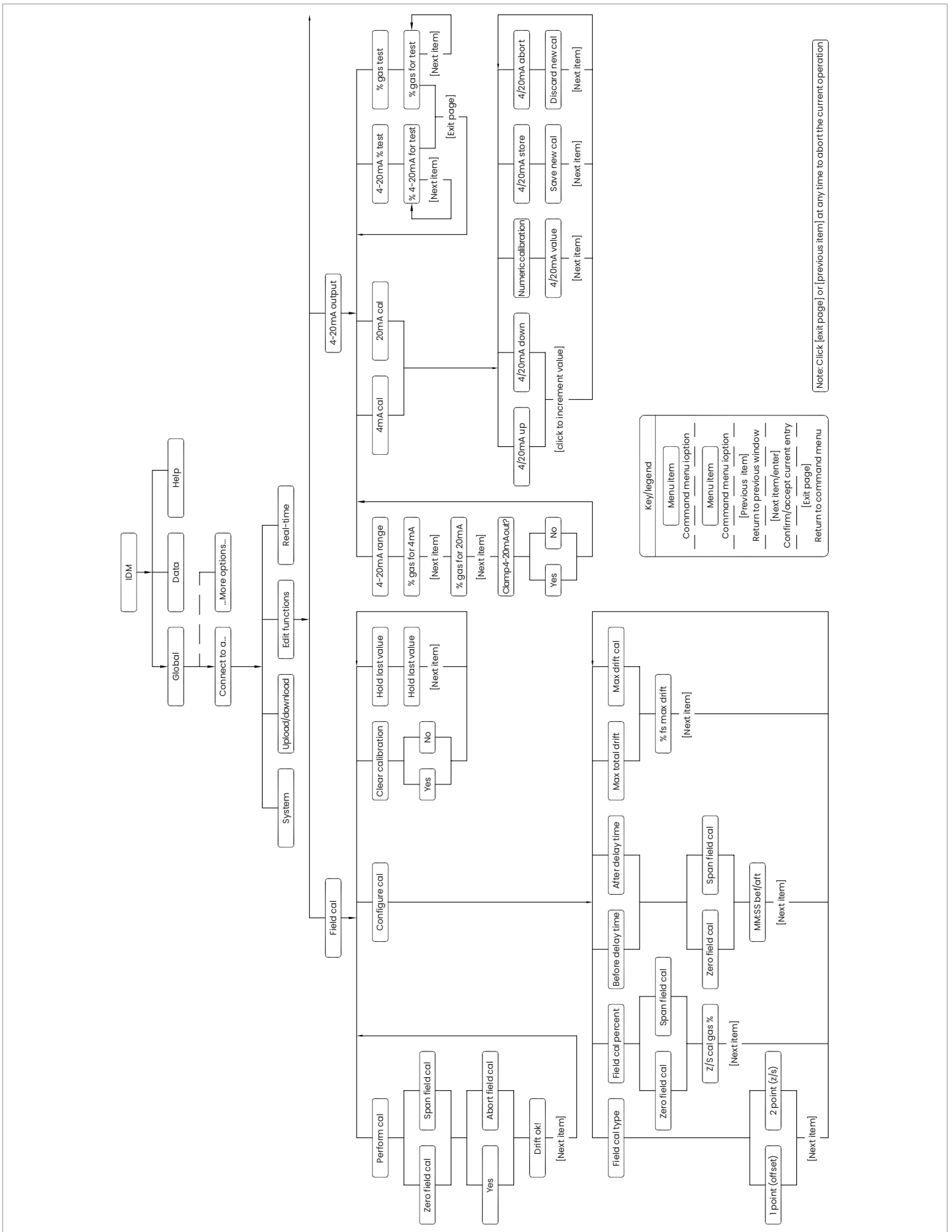

Figure 51: Field cal and 4-20mA output menu map

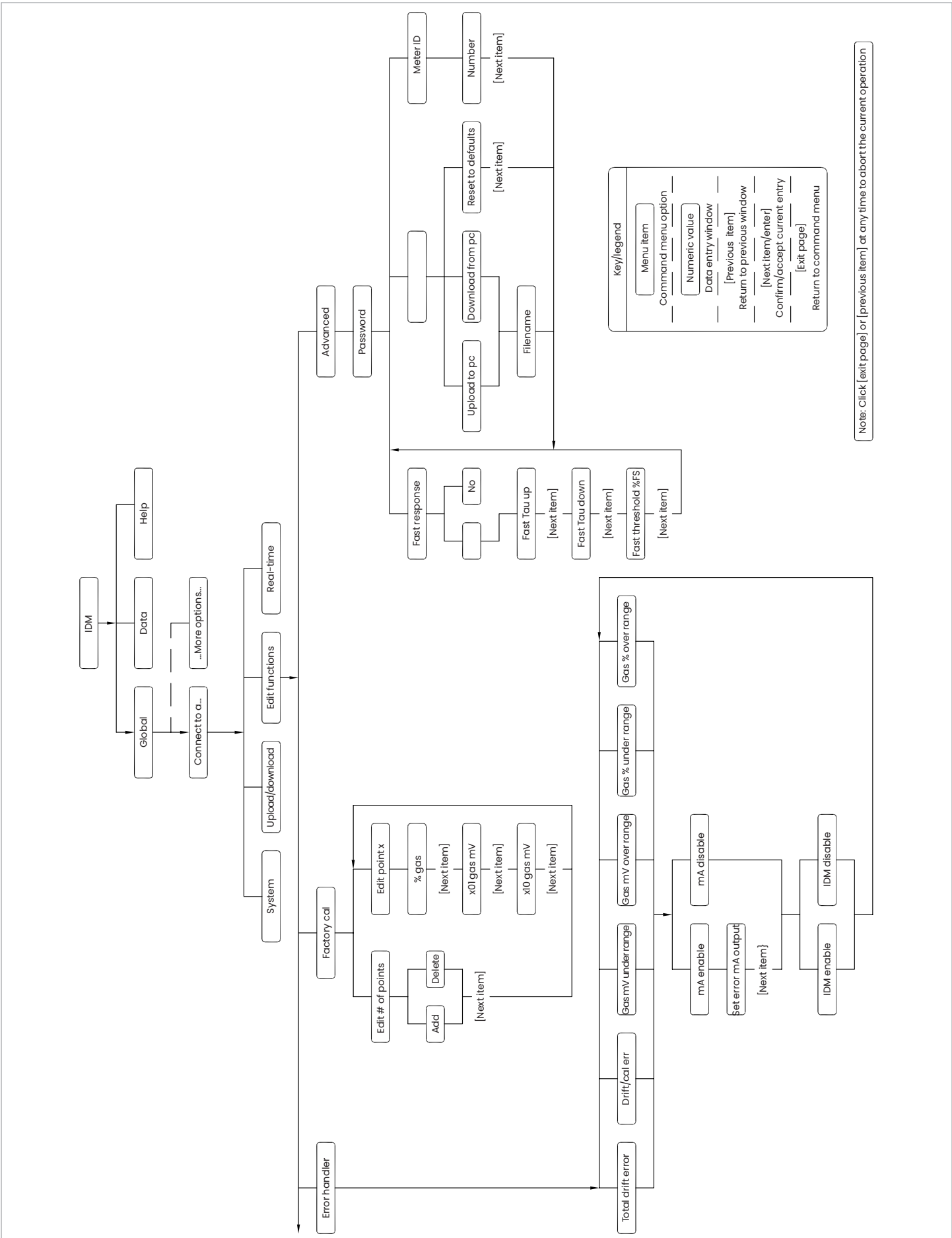

Figure 52: Error handler, factory cal and advanced menu map

Chapter 4. Calibration

4.1 Introduction

This chapter provides information on calibrating the XMTC in the field using zero, span, and reference gases. The following topics are discussed:

- General considerations for calibration at the factory and in the field
- What you will need before you begin calibrating
- Getting the XMTC ready and locating the adjustment potentiometers
- Calibrating the 2-port (sealed reference gas) XMTC with zero and span gases
- Calibrating the 4-port (flowing reference gas) XMTC with zero, span, and reference gases

4.2 Gas ranges and types

The XMTC was calibrated at the factory for the range and gas mixture specified at the time of purchase. The following standard ranges and gases are provided:

Ranges	Gases
0-2%	H ₂ in N ₂
0-5%	He in air
0-10%	He in N ₂
0-25%	CH ₄ in CO ₂ (minimum range 0-10% CH ₄)
0-50%	CO ₂ in air (minimum range 0-20% CO ₂)
0-100%	CO ₂ in N ₂ (minimum range 0-20% CO ₂)
50-100%	
80-100%	
90-100%	
95-100%	
98-100%	

NOTE: Calibrations can be performed for special ranges and gases upon request.

The XMTC requires recalibration every 2 to 6 months, depending on the application. The exact calibration interval will depend on such factors as: components of the binary gas mixture, desired accuracy, range, and cleanliness of the sample gas. You can recalibrate the XMTC for the same range and binary gas mixture as the previous calibration using just the zero and span adjustments.

4.3 Required equipment and materials



WARNING!

The calibration procedure described in this section requires the use of specialized apparatus and should be performed only by properly trained personnel.

To calibrate the XMTC, you will need the following equipment and materials:

- XMTC calibration sheet
- +24 VDC, 1.2 A power supply (system power, if unit is installed in a system)
- Zero gas
- Span gas
- Reference gas (for the 4-port version - the reference gas is usually the same as the span gas.)
- Sample system or individual components (e.g. flow meter, needle valve, pressure regulator) for connecting zero and span gases and controlling pressure and flow rates

NOTE: The accuracy of the calibration will only be as accurate as the composition accuracy of the zero and span gases.



WARNING!

Do not use explosive gas mixtures to calibrate the XMTC.

4.4 Preparing the transmitter for calibration

Complete the following steps before connecting and adjusting the zero, span, and reference gases:

1. Allow 30 minutes after power is turned on for the XMTC to reach temperature stability.
2. Loosen the set screw that locks the XMTC cover in place, and unscrew the cover (see *Figure 53* below).

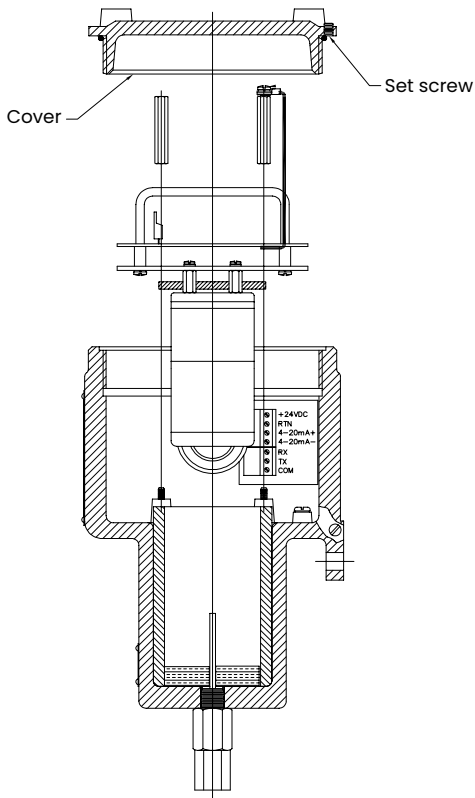

Figure 53: Transmitter cover and set screw

3. The XMTC printed circuit board (PCB) is located directly below the cover. Locate the switches S1 (zero and span adjustment) and S3 (calibration button) using *Figure 54* below as a guide.

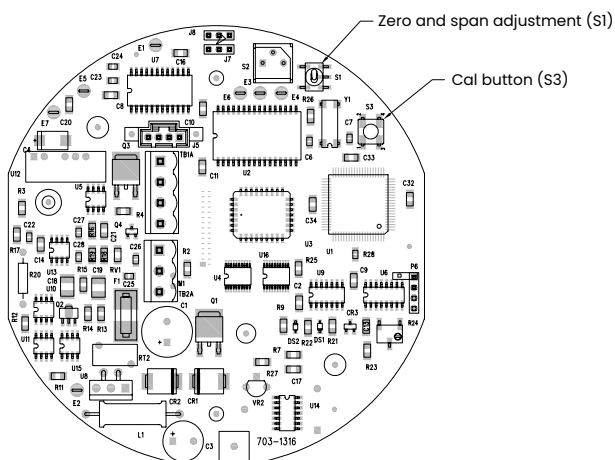

Figure 54: Calibration switch locations

4.5 2-port (sealed reference gas) calibration

1. Connect the XMTC sample inlet to the zero gas via the zero gas inlet on the sample system or other gas control system.
2. Establish a flow rate of 0.5 SCFH (250 cc/min) of zero gas at 0.0 psig to the XMTC.
3. Allow 2–5 minutes for the reading to settle. Move S1 to the zero position (marked on the PCB). Press S3 (the calibration button) for about 20 seconds.
4. Connect the XMTC sample inlet to the span gas via the span gas inlet on the sample system or other gas control system.
5. Establish a flow rate of 0.5 SCFH (250 cc/min) of span gas at 0.0 psig to the XMTC.
6. Allow 2–5 minutes for the reading to settle. Move S1 to the span position (marked on the PCB). Press S3 (the calibration button) for about 20 seconds.

4.6 4-port (flowing reference gas) calibration

1. Connect the XMTC reference inlet to the reference (span) gas via the reference gas inlet on the sample system or other gas control system.
2. Establish a flow rate of 0.5 SCFH (250 cc/min) of reference (span) gas at 0.0 psig to the XMTC reference inlet.

NOTE: You can use a calibration gas flow rate as low as 5 cc/min to conserve gas.

3. Connect the XMTC sample inlet to the zero gas via the zero gas inlet on the sample system or other gas control system.
4. Establish a flow rate of 0.5 SCFH (250 cc/min) of zero gas at 0.0 psig to the XMTC sample inlet.
5. Allow 2–5 minutes for the reading to settle. Move S1 to the zero position (marked on the PCB). Press S3 (the calibration button) for about 20 seconds.
6. Connect the XMTC sample inlet to the span gas via the span gas inlet on the sample system or other gas control system.
7. Establish a flow rate of 0.5 SCFH (250 cc/min) of span gas at 0.0 psig to the XMTC sample inlet.
8. Allow 2–5 minutes for the reading to settle. Move S1 to the span position (marked on the PCB). Press S3 (the calibration button) for about 20 seconds.

[no content intended for this page]

Chapter 5. Specifications

5.1 Performance

Accuracy	±2% of span
Linearity	±1% of span
Repeatability	±0.5% of span
Stability	Zero: ±0.5% of span per week Span: ±0.5% of span per week
Response time	20 seconds for 90% of step change
Measurement ranges (typical)	0-2% 0-5% 0-10% 0-25% 0-50% 0-100% 50-100% 80-100% 90-100% 95-100% 98-100%
Measurement gases (typical)	H ₂ in N ₂ , air or CO ₂ He in N ₂ or air CO ₂ in N ₂ or air (minimum range 0-20% CO ₂) SO ₂ in air (minimum range 0-10% SO ₂) Ar in N ₂ or air (minimum range 0-20% argon)
Ambient temperature effect	±0.05% of span per °C
Required sample gas flow rate	0.1 to 4.0 SCFH (5 to 2000 cc/min), 0.5 SCFH (250 cc/min) nominal
Required reference gas flow rate	0.01 to 4.0 SCFH (5 to 2,000 cc/min), 0.5 SCFH (250 cc/min) nominal

5.2 Functional

Analog output	4-20 mA isolated, 800 ohm max, field-programmable
Power	24 VDC ±2 VDC, 1.2 A maximum
Cable	10 ft (3 m), 4-wire; lengths up to 4000 ft. (1200 m) available
Operating Temperature	Standard: +55°C (+131°F) Optional: +70°C (+158°F)
Ambient Temperature range	Standard cell operating temperature (55°): -20° to +45°C (-4° to +104°F) Optional cell operating temperature (70°): +5° to +60°C (+41° to +140°F)

5.3 Physical

Sensor wetted materials	<p>Standard: 316 SS, glass, and Viton™ o-rings</p> <p>Optional: Hastelloy C276, Titanium and Chemraz™ o-rings</p>
Dimensions	<p>Weatherproof unit: 9.54" (H) x 5.70" (D) (242 x 145 mm)</p> <p>Explosion-proof unit: 10.48" (H) x 5.70" (D) (266 x 145 mm)</p>
Weight	9.5 lb (4.3 kg)
Connections	<p>Electrical conduit: 3/4" NPTF</p> <p>Sample inlet/outlet, optional reference inlet/outlet: 1/4" NPTF</p>
Environmental	<p>Weatherproof: Class I div. 1 groups A, B, C & D Class II, III div. 1 groups E, F & G Tamb 65°C T5 type 4X</p> <p>Flameproof: III 2 G Ex d IIC T6 Gb IP66 -20°C < Tamb < +65°C All conduit entries 3/4" NPT</p> <p>CE: EMC 2014/30/EU PED 2014/68/EU ATEX 2014/34/EU</p> <p>NOTE: For CE compliance, the power and I/O cables must be shielded. All cables must be terminated within the cable gland at the XMTC.</p> <p>NOTE: See the certification drawings in <i>Appendix C. Installation and wiring diagrams on page 43</i>, for additional details.</p>

5.4 Accessories

The following accessories are available for use with the XMTC:

- **PS5R-C24**
24 VDC power supply
- **X4 (*)**
4-wire cable (X specifies length), lengths up to 4000 ft (1200 m) are available
- **TMO2D**
Display/control module
- **MIS-1 and MMS-3**
Graphical moisture, temperature, oxygen and thermal conductivity analyzers
- **XDP**
Explosion-proof display package
- **704-668-12**
RS232 cable, 12 ft (4 m) length with DB-9 female connector
- **IDM**
Manual and software with floppy disk (part number 910-185)
- **PanaView**
Interface software manual and CD (part number 910-211)

Appendix A. Supplemental information

A.1 Ordering information

A B C D E

- - -

B - Measuring cell package*

1. Weatherproof enclosure, sealed reference (2-port), CPVC cell
2. Explosion-proof enclosure, sealed reference (2-port), CPVC cell
3. Weatherproof enclosure, flowing reference (4-port), CPVC cell
4. Explosion-proof enclosure, flowing reference (4-port), CPVC cell
5. Weatherproof enclosure, sealed reference (2-port), FEP-coated aluminum cell*
6. Explosion-proof enclosure, sealed reference (2-port), FEP-coated aluminum cell*
- W. Without enclosure, sealed reference (2-port), FEP-coated aluminum cell
- X. Without enclosure, sealed reference (2-port), CPVC cell
- Y. Without enclosure, flowing reference (4-port), CPVC cell

*Standard measuring cell package is FEP coated aluminum cell — see options 5 and 6 above.

C - CE compliance

2. Standard
- C. CE compliant

D - Certification label for explosion-proof options

1. T6 rating label, for ambient temperatures up to 55°C
2. T5 rating label, for ambient temperatures up to 65°C

E - Wetted material

1. 316 Stainless Steel/Viton O rings
2. Hastelloy C276/Chemraz O rings

A.2 Calibration specification ordering information

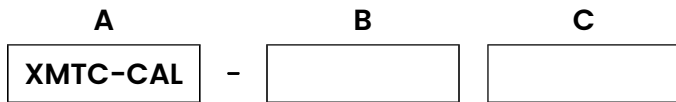

B - Cell range

2. 0 to 2%
3. 0 to 5%
4. 0 to 10%
6. 0 to 25%
7. 0 to 50%
8. 0 to 100%
- A. 90 to 100%
- B. 80 to 100%
- C. 50 to 100%
- D. 98 to 100%
- E. 95 to 100%
- S. Special

C - Standard gases

1. H₂ in N₂
2. CO₂ in N₂ (minimum range 0 to 20% CO₂)
3. CO₂ in air (minimum range 0 to 20% CO₂)
4. He in N₂
5. He in air
6. Calibration for H₂ cooled generators H₂/CO₂/air
7. CH₄ in CO₂ (minimum range 0 to 10% CH₄)
- S. Special

NOTE: Binary gas composition must total 100%.

A.3 XMTC PCB subassemblies

703-1276-02	XMTC transmitter analog PCB assembly
707-320	XMTC instrument program
703-1316-03	XMTC transmitter digital PCB assembly compatible with IDM communications software
910-185	Instrument data manager software and manual (supplied on floppy disk)
CREDIT-XMTC	Trade-in credit for uncontaminated XMTC. Partial credit to be determined after receipt and upon inspection at the factory.

A.4 Sample calibration sheet

A typical calibration sheet example is shown in *Figure 55* below.

XMCT calibration sheet				
XMTC s/n	2630			
XMTC part number	XMTC-62-II			
Calibration part number	XMTC-CAL-3II			
Calibration gases	H ₂ N ₂			
Calibration ranges	0 to 5%			
Work order number	508230006418			
Calibration date	April 25, 2009			
Technician	K. Brin			
Unit calibrated using	x10	Gain scale		
XMTC calibration data hydrogen in nitrogen				
	PT	%H₂	x10 (mV)	Output (mA)
	1	0.00	-56.02	4.00
	2	5.00	574.00	20.00
Output	4 to 20 mA	0 to 5% H ₂ in N ₂		
Clamp output	No			
Field calibration				
Zero	100% N ₂			
Span	5% H ₂ in N ₂			

Figure 55: A sample calibration sheet

A.5 Relative thermal conductivity of common gases

Table 4: Thermal conductivity of common gases		
Gas	Temperature = 0°C (32°F)	Temperature = 100°C (212°F)
Air, N ₂ /O ₂	1.000	1.000
Hydrogen, H ₂	6.968	6.803
Helium, He	5.970	5.530
Nitrogen, N ₂	1.000	0.989
Oxygen, O ₂	1.018	1.028
Neon, Ne	1.900	1.840
Argon, Ar	0.677	0.665
Chlorine, Cl ₂	0.323	0.340
Carbon Monoxide, CO	0.962	0.958
Carbon Dioxide, CO ₂	0.603	0.704
Nitric Oxide, NO	0.980	0.978
Sulfur Dioxide, SO ₂	0.350	0.381
Hydrogen Sulfide, H ₂ S	0.538	0.562
Carbon Disulfide, CS ₂	0.285	0.300
Ammonia, NH ₃	0.897	1.040
Water Vapor, H ₂ O	0.755	0.771
Methane, CH ₄	1.250	1.450
Ethane, C ₂ H ₆	0.750	0.970
Propane, C ₃ H ₈	0.615	0.832
n-Butane, C ₄ H ₁₀	0.552	0.744
Isobutane, C ₄ H ₁₀	0.569	0.776
n-Pentane, C ₅ H ₁₂	0.535	0.702
Isopentane, C ₅ H ₁₂	0.515	0.702

Table 4: Thermal conductivity of common gases		
Gas	Temperature = 0°C (32°F)	Temperature = 100°C (212°F)
n-Hexane, C ₆ H ₁₄	0.508	0.662
n-Heptane, C ₇ H ₁₆	0.399	0.582
Cyclohexane, C ₆ H ₁₂	0.375	0.576
Ethylene, C ₂ H ₄	0.720	0.980
Propylene, C ₃ H ₆	0.626	0.879
Acetylene, C ₂ H ₂	0.770	0.900
1,3 Butadiene, C ₄ H ₆	0.441	0.642
Nitrous Oxide, N ₂ O	0.633	0.762
Ethylene Oxide, C ₂ H ₄ O	0.469	0.620
Ethyl Alcohol, C ₂ H ₅ OH	0.590	0.685
Isopropyl Alcohol*, C ₃ H ₇ OH	0.492	0.644
Acetone, C ₃ H ₆ O	0.406	0.557
Methyl Chloride, CH ₃ Cl	0.377	0.530
Ethyl Chloride, C ₂ H ₅ Cl	0.391	0.540
Vinyl Chloride, C ₂ H ₃ Cl	0.443	0.551
Freon-11, CCl ₃ F	0.286	0.368
Freon-12, CCl ₂ F ₂	0.344	0.442
Freon-22, CHClF ₂	0.388	0.474
Freon-113, C ₂ Cl ₃ F ₃	0.277	0.369
Hydrogen Chloride, HCl	0.520	0.517
Hydrogen Fluoride, HF	0.654	0.959

*Consult Panametrics

Appendix B. Typical applications

B.1 H₂ in N₂ in heat treat furnace atmospheres

The XMTC can be used to measure the concentration of hydrogen (H₂) in nitrogen (N₂) in a heat treat furnace atmosphere.

B.1.1 Problem

Mixtures of H₂ and N₂ are used as controlled atmospheres in the heat treating of metals. These mixtures are well-defined and need to be maintained in order to assure product quality and consistency. Dissociated ammonia is one such atmosphere. Here, ammonia is broken down into free N₂ and H₂ in a 25 to 75% mixture.

B.1.2 Equipment

A typical instrumentation package includes a 2-port (sealed reference gas - air) XMTC transmitter with a 4–20 mA range of 0–25% H₂ mounted in a sample system similar to the one shown in *Figure 56* below. A display package is often specified.

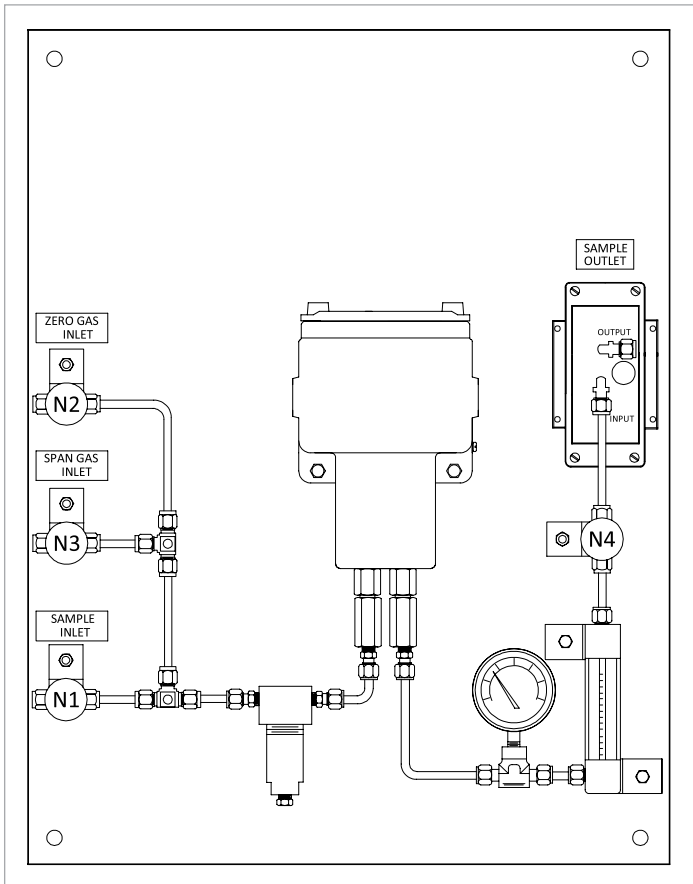

Figure 56: Sample system

The sample system consists of needle valves for selection and isolation of sample, zero, and span gases, a needle valve for flow control, a filter/coalescer, a 2-port XMTC transmitter, a pressure gauge, a flowmeter, and a sample pump. All components are mounted on a painted steel plate.

NOTE: A TMO2D or XDP display package is typically used. A Panametrics moisture analyzer can be used when the H₂ measurement is to be made in conjunction with a moisture measurement.

B.1.3 Basic operating procedure

The H₂ content is continuously monitored at the inlet, hot zone, and/or effluent of the furnace. A sample gas flow rate of 0.5 SCFH (250 cc/min) is established. The sample system should be located in an area cooler than 50°C (122°F), and the tubing leading to the sample system should be at least 5 ft (1.5 m) long to insure proper cooling of the sample gas.

For this application the required calibration gases are:

- **Zero gas** - N₂ (99.95 % minimum purity)
- **Span gas** - 10.0 or 25.0% H₂ in N₂, or H₂ (99.95 % minimum purity) A typical XMTC Calibration data sheet is shown in *Figure 57* below.

XMTC calibration sheet Thermal conductivity transmitter

Serial number TC-102

Part number XMTC-22-2

Range, % 0 to 25% H₂

Output 4 to 20 mA

PC board 703-1095

Work order PCI 90403

Calibration date September 8, 2000

	Point	%H ₂ *	H ₂ , mA
	1	0.00	4.00
	2	25.00	20.0

* Calibration is with Hydrogen (H₂) in Nitrogen (N₂)

Figure 57: A typical XMTC calibration data sheet

B.1.4 Permanent installation

Continuous monitoring of the furnace atmosphere H₂ content using the XMTC assures a high degree of quality control in the manufacturing process.

B.1.5 Specifications

Typical ranges:	0 to 10% H ₂ in N ₂ 0 to 25% H ₂ in N ₂ 0 to 100% H ₂ in N ₂
Operating conditions:	Pressure: Ambient Temperature: +540 to +1370°C (+1000 to +2500°F)

B.1.6 Detailed operating procedure

The following procedure details the start-up, operation, and calibration of the 2-port (sealed reference gas) XMTC sample system for heat treat furnace applications shown in *Figure 56 on page 38*.

Needle valves N1 through N4 on the sample system drawing have the following functions:

- N1 – selects/isolates the process sample gas
- N2 – selects/isolates the calibration zero gas
- N3 – selects/isolates the calibration span gas
- N4 – controls the flow of the selected gas

B.1.6a Start-up

1. Mount the sample system in an enclosed area heated to a temperature above 0°C.
2. Make sure that all needle valves are fully closed.
3. Run 1/4" tubing from the process to N1 (sample inlet).

NOTE: If the process is at a high pressure, a pressure regulator should be placed before this valve.



CAUTION!

The XMTC is calibrated and intended for use at atmospheric pressure. Higher pressures will lead to inaccurate readings, may result in damage to the instrument, and/or may pose a safety problem.

4. Run 1/4" tubing from the pressure regulator on the cylinder containing the zero calibration gas to N2 (zero gas inlet).
5. Run 1/4" tubing from the pressure regulator on the cylinder containing the span calibration gas to N3 (span gas inlet).

NOTE: No pressure restrictions should be placed on the pump outlet. Any tubing on the outlet should be at least 1/4" in diameter, and preferably 1/2".

6. Leak test all sample system fittings, as well as those leading to the sample system.
7. Bring 24 VDC to the XMTC. Refer to *Chapter 2. Installation on page 7*, and allow 1 hour before proceeding.
8. Bring 120 VAC to the sample pump.
9. Open N4 one turn.
10. Fully open N1.
11. Adjust N4 until the flowmeter reads mid-scale. The pressure gauge should read 0 psig.

After the system has come to equilibrium, the sample system should be checked periodically to ensure that there is gas flow through the flowmeter.

B.1.6b Calibration

Refer to *Chapter 4. Calibration on page 27*, for the complete XMTC calibration procedure. The procedures below are only a supplement to that procedure. These procedures show the valve configurations necessary to deliver the calibration gases to the XMTC.

Zero gas calibration:

1. Fully close N1.
2. Fully open N2.
3. Adjust N4 until the flowmeter reads mid-scale. The pressure gauge should read 0 psig.

Allow enough time for the tubing to be cleared of the sample gas before making any adjustments to the transmitter.

Span gas calibration:

1. Fully close N2 (or N1).
2. Fully open N3.
3. Adjust N4 until the flowmeter reads mid-scale. The pressure gauge should read 0 psig.

Allow enough time for the tubing to be cleared of the zero (or sample) gas before making any adjustments to the transmitter.

Returning to standard operation:

1. Fully close N3 (or N2).
2. Fully open N1.
3. Adjust N4 until the flow meter reads mid-scale. The pressure gauge should read 0 psig.

After the system has come to equilibrium, the sample system should be checked periodically to insure that there is flow through the flow meter.

B.2 H₂ purity in H₂-cooled electricity generator

The XMTC can be used to measure the purity of hydrogen (H₂) in hydrogen-cooled electricity generators used in the power industry.

B.2.1 Problem

H₂ is used as a cooling medium in electricity generators because of its high thermal conductivity. If air leaks into the H₂, the mixture can become explosive.

B.2.2 Equipment

A typical instrumentation package includes a 4-port (flowing reference gas - hydrogen), explosion-proof XMTC with a 4-20 mA range of 80 to 100% H₂ mounted in a sample system similar to the one shown in *Figure 58* below. An XDP display package is often specified.

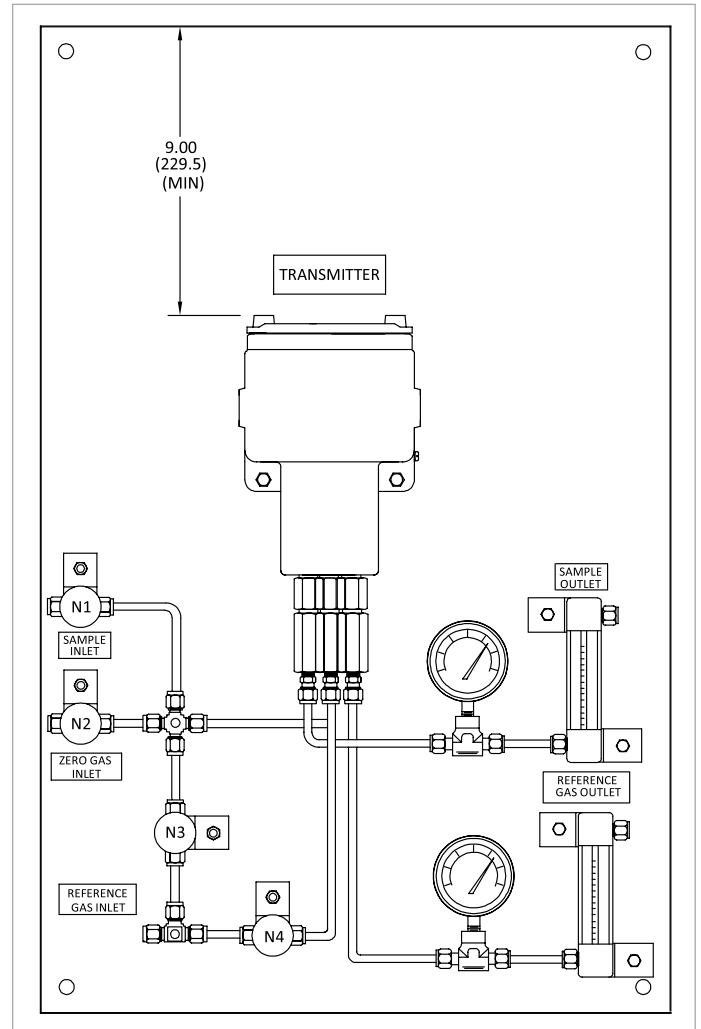

Figure 58: Sample system (732-028)

The sample system consists of inlet needle valves for sample, zero, span, and reference gases; a 4-port explosion-proof XMTC; two pressure gauges; and two flowmeters. All components are mounted on a painted steel plate. A pump may be needed to draw a sample through the sample system.

NOTE: A TMO2D or XDP display package is typically used. A Panametrics moisture analyzer display package can be used when the H₂ measurement is to be made in conjunction with a moisture measurement.

B.2.3 Basic operating procedure

The H₂ purity is continuously monitored at the generator. A sample gas flow of 0.5 SCFH (250 cc/min) is established. A hydrogen reference gas flow of 0.4 SCFH (200 cc/min) is sufficient for proper operation. The sample system should be located in an area cooler than 50oC (122oF), and the tubing leading to the sample system should be at least 5 ft (1.5 m) long to insure proper cooling of the sample gas.

For this application the required calibration gases are as follows:

- **Zero gas** - 80.0% H₂ in N₂
- **Span gas** - H₂ (minimum 99.95 % purity)
- **Reference gas** - same as span gas

A typical XMTC calibration data sheet is shown in *Figure 59* below.

XMTC calibration sheet Thermal conductivity transmitter			
XMTC transmitter			
Serial number	TC-135		
Part number	XMTC-42-1		
Range, %	80 to 100% H ₂ in N ₂		
Output	4 to 20 mA		
PC board	703-1095		
Work order	PCI 94445		
Calibration date	September 1, 2000		
	Point	%H ₂ *	H ₂ , mA
	1	80.00	4.00
	2	90.00	11.62
	3	100.00	20.00
* Calibration is with Hydrogen (H ₂) in Nitrogen (N ₂)			

Figure 59: Typical XMTC calibration data sheet

B.2.4 How previously handled

The system (generator) was leak checked periodically. If a leak occurred between checks, an explosion could occur. Moisture analyzers were also used for continuous analysis, since the presence of moisture in the H₂ is indirect evidence of an air leak.

B.2.5 Permanent installation

Continuous monitoring of the generator H₂ purity using the XMTC provides increased safety. A low H₂ reading alerts plant personnel to a potential safety problem and allows them to locate the leak and correct the problem.

B.2.6 Specifications

Range:	80 to 100% H ₂ in N ₂
Operating conditions:	Pressure: 0.5 to 75 psig Temperature: +30° to +50°C (+86 to +122°F)

B.2.7 Detailed operating procedure

The following procedure details the start-up, operation, and calibration of the 4-port (flowing reference gas) XMTC sample system for the hydrogen purity applications shown in *Figure 58 on page 40*.

Needle valves N1 through N4 on the sample system drawing have the following functions:

- N1 – controls the flow of the process sample gas
- N2 – controls the flow of the zero calibration gas
- N3 – controls the flow of the span calibration gas
- N4 – controls the flow of the reference gas

B.2.7a Start-up

1. Mount the sample system in an enclosed area heated to a temperature above 0°C.
2. Make sure that all needle valves are fully closed.
3. Run 1/4" tubing from the process to N1 (sample inlet).

NOTE: If the process is at a high pressure, a pressure regulator should be placed before this valve.



CAUTION!

The XMTC is calibrated and intended for use at atmospheric pressure. Higher pressures will lead to inaccurate readings, may result in damage to the instrument, and/or may pose a safety problem.

4. Run 1/4" tubing from the pressure regulator on the cylinder containing the zero calibration gas to N2 (*zero gas inlet*).
5. Run 1/4" tubing from the pressure regulator on the cylinder containing the span calibration gas/reference gas to N4 (*reference gas inlet*).

NOTE: No pressure restrictions should be placed on the flowmeter outlets. Any tubing on the outlets should be at least 1/4" in diameter, and preferably 1/2".

6. Leak test all sample system fittings, as well as those leading to the sample system.
7. Bring 24 VDC to the XMTC. Refer to *Chapter 2. Installation on page 7*, and allow 1 hour before proceeding.
8. Slowly open N1 until the sample outlet flowmeter reads mid-scale. The pressure gauge at the sample outlet should read 0 psig.
9. Slowly open N4 until the reference gas outlet flowmeter reads mid-scale. The pressure gauge at the reference gas outlet should read 0 psig.

After the system has come to equilibrium, the sample system should be checked periodically to insure that there is gas flow through both flowmeters.

B.2.7b Calibration

Refer to *Chapter 4. Calibration on page 27*, for the complete XMTC calibration procedure. The procedures below are only a supplement to that procedure. These procedures show the valve configurations necessary to bring the calibration gases to the XMTC.

Zero gas calibration:

1. Fully close N1 and/or N3.
2. Slowly open N2 until the sample outlet flowmeter reads mid-scale. The pressure gauge at the sample outlet should read 0 psig.

NOTE: If N3 was closed in this step and if the flow in the reference gas outlet flowmeter increased when N3 was closed, adjust N4 to bring the flow to mid-scale.

Allow enough time for the tubing to be cleared of the sample gas or calibration span gas before making any adjustments to the transmitter.

Span gas calibration:

1. Fully close N1 and/or N2.
2. Slowly open N3 until the sample outlet flowmeter reads mid-scale. The pressure gauge at the sample outlet should read 0 psig.

NOTE: If the flow in the reference gas outlet flowmeter decreased when N3 was opened, adjust N4 to bring the flow to mid-scale.

Returning to standard operation:

1. Fully close N2 and/or N3.

NOTE: If N3 was closed in this step and if the flow in the reference gas outlet flowmeter increased when N3 was closed, adjust N4 to bring the reference gas flow to mid-scale.

2. Slowly open N1 until the sample outlet flowmeter reads mid-scale. The pressure gauge at the sample outlet should read 0 psig.
3. After the system has come to equilibrium, the sample system should be checked periodically to insure that there is flow through both flow meters.

Appendix C. Installation and wiring diagrams

This appendix includes the following XMTC drawings:

- *Figure 60: Certification drawing (ref. 752-168, Rev. E, SH1) on page 44*
- *Figure 61: Certification drawing (ref. 752-168, Rev. E, SH2) on page 45*
- *Figure 62: Certification drawing (ref. 752-168, Rev. E, SH4) on page 46*
- *Figure 63: Analog PCB schematic (ref. 700-1276, Rev. F, SH1) on page 47*
- *Figure 64: Analog PCB schematic (ref. 700-1276, Rev. F, SH2) on page 48*
- *Figure 65: Digital PCB schematic (ref. 700-1316, Rev. H, SH1) on page 49*
- *Figure 66: Digital PCB schematic (ref. 700-1316, Rev. H, SH2) on page 50*
- *Figure 67: EMI filter PCB schematic (ref. 700-1550, Rev. A) on page 51*
- *Figure 68: Analog PCB assembly (ref. 703-1276, Rev. H) on page 52*
- *Figure 69: Digital PCB assembly (ref. 703-1316, Rev. K, SH1) on page 53*
- *Figure 70: Digital PCB assembly (ref. 703-1316, Rev. K, SH2) on page 54*
- *Figure 71: EMI filter PCB assembly (ref. 703-1550, Rev. A, SH1 & SH2) on page 55*
- *Figure 72: XMTC interconnection diagrams on page 56*

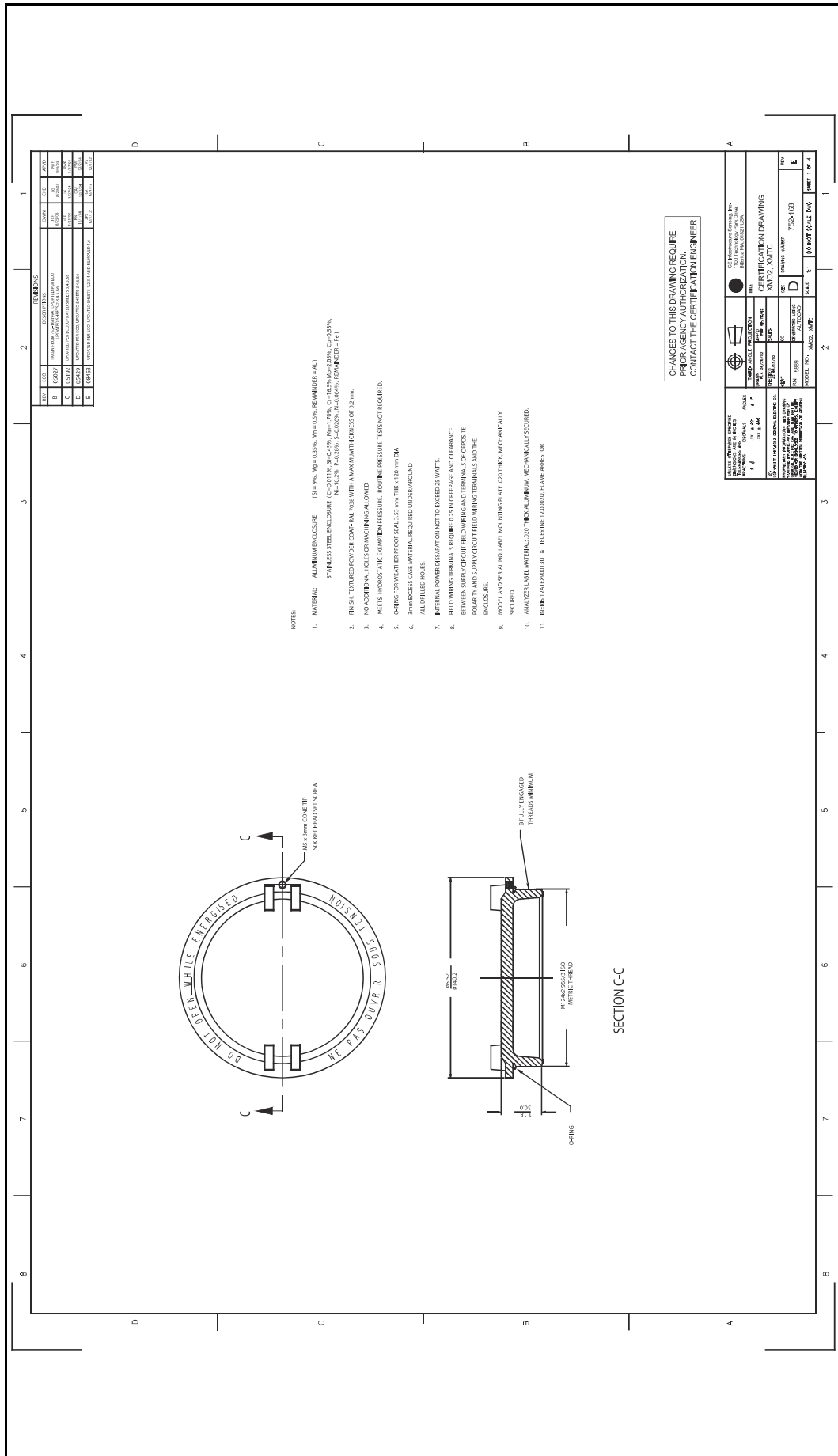

Figure 60: Certification drawing (ref. 752-168, Rev. E. SH)

UPDATE WITH LATEST REV

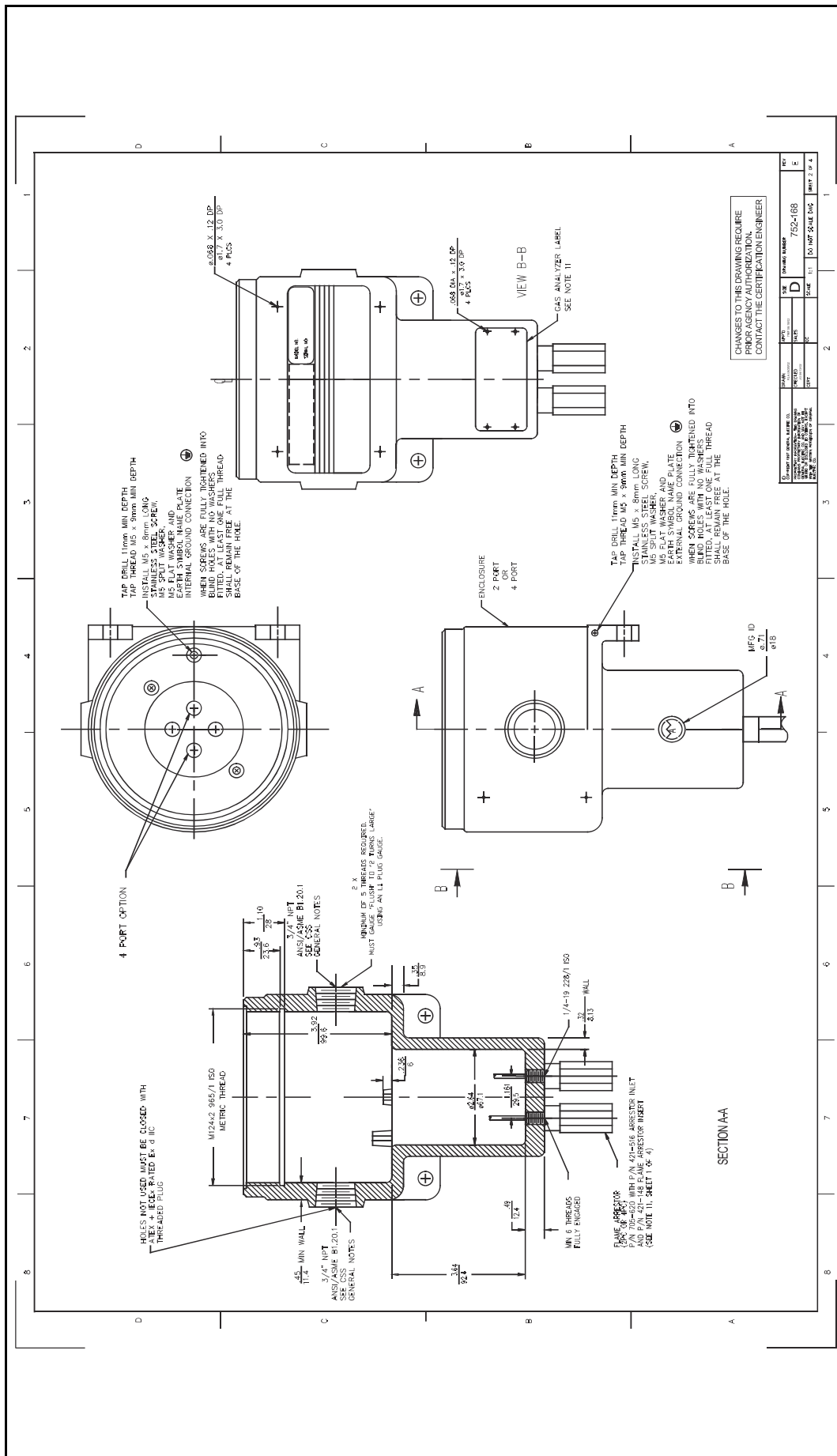

Figure 61: Certification drawing (ref, 752-168, Rev. E, SH2)

UPDATE WITH LATEST REV

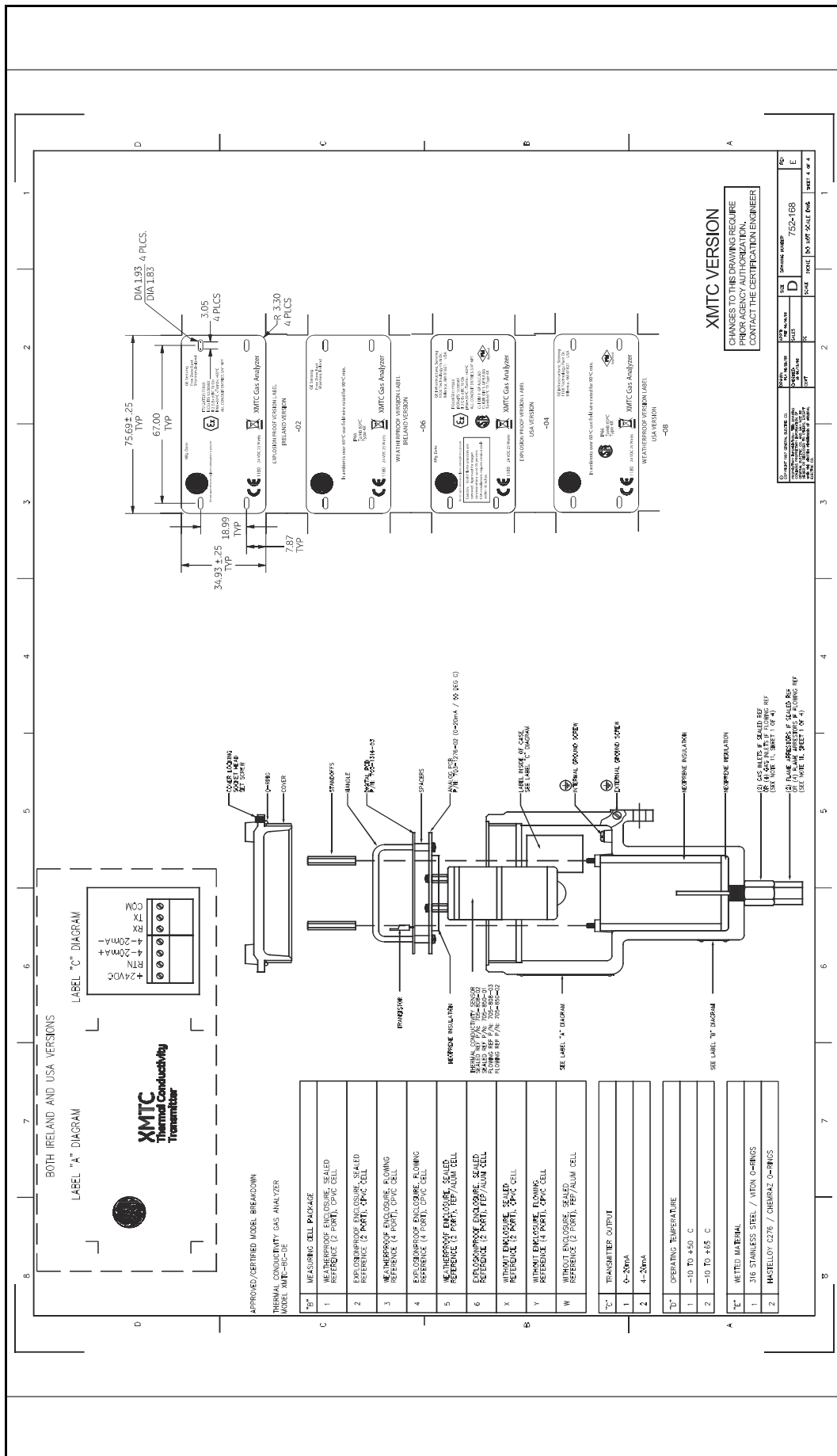

Figure 62: Certification drawing (ref. 752-168, Rev. E, SH4)

UPDATE WITH LATEST REV

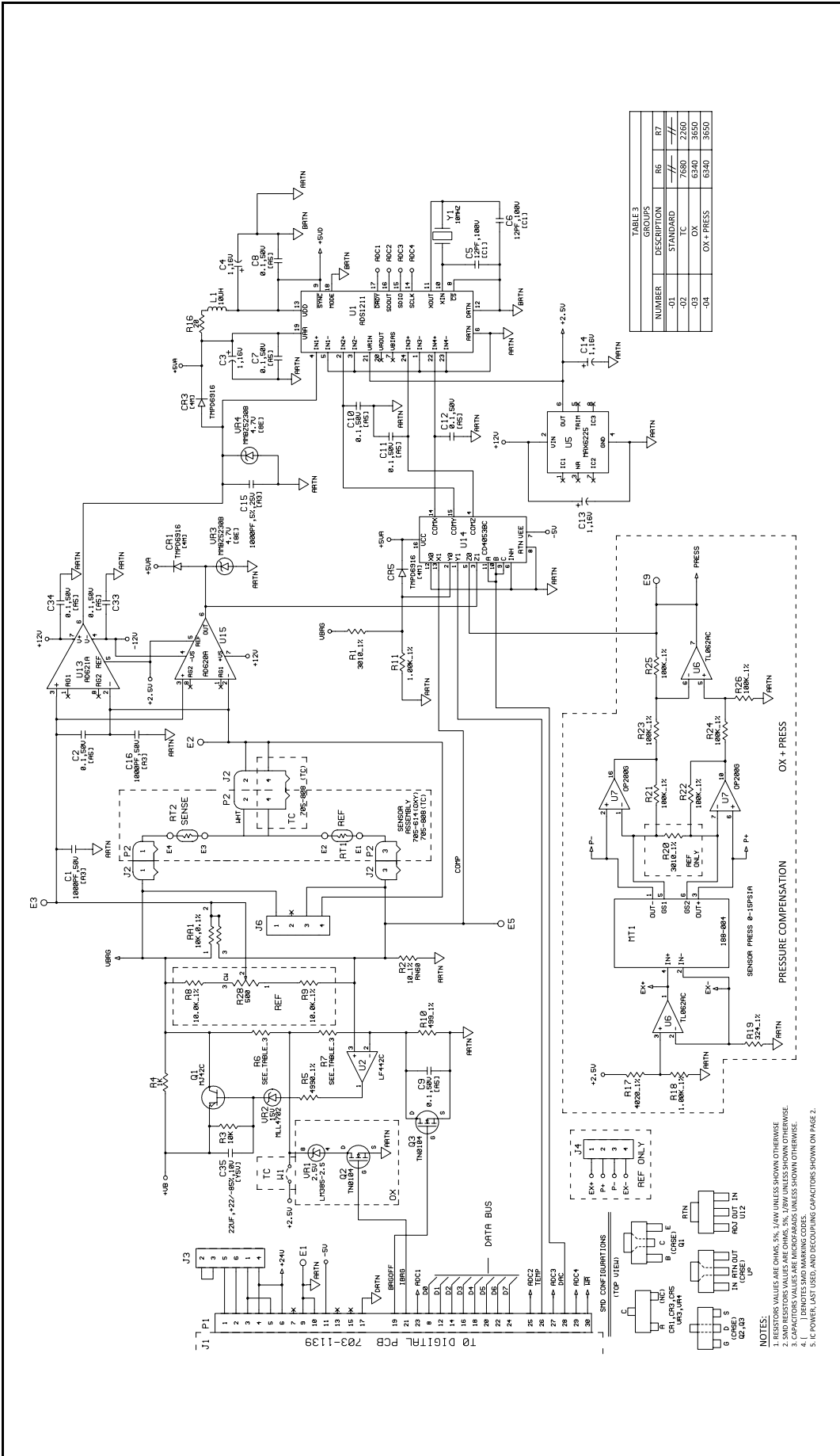

Figure 63: Analog PCB schematic (ref. 700-1276, Rev. F, SHI)

UPDATE WITH LATEST REV

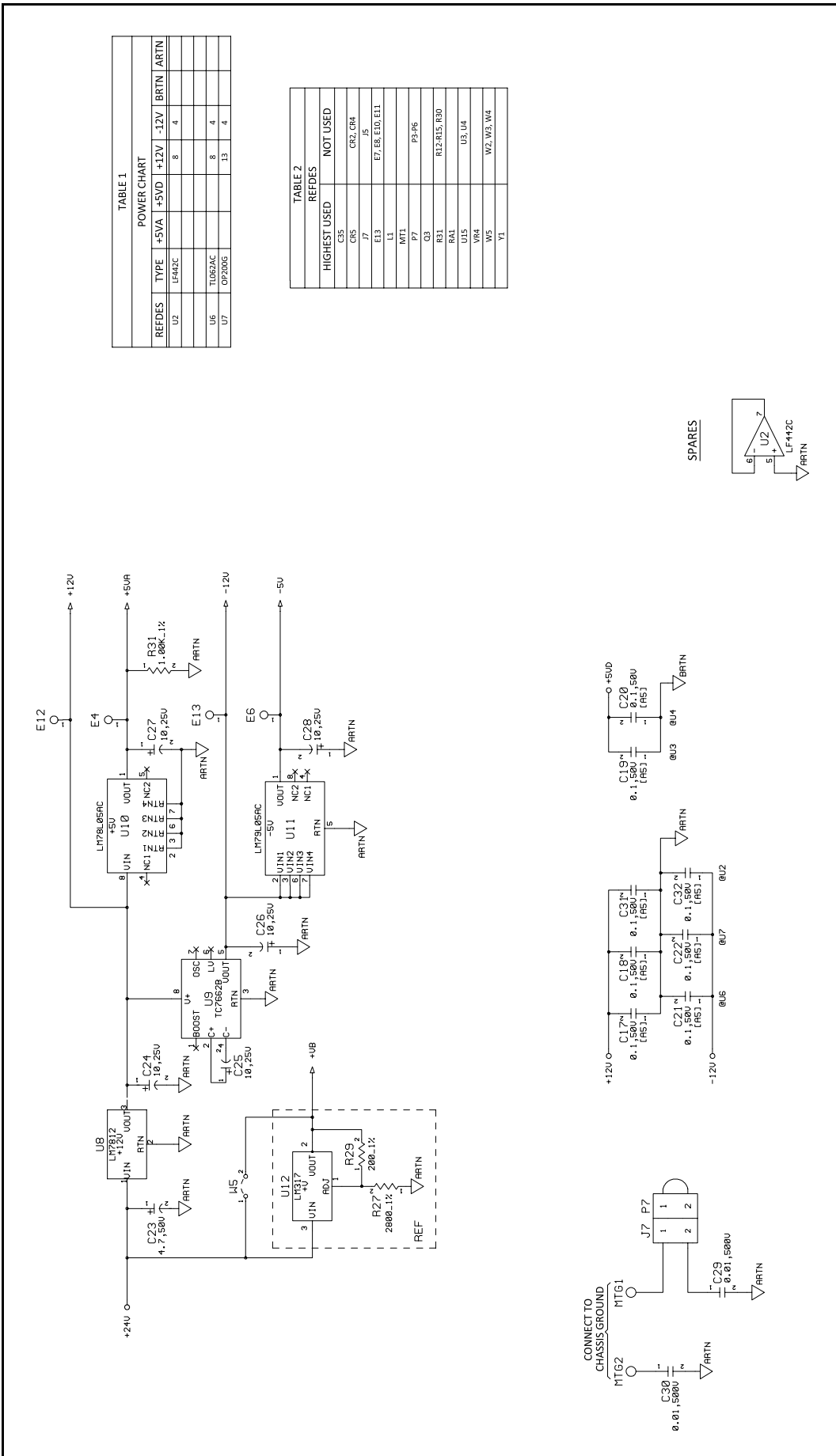

TABLE 1
POWER CHART

REFDES	TYPE	+5VA	+5VD	+12V	-12V	BRTN	ARTN
U2	LF442C			8	4		
U6	TL062AC			8	4		
U7	OP2200G			13	4		

TABLE 2
REFDES

HIGHEST USED	NOT USED
C35	CR2, CR4
CR5	J5
E13	E7, E8, E10, E11
L1	
MT1	
P7	P3-P6
Q3	
R31	R12-R15, R30
RA1	
U15	U3, U4
VR4	
W5	W2, W3, W4
Y1	

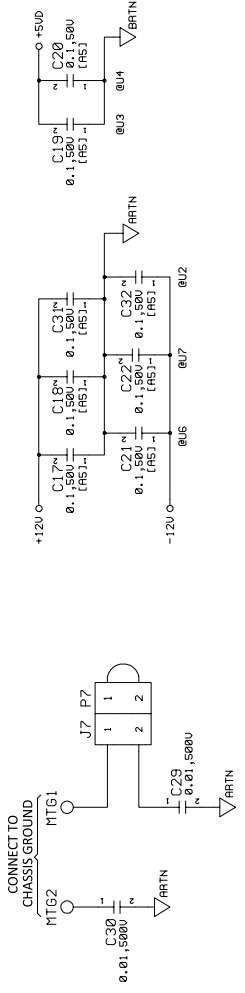
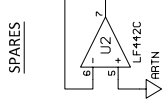

Figure 64: Analog PCB schematic (ref. 700-1276, Rev. F, SH2)

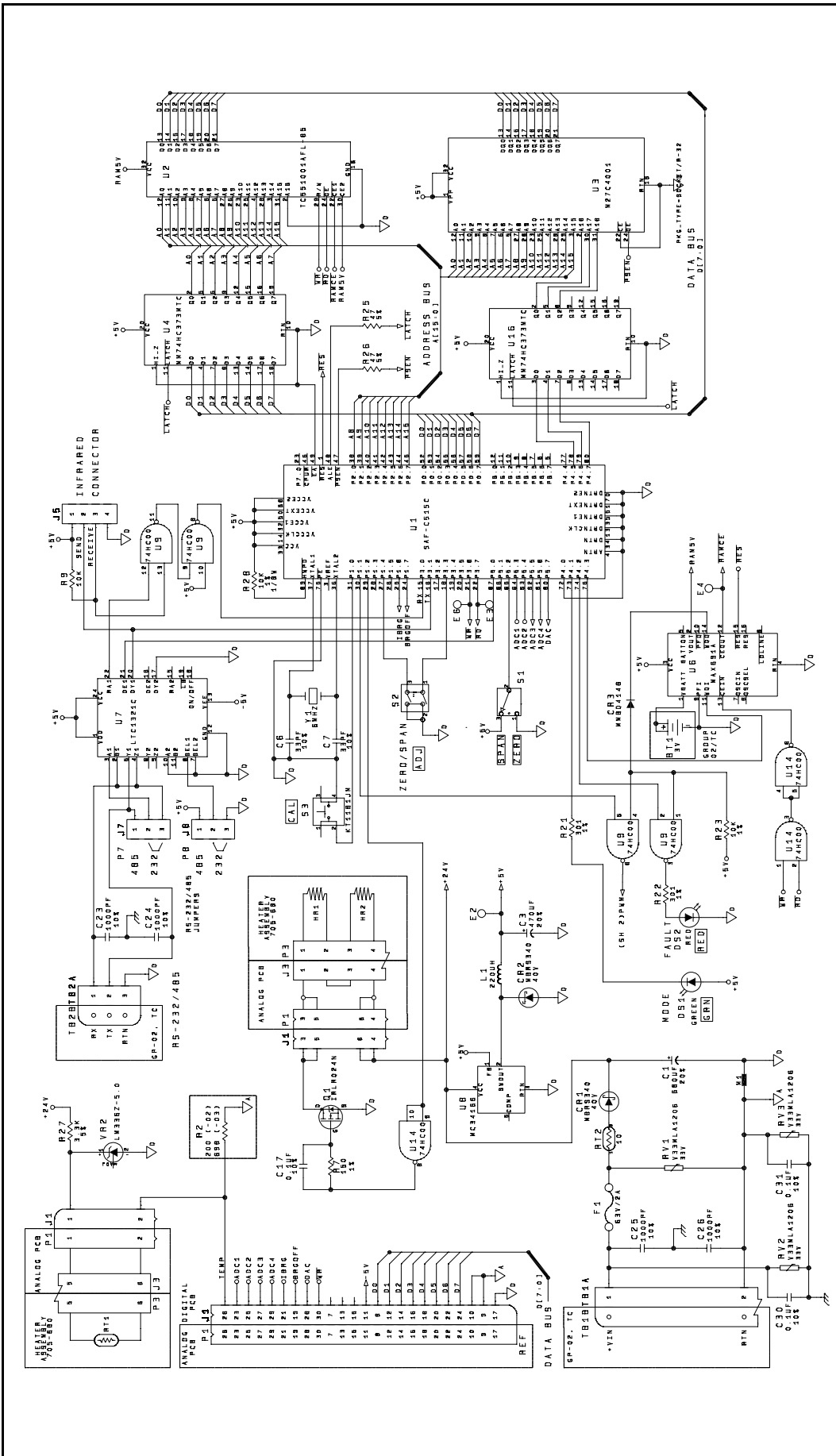

Figure 65: Digital PCB schematic (ref. 700-1316, Rev. H, SH1)

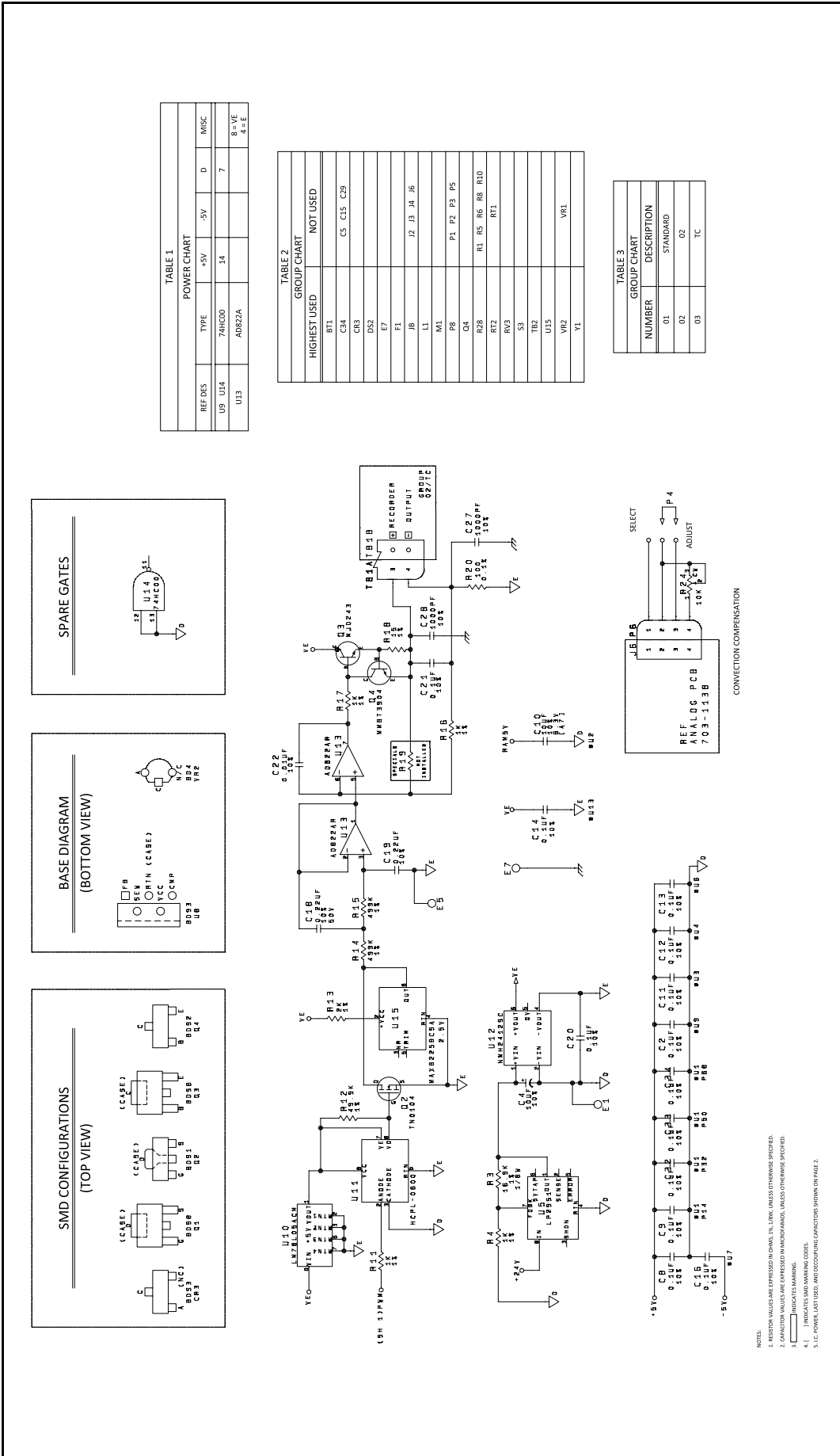

Figure 66: Digital PCB schematic (ref. 700-1316, Rev. H, SH2)

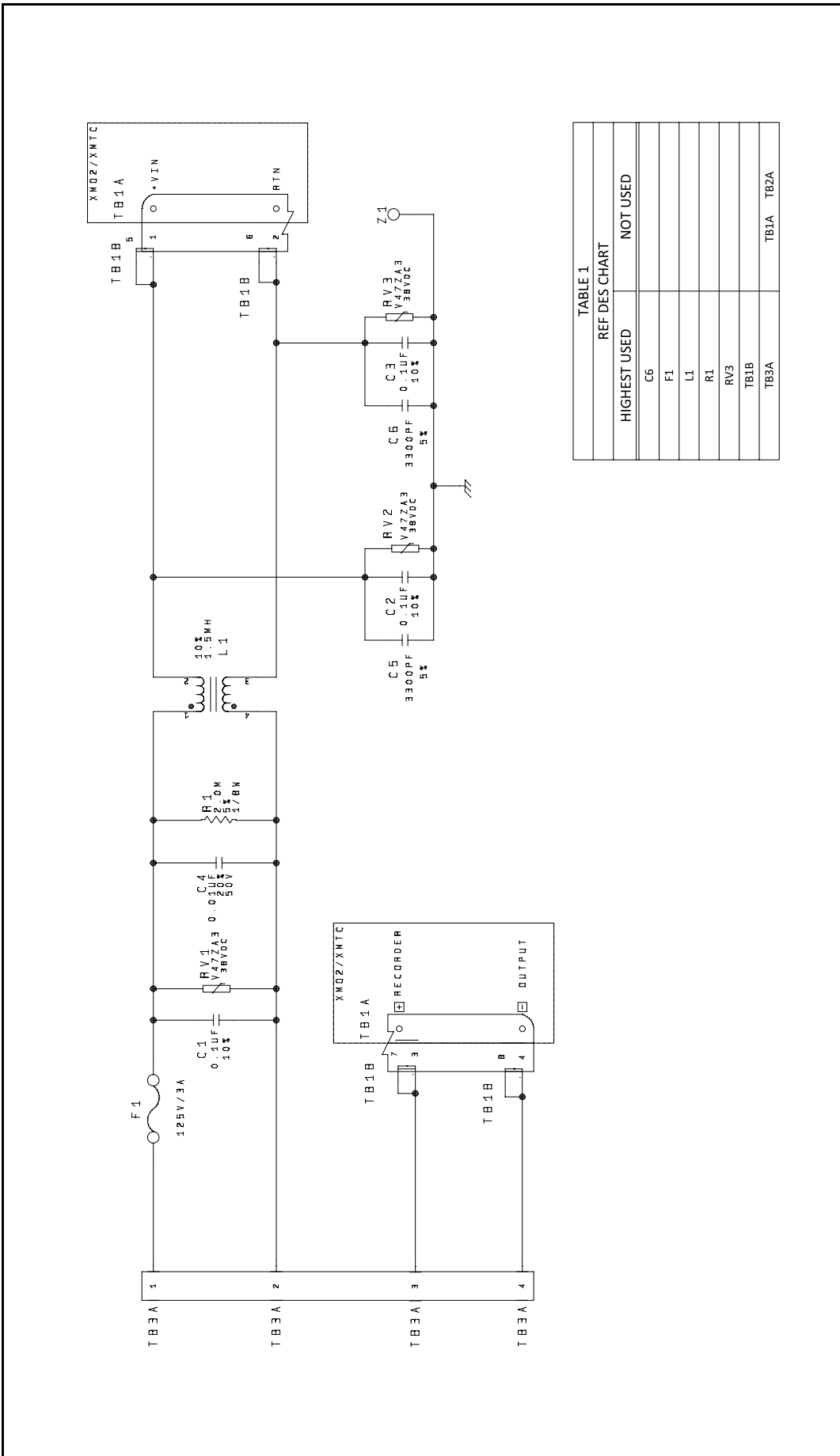

TABLE 1
REF DES CHART

HIGHEST USED	NOT USED
C6	
F1	
L1	
R1	
RV3	
TB1B	
TB3A	TB1A TB2A

Figure 67: EMI filter PCB schematic (ref. 700-1550, Rev. A)

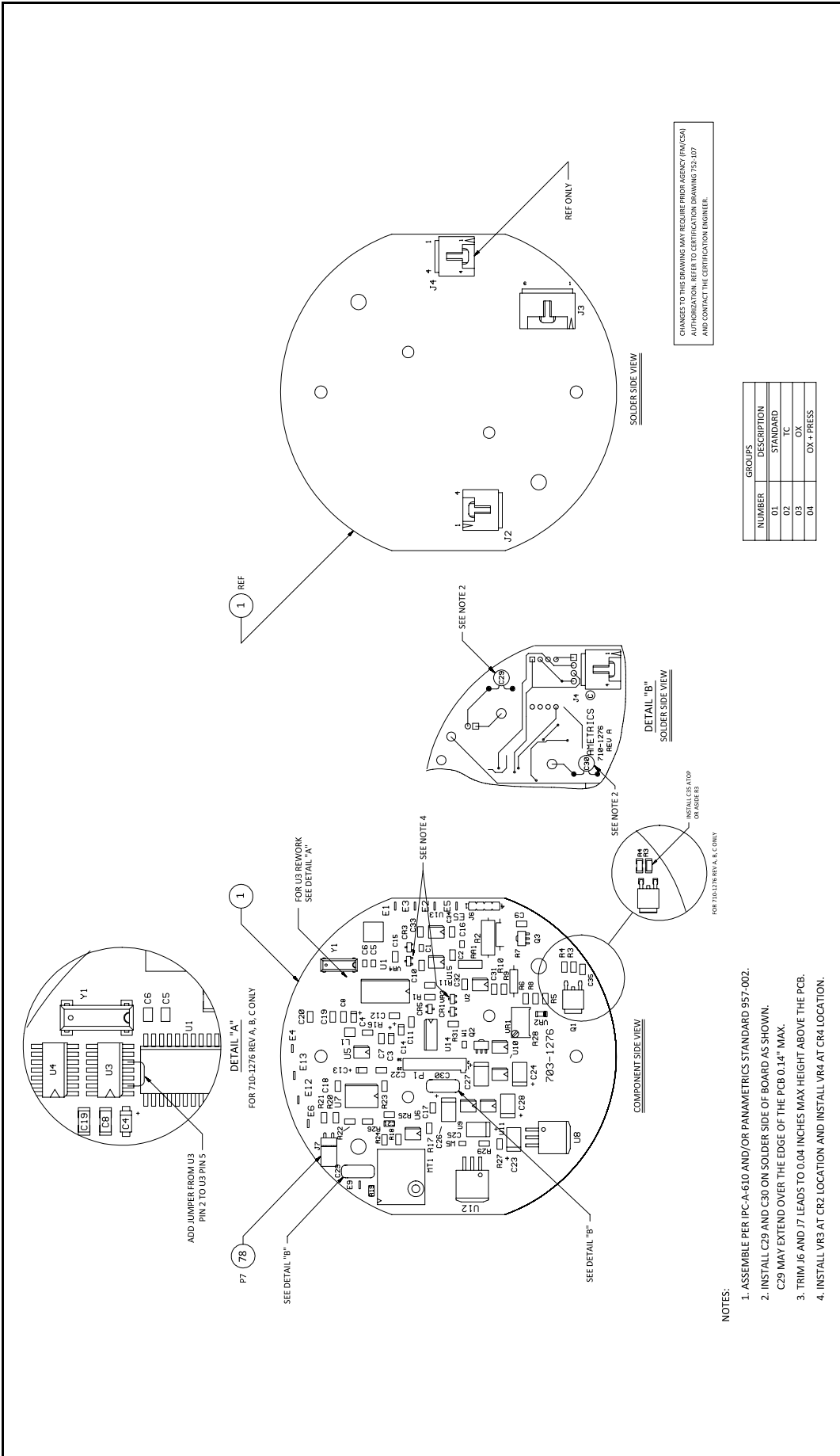
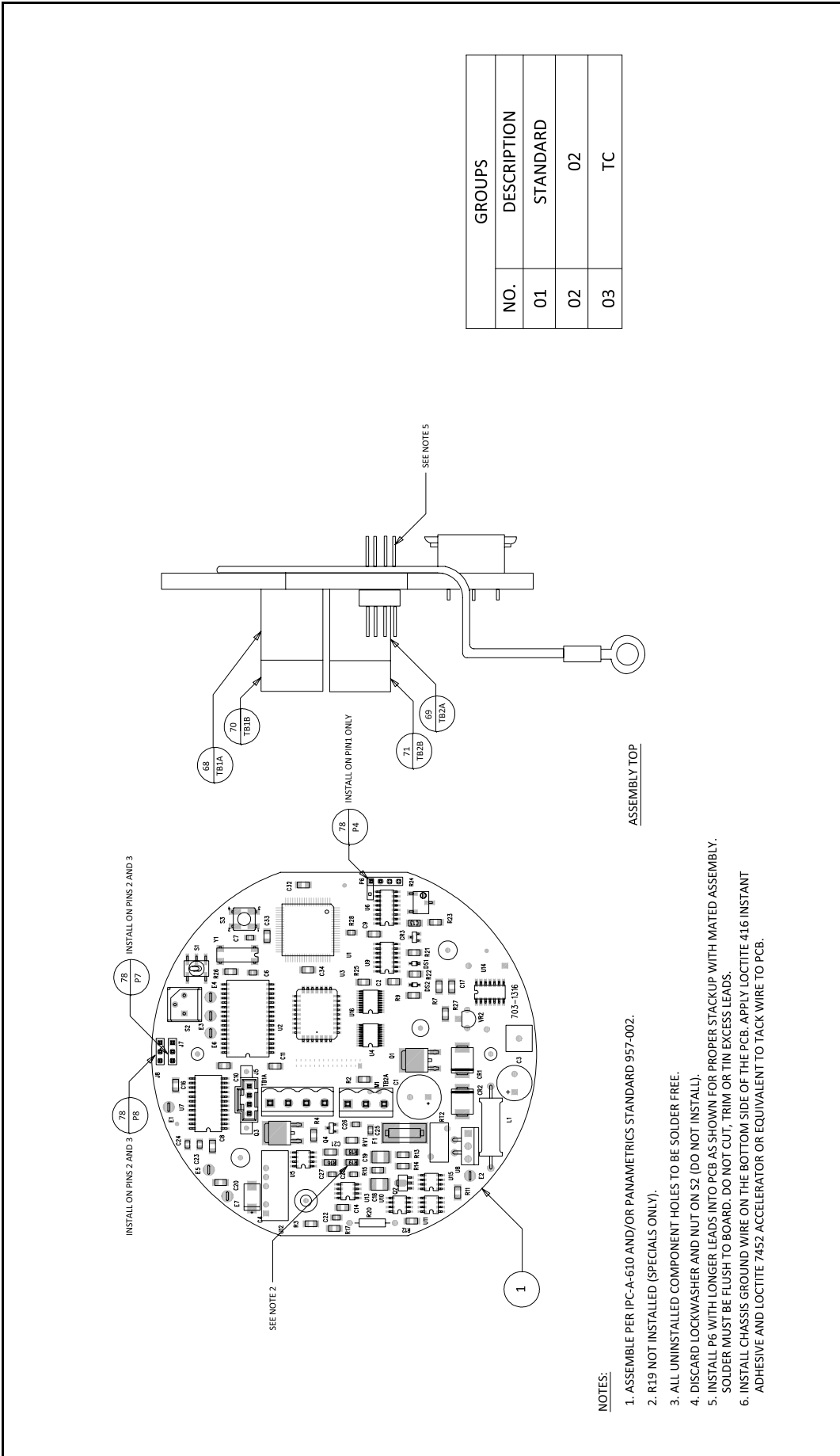

Figure 68: Analog PCB assembly (ref. 703-1276, Rev. H)

UPDATE WITH LATEST REV



NOTES:

1. ASSEMBLE PER IPC-A-610 AND/OR PANAMETRICS STANDARD 957-002.
2. R19 NOT INSTALLED (SPECIALS ONLY).
3. ALL UNINSTALLED COMPONENT HOLES TO BE SOLDER FREE.
4. DISCARD LOCKWASHER AND NUT ON S2 (DO NOT INSTALL).
5. INSTALL P6 WITH LONGER LEADS INTO PCB AS SHOWN FOR PROPER STACKUP WITH MATED ASSEMBLY. SOLDER MUST BE FLUSH TO BOARD. DO NOT CUT, TRIM OR TIN EXCESS LEADS.
6. INSTALL CHASSIS GROUND WIRE ON THE BOTTOM SIDE OF THE PCB. APPLY LOCTITE 416 INSTANT ADHESIVE AND LOCTITE 7452 ACCELERATOR OR EQUIVALENT TO TACK WIRE TO PCB.

ASSEMBLY TOP

Figure 69: Digital PCB assembly (ref. 703-1316, Rev. K, SHI)

UPDATE WITH LATEST REV

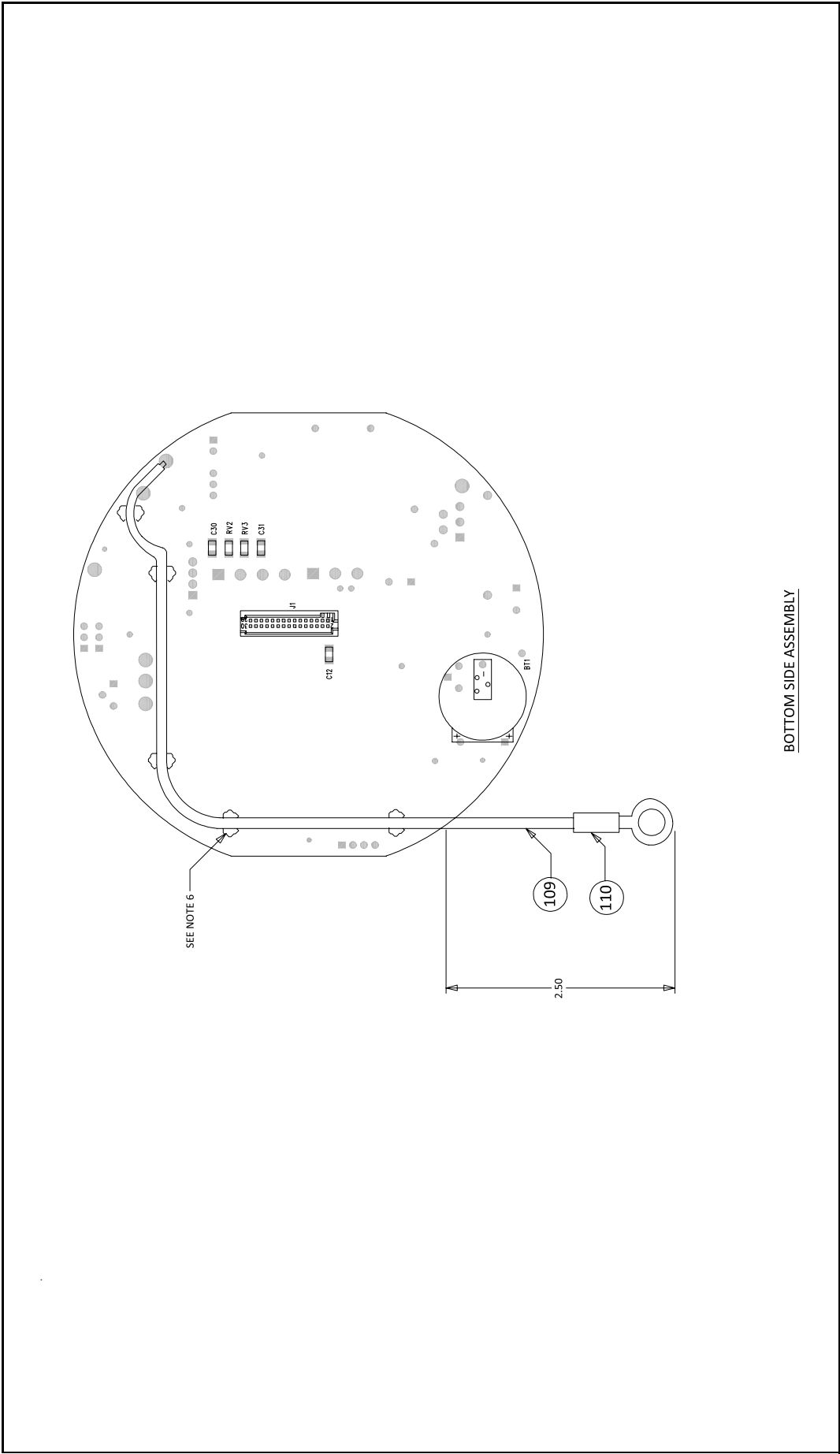
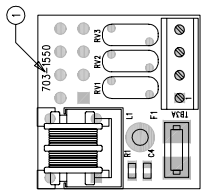
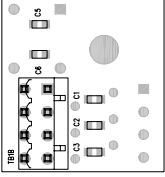

Figure 70: Digital PCB assembly (ref. 703-1316, Rev. K, SH2)

UPDATE WITH LATEST REV



ASSEMBLY TOP



BOTTOM SIDE ASSEMBLY

NOTES:

1. ASSEMBLE PER IPC-A-610 AND/OR PANAMETRICS STANDARD 957-002.

Figure 71: EMI filter PCB assembly (ref. 703-1550, Rev. A, SH1 & SH2)

UPDATE WITH LATEST REV

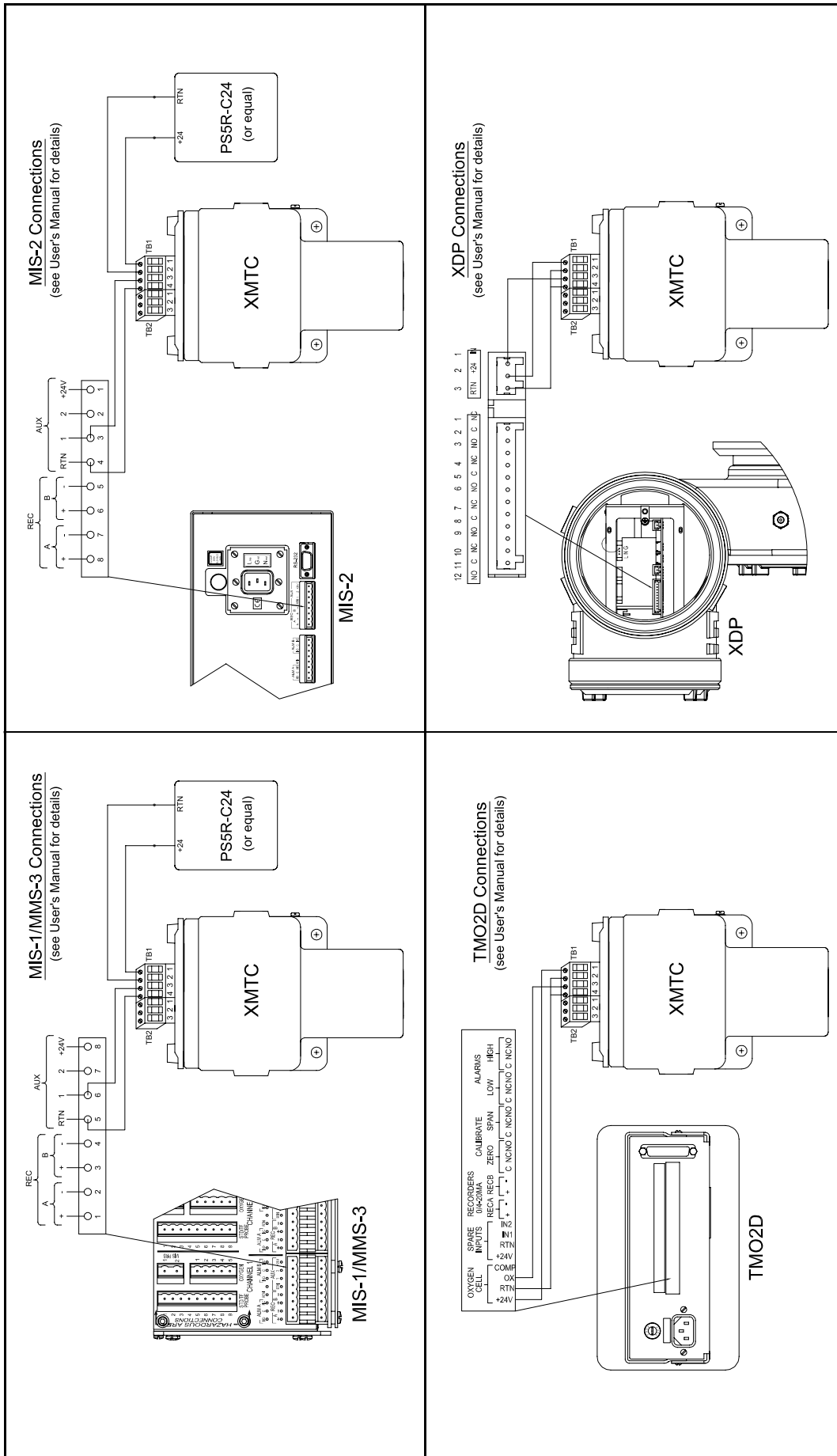

Figure 72: XMTc interconnection diagrams

Appendix D. The enhanced advanced option

D.1 Entering the enhanced advanced option

For internal technical support, the XMTC transmitter software includes in its edit functions submenu (*advanced option* command) several commands only accessible with factory authorization. Since improper programming could result in serious performance inaccuracies, these commands should only be accessed under direct factory supervision using the Panametrics IDM™ software.

IMPORTANT:

You must contact Panametrics before changing the parameters in this menu.

To access the enhanced *advanced option*:

1. From the *edit functions* menu (see *Figure 10* on page 14), click on *advanced*.
2. When a window similar to *Figure 73* below opens, enter your factory-level password. Contact Panametrics for the appropriate password.

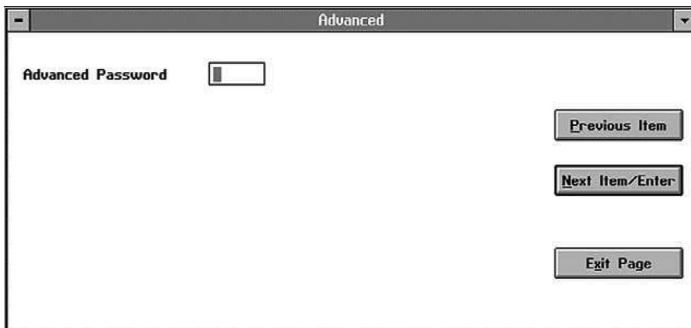

Figure 73: Password window

After you have entered the password, an *advanced* window similar to *Figure 74* below opens.

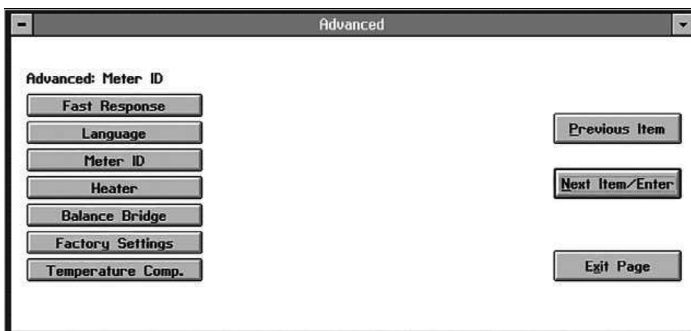

Figure 74: Advanced window

Along with *fast response*, *language*, and *meter ID* discussed in *Chapter 3. Operation and programming* on page 13, the enhanced *advanced menu* offers four additional commands:

- **Heater**
Sets a specified operating temperature for the XMTC cell.
- **Balance bridge**
Compensates the XMTC cell for nonlinearity in the bridge (for factory use only).
- **Factory commands**
Allows users to upload or download modified settings or to reset the values to the factory defaults.
- **Temperature comp.**
Allows entry of temperature calibration values (for factory use only).

Click on the desired option to open it, or click on next item/enter to open the menu listed on the status line above the options. (Click previous item or exit page to close the window without entering any commands.)

D.2 Heater

The parameters in the *heater* command affect the operation of the heater controls. The window for the *heater* command is similar to *Figure 75* below.

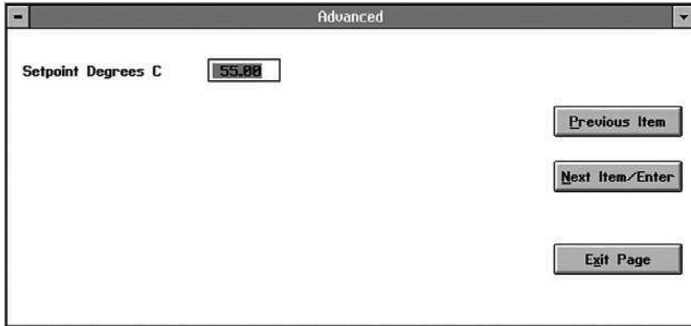

The screenshot shows a window titled "Advanced" with a dropdown arrow. Inside, there is a label "Setpoint Degrees C" followed by a text input field containing the value "55.00". To the right of the input field are three buttons: "Previous Item", "Next Item/Enter", and "Exit Page".

Figure 75: Temperature comp. window

The first command, *setpoint degrees C*, asks you to enter the *heater setpoint* (the temperature at which the cell is maintained). Enter the desired temperature (in degrees C) and press *next item/enter* to confirm the entry. (For any command, click *previous item* to return to the previous parameter, or *exit page* to close the window without changing any values.)

The next command, as shown in *Figure 76* below, asks you to enter the *proportional band* (in degrees C). This parameter should be set at 5° unless otherwise specified by Panametrics.

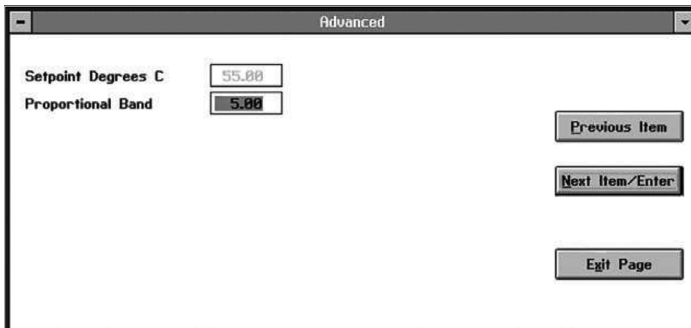

The screenshot shows a window titled "Advanced" with a dropdown arrow. Inside, there are two labels: "Setpoint Degrees C" with a text input field containing "55.00", and "Proportional Band" with a text input field containing "5.00". To the right of the input fields are three buttons: "Previous Item", "Next Item/Enter", and "Exit Page".

Figure 76: Proportional band in the heater window

Enter the desired value and click on *next item/enter* to confirm the entry.

The final command asks for the *integral time* in seconds, as shown in *Figure 77* below. Unless otherwise specified by Panametrics, the integral time should be set at 200.00.

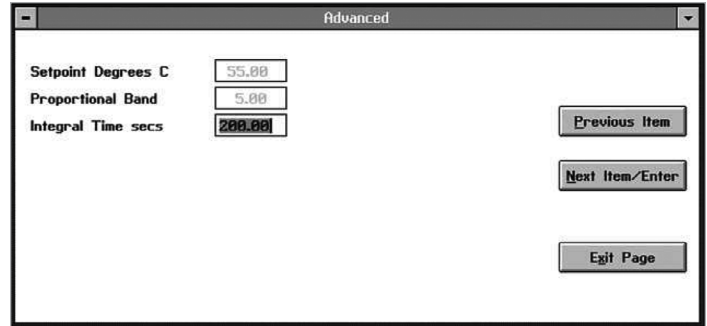

The screenshot shows a window titled "Advanced" with a dropdown arrow. Inside, there are three labels: "Setpoint Degrees C" with a text input field containing "55.00", "Proportional Band" with a text input field containing "5.00", and "Integral Time secs" with a text input field containing "200.00". To the right of the input fields are three buttons: "Previous Item", "Next Item/Enter", and "Exit Page".

Figure 77: Integral time secs in the heater window

Enter the desired number of seconds, and click on *next item/enter* to confirm the entry and return to the *advanced* window.

D.3 Balance bridge

The window for the *balance bridge* command is similar to *Figure 78* below.

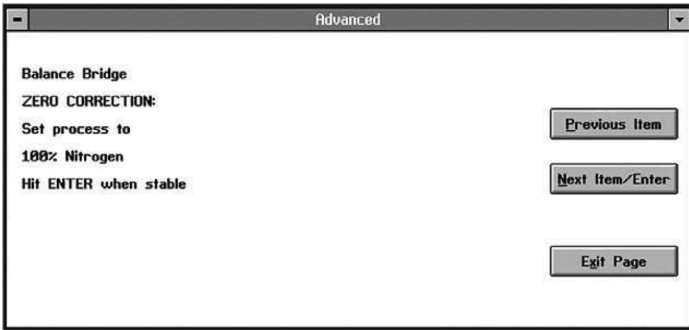

Figure 78: Balance bridge window

Click on *next item/enter* after the bridge has reached stability. You can monitor stability in the *real time/diagnostics* menu of IDM. The next window lists the selected thermal parameters, as shown in *Figure 79* below.

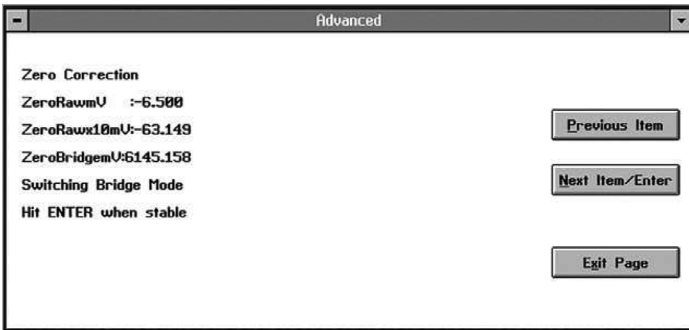

Figure 79: Zero correction window

Click on *next item/enter* to complete the balancing procedure. The window displays the thermal balance or imbalance diagnostic, as shown in *Figure 80* below.

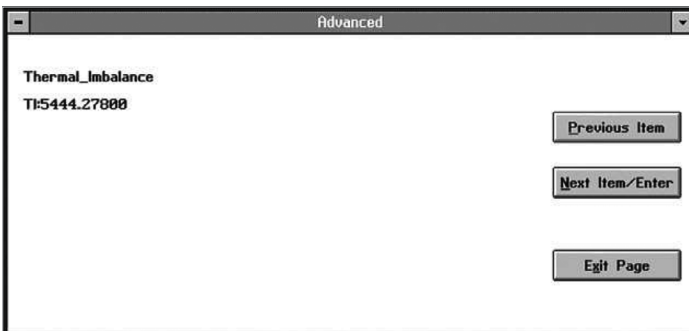

Figure 80: Thermal Balance (or Imbalance) window

Click on *next item/enter* to return to the *advanced* window.

D.4 Factory settings

The window for the *factory settings* command is similar to *Figure 81* below.

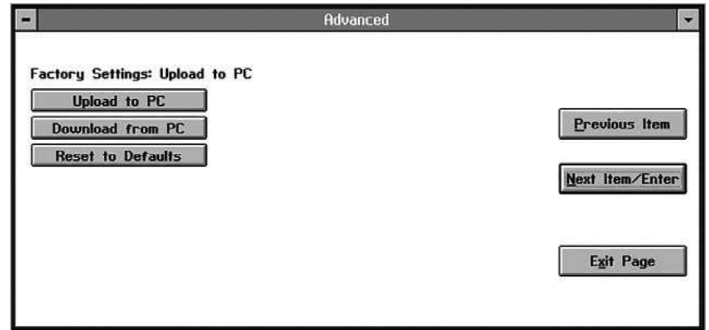

Figure 81: Factory settings command

If you click on *upload to PC*, you are prompted to create a file, as shown in *Figure 82* below.

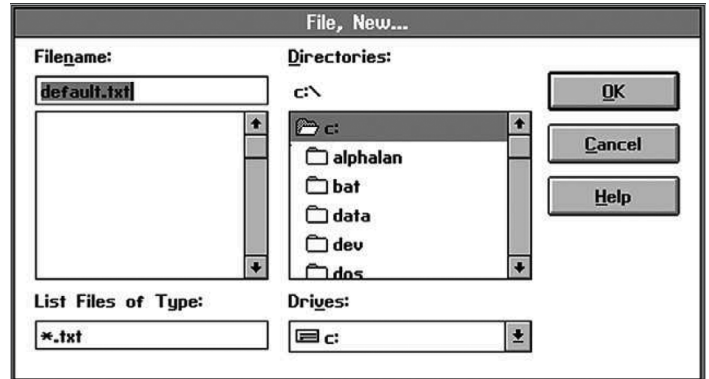

Figure 82: Creating a data File

If you click on *download from PC*, you are asked for a file name, as shown in *Figure 83* below.

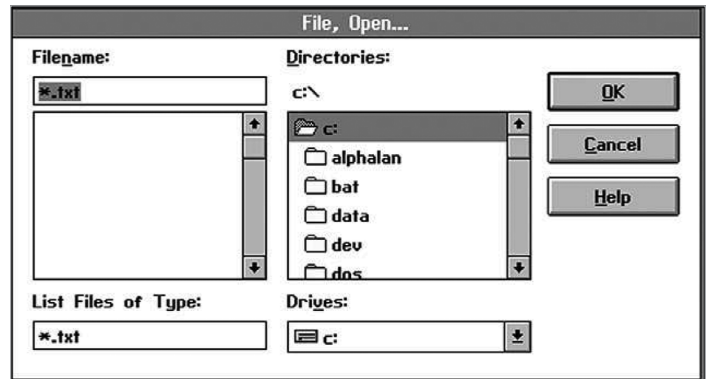
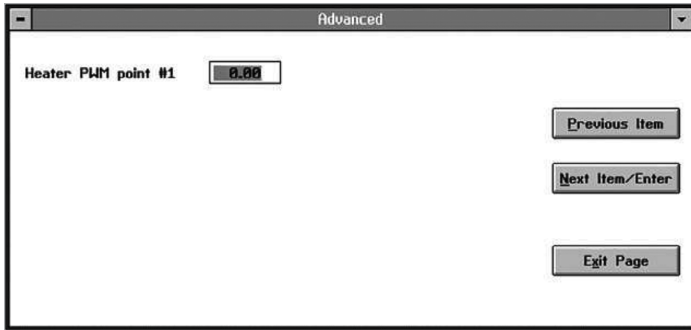

Figure 83: Downloading a data File

However, if you click on *reset to defaults*, the status is displayed in the *factory settings* window. Click on *next item/enter* to confirm the entry. (Click *previous item* or *exit page* to close the window without changing the status.)

D.5 Temperature comp.

The window for the *temperature comp.* command is similar to *Figure 84* below.



The screenshot shows a window titled "Advanced" with a dropdown arrow. It contains a text input field labeled "Heater PWM point #1" with the value "0.00" entered. To the right of the input field are three buttons: "Previous Item", "Next Item/Enter", and "Exit Page".

Figure 84: Temperature comp. window

The first command asks for the *PWM* (pulse-width-modulation) for *point #1*. PWM represents the ratio of the heater *on* time to the heater *off* time. It acts to compensate for drift due to changes in ambient temperature. Enter the desired percentage of time the heater is ON, and click on *next item/enter* to confirm the entry. (For any command, click *previous item* to return to the previous parameter, or *exit page* to close the window without changing any values.)

At the next command, as shown in *Figure 85* below, enter the *K-factor* (the compensation for the PWM percentage) for point #1.

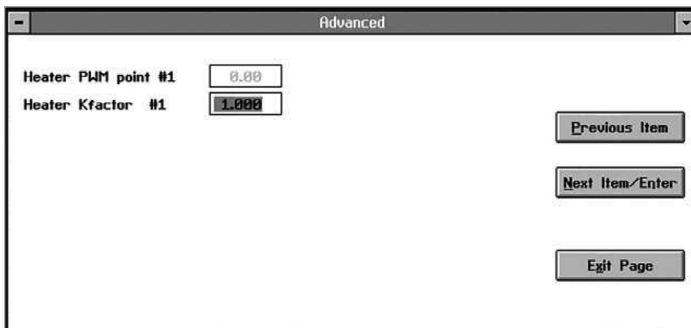

The screenshot shows the "Advanced" window with two input fields. The first is "Heater PWM point #1" with "0.00" and the second is "Heater Kfactor #1" with "1.000" entered. The "Next Item/Enter" button is highlighted. The other buttons are "Previous Item" and "Exit Page".

Figure 85: K-factor window

At the next prompt, enter the K factor for the analog output, as shown in *Figure 86* below.

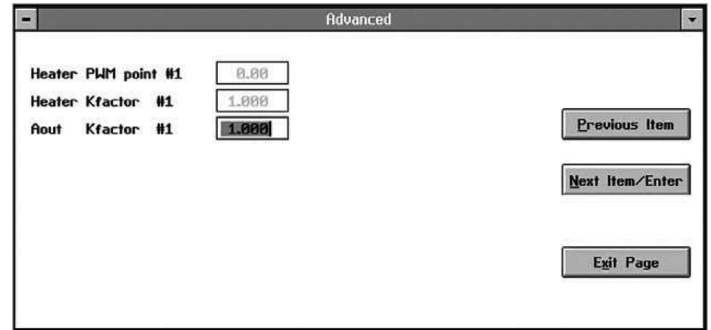

The screenshot shows the "Advanced" window with three input fields. The first is "Heater PWM point #1" with "0.00", the second is "Heater Kfactor #1" with "1.000", and the third is "Aout Kfactor #1" with "1.000" entered. The "Next Item/Enter" button is highlighted. The other buttons are "Previous Item" and "Exit Page".

Figure 86: Aout K-factor window

At the following series of prompts, enter the PWM point, the K-factor and the Aout K-factor for points #2 and #3. In each case, enter the desired value and click on *next item/enter* to confirm the entry.

At the final prompt, as shown in *Figure 87* below, enter the *temperature mV K-factor*, a compensation to the bridge reading during ambient temperature transitions.

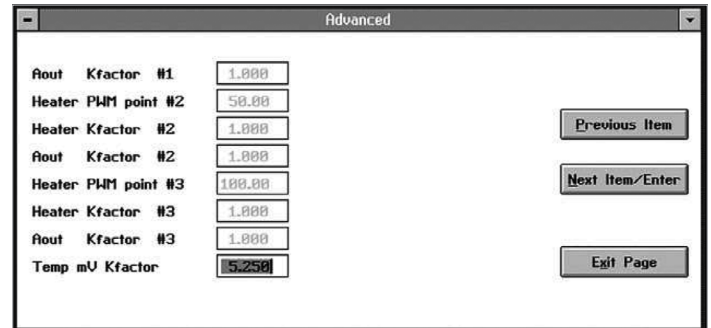

The screenshot shows the "Advanced" window with six input fields. The first is "Aout Kfactor #1" with "1.000", the second is "Heater PWM point #2" with "50.00", the third is "Heater Kfactor #2" with "1.000", the fourth is "Aout Kfactor #2" with "1.000", the fifth is "Heater PWM point #3" with "100.00", the sixth is "Heater Kfactor #3" with "1.000", and the seventh is "Aout Kfactor #3" with "1.000". The final field is "Temp mV Kfactor" with "5.250" entered. The "Next Item/Enter" button is highlighted. The other buttons are "Previous Item" and "Exit Page".

Figure 87: Temperature mV Kfactor window

Enter the desired number and click on *next item/enter* to confirm the entry. You are then returned to the advanced menu.

Appendix E. CE Mark compliance

E.1 CE Mark requirements

	<p>WARNING!</p> <p>CE Mark compliance is required for all units installed in EU countries.</p>
---	---

	<p>WARNING!</p> <p>To meet CE Mark requirements, you must shield and ground all electrical cables as described in this section (see <i>Table 5</i> below).</p>
---	---

NOTE: If you follow the instructions in this section, your unit will comply with the EMC directive.

	<p>WARNING!</p> <p>Cable entries of an approved flameproof design are required. These must be installed according to the manufacturer's instructions. The choice of cable entry device may limit the overall installation category achieved.</p>
---	---

	<p>WARNING!</p> <p>It is the responsibility of the user to ensure that all cable entry devices and covers are properly installed and secure prior to applying power to the XMTC.</p>
---	---

Table 5: Wiring requirements for CE Mark compliance

Connection	Termination modification
Power/analog output	<ol style="list-style-type: none"> 1. When connecting the line power/analog output cable, select the cable entry closest to the terminal blocks. 2. Use shielded cable* to connect the line power and the 4–20mA analog output device to the XMTC. It is recommended to use Panametrics P/N X4(*) or equivalent for all weatherproof installation, and Panametrics P/N Z4(*) or equivalent for all explosion/flameproof installation. 3. Terminate the shield to the cable gland. It is recommended to use Panametrics P/N 419-215 or equivalent for all weatherproof installation and Panametrics P/N 419-217 or equivalent for all explosion/flameproof installation.
RS232 output	<ol style="list-style-type: none"> 1. Use shielded cable* to interconnect the XMTC enclosure with any external I/O devices. It is recommended to use Panametrics P/N 704-668-12 or equivalent for all weatherproof installation and Panametrics P/N 704-1262-12 or equivalent for all explosion/flameproof installation. 2. Terminate the shield to the cable gland. It is recommended to use Panametrics P/N 419-215 or equivalent for all weatherproof installation and Panametrics P/N 419-217 or equivalent for all explosion/flameproof installation.

*Wires enclosed in a properly-grounded metal conduit do not require additional shielding.

E.2 EMI filter board

For CE compliance, an *EMI filter board* has been added to the XMTc (see *Figure 88* below). This board is connected internally to terminal block *TB1*. The power and analog output connections are now made to terminal block *TB3* on the EMI filter board. The RS232 *digital output* connections are made to terminal block *TB2*.



CAUTION!

Do not make any connections to unassigned or unused terminals.

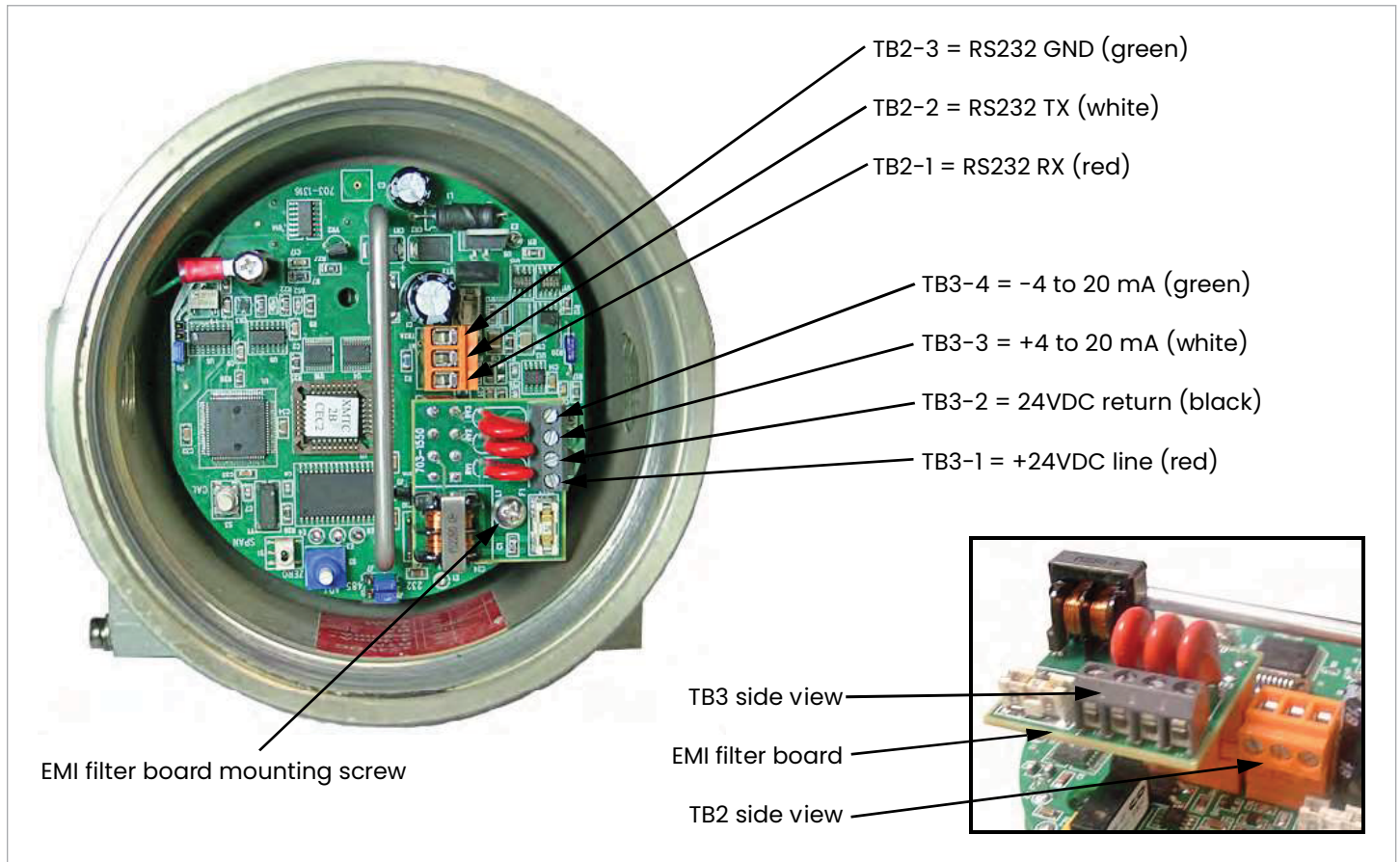

Figure 88: XMTc with EMI filter board - wiring connections

E.3 Wiring the signal connections for the weatherproof version

Refer to *Figure 88* on page 62, and complete the following steps to make the proper wiring connections:



WARNING!

Cable entries of an approved flameproof design are required. These must be installed according to the manufacturer's instructions. The choice of cable entry device may limit the overall installation category achieved.

1. Install the first cable entry device in accordance with the manufacturer's instructions.

NOTE: If installation of the cable entry device is only partially complete, Panametrics recommends tagging the device to ensure the safety of subsequent users.

- a. Thread the cable gland entry body into the XMTC port closest to the terminal blocks.
- b. Route the 4-wire power/analog output cable through the cable gland as shown in *Figure 89* below.
- c. After terminating the shield as shown, assemble the three gland pieces together and tighten the gland to secure the cable and the shield.

IMPORTANT:

The cable shield must be terminated in the cable gland as shown in *Figure 89* below.

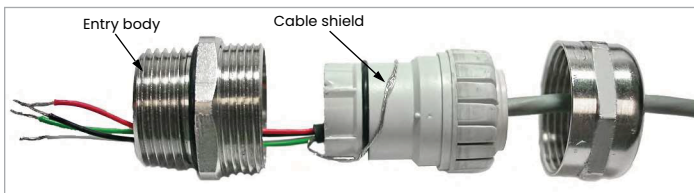

Figure 89: Proper cable gland assembly (Panametrics p/n 419-215)

2. Remove the screw that secures the EMI filter board to its standoff. Then, pull the board from its socket to access the TB3 connector, and loosen the terminal screws on the TB3 connector.
3. Connect the power leads:



CAUTION!

Connecting the +24 VDC line (red) lead to any terminal except TB3-1 will damage the XMTC.

- a. Insert the 4-wire cable +24 VDC line (red) lead into pin TB3-1 and tighten the screw.
- b. Insert the 4-wire cable 24 VDC return (black) lead into pin TB3-2 and tighten the screw.

4. Connect the analog output leads:
 - a. Insert the 4-wire cable + 4-20 mA (white) lead into pin TB3-3 and tighten the screw.
 - b. Insert the 4-wire cable - 4-20 mA (green) lead into pin TB3-4 and tighten the screw.
5. Carefully plug the EMI filter board back into its socket, and screw the EMI filter board to its standoff.
6. If you are installing the second cable entry device, do so in accordance with the manufacturer's instructions.

NOTE: If installation of the cable entry device is only partially complete, Panametrics recommends tagging the device to ensure the safety of subsequent users.

- a. Thread the cable gland entry body into the remaining XMTC port.
- b. Route the 3-wire RS232 cable through the cable gland as shown in *Figure 89* on page 63.
- c. After terminating the shield as shown, assemble the three gland pieces together and tighten the gland to secure the cable and the shield.

IMPORTANT:

The cable shield must be terminated in the cable gland as shown in *Figure 89* on page 63.

7. Unplug the TB2 connector by pulling it straight out of its socket, and loosen the terminal screws on the TB2 connector.
8. Connect the RS232 serial port leads:
 - a. Insert the 3-wire cable RX (red) lead into pin TB2-1 and tighten the screw.
 - b. Insert the 3-wire cable TX (white) lead into pin TB2-2 and tighten the screw.
 - c. Insert the 3-wire cable GND (green) lead into pin TB2-3 and tighten the screw.
9. Carefully plug the TB2 connector into its socket.
10. Reinstall the cover on the XMTC.
11. Connect the other ends of the cables to the 24 VDC power supply, the 4-20 mA input of the display device, and the serial port of the computer or terminal (see the instruction manuals for those devices for details).

E.4 Wiring the signal connections for the explosion/flameproof version

Refer to *Figure 88* on page 62, and complete the following steps to make the proper wiring connections:



WARNING!

Cable entries of an approved flameproof design are required. These must be installed according to the manufacturer's instructions. The choice of cable entry device may limit the overall installation category achieved.

1. Install the first cable entry device in accordance with the manufacturer's instructions.

NOTE: If installation of the cable entry device is only partially complete, Panametrics recommends tagging the device to ensure the safety of subsequent users.

- a. Remove the tab "remove before installation".
- b. Thread the cable gland entry body into the XMTC port closest to the terminal blocks.
- c. Route the 4-wire power/analog output cable & its ground lug through the cable gland.
- d. Fray the braided shield and spread evenly around the cone as shown in *Figure 90* below. Compress the ring to lock the shield.
- e. After terminating the shield as shown, assemble the gland pieces together and tighten the gland to secure the cable and the shield.

IMPORTANT:

The cable shield must be terminated in the cable gland as shown in *Figure 90* below.

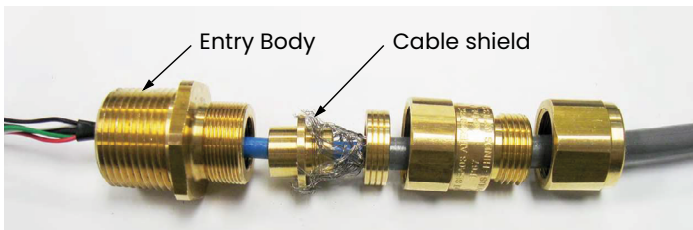

Figure 90: Proper cable Gland assembly (Panametrics p/n 419-217)

2. Remove the standoff and the screw that secures the EMI filter board to its standoff. Then, pull the board from its socket to access the TB3 connector, and loosen the terminal screws on the TB3 connector.
3. Connect the power leads:



CAUTION!

Connecting the +24 VDC line (red) lead to any terminal except TB3-1 will damage the XMTC.

- a. Insert the 4-wire cable +24 VDC line (red) lead into pin TB3-1 and tighten the screw.
 - b. Insert the 4-wire cable 24 VDC return (black) lead into pin TB3-2 and tighten the screw.
4. Connect the analog output leads:
 - a. Insert the 4-wire cable + 4-20 mA (white) lead into pin TB3-3 and tighten the screw.
 - b. Insert the 4-wire cable - 4-20 mA (green) lead into pin TB3-4 and tighten the screw.
 5. Plug the EMI board back into its socket and secure it with the standoff. Terminate the ground lug of the cable to the standoff and secure it with the provided screw.
 6. If you are installing the second cable entry device, do so in accordance with the manufacturer's instructions.

NOTE: If installation of the cable entry device is only partially complete, Panametrics recommends tagging the device to ensure the safety of subsequent users.

- a. Remove the tab "remove before installation".
- b. Thread the cable gland entry body into the remaining XMTC port.
- c. Route the 3-wire RS232 cable & its ground lug through the cable gland.
- d. Fray the braided shield and spread evenly around the cone as shown in *Figure 90* on page 64. Compress the ring to lock the shield.
- e. After terminating the shield as shown, assemble the gland pieces together and tighten the gland to secure the cable and the shield.

IMPORTANT:

The cable shield must be terminated in the cable gland as shown in *Figure 90* on page 64.

7. Unplug the TB2 connector by pulling it straight out of its socket, and loosen the terminal screws on the TB2 connector.
8. Connect the RS232 serial port leads:
 - a. Insert the 3-wire cable RX (red) lead into pin TB2-1 and tighten the screw.
 - b. Insert the 3-wire cable TX (white) lead into pin TB2-2 and tighten the screw.
 - c. Insert the 3-wire cable GND (green) lead into pin TB2-3 and tighten the screw.
9. Carefully plug the TB2 connector back into its sockets. Terminate the ground lug to the nearest standoff.
10. Reinstall the cover on the XMTC.
11. Connect the other ends of the cables to the 24 VDC power supply, the 4-20 mA input of the display device, and the serial port of the computer or terminal (see the instruction manuals for those devices for details).

Warranty

Each instrument manufactured by Panametrics is warranted to be free from defects in material and workmanship. Liability under this warranty is limited to restoring the instrument to normal operation or replacing the instrument, at the sole discretion of Panametrics. Fuses and batteries are specifically excluded from any liability. This warranty is effective from the date of delivery to the original purchaser. If Panametrics determines that the equipment was defective, the warranty period is:

- one year from delivery for electronic or mechanical failures
- one year from delivery for sensor shelf life

If Panametrics determines that the equipment was damaged by misuse, improper installation, the use of unauthorized replacement parts, or operating conditions outside the guidelines specified by Panametrics, the repairs are not covered under this warranty.

The warranties set forth herein are exclusive and are in lieu of all other warranties whether statutory, express or implied (including warranties or merchantability and fitness for a particular purpose, and warranties arising from course of dealing or usage or trade).

Return policy

If a Panametrics instrument malfunctions within the warranty period, the following procedure must be completed:

1. Notify Panametrics, giving full details of the problem, and provide the model number and serial number of the instrument. If the nature of the problem indicates the need for factory service, Panametrics will issue a RETURN AUTHORIZATION NUMBER (RAN), and shipping instructions for the return of the instrument to a service center will be provided.
2. If Panametrics instructs you to send your instrument to a service center, it must be shipped prepaid to the authorized repair station indicated in the shipping instructions.
3. Upon receipt, Panametrics will evaluate the instrument to determine the cause of the malfunction.

Then, one of the following courses of action will then be taken:

- If the damage is covered under the terms of the warranty, the instrument will be repaired at no cost to the owner and returned.
- If Panametrics determines that the damage is not covered under the terms of the warranty, or if the warranty has expired, an estimate for the cost of the repairs at standard rates will be provided. Upon receipt of the owner's approval to proceed, the instrument will be repaired and returned.

Special conditions for safe use

- Consult the manufacturer if dimensional information on the flameproof joints is necessary.

Markings

- Markings shall appear on the product as shown below.

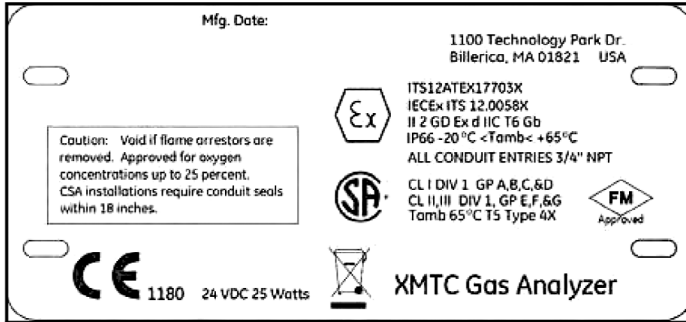

Customer support centers

Americas

U.S.A.

The Boston Center
1100 Technology Park Drive
Billerica, MA 01821

U.S.A.

Tel: +1 800 833 9438 (toll-free)

Tel: +1 978 437 1000

E-mail: mstechsupport@bhge.com

Europe

Ireland

Sensing House
Shannon Free Zone East
Shannon, County Clare
Ireland

Tel: +353 61 61470200

E-mail: mstechsupport@bhge.com

Panametrics, a Baker Hughes Business, provides solutions in the toughest applications and environments for moisture, oxygen, liquid and gas flow measurement. Experts in flare management, Panametrics technology also reduces flare emissions and optimizes performance.

With a reach that extends across the globe, Panametrics' critical measurement solutions and flare emissions management are enabling customers to drive efficiency and achieve carbon reduction targets across critical industries including: Oil & Gas; Energy; Healthcare; Water and Wastewater; Chemical Processing; Food & Beverage and many others.

Join the conversation and follow us on LinkedIn
[linkedin.com/company/panametricscompany](https://www.linkedin.com/company/panametricscompany)