

---

# User's Manual

IM XL100P-E

**XL100**  
**Portable Data Station**

**Quick Setup Manual**

---

---

# Introduction

Thank you for purchasing our XL100 Portable Data Station.

This Quick Setup Manual briefly describes the key operations as well as setting examples of the XL100 upon actual measurement, so that you can operate the XL100 for the first time.

In addition to this manual, the User's Manual and Communication Function Manual contained in the CD-ROM are available separately. The User's Manual provides detailed information regarding all of the functions and operations of the XL100 excluding the communication functions. The Communication Function Manual provides information necessary for using communication functions and creating communication programs. Use them together with this Quick Setup Manual.

After reading this manual, keep it in an easily accessible place for later reference. This manual will come in handy when you are unsure of how to operate the product.

## Notes

- The contents of this manual are subject to change without prior notice.
- Figures and illustrations representing display views in this manual may differ from actual views.
- Every effort has been made to ensure accuracy in the preparation of this manual. However, should any doubts arise or errors come to your attention, please contact the vendor from which you purchased the product.
- The contents of this manual may not be transcribed or reproduced, in part or in their entirety, without prior permission.

## Trademarks

The company and product names referred to in this document are either trademarks or registered trademarks of their respective holders.

## Revisions

First Edition: October, 2005

---

# Safety Precautions

When operating the instrument, be sure to observe the cautionary notes given in “Safety Precautions” on pages 4 and 5 and section 3.1, “Handling Precautions” in the User’s Manual. If you use the instrument in any way other than as instructed, the instrument’s protective measures may be impaired.

The following safety symbols are used on the instrument and in this manual.



## **WARNING**

---

---

**Indicates a hazard that may result in the loss of life or serious injury of the user unless the described instruction is abided by.**

---

---



## **CAUTION**

---

---

**Indicates a hazard that may result in an injury to the user and/or physical damage to the product or other equipment unless the described instruction is abided by.**

---

---



## **Note**

---

---

**Indicates information that is essential for handling the instrument or should be noted in order to familiarize yourself with the instrument’s operating procedures and/or functions.**

---

---

## **TIP**

---

---

Indicates information that complements the present topic.

---

---

---

# Contents

Introduction .....	1
Safety Precautions .....	2
1. Checking the Contents of the Package .....	4
2. Flow of Operation .....	5
3. Names and Functions of Parts .....	6
4. How to View the Display .....	9
5. Introduction of the Main Functions .....	14
Input Type and Calculation .....	14
Alarm Function .....	15
Saving Data .....	16
Triggers .....	17
File Operations .....	17
Communication Function .....	18
6. Operation Mode and Basic Key Operations .....	20
Operation Modes and Switching the Operation Mode .....	20
Switching the Display in Free Running Mode or Logging Mode .....	21
Switching the menu in Setting Mode .....	21
Key Operations for Entering Characters .....	22
Key Operations for Entering Values .....	22
7. Signal Wiring .....	23
8. Connecting to the Power Supply and Turning the Power Switch ON/OFF .....	25
Connecting the Power Supply .....	25
Turning the Power Switch ON/OFF .....	26
9. Setting the Input Channel .....	27
10. Setting the Data Save Operation .....	31
11. Confirming the Settings and Performing the Measurement .....	36
12. Inserting an External Storage Medium and Saving Data ..	37
Inserting an External Storage Medium .....	37
Starting the Data Save Operation .....	38
Stopping the Data Save Operation .....	38
13. Analyzing the Saved Data .....	39
Loading the Saved Data File .....	39
Loading the Measured Data .....	41
Displaying Statistical Calculation Values .....	41
14. Troubleshooting .....	42
Index .....	43

# 1. Checking the Contents of the Package

Unpack the box and check the contents before operating the instrument. Should the product you have received be the wrong model, lack any items, or show any problems in its appearance, contact the vendor from whom you purchased the product.

## Instrument Main Unit

Check the model and suffix code printed on the nameplate on the rear panel to ensure that the XL100 is exactly as specified in your purchase order.

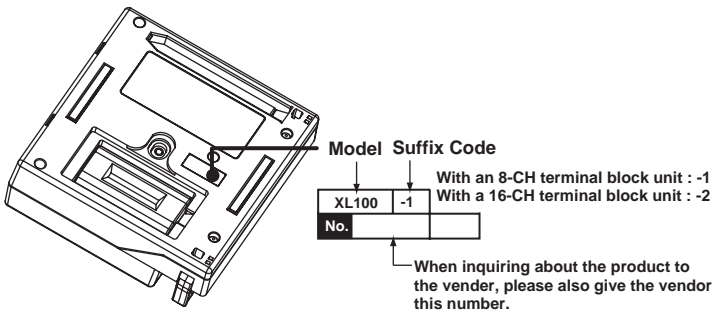

## Accessories

Make sure that the package contains all the accessories listed below and that they are all free from any damage.

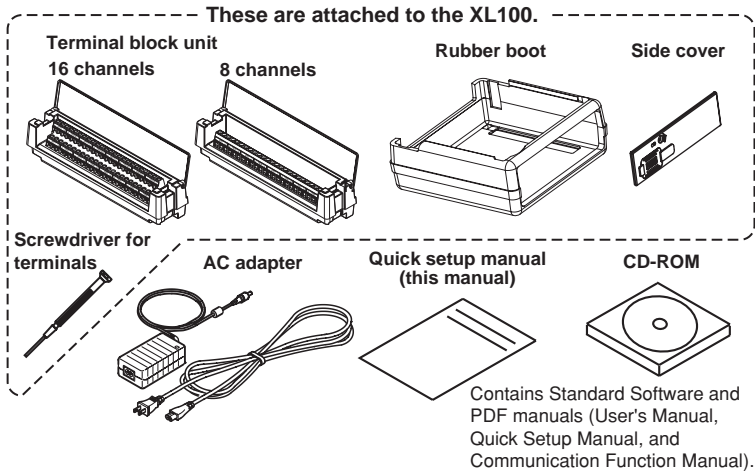

### TIP

For details on peripherals and spare parts, see page 3 in the User's Manual.

## 2. Flow of Operation

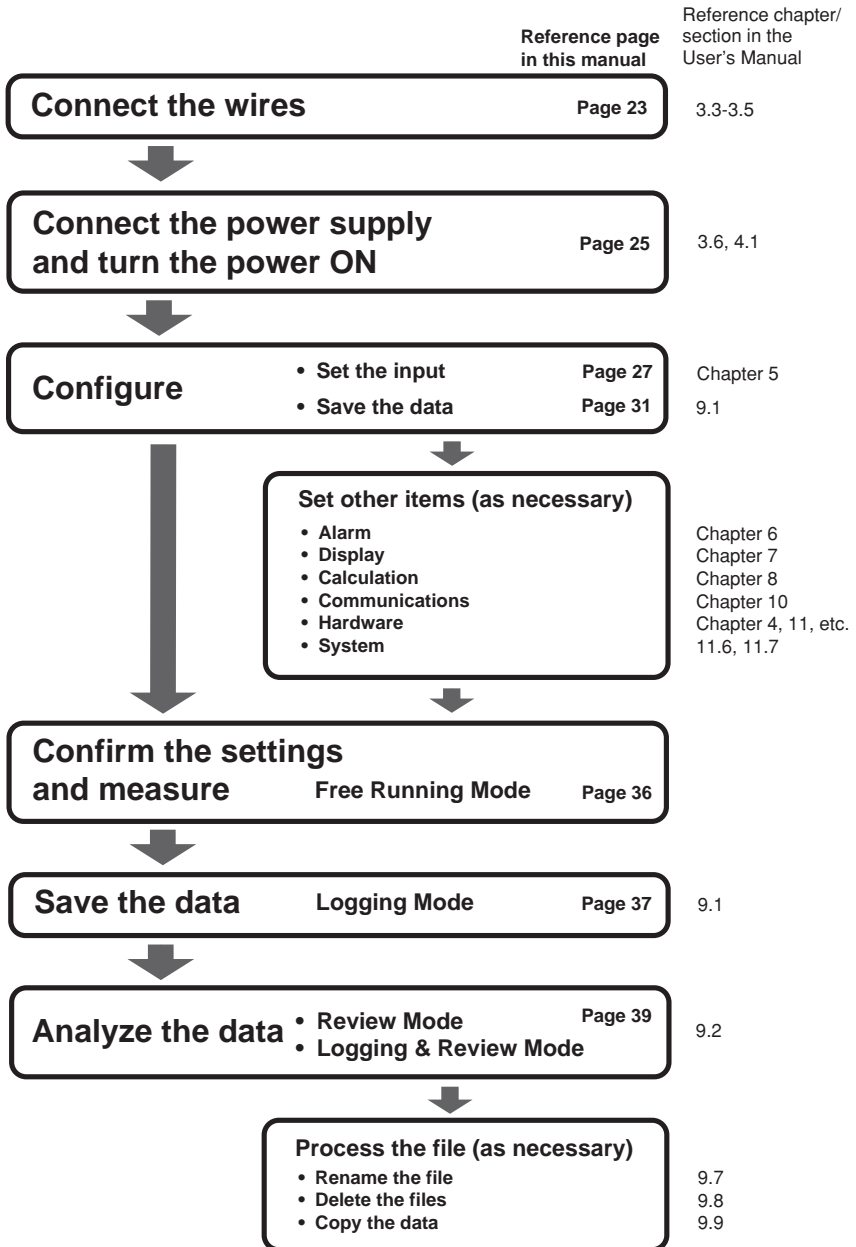

# 3. Names and Functions of Parts

## Front Panel

### Terminal block unit

Terminal block unit where probes are connected.

For the wiring procedure, see page 23.

### Display

Displays measured data, operation status, setup menu, settings, etc.

For the viewing the displays, see page 9.

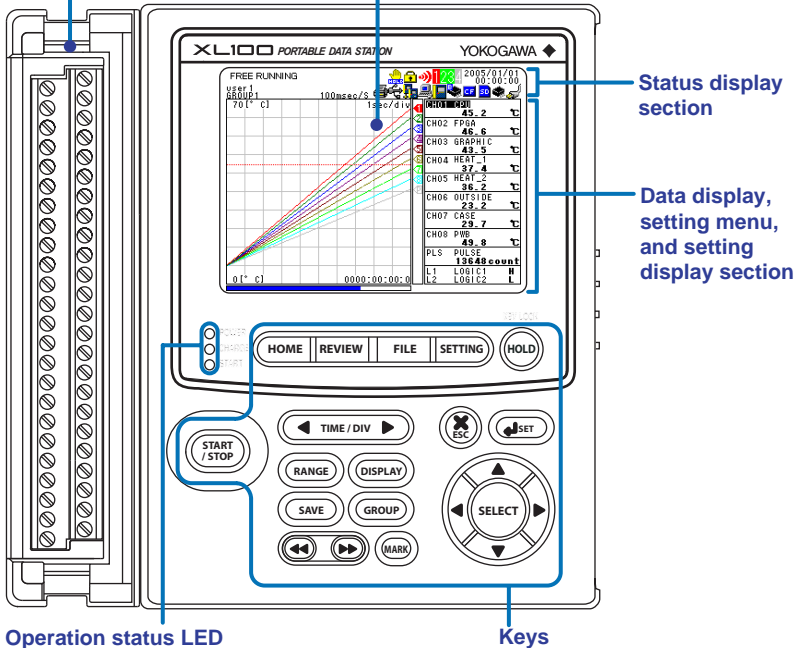

### Operation status LED

- POWER : Illuminates when the power is ON
- CHARGE : Illuminates when the battery is being charged
- START : Illuminates while logging

### Keys

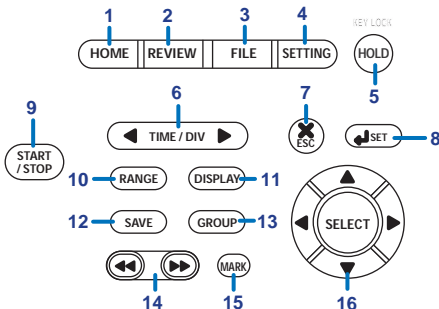

**1. HOME Key**

Press this key to enable Free Running Mode for measuring instantaneous values (see page 20).

**2. REVIEW Key**

Press this key to enable Logging & Review Mode in which past measured data can be viewed while logging (see page 20) or enable Review Mode in which saved data can be analyzed (see page 20).

**3. FILE Key**

Press this key to enable File Operation mode in which file names can be changed, measured data can be copied, setting data can be saved or loaded, and so on (see page 20).

**4. SETTING Key**

Press this key to set measurement conditions, conditions for saving measured data, alarm conditions, etc.

**5. HOLD Key**

Press this key to hold the display so that the measured values are not updated or to release the display. In addition, hold this key down to enable or disable key lock.

**6. TIME/DIV Key**

Press this key to switch the time axis (the time per grid (division)).

**7. ESC Key**

Press this key to cancel a key operation.

**8. SET Key**

Press this key to set settings entered through the keys.

**9. START/STOP Key**

Press this key to start/stop logging.

**10. RANGE Key**

Press this key to change the input range or span (scale).

**11. DISPLAY Key**

Press this key to switch the display in Free Running Mode or Logging Mode (see page 21). Press this key also to switch between marker display and statistical calculation display in Review Mode.

**12. SAVE Key**

Press this key to manually save or print the measured data or screen data.

**13. GROUP Key**

Press this key to switch the displayed group of measurement, calculation, and communication input channels.

**14. Fast Forward Key**

Press this key to move the marker to the left or right by 1 division on the review display (see page 41).

**15. MARK Key**

Press this key to select a marker to be activated on the review display (see page 41).

**16. Arrow/SELECT Key**

Press the arrow keys to select items on the display. Press this key also to move the marker to the left or right on the review display (see page 41).

Press the SELECT key to confirm a selection.



### 3. Names and Functions of Parts

#### Side Panel

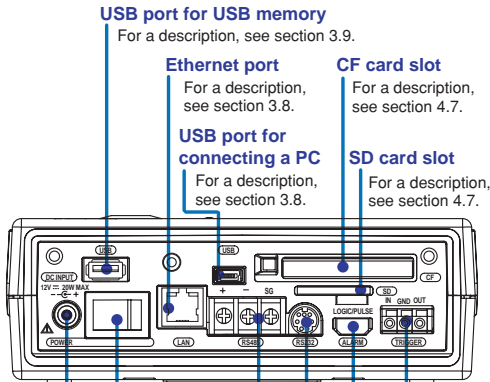

**USB port for USB memory**  
For a description, see section 3.9.

**Ethernet port**  
For a description, see section 3.8.

**USB port for connecting a PC**  
For a description, see section 3.8.

**CF card slot**  
For a description, see section 4.7.

**SD card slot**  
For a description, see section 4.7.

The reference sections are those of the User's Manual.

For details on how to insert the CF card or SD card, see page 37.

The side cover comes attached when the XL100 is shipped from the factory. You can remove the side cover by loosening the attachment screw at the center of the cover.

**Power switch**  
For a description, see section 4.1.

**AC adapter jack**  
For a description, see section 3.6.

For details on connecting the power supply and turning the power ON/OFF, see pages 25 and 26.

**Trigger input/output terminal**  
For a description, see section 3.5.

**Digital I/O connector**  
For a description, see section 3.4.

**RS-232 connector**  
For a description, see section 3.8.

**RS-485 connector**  
For a description, see section 3.8.

#### Rear Panel

**Screwdriver for terminals (accessory)**  
Press the screwdriver towards the spring (right in this figure) to detach it.

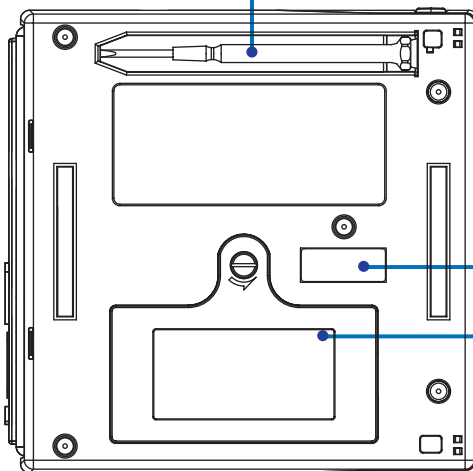

**Name plate**

**Battery cover**  
Holds the lithium ion battery (94009) sold separately .

## 4. How to View the Display

### Status Display Section

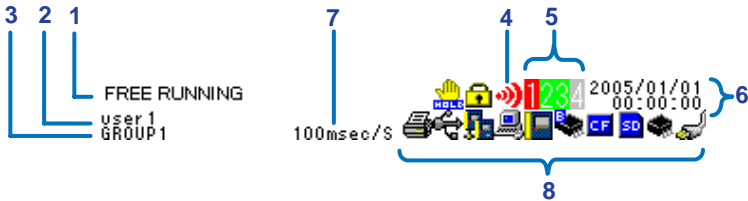

#### 1. Operation Mode

Displays the mode name, free running, logging, logging & review, setup, or file operation.

#### 2. User name

Displays the login user name when the key login function (see section 11.7 in the User's Manual) is turned ON.

#### 3. Group Name (For the procedure to set groups, see section 7.2 in the User's Manual)

Displays the group name of the displayed measurement channel.

#### 4. Alarm Status (For a description of the alarm function, see page 15)

The status is displayed using different icon colors as follows:

Gray:	No alarm setting
Yellow-green:	Alarm setting enabled
Red:	Alarm activated

#### 5. Alarm Output Status

The status is displayed using different icon colors for each alarm output channel (1 to 4) as follows:

Gray:	No alarm setting
Yellow-green:	Alarm setting enabled
Red:	Alarm outputting

#### 6. Date/Time (For the procedure to set the date/time, see section 4.3 in the User's Manual)

Displays the year, month, day, hour, minute, and second.

#### 7. Sampling Interval

Displays the sampling interval (measurement/save interval of measured data) when in Free Running, Logging, or Logging & Review Mode.

#### 8. Various Icons

The following icons are used to display the operation status, interface usage status, etc.



An icon shown when the data save destination is set to internal memory. The icon blinks while the internal memory is being accessed. The icon is gray when it is not set to be the data save destination.

## 4. How to View the Display

---



An icon shown when the data save destination is set to CF card. The icon blinks while the CF card is being accessed. The icon is gray when it is not set to be the data save destination.



An icon shown when the data save destination is set to SD card. The icon blinks while the SD card is being accessed. The icon is gray when it is not set to be the data save destination.



An icon shown when there is data saved in the backup memory. The icon blinks while the memory is being accessed. The icon is gray when there is no data saved to the backup memory.



An icon shown when the interface is set to LAN, the IP address is set to a value other than 0.0.0.0, and the cable is connected. Otherwise, the icon is gray.



An icon shown when the interface is set to USB and a USB device is connected. Otherwise, the icon is gray.



An icon shown when the communication protocol is set to Modbus (slave). The icon is gray when set to Modbus (master).



An icon shown when the communication protocol is set to Modbus (master). The icon is gray when set to Modbus (slave).



An icon shown when the printer output is turned ON and the sampling interval is greater than or equal to 1 minute. The icon is gray when set to OFF.



An icon shown when the printer output is turned ON and the sampling interval is less than or equal to 30 seconds. This indicates that only manual print is valid using the SAVE key.



An icon shown when the display update is held. The icon is gray when it is not held.







An icon shown when key lock is enabled. The icon is gray when key lock is disabled.



An icon shown when the AC adapter is connected.



An icon shown when the AC adapter is not connected, and the XL100 is running on a battery (sold separately). Shows the battery, remaining battery power using four levels (  →  →  →  ).

## Data Display Section

### Waveform & Digital Display

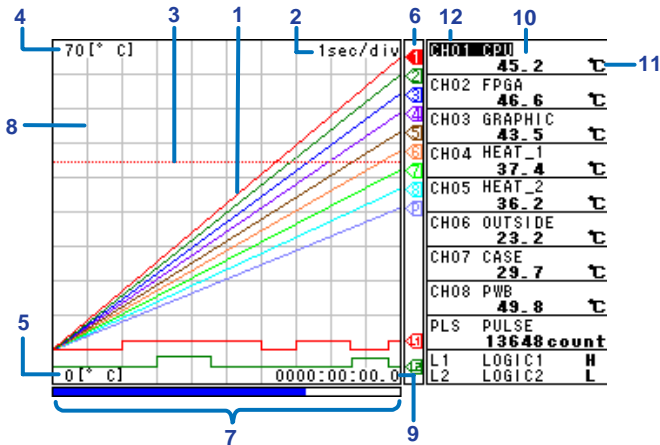

#### 1. Waveform

Waveforms of measured data, calculated data, and communication input data.

Waveforms of logic input are shown at the lower section of the screen as shown in the figure above.

#### 2. Time Axis

Displays the time axis (time per grid (division)) specified by the TIME/DIV key.

#### 3. Alarm Line

Displayed with a red dotted line at the position of the alarm value of the selected channel (active channel).

#### 4. Scale Upper Limit

Shows the display upper limit of the active channel.

#### 5. Scale Lower Limit

Shows the display lower limit of the active channel.

#### 6. Pen

Displayed at the current value position of each channel. The active channel is shown highlighted in reverse video.

#### 7. Usage Indication Bar of the Storage Media

Displays using a blue bar the amount of space used with respect to the total space on the storage medium that is specified to be the save destination of the measured data.

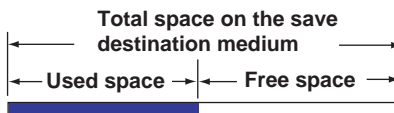

#### 8. Grid

The grid can be turned ON/OFF.

## 4. How to View the Display

### 9. Elapsed Time

Displays the elapsed time from the start of the logging operation.

### 10. Digital Display

Displays the current values of the measured data, calculated data, and communication input data using numeric values. When an alarm is occurring, the value is shown in red in reverse video.

### 11. Unit

Displays preset characters such as °C or an arbitrary specified characters (up to 6 characters).

### 12. Channel No./Tag

Displays the channel number or the specified tag (up to 8 characters). The active channel is shown highlighted (reverse video).

## Other Data Displays

In addition to the waveform & digital display, other displays are available including the waveform display that does not show numeric values. For a description of the data displays below, see section 2.3, "Data Display" in the User's Manual.

- Digital Display

Displays the numeric values of the instantaneous values and statistical calculation values.

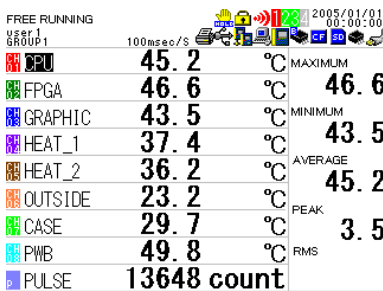

- Bar Graph Display

Displays a bar graph in place of a waveform.

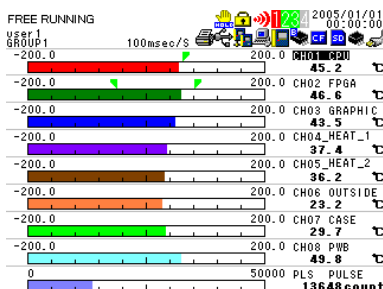

## 4. How to View the Display

- Review Display

Displays the waveforms of data saved in the past.

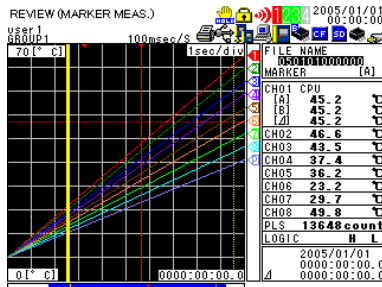

- Logging & Review Display

Displays both the waveforms of data currently being logged and the waveforms of data saved in the past.

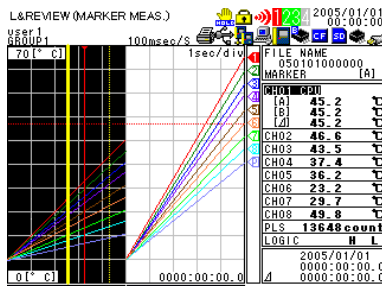

- Alarm Summary Display

Displays the alarm status in a list.

ALARM SUMMARY					
002/120	Channel No	Type	Alarm ON	Alarm OFF	
●	1	1	H	01/01 00:00:00.0	
●	1	1	H	01/01 00:00:00.0	
●	1	1	H	01/01 00:00:00.0	
●	1	1	H	01/01 00:00:00.0	01/01 00:00:00.0
●	1	1	H	01/01 00:00:00.0	01/01 00:00:00.0
●	1	1	H	01/01 00:00:00.0	01/01 00:00:00.0
●	1	1	H	01/01 00:00:00.0	01/01 00:00:00.0

- Log Display

Displays the log data of error messages and communications.

ERROR LOG			
06/06	Date	Error No	Message
	2005/01/01 00:00:00	210	Media is not inserted
	2005/01/01 00:10:00	210	Media is not inserted
	2005/01/01 00:20:00	210	Media is not inserted
	2005/01/01 00:30:00	210	Media is not inserted
	2005/01/01 00:40:00	210	Media is not inserted
	2005/01/01 00:50:00	210	Media is not inserted

# 5. Introduction of the Main Functions

## Input Type and Calculation

As shown in the table below, the available input types are analog input, which includes DC voltage, thermocouple, and RTD, and other inputs, which consist of pulse signal (1 channel) and logic signals (2 channels).

In addition, the difference between two inputs can be calculated and assigned to a calculation channel and displayed in the same fashion as measured values.

The statistics of measured values can also be displayed.

For details on the input settings, see chapter 5, "Setting the Input Channels."

For details on calculation, see chapter 8, "Setting the Calculation of Measured Data."

Input/Calculation	Description
DC voltage	Measures a DC voltage in the range of $\pm 100$ mV to $\pm 30$ V.
Thermocouple	Selectable from the following types: R, S, B, K, E, J, T, N, W, L, and U.
RTD	Selectable from Pt100 and JPt100 types.
Pulse signal	Displays the pulse input as number of revolutions, integrated value, or instantaneous value.
Logic signal	Displays the logic waveform at the lower section of the display by taking input voltage less than or equal to 0.9 V to be OFF (0) and input voltage greater than or equal to 2.1 V to be ON (1).
Differential Calculation	When the input type is set to DC voltage, thermocouple, RTD, or pulse input, the value obtained by subtracting the measured value of another channel from the input signal of the channel set to calculate the difference is displayed as the measured value of that channel (calculation channel).
Statistical Calculation	Calculates and displays the maximum, minimum, average, peak (P-P), or rms value of the measured value.

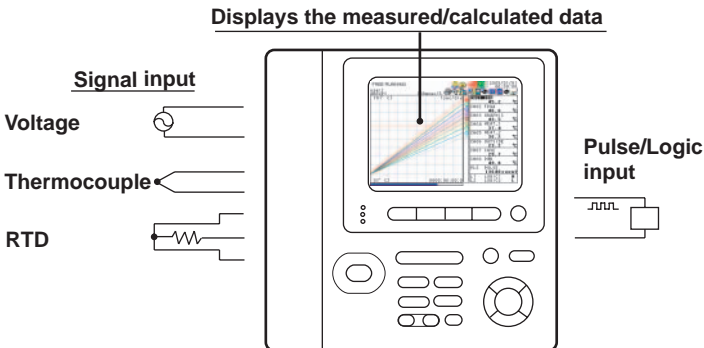

## Alarm Function

Generates an alarm when the measured/calculated value meets a certain condition. When an alarm occurs, information notifying the alarm occurrence is displayed on the screen. In addition, an alarm signal can be delivered from the output terminal (digital I/O connector) on the rear panel of the XL100. You can select the alarm conditions from the following table.

For details on the settings, see chapter 6, “Setting Alarms” in the User’s Manual.

Input Type	Setting	Alarm Condition
Level or Pulse	OFF	Not set alarm conditions.
	Hi	An alarm occurs when the measured/calculated value is greater than or equal to the alarm value.
	Lo	An alarm occurs when the measured/calculated value is less than or equal to the alarm value.
	Window IN	An alarm occurs when the measured/calculated value is within the lower limits and upper limits of the alarm range.
	Window OUT	An alarm occurs when the measured/calculated value is outside the lower limits and upper limits of the alarm range.
Logic	X	Not set alarm conditions.
	Hi	An alarm occurs when the logic input changes from low to high.
	Lo	An alarm occurs when the logic input changes from high to low.

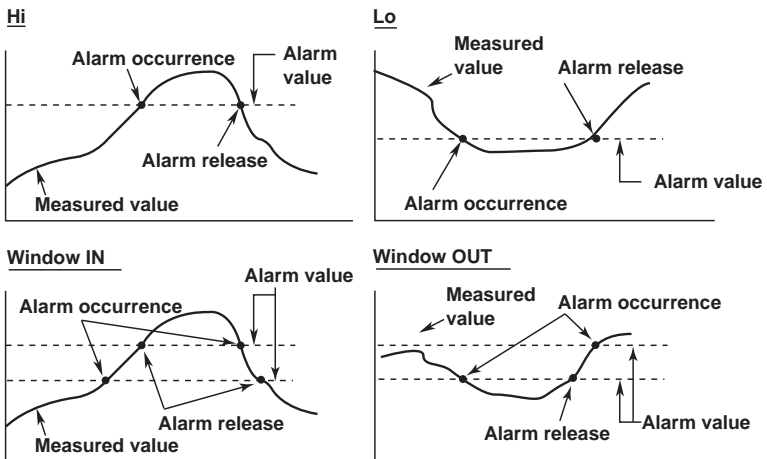



## 5. Introduction of the Main Functions

### Saving Data

Measured data, calculated data, setting data, and so forth can be saved to the XL100 internal memory or an external storage medium (CF card or SD card) that is inserted in the XL100.

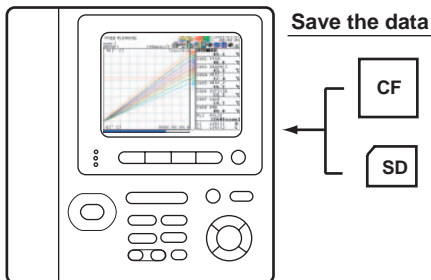

#### TIP

The XL100 is equipped with a USB port for USB memories. However, data cannot be saved directly to a USB memory (see section 3.9 in the User's Manual).

The types of data that can be saved are as follows:

Type	Description
Logging data	The instantaneous values of the measured/calculated data can be saved at a specified sampling interval. The data save operation is started or stopped with the START/STOP key. The save operation can also be started or stopped when a specific event (see "Trigger" on the next page) occurs. The logging data contains alarm information.
Manual Sampled Data	The measured/calculated data (instantaneous values) of all channels can be saved by pressing the SAVE key in free running mode.
Alarm Data	The same information as the alarm summary display can be saved by pressing the SAVE key during alarm summary display.
Screen Image Data	The image data of the screen being displayed can be saved by pressing the SAVE key in free running mode, etc.
Setting data	The setting data of the XL100 can be saved in file operation mode.
Log data	The same information as the log display can be saved by pressing the SAVE key during log data display.
Backup file	If the data save operation is not carried out normally to the internal memory or external storage medium (CF card or SD card), the data is saved to the backup memory of the XL100. The saved data can be copied to an external storage medium.

### Triggers

In addition to using the START/STOP key to start or stop the logging, a trigger for starting (or stopping) the save operation of the logging data (measured/calculated data) can be configured for automatic operation. The trigger for logging can be selected from the list below and configured. If multiple trigger conditions are selected, the data save operation starts (or stops) when any of the trigger conditions is met.

Type	Description								
None	Not set trigger conditions.								
External	A trigger is activated when a signal is applied to the external trigger input terminal.								
Level	<table style="width: 100%; border-collapse: collapse;"> <tr> <td style="width: 150px;">High limit (H)</td> <td>A trigger is activated when the measured value is greater than or equal to the specified value.</td> </tr> <tr> <td>Low limit (L)</td> <td>A trigger is activated when the measured value is less than or equal to the specified value.</td> </tr> <tr> <td>Window IN</td> <td>A trigger is activated when the measured value is within the specified lower and high limits.</td> </tr> <tr> <td>Window OUT</td> <td>A trigger is activated when the measured value is outside the specified lower and high limits.</td> </tr> </table>	High limit (H)	A trigger is activated when the measured value is greater than or equal to the specified value.	Low limit (L)	A trigger is activated when the measured value is less than or equal to the specified value.	Window IN	A trigger is activated when the measured value is within the specified lower and high limits.	Window OUT	A trigger is activated when the measured value is outside the specified lower and high limits.
High limit (H)	A trigger is activated when the measured value is greater than or equal to the specified value.								
Low limit (L)	A trigger is activated when the measured value is less than or equal to the specified value.								
Window IN	A trigger is activated when the measured value is within the specified lower and high limits.								
Window OUT	A trigger is activated when the measured value is outside the specified lower and high limits.								
Alarm	A trigger is activated when any of the alarms occur.								
Time	A trigger is activated at the specified time.								
Timer	The time at which the data save operation is stopped can be specified. Logging is stopped after the specified time elapses.								

### File Operations

The following file operations are available.

Operation Type	Description
Rename	Renames files saved on a external storage medium (CF card or SD card) or internal memory.
Save setting data	Saves setting data to an external storage medium (CF card or SD card) or internal memory.
Load setting data	Loads the setting data saved on a external storage medium (CF card or SD card) or internal memory and changes the settings.
Copy data	Copies the files saved to the internal memory to an external storage medium (CF card, SD card, or USB memory).
Copy backup memory	Copies the files saved to the backup memory (memory to which data is saved when data cannot be saved to an external storage medium or internal memory) to an external storage medium (CF card, SD card).
Format	Formats an external storage medium (CF card or SD card) or the internal memory.

## 5. Introduction of the Main Functions

---

### Communication Function

#### FTP Client/Server

The Ethernet interface can be used to automatically transfer measurement data files to an FTP server connected to the network or access the XL100 from a PC through FTP to retrieve data on the external storage medium of the XL100.

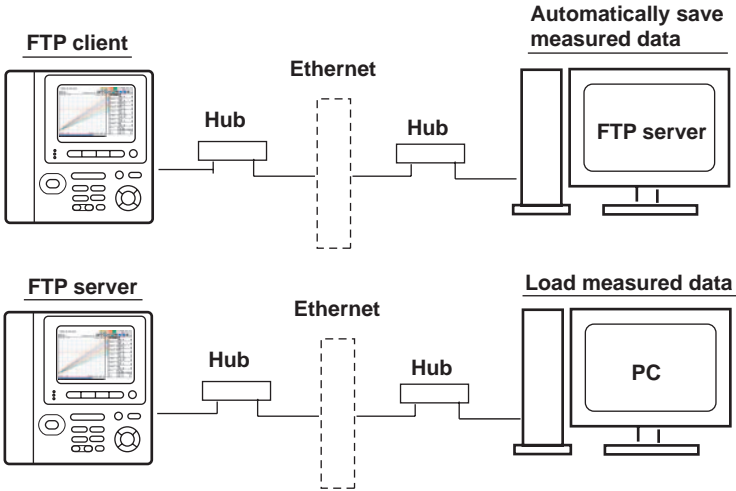

#### Web Server

By configuring the XL100 to be a Web server, the XL100 screen can be shown on the PC. You can monitor the measured data and switch the display from the PC.

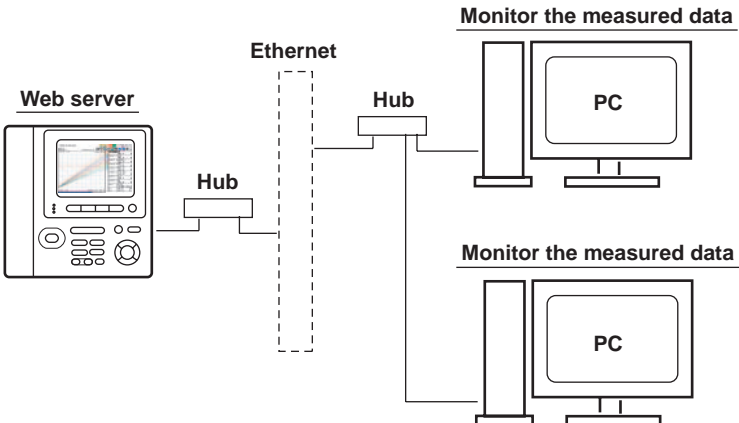

## 5. Introduction of the Main Functions

### E-mail transmission

An e-mail can be sent automatically from the XL100 when an alarm occurs.

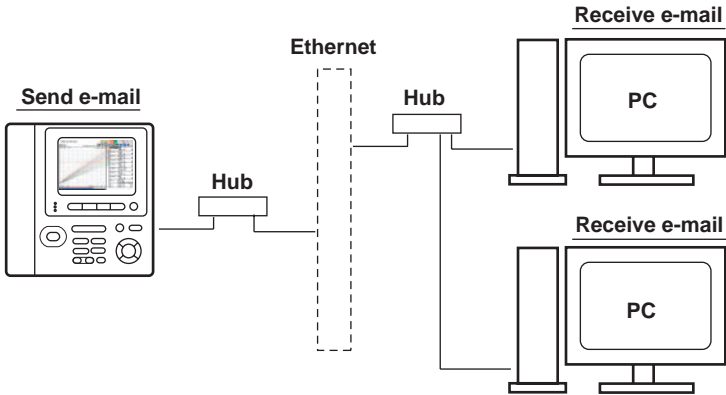

### Serial Communication

The USB interface or serial interface can be used to change the XL100 settings from a PC or retrieve data into the PC through command communication. In addition, Modbus communication is possible on the serial interface. The Modbus master function enables the measured data of a measuring instrument connected as a Modbus slave to be retrieved as communication input data. The data can be assigned to a communication channel and displayed on the XL100 in a similar fashion to measurement and calculation channels.

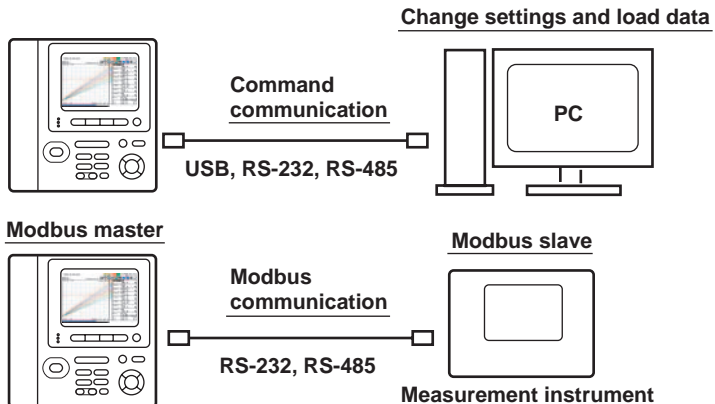

For details on the communication functions, see the Communication Function Manual (contained in the CD-ROM).

# 6. Operation Mode and Basic Key Operations

## Operation Modes and Switching the Operation Mode

As shown in the figure below, the XL100 has six operation modes: (1) Free Running Mode in which instantaneous values are measured, (2) Logging Mode in which continuous measurement is performed while saving data, (3) Logging & Review Mode in which past measured data can be viewed while the logging operation is in progress, (4) Review Mode in which saved data is analyzed, (5) File Operation Mode in which file operations such as saving and loading of the setup data is performed, and (6) Setting Mode in which various settings such as the measurement conditions are specified. The keys in the figure below are used to switch between these modes.

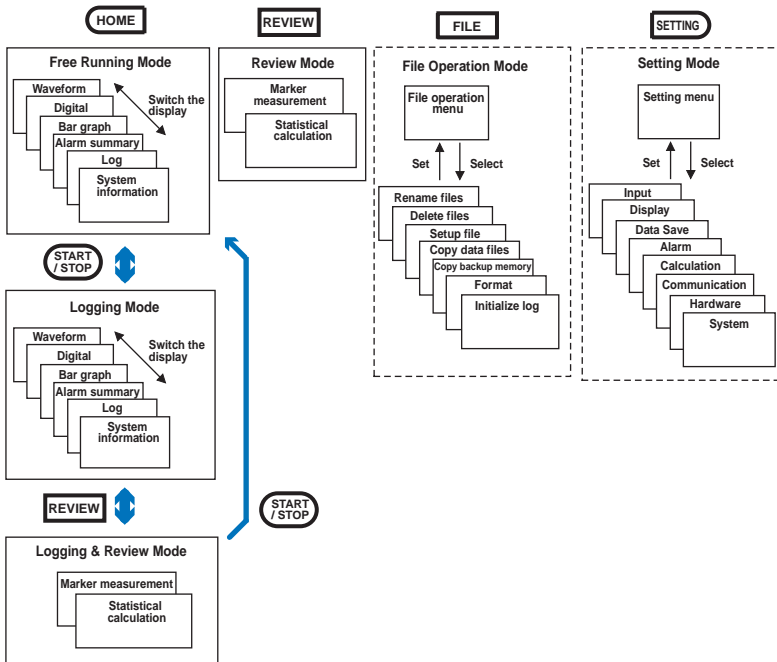

## 6. Operation Mode and Basic Key Operations

### Switching the Display in Free Running Mode or Logging Mode

To switch to a display other than waveform & digital display, press **DISPLAY** to show the display switch pop-up menu, select the display using the **arrow keys**, and press **SELECT**.

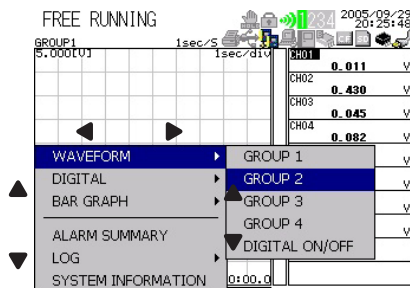
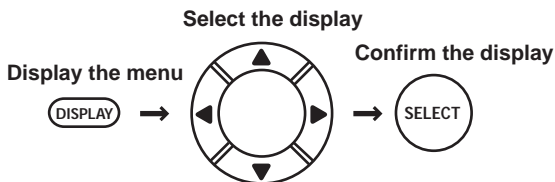

### Switching the menu in Setting Mode

Press the **arrow keys** to select the desired item, and press **SELECT**. A selection list, a setting window, or a setting menu that is one level lower is displayed. To return to the original setting menu, press **ESC**.

Select the setup item

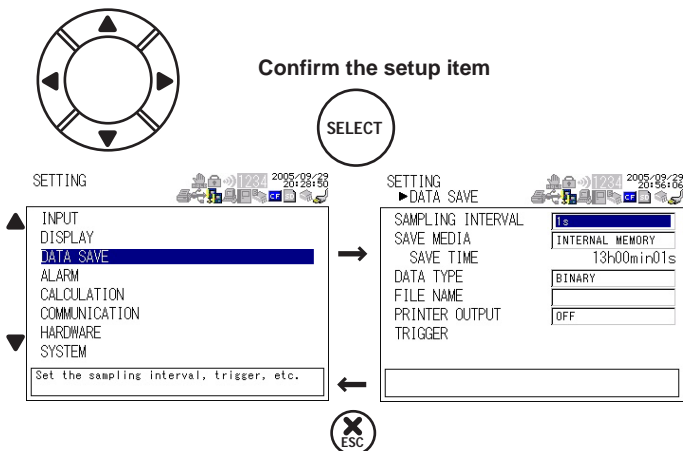

## 6. Operation Mode and Basic Key Operations

### Key Operations for Entering Characters

For settings that require characters to be entered, a character entry window opens as shown below.

To enter a character, press the **arrow keys** to move the cursor in the character selection area, select the character, and press **SELECT**. To set the entered value, press **SET**.

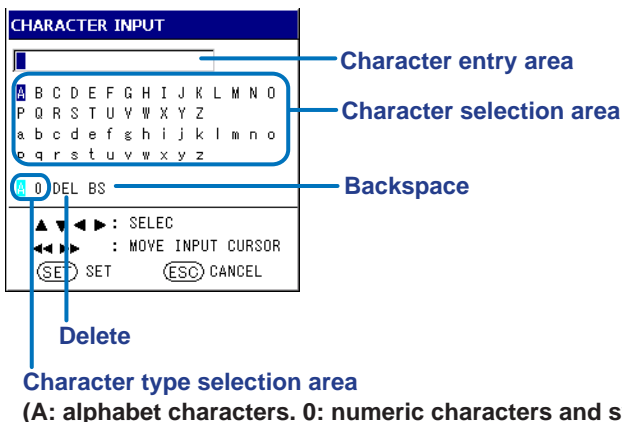

### Key Operations for Entering Values

For settings that require a value to be entered, a value entry window opens as shown below. Press the **up and down arrow keys** to increment or decrement the value and the **left and right arrow keys** to move along the digits. To set the entered value, press **SET**.

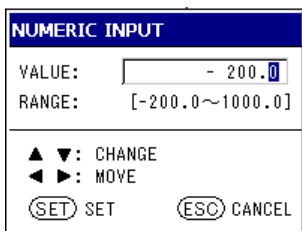

---

## 7. Signal Wiring

### Signal Input Wiring

Be sure to also read the precautions in section 3.3, “Wiring the Input Signal Cable” in the User’s Manual when wiring cables.

#### CAUTION

---

Do not apply an input exceeding the following values. Otherwise, the XL100 may break down.

- Maximum input voltage  
±30 VDC
  - Maximum common mode noise voltage  
30 VACrms (50/60 Hz)
- 

#### Wiring Procedure

1. Open the terminal cover of the terminal block unit.
2. Wire the input signal cables to the input terminals.  
As shown below, loosen the terminal screws using the screwdriver provided, insert the signal wires, and fasten the terminal screws.
3. Close the terminal cover of the terminal block unit.

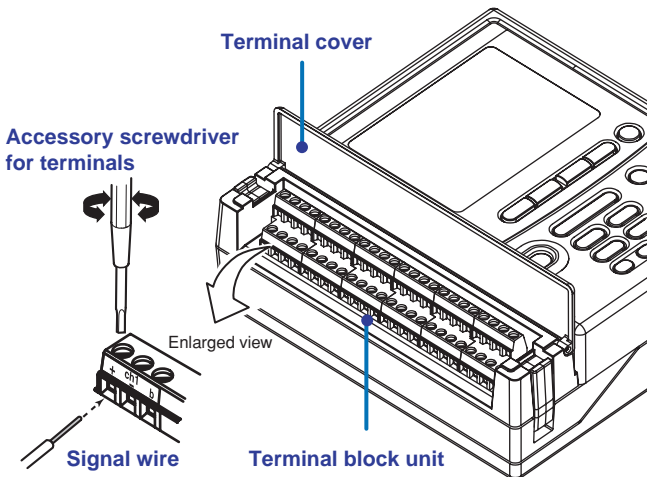

#### TIP

---

The terminal block unit can be removed. For the procedure to remove the terminal block unit, see section 3.3, “Wiring the Input Signal Cable” in the User’s Manual.

---



## 7. Signal Wiring

### Wiring Diagram

Connect the wires according to the figure below.

#### DC voltage input

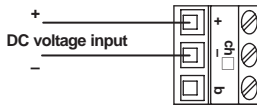

#### TC input

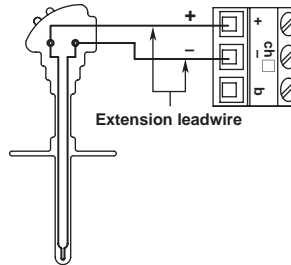

#### RTD input

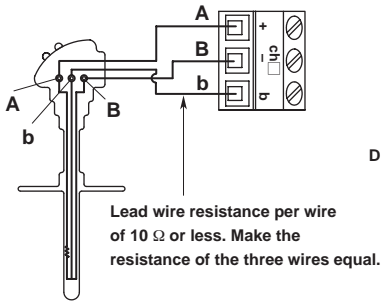

#### DC current input

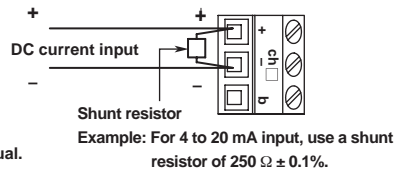

### Note

- Use wires of the following specifications.
  - Conductive cross-sectional area for single wire:  $0.14\ \text{mm}^2$  to  $2.5\ \text{mm}^2$ , stranded wire:  $0.14\ \text{mm}^2$  to  $1.5\ \text{mm}^2$   
AWG: 26 to 14
  - Length of the stripped section of the wire: Approx. 7 mm
- Input signal wires whose diameter is 0.3 mm or less may not be securely fastened. Fold over the conducting section of the wire, for example, to make sure that the wire is securely fastened to the clamped terminal.
- RTD input terminals A (+) and B (-) are isolated on each channel. Terminal b is shorted internally across all channels.

### Other Wiring

- For a description of the pulse input, logic input, and alarm output wiring, see section 3.4, “Wiring the Pulse Input, Logic Input, and Signal Cables” in the User’s Manual.
- For a description of the external trigger input/output wiring, see section 3.5, “Wiring the External Trigger I/O Signal Cables” in the User’s Manual.

## 8. Connecting to the Power Supply and Turning the Power Switch ON/OFF

### Connecting the Power Supply

Be sure to also read the precautions in section 3.6, “Connecting the Power Supply” in the User’s Manual when connecting the power supply.

#### WARNING

- Use only the power cord and AC adapter supplied by YOKOGAWA Meters & Instruments for the XL100.
- Check that the power source voltage matches the supply voltage rating (100 to 240 VAC), and then connect the power cord.

#### Connecting the AC Adapter

Follow the steps below to connect the AC adapter.

1. Check that the power switch is OFF.
2. Connect the AC adapter to the AC adapter jack of the XL100.
3. Connect the plug of the power cord supplied with the AC adapter to the power connector of the AC adapter.
4. Connect the other end of the power cord to the power outlet that meets the power rating (requirements).

#### Power supply rating of the AC adapter

Supply voltage rating	100 to 240VAC
Allowable supply voltage range	90 to 264 VAC
Power supply frequency rating	50/60 Hz

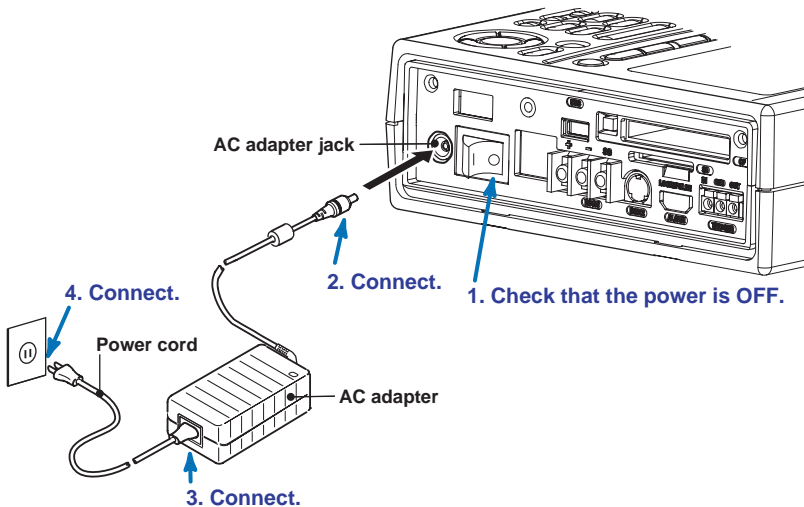

## 8. Connecting to the Power Supply and Turning the Power Switch ON/OFF

### Turning the Power Switch ON/OFF

The power switch is located on the right side panel of the XL100. To turn the power ON, press the I (ON) side of the power switch. Press the O on the other side to turn the power OFF.

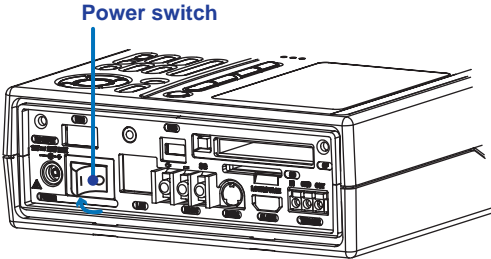

### Power Switch Operation When the Side Cover Is Attached

You can operate the power switch with the rubber boot and side cover attached by opening the power switch cover. To remove the side cover, loosen the side cover attachment screw.

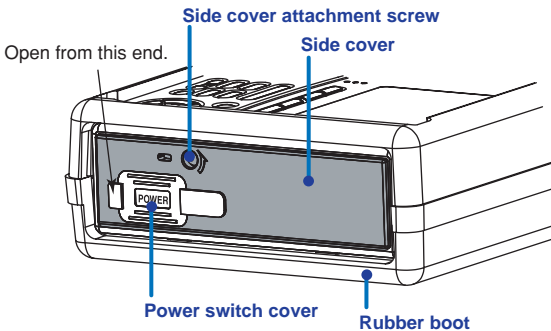

### Display at Power ON

When the power is turned ON, the XL100 shows “XL100 YOKOGAWA” followed by the self-test screen. When the self-test completes normally, the XL100 shows “Self Test OK” followed by the Waveform & Digital display of free running mode. For the corrective action when an error message is displayed, see section 4.1, “Turning ON/OFF the Power Switch” in the User’s Manual.

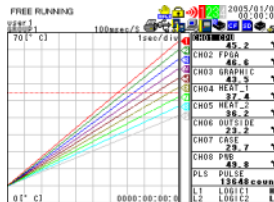
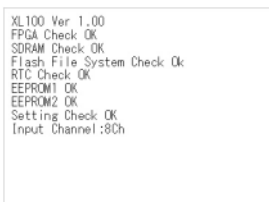

## 9. Setting the Input Channel

This chapter explains the steps to set the input channel using an example in which a thermocouple (type E, measurement range: 0.0 to 1000.0°C) is input to CH1. The settings of other input channels are not changed from the default settings. For details on setting the input channels, see chapter 5, “Setting the Input Channels” in the User’s Manual.

- Keys: 

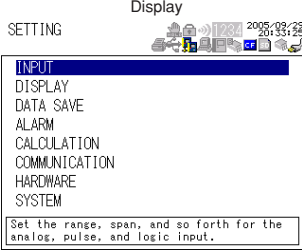
Display: 

**Change to Setting Mode.**
- Keys: 

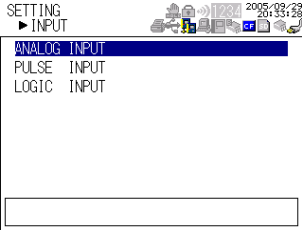
Display: 

**Show the INPUT menu.**
- Keys: 

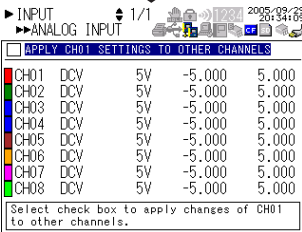

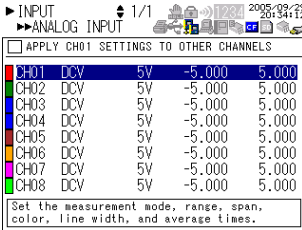

Display: 







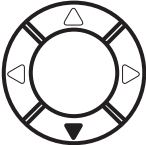
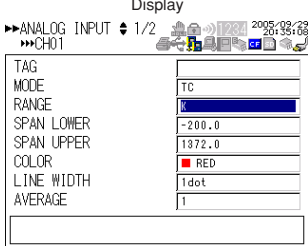

**Show the ANALOG INPUT setting screen.**
- Keys: 

Display: 

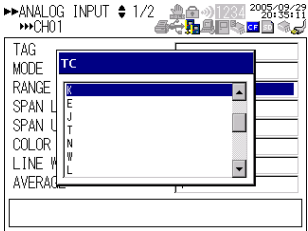

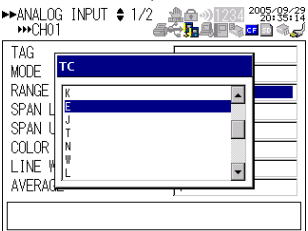
**Move the cursor to CH01.**

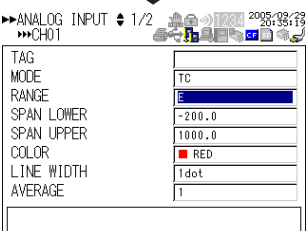

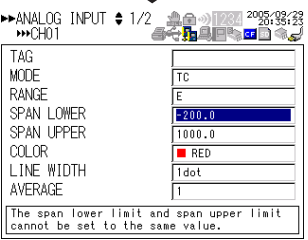
## 9. Setting the Input Channel

5. **Keys**  
  
**Show the CH01 setting screen.**
6.   
**Move the cursor to MODE.**
7.   
**Show the MODE selection list.**
8.   
**Move the cursor to TC.**
9.   
**Select TC.**
- Display**
- ▶ANALOG INPUT 1/2 2005-09-28 20:34:33  
 ▶▶CH01
- |            |        |
|------------|--------|
| TAG        |        |
| MODE       | DCV    |
| RANGE      | 5V     |
| SPAN LOWER | -5.000 |
| SPAN UPPER | 5.000  |
| COLOR      | RED    |
| LINE WIDTH | 1dot   |
| AVERAGE    | 1      |
- Set the tag. (max 8 characters)
- ↓
- ▶ANALOG INPUT 1/2 2005-09-28 20:34:33  
 ▶▶CH01
- |            |        |
|------------|--------|
| TAG        |        |
| MODE       | DCV    |
| RANGE      | 5V     |
| SPAN LOWER | -5.000 |
| SPAN UPPER | 5.000  |
| COLOR      | RED    |
| LINE WIDTH | 1dot   |
| AVERAGE    | 1      |
- ↓
- ▶ANALOG INPUT 1/2 2005-09-28 20:34:33  
 ▶▶CH01
- |         |      |
|---------|------|
| TAG     |      |
| MODE    | MODE |
| RANGE   | OFF  |
| SPAN L  | DCV  |
| SPAN U  | TC   |
| COLOR   | RTD  |
| LINE W  |      |
| AVERAGE |      |
- ↓
- ▶ANALOG INPUT 1/2 2005-09-28 20:34:33  
 ▶▶CH01
- |         |      |
|---------|------|
| TAG     |      |
| MODE    | MODE |
| RANGE   | OFF  |
| SPAN L  | DCV  |
| SPAN U  | TC   |
| COLOR   | RTD  |
| LINE W  |      |
| AVERAGE |      |
- ↓
- ▶ANALOG INPUT 1/2 2005-09-28 20:34:33  
 ▶▶CH01
- |            |        |
|------------|--------|
| TAG        |        |
| MODE       | TC     |
| RANGE      | K      |
| SPAN LOWER | -200.0 |
| SPAN UPPER | 1372.0 |
| COLOR      | RED    |
| LINE WIDTH | 1dot   |
| AVERAGE    | 1      |
- ↓

- 10.** **Keys**
- 
- Move the cursor to RANGE.**
- Display**
- 
- |            |        |
|------------|--------|
| TAG        |        |
| MODE       | Tc     |
| RANGE      | k      |
| SPAN LOWER | -200.0 |
| SPAN UPPER | 1372.0 |
| COLOR      | RED    |
| LINE WIDTH | 1dot   |
| AVERAGE    | 1      |
- 11.**
- 
- Show the RANGE selection list.**
- 
- 12.**
- 
- Move the cursor to E.**
- 
- 13.**
- 
- Select E.**
- 
- |            |        |
|------------|--------|
| TAG        |        |
| MODE       | Tc     |
| RANGE      | E      |
| SPAN LOWER | -200.0 |
| SPAN UPPER | 1000.0 |
| COLOR      | RED    |
| LINE WIDTH | 1dot   |
| AVERAGE    | 1      |
- 14.**
- 
- Move the cursor to SPAN LOWER.**
- 
- |            |        |
|------------|--------|
| TAG        |        |
| MODE       | Tc     |
| RANGE      | E      |
| SPAN LOWER | -200.0 |
| SPAN UPPER | 1000.0 |
| COLOR      | RED    |
| LINE WIDTH | 1dot   |
| AVERAGE    | 1      |
- The span lower limit and span upper limit cannot be set to the same value.

## 9. Setting the Input Channel

15. **Keys**
- 
- Show the SPAN LOWER entry window.**
- Display**
- ▶ANALOG INPUT ◀ 1/2 2005/09/23 20:35:56  
 ▶▶CHO1
- TAG: NUMERIC INPUT  
 MODE:   
 RANGE: VALUE: - 200.0  
 SPAN LI: RANGE: [-200.0~1000.0]  
 SPAN UI:   
 COLOR: ▲▼: CHANGE  
 LINE W: ◀▶: MOVE  
 AVERAGE: (SET) SET (ESC) CANCEL
- The span lower limit and span upper limit cannot be set to the same value.
- ↓
16. 
- Enter 0.0.**
- ▶ANALOG INPUT ◀ 1/2 2005/09/23 20:35:56  
 ▶▶CHO1
- TAG: NUMERIC INPUT  
 MODE:   
 RANGE: VALUE: 0.0  
 SPAN LI: RANGE: [-200.0~1000.0]  
 SPAN UI:   
 COLOR: ▲▼: CHANGE  
 LINE W: ◀▶: MOVE  
 AVERAGE: (SET) SET (ESC) CANCEL
- The span lower limit and span upper limit cannot be set to the same value.
- ↓
17. 
- Set SPAN LOWER settings.**  
 (This operation sets all the input settings.)
- ▶ANALOG INPUT ◀ 1/2 2005/09/23 20:36:04  
 ▶▶CHO1
- TAG: TC  
 MODE: E  
 RANGE:   
 SPAN LOWER: 0.0  
 SPAN UPPER: 1000.0  
 COLOR: RED  
 LINE WIDTH: 1dot  
 AVERAGE: T
- The span lower limit and span upper limit cannot be set to the same value.

- To perform measurement: 
- To configure other settings: 

# 10. Setting the Data Save Operation

This chapter explains the steps to save measured data using an example in which the sampling interval is set to 1 min, the data save destination is set to CF card, and the end trigger is set to timer (seven days later). The settings for saving other measured data are not changed from the default settings. For details on the settings for saving measured data, see section 9.1, “Setting the Save Operation of Measured and Calculated Data” in the User’s Manual.

**1.**  **Change to Setting Mode.**

**Display**

SETTING 2005-09-23 20:33:23

INPUT  
DISPLAY  
DATA SAVE  
ALARM  
CALCULATION  
COMMUNICATION  
HARDWARE  
SYSTEM

Set the range, span, and so forth for the analog, pulse, and logic input.

↓

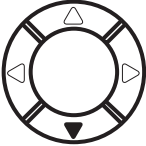
**2.**  **Move the cursor to DATA SAVE.**

SETTING 2005-09-23 20:33:50

INPUT  
DISPLAY  
DATA SAVE  
ALARM  
CALCULATION  
COMMUNICATION  
HARDWARE  
SYSTEM

Set the sampling interval, trigger, etc.

↓

**3.**  **Show the DATA SAVE setting screen.**

SETTING 2005-09-23 20:34:50

▶DATA SAVE

SAMPLING INTERVAL: 1s  
SAVE MEDIA: INTERNAL MEMORY  
SAVE TIME: 13H00min01s  
DATA TYPE: BINARY  
FILE NAME: \_\_\_\_\_  
PRINTER OUTPUT: OFF  
TRIGGER: \_\_\_\_\_

↓

**4.**  **Show the SAMPLING INTERVAL selection list.**

SETTING 2005-09-23 20:35:50

▶DATA SAVE

SAMPLING INTERVAL: 1s

SAVE: INTERNAL MEMORY

SAV: 1min50s





DATA: 5s  
FILE: 10s  
PRINT: 20s  
TRIGG: 30s  
1min  
2min

↓











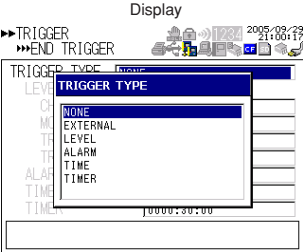

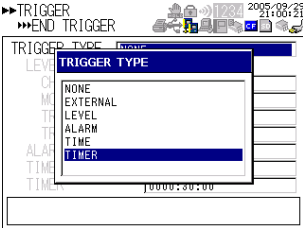

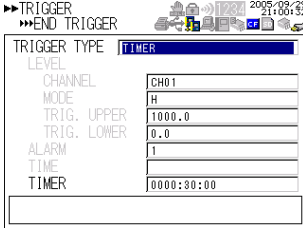
## 10. Setting the Data Save Operation

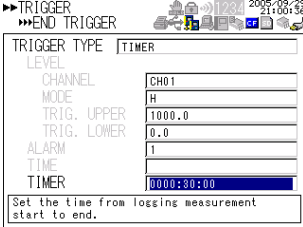
- 10.** Keys  Display
- Confirm CF CARD.**
- |                   |                     |
|-------------------|---------------------|
| SETTING           | 2005-09-23 20:39:41 |
| ▶DATA SAVE        |                     |
| SAMPLING INTERVAL | 1min                |
| SAVE MEDIA        | CF CARD             |
| SAVE TIME         | 6800h11min00s       |
| DATA TYPE         | BINARY              |
| FILE NAME         |                     |
| PRINTER OUTPUT    | OFF                 |
| TRIGGER           |                     |
- 11.** 
- Move the cursor to TRIGGER.**
- |                      |                     |
|----------------------|---------------------|
| SETTING              | 2005-09-23 20:39:46 |
| ▶DATA SAVE           |                     |
| SAMPLING INTERVAL    | 1min                |
| SAVE MEDIA           | CF CARD             |
| SAVE TIME            | 6787h39min00s       |
| DATA TYPE            | BINARY              |
| FILE NAME            |                     |
| PRINTER OUTPUT       | OFF                 |
| TRIGGER              |                     |
| Set trigger details. |                     |
- 12.** Keys  Display
- Show the TRIGGER setting screen.**
- |                          |                     |
|--------------------------|---------------------|
| ▶DATA SAVE               | 2005-09-23 20:39:54 |
| ▶▶TRIGGER                |                     |
| TRIGGER MODE             | SINGLE              |
| PRE/TRIGGER DELAY        | PRE-TRIGGER         |
| SAMPLING COUNT           | 0                   |
| START TRIGGER            | TIME                |
| END TRIGGER              | NONE                |
|                          |                     |
| Set end trigger details. |                     |
- 13.** 
- Move the cursor to END TRIGGER.**
- |                          |                     |
|--------------------------|---------------------|
| ▶DATA SAVE               | 2005-09-23 20:39:57 |
| ▶▶TRIGGER                |                     |
| TRIGGER MODE             | SINGLE              |
| PRE/TRIGGER DELAY        | PRE-TRIGGER         |
| SAMPLING COUNT           | 0                   |
| START TRIGGER            | TIME                |
| END TRIGGER              | NONE                |
|                          |                     |
| Set end trigger details. |                     |
- 14.** Keys  Display
- Show the END TRIGGER setting screen.**
- |                |                     |
|----------------|---------------------|
| ▶▶TRIGGER      | 2005-09-23 21:00:08 |
| ▶▶▶END TRIGGER |                     |
| TRIGGER TYPE   | NONE                |
| LEVEL          |                     |
| CHANNEL        | CH01                |
| MODE           | H                   |
| TRIG. UPPER    | 1000.0              |
| TRIG. LOWER    | 0.0                 |
| ALARM          | 1                   |
| TIME           |                     |
| TIMER          | 0000:30:00          |
|                |                     |

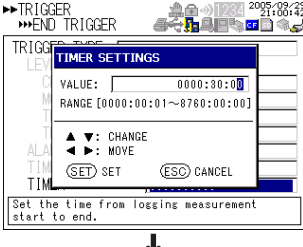
## 10. Setting the Data Save Operation

15. **Keys**  
  
**Show the TRIGGER TYPE selection list.**
- Display**  

 The screenshot shows the 'TRIGGER TYPE' selection menu. The options listed are NONE, EXTERNAL, LEVEL, ALARM, TIME, and TIMER. The 'TIMER' option is highlighted at the bottom of the list. The background shows the 'TRIGGER' menu with 'TRIGGER TYPE' selected.
16.   
**Move the cursor to TIMER.**
- 
 The screenshot shows the 'TRIGGER TYPE' selection menu with the 'TIMER' option highlighted. The background shows the 'TRIGGER' menu with 'TRIGGER TYPE' selected.
17. **Keys**  
  
**Select TIMER.**
- 
 The screenshot shows the 'TIMER' settings window. The 'TIMER' option is selected in the 'TRIGGER TYPE' field. The settings include: CHANNEL: CH01, MODE: H, TRIG. UPPER: 1000.0, TRIG. LOWER: 0.0, ALARM: 1, TIME: 0000:30:00. The background shows the 'TRIGGER' menu with 'TIMER' selected.
18.   
**Move the cursor to TIMER.**
- 
 The screenshot shows the 'TIMER' settings window with the 'TIMER' field highlighted. The background shows the 'TRIGGER' menu with 'TIMER' selected.
19. **Keys**  
  
**Show the TIMER SETTINGS window.**
- 
 The screenshot shows the 'TIMER SETTINGS' window. The 'VALUE' field is set to 0000:30:00. The 'RANGE' is 0000:00:01~8760:00:00. The window includes navigation keys: ▲▼: CHANGE, ◀▶: MOVE, and buttons for SET and CANCEL. The background shows the 'TRIGGER' menu with 'TIMER' selected.

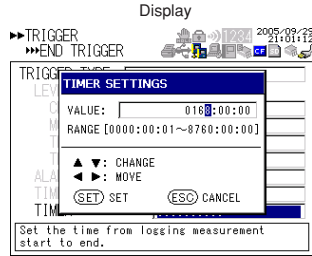

## 10. Setting the Data Save Operation

20.  Keys
- Enter 0168:00:00.

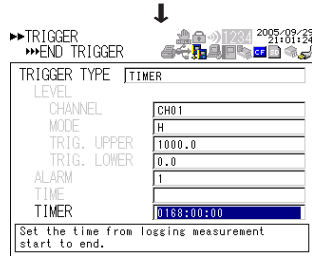

21.  SET
- Set END TRIGGER settings.  
(This operation sets all the data save settings.)



- To perform measurement:  HOME
- To configure other settings:  SETTING

---

## 11. Confirming the Settings and Performing the Measurement

When you are done with the settings, press **HOME** to switch to Free Running Mode and check the settings.

The figure below shows the display that appears when the XL100 is configured as explained in section chapter 9, “Setting the Input Channel” and 10, “Setting the Data Save Operation.”

Check whether the displayed values are correct. If the measured values are not correct, switch back to Setting Mode, and check that the input settings are correct. If the measured values are not correct even though the input settings are correct, see chapter 14, “Troubleshooting.”

If the CF Card icon is gray, the save destination is not set to the CF card.

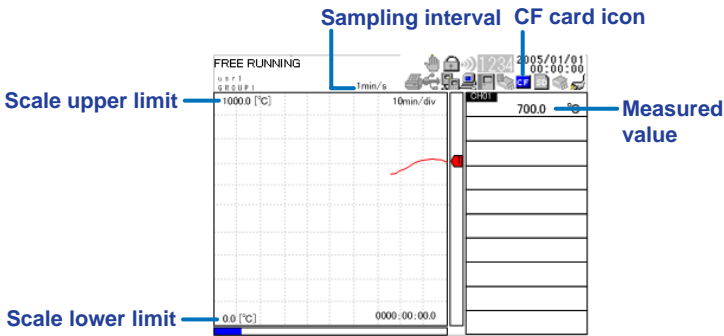

---

### TIP

- To switch to a display other than waveform & digital display, press **DISPLAY** to show the display switch pop-up menu, select the display using the arrow keys, and press **SELECT**. (The steps are explained in page 21.)
  - Press **TIME/DIV** to switch the time axis (the time per grid (division)).
  - Press **RANGE** to change the input range or span (scale).
-

## 12. Inserting an External Storage Medium and Saving Data

### Inserting an External Storage Medium

CF cards (Type II) and SD cards can be used on the XL100 as external storage media.

For the handling precautions of the external storage media, the estimated amount of stored data, and other information, see section 4.7, "Inserting and Removing the External Storage Media" in the User's Manual.

#### Inserting or Removing a CF Card

Insert the CF card firmly into the CF card slot on the side panel of the XL100.

To remove the CF card, press the CF card eject button to the left of the CF card slot, and pull the CF card out.

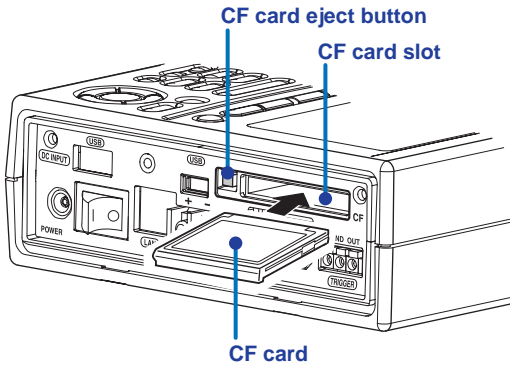

#### Inserting or Removing a SD Card

Insert the SD card firmly into the SD card slot on the side panel of the XL100.

To remove the SD card, press the SD card, and then pull it out.

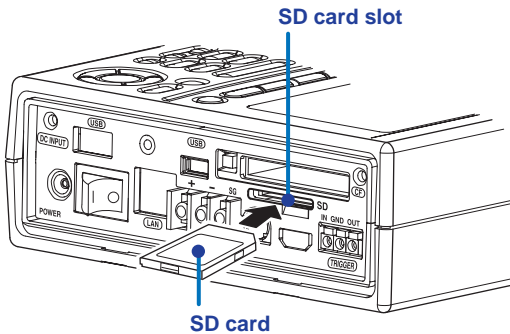

## 12. Inserting an External Storage Medium and Saving Data

---

### Starting the Data Save Operation

To start the data save (logging) operation, press **START/STOP**. When the data save operation starts, the START LED illuminates. If a start trigger (see page 17) is specified, the logging operation starts when the trigger condition is met.

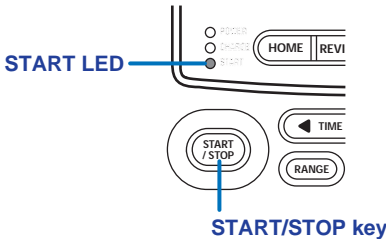

### Usage Indication of the External Storage Media

The amount of space used is displayed using a blue bar with respect to the total space on the storage medium that is specified to be the save destination of the measured data.

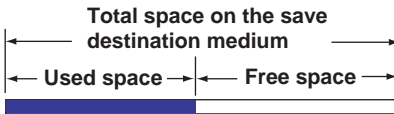

### Stopping the Data Save Operation

Press **START/STOP**. If a stop trigger (see page 17) is specified, the logging operation stops automatically when the trigger condition is met.

#### TIP

---

- A file name “YYMMDDhhmmss.DLO” (YY: year, MM: month, DD: day, hh: hour, mm: minute, ss: second) is automatically assigned to measurement data files. You can also assign an arbitrary file name. For the procedure to assign an arbitrary file name, see section 9.1, “Setting the Save Operation of Measured and Calculated Data” in the User’s Manual.
  - The measured/calculated data (instantaneous values) can be saved by pressing SAVE in Free Running Mode. For the procedure to save the data manually, see section 9.3, “Manually Saving Measured and Calculated Data” in the User’s Manual.
  - The saved data file can be renamed, deleted, or copied to another external storage medium in File Operation Mode. For these operations, see sections 9.7 to 9.9 in the User’s Manual.
  - If the data fails to be written to the save destination for some reason, the data is saved to the backup memory. For details on the backup memory, see section 9.1, “Manually Saving Measured and Calculated Data” in the User’s Manual.
-

# 13. Analyzing the Saved Data

## Loading the Saved Data File

The steps to load measured data saved to a CF card is given below.

### TIP

If you press REVIEW in Logging Mode, the XL100 switches to Logging & Review Mode (see page 20).

1. **REVIEW**  
Change to Review Mode.

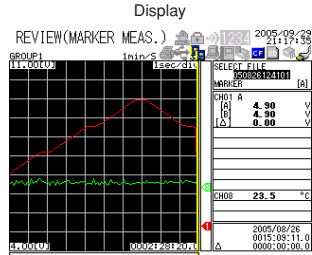

2. **SELECT**  
Show the LOAD FILE window.

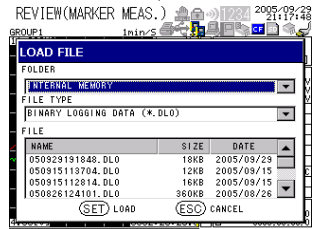

3. **SELECT**  
Show the LOAD FILE selection list.

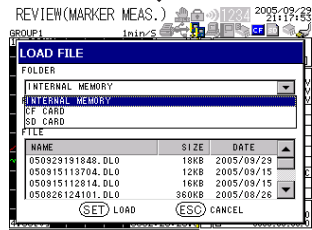

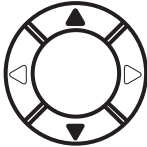
4.   
Move the cursor to CF CARD.

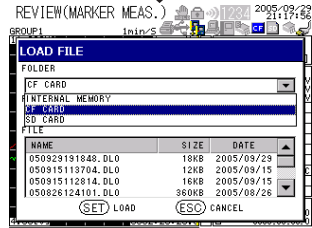





### 13. Analyzing the Saved Data

5. 

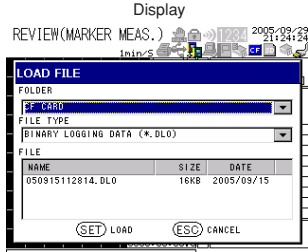
Select CF CARD.



6. 

Move the cursor to the file shown in the FILE area.

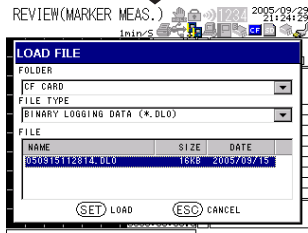

7. 

Select the file.

The file is loaded, and the data is displayed as shown in the figure on the right.

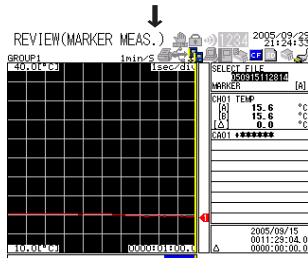

### Loading the Measured Data

Two markers (three markers including marker ALM when an alarm is activated) are shown in Review Mode. A measured value at an arbitrary position can be read by moving the markers horizontally.

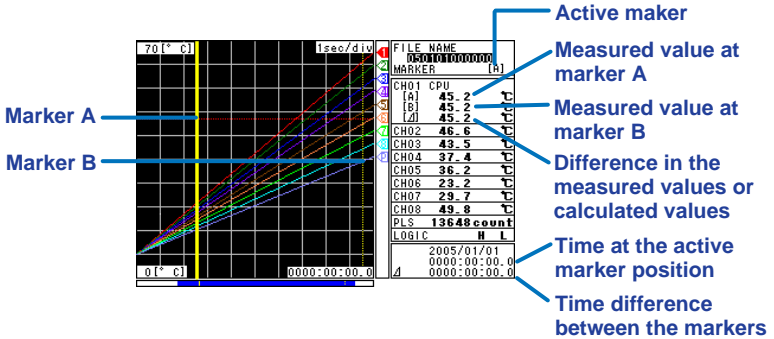

### Selecting the Marker

Press **MARK** to select marker A and B alternately. The selected marker (active marker) is displayed with a thick line.

### Moving the Marker

Press the left or right arrow key. Hold the key down to move the marker quickly.

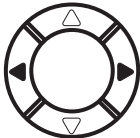

### Moving the Marker by One Division

Press **←** **→** (fast forward key) to move the active marker to the left or right by one division.

### Displaying Statistical Calculation Values

Press **DISPLAY** in Review Mode to display the maximum, minimum, average, peak (P-P), and rms values from the start to the end of the logging operation. Press **DISPLAY** again to return to the marker display.

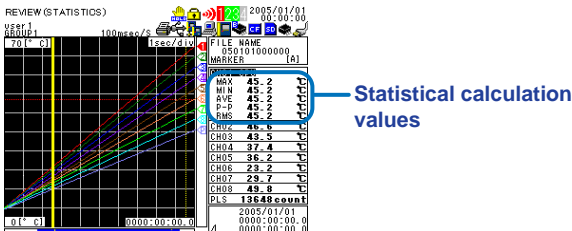

---

## 14. Troubleshooting

The table below lists the major symptoms and their corrective actions. For the procedure to check the items under “Things to Check”, see the referenced section written in section 12.1, “Troubleshooting” in the User’s Manual. For the corrective action for error messages, see the referenced section written in section 12.2, “Messages and Their Corrective Actions” in the User’s Manual.

Symptom	Things to Check
Nothing appears even when the power is turned ON.	For AC power operation <ul style="list-style-type: none"><li>• Check that the power cord is properly connected to the power outlet.</li><li>• Check that the power supply is within the allowed supply voltage range.</li></ul> For battery operation <ul style="list-style-type: none"><li>• Check that the battery is loaded correctly.</li><li>• Check that the battery is charged adequately.</li></ul>
The measurement display is odd.	<ul style="list-style-type: none"><li>• Check that noise is not riding on the input signal.</li><li>• Check that the wires are correctly connected.</li><li>• Check that the ambient temperature and humidity are within the allowed specifications.</li></ul>
Keys do not work.	Check that the key lock (  ) is not shown at the upper right corner of the display.
Unable to save/load from the memory.	<ul style="list-style-type: none"><li>• Turn the power switch OFF and then back internal ON. It may be restored by the power-on self-test.</li><li>• There may have been a power problem while the internal memory was being accessed. Format the internal memory in File Operation Mode. Note that the data saved in the memory will be lost in the process.</li></ul>
Unable to save/load from the external storage medium.	<ul style="list-style-type: none"><li>• Check that the external storage medium is correctly inserted.</li><li>• Check that the external storage medium is formatted.</li><li>• Check that there is sufficient free space on the external storage medium.</li></ul>
Unable to set or control the instrument using communication commands.	<ul style="list-style-type: none"><li>• Check that the communication parameters are matched.</li><li>• Check that the specifications of the cable is suitable for the application.</li><li>• Check that the electrical specifications are correct.</li></ul>
Unable to print.	<ul style="list-style-type: none"><li>• Check that the printer is turned ON.</li><li>• Check that the specifications of the connection cable are correct.</li><li>• Check that the cable is correctly connected.</li><li>• Check that the communication parameters on the XL100 and printer are matched.</li><li>• Check that the chart is loaded correctly in the printer.</li></ul>

# Index

## A

---

AC adapter 10, 25  
accessories 4  
active channel 11  
active marker 41  
alarm 15, 17  
alarm data 16  
alarm function 15  
alarm line 11  
alarm output status 9  
alarm status 9  
alarm summary display 13  
arrow keys 7

## B

---

backup file 16  
backup memory 10  
bar graph display 12  
battery 8, 10

## C

---

CF card 10, 16, 37  
channel No. 12  
character entry 22  
CHARGE LED 6  
communication function 18  
copy backup memory 17  
copy data 17

## D

---

data save operation, setting of 31, 32, 33, 34  
data save operation, starting of 38  
data save operation, stopping of 38  
data, saving of 16  
date/time 9  
DC current 24  
DC voltage 14, 24  
differential calculation 14  
digital display 12  
DISPLAY key 7, 21, 41  
display switching 21

## E

---

e-mail transmission 19  
elapsed time 12  
ESC key 7  
external storage medium 37  
external trigger 17

## F

---

fast forward key 7, 41  
FILE key 7, 20  
File Operation Mode 20  
file operations 17  
format 17  
Free Running Mode 20  
front panel 6  
FTP server 18

## G

---

grid 11  
GROUP key 7  
group name 9

## H

---

hold 10  
HOLD key 7  
HOME key 7, 20, 36

## I

---

icon 10  
icons 9  
input settings 27  
input type 14  
internal memory 9, 16, 17

## K

---

key lock 10  
keys 6

## Index

---

### L

---

LAN  
level 17  
load setting data 17  
log data 16  
log display 13  
Logging & Review Mode 20  
logging data 16  
Logging Mode 20  
logging review display 13  
logic 14

### M

---

manual sampled data 16  
MARK key 7, 41  
marker 41  
measured data, loading of 41  
menu switching 21  
Modbus 10, 19  
model 4

### O

---

operation mode 9, 20

### P

---

Pen 11  
POWER LED 6  
power supply, connection of 25  
power switch, turning ON/OFF of 26  
printer 10  
pulse 14

### R

---

RANGE key 7  
rear panel 8  
rename 17  
review display 13  
REVIEW key 7, 20, 39  
Review Mode 20, 41  
RS-232 8, 19  
RS-485 8, 19  
RTD 14, 24

### S

---

sampling interval 9, 31  
SAVE key 7  
save setting data 17  
saved data file, loading of 39  
scale 11  
screen image data 16  
SD card 10, 37  
SELECT key 7  
serial communication 19  
SET key 7  
setting data 16  
SETTING key 7, 20, 27, 31  
Setting Mode 20  
side panel 8  
signal input wiring 23  
START LED 6, 38  
START/STOP key 7, 20, 38  
Statistical Calculation 14  
statistical computation 41  
status display section 6, 9  
storage media, usage indication bar of 11

### T

---

tag 12  
terminal block unit 6  
terminal cover 23  
thermocouple 14, 24, 27  
time 17  
time axis 11  
TIME/DIV key 7  
timer 17, 31  
triggers 17

### U

---

unit 12  
usage indication of the external storage media 38  
USB 10, 19  
user name 9

### V

---

values, entry of 22

## W

---

waveform 11  
Web server 18

# Memo

# Memo



# Memo