**Instruction
Manual**

**Model UP750
Program Controller
User's Manual for
Dual-loop Control**



IM 05E01B02-51E

Blank Page

Introduction

Thank you for purchasing the UP750 program controller.

■ How to Use the Manuals

Purpose	Manual Title	Description
Setup	1. Installation	Describes the tasks (installation, wiring, and others) required to make the controller ready for operations.
Basic operation	2. Initial Settings	Describes examples of setting PV input types and control output types. Making settings described herein and program creation in "3. Programming" allows you to carry out basic control.
Program creation	3. Programming	Describes examples of creating basic programs. The use of the program pattern setup charts included in the "3.7 Program Pattern Setup Charts" is recommended.
General understanding of programming operations	3.5 Program Parameter Map 3.6 Lists of Program Parameter	Contains a parameter map that serves as a guide to creating programs. Also includes a brief explanation of the functions of program parameters.
Operating procedures and troubleshooting	4. Operations	Describes key operation sequences. For operation control through external contact inputs, see "1.5 Terminal Wiring Diagrams."
Brief operation	6.1 Parameter Map	Contains the parameter map used as a guideline for setting parameters.
Function description and setpoint recording	6.2 List of Parameters	Briefly describes the functions of parameters. In addition, each parameter table has a User Setting column, where you can record your setpoints when setting them in the controller.

■ Controllers Applicable to Dual-loop Control

The specification codes of the UP750 applicable to dual-loop control are given in the table below.

UP750-50	UP750-51
----------	----------

■ Regarding This User's Manual

- (1) This manual should be provided to the end user. Keep an extra copy or copies of the manual in a safe place.
- (2) Read this manual carefully to gain a thorough understanding of how to operate this product before starting operation.
- (3) This manual describes the functions of this product. Yokogawa M&C Corporation (hereinafter simply referred to as Yokogawa) does not guarantee the application of these functions for any particular purpose.
- (4) Under absolutely no circumstances may the contents of this manual, in part or in whole, be transcribed or copied without permission.
- (5) The contents of this manual are subject to change without prior notice.
- (6) Every effort has been made to ensure that the details of this manual are accurate. However, should any errors be found or important information be omitted, please contact your nearest Yokogawa representative or our sales office.

■ Safety Precautions

The following symbol is indicated on the controller to ensure safe use.



This symbol on the controller indicates that the operator must refer to an explanation in the instruction manual in order to avoid the risk of injury or death of personnel or damage to the instrument. The manual describes how the operator should exercise special care to avoid electric shock or other dangers that may result in injury or loss of life.

The following symbols are used in the hardcopy user's manuals and in the user's manual supplied on the CD-ROM.



Indicates that operating the hardware or software in a particular manner may damage it or result in a system failure.



Draws attention to information that is essential for understanding the operation and/or features of the controller.

■ Regarding Force Majeure

Yokogawa M&C Corporation assumes no liability for any loss or damage, direct or indirect, caused by the use of or unpredictable defects of the product.

Model UP750 Program Controller User's Manual for Dual-loop Control

IM 05E01B02-51E 1st Edition

CONTENTS

1.	Installation	1-1
1.1	Model and Suffix Codes	1-1
1.2	How to Install	1-2
1.3	How to Connect Wires	1-5
1.4	Hardware Specifications	1-7
1.5	Terminal Wiring Diagrams	1-13
2.	Initial Settings	2-1
2.1	Names and Functions of Front Panel Parts	2-2
2.2	Setting UP mode (Setting First at Power-on)	2-3
2.3	Changing UP mode	2-4
2.4	Setting PV Input Types of Loop1 and Loop2	2-6
2.5	Setting Control Output Types of Loop1 and Loop2	2-10
2.6	Initializing Parameters	2-13
3.	Programming	3-1
3.1	Overview of Program Patterns	3-1
3.2	Example of Program Pattern Setup Charts	3-2
3.3	Creating Program Patterns	3-4
3.4	Changing Program Patterns	3-13
3.5	Program Parameter Map	3-16
3.6	Lists of Program Parameters	3-18
3.7	Program Pattern Setup Charts	3-23
3.8	Explanation of Program Functions	3-26
4.	Operations	4-1
4.1	Monitoring-purpose Operating Displays Available during Operation	4-1
4.2	Performing/Canceling Auto-tuning of Loop1	4-6
4.3	Performing/Canceling Auto-tuning of Loop2	4-8
4.4	Setting PID Manually of Loop1	4-9
4.5	Setting PID Manually of Loop2	4-11
4.6	Selecting the Program Pattern Number (PT.No)	4-12
4.7	Switching between RUN and RESET Modes	4-13
4.8	Switching between AUTO and MAN of Loop1	4-14
4.9	Switching between AUTO and MAN of Loop2	4-15
4.10	Manipulating Control Output during Manual Operation of Loop1	4-16

4.11	Manipulating Control Output during Manual Operation of Loop2	4-18
4.12	Enabling/Disabling the Hold Mode of Program Operation	4-20
4.13	Changing Program Setpoints when in Hold Mode	4-21
4.14	Executing the “Advance” Function	4-22
4.15	Switching to Local-mode (LOCAL) Operation	4-23
4.16	Changing Setpoints during Local-mode Operation	4-24
5.	Troubleshooting and Maintenance	5-1
5.1	Troubleshooting	5-1
5.2	Maintenance	5-5
5.2.1	Cleaning	5-5
5.2.2	Replacing Brackets	5-5
5.2.3	Attaching Terminal Cover	5-5
5.2.4	Replacing Parts with a Limited Service Life	5-7
5.2.5	Replacing Control Output Relays	5-8
6.	Parameters	6-1
6.1	Parameter Map	6-1
6.2	Lists of Parameters	6-6
7.	Function Block Diagram and Descriptions	7-1

1. Installation

This chapter describes installation, wiring, and other tasks required to make the controller ready for operation.

1.1 Model and Suffix Codes

Before using the controller, check that the model and suffix codes match your order.

Model	Suffix Code	Description
UP750		Program controller (provided with Custom Computing Function*)
Type	-0	Single-loop type
	-5	Dual-loop type
Optional functions	0	None
	1	With communication, auxiliary analog input

Check that the following items are provided:

- Program controller (of ordered model) 1
- Brackets (mounting hardware) 1 pair
- Unit label 1
- User's Manuals for Single-loop Control 7 (A2 size)
- User's Manual (Reference) (CD-ROM version) 1

* Using an optional custom computation building tool (Model LL200-E10) that runs on a personal computer, you can build a variety of computations (e.g., four arithmetic operations, logical operations, ten-segment linearizer computations, temperature correction factor computations, and pressure correction factor computations) to be applied to the controller's I/O signals.

1.2 How to Install

NOTE

To install the controller, select a location where:

1. no one may accidentally touch the terminals,
2. mechanical vibrations are minimal,
3. corrosive gas is minimal,
4. temperature can be maintained at about 23°C and the fluctuation is minimal,
5. no direct radiant heat is present,
6. no magnetic disturbances are caused,
7. no wind blows against the terminal board (reference junction compensation element),
8. no water is splashed,
9. no flammable materials are around,

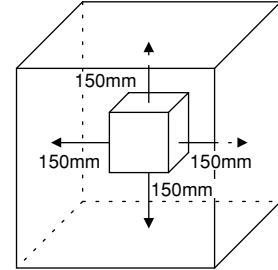

Never place the controller directly on flammable items or equipment.

If the controller has to be installed close to flammable items or equipment, be sure to provide shielding panels all around the controller, at least 150 mm away from every side; the panels should be made of either 1.43 mm-thick metal-plated steel plates or 1.6 mm-thick uncoated steel plates.

● Installation Position

Install the controller at an angle within 30° from horizontal with the front panel facing upward. Do not install it facing downward. The position of right and left sides should be horizontal.

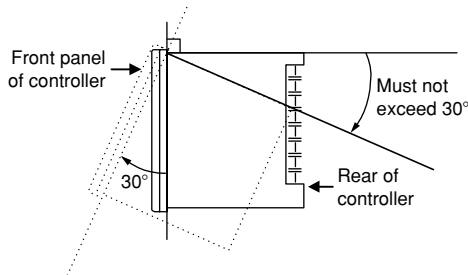

External Dimensions and Panel Cutout Dimensions

UP750

Unit: mm

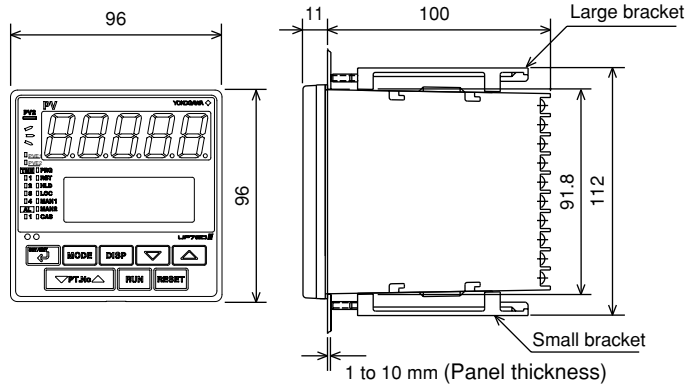

General installation

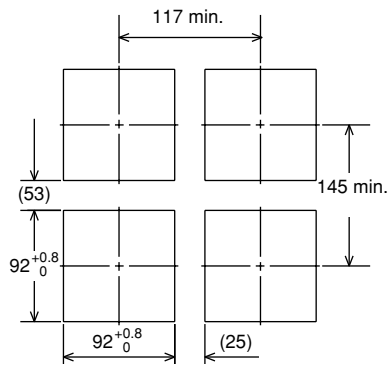

Side-by-side close installation

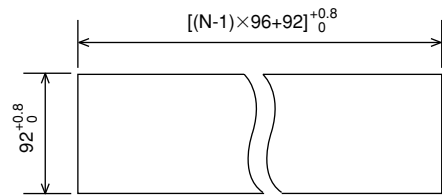

"N" stands for the number of controllers to be installed.
However, the measured value applies if $N \geq 5$.

■ How to Install



CAUTION

Turn off the power to the controller before installing it on the panel because there is a possibility of electric shock.

After opening the mounting hole on the panel, follow the procedures below to install the controller:

1. Insert the controller into the opening from the front of the panel so that the terminal board on the rear is at the far side.
2. Set the brackets in place on the top and bottom of the controller as shown in the figure below, then tighten the screws of the brackets. Take care not to overtighten them.

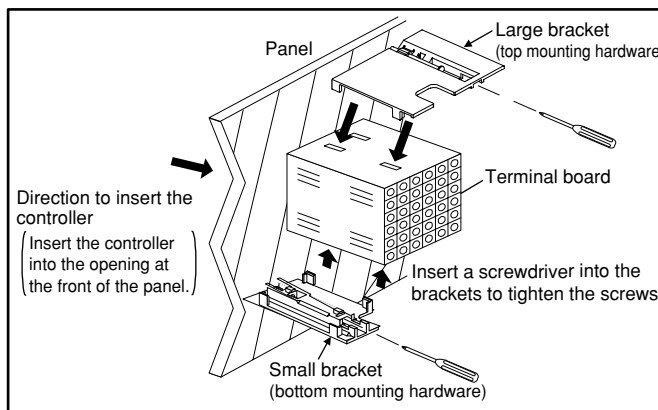

1.3 How to Connect Wires



- 1) Before carrying out wiring, turn off the power to the controller and check that the cables to be connected are not alive with a tester or the like because there is a possibility of electric shock.
- 2) Wiring must be carried out by personnel who have basic electrical knowledge and practical experience.

NOTE

- 1) Provide power from a single-phase instrument power supply. If there is a lot of noise in the power line, insert an insulating transformer into the primary side of the line and use a line filter (recommended part: ZAC2205-00U from TDK) on the secondary side. As a countermeasures against noise, do not place the primary and secondary power cables close to each other.
- 2) For thermocouple input, use shielded compensating lead wires for wiring. For RTD input, use shielded wires that have low conductor resistance and cause no significant differences in resistance between the three wires. The cables to be used for wiring, terminal specifications, and recommended parts are as shown below.
- 3) Control output relays may be replaced. However, because they have a life of 100,000 times that of the resistance load, use auxiliary relays to turn on/off a load.
- 4) The use of inductance (L) loads such as auxiliary relays, motors and solenoid valves causes malfunction or relay failure; always insert a CR filter for use with alternating current or a diode for use with direct current, as a spark-removal surge suppression circuit, into the line in parallel with the load.

■ For DC Relay Wiring

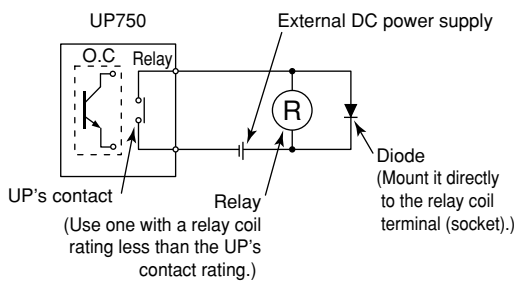

■ For AC Relay Wiring

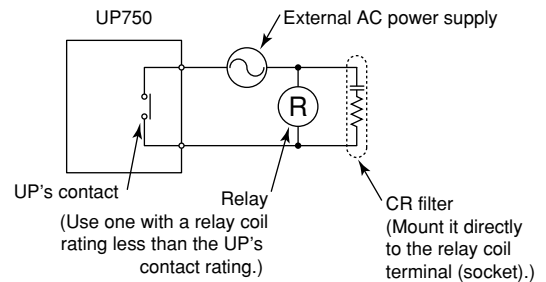

● Cable Specifications and Recommended Cables

Purpose	Name and Manufacturer
Power supply, grounding, relay contact outputs	600 V PVC insulated wires, JIS C 3307, 0.9 to 2.0 mm ²
Thermocouple	Shielded compensating lead wires, JIS C 1610, □X-□-□-□ (See Yokogawa Electric's GS 6B1U1-E.)
RTD	Shielded wires (three conductors), UL2482 (Hitachi Cable)
Other signals	Shielded wires

● Recommended Terminal Lugs

Applicable wire size	Tightening torque
0.3 to 1.65 mm ²	0.8 N·m or less

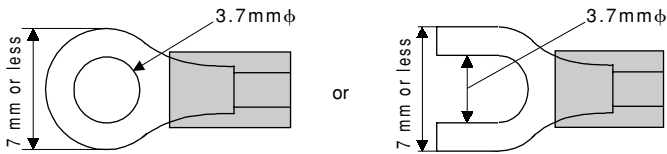

● Terminal Covers

Target Model	Part Number	Sales Unit
For UP750	T9115YD	1

1.4 Hardware Specifications

PV Input Signals

- Number of inputs: 2 (Loop1: terminals ①①-①②-①③/Loop2: terminals ④①-④②-④③)
- Input type: Universal input system. The input type can be selected with the software.
- Sampling period: Can be selected from 100, 200 and 500 ms.
- Burnout detection: Functions at TC, RTD, standard signal (0.4 to 2 V or 1 to 5 V)
Upscale, downscale, and off can be specified.
For standard signal, burnout is determined to have occurred if it is 0.1 V or less.
- Input bias current: 0.05 μA (for TC or RTD b-terminal)
- Measurement current (RTD): About 0.13 mA
- Input resistance: 1 $\text{M}\Omega$ or more for thermocouple or mV input
About 1 $\text{M}\Omega$ for DC voltage input
Loop2 PV input of 0.00 to 1.25 V range is about 8 Ω
- Allowable signal source resistance: 250 Ω or less for thermocouple or mV input
Effects of signal source resistance: 0.1 $\mu\text{V}/\Omega$ or less
2 k Ω or less for DC voltage input
Effects of signal source resistance: About 0.01%/100 Ω
- Allowable wiring resistance: for RTD input
Maximum 150 Ω /wire: Conductor resistance between three wires should be equal
However, 10 Ω /wire for a maximum range of -150.0 to 150.0 $^{\circ}\text{C}$.
Wire resistance effect: $\pm 0.1^{\circ}\text{C}/10 \Omega$
- Allowable input voltage: $\pm 10 \text{ V}$ DC for thermocouple, mV, or RTD input
 $\pm 20 \text{ V}$ DC for DC voltage input
- Noise rejection ratio: 40 dB (50/60 Hz) or more in normal mode
120 dB (50/60 Hz) or more in common mode
- Reference junction compensation error: $\pm 1.0^{\circ}\text{C}$ (15 to 35 $^{\circ}\text{C}$)
 $\pm 1.5^{\circ}\text{C}$ (0 to 15 $^{\circ}\text{C}$, 35 to 50 $^{\circ}\text{C}$)
- Applicable standards: JIS, IEC, DIN (ITS-90) for thermocouples and RTD

Auxiliary Analog Input Signals

Available only for controllers with auxiliary analog input terminals.

- Number of inputs: 1 (terminals ②①-②②)
- Input type: Settable in a range of 0-2, 0-10, 0.4-2.0, or 1-5 V DC
- Sampling period: 100, 200 and 500 ms
The sampling period of a remote input signal is associated with the PV input's sampling period.
- Input resistance: About 1 $\text{M}\Omega$
- Input accuracy: $\pm 0.3\% \pm 1$ digit of input span for 0 to 2 V DC
 $\pm 0.2\% \pm 1$ digit of input span for 0 to 10 V DC
 $\pm 0.375\% \pm 1$ digit of input span for 0.4 to 2.0 V DC
 $\pm 0.3\% \pm 1$ digit of input span for 1 to 5 V DC
Under standard operating conditions (23 $\pm 2^{\circ}\text{C}$, 55 $\pm 10\%$ RH, power frequency of 50/60 Hz)

Loop Power Supply

Power is supplied to a two-wire transmitter.

(15 V DC: terminals ⑭-⑮)

A resistor (10 to 250 Ω) connected between the controller and transmitter converts a current signal into a voltage signal, which is then read via the PV input terminal.

Supply voltage: 14.5 to 18.0 V DC, max. 21 mA (provided with a protection circuit against a field short-circuit)

Retransmission Output

Either PV, program setpoint, or control output is output.

Either the retransmission output or the loop power supply can be used with terminals ⑭-⑮.

- Number of outputs: 1 or 2 (terminals ⑭-⑮, terminals ⑰-⑱)
- Output signal: 4-20, 0-20, 20-4, or 20-0 mA DC (where, outputting signal levels of less than 0 mA is not feasible)
- Load resistance: 600 Ω or less
- Output accuracy: ±0.1% of span (±5% of span for 1 mA or less.)
Under standard operating conditions (23±2°C, 55±10% RH, power frequency of 50/60 Hz)

Control Output

Universal output system, The output type can be selected with the software.

- Current output
(Loop1: terminals ⑰-⑱; heating-side output: terminals ⑰-⑱, cooling-side output: terminals ⑭-⑮)
(Loop2: terminals ⑳-㉑; heating-side output: terminals ⑳-㉑, cooling-side output: Not selected)

Number of outputs	2 or 3 (two for heating/cooling type), switched between a voltage pulse output and current output.
Output signal	4-20, 0-20, 20-4, or 20-0 mA DC
Load resistance	600 Ω or less
Output accuracy	±0.1% of span (±5% of span for 1 mA or less) Under standard operating conditions (23±2°C, 55±10% RH, power frequency of 50/60 Hz)

- Voltage pulse output
(Loop1: terminals ⑰-⑱; heating-side output: terminals ⑰-⑱, cooling-side output: Not selected)
(Loop2: terminals ⑳-㉑; heating-side output: terminals ⑳-㉑, cooling-side output: Not selected)

- Relay contact output
(Loop1: terminals ①-②-③; heating-side output: terminals ①-②-③, cooling-side output: terminals ④-⑦)
(Loop2: terminals ④⑧-④⑨-⑤⑩; heating-side output: terminals ④⑧-④⑨-⑤⑩, cooling-side output: terminals ⑤-⑦)

Number of outputs	2 or 4 (two for heating/cooling type)
Output signal	Three terminals (NC, NO, and common)
Contact rating	250 V AC or 30 V DC, 3 A (resistance load)
Resolution	10 ms or 0.1% of output, whichever is larger

Contact Inputs

- Purpose: Program pattern no. selection, and run/reset switching
- Number of inputs: 7 points
- Input type: Non-voltage contact or transistor open collector input
- Input contact rating: 12 V DC, 10 mA or more
- On/off determination: For non-voltage contact input, contact resistance of 1 k Ω or less is determined as "on" and contact resistance of 20 k Ω or more as "off."
For transistor open collector input, input voltage of 2 V or less is determined as "on" and leakage current must not exceed 100 μ A when "off."
- Minimum status detection hold time: PV input's sampling period \times 3

Contact Outputs

- Purpose: Event output, FAIL output, and others
- Number of outputs: 7 points
- Relay contact rating: 240 V AC, 1 A, or 30 V DC, 1 A
- Transistor contact rating: 24 V DC, 50 mA

Display Specifications

- PV display: 5-digit, 7-segment, red LEDs, character height of 20 mm
- Setpoint display: 32 \times 128 dot LCD with back lighting
- Status indicating lamps: LEDs

Safety and EMC Standards

- Safety: Compliant with IEC1010-1: 1990 and EN61010-1: 1992
Approved by CSA1010
CSA1010 installation category (overvoltage category) : CATII (IEC1010-1)
Approved by UL508
- EMC standards: This instrument complies with the following EMC standards (the instrument continues to operate at a measuring accuracy of within \pm 20% of the range during tests):
 - EMI (emission), EN55011: Class A Group 1
 - EMS (immunity), EN50082-2: 1995

Construction, Installation, and Wiring

- Construction: Only the front panel is dust-proof and drip-proof (protection class IP55) For side-by-side close installation the controller loses its dust-proof and drip-proof protection.
- Material: ABS resin and polycarbonate
- Case color: Black
- Weight: About 1 kg or less
- Dimensions: 96 (W) × 96 (H) × 100 (depth from panel face) mm
- Installation: Panel-mounting type. With top and bottom mounting hardware (1 each)
- Panel cutout dimensions: $92_0^{+0.8}$ (W) × $92_0^{+0.8}$ (H) mm
- Installation position: Up to 30° upward facing (not designed for facing downward)
- Wiring: M3.5 screw terminals (for signal wiring and power/ground wiring as well)

Power Supply Specifications

- Power supply: Rated voltage of 100 to 240 V AC ($\pm 10\%$), 50/60 Hz
- Power consumption: Max. 20 VA (8.0 W max.)
- Data backup: Lithium cell with life expectancy of 10 years
- Withstanding voltage
 - Between primary terminals* and secondary terminals**:
At least 1500 V AC for 1 minute (Note)
 - Between primary terminals* and grounding terminal:
At least 1500 V AC for 1 minute (Note)
 - Between grounding terminal and secondary terminals**:
At least 1500 V AC for 1 minute
 - Between secondary terminals**:
At least 500 V AC for 1 minute
- * Primary terminals indicate power terminals and relay output terminals
- ** Secondary terminals indicate analog I/O signal, voltage pulse output, and contact input terminals

Note: The withstanding voltage is specified as 2300 V AC per minute to provide a margin of safety.

- Insulation resistance: 20 M Ω or more at 500 V DC between power terminals and grounding terminal
- Grounding: Class 3 grounding (grounding resistance of 100 Ω or less)

Signal Isolations

- Loop1 PV input terminals: Isolated from other input/output terminals. Not isolated from the internal circuit.
- Loop2 PV input terminals: Isolated from loop1 PV input terminals, other input/output terminals and internal circuit.
- Auxiliary analog input terminals: Isolated from other input/output terminals and the internal circuit.
- 15 V DC loop power supply terminals: Not isolated from analog current output and voltage pulse control output. Isolated from other input/output terminals and internal circuit.
- Analog output terminals (for control output and retransmission): Not isolated between analog outputs and from 15 V DC loop power supply and voltage pulse control output. Isolated from other input/output terminals and internal circuit.
- Voltage pulse control output terminals: Not isolated from analog outputs and 15 V DC loop power supply. Isolated from other input/output terminals and internal circuit.
- Relay contact control output terminals: Isolated between contact output terminals and from other input/output terminals and internal circuit.
- Contact input terminals: Not isolated between contact input terminals and from communication terminals. Isolated from other input/output terminals and internal circuit.
- Relay contact output terminals: Not isolated between relay contact outputs. Isolated from other input/output terminals and internal circuit.
- Transistor contact output terminals: Not isolated between transistor contact outputs. Isolated from other input/output terminals and internal circuit.
- RS-485 communication terminals: Not isolated from contact input terminals. Isolated from other input/output terminals and internal circuit.
- Power terminals: Isolated from other input/output terminals and internal circuit.
- Grounding terminals: Isolated from other input/output terminals and internal circuit.

Environmental Conditions

- Normal operating conditions:
 - Ambient temperature: 0 to 50°C (40°C or less for side-by-side close installation)
 - Temperature change rate: 10°C/h or less
 - Ambient humidity: 20 to 90% RH (no condensation allowed)
 - Magnetic field: 400 A/m or less
 - Continuous vibration at 5 to 14 Hz: Full amplitude of 1.2 mm or less
 - Continuous vibration at 14 to 150 Hz: 4.9 m/s² or less
 - Short-period vibration: 14.7 m/s², 15 seconds or less
 - Shock: 14.7 m/s² or less, 11 ms
 - Installation height: Height above sea level of 2000 m or less
 - Warm-up time: 30 minutes or more after power on
- Transportation and storage conditions:
 - Temperature: -25 to 70°C
 - Temperature change rate: 20°C/h or less
 - Humidity: 5 to 95% RH (no condensation allowed)
- Effects of changes in operating conditions
 - Effects from changes in ambient temperature:
 - On voltage or thermocouple input, $\pm 1 \mu\text{V}/^\circ\text{C}$ or $\pm 0.01\%$ of F.S./ $^\circ\text{C}$, whichever is larger
 - On auxiliary analog input, $\pm 0.02\%$ of F.S./ $^\circ\text{C}$
 - On RTD input, $\pm 0.05^\circ\text{C}/^\circ\text{C}$ (ambient temperature) or less
 - On analog output, $\pm 0.05\%$ of F.S./ $^\circ\text{C}$ or less
 - Effects from power supply fluctuation (within rated voltage range)
 - On remote input, $\pm 1 \mu\text{V}/10 \text{ V}$ or $\pm 0.01\%$ of F.S./10 V, whichever is larger
 - On analog output, $\pm 0.05\%$ of F.S./10 V or less

1.5 Terminal Wiring Diagrams



NOTE

Do not use unassigned terminals as relay terminals.

Terminal wiring diagrams are shown on and after the next page.

UP750 Dual-loop Control (Model UP750-5□)

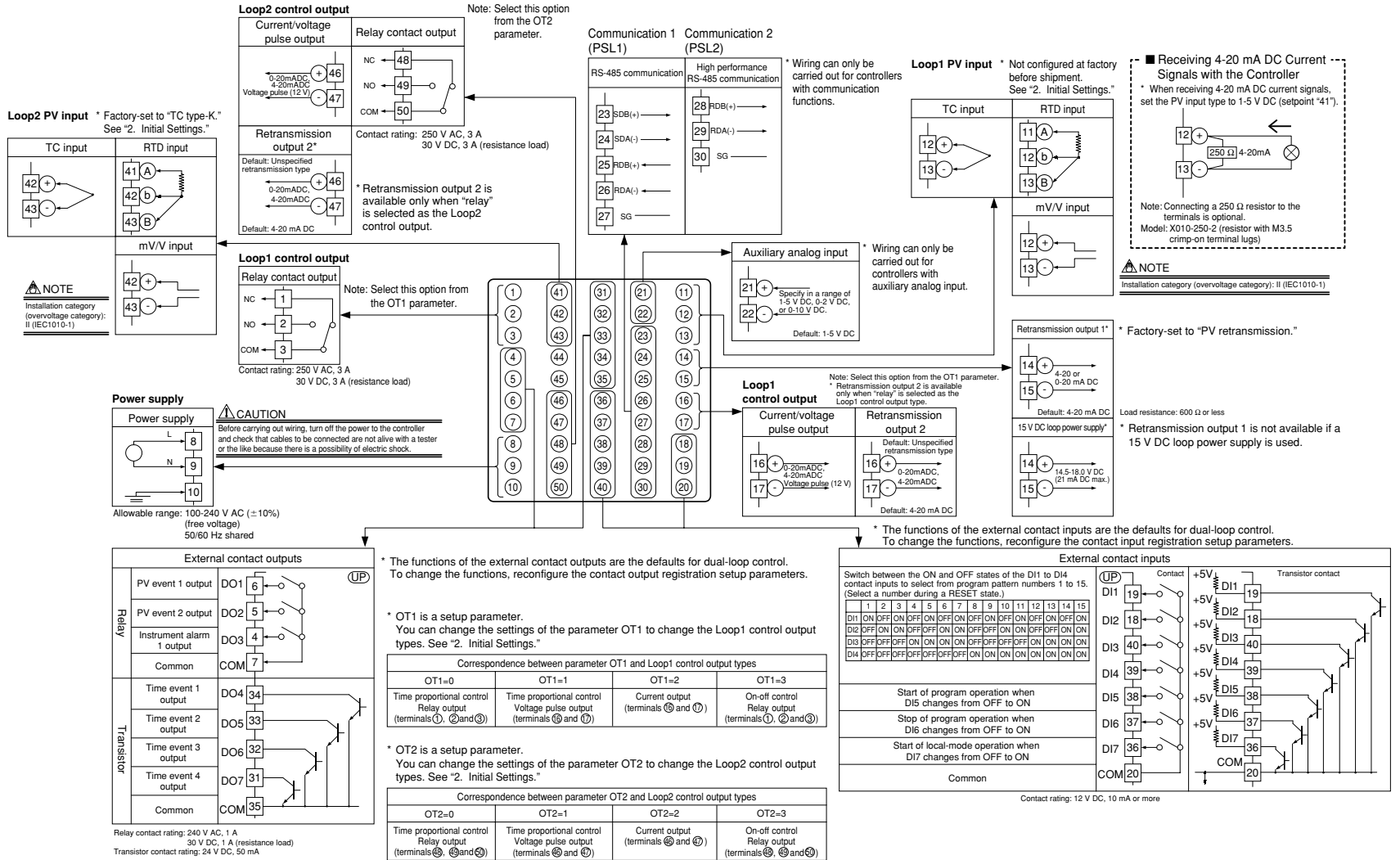

UP750 Dual-loop Heating/Cooling Control (Model UP750-5□)

IMPORTANT
Change the setting of the control output type (OT1 and OT2) parameters to the Heating/Cooling Control.

Loop2 PV input * Factory-set to "TC type-K." See "2. Initial Settings."

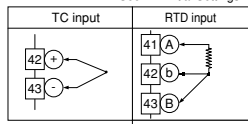

NOTE
Installation category (overvoltage category): II (IEC1010-1)

Loop2 heating-side control output

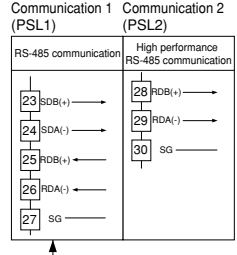
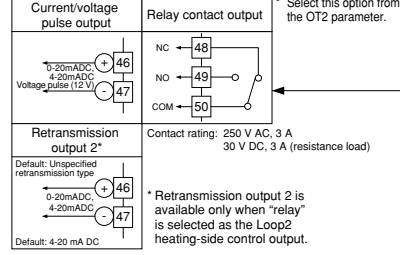

Loop1 PV input * Not configured at factory before shipment. See "2. Initial Settings."

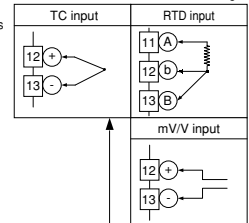

Receiving 4-20 mA DC Current Signals with the Controller
* When receiving 4-20 mA DC current signals, set the PV input type to 1-5 V DC (setpoint "41").

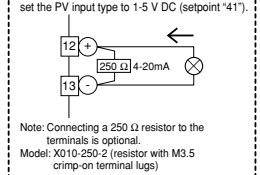

NOTE
Installation category (overvoltage category): II (IEC1010-1)

Power supply

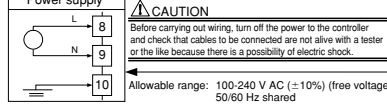

CAUTION
Before carrying out wiring, turn off the power to the controller and check that cables to be connected are not alive with a tester or the like because there is a possibility of electric shock.
Allowable range: 100-240 V AC (±10%) (free voltage) 50/60 Hz shared

Loop1 heating-side control output

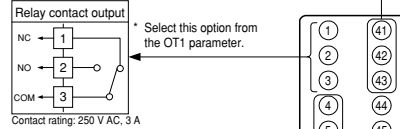

Auxiliary analog input * Wiring can only be carried out for controllers with auxiliary analog input. Specify in a range of 1-5 V DC, 0-2 V DC, or 0-10 V DC. Default: 1-5 V DC

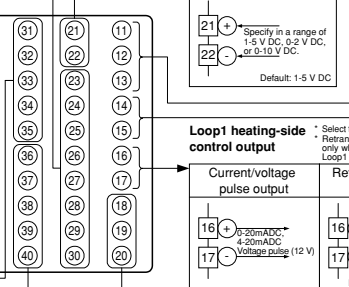

Loop1 heating-side control output

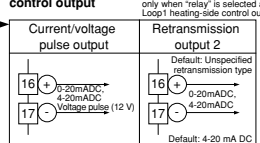

* Factory-set to "PV retransmission."

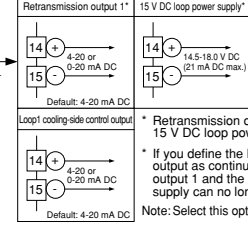

External contact outputs

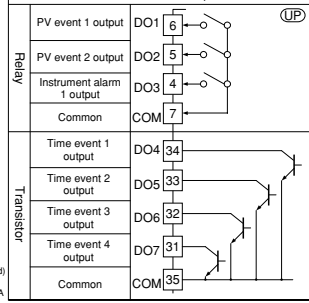

The functions of the external contact outputs are the defaults for dual-loop heating/cooling control. To change the functions, reconfigure the contact output registration setup parameters.
Note 1: If you define the DO2 as the cooling-side control output, the DO5 serves as the Loop2 alarm 1 output. Inversely, if you define the DO5 as the Loop2 cooling-side control output, the DO2 serves as the Loop1 alarm 2 output.
Note 2: If you define the DO3 as the Loop1 cooling-side control output, the DO3 serves as the Loop1 alarm 3 output. Inversely, if you define the DO4 as the Loop1 cooling-side control output is the current, the DO3 serves as the Loop1 alarm 3 output, and the DO4 serves as the Loop1 alarm 4 output.
* Loop1: Select from the OT1 parameter.
Loop2: Select from the OT2 parameter.

The functions of the external contact inputs are the defaults for dual-loop heating/cooling control. To change the functions, reconfigure the contact input registration setup parameters.

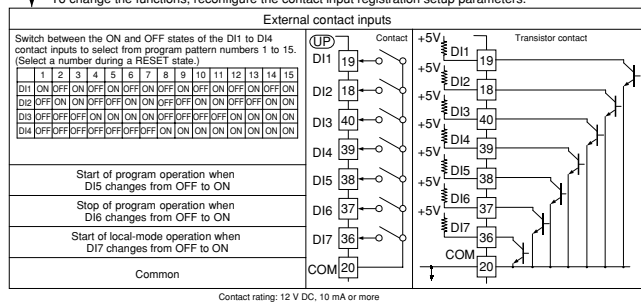

* OT1 is a setup parameter. You can change the settings of the parameter OT1 to change the Loop1 control output types. See "2. Initial Settings."

Correspondence between parameter OT1 and heating-side output types/cooling-side output types of Loop1								
OT1=4	OT1=5	OT1=6	OT1=7	OT1=8	OT1=9	OT1=10	OT1=11	OT1=12
Heating side: Relay output (terminals ①, ② and ③) Cooling side: Relay output (terminals ④ and ⑦)	Heating side: Voltage pulse output (terminals ① and ⑦) Cooling side: Relay output (terminals ④ and ⑦)	Heating side: Current output (terminals ① and ⑦) Cooling side: Relay output (terminals ④ and ⑦)	Heating side: Relay output (terminals ①, ② and ③) Cooling side: Transistor output (terminals ④ and ⑦)	Heating side: Voltage pulse output (terminals ① and ⑦) Cooling side: Transistor output (terminals ④ and ⑦)	Heating side: Current output (terminals ① and ⑦) Cooling side: Transistor output (terminals ④ and ⑦)	Heating side: Relay output (terminals ①, ② and ③) Cooling side: Current output (terminals ④ and ⑦)	Heating side: Voltage pulse output (terminals ① and ⑦) Cooling side: Current output (terminals ④ and ⑦)	Heating side: Current output (terminals ① and ⑦) Cooling side: Current output (terminals ④ and ⑦)

* OT2 is a setup parameter. You can change the settings of the parameter OT2 to change the Loop2 control output types. See "2. Initial Settings."

Correspondence between parameter OT2 and heating-side output types/cooling-side output types of Loop2					
OT2=4	OT2=5	OT2=6	OT2=7	OT2=8	OT2=9
Heating side: Relay output (terminals ①, ② and ③) Cooling side: Relay output (terminals ④ and ⑦)	Heating side: Voltage pulse output (terminals ① and ⑦) Cooling side: Relay output (terminals ④ and ⑦)	Heating side: Current output (terminals ① and ⑦) Cooling side: Relay output (terminals ④ and ⑦)	Heating side: Relay output (terminals ①, ② and ③) Cooling side: Transistor output (terminals ④ and ⑦)	Heating side: Voltage pulse output (terminals ① and ⑦) Cooling side: Transistor output (terminals ④ and ⑦)	Heating side: Current output (terminals ① and ⑦) Cooling side: Transistor output (terminals ④ and ⑦)

Blank Page

2. Initial Settings

This chapter describes examples of setting PV input types, control output types. Carrying out settings described herein allows you to perform basic control. Refer to examples of various settings to understand how to set parameters required. Refer to “6.1 Parameter Map” for an easy to understand explanation of setting various parameters. If you cannot remember how to carry out an operation during setting, press the **[DISP]** key no more than four times. This brings you to the display (operating display) that appears at power-on. After carrying out the settings described here, create programs in “3. Programming.”

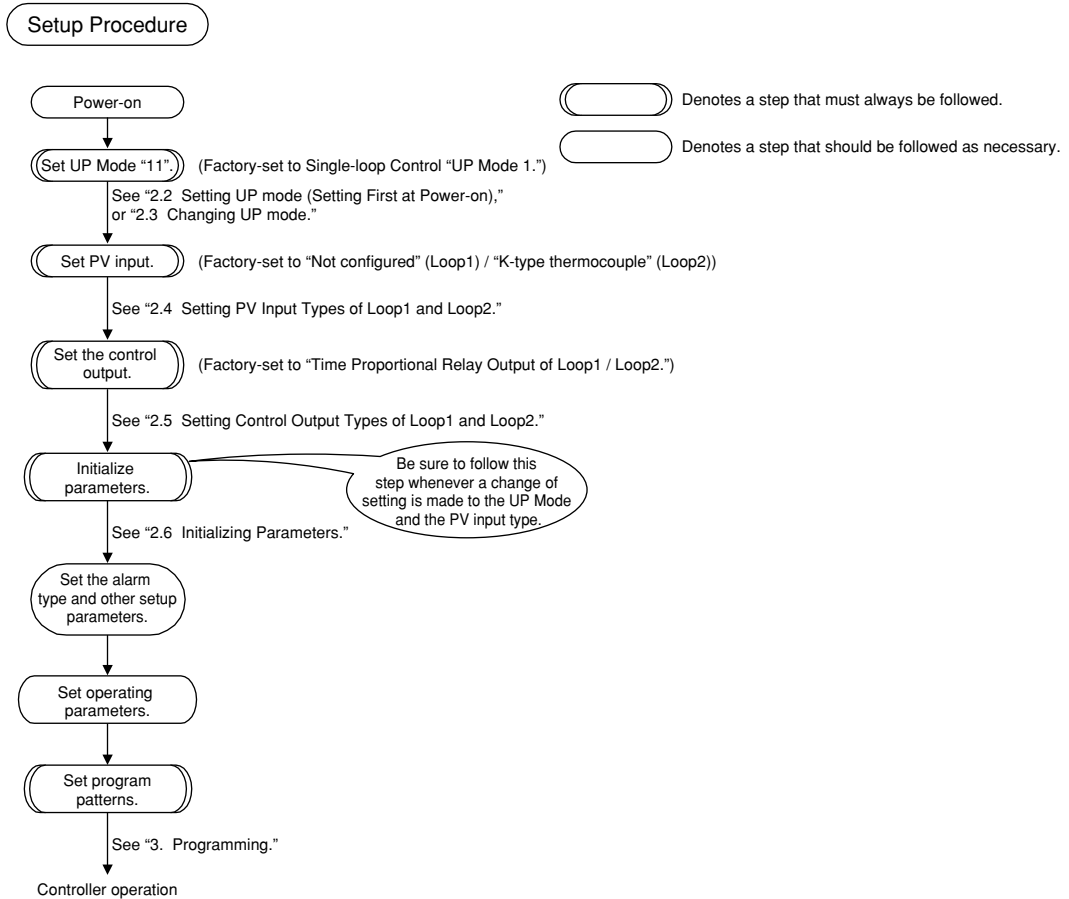

2.1 Names and Functions of Front Panel Parts

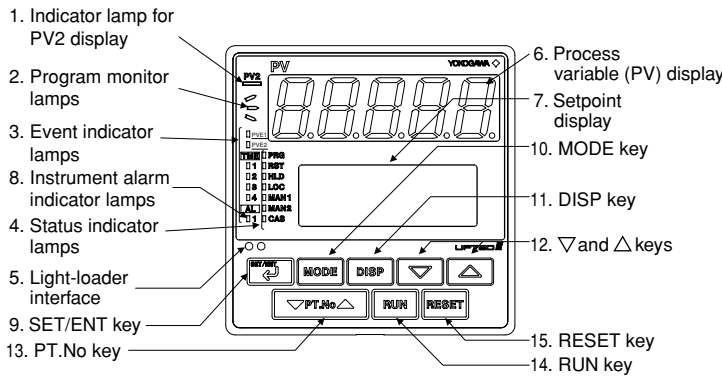

Name of Part	Function
1. Indicator lamp for PV2 display	Is lit when Loop2 PV is displayed on PV display.
2. Program monitor lamps	<ul style="list-style-type: none"> ↗ : Is lit (in green) when a program setpoint is increasing. ↔ : Is lit (in green) when a program setpoint is constant. ↘ : Is lit (in green) when a program setpoint is decreasing.
3. Event indicator lamps	Display the statuses of PV events, time events and instrument alarms in orange. PVE1 and PVE2 lamps: Come on when PV event 1 and PV event 2 turn on. TME1 to TME4 lamps: Come on when time event 1 to time event 4 turn on. AL1 lamp: Comes on when instrument alarm 1 turns on.
4. Status indicator lamps	Is lit (in green) to indicate the status of operation or control. PRG: Is lit when in program mode. RST: Is lit when in reset mode. HLD: Is lit when in hold mode. LOC: Is lit when in local mode. MAN1: Is lit when in manual mode of Loop2. MAN2: Is lit when in manual mode of Loop2. CAS: Not used in dual-loop control.
5. Light-loader interface	Interface for an adapter cable used when setting and storing parameters from a PC. This requires an optional parameter setting tool.
6. Process variable (PV) display	Displays PV. Displays an error code (in red) if an error occurs.
7. Setpoint display (LCD)	Displays the name and value of a target setpoint (SP), output (OUT), deviation trend, or a parameter. Displays an error code if an error occurs.
8. Instrument alarm indicator lamps	The AL1 lamp comes on in orange if instrument alarm 1 turns on.
9. SET/ENT key	Used to switch or register a parameter. Pressing the key for more than 3 seconds allows you to switch between the operating display and the main menu for operating parameter setting display alternately.
10. MODE key	Presents a display for switching between the hold, advance, local, AUTO and MAN modes.
11. DISP key	Used to switch between displays. Pressing this key while any operating display is shown lets you switch to another prearranged operating display. Pressing this key while any display other than an operating display is shown lets you go one display back. (One to four presses (maximum) of this key lets you return to the current operating display, though the number of presses depends on the operating status.)
12. Up and Down arrow keys	Used to change numerical values. On setting displays for various parameters, you can change target setpoints, parameters, and output values (in manual operation). Pressing the ↓ key decreases a numerical value, while pressing the ↑ key causes it to increase. You can hold down a key to gradually increase the speed of change. These keys also switch between menu displays when a main menu or submenu of parameter setting display is shown.
13. PT.No key	Use this key when the controller is at a stop to select a program pattern number on an operating display.
14. RUN key	Pressing this key for more than 2 seconds while an operating display is shown starts the controller.
15. RESET key	Pressing this key for more than 2 seconds while an operating display is shown stops the controller.

2.2 Setting UP mode (Setting First at Power-on)

NOTE

The controller displays an operating display when the power is turned on. The submenu "IN" appears at this point if the type of PV input has not been defined yet. In this case, first set a UP mode to "Dual-loop Control" following the operating procedure described below. Then, PV input type, control output type and others.

The following operation describes a procedure of setting a UP mode to "Dual-loop Control." (set "11")

1. Display view at power on

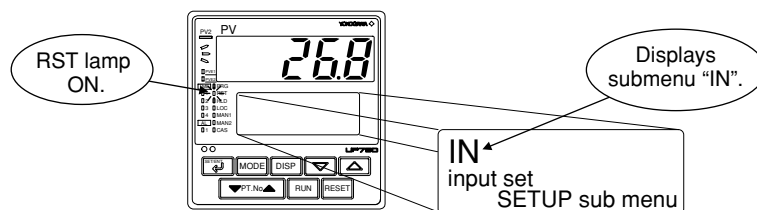

In steps 2 and later, illustrations of the LCD are cited to explain the procedure.

2. Press the key once to display the submenu "MD".

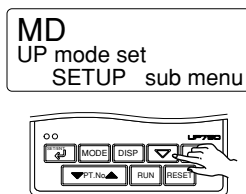

3. Press the key once to display the parameter "UPM" (controller mode).

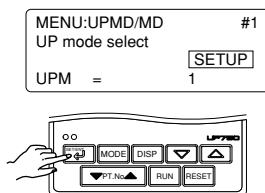

4. Press the or key to display the setpoint "11".

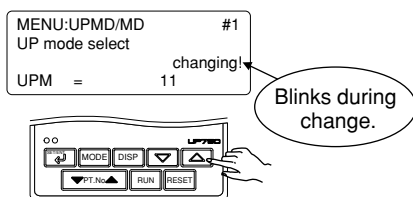

5. Press the key once to register the setpoint.

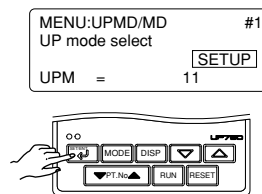

6. The controller re-starts (which is normal). Then, set PV input type. See "2.4 Setting PV Input Types of Loop1 and Loop2."

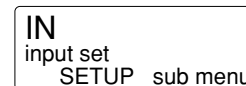

2.3 Changing UP mode

The following operation describes a procedure of changing a UP mode to “Dual-loop Control.” (set “11”)

1. Bring the operating display into view (display appears at power-on).

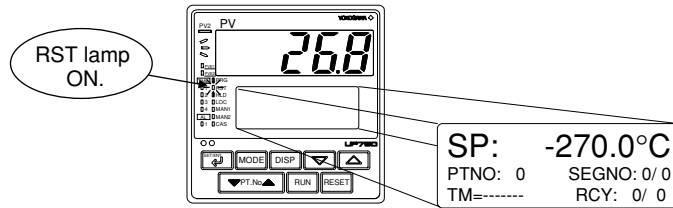

In steps 2 and later, illustrations of the LCD are cited to explain the procedure.

2. Press the key for more than 3 seconds to call up the main menu “PROG”.

PROG
programming
main menu

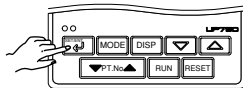

3. Press the key once to display the main menu “STUP”.

STUP
password input
main menu

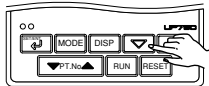

4. Press the key once to display the setup parameter main menu “PARA”.

PARA
setup parameter
SETUP main menu

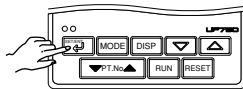

5. Press the key once to display the setup parameter main menu “UPMD”.

UPMD
UP750 configuration
SETUP main menu

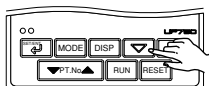

6. Press the key once to display the setup parameter submenu “MD”.

MD
UP mode set
SETUP sub menu

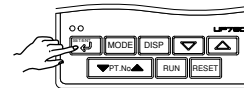

7. Press the key once to display the parameter “UPM” (controller mode).

MENU:UPMD/MD #1
UP mode select
UPM = 1

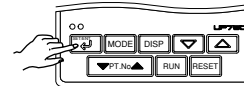

8. Press the or key to display the set-point “11”.

MENU:UPMD/MD #1
UP mode select
UPM = 11

Blinks during change.

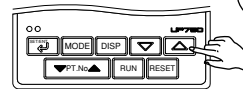

9. Press the  key once to register the setpoint.

```
MENU:UPMD/MD #1
UP mode select
UPM = 11
```

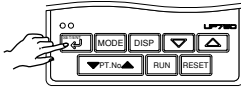

10. The controller re-starts (which is normal). Then, set PV input type. See “2.4 Setting PV Input Types of Loop1 and Loop2.”

```
IN
input set
SETUP sub menu
```



How to return to a menu

Press the  key once during parameter setting. This lets you return to the parameter menu.

2.4 Setting PV Input Types of Loop1 and Loop2

The following operating procedure describes an example of setting the PV input type of Loop1 to K-type thermocouple (-200.0 to 500.0°C) and a measurement range of 0.0 to 200.0°C.

You can take the same steps for the PV input type (IN2) and ranges (RH2, RL2) or scales (SH2, SL2) of Loop2 that are displayed after the Loop1 related parameters.

PV input of Loop1 (Factory-set to “Not configured”)

PV input terminal	
Thermocouple/mV/V input.....	⑫-⑬
RTD input	⑪-⑫-⑬

PV input of Loop2 (Factory-set to “K-type thermocouple”)

PV input terminal	
Thermocouple/mV/V input.....	⑫-⑬
RTD input	⑪-⑫-⑬

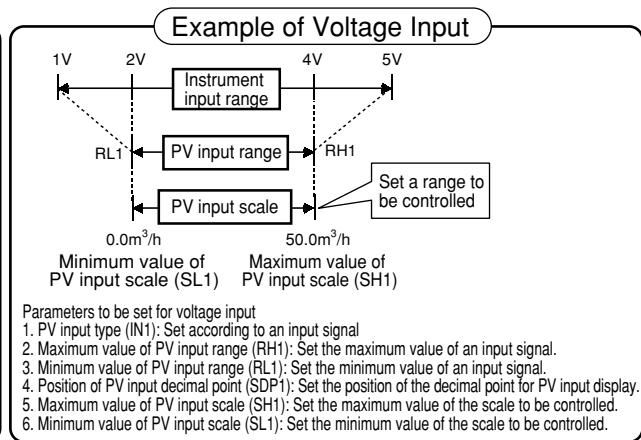
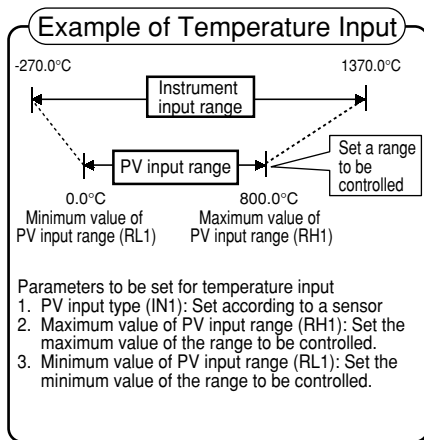

NOTE

The controller may automatically initialize the registered operating parameter setpoints if any change is made to the data item PV Input Type (IN1, IN2), Maximum Value of PV Input Range (RH1, RH2), Minimum Value of PV Input Range (RL1, RL2), PV Input Decimal Point Position (SDP1, SDP2), Maximum Value of PV Input Scale (SH1, SH2) or Minimum Value of PV Input Scale (SL1, SL2). After a change has been made to any of these data items, be sure to verify the registered operating parameter setpoints to ensure that they are correct. If any data item has been changed to its default, set it to a required value.

1. Bring the operating display into view (display appears at power-on).

The PV display in the figure below shows the error code for input burnout (*boUt*) if PV input wiring is not yet complete. The error code disappears when you wire the PV input terminals correctly.

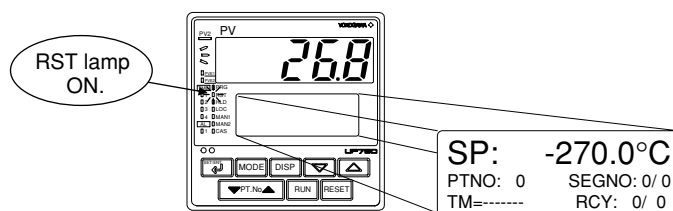

In steps 2 and later, illustrations of the LCD are cited to explain the procedure.

- 2. Press the  key for more than 3 seconds to call up the main menu "PROG".

PROG
programming
main menu

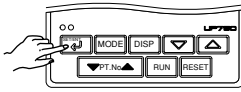

- 3. Press the  key once to display the main menu "STUP".

STUP
password input
main menu

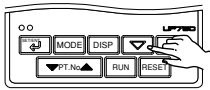

- 4. Press the  key once to display the main menu "PARA".

PARA
setup parameter
SETUP main menu

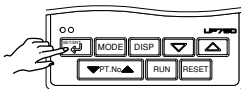

- 5. Press the  key once to display the main menu "UPMD".

UPMD
UP750 configuration
SETUP main menu

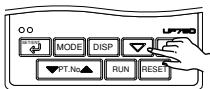

- 6. Press the  key once to display the submenu "MD".

MD
UP mode set
SETUP sub menu

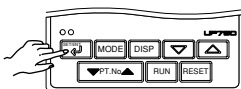

- 7. Press the  key once to display the submenu "IN".

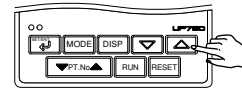

IN
input set
SETUP sub menu

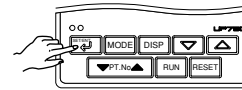

- 8. Press the  key once to display the parameter "IN1" (PV input type of Loop1).

MENU:UPMD/IN #1
input 1 type select
IN1 = OFF



- 9. Press the  or  key to display the required setpoint. The figure below shows an example of setting the PV input type to a K-type thermocouple (-200.0°C to 500.0°C).

MENU:UPMD/IN #1
input 1 type select
IN1 = typeK3

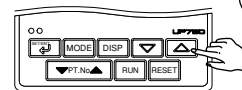

Blinks during change.

- 10. Press the  key once to register the setpoint.

MENU:UPMD/IN #1
input 1 type select
IN1 = typeK3

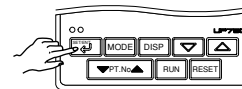

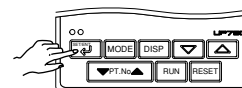

- 11. Press the  key once to display the parameter "UNI1".

MENU:UPMD/IN #2
input 1 unit select
UNI1 = °C

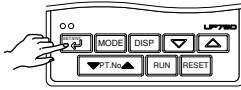
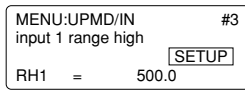

- 12. Press the  key once to display the parameter "RH1" (maximum value of PV input range of Loop1).



- 13. Press the  or  key to display the required setpoint. The figure below shows an example of setting the maximum value of the PV input range to 200.0°C.

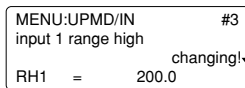

Blinks during change.

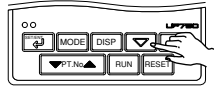

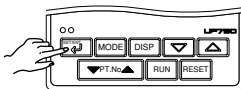
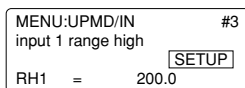

- 14. Press the  key once to register the setpoint.

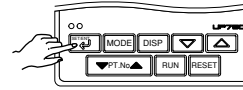
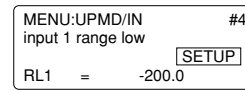

- 15. Press the  key once to display the parameter "RL1" (minimum value of PV input range of Loop1).



- 16. Press the  or  key to display the required setpoint. The figure below shows an example of setting the minimum value of the PV input range to 0.0°C.

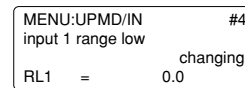

Blinks during change.

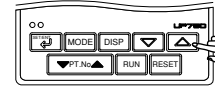

- 17. Press the  key once to register the setpoint.

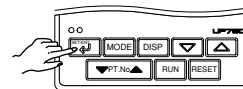
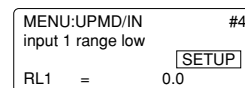

If the type of Input is voltage, also configure the PV Input Decimal Point Position of Loop1 (SDP1), Maximum Value of PV Input Scale of Loop1 (SH1) and Minimum Value of PV Input Scale of Loop1 (SL1) parameters that are displayed after this.

- 18. Press the  key for more than 3 seconds. This returns you to the display shown at power-on (figure below).

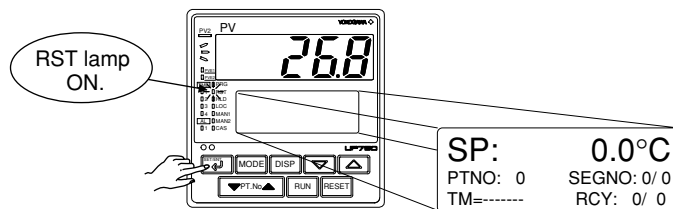

Instrument Input Range Codes

Input	Type	Instrument Input Range Code	Instrument Input Range	Measurement Accuracy
Unspecified		OFF (0)	Set the data item PV Input Type "IN1" to the OFF option to leave the PV input type undefined.	
Thermocouple	K	typeK1 (1)	-270.0 to 1370.0°C -450.0 to 2500.0°F	±0.1% of instrument range ±1 digit at 0°C or more ±0.2% ±1 digit for temperatures below 0°C, where the accuracy is: ±2% of instrument range ±1 digit for temperatures below -200.0°C for a type-K thermocouple, or ±1% of instrument range ±1 digit for temperatures below -200.0°C for a type-T thermocouple. ±0.15% of instrument range ±1 digit at 400°C or more ±5% of instrument range ±1 digit at less than 400°C ±0.15% of instrument range ±1 digit ±0.1% of instrument range ±1 digit ±0.25% of instrument range ±1 digit for temperatures below 0°C ±0.1% of instrument range ±1 digit at 0°C or more ±0.2% ±1 digit for temperatures below 0°C, where the accuracy is: ±1.5% of instrument range ±1 digit for temperatures below -200.0°C for a type-E thermocouple. ±0.2% of instrument range ±1 digit ±0.1% of instrument range ±1 digit ±0.5% of instrument range ±1 digit at 800°C or more No accuracy is guaranteed at less than 800°C ±0.2% of instrument range ±1 digit ±0.1% of instrument range ±1 digit (Note 1) (Note 2) ±0.2% of instrument range ±1 digit (Note 1) ±0.1% of instrument range ±1 digit (Note 1) (Note 2) ±0.2% of instrument range ±1 digit (Note 1) ±0.1% of instrument range ±1 digit Display range is scalable in a range of -19999 to 30000. Display span is 30000 or less.
		typeK2 (2)	-270.0 to 1000.0°C -450.0 to 2300.0°F	
		typeK3 (3)	-200.0 to 500.0°C -200.0 to 1000.0°F	
	J	typeJ (4)	-200.0 to 1200.0°C -300.0 to 2300.0°F	
	T	typeT1 (5)	-270.0 to 400.0°C -450.0 to 750.0°F	
		typeT2 (6)	0.0 to 400.0°C -200.0 to 750.0°F	
	B	typeB (7)	0.0 to 1800.0°C 32 to 3300°F	
	S	typeS (8)	0.0 to 1700.0°C 32 to 3100°F	
	R	typeR (9)	0.0 to 1700.0°C 32 to 3100°F	
	N	typeN (10)	-200.0 to 1300.0°C -300.0 to 2400.0°F	
	E	typeE (11)	-270.0 to 1000.0°C -450.0 to 1800.0°F	
	L(DIN)	typeL (12)	-200.0 to 900.0°C -300.0 to 1600.0°F	
	U(DIN)	typeU1 (13)	-200.0 to 400.0°C -300.0 to 750.0°F	
		typeU2 (14)	0.0 to 400.0°C -200.0 to 1000.0°F	
	W	typeW (15)	0.0 to 2300.0°C 32 to 4200°F	
	Platinel 2	Plati2 (16)	0.0 to 1390.0°C 32 to 2500.0°F	
	PR20-40	PR2040 (17)	0.0 to 1900.0°C 32 to 3400°F	
	W97Re3-W75Re25	W97Re3 (18)	0.0 to 2000.0°C 32 to 3600°F	
RTD	JPt100	JPt1 (30)	-200.0 to 500.0°C -300.0 to 1000.0°F	
		JPt2 (31)	-150.00 to 150.00°C -200.0 to 300.0°F	
	Pt100	Pt1 (35)	-200.0 to 850.0°C -300.0 to 1560.0°F	
		Pt2 (36)	-200.0 to 500.0°C -300.0 to 1000.0°F	
		Pt3 (37)	-150.00 to 150.00°C -200.0 to 300.0°F	
Standard signal	0.4 to 2 V	0.4 to 2 V (40)	0.400 to 2.000 V	
	1 to 5 V	1 to 5 V (41)	1.000 to 5.000 V	
DC voltage	0 to 2 V	0 to 2 V (50)	0.000 to 2.000 V	
	0 to 10 V	0 to 10 V (51)	0.00 to 10.00 V	
	0.00 to 1.25 V (Note 3)	0.00 to 1.25 V (52)	0.000 to 1.200 V	
	-10 to 20 mV	mV1 (55)	-10.00 to 20.00 mV	
	0 to 100 mV	mV2 (56)	0.0 to 100.0 mV	

Numbers in () are the setting value that apply when the communication is used.

* Performance in the standard operating conditions (at 23±2°C, 55±10%RH, and 50/60 Hz power frequency)

Note 1: The accuracy is ±0.3°C of instrument range ±1 digit for a temperature range from 0°C to 100°C.

Note 2: The accuracy is ±0.5°C of instrument range ±1 digit for a temperature range from -100°C to 200°C.

Note 3: Only used for PV input of Loop2 (IN2).

* To receive a 4-20 mA DC signal, select a standard signal of 1 to 5 V DC and connect it to a 250 Ω resistor. This resistor is optional.

Model: X010-250-2 (resistor with M3.5 crimp-on terminal lugs)

2.5 Setting Control Output Types of Loop1 and Loop2

The following operating procedure describes an example of changing the control output type of Loop1 from time proportional PID relay output (0: factory-set default) to current output (2).

You can take the same steps for the control output type of Loop2 (OT2) that is displayed after the control output type of Loop1.

Control output of Loop1

Control output terminal	Values in parentheses are setpoints
Time proportional PID relay (0)/on-off(3) output.....	①-②-③
Current (2)/time proportional PID voltage pulse (1) output.....	⑯-⑰

For details on the output terminals for heating/cooling control, see "1.5 Terminal Wiring Diagrams."

Control output of Loop2

Control output terminal	Values in parentheses are setpoints
Time proportional PID relay (0)/on-off(3) output.....	④⑧-④⑨-⑤⑩
Current (2)/time proportional PID voltage pulse (1) output.....	④⑥-④⑷

For details on the output terminals for heating/cooling control, see "1.5 Terminal Wiring Diagrams."

1. Bring the operating display into view (display appears at power-on).

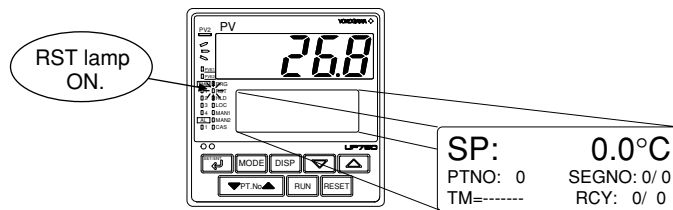

In steps 2 and later, illustrations of the LCD are cited to explain the procedure.

2. Press the key for more than 3 seconds to call up the main menu "PROG".

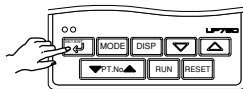

4. Press the key once to display the main menu "PARA".

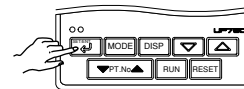
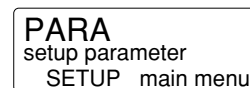

3. Press the key once to display the main menu "STUP".

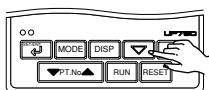
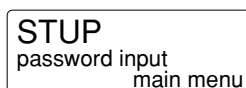

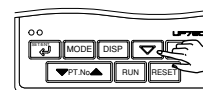
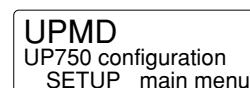

5. Press the key once to display the main menu "UPMD".

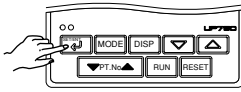

- 6. Press the  key once to display the submenu "MD".

MD
UP mode set
SETUP sub menu



- 7. Press the  key twice to display the submenu "OUT".

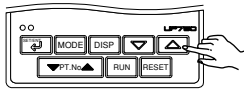

OUT
output set
SETUP sub menu

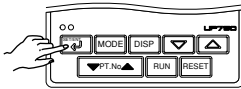

- 8. Press the  key once to display the parameter "OT1" (control output type of Loop1).

MENU:UPMD/OUT #1
output 1 select
OT1 = 0



- 9. Press the  or  key to display the required setpoint. The figure below shows an example of setting to current output (4 to 20 mA DC).

MENU:UPMD/OUT #1
output 1 select
OT1 = 2

Blinks during change.

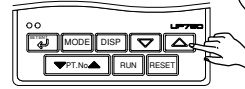

- 10. Press the  key once to register the setpoint.

MENU:UPMD/OUT #1
output 1 select
OT1 = 2

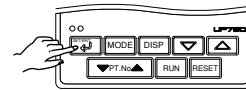

You can take the same steps for the control output type of Loop2 (OT2) that is displayed after the control output type of Loop1.

- 11. Press the  key for more than 3 seconds. This returns you to the display shown at power-on (figure below).

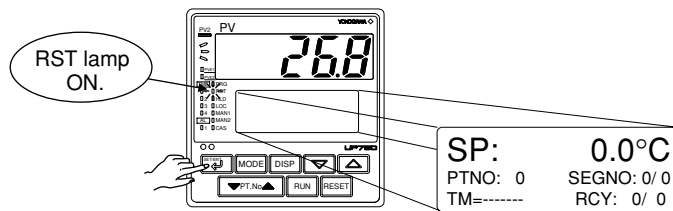

● List of Control Output Types of Loop1

Parameter Symbol	Name of Parameter	Setpoint	Control Output Types
OT1	Loop1 Control output type	0	Time proportional PID relay contact output (terminals ①-②-③)
		1	Time proportional PID voltage pulse output (terminals ⑯-⑰)
		2	Current output (terminals ⑯-⑰)
		3	On/off control relay contact output (terminals ①-②-③)
		4	Heating-side relay output (terminals ①-②-③), cooling-side relay output (terminals ④-⑦)
		5	Heating-side pulse output (terminals ⑯-⑰), cooling-side relay output (terminals ④-⑦)
		6	Heating-side current output (terminals ⑯-⑰), cooling-side relay output (terminals ④-⑦)
		7	Heating-side relay output (terminals ①-②-③), cooling-side transistor output (terminals ⑳-㉓)
		8	Heating-side pulse output (terminals ⑯-⑰), cooling-side transistor output (terminals ⑳-㉓)
		9	Heating-side current output (terminals ⑯-⑰), cooling-side transistor output (terminals ⑳-㉓)
		10	Heating-side relay output (terminals ①-②-③), cooling-side current output (terminals ⑭-⑮)
		11	Heating-side pulse output (terminals ⑯-⑰), cooling-side current output (terminals ⑭-⑮)
		12	Heating-side current output (terminals ⑯-⑰), cooling-side current output (terminals ⑭-⑮)

● List of Control Output Types of Loop2

Parameter Symbol	Name of Parameter	Setpoint	Control Output Types
OT2	Loop2 Control output type	0	Time proportional PID relay contact output (terminals ⑳-㉓)
		1	Time proportional PID voltage pulse output (terminals ⑯-⑰)
		2	Current output (terminals ⑯-⑰)
		3	On/off control relay contact output (terminals ⑳-㉓)
		4	Heating-side relay output (terminals ⑳-㉓-㉖), cooling-side relay output (terminals ⑤-⑦)
		5	Heating-side pulse output (terminals ⑯-⑰), cooling-side relay output (terminals ⑤-⑦)
		6	Heating-side current output (terminals ⑯-⑰), cooling-side relay output (terminals ⑤-⑦)
		7	Heating-side relay output (terminals ⑳-㉓-㉖), cooling-side transistor output (terminals ㉔-㉗)
		8	Heating-side pulse output (terminals ⑯-⑰), cooling-side transistor output (terminals ㉔-㉗)
		9	Heating-side current output (terminals ⑯-⑰), cooling-side transistor output (terminals ㉔-㉗)

2.6 Initializing Parameters

Be sure to follow the steps below after a change of setting has been made to the data item PV Input Type, PV Input Range or PV Input Scale.

1. Bring the operating display into view (display appears at power-on).

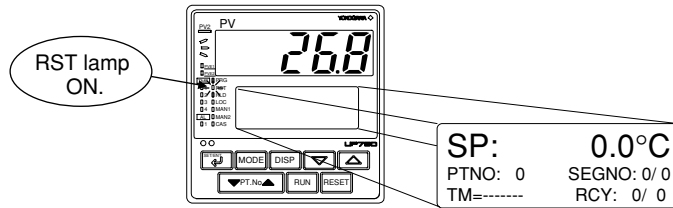

In steps 2 and later, illustrations of the LCD are cited to explain the procedure.

2. Press the key for more than 3 seconds to call up the main menu "PROG".

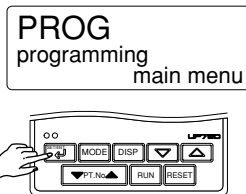

3. Press the key once to display the main menu "STUP".

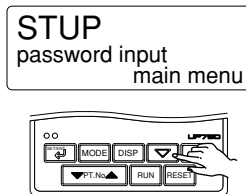

4. Press the key once to display the main menu "PARA".

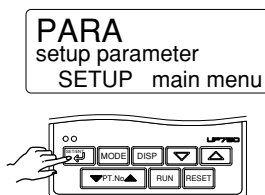

5. Press the key once to display the main menu "UPMD".

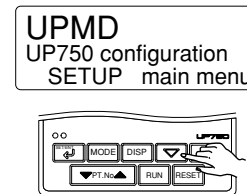

6. Press the key once to display the submenu "MD".

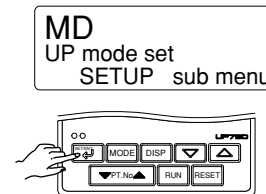

7. Press the key twice to display the submenu "INIT".

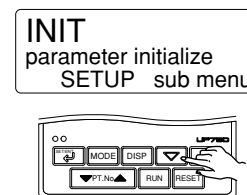

8. Press the  key once to display the parameter "INI".

```
MENU:UPMD/INIT #1
parameter initialize
INI = OFF
```

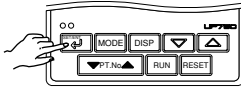

9. Press the  key to display "ON".

```
MENU:UPMD/INIT #1
parameter initialize
INI = ON
```

changing!
Blinks during change.

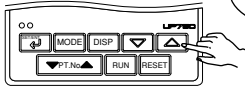

10. Press the  key once. The display momentarily becomes blank (which is normal), indicating the parameters have been initialized.

```
MENU:UPMD/INIT #1
parameter initialize
INI = ON
```

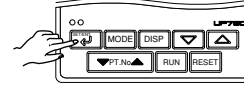

11. Press the  key for more than 3 seconds. This returns you to the display shown at power-on (figure below).

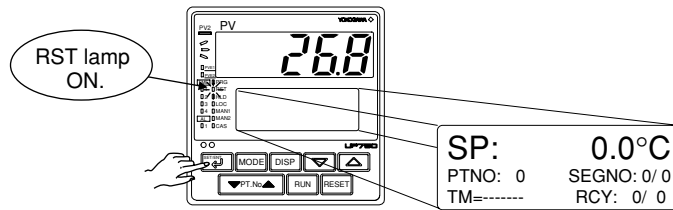

3. Programming

This chapter explains how to create programs by citing specific examples. Create user programs by referring to the given programming examples. Use the parameter map included in “3.5 Program Parameter Map,” in order to further familiarize yourself with the required operations.

Be sure to carry out the settings instructed in “2. Initial Settings” before beginning any of the tasks discussed in this chapter.

3.1 Overview of Program Patterns

■ Programming Overview

The programming example given here demonstrates how to do the tasks outlined below.

1. Program the controller to start program operation of Loop1 at 25°C and raise the temperature up to 80°C in 20 minutes. And program the controller to start program operation of Loop2 at 0°C and raise the temperature up to 60°C in 20 minutes.
2. When the temperature of Loop1 reaches 80°C, keep it at this level for 80 minutes. And when the temperature of Loop2 reaches 60°C, keep it at this level for 80 minutes.
3. Finally, Loop1 and Loop2 lower the temperature to 0°C in 10 minutes.

Event output

- Set a deviation of 5°C on both the positive and negative sides of a program setpoint to allow the controller to output of Loop1 an event signal if the temperature goes beyond the deviation range.
- Let the controller output of Loop1 an event signal when the temperature stabilizes to 80°C.

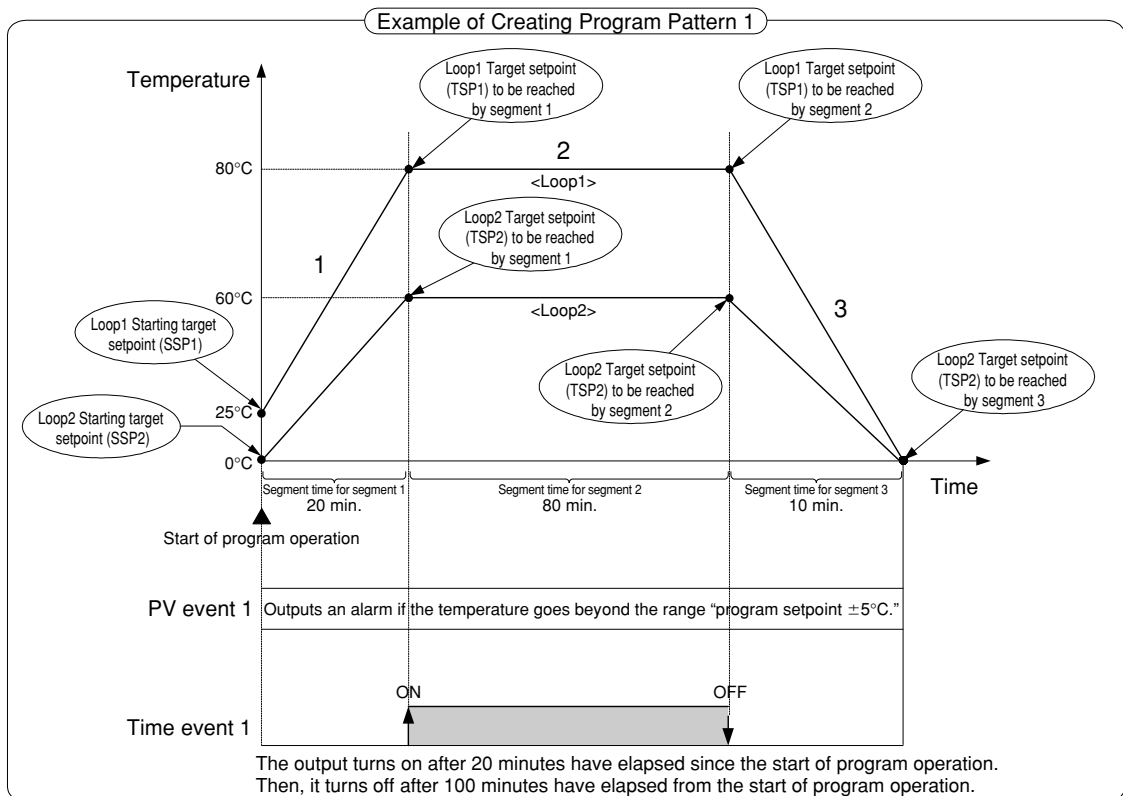

3.2 Example of Program Pattern Setup Charts

Complete the following setup chart before setting programs in the controller. Filling in the chart makes it easier for you to input program data into the controller. See “3.7 Program Pattern Setup Charts.”

In the following chart, fill in the fields with bold-face borders.

1. Maximum value of PV input range: Setpoint of the “Maximum Value of PV Input Loop1 and Loop2 Range (RH1, RH2)” setup parameter
2. Minimum value of PV input range: Setpoint of the “Minimum Value of PV Input Loop1 and Loop2 Range (RL1, RL2)” setup parameter
3. PV input unit: Setpoint of the “PV Input Unit (UNI1)” setup parameter
4. Program time unit: Setpoint of the “Program Time Unit (TMU)” setup parameter
5. Segment setting method: Setpoint of the “Segment Setting Method (SEG.T)” setup parameter
6. Starting target setpoint: Setpoint of the “Starting Target Setpoint (SSP1, SSP2)” program parameter of Loop1 and Loop2
7. Start code: Setpoint of the “Start Code (STC)” program parameter
8. Final target setpoint, Segment time, Events (PV event and Time event) and Junction code: Setpoint of each program parameter
9. Draw the program pattern.

Program time unit (TMU)	4 Hour, minute
Segment setting method (SEG.T)	5 Time setting

Starting target setpoint 1 (SSP1)	6 25°C	← Loop1
Starting target setpoint 2 (SSP2)	6 0°C	← Loop2
Start code (STC)	7 0	
1st group of wait zones (1.WZ1)		} See User's Manual (Reference) (CD-ROM version) for more information.
1st group of wait times (1.WTM)		
2nd group of wait zones (2.WZ1)		
2nd group of wait times (2.WTM)		
3rd group of wait zones (3.WZ1)		
3rd group of wait times (3.WTM)		
4th group of wait zones (4.WZ1)		
4th group of wait times (4.WTM)		
5th group of wait zones (5.WZ1)		
5th group of wait times (5.WTM)		
Number of repetitions (RCY)		
Start-of-repetition segment number (RST)		
End-of-repetition segment number (REN)		

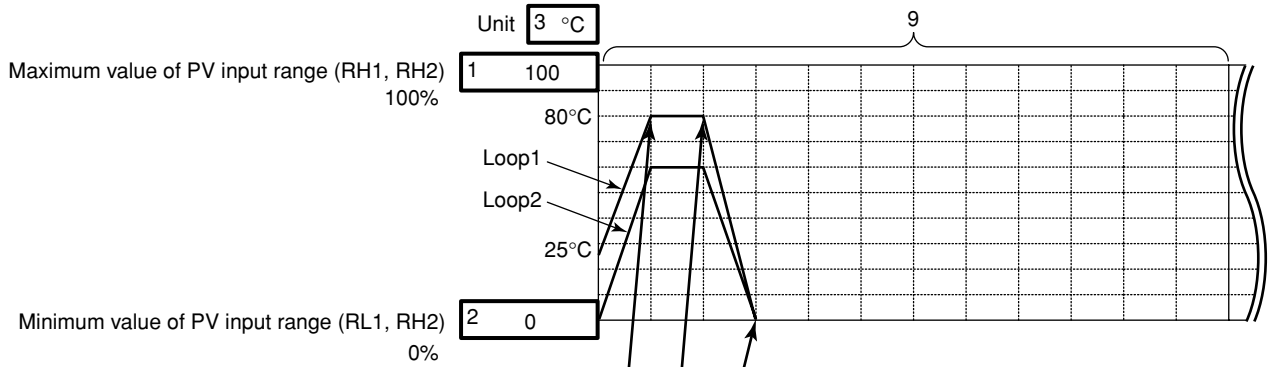

	Segment No. →	1	2	3	4	5	6	7	8	9	10	11	12	1
Final target setpoint 1 (TSP1) <Loop1>		80°C	80°C	0°C										
Final target setpoint 2 (TSP2) <Loop2>		60°C	60°C	0°C										
Segment time (TIME/TM.RT) (for both Loop1 and Loop2)		20 min	80 min	10 min										
PID number (PID) (Note)														
Event number (EV1)		21	1											
PV event type (TY1)/on time of time event (ON1)		7	0 min											
PV event setpoint (PE1)/off time of time event (OFF1)		5°C	80 min											
Event number (EV2)														
PV event type (TY2)/on time of time event (ON2)														
PV event setpoint (PE2)/off time of time event (OFF2)														
Event number (EV3)														
PV event type (TY3)/on time of time event (ON3)														
PV event setpoint (PE3)/off time of time event (OFF3)														
Event number (EV4)														
PV event type (TY4)/on time of time event (ON4)														
PV event setpoint (PE4)/off time of time event (OFF4)														
Event number (EV5)														
PV event type (TY5)/on time of time event (ON5)														
PV event setpoint (PE5)/off time of time event (OFF5)														
Event number (EV6)														
PV event type (TY6)/on time of time event (ON6)														
PV event setpoint (PE6)/off time of time event (OFF6)														
Event number (EV7)														
PV event type (TY7)/on time of time event (ON7)														
PV event setpoint (PE7)/off time of time event (OFF7)														
Event number (EV8)														
PV event type (TY8)/on time of time event (ON8)														
PV event setpoint (PE8)/off time of time event (OFF8)														
Junction code (JC)		0	0	0										

Note: Shown for segment PID parameters when the setup parameter "ZON" is set to 0.

3.3 Creating Program Patterns

The following operating procedure describes an example of creating the program discussed in “3.1 Overview of Program Patterns.”



NOTE

Before creating the program, reverify the Maximum Value of PV Input Range of Loop1 and Loop2 (RH1, RH2), Minimum Value of PV Input Range of Loop1 and Loop2 (RL1, RL2), Program Time Unit (TMU), and Segment Setting Method (SEG.T) parameters.

If the setting of the setup parameter “SEG.T” is changed, the program patterns created and stored so far will be all cleared (initialized)!! Be careful.

Is common as program pattern segment of Loop1 and Loop2

The programming example given in this section includes the following steps.

- Step 5 selects the program pattern number (PTN).
- Steps 7 to 12 configure the parameter Starting Target Setpoint of Loop1 (SSP1) (so that the program starts from 25°C), and the parameter starting Target Setpoint of Loop2 (SSP2) (so that the program starts from 0°C).
- Steps 14 to 19 configure the Final Target Setpoint (TSP1) parameter for segment 1.
- Steps 20 to 22 configure the Segment Time (TIME) parameter of Loop1 and Loop2 for segment 1.
- Steps 23 to 31 configure the PV Event parameters (EV1, TY1 and PE1).
- Step 34 configures the Final Target Setpoint of Loop1 (TSP1) parameter for segment 2 (not changed in this example).
- Step 35 configures the Final Target Setpoint of Loop2 (TSP2) parameter for segment 2 (not changed in this example).
- Steps 36 to 38 configure the Segment Time (TIME) parameter for segment 2.
- Steps 39 to 47 configure the Time Event parameters (EV1, ON1 and OFF1).
- Steps 50 to 55 configure the Final Target Setpoint of Loop1 and Loop2 (TSP1, TSP2) parameter for segment 3.
- Steps 56 to 58 configure the Segment Time (TIME) parameter for segment 3.

1. Bring the operating display into view (appears at power-on).

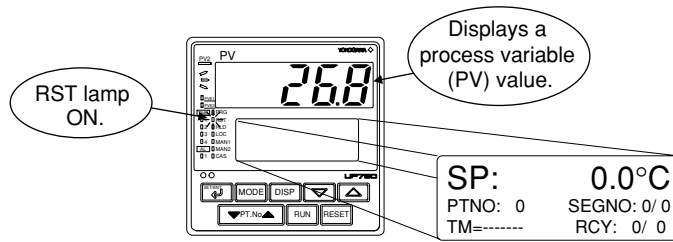

For steps 2 and later, illustrations of the LCD are cited to explain the procedure.

2. Press the  key for more than 3 seconds to call up the main menu "PROG".

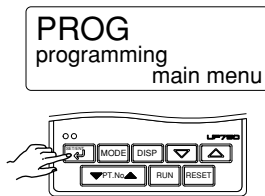

3. Press the  key once to display the submenu "LOC".

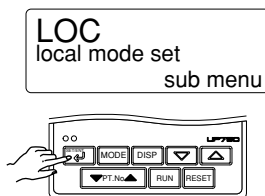

4. Press the  key once to display the submenu "PRG".

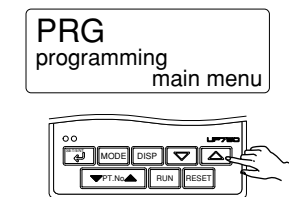

5. Press the  key once to display the Pattern Number parameter "PTN". At this point, the PV display shows "001.00" (the first three digits denote the pattern number and the last two digits the segment number).

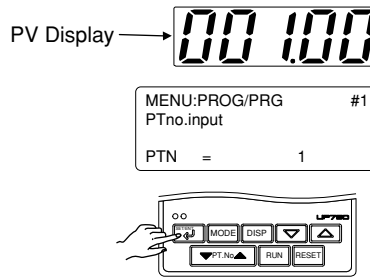

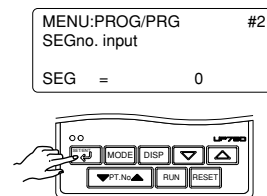

6. Press the  key once to display the Segment Number parameter "SEG".

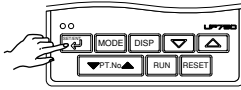

- 7. Press the  key once to display the Loop1 Starting Target Setpoint parameter "SSP1".

MENU:PROG/PRG #3
start set point 1
SSP1 = 0.0°C



- 8. Press the  or  key to display the required setpoint. The figure below shows an example of the parameter set to "25.0°C".

MENU:PROG/PRG #3
start set point 1
SSP1 = 25.0°C changing!

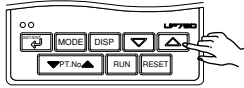

- 9. Press the  key once to register the setpoint.

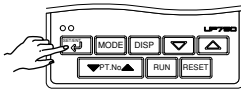

MENU:PROG/PRG #3
start set point 1
SSP1 = 25.0°C

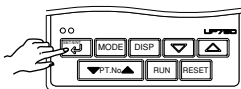

- 10. Press the  key once to display the Loop2 Starting Target Setpoint parameter "SSP2".

MENU:PROG/PRG #4
start set point 2
SSP2 = 0.0°C



- 11. Press the  or  key to display the required setpoint. The figure below shows an example of the parameter set to "0.0°C".

MENU:PROG/PRG #4
start set point 2
SSP2 = 0.0°C changing!

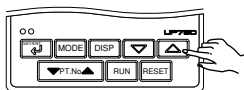

- 12. Press the  key once to register the setpoint.

MENU:PROG/PRG #4
start set point 2
SSP2 = 0.0°C

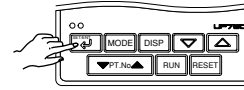

- 13. Press the  key once to display the Start Code parameter "STC".

MENU:PROG/PRG #5
start code select
STC = 0

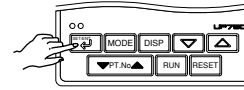



- 14. Press the  key once to display the Target Setpoint parameter "TSP1" for Loop1 segment 1. At this point, the PV display shows "001.01" (the first three digits denote the pattern number and the last two digits the segment number).

PV Display → 

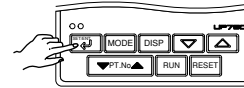
MENU:PROG/PRG #24
target set point 1
TSP1 = 25.0°C



- 15. Press the  or  key to display the required setpoint. The figure below shows an example of the parameter set to "80.0°C".

MENU:PROG/PRG #24
target set point 1
TSP1 = 80.0°C changing!

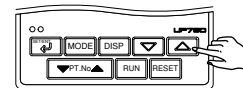

- 16. Press the  key once to register the setpoint.

MENU:PROG/PRG #24
target set point 1
TSP1 = 80.0°C

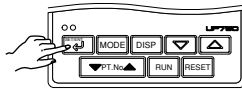



- 17. Press the  key once to display the Target Setpoint parameter “TSP2” for Loop2 segment 1. At this point, the PV display shows “001.01” (the first three digits denote the pattern number and the last two digits the segment number).

PV Display → 

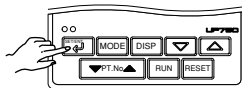
MENU:PROG/PRG #5
target set point 2
TSP2 = 0.0°C



- 18. Press the  or  key to display the required setpoint. The figure below shows an example of the parameter set to “60.0°C”.

MENU:PROG/PRG #5
target set point 2
TSP2 = 60.0°C
changing!

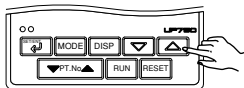

- 19. Press the  key once to register the setpoint.

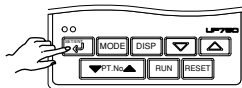

MENU:PROG/PRG #25
target set point 2
TSP2 = 60.0°C

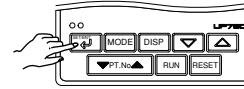

- 20. Press the  key once to display the Segment Time parameter “TIME” for segment 1. Simultaneously for Loop1 and Loop2.

MENU:PROG/PRG #26
segment time
TIME = -



- 21. Press the  or  key to display the required setpoint. The figure below shows an example of the parameter set to “20 min. (0h20)”.

MENU:PROG/PRG #26
segment time
TIME = 0h20
changing!

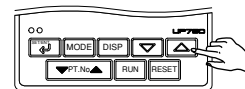

- 22. Press the  key once to register the setpoint.

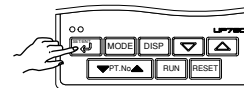

MENU:PROG/PRG #26
segment time
TIME = 0h20

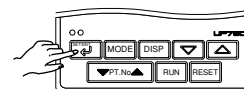

- 23. Press the  key once to display the Event Number parameter “EV1”.

MENU:PROG/PRG #29
event 1 no. select
EV1 = 0



24. Press the  or  key to display the required setpoint.
The figure below shows an example of the parameter set to “PV event 1” (setpoint 21).

```
MENU:PROG/PRG      #29
event 1 no. select
EV1 =                21
changing!
```

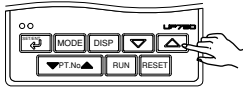

25. Press the  key once to register the setpoint.

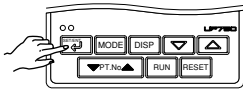

```
MENU:PROG/PRG      #29
event 1 no. select
EV1 =                21
```

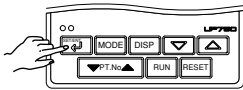

26. Press the  key once to display the PV Event Type parameter “TY1”.

```
MENU:PROG/PRG      #30
PV event 1 type
TY1 =                OFF
```



27. Press the  or  key to display the required setpoint.
The figure below shows an example of the parameter of Loop1 set to “Deviation high and low limits Alarm” (setpoint 7).

```
MENU:PROG/PRG      #30
PV event 1 type
TY1 =                7
changing!
```

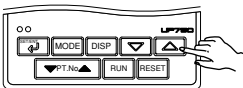

28. Press the  key once to register the setpoint.

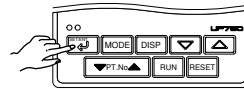

```
MENU:PROG/PRG      #30
PV event 1 type
TY1 =                7
```

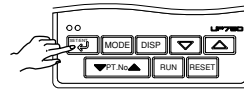

29. Press the  key once to display the PV Event Setpoint parameter “PE1”.

```
MENU:PROG/PRG      #31
PV event 1 set point
PE1 =                0.0°C
```



30. Press the  or  key to display the required setpoint.
The figure below shows an example of the parameter set to “5.0°C”.

```
MENU:PROG/PRG      #31
PV event 1 set point
PE1 =                5.0°C
changing!
```

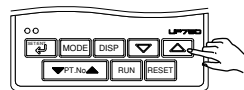

31. Press the  key once to register the setpoint.

```
MENU:PROG/PRG      #31
PV event 1 set point
PE1 =                5.0°C
```

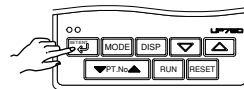

- 32. Press the  key once to display the Event Number parameter “EV2”.

MENU:PROG/PRG #32
 event 2 no. select
 EV2 = 0

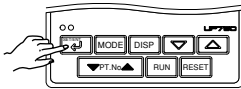

- 33. Press the  key once to display the Junction Code parameter “JC” for segment 1. The setpoint of this parameter is not changed in this example.

MENU:PROG/PRG #53
 junction code select
 JC = 0

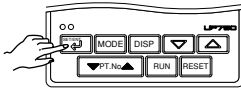



- 34. Press the  key once to display the Target Setpoint parameter “TSP1” for Loop1 segment 2. The setpoint of this parameter is not changed in this example. At this point, the PV display shows “001.02” (the first three digits denote the pattern number and the last two digits the segment number).

PV Display → 

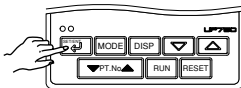
MENU:PROG/PRG #24
 target set point 1
 TSP1 = 80.0°C



- 35. Press the  key once to display the Target Setpoint parameter “TSP2” for Loop2 segment 2. The setpoint of this parameter is not changed in this example. At this point, the PV display shows “001.02” (the first three digits denote the pattern number and the last two digits the segment number).

PV Display → 

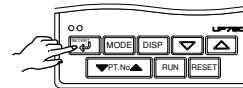

MENU:PROG/PRG #25
 target set point 2
 TSP2 = 60.0°C

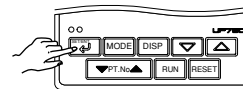

- 36. Press the  key once to display the Segment Time parameter “TIME” for segment 2. Simultaneously from Loop1 and Loop2.

MENU:PROG/PRG #26
 segment time
 TIME = -



- 37. Press the  or  key to display the required setpoint. The figure below shows an example of the parameter set to “1 hr. and 20 min. (setpoint 1h20)”.

MENU:PROG/PRG #26
 segment time
 changing!
 TIME = 1h20

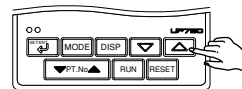

38. Press the  key once to register the setpoint.

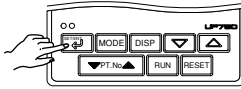

```
MENU:PROG/PRG      #26
segment time
TIME = 1h20
```

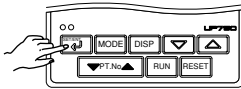

39. Press the  key once to display the Event Number parameter "EV1".

```
MENU:PROG/PRG      #29
event 1 no. select
EV1 = 0
```



40. Press the  or  key to display the required setpoint. The figure below shows an example of the parameter set to "time event 1 (setpoint 1)".

```
MENU:PROG/PRG      #29
event 1 no. select
EV1 = 1 changing!
```

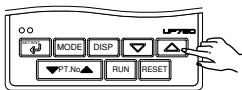

41. Press the  key once to register the setpoint.

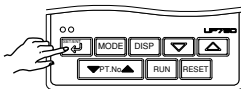

```
MENU:PROG/PRG      #29
event 1 no. select
EV1 = 1
```

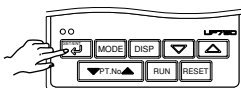

42. Press the  key once to display the On Time of Time Event parameter "ON1".

```
MENU:PROG/PRG      #30
time event 1 ON time
ON1 = OFF
```



43. Press the  or  key to display the required setpoint. The figure below shows an example of the parameter set to "0 min. (setpoint 0h00)".

```
MENU:PROG/PRG      #30
time event 1 ON time
ON1 = 0h00 changing!
```

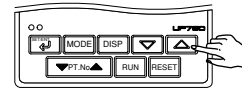

44. Press the  key once to register the setpoint.

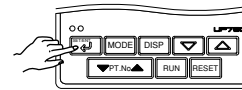

```
MENU:PROG/PRG      #30
time event 1 ON time
ON1 = 0h00
```

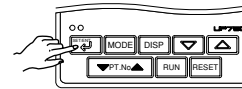

45. Press the  key once to display the Off Time of Time Event parameter "OFF1".

```
MENU:PROG/PRG      #31
time event 1 OFF time
OFF1 = OFF
```



46. Press the  or  key to display the required setpoint. The figure below shows an example of the parameter set to "1 hr. and 20 min. (setpoint 1h20)".

```
MENU:PROG/PRG      #31
time event 1 OFF time
OFF1 = 1h20 changing!
```

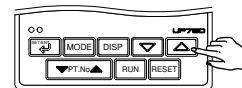

47. Press the  key once to register the setpoint.

MENU:PROG/PRG #31
time event 1 OFF time
OFF1 = 1h20

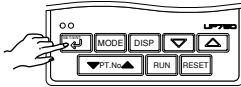

48. Press the  key once to display the Event Number parameter "EV2".

MENU:PROG/PRG #32
event 1 no. select
EV2 = 0

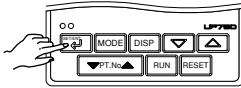

49. Press the  key once to display the Junction Code parameter "JC" for segment 2.
The setpoint of this parameter is not changed in this example.

MENU:PROG/PRG #53
junction code select
JC = 0

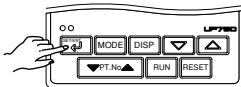



50. Press the  key once to display the Target Setpoint parameter for Loop1 segment 3.
At this point, the PV display shows "001.03" (the first three digits denote the pattern number and the last two digits the segment number).

PV Display → 

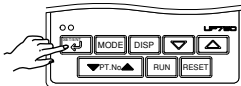
MENU:PROG/PRG #24
target set point 1
TSP1 = 80.0°C



51. Press the  or  key to display the required setpoint.
The figure below shows an example of the parameter set to "0.0°C".

MENU:PROG/PRG #24
target set point 1
TSP1 = 0.0°C
changing!

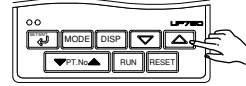

52. Press the  key once to register the setpoint.

MENU:PROG/PRG #24
target set point 1
TSP1 = 0.0°C

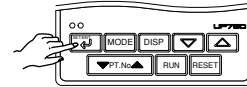



53. Press the  key once to display the Target Setpoint parameter for Loop2 segment 3.
At this point, the PV display shows "001.03" (the first three digits denote the pattern number and the last two digits the segment number).

PV Display → 

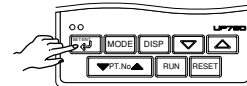
MENU:PROG/PRG #25
target set point 2
TSP2 = 60.0°C



54. Press the  or  key to display the required setpoint.
The figure below shows an example of the parameter set to "0.0°C".

MENU:PROG/PRG #25
target set point 2
TSP2 = 0.0°C
changing!

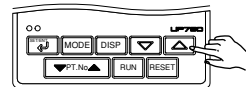

55. Press the  key once to register the setpoint.

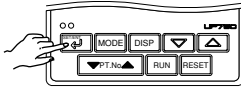

```
MENU:PROG/PRG      #25
target set point 2
TSP2 =      0.0°C
```

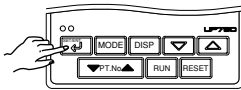

56. Press the  key once to display the Segment Time parameter "TIME" for segment 3. Simultaneously for Loop1 and Loop2.

```
MENU:PROG/PRG      #36
segment time
TIME =      -
```



57. Press the  or  key to display the required setpoint. The figure below shows an example of the parameter set to "10 min. (setpoint 0h10)".

```
MENU:PROG/PRG      #26
segment time
changing!
TIME =      0h10
```

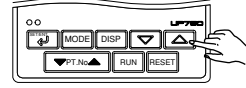

58. Press the  key once to register the setpoint.

```
MENU:PROG/PRG      #26
segment time
TIME =      0h10
```

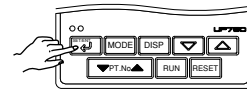

59. Programming is now complete. Press the  key for more than 3 seconds. This returns you to the display shown at power-on (figure below).

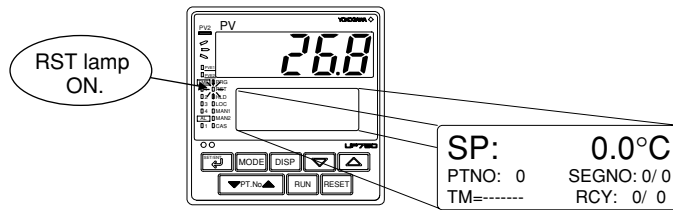

3.4 Changing Program Patterns

The following operating procedure describes an example of changing the program pattern created in “3.3 Creating Program Patterns” to the program pattern shown in the figure below.

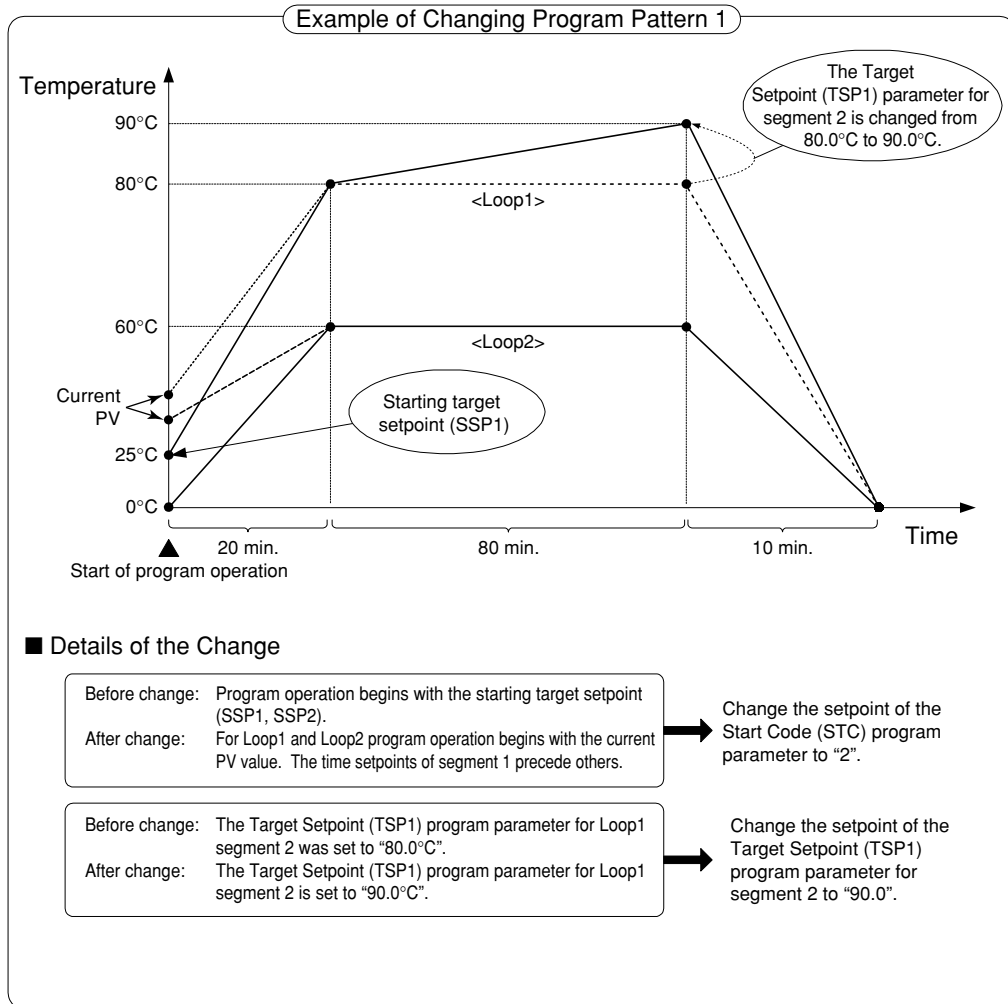

1. Bring the operating display into view (appears at power-on).

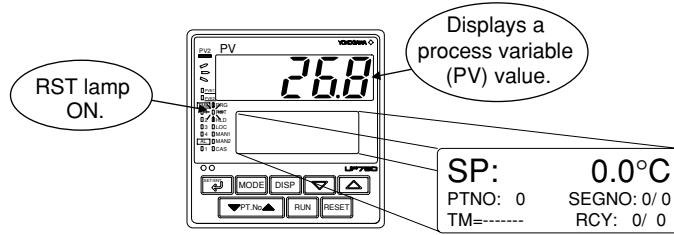

For steps 2 and later, illustrations of the LCD are cited to explain the procedure.

2. Press the key for **more than 3 seconds** to call up the main menu "PROG".

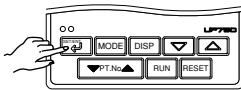

3. Press the key once to display the submenu "LOC".

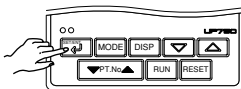
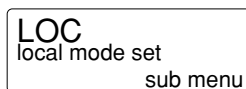

4. Press the key once to display the submenu "PRG".

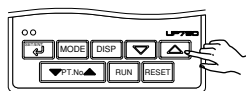
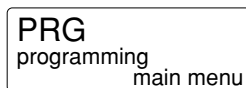

5. Press the key once to display the Pattern Number parameter "PTN".

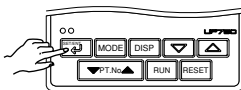
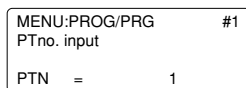

6. Press the key once to display the Segment Number parameter "SEG".

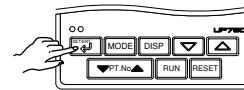
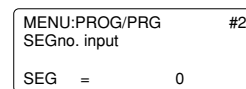

7. Press the key twice to display the Start Code parameter "STC".

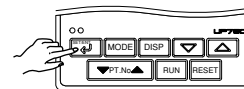
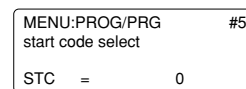

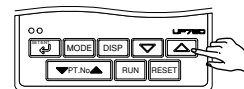
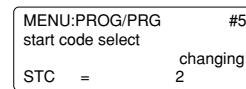

8. Press the or key to display the required setpoint. The figure below shows an example of the parameter set to "time-prioritized PV start (setpoint 2)".

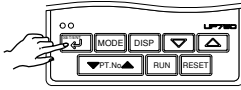

- 9. Press the  key once to register the setpoint.

```
MENU:PROG/PRG      #5
start code select
STC =                2
```



- 10. Press the  key once to display the Target Setpoint parameter "TSP1" for Loop1 segment 1.

```
MENU:PROG/PRG      #24
target set point 1
TSP1 =             80.0°C
```

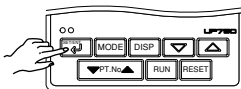



- 11. Press the  key eight times to display the Target Setpoint parameter "TSP1" for segment 2. At this point, the PV display shows "001.02" (the first three digits denote the pattern number and the last two digits the segment number).

PV Display → 

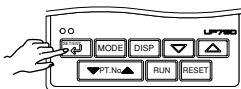
```
MENU:PROG/PRG      #24
target set point 1
TSP1 =             80.0°C
```



- 12. Press the  or  key to display the required setpoint. The figure below shows an example of the parameter set to "90.0°C".

```
MENU:PROG/PRG      #24
target set point 1
TSP1 =             90.0°C
changing!
```

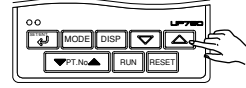

- 13. Press the  key once to register the setpoint.

```
MENU:PROG/PRG      #24
target set point 1
TSP1 =             90.0°C
```

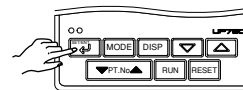

- 14. Changing the program is now complete. Press the  key for more than 3 seconds. This returns you to the display shown at power-on (figure below).

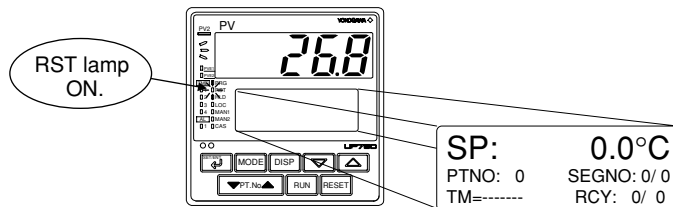

3.5 Program Parameter Map

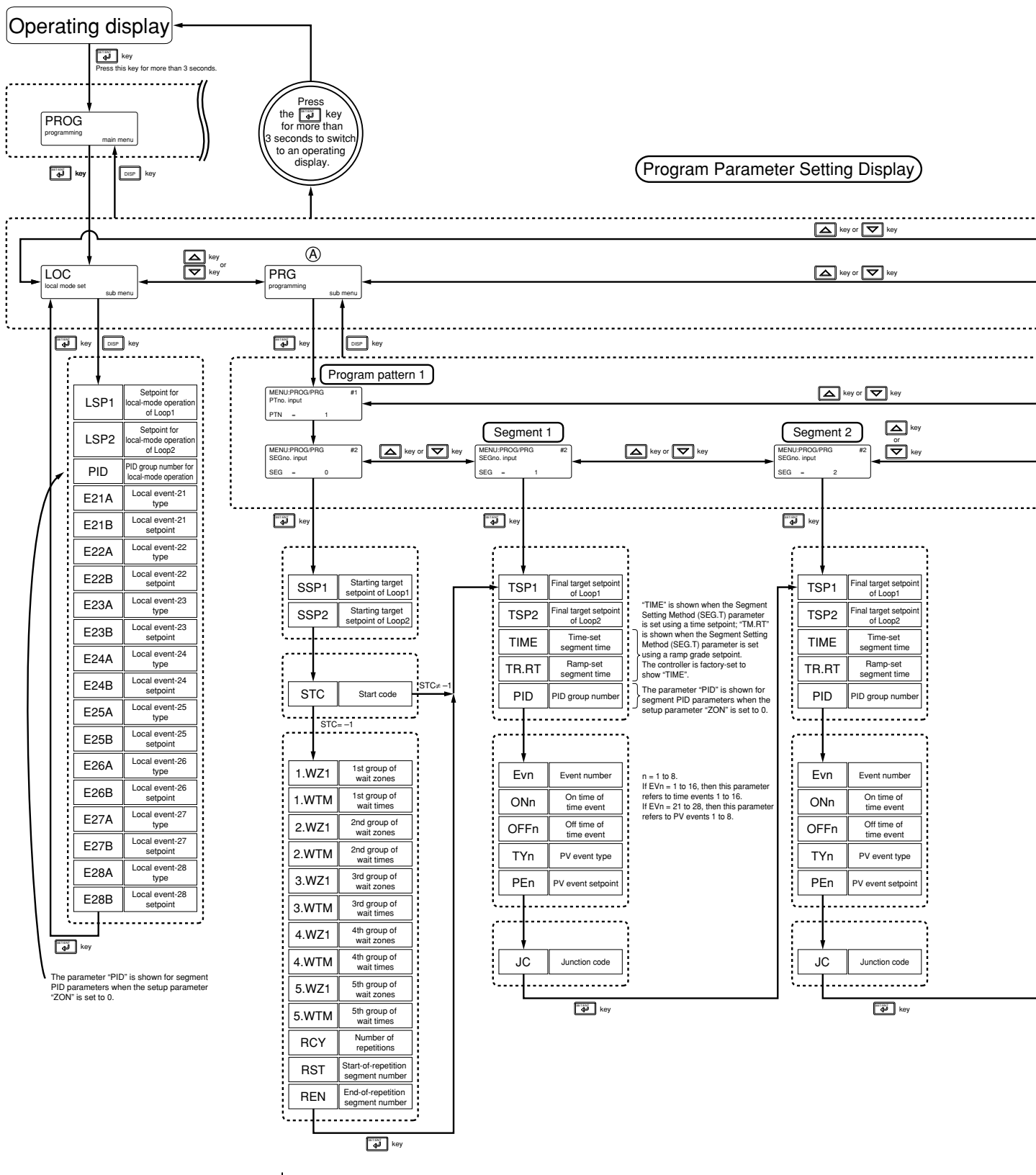

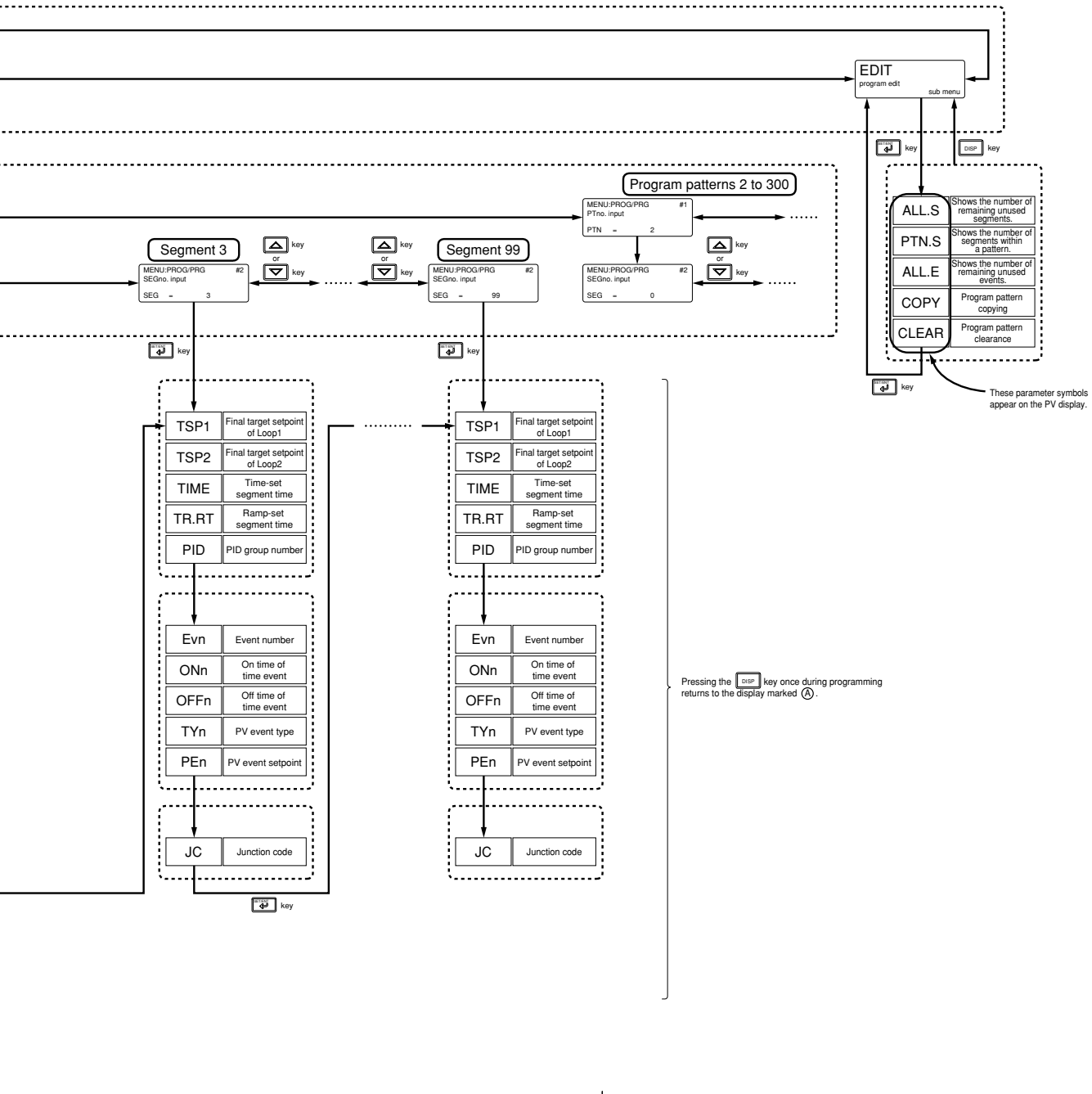

3.6 Lists of Program Parameters

- * Parameters relating to PV or program setpoints should all be set in real numbers. For example, use temperature values to define program setpoints and PV event setpoints for temperature input.
- * The “User Setting” column in the table below is provided for the customer to record setpoints.

● Local Setpoint Parameters

Located in: Main menu = **PROG** ; Submenu = **LOC**

Parameter Symbol	Name of Parameter	Setting Range and Description	Initial Value	User Setting
LSP1	Local setpoint for local-mode operation of loop1	0.0 to 100.0% of Loop1 PV input range	0.0% of Loop1 PV input range	
LSP2	Local setpoint for local-mode operation of loop2	0.0 to 100.0% of Loop2 PV input range	0.0% of Loop2 PV input range	
PID	PID group number for local-mode operation	Shown for segment PID parameters when the setup parameter “ZON” is set to 0. This parameter is factory-set so as not to appear. 1: Uses the 1st group of PID parameters. 2: Uses the 2nd group of PID parameters. 3: Uses the 3rd group of PID parameters. 4: Uses the 4th group of PID parameters. 5 to 8: Likewise, selecting these numbers uses the 5th to 8th groups of PID parameters.	1	
E21A	Local event-21 type	OFF, Loop1: 1 to 10, 28 to 31 Loop2: 41 to 50, 68 to 71 1: PV high limit (energized, no stand-by action) 2: PV low limit (energized, no stand-by action) 3: Deviation high limit (energized, no stand-by action) 4: Deviation low limit (energized, no stand-by action) 5: Deviation high limit (de-energized, no stand-by action) 6: Deviation low limit (de-energized, no stand-by action) 7: Deviation high/low limits (energized, no stand-by action) 8: Deviation within high/low limits (energized, no stand-by action) 9: PV high limit (de-energized, no stand-by action) 10: PV low limit (de-energized, no stand-by action)	OFF (0)	
E21B	Local event-21 setpoint	PV/SP alarm: -100.0 to 100.0% of PV input range Deviation alarm: -100.0 to 100.0% of PV input range span Output value alarm: -5.0 to 105.0%	PV/SP high limit alarm: 100.0% of PV input range. Deviation alarm: 0.0% of PV input range span. Other PV/SP low limit alarms: 0.0% of PV input range. Output high limit alarm: 100.0% Output low limit alarm: 0.0%	

Parameter Symbol	Name of Parameter	Setting Range and Description	Initial Value	User Setting
E22A	Local event-22 type	Same as the E21A parameter.		
E22B	Local event-22 setpoint	Same as the E21B parameter.		
E23A	Local event-23 type	Same as the E21A parameter.		
E23B	Local event-23 setpoint	Same as the E21B parameter.		
E24A	Local event-24 type	Same as the E21A parameter.		
E24B	Local event-24 setpoint	Same as the E21B parameter.		
E25A	Local event-25 type	Same as the E21A parameter.		
E25B	Local event-25 setpoint	Same as the E21B parameter.		
E26A	Local event-26 type	Same as the E21A parameter.		
E26B	Local event-26 setpoint	Same as the E21B parameter.		
E27A	Local event-27 type	Same as the E21A parameter.		
E27B	Local event-27 setpoint	Same as the E21B parameter.		
E28A	Local event-28 type	Same as the E21A parameter.		
E28B	Local event-28 setpoint	Same as the E21B parameter.		

● **Program Parameters (Parameters for Setting the Conditions of Program Operation Startup)**

Use the program pattern setup chart discussed in “3.2 Example of Program Pattern Setup Charts” of this chapter, to record your setpoints of program parameters.

Located in: Main menu = PROG ; Submenu = PRG

Parameter Symbol	Name of Parameter	Setting Range and Description	Initial Value	User Setting
PTN	Pattern number	1: Program pattern 1 2: Program pattern 2 3: Program pattern 3 4 to 300: Likewise, specifying these numbers sets their corresponding program pattern numbers.		
SEG	Segment number	0: Shows parameters for setting the starting target setpoint, start code, etc. 1 to 99: Specify the corresponding segment numbers. Specify “0” when creating a program for the first time.	0	
SSP1	Starting target setpoint 1 (Loop1)	0.0 to 100.0% of Loop1 PV input range	0.0% of Loop1 PV input range	
SSP2	Starting target setpoint 2 (Loop2)	0.0 to 100.0% of Loop2 PV input range	0.0% of Loop2 PV input range	
STC	Start code	-1: Shows parameters for setting the wait and repeat actions. 0: Program operation begins with the starting target setpoint. 1: Loop1 ramp-prioritized PV start (program operation begins with the PV value by giving priority to the ramp of Loop1 segment 1) 2: Time-prioritized PV start (program operation begins with the PV value by giving priority to the time of segment 1) 3: Loop2 ramp-prioritized PV start (program operation begins with the PV value by giving priority to the ramp of Loop2 segment 1) TIP: The option “-1” is not a setpoint.	0	

● **Program Parameters (Parameters for Setting the Wait and Repeat Actions)**

The parameters listed below are shown when the Start Code (STC) parameter is set to “-1.”

Located in: Main menu = PROG ; Submenu = PRG

Parameter Symbol	Name of Parameter	Setting Range and Description	Initial Value	User Setting
1.WZ1	1st group of wait zones	OFF: No function 0.0 to 10.0% of PV input range span	OFF	
1.WTM	1st group of wait times	OFF: No function 0.01 to 99.59 (“hour, minute” or “minute, second”) Use the TMU setup parameter to set the time unit.	OFF	
2.WZ1	2nd group of wait zones	Same as the 1st group of wait zones.		
2.WTM	2nd group of wait times	Same as the 1st group of wait times.		
3.WZ1	3rd group of wait zones	Same as the 1st group of wait zones.		
3.WTM	3rd group of wait times	Same as the 1st group of wait times.		
4.WZ1	4th group of wait zones	Same as the 1st group of wait zones.		
4.WTM	4th group of wait times	Same as the 1st group of wait times.		
5.WZ1	5th group of wait zones	Same as the 1st group of wait zones.		
5.WTM	5th group of wait times	Same as the 1st group of wait times.		
RCY	Number of repetitions	0 to 999: The controller repeats the segment specified by the RST and REN parameters as many times as defined by this parameter. CONT: The controller indefinitely repeats the segment specified by the RST and REN parameters.	0	
RST	Start-of-repetition segment number	1 ≤ RST ≤ REN ≤ 99	1	
REN	End-of-repetition segment number		1	

● **Program Parameters (Parameters for Setting the Final Target Setpoints and Segment Times)**

Located in: Main menu = PROG ; Submenu = PRG

Parameter Symbol	Name of Parameter	Setting Range and Description	Initial Value	User Setting
TSP1	Final target setpoint 1 (Loop1)	The final target setpoint of each segment.		
TSP2	Final target setpoint 2 (Loop2)	The final target setpoint of each segment.		
TIME	Time-set segment time	Time setpoint: - (unregistered) 0.00 to 99.59 (“hour, minute” or “minute, second”) Without a time setpoint, it is not possible to create programs.		
TM.RT	Ramp-set segment time	For ramp segments (ramp setpoint): - (unregistered), 0.0 to 100.0% of PV input range span per hour or minute For soak segments: 0.00 to 99.59 (“hour, minute” or “minute, second”) Without a time setpoint or a ramp grade setpoint, it is not possible to create programs.		
PID	Segment PID group number	This parameter is shown for segment PID parameters when the setup parameter “ZON” is set to 0. This parameter is factory-set so as not to appear. 1 to 8	1	

● **Program Parameters (Parameters for Setting the Event Action)**

You can set a maximum of eight units each for the parameters listed below for each individual segment.

Located in: Main menu = PROG ; Submenu = PRG

Parameter Symbol	Name of Parameter	Setting Range and Description	Initial Value	User Setting
EV_n (n = 1 to 8)	Event number	0: Unregistered. 1: Time event 1 (terminal numbers ⑳-㉓) 2: Time event 2 (terminal numbers ㉔-㉗) 3: Time event 3 (terminal numbers ㉘-㉛) 4: Time event 4 (terminal numbers ㉜-㉟) 5 to 16: Time events 5 to 16 (see the CD-ROM version user's manual for details on the terminal number) 21: PV event 1 (terminal numbers ㉠-㉡) 22: PV event 2 (terminal numbers ㉢-㉣) 23 to 28: PV events 3 to 8 (see the CD-ROM version user's manual for details on the terminal number)	0	
ON_n	On time of time event	OFF: Unused. 0.00 to 99.59 ("hour, minute" or "minute, second")	OFF	
OFF_n	Off time of time event	OFF: Unused. 0.00 to 99.59 ("hour, minute" or "minute, second")	OFF	
TY_n	PV event type	OFF, Loop1: 1 to 10, 28 to 31 Loop2: 41 to 50, 68 to 71 1: PV high limit (energized, no stand-by action) 2: PV low limit (energized, no stand-by action) 3: Deviation high limit (energized, no stand-by action) 4: Deviation low limit (energized, no stand-by action) 5: Deviation high limit (de-energized, no stand-by action) 6: Deviation low limit (de-energized, no stand-by action) 7: Deviation high/low limits (energized, no stand-by action) 8: Deviation within high/low limits (energized, no stand-by action) 9: PV high limit (de-energized, no stand-by action) 10: PV low limit (de-energized, no stand-by action) See the next page for details on other alarm types.	OFF	
PE_n	PV event setpoint	PV/SP alarm: -100.0 to 100.0% of PV input range Deviation alarm: -100.0 to 100.0% of PV input range span Output value alarm: -5.0 to 105.0%	PV/SP high limit alarm: 100.0% of PV input range. Deviation alarm: 0.0% of PV input range span. Other PV/SP low limit alarms: 0.0% of PV input range. Output high limit alarm: 100.0% Output low limit alarm: 0.0%	

● **Program Parameters (Junction Code Parameter)**

Located in: Main menu = PROG ; Submenu = PRG

Parameter Symbol	Name of Parameter	Setting Range and Description	Initial Value	User Setting
JC	Junction code	0: Switching for continuation 1: Hold-on switching (the controller holds the end-of-segment setpoint when the segment is completed, to perform control). 2: Local-mode end (the controller switches to a local setpoint when the segment is completed). 11 to 15: Wait during switching between segments (see the CD-ROM version user's manual). 21 to 25: Wait within a segment interval (see the CD-ROM version user's manual). INSERT: Allows a segment to be added to the end of a specified segment. DELETE: Allows a specified segment to be deleted.	0	

List of PV Event and Local Event Types

The table below shows the types and actions of PV event and Local event. In the table, codes 1 to 10 are for Loop1, 41 to 50 and 68 to 71 are Loop2.

Alarm type	Alarm action "Open/close" shows status of relay contact, and "lit" and "unlit" shows status of lamp	Alarm type code		Alarm type	Alarm action "Open/close" shows status of relay contact, and "lit" and "unlit" shows status of lamp	Alarm type code	
		Contact closes if alarm occurs	Contact opens if alarm occurs			Contact closes if alarm occurs	Contact opens if alarm occurs
No alarm		OFF					
PV high limit		1 41	/	De-energized on deviation low limit alarm		/	6 46
PV low limit		2 42	/	Deviation high and low limits		7 47	/
Deviation high limit		3 43	/	Deviation within high and low limits		8 48	/
Deviation low limit		4 44	/	De-energized on PV high limit		9 49	/
De-energized on deviation high limit alarm		/	5 15	De-energized on PV low limit		/	10 50
SP high limit		28 68	/	Output high limit		30 70	/
SP low limit		29 69	/	Output low limit		31 71	/

● Program Parameters (Parameters for Editing Programs)

Located in: Main menu = **PROG** ; Submenu = **EDIT**

Symbol on PV Display	Name of Parameter	Setting Range and Description	Initial Value	User Setting
ALLS (ALL.S)	Number of remaining unused segments.	Read-only		
PTnS (PTN.S)	Number of segments within a pattern.			
ALLE (ALL.E)	Number of remaining unused events.			
COPY (COPY)	Program pattern copying	Specify the numbers of the source-of-copying program pattern and target-of-copying program pattern. (1 to 300)		
CLEAR (CLEAR)	Program pattern clearance	Specify the number of the program pattern to be cleared. (1 to 300)		

3.7 Program Pattern Setup Charts

For details on how to use the program pattern setup chart, see “3.1 Overview of Program Patterns,” and “3.2 Example of Program Pattern Setup Charts.”

You can register as many as 300 program patterns with the UP750 controller. Create as many copies of the chart as necessary.

First fill in the fields with bold-face borders in the order from number 1 to number 9. Then, input the data into the controller.

1. Maximum value of PV input range: Setpoint of the "Maximum Value of PV Input Range of Loop1 and Loop2 (RH1, RH2)" setup parameter
2. Minimum value of PV input range: Setpoint of the "Minimum Value of PV Input Range of Loop1 and Loop2 (RL1, RL2)" setup parameter
3. PV input unit: Setpoint of the "PV Input Unit (UNI1)" setup parameter
4. Program time unit: Setpoint of the "Program Time Unit (TMU)" setup parameter
5. Segment setting method: Setpoint of the "Segment Setting Method (SEG.T)" setup parameter
6. Starting target setpoint: Setpoint of the "Starting Target Setpoint (SSP1, SSP2)" program parameter of Loop1 and Loop2
7. Start code: Setpoint of the "Start Code (STC)" program parameter
8. Final target setpoint, segment time, Events (PV event and Time event) and Junction code: Setpoint of each program parameter
9. Draw the program pattern.

System name	
Program No.	
Program name	
Model	UP750 -
Serial No.	

Program time unit (TMU)	4
Segment setting method (SEG.T)	5

Unit

Maximum value of PV input range (RH1, RH2)	<input type="text" value="1"/>						
100%							
Minimum value of PV input range (RL1, RL2)	<input type="text" value="2"/>						
0%							

Time setting (TIME) when the Segment Setting Method (SEG.T) parameter is set as SEG.T = 0; ramp setting (TM.RT) when the parameter is set as SEG.T = 1
Factory-set to Time setting (TIME).

Shown for segment PID parameters when the setup parameter "ZON" is set to 0.

Segment No. →	1	2	3	4	5	6
Final target setpoint 1 (TSP1) <Loop1>						
Final target setpoint 2 (TSP2) <Loop2>						
Segment time (TIME/TM.RT) <for both Loop1 and Loop2>						
PID number (PID)						
Event number (EV1)						
PV event type (TY1)/on time of time event (ON1)						
PV event setpoint (PE1)/off time of time event (OFF1)						
Event number (EV2)						
PV event type (TY2)/on time of time event (ON2)						
PV event setpoint (PE2)/off time of time event (OFF2)						
Event number (EV3)						
PV event type (TY3)/on time of time event (ON3)						
PV event setpoint (PE3)/off time of time event (OFF3)						
Event number (EV4)						
PV event type (TY4)/on time of time event (ON4)						
PV event setpoint (PE4)/off time of time event (OFF4)						
Event number (EV5)						
PV event type (TY5)/on time of time event (ON5)						
PV event setpoint (PE5)/off time of time event (OFF5)						
Event number (EV6)						
PV event type (TY6)/on time of time event (ON6)						
PV event setpoint (PE6)/off time of time event (OFF6)						
Event number (EV7)						
PV event type (TY7)/on time of time event (ON7)						
PV event setpoint (PE7)/off time of time event (OFF7)						
Event number (EV8)						
PV event type (TY8)/on time of time event (ON8)						
PV event setpoint (PE8)/off time of time event (OFF8)						
Junction code (JC)						

3.8 Explanation of Program Functions

■ Programming

You can create programs using either method 1 or 2 described below.

The controller is factory-set to “method 1.” To create programs using method 2, change the setpoint of the SEG.T (Segment Setting Method) setup parameter to “1.”

Before you begin programming, determine whether your programs are created using the time unit of “hour and minute” or “minute and second.” The controller is factory-set to the “hour and minute” time unit. To create programs using the “minute and second” time unit, change the setpoint of the TMU (Program Time Unit) setup parameter to “mm:ss.”

<Controller Settings>

	Setpoint of SEG.T (Segment Setting Method) Setup Parameter
Time setting (method 1)	0 (factory-set default)
Ramp setting (method 2)	1

Choose the desired method and unit from the two programming methods and time unit options discussed above. Then, create programs according to the chosen options.

1. Creating programs by setting final target setpoint and time unit

As shown in the figure below, this method creates programs by setting a segment time and a final target setpoint on a segment-by-segment basis.

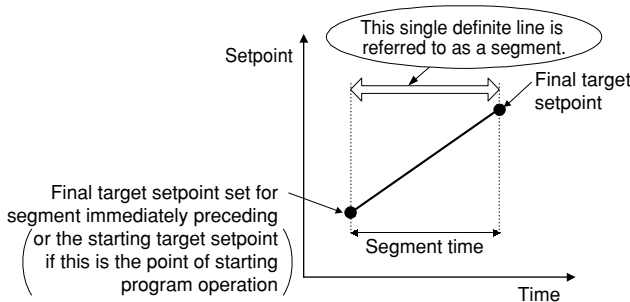

2. Creating programs by setting final target setpoint and ramp

As shown in the figure below, this method creates programs by setting a final target setpoint and a ramp grade on a segment-by-segment basis.

Define the ramp grade as the amount of change in the setpoint per hour or per minute.

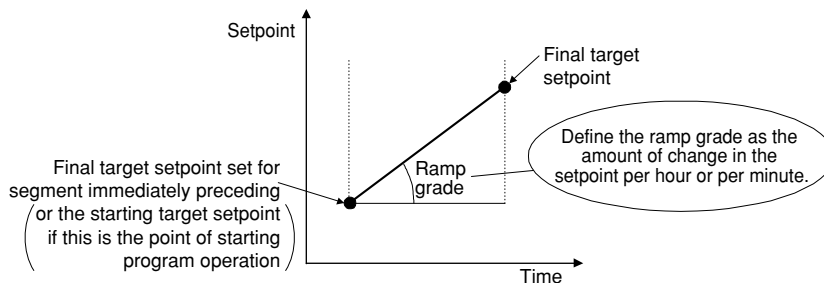

<Controller Settings>

	Setpoint of TMU (Program Time Unit) Setup Parameter
When changing the setpoint linearly over an hour	hh:mm (factory-set default)
When changing the setpoint linearly over a minute	mm:ss

Note: The "Program Time Unit (TMU)" parameter is the time unit you use when creating programs.

When creating a soak segment during programming, set a time ("hour and minute" or "minute and second") rather than a ramp grade.

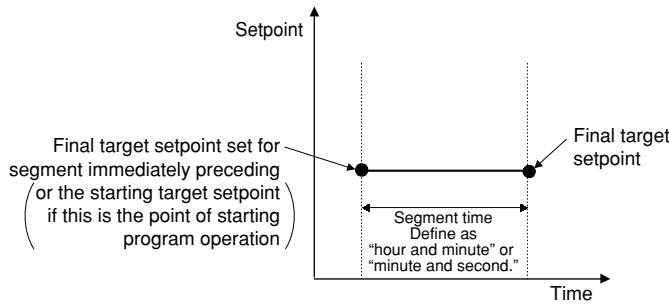

For example, configure segment 1 so the temperature rises in increments of 5°C per minute from 50°C to 100°C, as shown in the figure below.

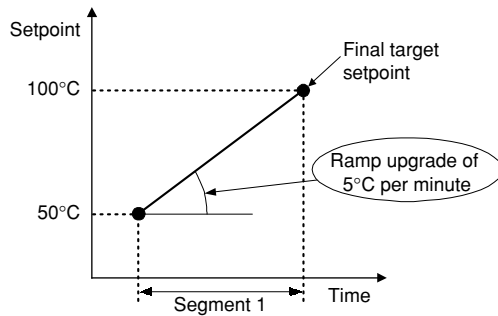

To change the temperature linearly over a minute, set the TMU parameter to "mm:ss" (minute and second) before you begin programming.

When programming the controller, set the Segment Time (TIME) parameter for segment 1 to 5°C.

This allows the controller to raise the setpoint in increments of 5°C per minute during the interval of segment 1.

■ Controller Behavior at the Start of Program Operation

You can determine how the controller should behave at the start of program operation.

1. Letting the controller run from a starting target setpoint

A starting target setpoint refers to a setpoint from which program operation begins. The controller operates in such a manner that the setpoint changes to the final target setpoint over the segment time set for segment 1, irrespective of what the PV value is.

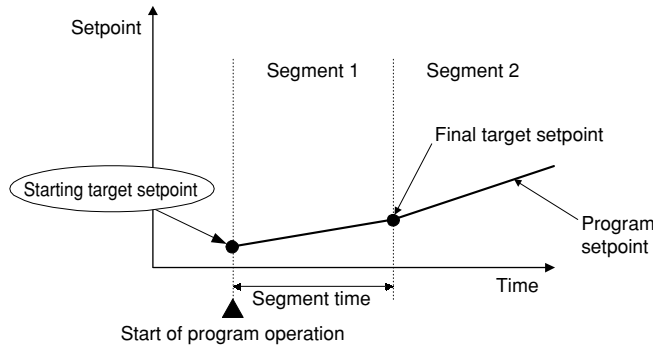

<Controller Settings>

Set the STC (Start Code) program parameter to "0".

2. Letting the controller start from the current setpoint and run according to time settings defined for segment 1

This method is not available if the SEG.T (Segment Setting Method) parameter is set to "ramp setting."

Starting Point of Operation	Controller Behavior
a	Begins to run from point a according to the time setting defined for segment 1.
b	Begins to run from point b according to the time setting defined for segment 1.
c	Begins to run from point c according to the time setting defined for segment 1.
d	Begins to run from point d according to the time setting defined for segment 1.
e	Begins to run from point e according to the time setting defined for segment 1.

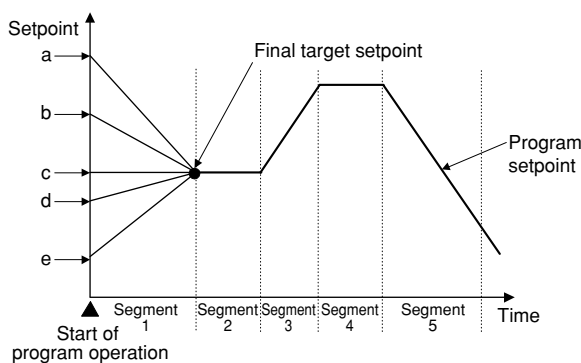

<Controller Settings>

Set the STC (Start Code) program parameter to "2".

3. Letting the controller start from the current setpoint and run according to ramp settings defined for segment 1 of the created program

Starting Point of Operation	Controller Behavior
a	Begins to run from point C1 (ignores the time setting defined for segment 1).
b	Begins to run from point C1 (ignores the time setting defined for segment 1).
c	Begins to run from point C1 (ignores the time setting defined for segment 1).
d	Begins to run from point D1 according to the preset ramp setting (the time setting defined for segment 1 is reduced).
e	Begins to run from point E1 according to the preset ramp setting.

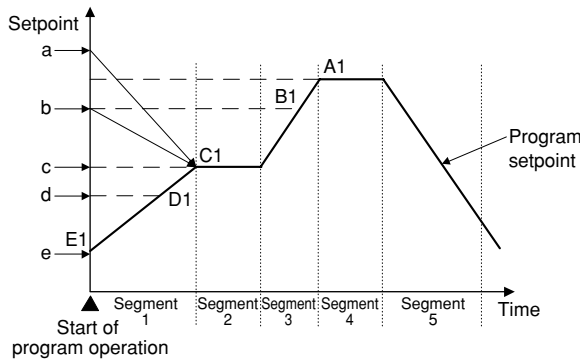

<Controller Settings>

Set the STC (Start Code) program parameter to "1".

■ PID Switching (Zone PID)

The UP750 offers two methods of PID switching. One of the methods is to automatically switch between groups of PID constants according to the temperature zone. The other method is to automatically switch between groups of PID constants on a segment-by-segment basis. This paragraph explains the method of switching between groups of PID constants according to the temperature zone. You can set a maximum of seven temperature zones. When shipped from the factory, the UP750 is configured so that it operates in zone 1 only and uses only one group of PID constants.

● When One Group of PID Constants is Used (factory-set default)

As shown in the figure below, the controller uses one group of PID constants over the range from the minimum value to the maximum value of the PV input range.

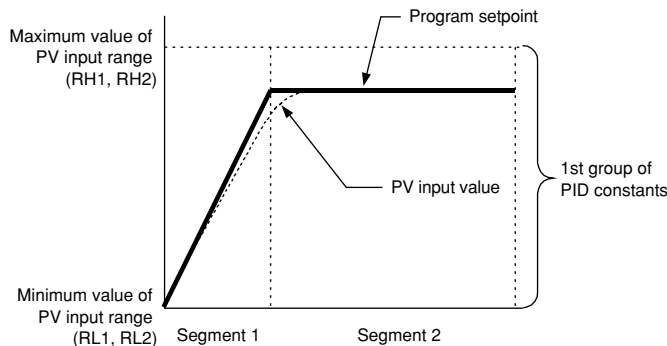

<Controller Settings>

- Configure the 1st group of PID constants (1.P, 1.I and 1.D operating parameters).

● Selection of PID Constants when the Control Range is Split into Three Zones

As shown in the figure below, three zones are set for the controller to automatically switch from one group of PID constants to another. Two zones can also be set for the controller to switch between two groups of PID constants.

- [1] The controller uses the 1st group of PID constants if the PV input value is within the zone set off by the minimum value of the PV input range and reference point 1.
- [2] The controller uses the 2nd group of PID constants if the PV input value is within the zone set off by reference point 1 and reference point 2.
- [3] The controller uses the 3rd group of PID constants if the PV input value is within the zone set off by reference point 2 and the maximum value of the PV input range.

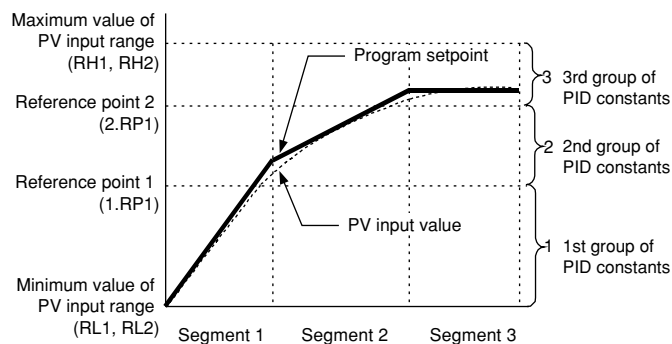

<Controller Settings>

- Splitting the control range into two zones
 - To split the control range into two zones, define reference point 1 (i.e., the 1.RP1 setup parameter).
 - Define the 1st and 2nd groups of PID constants (i.e., the 1.P, 1.I and 1.D operating parameters for the 1st group and the 2.P, 2.I and 2.D operating parameters for the 2nd group).
- Splitting the control range into three zones
 - To split the control range into three zones, define reference points 1 and 2 (i.e., the 1.RP1 and 2.RP1 setup parameters).
 - Define the 1st, 2nd and 3rd groups of PID constants (i.e., the 1.P, 1.I and 1.D operating parameters for the 1st group, the 2.P, 2.I and 2.D operating parameters for the 2nd group and the 3.P, 3.I and 3.D operating parameters for the 3rd group).

● Selecting PID Constants According to the Deviation

PID constants can be selected according to the deviation in two ways. One method is to select a group of PID constants only by a deviation from a program setpoint. The other method is to use a reference point, as discussed earlier, as well as a deviation from a program setpoint, to switch between groups of PID constants.

[Method 1]

As shown in the figure below, the controller selects the PID constants of the group number set in PID group number (GRP) if the PV input value goes beyond the given deviation from the program setpoint.

- [1] The controller uses the 1st group of PID constants.
- [2] The controller uses the PID constants of the group number set in PID group number (GRP).

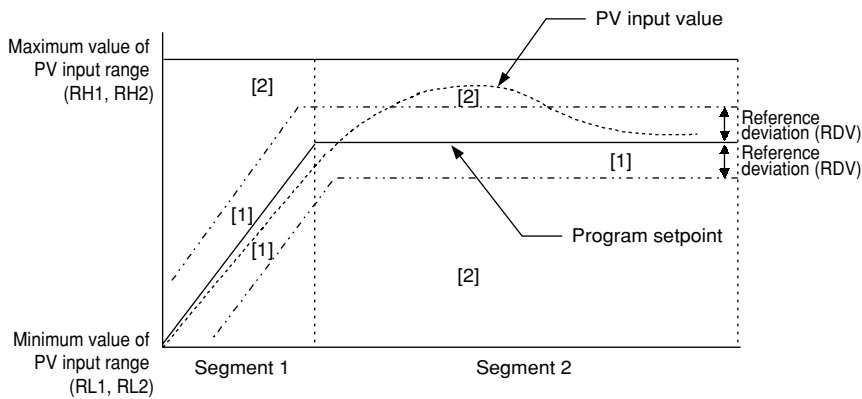

[Method 2]

As shown in the figure below, the controller selects an appropriate group of PID constants for each zone and, if the PV input value goes beyond the given deviation from the program setpoint, selects the PID constants of the group number set in PID group number (GRP).

- [1] The controller uses the 1st group of PID constants if the PV input value is both within the zone set off by the minimum value of the PV input range and reference point 1 and within the given reference deviation bandwidth.
- [2] The controller uses the 2nd group of PID constants if the PV input value is both within the zone set off by reference points 1 and the maximum value of the PV input range, and within the given reference deviation bandwidth.
- [3] The controller uses the PID constants of the group number set in PID group number (GRP).

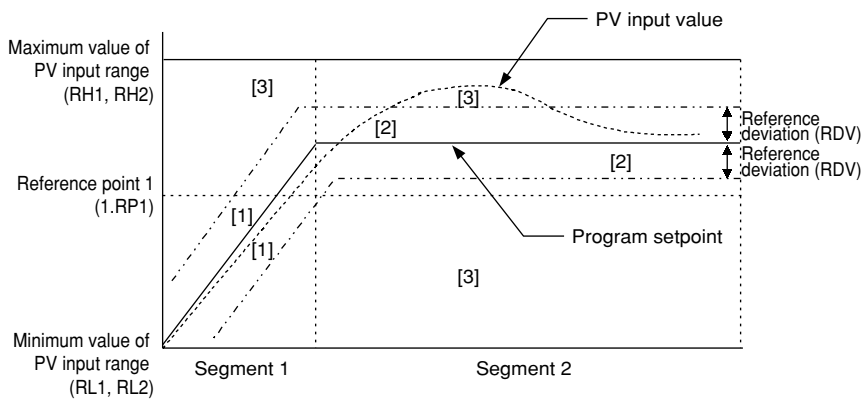

■ Retaining the End-of-Program State (Hold-mode End)

This function keeps the controller in the same state as when program operation was completed.

When in hold operation, the controller retains its states of control output and event output. To cancel hold operation, use either key operation or external contact input. When the hold operation is cancelled, the control output is set to 0% or OFF, and the event output is set to OFF.

To retain the end-of-program state, set the Junction Code program parameter of the segment in question to "1."

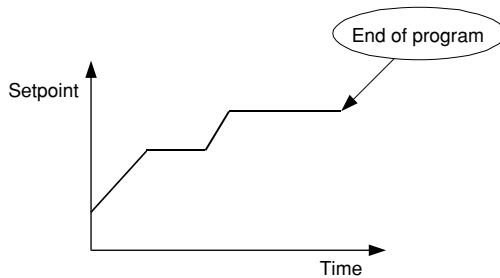

■ Suspending the Progress of a Program (Wait Function)

When a running program moves from one segment to another, the wait function places the program in a wait (stand-by) state, by using a wait zone and a wait time, until any deviation is cancelled.

A wait zone is a deviation bandwidth from which the degree of PV input tracking is judged.

A wait time is the length of time that elapses until the PV input enters the wait zone. The program progresses if the PV input fails to re-enter the wait zone within the wait time.

When the program is in wait state, the time setpoints of Segment Time and Time Event parameters temporarily cease to be passed. At this point, the output based on the Time Event parameter is retained.

4. Operations

This chapter describes key entries for operating the controller. For operations using external contact inputs, see “1.5 Terminal Wiring Diagrams.” If you cannot remember how to carry out an operation during setting, press the **DISP** key no more than four times. This brings you to the display (operating display) that appears at power-on.

4.1 Monitoring-purpose Operating Displays Available during Operation

The monitoring-purpose operating displays available during operation include those for controllers of Dual-loop and Dual-loop position proportional control and those for controllers of Dual-loop heating/cooling control.

The Process Variable (PV) display always shows the value of PV input.

■ Operating Displays for Dual-loop and Dual-loop Position Proportional Control

● PV2/SP/TM/RCY Display

The PV input value of Loop1 appears on the PV display.

On the Setpoint display (LCD), the controller displays the PV input value of Loop2 (PV2), the PID number (PID) being used, the current setpoint of Loop1 (SP1), the current setpoint of Loop2 (SP2), the program pattern number (PT) selected, the segment number (SG) for which operation is in progress, the number of segments included in the selected program pattern, the remaining time of the segment for which operation is in progress, the current number of repetitions (RCY), and the total sum of repetitions.

● Target SP Display (Loop1 and Loop2)

The PV input value of Loop1 appears on the PV display.

On the Setpoint display (LCD), the controller displays the program setpoint (SP1) and final target setpoint (TSP), the program setpoint (SP2) and final target setpoint (TSP), the program pattern number (PTNO) selected, the segment number (SEGNO) for which operation is in progress, the number of segments included in the selected program pattern, the program pattern name (only displayed when setting the program pattern name using an optional parameter setting tool (model: LL100-E10)).

● PV2/OUT Display (Loop1)

The PV input value of Loop1 appears on the PV display.

On the Setpoint display (LCD), the controller displays the PV input value of Loop2 (PV2), the program pattern number (PTNO), the segment number (SEGNO) for which operation is in progress, and the number of segments included in the selected program pattern, and the control output value (OUT).

- **PV2/OUT Display (Loop2)**

The PV input value of Loop2 appears on the PV display.

On the Setpoint display (LCD), the controller displays the PV input value of Loop2 (PV2), the program pattern number (PTNO), the segment number (SEGNO) for which operation is in progress, and the number of segments included in the selected program pattern, and the control output value (OUT).

- **Deviation Trend Display (Loop1)**

The PV input value of Loop1 appears on the PV display.

On the Setpoint display (LCD), the controller displays the deviation trend.

- **Deviation Trend Display (Loop2)**

The PV input value of Loop2 appears on the PV display.

On the Setpoint display (LCD), the controller displays the deviation trend.

- **Pattern Display**

On the Setpoint display (LCD), the controller displays the selected program pattern.

- **Event Display**

On the Setpoint display (LCD), the controller displays the event number for which an event has occurred.

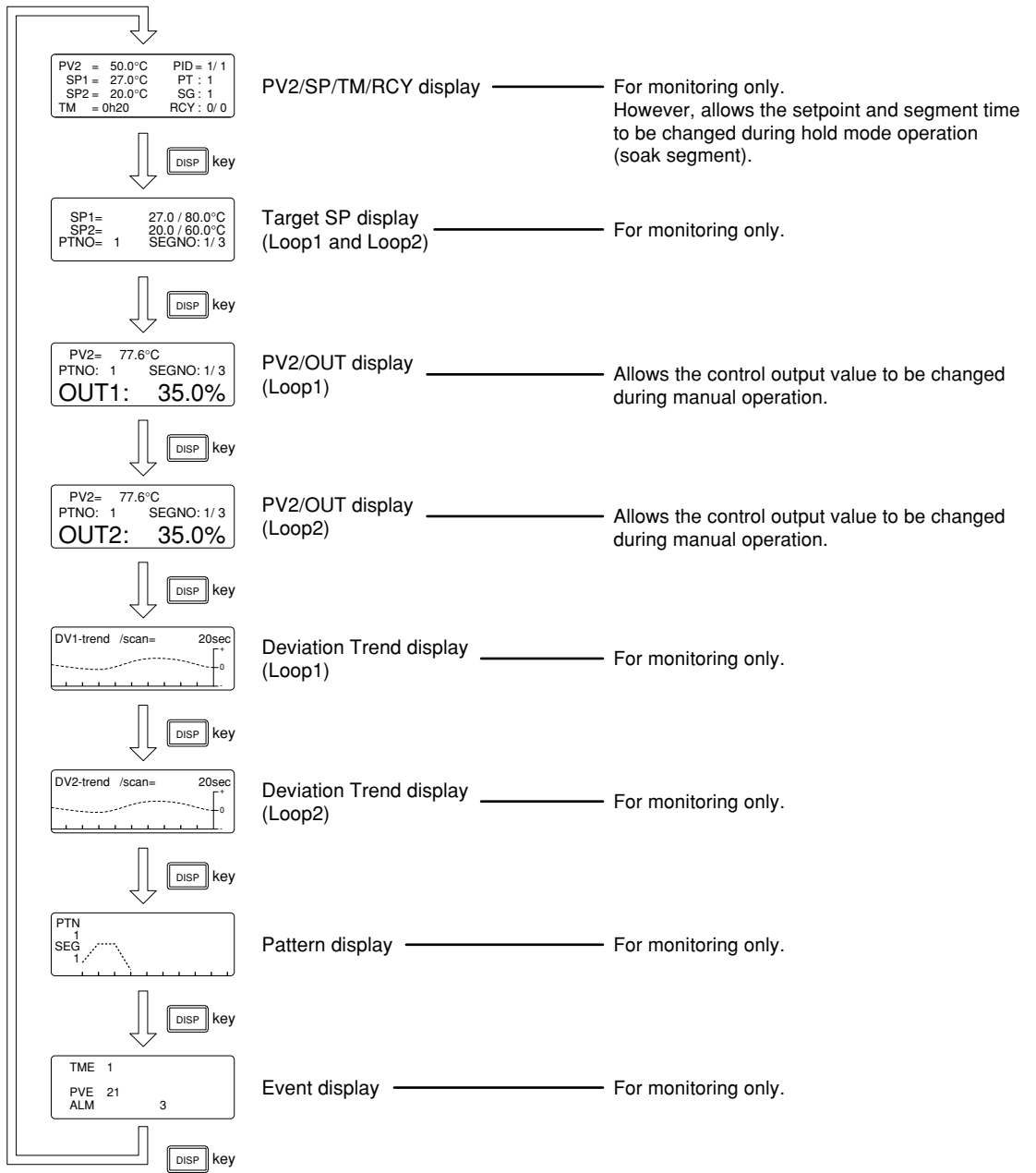

■ Operating Displays for Dual-loop Heating/Cooling Control

● PV2/SP/OUT2 Display

The PV input value of Loop1 appears on the PV display.

On the Setpoint display (LCD), the controller displays the PV input value of Loop2 (PV2), the PID number (PID) being used, the current setpoint of Loop1 (SP1), the current setpoint of Loop2 (SP2), the program pattern number (PT) selected, the segment number (SG) for which operation is in progress, the number of segments included in the selected program pattern, the remaining time of the segment (TM) for which operation is in progress, the current number of repetitions (RCY), and the total sum of repetitions.

● Target SP Display (Loop1 and Loop2)

The PV input value of Loop1 appears on the PV display.

On the setpoint display (LCD), the controller displays the program setpoint (SP1) and final target setpoint (TSP), the program setpoint (SP2) and final target setpoint (TSP), the program pattern number (PTNO) selected, the segment number (SEGNO) for which operation is in progress, the number of segments included in the selected program pattern, the program pattern name (only displayed when setting the program pattern name using an optional parameter setting tool (model: LL100-E10)).

● Heating/Cooling PV2/OUT Display (Loop1)

The PV input value of Loop1 appears on the PV display.

On the Setpoint display (LCD), the controller displays the PV input value of Loop2 (PV2), the program pattern number (PTNO), the segment number (SEGNO) for which operation is in progress, the number of segments included in the selected program pattern, and the heating-side (HEAT) and cooling-side (COOL) control output values.

● Heating/Cooling PV2/OUT Display (Loop2)

The PV input value of Loop2 appears on the PV display.

On the Setpoint display (LCD), the controller displays the PV input value of Loop2 (PV2), the program pattern number (PTNO), the segment number (SEGNO) for which operation is in progress, the number of segments included in the selected program pattern, and the heating-side (HEAT) and cooling-side (COOL) control output values.

● Deviation Trend Display (Loop1)

The PV input value of Loop1 appears on the PV display.

On the Setpoint display (LCD), the controller displays the deviation trend.

● Deviation Trend Display (Loop2)

The PV input value of Loop2 appears on the PV display.

On the Setpoint display (LCD), the controller displays the deviation trend.

● Pattern Display

The PV input value of Loop1 appears on the PV display.

On the Setpoint display (LCD), the controller displays the selected program pattern.

● Event Display

The PV input value of Loop1 appears on the PV display.

On the Setpoint display (LCD), the controller displays the event number for which an event has occurred.

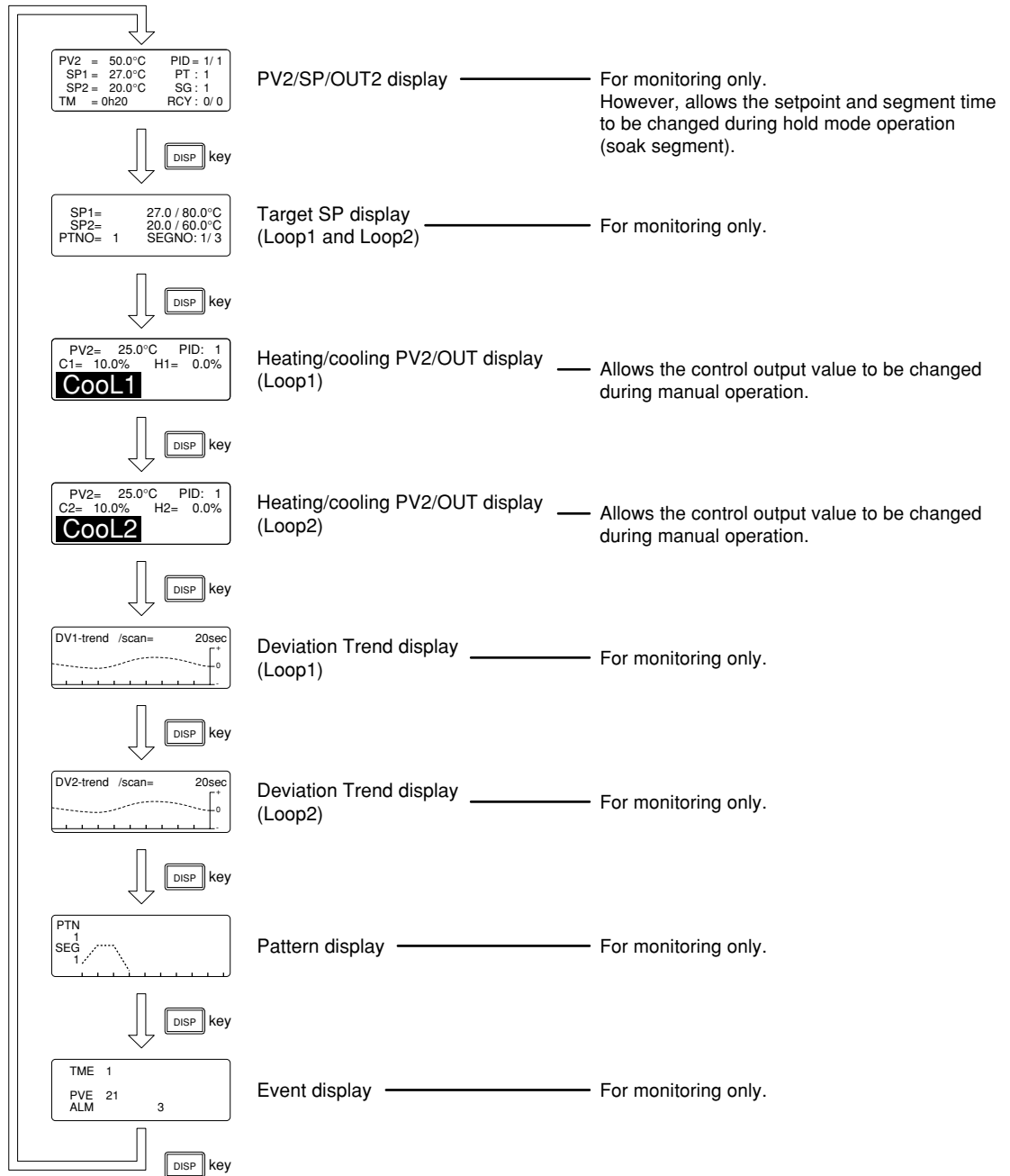

4.2 Performing/Canceling Auto-tuning of Loop1

Perform auto-tuning when you have finished creating program patterns. Make sure the controller is in program (RUN) mode and in automatic (AUTO) mode before carrying out auto-tuning. See “4.7 Switching between RUN and RESET Modes,” to change to RUN or “4.8 Switching between AUTO and MAN of Loop1,” to change to AUTO.

PID constants are obtained by using the current program setpoint value at the start of auto-tuning.

NOTE

When on-off control is being used, auto-tuning cannot be carried out. Moreover, do not perform auto-tuning when controlling any of the following processes.

- Control processes with quick response such as flow control or pressure control
- Processes where even temporary output on/off results in inconvenience
- Processes where a large output change at control element results in inconvenience
- Processes where variations in PV may exceed an allowable range, adversely affecting product quality

1. Bring the operating display into view (display appears at power on).

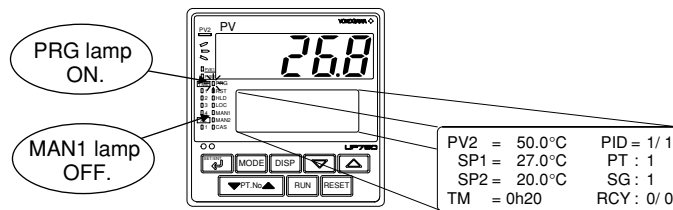

In steps 2 and later, illustrations of the LCD are cited to explain the procedure.

2.

Press the  key for **more than 3 seconds** to call up the main menu “PROG”.

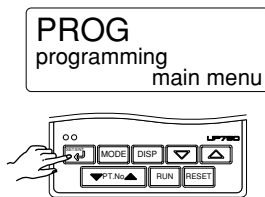

3. Press the  key twice to display the main menu “LP1”.

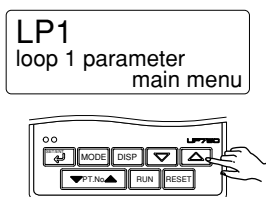

4. Press the  key to display the submenu “PAR”.

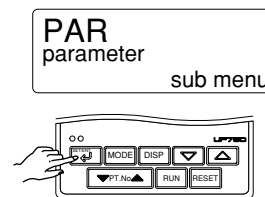

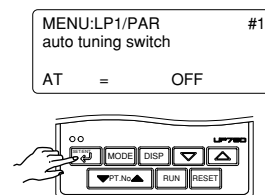

5. Press the  key once again to display the parameter “AT”.

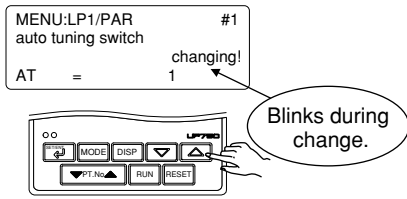

- 6. Press the  or  key to display the required setpoint. Tuning for 1st group of PID is AT = 1.



To cancel auto-tuning, set AT = OFF.

- 7. Press the  key once to register the setpoint. (This starts auto-tuning.) If the  key is pressed when AT = OFF, auto-tuning will be cancelled. In this case, PID contains the value existing before auto-tuning.

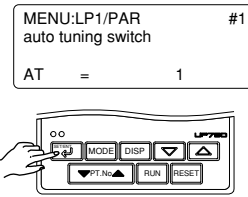

- 8. During auto-tuning, the panel indications become as shown below.

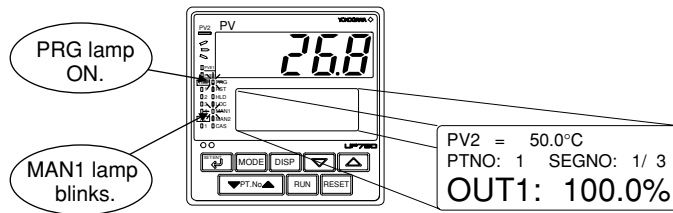

Auto-tuning is complete when the MAN1 lamp goes off.

4.3 Performing/Canceling Auto-tuning of Loop2

Perform auto-tuning when you have finished creating program patterns. Make sure the controller is in program (RUN) mode and in automatic (AUTO) mode before carrying out auto-tuning. See “4.7 Switching between RUN and RESET Modes,” to change to RUN or “4.9 Switching between AUTO and MAN of Loop2,” to change to AUTO.

PID constants are obtained by using the current program setpoint value at the start of auto-tuning.

NOTE

When on-off control is being used, auto-tuning cannot be carried out. Moreover, do not perform auto-tuning when controlling any of the following processes.

- Control processes with quick response such as flow control or pressure control
- Processes where even temporary output on/off results in inconvenience
- Processes where a large output change at control element results in inconvenience
- Processes where variations in PV may exceed an allowable range, adversely affecting product quality

1. Bring the operating display into view (display appears at power on).

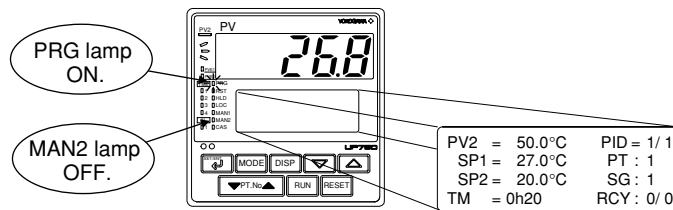

In steps 2 and later, illustrations of the LCD are cited to explain the procedure.

2. Press the  key for **more than 3 seconds** to call up the main menu “PROG”.

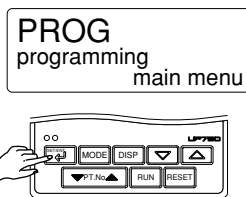

3. Press the  key three times to display the main menu “LP2”.

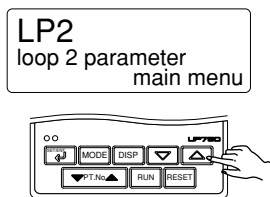

4. Press the  key to display the submenu “PAR”.

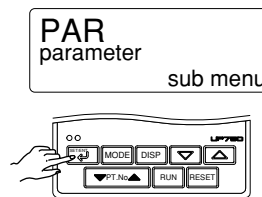

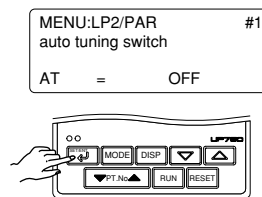

5. Press the  key once again to display the parameter “AT”.

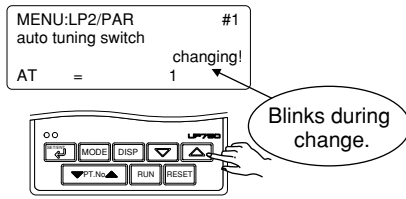

- 6. Press the  or  key to display the required setpoint. Tuning for 1st group of PID is AT = 1.



To cancel auto-tuning, set AT = OFF.

- 7. Press the  key once to register the setpoint. (This starts auto-tuning.) If the  key is pressed when AT = OFF, auto-tuning will be cancelled. In this case, PID contains the value existing before auto-tuning.

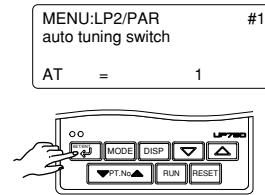

- 8. During auto-tuning, the panel indications become as shown below.

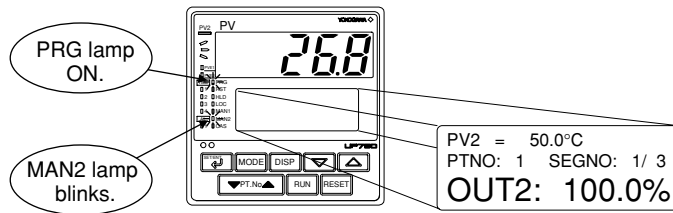

Auto-tuning is complete when the MAN1 lamp goes off.

4.4 Setting PID Manually of Loop1

If you know the values to be set or if suitable PID constants cannot be obtained by auto-tuning, follow the procedure below to set values.

- 1. Bring the operating display into view (display appears at power on).

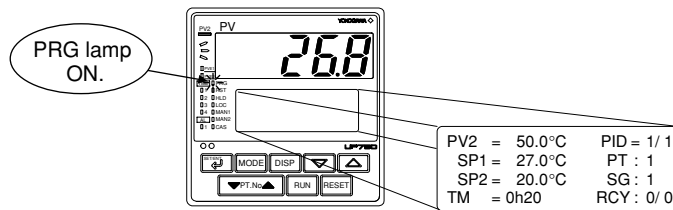

In steps 2 and later, illustrations of the LCD are cited to explain the procedure.

- 2. Press the  key for more than 3 seconds to call up the main menu "PROG".

PROG
programming
main menu

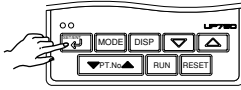

- 3. Press the  key twice to display the main menu "LP1".

LP1
loop 1 parameter
main menu

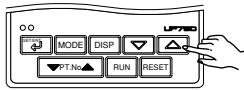

- 4. Press the  key once to display the submenu "PAR".

PAR
parameter
sub menu

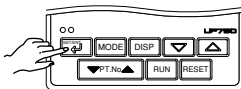

- 5. Press the  key once to display the submenu "1.PID".

1.PID
PID parameter SPno.1
sub menu

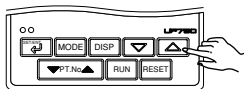

- 6. Press the  key once to display the parameter "1.P".

MENU:LP1/1.PID #1
proportional band
1.P = 5.0%

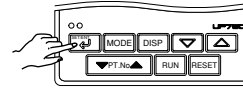

- 7. Press the  or  key to display the required setpoint.

MENU:LP1/1.PID #1
proportional band
1.P = 18.0%

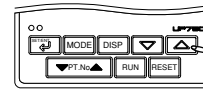

Blinks during change.

- 8. Press the  key once to register the setpoint.

MENU:LP1/1.PID #1
proportional band
1.P = 18.0%

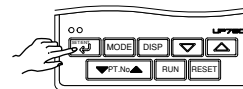

The same steps can be used for integral time (1.I) and derivative time (1.D) that are displayed after this.

- 9. Press the  key for more than 3 seconds. This returns you to the display shown at power-on (figure below).

PRG lamp ON.

PV2 = 50.0°C	PID = 1/1
SP1 = 27.0°C	PT : 1
SP2 = 20.0°C	SG : 1
TM = 0h20	RCY : 0/0

4.5 Setting PID Manually of Loop2

If you know the values to be set or if suitable PID constants cannot be obtained by auto-tuning, follow the procedure below to set values.

1. Bring the operating display into view (display appears at power on).

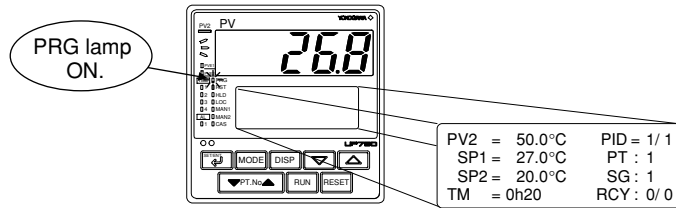

In steps 2 and later, illustrations of the LCD are cited to explain the procedure.

2. Press the key for more than 3 seconds to call up the main menu "PROG".

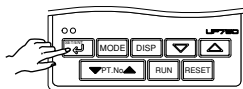

3. Press the key three times to display the main menu "LP2".

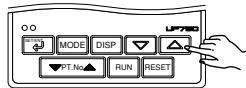
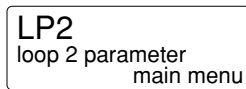

4. Press the key once to display the submenu "PAR".

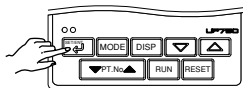
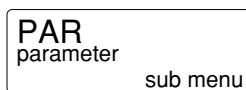

5. Press the key once to display the submenu "1.PID".

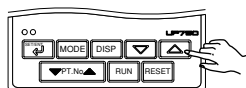
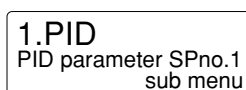

6. Press the key once to display the parameter "1.P".

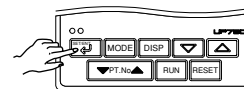
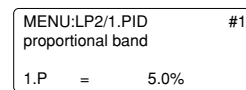

7. Press the or key to display the required setpoint.

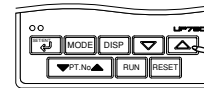
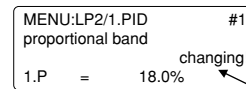

Blinks during change.

8. Press the key once to register the setpoint.

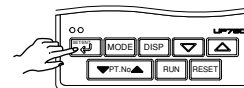
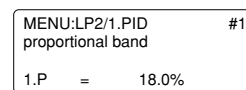

The same steps can be used for integral time (1.I) and derivative time (1.D) that are displayed after this.

9. Press the  key for **more than 3 seconds**. This returns you to the display shown at power-on (figure below).

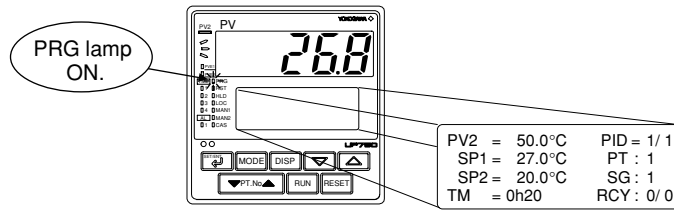

4.6 Selecting the Program Pattern Number (PT.No)

The following operating procedure selects program pattern 1. A program pattern number can only be selected when the controller is in a RESET mode. Simultaneously for Loop1 and Loop2.

 **NOTE**

If contact input, which is used to select between program pattern numbers is on, any program pattern number cannot be selected by key operation.

1. Bring the operating display into view (appears at power-on).

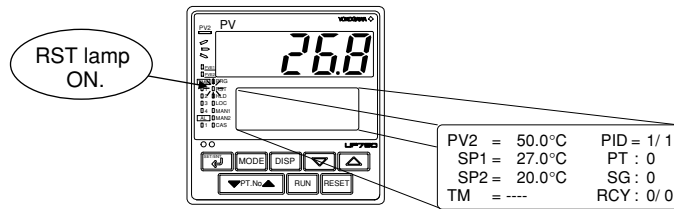

2. Press the  key. This selects the program pattern number.

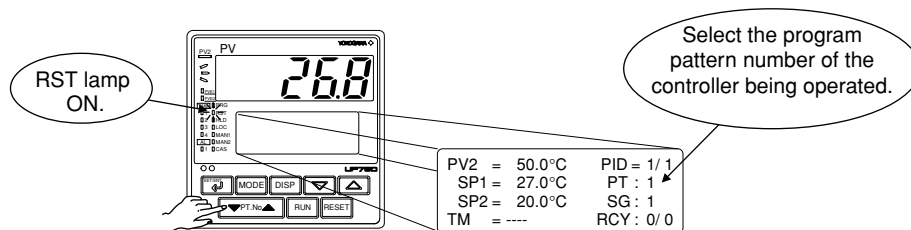

4.7 Switching between RUN and RESET Modes

The following operating procedure switches the RUN mode and the RESET mode. Simultaneously for Loop1 and Loop2.

1. Brings the operating display into view (appears at power-on).

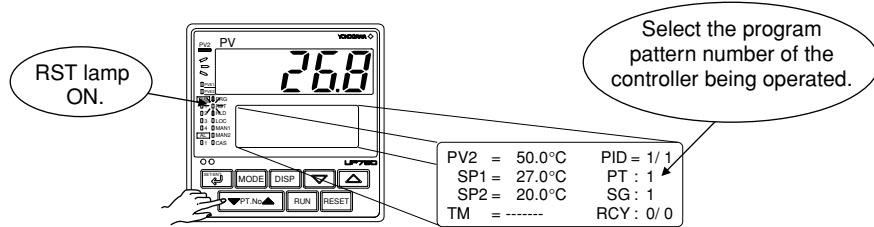

2. Press the **RUN** key for 2 seconds. The selected program pattern starts.

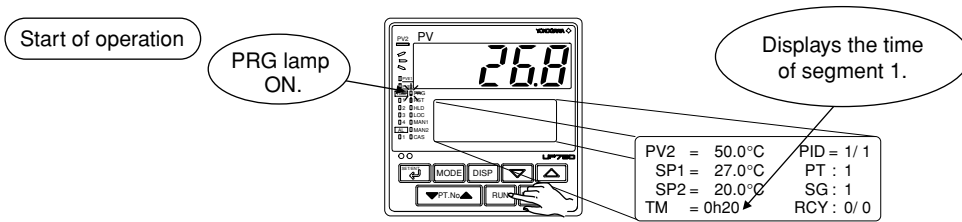

3. Hold down the **RESET** key for 2 seconds. The running program stops.

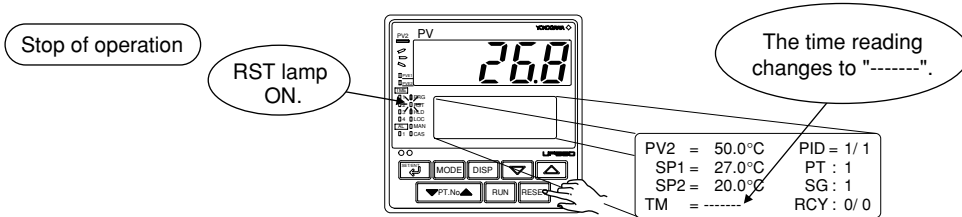

When in the RESET mode, the controller provides the following input/output values.

PV input (Loop1, Loop2)	Value of process variable
Control output (Loop1, Loop2)	Preset output value (factory-set to 0%)
Event output	OFF, if there is any event.

4.8 Switching between AUTO and MAN of Loop1

NOTE

If AUTO and MAN of Loop1 have been switched using contact input, when the contact input is ON, switching between AUTO and MAN cannot be achieved by keystroke.

1. Brings the operating display into view (appears at power-on).

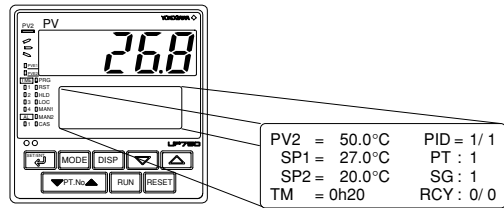

2. [To change from AUTO to MAN mode]
Press the **MODE** key several times to display the MODE:MAN1 mode parameter.

[To change from MAN to AUTO mode]
Press the **MODE** key several times to display the MODE:AUTO1 mode parameter.

The figure below is an example of changing the AUTO mode to the MAN mode.

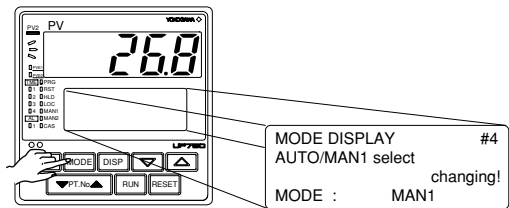

3. Press the **RETRN** key once. The controller switches to either MAN-mode or AUTO-mode operation. The figure below is an example of the display after a change from the AUTO mode to the MAN mode.

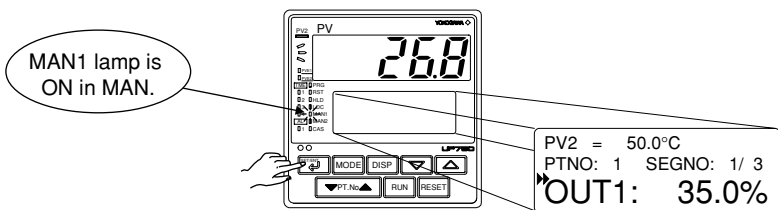

* MAN1 lamp is OFF in AUTO.

4.9 Switching between AUTO and MAN of Loop2

NOTE

If AUTO and MAN of Loop2 have been switched using contact input, when the contact input is ON, switching between AUTO and MAN cannot be achieved by keystroke.

- 1. Brings the operating display into view (appears at power-on).

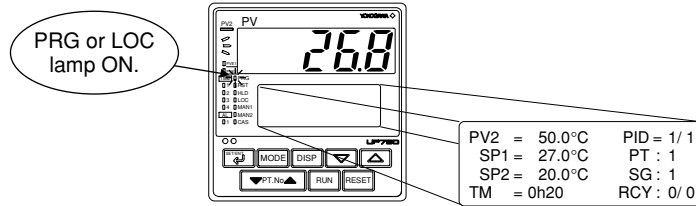

- 2. [To change from AUTO to MAN mode]
Press the **MODE** key several times to display the MODE:MAN2 mode parameter.
- [To change from MAN to AUTO mode]
Press the **MODE** key several times to display the MODE:AUTO2 mode parameter.

The figure below is an example of changing the AUTO mode to the MAN mode.

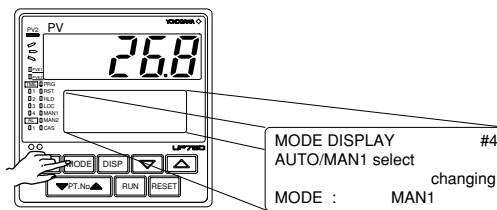

- 3. Press the **RETRY** key once. The controller switches to either MAN-mode or AUTO-mode operation. The figure below is an example of the display after a change from the AUTO mode to the MAN mode.

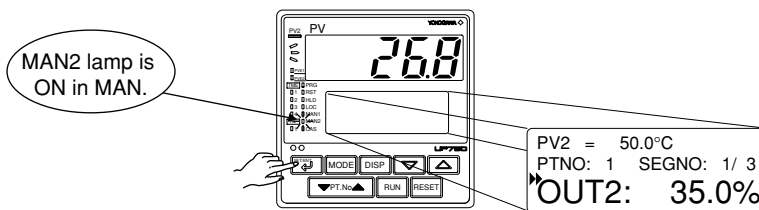



* MAN2 lamp is OFF in AUTO.

4.10 Manipulating Control Output during Manual Operation of Loop1

NOTE

Control output cannot be changed if the controller is in the RESET mode. In this case, the preset output value (operating parameter PO) will be output.

A control output value is linked with a display value changed using the  or  key. Note that the control output changes as displayed without requiring the  key.

1. Bring manual operating display into view. For switching to manual operation, see “4.8 Switching between AUTO and MAN of Loop1.”

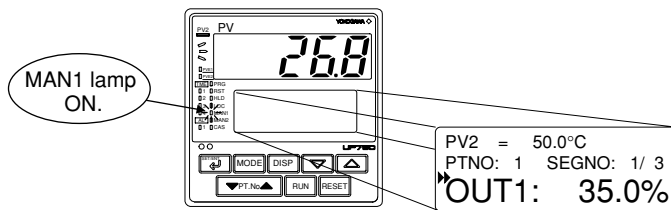

2. Press the  or  key to change a control output value. You don't need to press the  key.

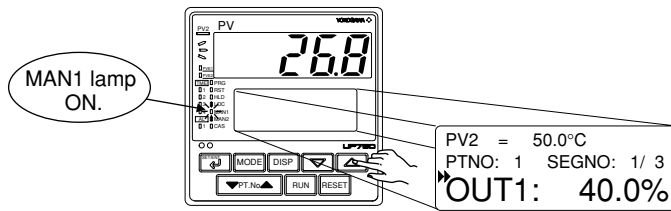



■ Manipulating the Control Output during Heating/Cooling Control

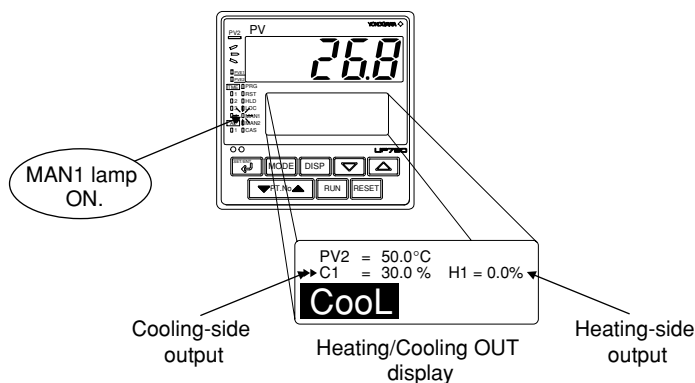

Showing the Heating/Cooling OUT display of Loop1.



● Controller Behavior and Control Output Manipulation when the Dead Band is Positive

The following is an example when the DB parameter is set at 12.4%.

If you hold down the  key with the heating-side output under manipulation (i.e., cooling-side output C1 = 0.0%), the heating-side output (H1 =) decreases. Consequently, both the heating-side and cooling-side outputs change to 0.0%. If you keep the  key held down longer, you enter the state of manipulating the cooling-side output, and its value begins to increase.

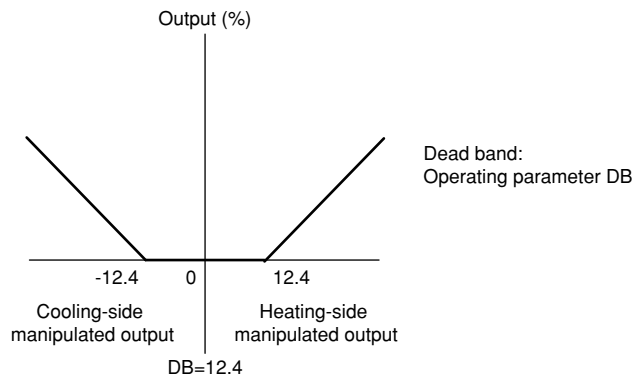

Inversely, if you hold down the  key with the cooling-side output under manipulation (i.e., heating-side output H1 = 0.0%), the cooling-side output (C1 =) decreases. Consequently, both the heating-side and cooling-side outputs go to 0.0%. If you keep the  key held down longer, you enter the state of manipulating the heating-side output, and its value begins to increase.



Change in manipulated output when the dead band is positive

● Controller Behavior and Control Output Manipulation when the Dead Band is Negative

The following is an example when the DB parameter is set at -12.4%.

If you hold down the  key with the heating-side output under manipulation (i.e., cooling-side output C1 = 0.0%), the heating-side output (H1 =) decreases. If the output H1 falls below 24.8%, the cooling-side output C1 begins to increase from 0.0%. If you keep the  key held down longer and the output C1 rises above 24.8%, the output H1 goes to 0.0% and you enter the state of manipulating the cooling-side output.

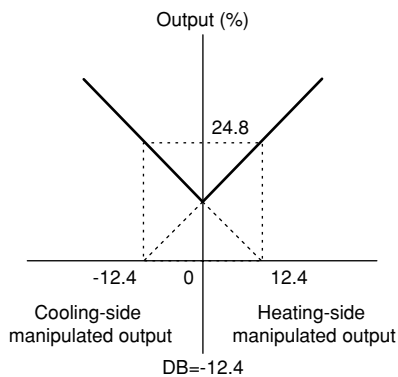



Change in manipulated output when the dead band is negative

4.11 Manipulating Control Output during Manual Operation of Loop2

NOTE

Control output cannot be changed if the controller is in the RESET mode. In this case, the preset output value (operating parameter PO) will be output.

A control output value is linked with a display value changed using the  or  key. Note that the control output changes as displayed without requiring the  key.

1. Bring manual operating display into view. For switching to manual operation, see “4.9 Switching between AUTO and MAN of Loop2.”

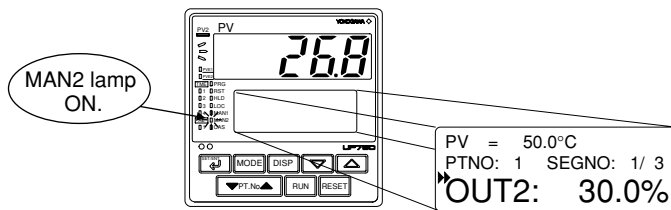

2. Press the  or  key to change a control output value. You don't need to press the  key.

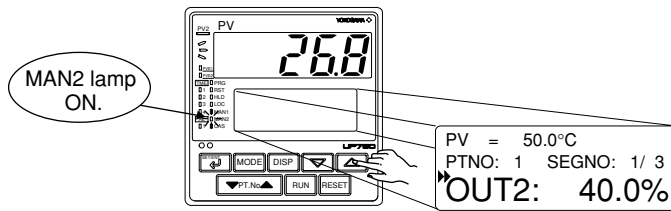



■ Manipulating the Control Output during Heating/Cooling Control

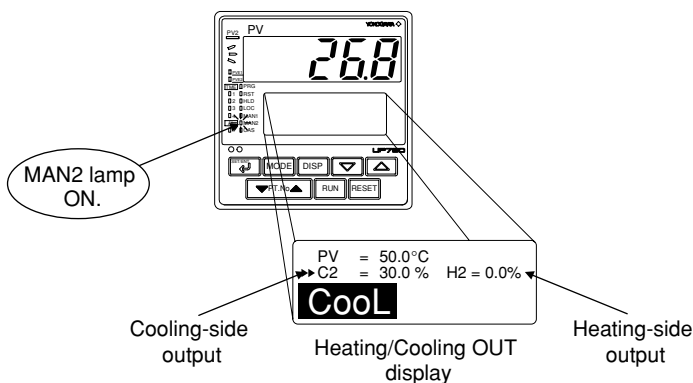

Showing the Heating/Cooling OUT display of Loop2.



● Controller Behavior and Control Output Manipulation when the Dead Band is Positive

The following is an example when the DB parameter is set at 12.4%.

If you hold down the  key with the heating-side output under manipulation (i.e., cooling-side output C2 = 0.0%), the heating-side output (H2 =) decreases. Consequently, both the heating-side and cooling-side outputs change to 0.0%. If you keep the  key held down longer, you enter the state of manipulating the cooling-side output, and its value begins to increase.

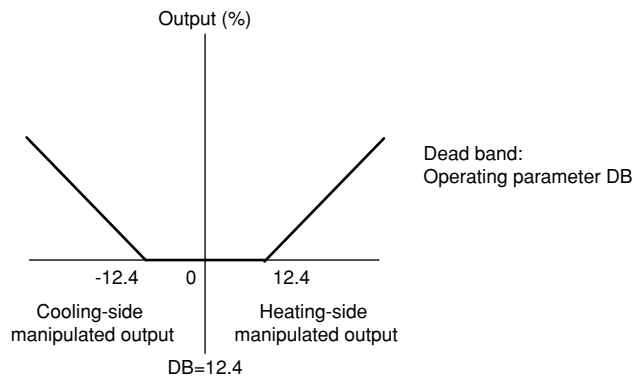

Inversely, if you hold down the  key with the cooling-side output under manipulation (i.e., heating-side output H2 = 0.0%), the cooling-side output (C2 =) decreases. Consequently, both the heating-side and cooling-side outputs go to 0.0%. If you keep the  key held down longer, you enter the state of manipulating the heating-side output, and its value begins to increase.



Change in manipulated output when the dead band is positive

● Controller Behavior and Control Output Manipulation when the Dead Band is Negative

The following is an example when the DB parameter is set at -12.4%.

If you hold down the  key with the heating-side output under manipulation (i.e., cooling-side output C2 = 0.0%), the heating-side output (H2 =) decreases. If the output H2 falls below 24.8%, the cooling-side output C2 begins to increase from 0.0%. If you keep the  key held down longer and the output C2 rises above 24.8%, the output H2 goes to 0.0% and you enter the state of manipulating the cooling-side output.

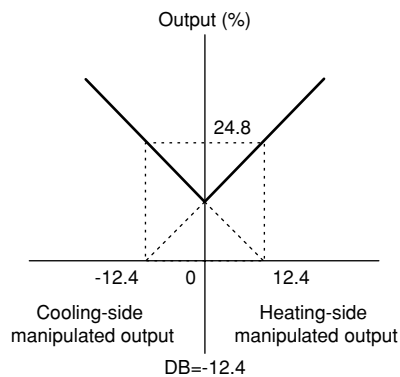

Change in manipulated output when the dead band is negative

4.12 Enabling/Disabling the Hold Mode of Program Operation

Enabling/disabling the hold mode of program operation should be done when the controller is in operation.

The following operating procedure is an example of setting program operation in the hold mode.

Simultaneously for Loop1 and Loop2.

1. Bring the operating display into view (appears at power-on).

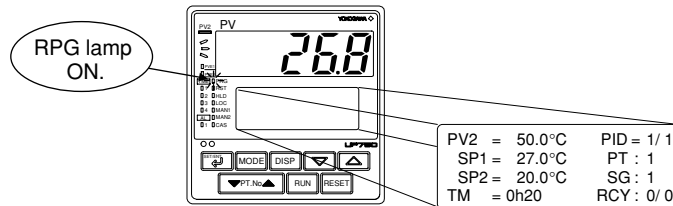

2. [To enable the hold mode of program operation]
Press the **MODE** key once to display the HOLD:ON mode parameter.

[To disable the hold mode of program operation]
Press the **MODE** key once to display the HOLD:OFF mode parameter.

The figure below is an example of enabling the hold mode of program operation.

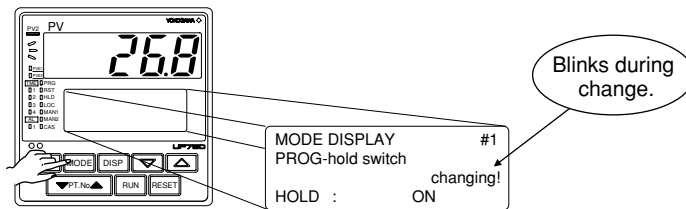

3. Press the **RESET** key once. The controller switches from the either hold mode or non-hold mode.

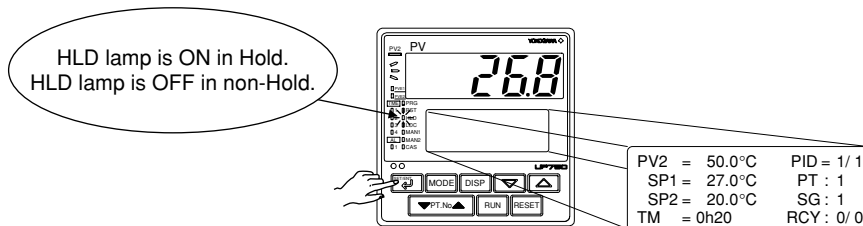

* Other operating procedures for disabling the hold mode:

- [1] Press the **RUN** key for two seconds during hold-mode operation. In this case, the controller resumes program operation.
- [2] Execute the “advance” function during hold-mode operation. In this case, the segment is advanced.

4.13 Changing Program Setpoints when in Hold Mode

The following operating procedure changes program setpoints when program operation in soak segment is put in hold mode.

When you have finished changing the setpoints, disable the hold mode of program operation as instructed in, "4.12 Enabling/Disabling the Hold Mode of Program Operation." The controller resumes program operation when the hold mode is disabled.

1. Set program operation in the hold mode. To do this, see "4.12 Enabling/Disabling the Hold Mode of Program Operation."

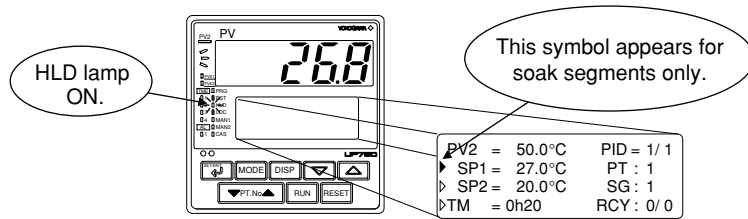

2. Press the key once to display the symbol "▶▶".

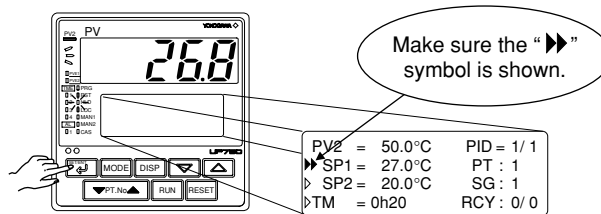

3. Press the or key to change the setpoint.

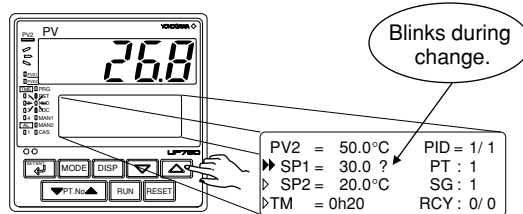

4. Press the key once to require the setpoint.

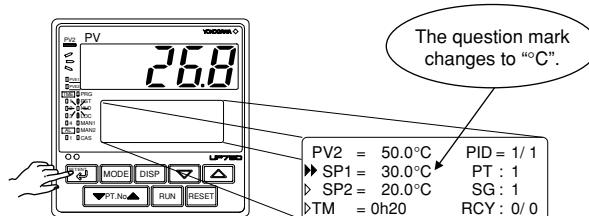

4.14 Executing the “Advance” Function

The following operating procedure advances the controller from segment 1 to segment 2. If you execute the “advance” function during hold-mode operation, the hold mode is disabled. Simultaneously for Loop1 and Loop2.

1. Bring the current operating display for program operation into view.

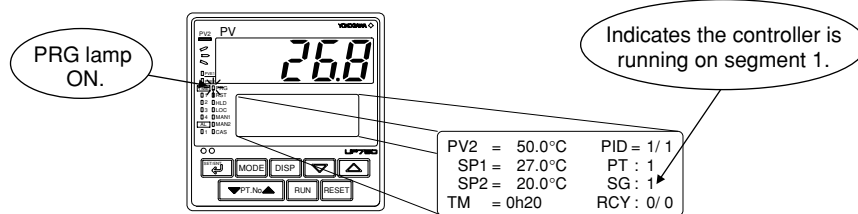

2. Press the **MODE** key twice to display the LOC:ON mode parameter.

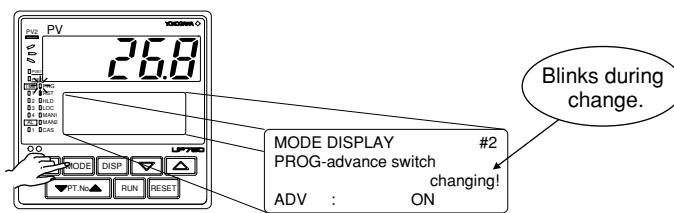

3. Press the **REVERT** key once. The controller resumes operation from the target setpoint of segment 1.

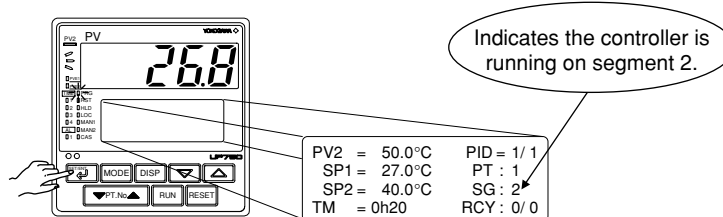

4.15 Switching to Local-mode (LOCAL) Operation

The controller can be switched to local-mode operation when it is in program operation or in a RESET mode.

The following operating procedure switches the controller to local-mode operation during program operation.

Simultaneously for Loop1 and Loop2.

1. Bring the current display for program operation into view.

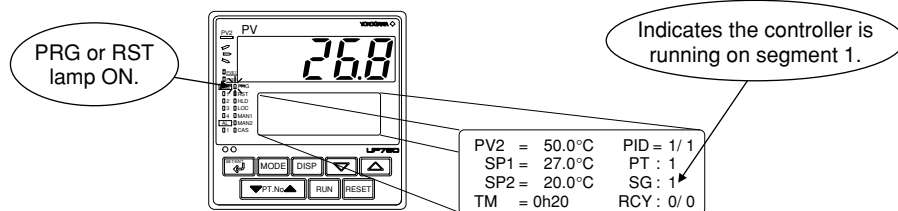

2. Press the **MODE** key several times to display the LOC:ON mode parameter.

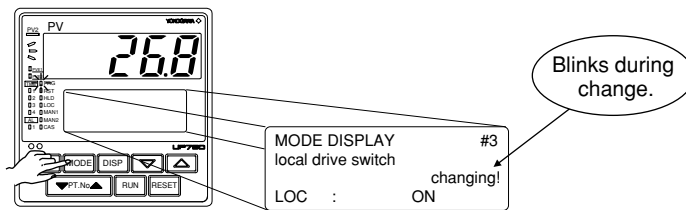

3. Press the **RETRY** key once. The controller begins running with a local setpoint (L.SP). The figure below shows an example of setting the controller with the local setpoint of 50.0°C.

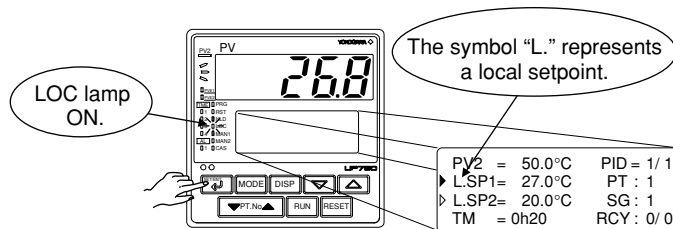

4.16 Changing Setpoints during Local-mode Operation

The following operating procedure changes setpoints during local-mode operation.

1. Change the controller to local-mode operation. To do this, see “4.15 Switching to Local-mode (LOCAL) Operation.”

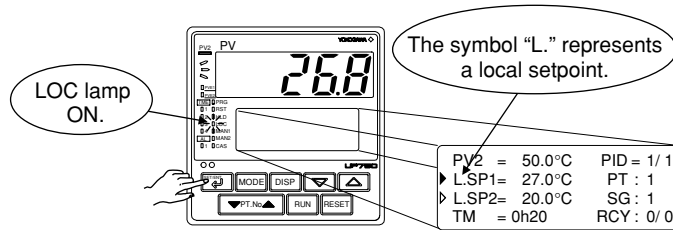

L.SP1: Local setpoint of Loop1

L.SP2: Local setpoint of Loop2

When changing the local setpoint of Loop2, press the ▲ or ▼ key to display “▶ L.SP2”.

2. Press the key once to display the symbol “▶▶”.

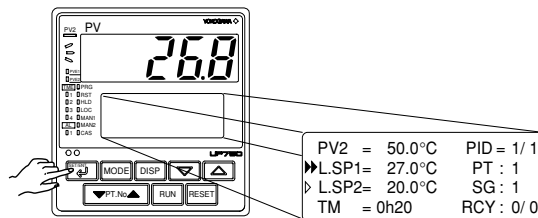

3. Press the ▲ or ▼ key to change the local setpoint.

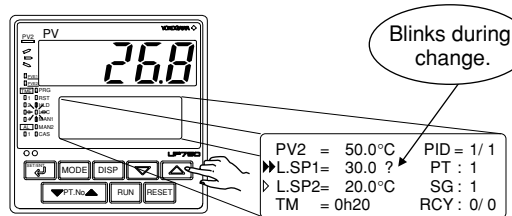

4. Press the key once to register the setpoint.

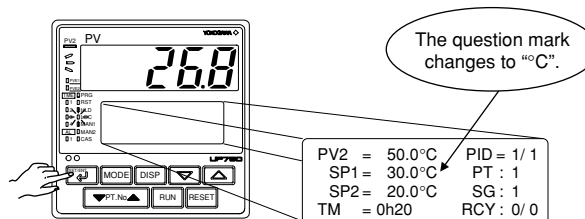

5. Troubleshooting and Maintenance

5.1 Troubleshooting

■ Troubleshooting Flow

If the operating display does not appear after turning on the controller's power, follow the measures in the procedure below.

If a problem appears complicated, contact our sales representative.

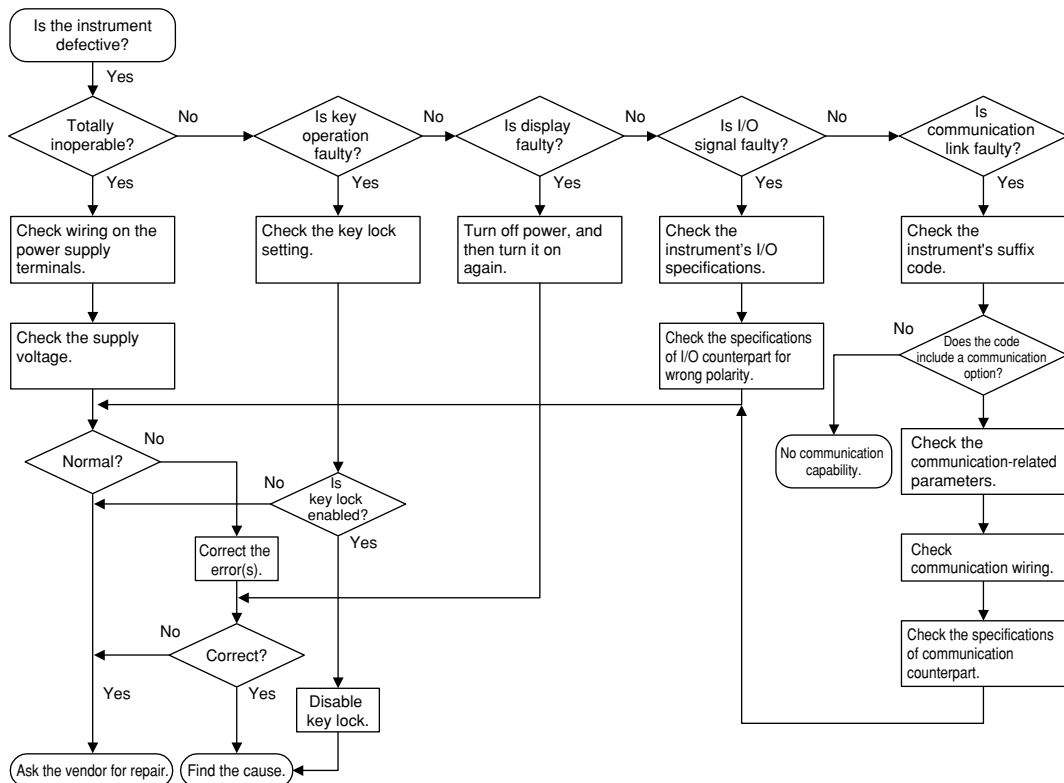

IMPORTANT

Take note of the parameter settings when asking the vendor for repair.

■ Errors at Power on

The following table shows errors that may be detected by the fault diagnosis function when the power is turned on.

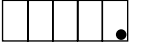
Display position (Note)	Error indication	Description of error	PV	Control output	Alarm output	Retransmission output	Communication	Remedy
1	E000	Faulty RAM	None	0% or less or OFF	OFF	0% or less	Stopped	Faulty Contact us for repair.
	E001	Faulty ROM			Undefined	Undefined		
	E002	System data error	Undefined	Undefined	Undefined	Undefined		
	PV decimal point blinks. 	Faulty calibration value	Normal action (out of accuracy)	Normal action (out of accuracy)	Normal action (out of accuracy)	Normal action (out of accuracy)	Normal action	
2	Error code (See description below.)	Parameter error	Normal action	0% or less or OFF	Normal action	Normal action		Check and set the initialized parameters.

Note 1: PV display
 Note 2: Setpoint display

An error code is displayed in the event of an error, according to its type.

An error code is a two-digit figure in which a combination of 6 bits of on and off is converted into a decimal number.

The following shows the relationship between each bit and parameter to be checked for abnormality.

Bit No.	6	5	4	3	2	1	0
Parameter to be checked	Operation mode/output	Operating parameters	Setup parameters	Range data	UP mode	Custom computing data	Calibration data

For example, if an error occurs with the operating parameter and calibration data, the error code will be as follows:

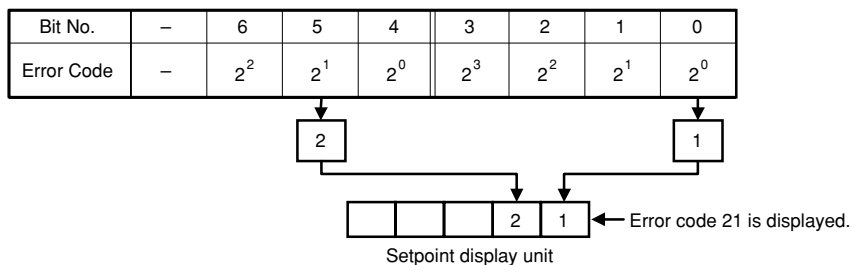

■ Possible Errors during Operation

The following shows possible errors occurring during operations.

Display position (Note)	Error indication	Description of error	PV	Control output	Alarm output	Retransmission output	Communication	Remedy
3	Displays "RJC" and PV alternately	RJC error	Measured with RJC=0	Normal action	Normal action	Normal action	Normal action	Faulty Contact us for repair.
	E300	ADC error	105%	In AUTO: Preset value output In MAN: Normal action				Check wires and sensor.
	B.OUT	PV burnout error	Dependent on the BSL parameter Up-scale: 105% Down-scale: -5%	Normal action				Check process.
	OVER or -OVER	Excessive PV Out of -5 to 105%	-5% or 105%	Normal action				Check process. Press any key to erase error indication.
2	Left end of Setpoint display unit blinks.	Faulty communication line	Normal action	Action with PID existing before auto-tuning	Normal action	Normal action	Check wires and communication parameters, and make resetting. Recovery at normal receipt	
				Normal action				
1	Decimal point at right end lights. 	Runaway (due to defective power or noise)	Undefined	0% or less or OFF	OFF	0% or less	Stopped	Faulty if power off/on does not reset start the unit. Contact us for repair.
No display	All indications off	Power off	None					Check for abnormal power.

Note 1: PV display
 2: Setpoint display
 3: Display showing the PV of the corresponding loop

■ Remedies if Power Failure Occurs during Operations

The operation status and remedies after a power failure differ with the length of power failure time:

● Instantaneous Power Failure of 20 ms or less

A power failure is not detected. Normal operation continues.

● Power Failure of about 2 seconds or less

The following show effects caused in "settings" and "operation status."

Alarm action	Continues. Alarm with standby function will enter standby status.
Setting parameter	Set contents of each parameter are retained.
Auto-tuning	Cancelled.
Control action	Action before power failure continues.

● **Power Failure of more than about 2 seconds**

The following show effects caused in “settings” and “operation status.”

Alarm action	Continues. Alarm with standby function will enter standby status.	
Setting parameter	Set contents of each parameter are retained.	
Auto-tuning	Cancelled.	
Control action	Differs with setting of setup parameter “R.MD”(restart mode).	
	R.MD setting	Control action after recovery from power failure
	CONT	Action before power failure continues. (factory-shipped setting)
	MAN	Outputs preset output value (PO) (NOTE) as control output and continues action set before power failure in MAN mode.
	RESET	Outputs preset output value (PO) (NOTE) as control output and continues action set before power failure in AUTO mode. Operation mode is set to RESET.
NOTE : For heating/cooling control, the preset output value is 50% of PID computation.		

■ **Troubleshooting when the Controller Fails to Operate Correctly**

If your control tasks are not successful, check the preset parameters and controller wiring before concluding the controller to be defective. The following show some examples of troubleshooting you should refer to in order to avoid the possibility of other problems.

● **The Controller does not Show the Correct Process Variable (PV).**

- The UP750 controllers have a universal input.
The type of PV input can be set/changed using the parameter “IN1,” “IN2.” At this point, the controller must be wired correctly according to the selected type of PV input. Check the wiring first if the controller fails to show the correct PV value. To do this, refer to “2. Initial Settings.”
With the parameters “RH1”, “RL1”, “SDP1”, “SH1” and “SL1”, it is possible to scale the input signal and change its number of decimal places. Also check that these parameters are configured correctly.

● **The Controller does not Provide any Control Output or the Control Output does not Change at all.**

- The UP750 controllers have a universal output.
The type of control output can be set/changed using the parameter “OT1,” “OT2.” At this point, the controller must be wired correctly according to the selected type of control output. Check the wiring first if the controller provides no control output. To do this, refer to “1.5 Terminal Wiring Diagrams.”
With the parameters “OH” and “OL”, it is possible to set/change the high and low limits of control output. The control output may not change at all, however, because of restrictions on these parameters. Also check the restrictions on these parameters.
- The control output can only be changed when the controller is in the MAN mode.
If the MAN lamp is off (i.e., the controller is in the AUTO mode), you cannot change the control output using key operation.

● **The Control Output does not Change soon after the Target Setpoint SP has been Changed.**

- If this happens, check the setpoint of the parameter “MOD1”. In cases where fixed-point control is selected as the PID control mode (MOD1 = 1), tracking based on the I-term works to prevent the control output from changing suddenly even if the target setpoint SP is varied.
The control output therefore may appear to be working incorrectly at first; however it gradually adapts itself to the new target setpoint. Be especially careful when the controller is in the fixed-point control mode; the control output may fail to change and therefore result in a loss of control if you change the target setpoint SP too frequently.

5.2 Maintenance

This section describes the cleaning and maintenance of the UP750.

5.2.1 Cleaning

The front panel and operation keys should be gently wiped with a dry cloth.



NOTE

Do not use alcohol, benzine, or any other solvents.

5.2.2 Replacing Brackets

When the brackets are broken or lost, purchase the following brackets for replacement.

Target Model	Part No.	Sales Unit
UP750	T9115NL	A large bracket and small bracket in pair

SEE ALSO

“1.2 How to Install,” for how to replace brackets.

5.2.3 Attaching Terminal Cover

When a terminal cover is necessary, purchase the following part.

Target Model	Part No.	Sales Unit
UP750	T9115YD	1

■ Attaching Terminal Cover

The procedure for attaching the terminal cover is as follows.



Do not touch the terminals on the rear panel when power is being supplied to the controller. Doing so may result in electric shock.

Before attaching the terminal cover, turn off the source circuit breaker and use a tester to check that the power cable is not conducting any electricity.

1. Before attaching the terminal cover, fold it once or twice so that the side which has the “Handle With Care” symbol (⚠), is on the outside.

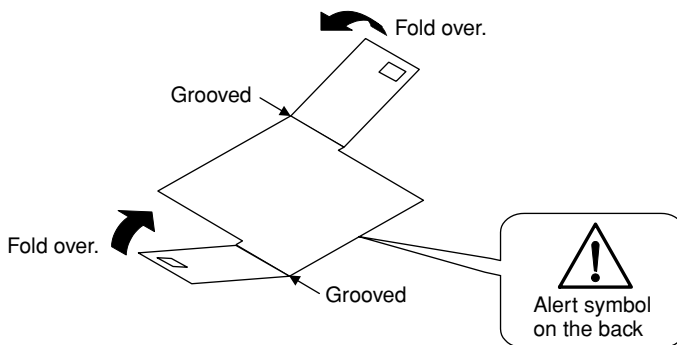

Folding Direction of Terminal Cover



Do not fold the terminal cover the wrong way, doing so not only reduces the cover's strength but may also cause the hinge to crack, thereby disabling attachment.

2. With the cover properly folded, fit its top and bottom holes to the protrusions of the mounting brackets.

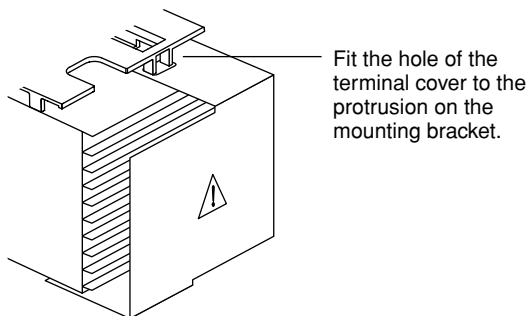

Attaching Terminal Cover

5.2.4 Replacing Parts with a Limited Service Life

The following UP750 parts have a limited service life. The service life given in the table assume that the controller is used under normal operating conditions.

Part	Service life
Aluminum electrolytic condenser	About 10 years (rated)
Lithium battery for backup	About 10 years (rated)
Alarm output relays	About 100,000 more ON-OFF operations or with resistance load
Control output relays	About 100,000 more ON-OFF operations or with resistance load

If any of these parts, except control output relays, cause a controller failure due to deterioration, contact your dealer for replacement at your cost. Control output relays can be replaced by yourself.

SEE ALSO

“5.2.5 Replacing Control Output Relays,” for how to replace the control output relays.

5.2.5 Replacing Control Output Relays

This subsection describes how to replace the control output relays.

The replacement must be performed by an engineer qualified for the work.



Always turn off the power before starting the work in order to avoid electric shock.

Do not pull out the internal unit for any other purpose other than to replace the control output relays.

1. Insert a flat-blade screwdriver (tip width of 6 mm is recommended) into the opening with the tip in parallel with the front panel, and then turn the screwdriver gently. Take this procedure to four openings 1, 2, 3 and 4 (see the figure below) on the upper and lower parts of the bezel, in order. The bezel slightly moves forward from the housing.

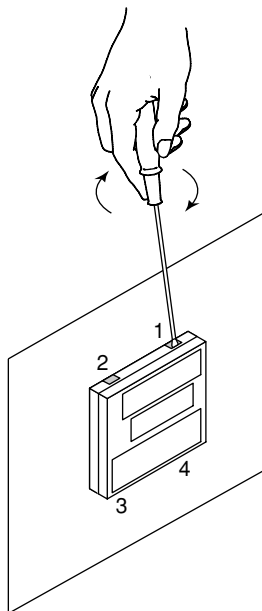

2. Push up the center of the bottom gasket of bezel by a finger to release the latch.

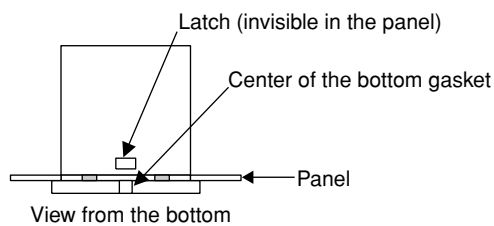

3. Insert the flat-blade screwdriver into the four openings and flip the tip forward to move the bezel more forward.
4. Hold the bezel and pull it along with the internal unit out of the housing.
(Note) Be careful not to damage the RJC sensor.

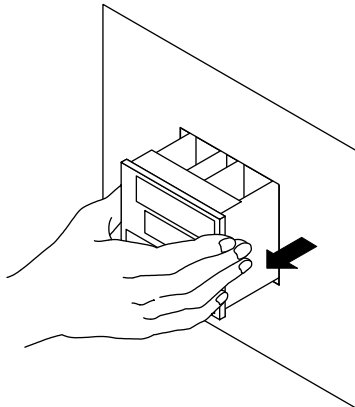

5. The location and number of the relays differ depending on the model code of the UP750. Confirm the location of the control output relay to be replaced before pulling out the relay.

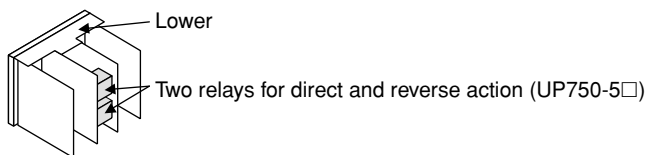

6. Pull out the relay to be replaced.
The control output relays are easy to remove and mount, since they are connected via a socket onto the print boards.

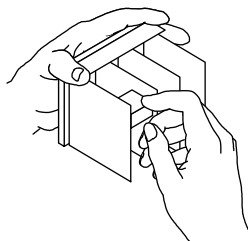

Insert the new relay in the socket. Use the following relay.

Manufacturer	OMRON
Model	G6B-2114P-FD-US-P6B
Power supply	12 V DC

7. **Insert the internal unit into the housing.**
Apply power to the controller and confirm that the initial operating display is shown. If the operating display is not shown properly, turn off the controller and pull out the internal unit. Then, insert it into the housing again.

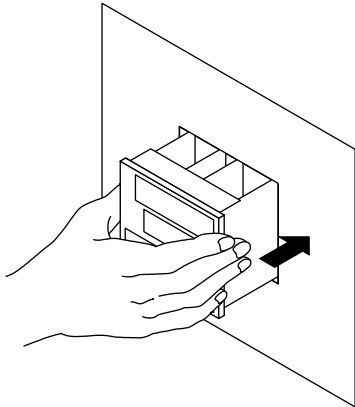

This completes replacement of the control output relay.

6. Parameters

6.1 Parameter Map

This section contains “Operating Parameter Map” and “Setup Parameter Map” for UP750 as a guideline for setting parameters.

These maps are helpful in finding the positions of the displays when setting the parameters, and should be used as a quick reference for the entire range of parameter displays.





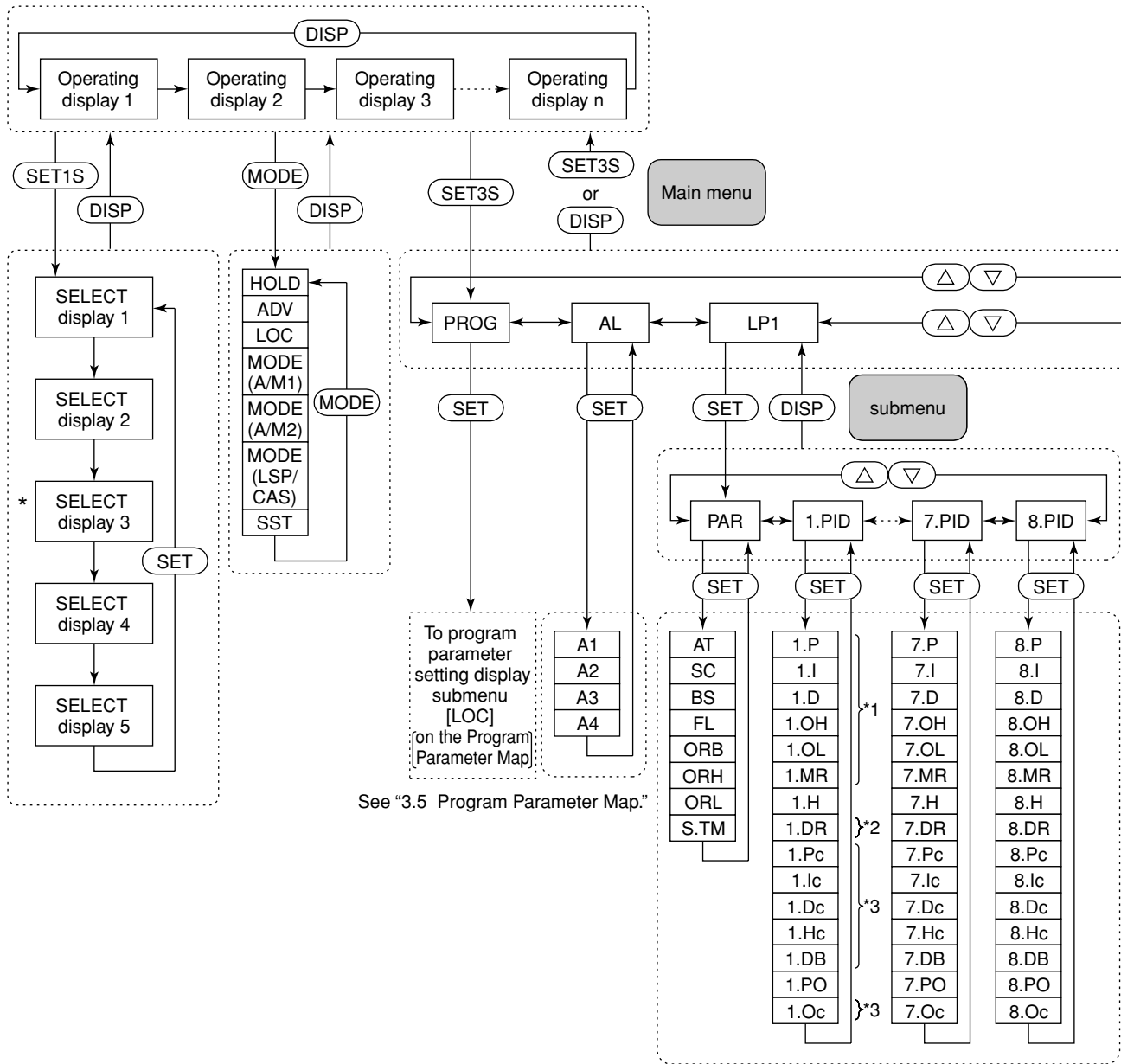

UP750 Operating Parameter Map

Operating Display





See "3.5 Program Parameter Map."

- *1 Not displayed for ON/OFF control
- *2 Not displayed for heating/cooling control
- *3 Displayed for heating/cooling control

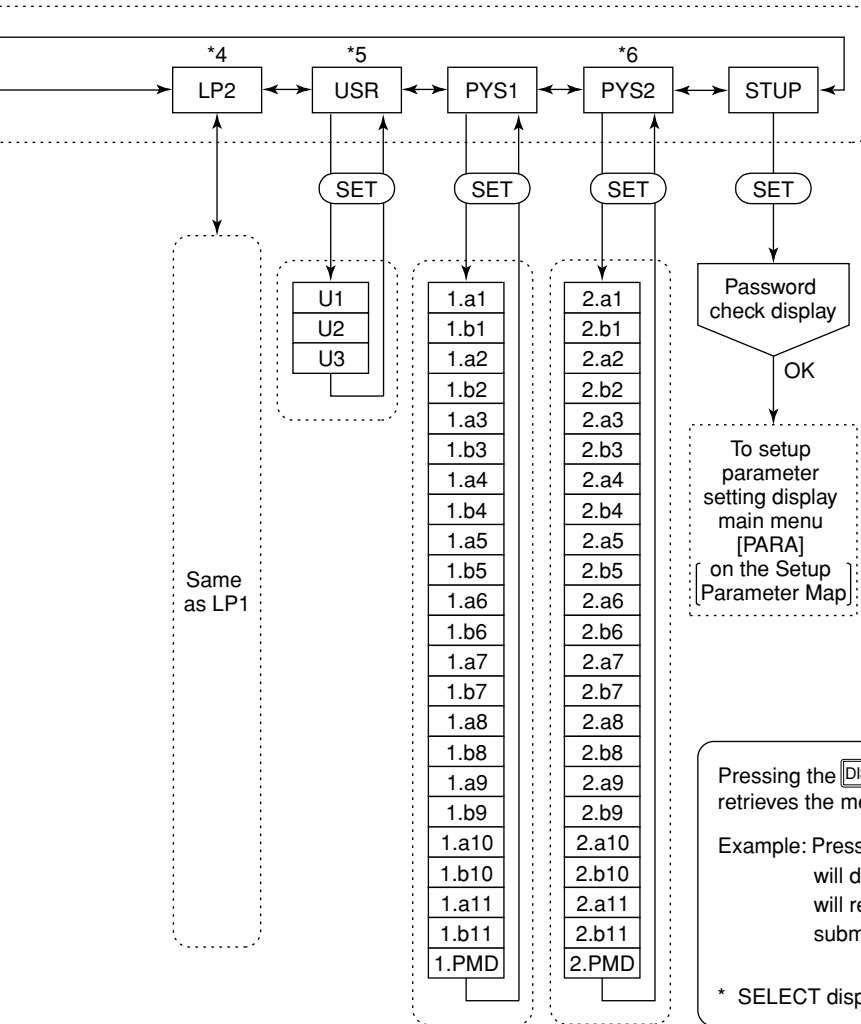
- SET** : Press the  key once.
- MODE** : Press the  key once.
- DISP** : Press the  key once.
- SET1S** : Press the  key for 1 second.
- SET3S** : Press the  key for 3 seconds.
- △** **▽** : Press the  or  key once.



Pressing the  key once when a parameter setting display is shown retrieves the menu of that parameter setting display.

Example: Pressing the  key once when the [PAR] submenu is displayed, will display the [LP1] main menu. Conversely, the [PAR] submenu will reappear by pressing the  key once when the [PAR] submenu's "FL" parameter display is shown.

* SELECT displays 1 to 5 are shown only when they are registered.

*4 Main menu LP2 is displayed when UP mode is "Cascade control," "Dual-loop control," "Temperature and humidity control," "Cascade control with two universal inputs."



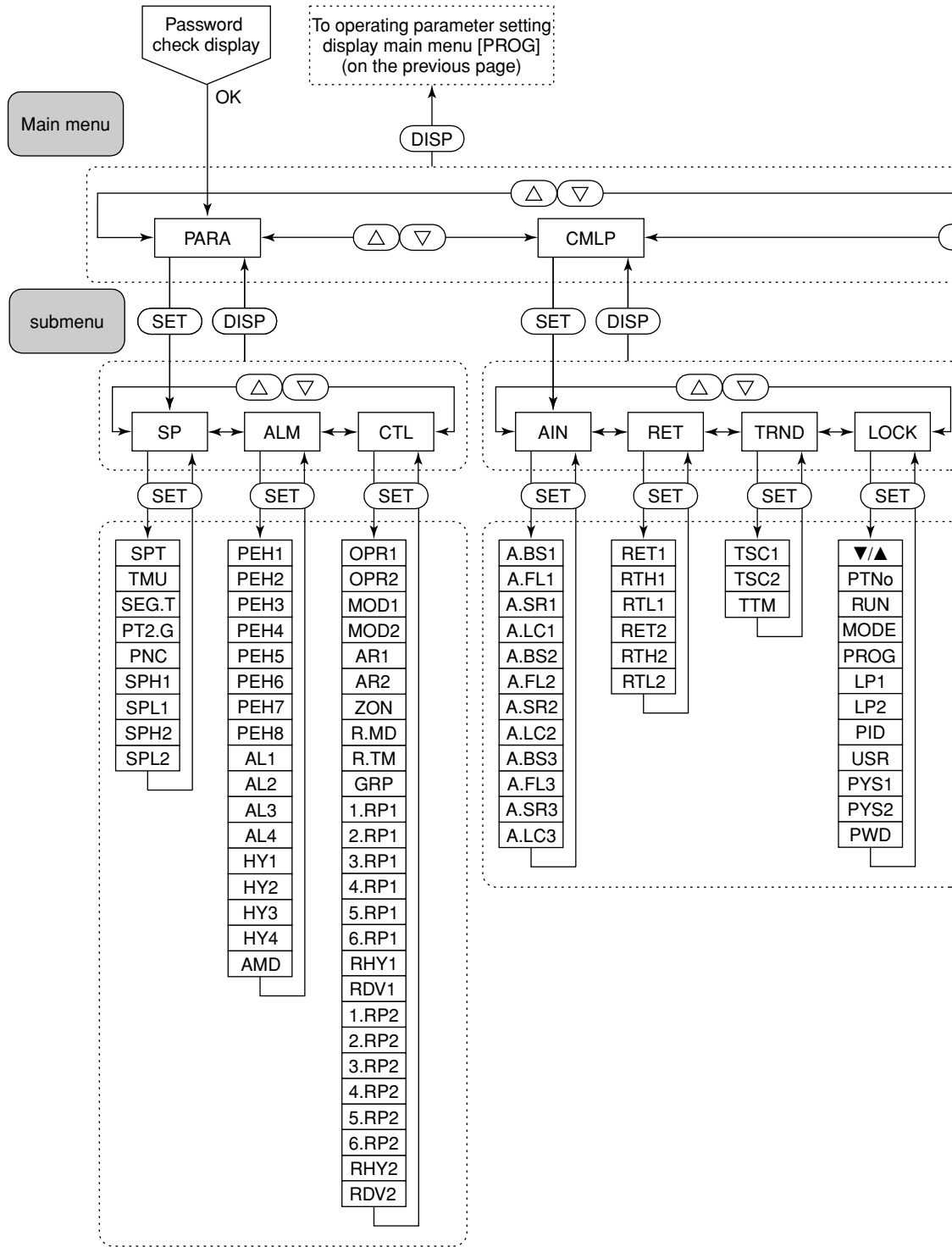

*5 Main menu USR is displayed when UP mode is "Loop control with PV switching," "Loop control with PV auto-selector," "Loop control with PV switching and two universal inputs," "Loop control with PV auto-selector and two universal inputs."

*6 Main menu PYS2 is displayed when UP mode is "Cascade control," "Loop control with PV switching," "Dual-loop control," "Temperature and humidity control," "Cascade control with two universal inputs," "Loop control with PV switching and two universal inputs," "Loop control with PV auto-selector and two universal inputs."

UP750 Setup Parameter Map



Pressing the **DISP** key once when a parameter setting display is shown retrieves the submenu of that parameter setting display.

(SET) : Press the  key once.
 (DISP) : Press the  key once.
 (Δ) (▽) : Press the  or  key once.

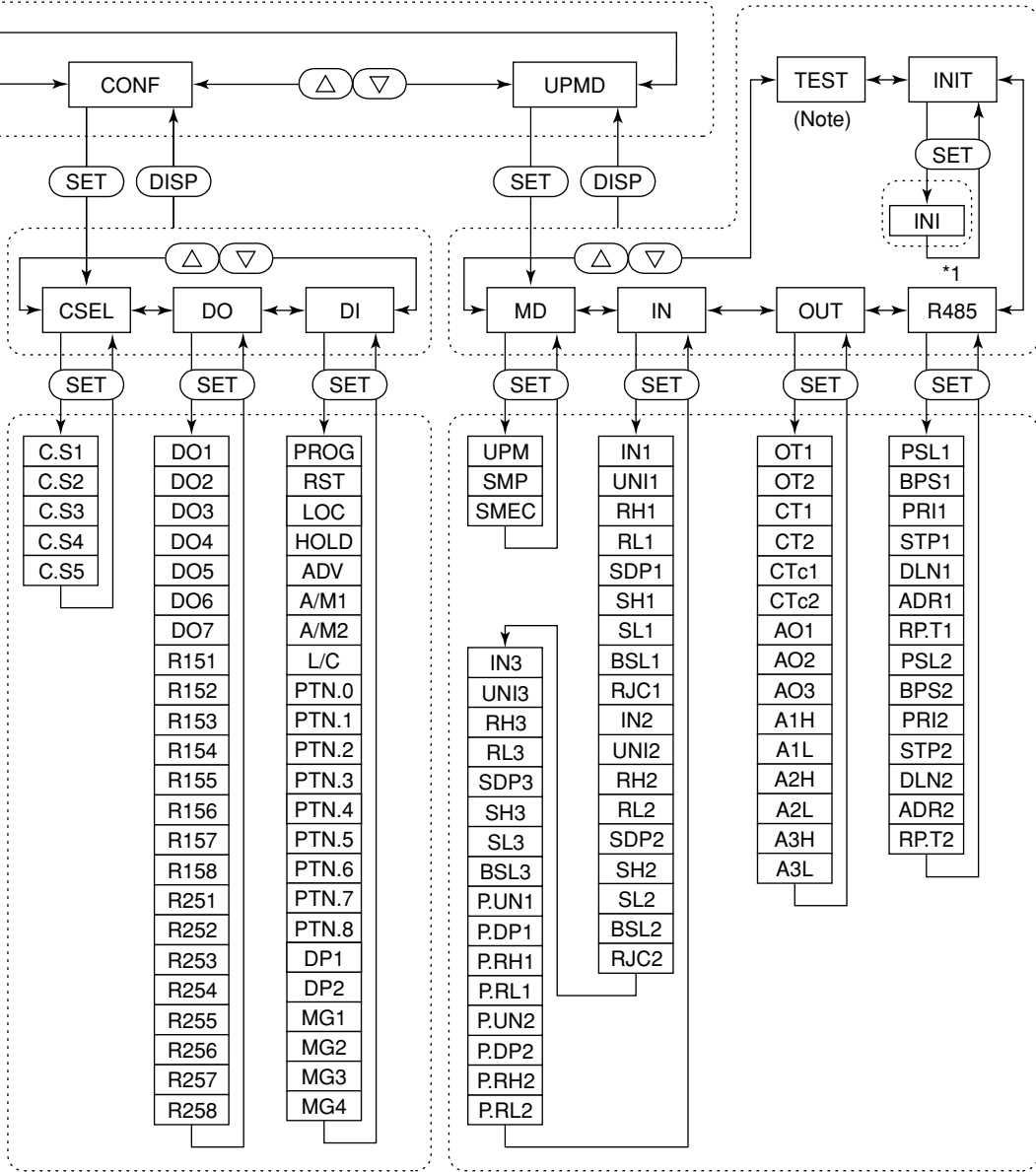

*1 Submenu R485 is displayed only for the controller with communication function.

Note: The parameter items shown on the [TEST] submenu of the setup parameter setting display are to be used by Yokogawa service personnel to check the controller functions. User cannot set or change these parameters.

6.2 Lists of Parameters

This section describes the functions of parameters briefly. In addition, each parameter table has a “User Setting” column, where you can record your setpoints when setting them in the controller.

- * Parameters relating to PV or program setpoints should all be set in real numbers. For example, use temperature values to define program setpoints and PV event setpoints for temperature input.
- * The “User Setting” column in the table is provided for the customer to record setpoints.
- * Numbers in () are the parameter setpoints that apply when the communication function is used. ex. AUTO1 (0), MAN1 (1).

■ Operation Mode Parameters

Located in: **MODE** key ( key on the instrument's front panel)

Parameter Symbol	Name of Parameter	Setting Range and Description	Initial Value	User Setting
HOLD	Pause of program operation	Set as “HOLD = ON” to enable the hold mode of program operation.		
ADV	Advance of segment	Set as “ADV = ON” to advance from the current segment to the next segment.		
LOC	Local-mode operation	Set as “LOC = ON” to switch from program operation or RESET mode to local-mode operation.		
A/M1	Loop1 AUTO/MAN switching	To switch between AUTO and MAN: To switch to AUTO mode, set as “MODE: AUTO1 (0)”. To switch to MAN mode, set as “MODE: MAN1 (1)”.		
A/M2	Loop2 AUTO/MAN switching	To switch between AUTO and MAN: To switch to AUTO mode, set as “MODE: AUTO2 (0)”. To switch to MAN mode, set as “MODE: MAN2 (1)”.		
SST	Start-of-program segment number	1 to 99 Program operation begins with the segment whose number is specified by this parameter.	1	

■ Operating Parameters

● Instrument Alarm Setting Parameters

Located in: Main menu = **AL**

Parameter Symbol	Name of Parameter	Setting Range and Description	Initial Value	User Setting
A1	Instrument alarm-1 setpoint	Allows alarm action to be set irrespective of the program. PV alarm / SP alarm: -100.0 to 100.0% of PV input range Deviation alarm: -100.0 to 100.0% of PV input range span Output alarm: -5.0 to 105.0%	PV high limit/SP high limit alarm: 100.0% of PV input range Deviation alarm: 0.0% of PV input range span Other PV/SP low limit alarm: 0.0% of PV input range Output high limit alarm: 100.0% Output low limit alarm: 0.0%	
A2	Instrument alarm-2 setpoint			
A3	Instrument alarm-3 setpoint			
A4	Instrument alarm-4 setpoint			

The following parameters are for Loop1.

● Operation-related Parameters

Located in: Main menu = **LP1** ; Submenu = **PAR**

Parameter Symbol	Name of Parameter	Setting Range and Description	Initial Value	User Setting
AT	Auto-tuning	OFF (0): No auto-tuning 1: Auto-tuning for 1st group of PID 2: Auto-tuning for 2nd group of PID 3: Auto-tuning for 3rd group of PID 4: Auto-tuning for 4th group of PID 5 to 8: Perform auto-tuning on a group basis in the same way as 1 to 4 9: Performs auto-tuning to all groups 1 to 8.	OFF (0)	
SC	"SUPER" function	OFF (0): Disable 1: Overshoot suppressing function Suppresses overshoots generated by abrupt changes in the target setpoint or by disturbances. 2: Hunting suppressing function (Stable mode) Suitable to stabilize the state of control when the load varies greatly, or the target setpoint is changed. Enables to answer the wider characteristic changes compared with Response mode. 3: Hunting suppressing function (Response mode) Enables quick follow-up and short converging time of PV for the changed target setpoint. Note: Use "SUPER" function (SC) 2 or 3 in PID control or PI control. "SUPER" function 2 or 3 is not available in the following controls: 1) ON/OFF control 2) P control (control for proportional band only) 3) PD control (control for proportional band and derivative item only) 4) Heating/cooling control Do not use hunting suppressing function when control processes with response such as flow or pressure control.	OFF (0)	
BS	PV input bias	-100.0% to 100.0% of Loop1 PV input range span Used to correct the PV input value.	0.0% of Loop1 PV input range span	
FL	PV input filter	OFF (0), 1 to 120 sec. Used when the PV input value fluctuates.	OFF (0)	
ORB	ON/OFF rate detection band	0.0 to 100.0% of Loop1 PV input range span	1.0% of Loop1 PV input range span	
ORH	ON/OFF rate high limit	ORL + 1 digit to 105.0%	100.0%	
ORL	ON/OFF rate low limit	-5.0% to ORH - 1 digit	0.0%	
S.TM	Starting time of program pattern operation	0.00 to 99.59 ("hour, minute" or "minute, second") The controller begins control when the specified time has passed after power-on.	0.00	

The following parameters are for Loop1.

● **PID-related Parameters**

Located in: Main menu = **LP1** ; Submenu = **1.PID**

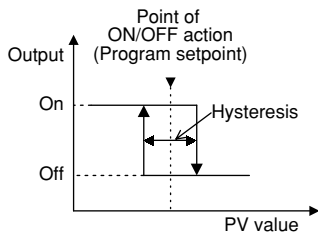
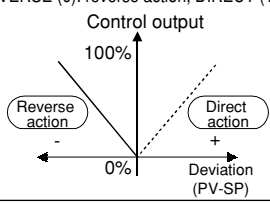
Parameter Symbol	Name of Parameter	Setting Range and Description	Initial Value	User Setting
1.P	Proportional band/Heating-side proportional band (in heating/cooling control)	0.1 to 999.9% of Loop1 PV input range In heating/cooling control: 0.0 to 999.9% (heating-side on/off control applies when 0.0)	5.0%	
1.I	Integral time Heating-side integral time (in heating/cooling control)	OFF (0), 1 to 6000 sec.	240 sec.	
1.D	Derivative time Heating-side derivative time (in heating/cooling control)	OFF (0), 1 to 6000 sec.	60 sec.	
1.OH	Output high limit Heating-side output high limit (in heating/cooling control)	-5.0 to 105.0% Heating-side limiter in heating/cooling control: 0.0 to 105.0% (1.OL < 1.OH)	100% Heating/cooling control: 100.0%	
1.OL	Output low limit Cooling-side output high limit (in heating/cooling control)	-5.0 to 105.0% Cooling-side limiter in heating/cooling control: 0.0 to 105.0% (1.OL < 1.OH) SD (shutdown): Set in manual operation in 4-20 mA control output. Output is 0 mA.	0.0% Heating/cooling control: 100.0%	
1.MR	Manual reset	-5.0 to 105.0% (enabled when integral time "1.I" is OFF) The manual reset value equals the output value when PV = SP is true. For example, if the manual reset value is 50%, the output value is 50% when PV = SP becomes true.	50.0%	
1.H	ON/OFF control hysteresis Heating-side ON/OFF control hysteresis (in heating/cooling control)	In ON/OFF control: 0.0 to 100.0% of Loop1 PV input range span Hysteresis can be set in the program setpoint when the controller is performing ON/OFF control. 	ON/OFF control: 0.5% of Loop1 PV input range span Heating/cooling control: 0.5%	
1.DR	Direct/reverse action switching	REVERSE (0): reverse action, DIRECT (1): direct action 	REVERSE (0)	
1.Pc	Cooling-side proportional band	0.0 to 999.9% of Loop1 PV input range (Cooling-side ON/OFF control applies when 0.0)	5.0%	
1.Ic	Cooling-side integral time	OFF, 1 to 6000 sec.	240 sec.	
1.Dc	Cooling-side derivative time	OFF, 1 to 6000 sec.	60 sec.	
1.Hc	Cooling-side ON/OFF control hysteresis	0.0 to 100.0%	0.5%	

Parameter Symbol	Name of Parameter	Setting Range and Description	Initial Value	User Setting
1.DB	Dead band	In heating/cooling control: -100.0 to 50.0% • When performing heating/cooling control: setting any positive value prohibits both the heating and cooling outputs from turning on; setting any negative value allows both the heating and cooling outputs to turn on; and setting a value of zero either the heating or cooling output to turn on.	3.0%	
1.PO	Preset output/Heating-side preset output (in heating/cooling control)	-5.0 to 105.0% In RESET mode, fixed control output can be generated. In heating/cooling control: Heating-side 0.0 to 105.0%	0.0%	
1.Oc	Cooling-side preset output	0.0 to 105.0% In RESET mode, cooling-side fixed control output can be generated.	0.0%	

If you are using two or more groups of PID parameters, use the following table to record their values.

Parameter	n=2	n=3	n=4	n=5	n=6	n=7	n=8
n.P							
n.I							
n.D							
n.OH							
n.OL							
n.MR							
n.H							
n.DR							
n.Pc							
n.Ic							
n.Dc							
n.Hc							
n.DB							
n.PO							
n.Oc							

● Ten-segment Linearizer 1 Parameters

Located in: Main menu = PYS1

- Ten-segment linearizer biasing (factory-set default)

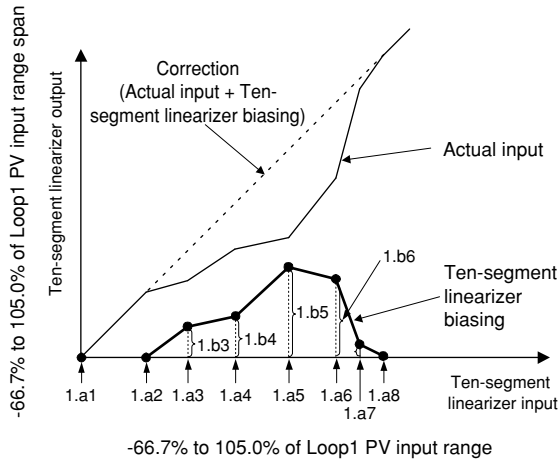

- Ten-segment linearizer approximation

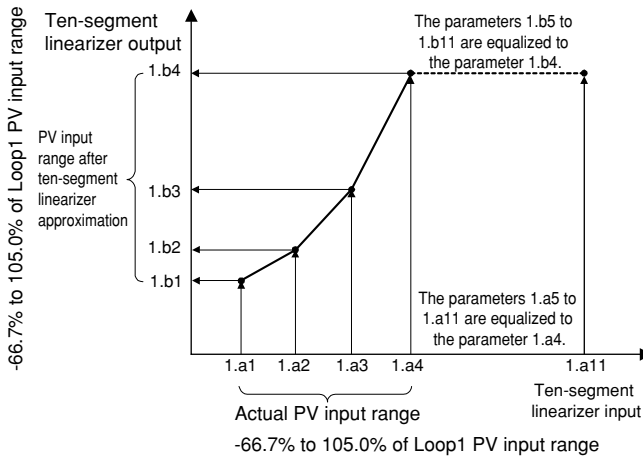

The following parameters are for Loop2.

● **Operation-related Parameters**

Located in: Main menu = LP2 ; Submenu = PAR

Parameter Symbol	Name of Parameter	Setting Range and Description	Initial Value	User Setting
AT	Auto-tuning	OFF (0): No auto-tuning 1: Auto-tuning for 1st group of PID 2: Auto-tuning for 2nd group of PID 3: Auto-tuning for 3rd group of PID 4: Auto-tuning for 4th group of PID 5 to 8: Perform auto-tuning on a group basis in the same way as 1 to 4 9: Performs auto-tuning to all groups 1 to 8.	OFF (0)	
SC	"SUPER" function	OFF (0): Disable 1: Overshoot suppressing function Suppresses overshoots generated by abrupt changes in the target setpoint or by disturbances. 2: Hunting suppressing function (Stable mode) Suitable to stabilize the state of control when the load varies greatly, or the target setpoint is changed. Enables to answer the wider characteristic changes compared with Response mode. 3: Hunting suppressing function (Response mode) Enables quick follow-up and short converging time of PV for the changed target setpoint. Note: Use "SUPER" function (SC) 2 or 3 in PID control or PI control. "SUPER" function 2 or 3 is not available in the following controls: 1) ON/OFF control 2) P control (control for proportional band only) 3) PD control (control for proportional band and derivative item only) 4) Heating/cooling control Do not use hunting suppressing function when control processes with response such as flow or pressure control.	OFF (0)	
BS	PV input bias	-100.0% to 100.0% of Loop2 PV input range span Used to correct the PV input value.	0.0% of Loop2 PV input range span	
FL	PV input filter	OFF (0), 1 to 120 sec. Used when the PV input value fluctuates.	OFF (0)	
ORB	ON/OFF rate detection band	0.0 to 100.0% of Loop2 PV input range span	1.0% of Loop2 PV input range span	
ORH	ON/OFF rate high limit	ORL + 1 digit to 105.0%	100.0%	
ORL	ON/OFF rate low limit	-5.0% to ORH - 1 digit	0.0%	
S.TM	Starting time of program pattern operation	0.00 to 99.59 ("hour, minute" or "minute, second") The controller begins control when the specified time has passed after power-on.	0.00	

The following parameters are for Loop2.

● **PID-related Parameters**

Located in: Main menu = **LP2** ; Submenu = **1.PID**

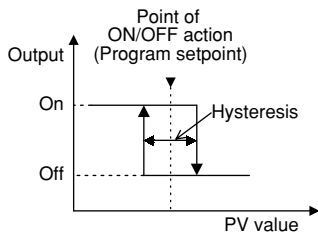
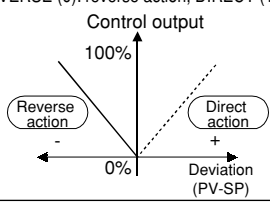
Parameter Symbol	Name of Parameter	Setting Range and Description	Initial Value	User Setting
1.P	Proportional band/Heating-side proportional band (in heating/cooling control)	0.1 to 999.9% of Loop2 PV input range In heating/cooling control: 0.0 to 999.9% (heating-side on/off control applies when 0.0)	5.0%	
1.I	Integral time Heating-side integral time (in heating/cooling control)	OFF (0), 1 to 6000 sec.	240 sec.	
1.D	Derivative time Heating-side derivative time (in heating/cooling control)	OFF (0), 1 to 6000 sec.	60 sec.	
1.OH	Output high limit Heating-side output high limit (in heating/cooling control)	-5.0 to 105.0% Heating-side limiter in heating/cooling control: 0.0 to 105.0% (1.OL < 1.OH)	100% Heating/cooling control: 100.0%	
1.OL	Output low limit Cooling-side output high limit (in heating/cooling control)	-5.0 to 105.0% Cooling-side limiter in heating/cooling control: 0.0 to 105.0% (1.OL < 1.OH) SD (shutdown): Set in manual operation in 4-20 mA control output. Output is 0 mA.	0.0% Heating/cooling control: 100.0%	
1.MR	Manual reset	-5.0 to 105.0% (enabled when integral time "1.I" is OFF) The manual reset value equals the output value when PV = SP is true. For example, if the manual reset value is 50%, the output value is 50% when PV = SP becomes true.	50.0%	
1.H	ON/OFF control hysteresis Heating-side ON/OFF control hysteresis (in heating/cooling control)	In ON/OFF control: 0.0 to 100.0% of Loop2 PV input range span Hysteresis can be set in the program setpoint when the controller is performing ON/OFF control. 	ON/OFF control: 0.5% of Loop2 PV input range span Heating/cooling control: 0.5%	
1.DR	Direct/reverse action switching	REVERSE (0): reverse action, DIRECT (1): direct action 	REVERSE (0)	
1.Pc	Cooling-side proportional band	0.0 to 999.9% of Loop2 PV input range (Cooling-side ON/OFF control applies when 0.0)	5.0%	
1.Ic	Cooling-side integral time	OFF, 1 to 6000 sec.	240 sec.	
1.Dc	Cooling-side derivative time	OFF, 1 to 6000 sec.	60 sec.	
1.Hc	Cooling-side ON/OFF control hysteresis	0.0 to 100.0%	0.5%	

Parameter Symbol	Name of Parameter	Setting Range and Description	Initial Value	User Setting
1.DB	Dead band	In heating/cooling control: -100.0 to 50.0% • When performing heating/cooling control: setting any positive value prohibits both the heating and cooling outputs from turning on; setting any negative value allows both the heating and cooling outputs to turn on; and setting a value of zero either the heating or cooling output to turn on.	3.0%	
1.PO	Preset output/Heating-side preset output (in heating/cooling control)	-5.0 to 105.0% In RESET mode, fixed control output can be generated. In heating/cooling control: Heating-side 0.0 to 105.0%	0.0%	
1.Oc	Cooling-side preset output	0.0 to 105.0% In RESET mode, cooling-side fixed control output can be generated.	0.0%	

If you are using two or more groups of PID parameters, use the following table to record their values.

Parameter	n=2	n=3	n=4	n=5	n=6	n=7	n=8
n.P							
n.I							
n.D							
n.OH							
n.OL							
n.MR							
n.H							
n.DR							
n.Pc							
n.Ic							
n.Dc							
n.Hc							
n.DB							
n.PO							
n.Oc							

The following parameters are for Loop2.

● Ten-segment Linearizer 2 Parameters

Located in: Main menu = PYS2

- Ten-segment linearizer biasing (factory-set default)

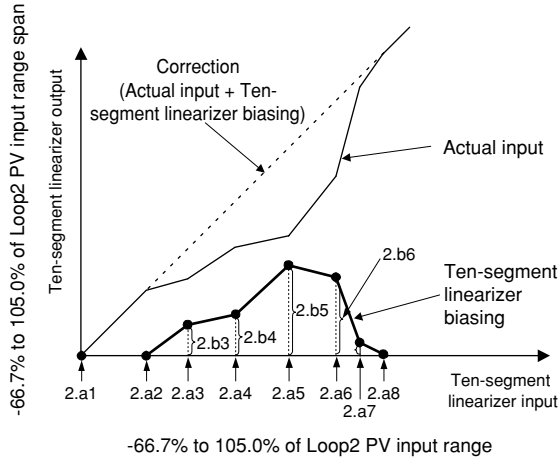

- Ten-segment linearizer approximation

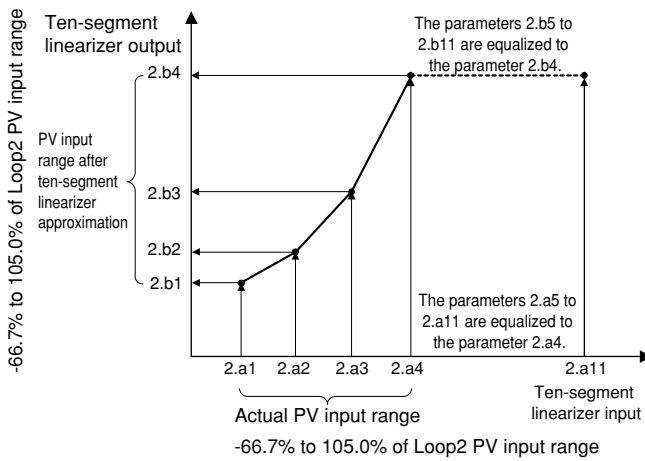

■ Setup Parameters

● Program Setpoint-related Parameters

Located in: Main menu = **PARA** ; Submenu = **SP**

Parameter Symbol	Name of Parameter	Setting Range and Description	Initial Value	User Setting
SPT	SP tracking selection	OFF (0), ON (1) Tracking is performed when the mode changes from program to Local (The local setpoint keeps track of the program setpoint.)	OFF (0)	
TMU	Program time unit	Sets the time unit of a program. hh:mm (0): "hour, minute" mm:ss (1): "minute, second"	hh:mm (0)	
SEG.T	Segment setting method	Defines the method of programming. Note that changing the setpoint of this parameter deletes the program in question. 0: Programming by setting segment times 1: Programming by setting segment ramps	0	
PNC	Program pattern number clearance	The controller resets (clears) the program pattern number on the operating display to "0" at the end of program operation. OFF (0): Not cleared. ON (1): Cleared.	OFF (0)	
SPH1	Program setpoint-1 limiter upper limit	Place limits on the program setpoints when the controller is in Loop1 program operation. 0.0% to 100.0% of Loop1 PV input range. Note that SPL1 < SPH1	100.0% of Loop1 PV input range	
SPL1	Program setpoint-1 limiter lower limit		0.0% of Loop1 PV input range	
SPH2	Program setpoint-2 limiter upper limit	Place limits on the program setpoints when the controller is in Loop2 program operation. 0.0% to 100.0% of Loop2 PV input range. Note that SPL2 < SPH2	100.0% of Loop2 PV input range	
SPL2	Program setpoint-2 limiter lower limit		0.0% of Loop2 PV input range	

● Alarm-related Parameters

Located in: Main menu = **PARA** ; Submenu = **ALM**

Parameter Symbol	Name of Parameter	Setting Range and Description	Initial Value	User Setting
PEH1	PV event 1 hysteresis	<p>Allows margins to be set for a PV event setpoint. With the hysteresis settings, it is possible to prevent relays from chattering.</p> <p>Hysteresis for PV high limit alarm</p> <p>0.0 to 100.0%</p>	0.5%	
PEH2	PV event 2 hysteresis			
PEH3	PV event 3 hysteresis			
PEH4	PV event 4 hysteresis			
PEH5	PV event 5 hysteresis			
PEH6	PV event 6 hysteresis			
PEH7	PV event 7 hysteresis			
PEH8	PV event 8 hysteresis			
AL1	Instrument alarm-1 type	OFF (0), Loop1: 1 to 20, 25 to 31 Loop2: 41 to 60, 65 to 71	1	
AL2	Instrument alarm-2 type	1: PV high limit (energized, no stand-by action) 2: PV low limit (energized, no stand-by action)	2	
AL3	Instrument alarm-3 type	3: Deviation high limit (energized, no stand-by action) 4: Deviation low limit (energized, no stand-by action)	1	
AL4	Instrument alarm-4 type	5: Deviation high limit (de-energized, no stand-by action) 6: Deviation low limit (de-energized, no stand-by action) For other alarm types, see the next page.	2	
HY1	Instrument alarm-1 hysteresis	0.0 to 100.0% of PV input range span Output alarm: 0.0 to 100.0%	0.5% of PV input range span Output alarm: 0.5%	
HY2	Instrument alarm-2 hysteresis	Allows margins to be set for an alarm setpoint. With the hysteresis settings, it is possible to prevent relays from chattering.		
HY3	Instrument alarm-3 hysteresis	<p>Hysteresis for PV high limit alarm</p>		
HY4	Instrument alarm-4 hysteresis			
AMD	Alarm mode	Allows the instrument alarm function to be enabled or disabled according to the operating condition. 0: Always active 1: Not active when in RESET mode 2: Not active when in RESET mode or manual operation	0	

List of Instrument Alarm Types

The table below shows the types and actions of instrument alarm. In the table, codes 1 to 20, 28 to 31 are for Loop1, codes 41 to 60, 68 to 71 are for Loop2, codes 1 to 10, 41 to 51 are not provided with stand-by actions, while codes 11 to 20, 51 to 60 are provided with stand-by actions.

Alarm type	Alarm action "Open/close" shows status of relay contact, and "lit" and "unlit" shows status of lamp	Alarm type code		Alarm type	Alarm action "Open/close" shows status of relay contact, and "lit" and "unlit" shows status of lamp	Alarm type code	
		Contact closes if alarm occurs	Contact opens if alarm occurs			Contact closes if alarm occurs	Contact opens if alarm occurs
No alarm		OFF					
PV high limit		1 11 41 51	/	De-energized on deviation low limit alarm		/	6 16 46 56
PV low limit		2 12 42 52	/	Deviation high and low limits		/	7 17 47 57
Deviation high limit		3 13 43 53	/	Deviation within high and low limits		/	8 18 48 58
Deviation low limit		4 14 44 54	/	De-energized on PV high limit		/	9 19 49 59
De-energized on deviation high limit alarm		5 15 45 55	/	De-energized on PV low limit		/	10 20 50 60
SP high limit		28 68	/	Output high limit		/	30 70
SP low limit		29 69	/	Output low limit		/	31 71

The following alarm can be used only for "instrument alarm."

- 25, 65: Sensor grounding alarm
- 26, 66: Fault diagnosis output (Note 1)
- 27, 67: FAIL output (Note 2)

Note 1: The fault diagnosis output turns on in case of input burnout, A/D converter failure, or reference junction compensation (RJC) failure. For input burnout or A/D converter failure, the control output is set to the setpoint of the Preset Output Value operating parameter (PO).

Note 2: The FAIL output is on during normal operation and turns off case failure.

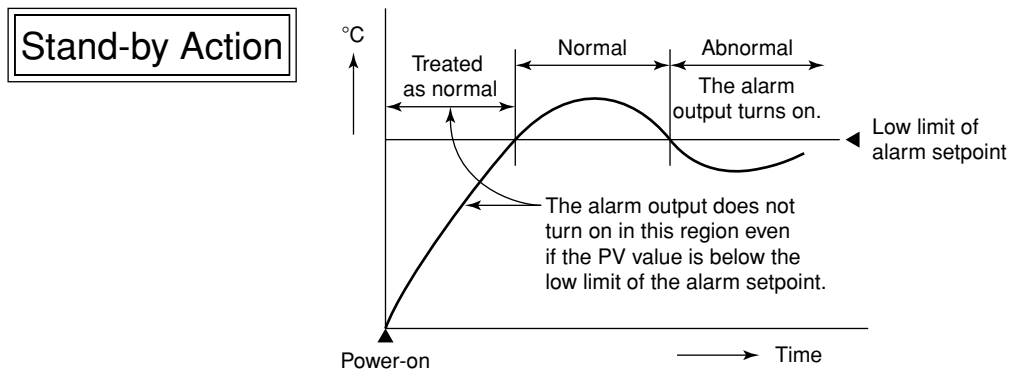

● Control Action-related Parameters

Located in: Main menu = **PARA** ; Submenu = **CTL**

Parameter Symbol	Name of Parameter	Setting Range and Description	Initial Value	User Setting
OPR1	Output of Loop1 velocity limiter	OFF (0) 0.1 to 100.0%/sec. can limit control output velocity	OFF (0)	
OPR2	Output of Loop2 velocity limiter	OFF (0) 0.1 to 100.0%/sec. can limit control output velocity	OFF (0)	
MOD1	PID of Loop1 control mode	0: Standard PID control (with output bump at SP change) 1: Fixed-point control (without output bump at SP change) Choose "Fixed-point Control" when controlling pressure or flow rate.	0	
MOD2	PID of Loop2 control mode	0: Standard PID control (with output bump at SP change) 1: Fixed-point control (without output bump at SP change) Choose "Fixed-point Control" when controlling pressure or flow rate.	0	
AR1	Anti-reset windup of Loop1 (Excess integration prevention)	AUTO (0), 50.0 to 200.0% The larger Setting, the sooner PID computation (integral computation) stops. Used when the control output travels up to 100% or down to 0% and stays at this point.	AUTO (0)	
AR2	Anti-reset windup of Loop2 (Excess integration prevention)	AUTO (0), 50.0 to 200.0% The larger Setting, the sooner PID computation (integral computation) stops. Used when the control output travels up to 100% or down to 0% and stays at this point.	AUTO (0)	
ZON	Zone PID selection	0: Segment PID 1: Zone PID If set to "Segment PID," allows PID constants to be selected for each segment. If set to "Zone PID," automatically selects PID constants according to the temperature range set in the given Reference Point parameter.	1	
R.MD	Restart mode	CONT (0): Continues action set before power failure. MAN (1): Starts from manual operation status RESET (2): Continues action set before power failure and starts computation from the preset output value.	CONT (0)	
R.TM	Restart timer	0 to 10 sec. Sets time between power on and the instant where controller starts computation.	0 sec.	
GRP	PID group number	Allows you to determine how many groups of setpoint, alarm and PID parameters the controller should show. 1: Show one set. 2: Show two sets. 3: Show three sets. 4: Show four sets. 5 to 8: Show as many groups of parameters as have been set.	8	
1.RP1	Zone PID of Loop1 reference point-1	0.0 to 100.0% of Loop1 PV input range. Note that 1.RP1 ≤ 2.RP1 ≤ 3.RP1 ≤ 4.RP1 ≤ 5.RP1 ≤ 6.RP1. Sets reference points at which switching is carried out between groups of PID constants according to the given temperature zone. You can set a maximum of six reference points and therefore a maximum of seven temperature zones. The example below sets reference points 1 and 2 to provide 3 zones to switch PID constants automatically.	100.0% of Loop1 PV input range	
2.RP1	Zone PID of Loop1 reference point-2			
3.RP1	Zone PID of Loop1 reference point-3			
4.RP1	Zone PID of Loop1 reference point-4			
5.RP1	Zone PID of Loop1 reference point-5			
6.RP1	Zone PID of Loop1 reference point-6			

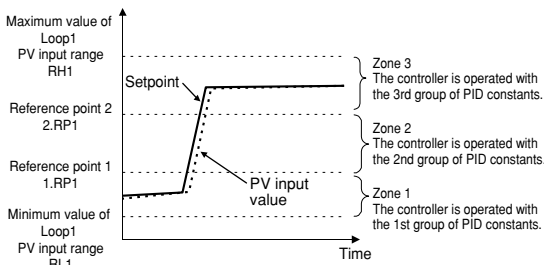

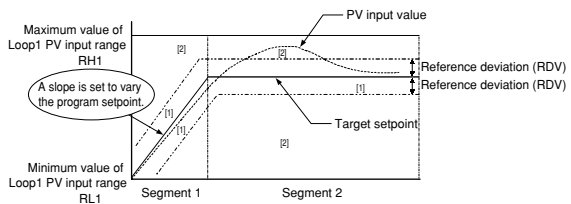
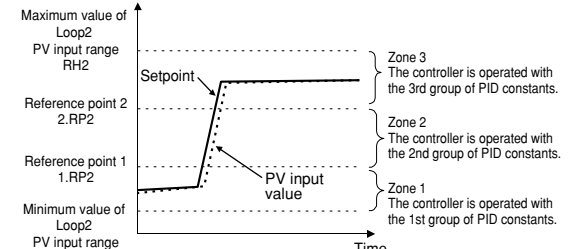
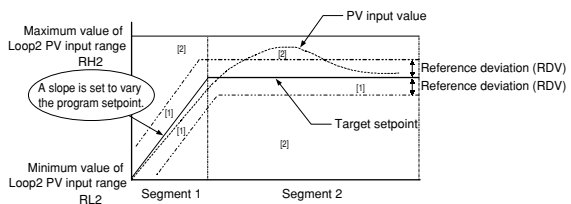
Parameter Symbol	Name of Parameter	Setting Range and Description	Initial Value	User Setting
RHY1	Zone switching of Loop1 hysteresis	0.0 to 10.0% of Loop1 PV input range span Allows hysteresis to be set for switching at a reference point.	0.5% of Loop1 PV input range span	
RDV1	Reference of Loop1 deviation	<p>Used to select a group of PID parameters according to a deviation from the given program setpoint. The controller uses the PID parameters of the number selected in PID group number (GRP) if the PV input falls outside the given deviation range. The following example shows a case when only the reference deviation is set without setting any reference point. The selected group of PID parameters is as follows.</p> <p>Since region 1 is within the deviation range, the controller uses the 1st group of PID parameters.</p> <p>Since region 2 is outside the deviation range, the controller uses the PID parameters of the number selected in PID group number (GRP).</p>  <p>OFF (0): Disable 0.0% to 100.0% of Loop1 PV input range span</p>	OFF (0)	
1.RP2	Zone PID of Loop2 reference point-1	<p>0.0 to 100.0% of Loop2 PV input range. Note that 1.RP2 ≤ 2.RP2 ≤ 3.RP2 ≤ 4.RP2 ≤ 5.RP2 ≤ 6.RP2. Sets reference points at which switching is carried out between groups of PID constants according to the given temperature zone. You can set a maximum of six reference points and therefore a maximum of seven temperature zones.</p> <p>The example below sets reference points 1 and 2 to provide 3 zones to switch PID constants automatically.</p> 	100.0% of Loop2 PV input range	
2.RP2	Zone PID of Loop2 reference point-2			
3.RP2	Zone PID of Loop2 reference point-3			
4.RP2	Zone PID of Loop2 reference point-4			
5.RP2	Zone PID of Loop2 reference point-5			
6.RP2	Zone PID of Loop2 reference point-6			
RHY2	Zone switching of Loop2 hysteresis	0.0 to 10.0% of Loop2 PV input range span Allows hysteresis to be set for switching at a reference point.	0.5% of Loop2 PV input range span	
RDV2	Reference of Loop2 deviation	<p>Used to select a group of PID parameters according to a deviation from the given program setpoint. The controller uses the PID parameters of the number selected in PID group number (GRP) if the PV input falls outside the given deviation range. The following example shows a case when only the reference deviation is set without setting any reference point. The selected group of PID parameters is as follows.</p> <p>Since region 1 is within the deviation range, the controller uses the 1st group of PID parameters.</p> <p>Since region 2 is outside the deviation range, the controller uses the PID parameters of the number selected in PID group number (GRP).</p>  <p>OFF (0): Disable 0.0% to 100.0% of Loop2 PV input range span</p>	OFF (0)	

● Analog Input Computation Parameters

Located in: Main menu = **CMLP** ; Submenu = **AIN**

Parameter Symbol	Name of Parameter	Setting Range and Description	Initial Value	User Setting
A.BS1	Analog input-1 bias	Used to correct the PV input value of Loop1 beforehand. When in normal operation, use the PV Input Bias (BS) operating parameter. -100.0% to 100.0% of Loop1 PV input range span	0.0% of Loop1 PV input range span	
A.FL1	Analog input-1 filter	OFF (0): Disable 1 to 120 sec.	OFF (0)	
A.SR1	Analog input-1 square-root computation	Performs square-root computation for the PV input value of Loop1. OFF (0): Do not compute the square root ON (1): Compute the square root	OFF (0)	
A.LC1	Analog input-1 low signal cutoff	0.0% to 5.0% The slope equals "1" at levels below the low-signal cutoff point.	1.0%	
A.BS2	Analog input-2 bias	Used to correct the PV input value of Loop2 beforehand. When in normal operation, use the PV Input Bias (BS) operating parameter. -100.0% to 100.0% of Loop2 PV input range span	0.0% of Loop2 PV input range span	
A.FL2	Analog input-2 filter	OFF (0): Disable 1 to 120 sec.	OFF (0)	
A.SR2	Analog input-2 square-root computation	Performs square-root computation for the PV input value of Loop2. OFF (0): Do not compute the square root ON (1): Compute the square root	OFF (0)	
A.LC2	Analog input-2 low signal cutoff	0.0% to 5.0% The slope equals "1" at levels below the low-signal cutoff point.	1.0%	
A.BS3	Although not used in dual-loop control, it is shown on the display.			
A.FL3	Although not used in dual-loop control, it is shown on the display.			
A.SR3	Although not used in dual-loop control, it is shown on the display.			
A.LC3	Although not used in dual-loop control, it is shown on the display.			

● **Retransmission Output Parameters**

Located in: Main menu = **CMLP** ; Submenu = **RET**

Parameter Symbol	Name of Parameter	Setting Range and Description	Initial Value	User Setting
RET1	Retransmission output-1 type	OFF (0): Disable 1: PV1, 2: SP1, 3: OUT1, 4: LPS loop power supply (15 V), 5: PV2, 6: SP2, 7: OUT2 Setpoints 5 to 7 are not available for dual-loop control. Retransmission output 1 is always provided via terminals 14 and 15. In heating/cooling control, an output value before allocation to heating/cooling control is transmitted if setpoint "3" is selected. (0% to 50%: Cooling-side output; 50% to 100%: Heating-side output)	1	
RTH1	Maximum value of retransmission output-1 scale	RET1=1, 2: RTL1 + 1 digit to 100.0% of PV input range RET1=3: RTL1 + 1 digit to 100.0%	100.0% of PV input range	
RTL1	Minimum value of retransmission output-1 scale	RET1=1, 2: 0.0% of PV input range to RTH1 - 1 digit RET1=3: 0.0% to RTH1 - 1 digit	0.0% of PV input range	
RET2	Retransmission output-2 type	Retransmission output-2 is available when the type of control output is not "current" or "voltage pulse." The output is provided via terminals 16 and 17. OFF (0): Disable 1: PV1, 2: SP1, 3: OUT1, 4: LPS loop power supply (15 V), 5: PV2, 6: SP2, 7: OUT2 In heating/cooling control, an output value before allocation to heating/cooling control is transmitted if setpoint "3" is selected. (0% to 50%: Cooling-side output; 50% to 100%: Heating-side output)	OFF (0)	
RTH2	Maximum value of retransmission output-2 scale	RET2=1, 2: RTL2 + 1 digit to 100.0% of PV input range RET2=3: RTL2 + 1 digit to 100.0%	100.0% of PV input range	
RTL2	Minimum value of retransmission output-2 scale	RET2=1, 2: 0.0% of PV input range to RTH2 - 1 digit RET2=3: 0.0% to RTH2 - 1 digit	0.0% of PV input range	

● **Deviation Trend Parameters**

Located in: Main menu = **CMLP** ; Submenu = **TRND**

Parameter Symbol	Name of Parameter	Setting Range and Description	Initial Value	User Setting
TSC1	Deviation trend scale of Loop1	Allows the deviation axis of the Deviation Trend operating display to be rescaled. 0.1 to 100.0% of Loop1 PV input range span	0.5% of Loop1 PV input range span	
TSC2	Deviation trend scale of Loop2	Allows the deviation axis of the Deviation Trend operating display to be rescaled. 0.1 to 100.0% of Loop2 PV input range span	0.5% of Loop2 PV input range span	
TTM	Deviation trend time	Allows the time axis of the Deviation Trend operating display to be rescaled. 1 to 600 sec.	5 sec.	

● **Security-related Parameters**

Located in: Main menu = **CMLP** ; Submenu = **LOCK**

Parameter Symbol	Name of Parameter	Setting Range and Description	Initial Value	User Setting
▼/▲	Locking of front panel up/down keys (▲and▼)	OFF (0): Unlock ON (1): Lock	OFF (0)	
PTNo	Locking of front panel PT.No key	OFF (0): Unlock ON (1): Lock	OFF (0)	
RUN	Locking of front panel RUN key	OFF (0): Unlock ON (1): Lock	OFF (0)	
MODE	Locking of front panel MODE key	OFF (0): Unlock ON (1): Lock	OFF (0)	
PROG	Locking of operating parameter main menu PROG display	OFF (0): Unlock ON (1): Lock	OFF (0)	
LP1	Operating parameter main menu [LP1] lock	OFF (0): Unlock ON (1): Lock	OFF (0)	
LP2	Operating parameter main menu [LP2] lock	OFF (0): Unlock ON (1): Lock	OFF (0)	
PID	Operating parameter submenu [PID] lock	OFF (0): Unlock ON (1): Lock	OFF (0)	
USR	Although not used in dual-loop control, it is shown on the display.			
PYS1	Operating parameter main menu [PYS1] lock	OFF (0): Unlock ON (1): Lock	OFF (0)	
PYS2	Operating parameter main menu [PYS2] lock	OFF (0): Unlock ON (1): Lock	OFF (0)	
PWD	Password setting	0: Password not set 1 to 30000 Note: If a password is set, the setup parameters cannot be displayed without entering the correct password.	0	

● **SELECT Display Parameters**

Located in: Main menu = **CONF** ; Submenu = **CSEL**

Parameter Symbol	Name of Parameter	Setting Range and Description	Initial Value	User Setting
C.S1	SELECT display-1 registration	OFF (0), 101 to 1023 Select the desired parameter from among the operating and setup parameters, then register the number (D register No.) accompanying that parameter. For example, registering "231" for C.S1 allows you to change instrument alarm-1 setpoint in operating display. Numbers for registering instrument alarm SP parameter for operating display: Instrument alarm-1 setpoint: 231 Instrument alarm-2 setpoint: 232 Instrument alarm-3 setpoint: 233 Instrument alarm-4 setpoint: 234	OFF (0)	
C.S2	SELECT display-2 registration			
C.S3	SELECT display-3 registration			
C.S4	SELECT display-4 registration			
C.S5	SELECT display-5 registration			

● **Contact Output Registration Parameters**

Located in: Main menu = **CONF** ; Submenu = **DO**

Parameter Symbol	Name of Parameter	Setting Range and Description	Initial Value	User Setting
DO1	Relay output flag registration for DO1	The following setpoints are registration numbers for dual-loop control only. 5705: PV event 1 output 5706: PV event 2 output 5689: Instrument alarm 1 output 5129: Time event 1 output 5130: Time event 2 output 5131: Time event 3 output 5133: Time event 4 output See "External contact output" in "1.5 Terminal Wiring Diagrams."	5705	
DO2	Relay output flag registration for DO2		5706	
DO3	Relay output flag registration for DO3		5689	
DO4	Open-collector transistor output flag registration for DO4		5129	
DO5	Open-collector transistor output flag registration for DO5		5130	
DO6	Open-collector transistor output flag registration for DO6		5131	
DO7	Open-collector transistor output flag registration for DO7		5133	
R151	R151 output flag registration	For contact input/output module 1 See Green series communication manual chapter "7. Input/Output Extension." 5707: PV event 3 output 5134: Time event 5 output 5135: Time event 6 output 5137: Time event 7 output 5138: Time event 8 output 5145: Time event 9 output 5146: Time event 10 output	5707	
R152	R152 output flag registration		5709	
R153	R153 output flag registration		5134	
R154	R154 output flag registration		5135	
R155	R155 output flag registration		5137	
R156	R156 output flag registration		5138	
R157	R157 output flag registration		5145	
R158	R158 output flag registration		5146	
R251	R251 output flag registration	For contact input/output module 2 See Green series communication manual chapter "7. Input/Output Extension." 5710: PV event 5 output 5711: PV event 6 output 5147: Time event 11 output 5149: Time event 12 output 5150: Time event 13 output 5151: Time event 14 output 5153: Time event 15 output 5154: Time event 16 output	5710	
R252	R252 output flag registration		5711	
R253	R253 output flag registration		5147	
R254	R254 output flag registration		5149	
R255	R255 output flag registration		5150	
R256	R256 output flag registration		5151	
R257	R257 output flag registration		5153	
R258	R258 output flag registration		5154	

● **Contact Input Registration Parameters**

Located in: Main menu = **CONF** ; Submenu = **DI**

Parameter Symbol	Name of Parameter	Setting Range and Description	Initial Value	User Setting																																																																																					
PROG	Start of program operation (When "DIIn" changes from OFF to ON)	These parameters determine which contact input to use to make selections/switches listed on the left. DI1: 5161 No function: 0 DI2: 5162 DI3: 5163 DI4: 5164 DI5: 5165 DI6: 5166 DI7: 5167 The contact inputs are factory-set as shown below. Contact inputs 1 to 4 (DI1 to DI4): Program pattern number selection (see below) Contact input 5 (DI5): Start of program operation Contact input 6 (DI6): Stop of program operation Contact input 7 (DI7): Start of local-mode operation Program pattern number selection <table border="1" style="width: 100%; border-collapse: collapse; text-align: center;"> <tr> <td></td> <td>1</td> <td>2</td> <td>3</td> <td>4</td> <td>5</td> <td>6</td> <td>7</td> <td>8</td> </tr> <tr> <td>DI1</td> <td>ON</td> <td>OFF</td> <td>ON</td> <td>OFF</td> <td>ON</td> <td>OFF</td> <td>ON</td> <td>OFF</td> </tr> <tr> <td>DI2</td> <td>OFF</td> <td>ON</td> <td>ON</td> <td>OFF</td> <td>OFF</td> <td>ON</td> <td>ON</td> <td>OFF</td> </tr> <tr> <td>DI3</td> <td>OFF</td> <td>OFF</td> <td>OFF</td> <td>ON</td> <td>ON</td> <td>ON</td> <td>ON</td> <td>OFF</td> </tr> <tr> <td>DI4</td> <td>OFF</td> <td>OFF</td> <td>OFF</td> <td>OFF</td> <td>OFF</td> <td>OFF</td> <td>OFF</td> <td>ON</td> </tr> </table> <table border="1" style="width: 100%; border-collapse: collapse; text-align: center;"> <tr> <td></td> <td>9</td> <td>10</td> <td>11</td> <td>12</td> <td>13</td> <td>14</td> <td>15</td> </tr> <tr> <td>DI1</td> <td>ON</td> <td>OFF</td> <td>ON</td> <td>OFF</td> <td>ON</td> <td>OFF</td> <td>ON</td> </tr> <tr> <td>DI2</td> <td>OFF</td> <td>ON</td> <td>ON</td> <td>OFF</td> <td>OFF</td> <td>ON</td> <td>ON</td> </tr> <tr> <td>DI3</td> <td>OFF</td> <td>OFF</td> <td>OFF</td> <td>ON</td> <td>ON</td> <td>ON</td> <td>ON</td> </tr> <tr> <td>DI4</td> <td>ON</td> <td>ON</td> <td>ON</td> <td>ON</td> <td>ON</td> <td>ON</td> <td>ON</td> </tr> </table> See "External contact output" in "1.5 Terminal Wiring Diagrams."		1	2	3	4	5	6	7	8	DI1	ON	OFF	ON	OFF	ON	OFF	ON	OFF	DI2	OFF	ON	ON	OFF	OFF	ON	ON	OFF	DI3	OFF	OFF	OFF	ON	ON	ON	ON	OFF	DI4	OFF	OFF	OFF	OFF	OFF	OFF	OFF	ON		9	10	11	12	13	14	15	DI1	ON	OFF	ON	OFF	ON	OFF	ON	DI2	OFF	ON	ON	OFF	OFF	ON	ON	DI3	OFF	OFF	OFF	ON	ON	ON	ON	DI4	ON	ON	ON	ON	ON	ON	ON	5165	
	1		2	3	4	5	6	7	8																																																																																
DI1	ON		OFF	ON	OFF	ON	OFF	ON	OFF																																																																																
DI2	OFF		ON	ON	OFF	OFF	ON	ON	OFF																																																																																
DI3	OFF		OFF	OFF	ON	ON	ON	ON	OFF																																																																																
DI4	OFF		OFF	OFF	OFF	OFF	OFF	OFF	ON																																																																																
	9		10	11	12	13	14	15																																																																																	
DI1	ON		OFF	ON	OFF	ON	OFF	ON																																																																																	
DI2	OFF		ON	ON	OFF	OFF	ON	ON																																																																																	
DI3	OFF		OFF	OFF	ON	ON	ON	ON																																																																																	
DI4	ON	ON	ON	ON	ON	ON	ON																																																																																		
RST	Stop of program operation (When "DIIn" changes from OFF to ON)	5166																																																																																							
LOC	Start of local-mode operation (When "DIIn" changes from OFF to ON)	5167																																																																																							
HOLD	Start of hold-mode operation (When "DIIn" changes from OFF to ON)	0																																																																																							
ADV	Advance of segment (When "DIIn" changes from OFF to ON)	0																																																																																							
A/M1	Loop1 AUTO/MAN switching (AUTO when contact input is ON; MAN when contact input is OFF)	0																																																																																							
A/M2	Loop2 AUTO/MAN switching	0																																																																																							
L/C	LOCAL/CASCADE switching	0																																																																																							
PTN.0	Bit 0 of program pattern number	5161																																																																																							
PTN.1	Bit 1 of program pattern number	5162																																																																																							
PTN.2	Bit 2 of program pattern number	5163																																																																																							
PTN.3	Bit 3 of program pattern number	5164																																																																																							
PTN.4	Bit 4 of program pattern number	0																																																																																							
MG1	Interruptive message display 1	0																																																																																							
MG2	Interruptive message display 2	0																																																																																							
MG3	Interruptive message display 3	0																																																																																							
MG4	Interruptive message display 4	0																																																																																							

● **UP Mode Parameters**

Located in: Main menu = **UPMD** ; Submenu = **MD**

Parameter Symbol	Name of Parameter	Setting Range and Description	Initial Value	User Setting
UPM	Controller mode (UP mode)	11: Dual-loop control For another Controller mode, see User's Manual (Reference) (CD-ROM version).	1	
SMP	PV sampling period setting	100, 200 and 500 ms The controller restarts if any change is made to the PV sampling period; this does not affect other parameter settings at all, however.	200 ms	
SMEC	Sampling period error counter (reading only)	0 to 30000	Shows 0 at power-on.	

● Input-related Parameters

Located in: Main menu = **UPMD** ; Submenu = **IN**

Parameter Symbol	Name of Parameter	Setting Range and Description	Initial Value	User Setting
IN1	PV input type of Loop1 (INPUT 1 terminals) Terminals ①, ② and ③	Specify the type of PV input of Loop1 as a range code. See "Instrument Input Range Codes" in "2. Initial Settings."	OFF (0)	
UNI1	PV input unit of Loop1	Select the unit of PV input of Loop1. % (0): Percent - (2): No unit °C (1): Degree Celsius °F (5): Fahrenheit	Depends on the Loop1 PV input type.	
RH1	Max. value of PV input range of Loop1	Set the instrument input range (RL1 < RH1). - For temperature input -	Depends on the Loop1 PV input type.	
RL1	Min. value of PV input range of Loop1	- Set the range of temperature that is actually controlled. - For voltage input - Set the range of a voltage signal that is applied. The scale across which the voltage signal is actually controlled should be set using the parameters Maximum Value of PV Input Scale (SH1) and Minimum Value of PV Input Scale (SL1).		
SDP1	PV input decimal point position of Loop1 (shown when in voltage-input mode)	Set the position of the decimal point of voltage-mode PV input of Loop1. 0 to 4 0: No decimal place 1: One decimal place, 2 to 4: Two, three, four decimal places	Depends on the Loop1 PV input type.	
SH1	Max. value of PV input scale of Loop1 (shown when in voltage-input mode)	Set the read-out scale of voltage-mode PV input of Loop1. -19999 to 30000, where SL1 < SH1	Depends on the Loop1 PV input type.	
SL1	Min. value of PV input scale of Loop1 (shown when in voltage-input mode)			
BSL1	Selection of PV input burnout action of Loop1	Allows the PV input value to be determined as shown below in case of PV input burnout of Loop1. • 105% of PV input range of Loop1 if set to "Upscale" • -5.0% of PV input range of Loop1 if set to "Downscale" OFF (0): Disable UP (1): Upscale DOWN (2): Downscale	Depends on the Loop1 PV input type.	
RJC1	Presence/absence of PV input of Loop1 reference junction compensation	Allows input compensation to be applied to thermocouple input. OFF (0): Absent ON (1): Present	ON (1)	

Parameter Symbol	Name of Parameter	Setting Range and Description	Initial Value	User Setting
IN2	PV input type of Loop2 (INPUT 2 terminals) Terminals ④, ⑤ and ⑥	Specify the type of PV input of Loop2 as a range code. See "Instrument Input Range Codes" in "2. Initial Settings."	typeK1 (1)	
UNI2	PV input unit of Loop2	Select the unit of PV input of Loop2. % (0): Percent - (2): No unit °C (1): Degree Celsius °F (5): Fahrenheit	°C (1)	
RH2	Max. value of PV input range of Loop2	Set the instrument input range (RL2 < RH2). - For temperature input - Set the range of temperature that is actually controlled.	1370.0	
RL2	Min. value of PV input range of Loop2	- For voltage input - Set the range of a voltage signal that is applied. The scale across which the voltage signal is actually controlled should be set using the parameters Maximum Value of PV Input Scale (SH2) and Minimum Value of PV Input Scale (SL2).	-270.0	
SDP2	PV input decimal point position of Loop2 (shown when in voltage-input mode)	Set the position of the decimal point of voltage-mode PV input of Loop2. 0 to 4 0: No decimal place 1: One decimal place, 2 to 4: Two, three, four decimal places	2	
SH2	Max. value of PV input scale of Loop2 (shown when in voltage-input mode)	Set the read-out scale of voltage-mode PV input of Loop2. -19999 to 30000, where SL2 < SH2	100.00	
SL2	Min. value of PV input scale of Loop2 (shown when in voltage-input mode)		0.00	
BSL2	Selection of PV input burnout action of Loop2	Allows the PV input value to be determined as shown below in case of PV input burnout of Loop2. • 105% of PV input range of Loop2 if set to "Upscale" • -5.0% of PV input range of Loop2 if set to "Downscale" OFF (0): Disable UP (1): Upscale DOWN (2): Downscale	OFF (0)	
RJC2	Presence/absence of PV input of Loop2 reference junction compensation	Allows input compensation to be applied to thermocouple input. OFF (0): Absent ON (1): Present	ON (1)	
IN3	Auxiliary analog input type (INPUT 3 terminals) Terminals ⑦ and ⑧	Although not used in dual-loop control, it is shown on the display.		
UNI3	Auxiliary analog input unit	Although not used in dual-loop control, it is shown on the display.		
RH3	Maximum value of auxiliary analog input range	Although not used in dual-loop control, it is shown on the display.		
RL3	Minimum value of auxiliary analog input range	Although not used in dual-loop control, it is shown on the display.		
SDP3	Auxiliary analog input decimal point position	Although not used in dual-loop control, it is shown on the display.		
SH3	Max. value of auxiliary analog input scale	Although not used in dual-loop control, it is shown on the display.		
SL3	Min. value of auxiliary analog input scale	Although not used in dual-loop control, it is shown on the display.		
BSL3	Auxiliary analog input burnout action selection	Although not used in dual-loop control, it is shown on the display.		

Parameter Symbol	Name of Parameter	Setting Range and Description	Initial Value	User Setting
P.UN1	PV1 unit (Loop1)	Set the unit of PV1. % (0): Percent - (2): No unit °C (1): Degree Celsius °F (5): Fahrenheit	Same as the unit of Loop1 PV input	
P.DP1	PV1 decimal point position (Loop1)	Under normal operation, set the same value as in the PV Input Decimal Point Position (SDP1) parameter of Loop1. To shift the decimal point for temperature input, use this parameter. For example, set as "P.DP1 = 0" to change a temperature reading of one decimal place to that of no decimal places. This involves reconfiguring the P.RH1 and P.RL1 parameters. 0 to 4	-	
P.RH1	Maximum value of PV1 range (Loop1)	Under normal operation, keep the values of these parameters between the maximum and minimum values of the PV input range of Loop1. -19999 to 30000 P.RL1 < P.RH1, where P.RH1-P.RL1 ≤ 30000	Maximum value of Loop1 PV input range or scale	
P.RL1	Minimum value of PV1 range (Loop1)		Minimum value of Loop1 PV input range or scale	
P.UN2	PV2 unit (Loop2)	Set the unit of PV2. % (0): Percent - (2): No unit °C (1): Degree Celsius °F (5): Fahrenheit	Same as the unit of Loop2 PV input	
P.DP2	PV2 decimal point position (Loop2)	Under normal operation, set the same value as in the PV Input Decimal Point Position (SDP2) parameter of Loop2. To shift the decimal point for temperature input, use this parameter. For example, set as "P.DP2 = 0" to change a temperature reading of one decimal place to that of no decimal places. This involves reconfiguring the P.RH2 and P.RL2 parameters. 0 to 4	-	
P.RH2	Maximum value of PV2 range (Loop2)	Under normal operation, keep the values of these parameters between the maximum and minimum values of the PV input range of Loop2. -19999 to 30000 P.RL2 < P.RH2, where P.RH2-P.RL2 ≤ 30000	Maximum value of Loop2 PV input range or scale	
P.RL2	Minimum value of PV2 range (Loop2)		Minimum value of Loop2 PV input range or scale	

● Output-related Parameters

Located in: Main menu = **UPMD** ; Submenu = **OUT**

Parameter Symbol	Name of Parameter	Setting Range and Description	Initial Value	User Setting	
OT1	Control output type of Loop1	0	Time proportional PID relay contact output (terminals ① - ② - ③)	0	
		1	Time proportional PID voltage pulse output (terminals ⑩ - ⑪)		
		2	Current output (terminals ⑩ - ⑪)		
		3	ON/OFF control relay contact output (terminals ① - ② - ③)		
		4	Heating-side relay output (terminals ① - ② - ③), cooling-side relay output (terminals ④ - ⑦)		
		5	Heating-side pulse output (terminals ⑩ - ⑪), cooling-side relay output (terminals ④ - ⑦)		
		6	Heating-side current output (terminals ⑩ - ⑪), cooling-side relay output (terminals ④ - ⑦)		
		7	Heating-side relay output (terminals ① - ② - ③), cooling-side transistor output (terminals ⑭ - ⑮)		
		8	Heating-side pulse output (terminals ⑩ - ⑪), cooling-side transistor output (terminals ⑭ - ⑮)		
		9	Heating-side current output (terminals ⑩ - ⑪), cooling-side transistor output (terminals ⑭ - ⑮)		
		10	Heating-side relay output (terminals ① - ② - ③), cooling-side current output (terminals ⑭ - ⑮)		
		11	Heating-side pulse output (terminals ⑩ - ⑪), cooling-side current output (terminals ⑭ - ⑮)		
		12	Heating-side current output (terminals ⑩ - ⑪), cooling-side current output (terminals ⑭ - ⑮)		
OT2	Control output type of Loop2	0	Time proportional PID relay contact output (terminals ④⑧ - ④⑨ - ⑤①)	0	
		1	Time proportional PID voltage pulse output (terminals ④⑥ - ④⑦)		
		2	Current output (terminals ④⑥ - ④⑦)		
		3	ON/OFF control relay contact output (terminals ④⑧ - ④⑨ - ⑤①)		
		4	Heating-side relay output (terminals ④⑧ - ④⑨ - ⑤①), cooling-side relay output (terminals ⑤ - ⑦)		
		5	Heating-side pulse output (terminals ④⑥ - ④⑦), cooling-side relay output (terminals ⑤ - ⑦)		
		6	Heating-side current output (terminals ④⑥ - ④⑦), cooling-side relay output (terminals ⑤ - ⑦)		
		7	Heating-side relay output (terminals ④⑧ - ④⑨ - ⑤①), cooling-side transistor output (terminals ③③ - ③⑤)		
		8	Heating-side pulse output (terminals ④⑥ - ④⑦), cooling-side transistor output (terminals ③③ - ③⑤)		
		9	Heating-side current output (terminals ④⑥ - ④⑦), cooling-side transistor output (terminals ③③ - ③⑤)		

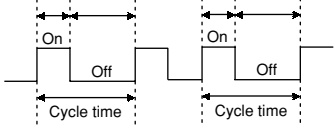
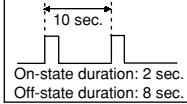
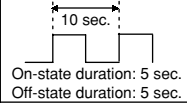
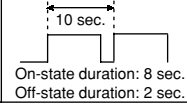
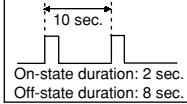
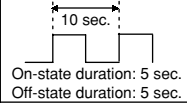
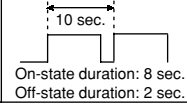
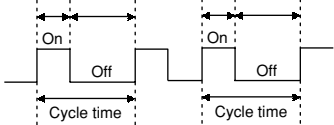
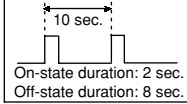
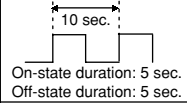
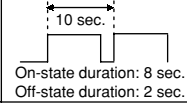
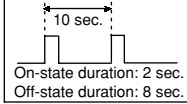
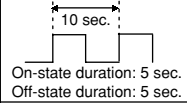
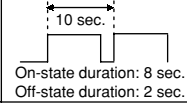
Parameter Symbol	Name of Parameter	Setting Range and Description	Initial Value	User Setting		
CT1	Control output cycle time of Loop1 Heating-side control output cycle time (in heating/cooling control)	1 to 1000 sec. 	30 sec.			
		Relay's Behavior when Cycle Time = 10 sec. <table border="1" data-bbox="655 434 1230 568"> <thead> <tr> <th>For 20% of Control Output</th> <th>For 50% of Control Output</th> <th>For 80% of Control Output</th> </tr> </thead> <tbody> <tr> <td></td> <td></td> <td></td> </tr> </tbody> </table>			For 20% of Control Output	For 50% of Control Output
For 20% of Control Output	For 50% of Control Output	For 80% of Control Output				
						
CT2	Control output cycle time of Loop2 Heating-side control output cycle time (in heating/cooling control)	1 to 1000 sec. 	30 sec.			
		Relay's Behavior when Cycle Time = 10 sec. <table border="1" data-bbox="655 799 1230 934"> <thead> <tr> <th>For 20% of Control Output</th> <th>For 50% of Control Output</th> <th>For 80% of Control Output</th> </tr> </thead> <tbody> <tr> <td></td> <td></td> <td></td> </tr> </tbody> </table>			For 20% of Control Output	For 50% of Control Output
For 20% of Control Output	For 50% of Control Output	For 80% of Control Output				
						
CTc1	Cooling-side control output cycle time of Loop1	1 to 1000 sec.	30 sec.			
CTc2	Cooling-side control output cycle time of Loop2	1 to 1000 sec.	30 sec.			
AO1	Analog output-1 type (OUTPUT 1: Terminals ⑥ and ⑦)	Allows control output or retransmission output to be presented as one of the following current signals. 0: 4 to 20 mA 1: 0 to 20 mA 2: 20 to 4 mA 3: 20 to 0 mA	0			
AO2	Analog output-2 type (OUTPUT 2: Terminals ④⑥ and ④⑦)		0			
AO3	Analog output-3 type (OUTPUT 3: Terminals ④④ and ④⑤)		0			
A1H	Analog output-1 100% segmental point	Set the values of segmental points for the 0% and 100% output levels at which the values are presented via OUTPUT-1 (terminals ⑥ and ⑦). See "■ Performing Split Computations" below. -5.0% to 105.0%	100.0%			
A1L	Analog output-1 0% segmental point		0.0%			
A2H	Analog output-2 100% segmental point	Set the values of segmental points for the 0% and 100% output levels at which the values are presented via OUTPUT-2 (terminals ④⑥ and ④⑦). See "■ Performing Split Computations" below. -5.0% to 105.0%	100.0%			
A2L	Analog output-2 0% segmental point		0.0%			
A3H	Analog output-3 100% segmental point	Set the values of segmental points for the 0% and 100% output levels at which the values are presented via OUTPUT-3 (terminals ④④ and ④⑤). See "■ Performing Split Computations" below. -5.0% to 105.0%	100.0%			
A3L	Analog output-3 0% segmental point		0.0%			

■ Performing Split Computations

[V-mode Output]

The following explains an example of letting “Analog OUTPUT-1 (terminals ⑯ and ⑰)” and “Analog OUTPUT-3 (terminals ⑭ and ⑮)” present the V-mode characteristics of split computations.

- [1] Set the Control Output Type (OT1) parameter to “2”.
This sets the control output to “current output.”
- [2] Set the Retransmission Output 1 (RET1) parameter to “3”.
This sets the retransmission output of Loop1 to “control output retransmission.”
- [3] Set the Analog Output-1 100% Segmental Point (A1H) parameter to “100%”.
- [4] Set the Analog Output-1 0% Segmental Point (A1L) parameter to “25%”.
- [5] Set the Analog Output-3 100% Segmental Point (A3H) parameter to “0%”.
- [6] Set the Analog Output-3 0% Segmental Point (A3L) parameter to “75%”.

The figure below shows an example where both analog outputs-1 and 3 are set to the current signal of 4 to 20 mA DC. The type of output signal can be determined separately for each of the analog outputs listed above, using the following three parameters.

- Analog output-1: Analog output-1 type (AO1)
- Analog output-2: Analog output-2 type (AO2)
- Analog output-3: Analog output-3 type (AO3)

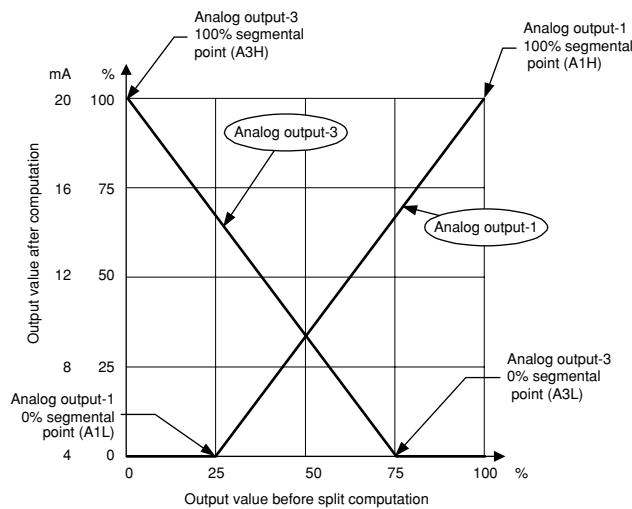

[Parallel-mode Output]

The following explains an example of letting “Analog OUTPUT-1 (terminals ⑯ and ⑰)” and “Analog OUTPUT-3 (terminals ⑭ and ⑮)” present the parallel-mode characteristics of split computations.

- [1] Set the Control Output Type (OT1) parameter to “2”.
This sets the control output to “current output.”
- [2] Set the Retransmission Output 1 (RET1) parameter to “3”.
This sets the retransmission output of Loop1 to “control output retransmission.”
- [3] Set the Analog Output-1 100% Segmental Point (A1H) parameter to “100%”.
- [4] Set the Analog Output-1 0% Segmental Point (A1L) parameter to “25%”.
- [5] Set the Analog Output-3 100% Segmental Point (A3H) parameter to “75%”.
- [6] Set the Analog Output-3 0% Segmental Point (A3L) parameter to “0%”.

The figure below shows an example where both analog outputs-1 and 3 are set to the current signal of 20 to 0 mA DC. The type of output signal can be determined separately for each of the analog outputs listed above, using the following three parameters.

- Analog output-1: Analog output-1 type (AO1)
- Analog output-2: Analog output-2 type (AO2)
- Analog output-3: Analog output-3 type (AO3)

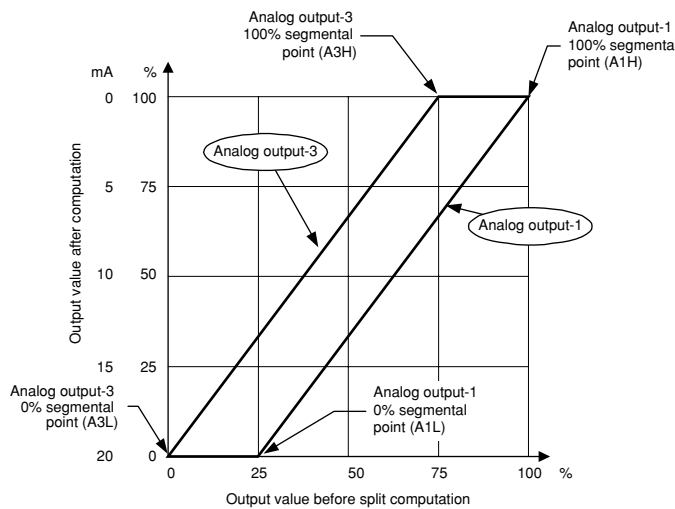

● Communication Parameters

Located in: Main menu = **UPMD** ; Submenu = **R485**

Parameter Symbol	Name of Parameter	Setting Range and Description	Initial Value	User Setting
PSL1	Protocol selection 1	0: PC link communication 1: PC link communication (with sum check) 2: Ladder communication 3: Coordinated master station 7: MODBUS (ASCII) 8: MODBUS (RTU) 9: Coordinated master station (2 loop mode)	0	
BPS1	Baud rate 1	600 (0), 1200 (1), 2400 (2), 4800 (3), 9600 (4) (bps)	9600 (4)	
PRI1	Parity 1	NONE (0): None EVEN (1): Even ODD (2): Odd	EVEN (1)	
STP1	Stop bit 1	1, 2	1	
DLN1	Data length 1	7, 8; 7 is fixed for MODBUS (ASCII) 8 is fixed for MODBUS (RTU), Ladder	8	
ADR1	Address 1	1 to 99 However, the maximum number of stations connectable is 31.	1	
RP.T1	Minimum response time 1	0 to 10 (× 10 ms)	0	
PSL2	Protocol selection 2	0: PC link communication 1: PC link communication (with sum check) 2: Ladder communication 3: Coordinated master station 4: Coordinated slave station 5: I/O expansion (for single-controller applications) 6: I/O expansion (for dual-controller applications) 9: Coordinated master station (2 loop mode) 10: Coordinated slave station (loop-1 mode) 11: Coordinated slave station (loop-2 mode)	0	
BPS2	Baud rate 2	600 (0), 1200 (1), 2400 (2), 4800 (3), 9600 (4), 19200 (5), 38400 (6) (bps)	9600 (4)	
PRI2	Parity 2	NONE (0): None EVEN (1): Even ODD (2): Odd	EVEN (1)	
STP2	Stop bit 2	1, 2	1	
DLN2	Data length 2	7, 8 8 is fixed for Ladder	8	
ADR2	Address 2	1 to 99 However, the maximum number of stations connectable is 31.	1	
RP.T2	Minimum response time 2	0 to 10 (× 10 ms)	0	

● Parameter-initializing Parameters

Located in: Main menu = **UPMD** ; Submenu = **INIT**

Parameter Symbol	Name of Parameter	Setting Range and Description	Initial Value	User Setting
INI	Parameter initialization	OFF (0): - ON (1): Initialize parameters	OFF (0)	

■ Tips about Heating/Cooling Control

In heating/cooling control, the controller outputs the result of computation after splitting it into heating-purpose and cooling-purpose signals. In addition, the controller can perform PID control or ON/OFF control on the heating and cooling sides separately. When performing ON/OFF control, set the proportional band to “0”.

The controller splits the result of computation (0 to 100%) into heating-side and cooling-side signals, as described below.

- 0% to 50% of the computation result is presented as a 0% to 100% cooling-side output.
- 50% to 100% of the computation result is presented as a 0% to 100% heating-side output.

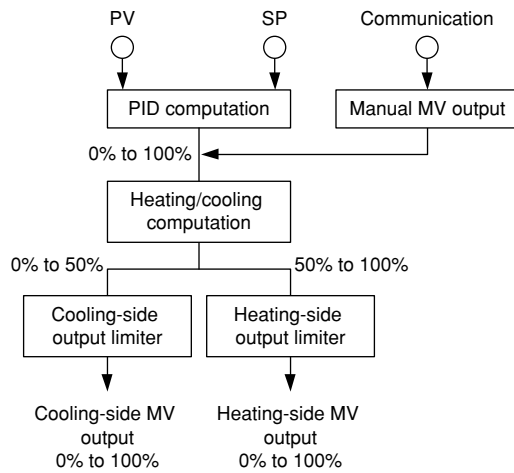

Heating/cooling control provides two methods in which either none of the heating- and cooling-side outputs are presented or both of the heating- and cooling-side outputs are presented, as shown in the following figures.

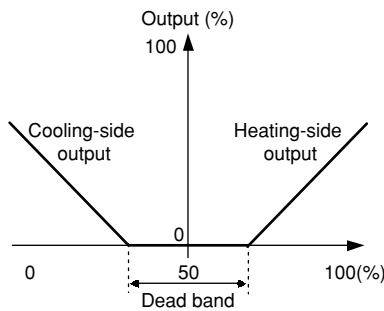

Value of control output before split into heating- and cooling-side outputs

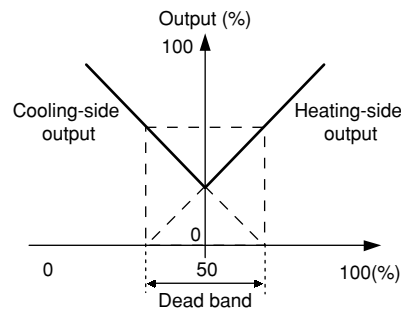

Value of control output before split into heating- and cooling-side outputs

Precautions in Heating/Cooling Control

- Keep the ratio of the heating-side proportional band (P) to the cooling-side proportional band (Pc) equal to or below 5.
- If neither the heating-side nor the cooling-side is performing ON/OFF control, setting the integral time (I or Ic) of one side to “0” results in the Integral Time parameters of both sides being set to “OFF”, irrespective of the integral time setting of the other side.

Blank Page

7. Function Block Diagram and Descriptions

This chapter contains the function block diagrams for “Dual-loop control,” “Dual-loop heating/cooling control.” For details on these function block diagrams, refer to the descriptions mentioned later.

Function Block Diagram for Dual-loop Control

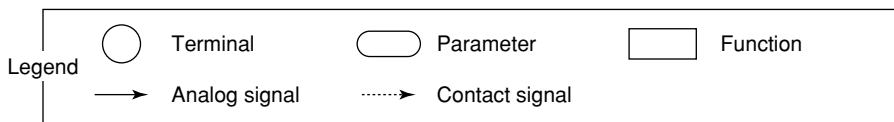
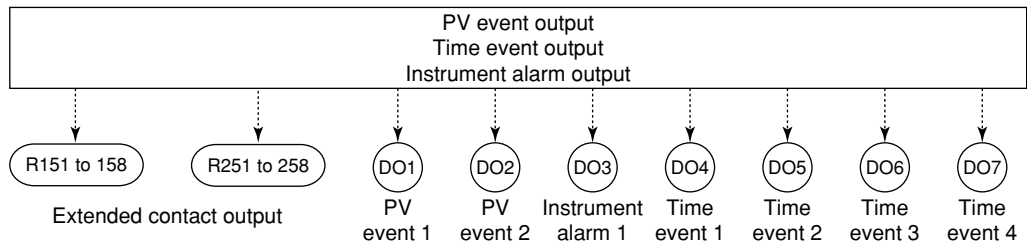
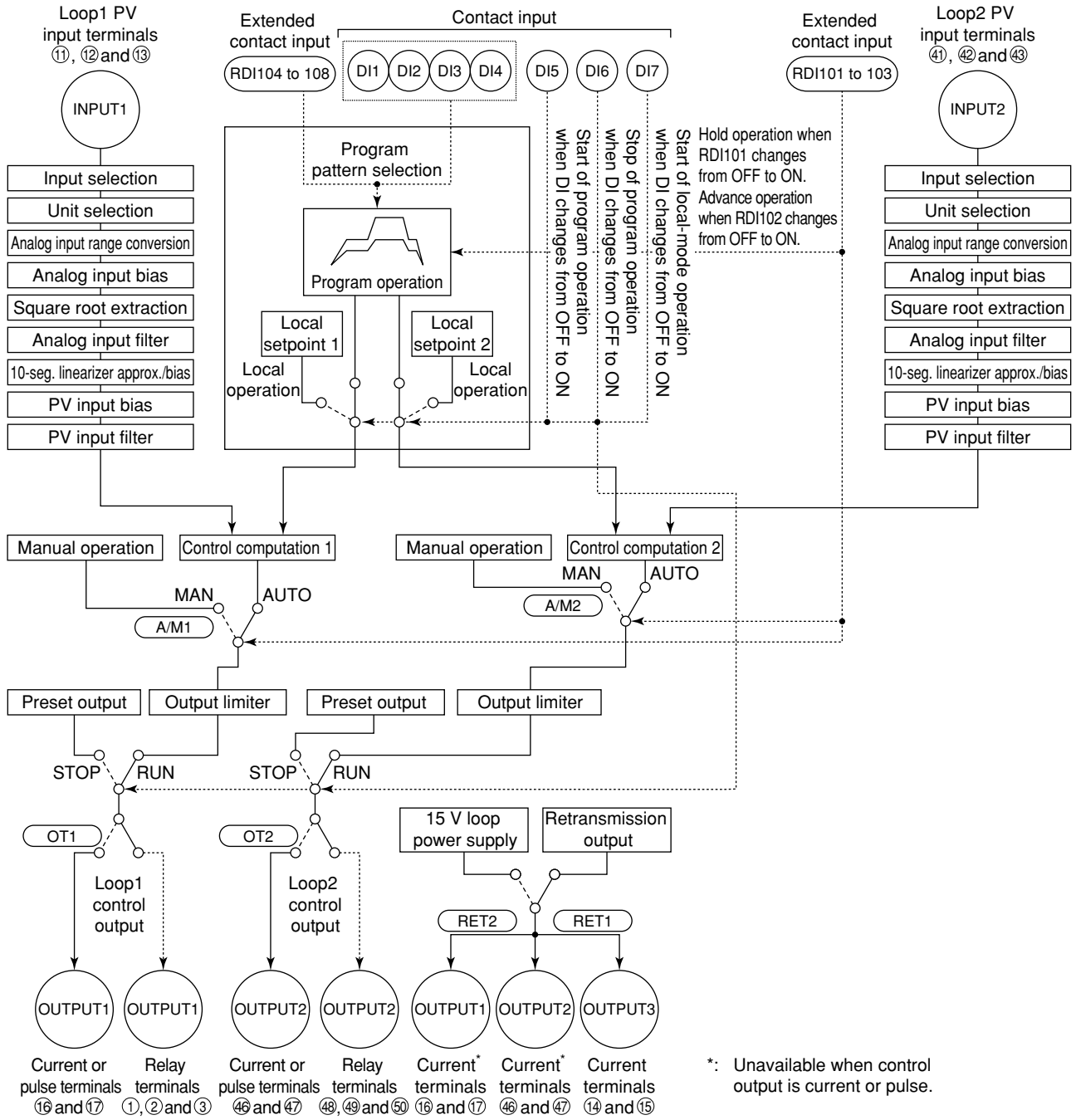

Function Block Diagram for Dual-loop Heating/Cooling Control

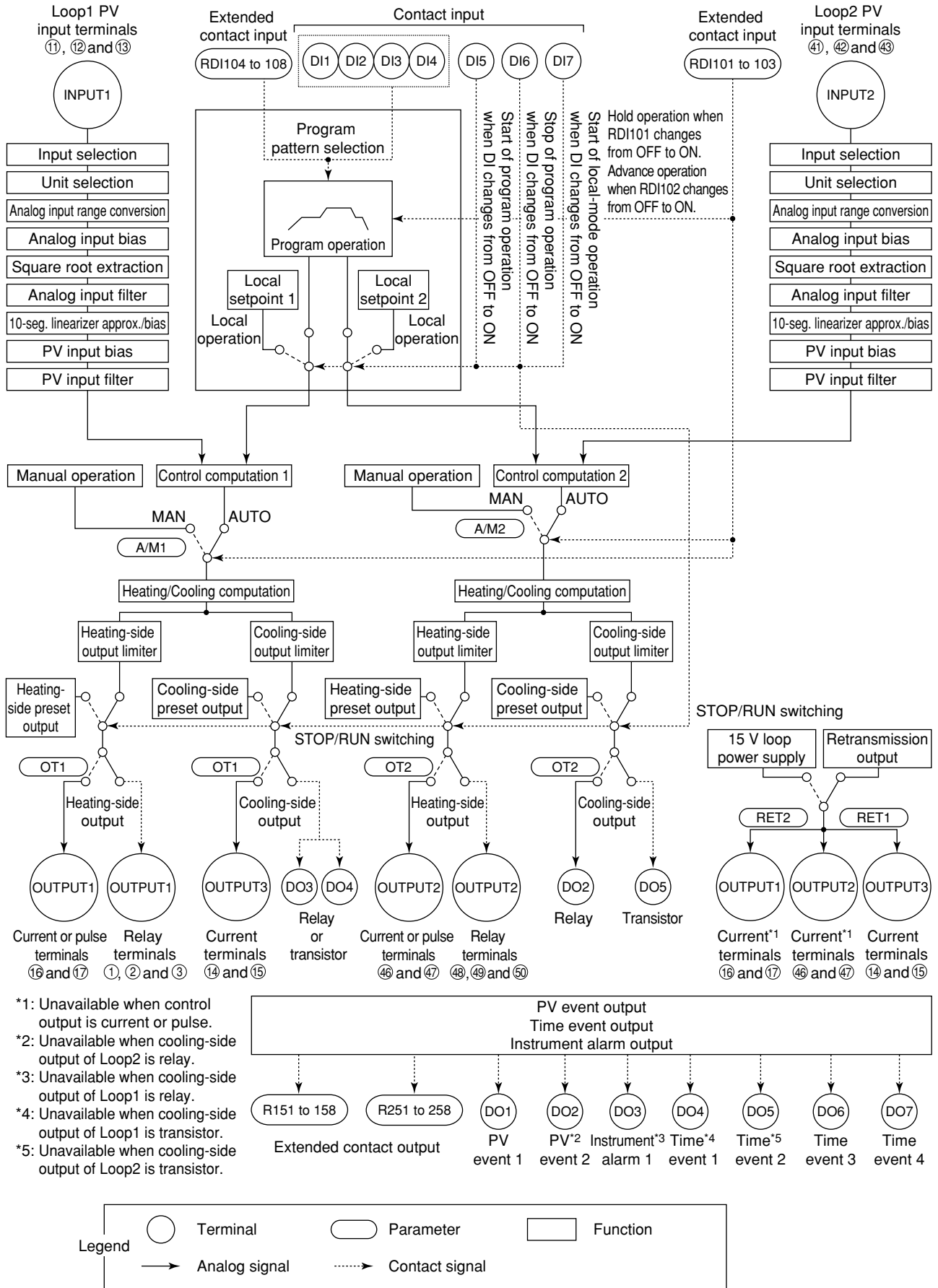

*1: Unavailable when control output is current or pulse.
 *2: Unavailable when cooling-side output of Loop2 is relay.
 *3: Unavailable when cooling-side output of Loop1 is relay.
 *4: Unavailable when cooling-side output of Loop1 is transistor.
 *5: Unavailable when cooling-side output of Loop2 is transistor.

Functions and Parameters for “Dual-loop control” in Initial State

Functions and parameters in initial state are given in the tables below. For details on each parameter, refer to “6.2 Lists of Parameters.”

■ PV Input of Loop1

PV input of Loop1 (INPUT1) is a universal input, which can receive signals from thermocouple, RTD, or DC voltage signals. The controller is capable of biasing, square root extraction, first-order lag computation (filtering), ten-segment linearizer approximation, and ten-segment linearizer biasing on input signals.

Each function can be set by the following parameters.

Setup Parameters

Function	Parameter	Main menu	Submenu
Input selection	IN1	UPMD	IN
Unit selection	UNI1	UPMD	IN
Analog input range conversion	RH1, RL1 (SDP1, SH1, SL1)	UPMD	IN
Analog input bias	A.BS1	CMLP	AIN
Square root extraction	A.SR1, A.LC1	CMLP	AIN
Analog input filter	A.FL1	CMLP	AIN

Operating Parameters

Function	Parameter	Main menu	Submenu
Ten-segment linearizer mode	1.PMD	PYS1	None
Ten-segment linearizer approximation/biasing	1.a1 to 1.a11, 1.b1 to 1.b11	PYS1	None
PV input bias	BS	LP1	PAR
PV input filter	FL	LP1	PAR

Note: PV input bias (BS) and PV input filter (FL) among the operating parameters are used as bias and filter when normal operation. Analog input bias (A.BS1) and analog input filter (A.FL1) among the setup parameters are used when PV correction value is decided in advance.

■ PV Input of Loop2

PV input of Loop2 (INPUT2) is a universal input, which can receive signals from thermocouple, RTD, or DC voltage signals. The controller is capable of biasing, square root extraction, first-order lag computation (filtering), ten-segment linearizer approximation, and ten-segment linearizer biasing on input signals.

Each function can be set by the following parameters.

Setup Parameters

Function	Parameter	Main menu	Submenu
Input selection	IN2	UPMD	IN
Unit selection	UNI2	UPMD	IN
Analog input range conversion	RH2, RL2 (SDP2, SH2, SL2)	UPMD	IN
Analog input bias	A.BS2	CMLP	AIN
Square root extraction	A.SR2, A.LC2	CMLP	AIN
Analog input filter	A.FL2	CMLP	AIN

Operating Parameters

Function	Parameter	Main menu	Submenu
Ten-segment linearizer mode	2.PMD	PYS2	None
Ten-segment linearizer approximation/biasing	2.a2 to 2.a22, 2.b2 to 2.b22	PYS2	None
PV input bias	BS	LP2	PAR
PV input filter	FL	LP2	PAR

Note: PV input bias (BS) and PV input filter (FL) among the operating parameters are used as bias and filter when normal operation. Analog input bias (A.BS2) and analog input filter (A.FL2) among the setup parameters are used when PV correction value is decided in advance.

■ Selecting Program Pattern Using Contact Input

It is possible to select the program pattern by turning the four contact input signals ON or OFF. This function is assigned to DI1 (contact input 1) to DI4 (contact input 4). Note that the program pattern can be selected during RESET mode, can not during operation.

Contact input	Program pattern number to be selected (PT.No)														
	1	2	3	4	5	6	7	8	9	10	11	12	13	14	15
DI1	ON	OFF	ON	OFF	ON	OFF	ON	OFF	ON	OFF	ON	OFF	ON	OFF	ON
DI2	OFF	ON	ON	OFF	OFF	ON	ON	OFF	OFF	ON	ON	OFF	OFF	ON	ON
DI3	OFF	OFF	OFF	ON	ON	ON	ON	OFF	OFF	OFF	OFF	ON	ON	ON	ON
DI4	OFF	OFF	OFF	OFF	OFF	OFF	OFF	ON	ON	ON	ON	ON	ON	ON	ON

For example, set contact input 2 (DI2) only to "ON" to change the program pattern 1 to the program pattern 2.

Set contact input 1 (DI1) and contact input 2 (DI2) to "ON" to select the program pattern 3.

■ Switching Operation Mode Using Contact Input



Program operation for the selected program pattern starts when DI5 (contact input 5) changes from OFF to ON.

Program operation stops when DI6 (contact input 6) changes from OFF to ON. Preset output value is outputted when the operation stops.

Local-mode operation starts when DI7 (contact input 7) changes from OFF to ON.

■ Switching Operation Mode and Selection Program Pattern Using Extended Input/Output

When connecting contact input/output extension module, switching operation mode and more than sixteen program pattern by extension input (RDI101 to RDI108) can be selected.

Extended contact input	Function	Switching method	Function
RDI101	Hold operation	When OFF to ON, program operation temporarily STOP.	-
RDI102	Advanced operation	When OFF to ON, advanced next segment.	-
RDI103	Switching AUTO/ MAN	ON = AUTO OFF = MAN	When manual operation, output value can be changed  or  key.
RDI104	Switching program pattern	Program pattern selection by contact input nine points with DI1 to DI4. Available up to 300 patterns.	Program pattern number of other contact input added with number below can be used. • RDI104 ON: +16 • RDI105 ON: +32 • RDI106 ON: +64 • RDI107 ON: +128 • RDI108 ON: +256
RDI105			
RDI106			
RDI107			
RDI108			

For example, when selecting seventeenth program pattern, set DI1 is ON, DI2 is OFF, DI3 is OFF, DI4 is OFF, RDI104 is ON, RDI105 to RDI108 is OFF.

■ PID (Loop1)

It is possible to use a maximum of eight groups of PID parameters.

Operating Parameters

Function	Parameter	Main menu	Submenu
Proportional band (P)	n.P	LP1	n.PID
Integral time (I)	n.I	LP1	n.PID
Derivative time (D)	n.D	LP1	n.PID
Cooling-side proportional band (Pc)	n.Pc	LP1	n.PID
Cooling-side integral time (Ic)	n.Ic	LP1	n.PID
Cooling-side derivative time (Dc)	n.Dc	LP1	n.PID

■ PID (Loop2)

It is possible to use a maximum of eight groups of PID parameters.

Operating Parameters

Function	Parameter	Main menu	Submenu
Proportional band (P)	n.P	LP2	n.PID
Integral time (I)	n.I	LP2	n.PID
Derivative time (D)	n.D	LP2	n.PID
Cooling-side proportional band (Pc)	n.Pc	LP2	n.PID
Cooling-side integral time (Ic)	n.Ic	LP2	n.PID
Cooling-side derivative time (Dc)	n.Dc	LP2	n.PID

■ Control Output of Loop1

Control output of Loop1 (OUTPUT1) selects the output type among the current output, voltage pulse output, and relay contact output signal.

Preset output value is output when the operation is stopped by key operation or contact input, which takes priority over the manual operation.

Each function can be set by the following parameters.

Setup Parameters

Function	Parameter	Main menu	Submenu
Control output type selection	OT1	UPMD	OUT
Control output cycle time	CT1	UPMD	OUT
Analog output-1 type	AO1	UPMD	OUT

Operating Parameters

Function	Parameter	Main menu	Submenu
Preset output	n.PO	LP1	n.PID
Output limiter	n.OL, n.OH	LP1	n.PID

■ Control Output of Loop2

Control output of Loop2 (OUTPUT2) selects the output type among the current output, voltage pulse output, and relay contact output signal.

Preset output value is output when the operation is stopped by key operation or contact input, which takes priority over the manual operation.

Each function can be set by the following parameters.

Setup Parameters

Function	Parameter	Main menu	Submenu
Control output type selection	OT2	UPMD	OUT
Control output cycle time	CT2	UPMD	OUT
Analog output-2 type	AO2	UPMD	OUT

Operating Parameters

Function	Parameter	Main menu	Submenu
Preset output	n.PO	LP2	n.PID
Output limiter	n.OL, n.OH	LP2	n.PID

■ Contact Output

PV event 1 is outputted via DO1 (contact output 1).

PV event 2 is outputted via DO2 (contact output 2).

Instrument alarm 1 is outputted via DO3 (contact output 3).

Time event 1 is outputted via DO4 (contact output 4).

Time event 2 is outputted via DO5 (contact output 5).

Time event 3 is outputted via DO6 (contact output 6).

Time event 4 is outputted via DO7 (contact output 7).

Extended Contact Output

When contact input/output extension module is connected, PV event contact and time event is output to expended contact output (R151 to R158, R251 to R258).

Contact output	Output configuration (*1)	Function
R151(*2)	Relay/O.C.	PV event 3 output
R152(*2)	Relay/O.C.	PV event 4 output
R153(*2)	Relay/O.C.	Time event 5 output
R154(*2)	Relay/O.C.	Time event 6 output
R155(*2)	Relay/O.C.	Time event 7 output
R156(*2)	Relay/O.C.	Time event 8 output
R157(*2)	Relay/O.C.	Time event 9 output
R158(*2)	Relay/O.C.	Time event 10 output
R251(*3)	Relay/O.C.	PV event 5 output
R252(*3)	Relay/O.C.	PV event 6 output
R253(*3)	Relay/O.C.	Time event 11 output
R254(*3)	Relay/O.C.	Time event 12 output
R255(*3)	Relay/O.C.	Time event 13 output
R256(*3)	Relay/O.C.	Time event 14 output
R257(*3)	Relay/O.C.	Time event 15 output
R258(*3)	Relay/O.C.	Time event 16 output

*1: The sign "O.C." stands for open collector output (transistor output)

*2: The first of contact input/output extension module.

*3: The third of contact input/output extension module.

Retransmission Output

PV, program setpoint, or control output can be output to retransmission output 1 (OUTPUT3).

Retransmission output 2 (OUTPUT1) can be used when the control output is relay.

Each function can be set by the following parameters.

Setup Parameters

Function	Parameter	Main menu	Submenu
Retransmission output 1 type	RET1	CMLP	RET
Retransmission output 1 scale	RTH1, RTL1	CMLP	RET
Retransmission output 2 type	RET2	CMLP	RET
Retransmission output 2 scale	RTH2, RTL2	CMLP	RET

■ 15 V DC Loop Power Supply

The 15 V DC loop power supply (OUTPUT3) uses the same terminal of retransmission output 1 or 2. The 15 V DC loop power supply can not be used when retransmission output 1 or 2 is used. To use the 15 V DC loop power supply, set "4" in retransmission output type 1 (RET1) or 2 (RET2) selection parameter.

Each function can be set by the following parameters.

Setup Parameters

Function	Parameter	Main menu	Submenu
Retransmission output 1 type	RET1	CMLP	RET
Retransmission output 2 type	RET2	CMLP	RET

Revision Information

- Title : Model UP750 Program Controller User's Manual for Dual-loop Control
- Manual No. : IM 05E01B02-51E

May 2000/1st Edition
Newly published

Written by Products Documents
Controllers & Conditioners Division
Yokogawa M&C Corporation
Published by Yokogawa M&C Corporation
1-19-18 Nakacho, Musashino-shi, Tokyo 180-0006, JAPAN

Blank Page