

**FUZZY  
CONTROLLER X**

Type: PYX

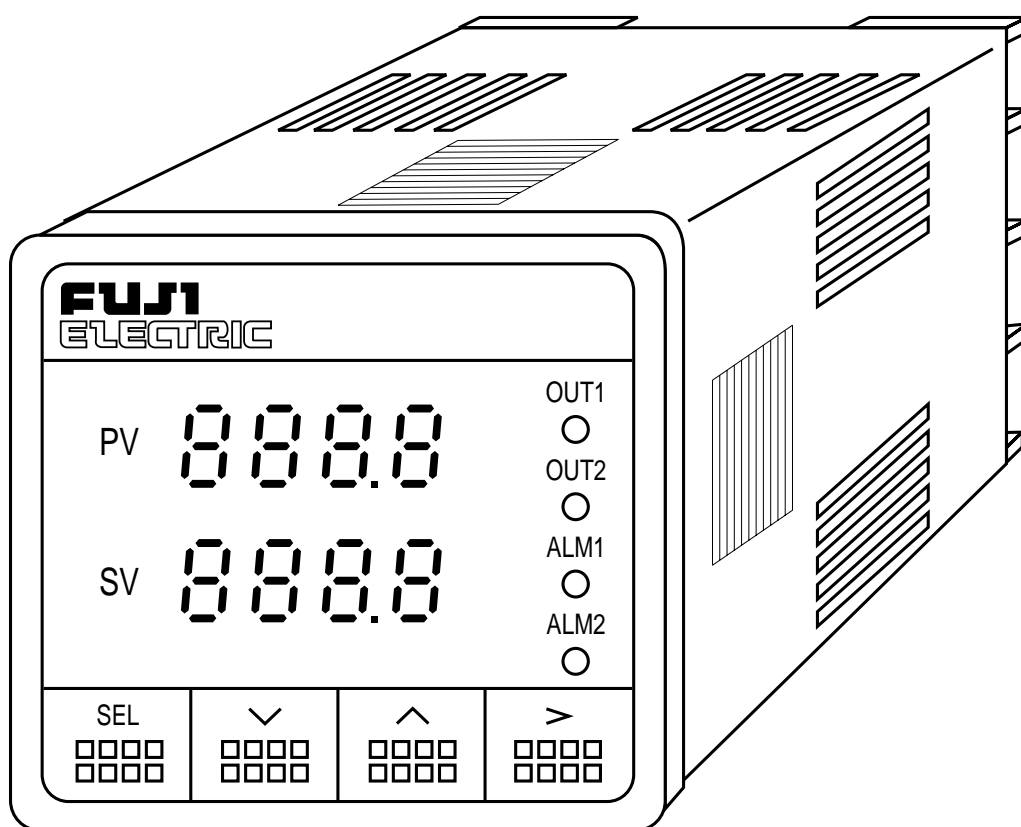

# Contents

---

I. PREPARING THE OPERATION .....	4
1. THE BASIC INSTALLATION PROCEDURE .....	5
2. CHECK OF SPECIFICATIONS .....	6
2.1 PYX4 MODEL CONFIGURATION .....	6
2.2 PYX5/9 MODEL CONFIGURATION .....	7
3. ACCESSORIES .....	8
4. INSTALLATION .....	8
4.1 INSTALLATION PLACE .....	8
4.2 INSTALLATION PROCEDURE .....	9
4.3 CAUTION ON SAFETY .....	10
4.4 PANEL CUT DIMENSIONS .....	18
5. WIRING .....	19
5.1 PYX4 WIRING DIAGRAM [When the output 1 is relay (SPST) output, SSR drive output or current output] .....	19
5.2 PYX4 WIRING DIAGRAM [When the output 1 is relay (SPDT) output] .....	21
5.3 PYX5/9 WIRING DIAGRAM (NOT UNIVERSAL OUTPUT) .....	23
5.4 PYX5/9 WIRING DIAGRAM (UNIVERSAL OUTPUT) .....	26
5.5 NOTES .....	28
II. FRONT PANEL LAYOUT .....	30

III. OPERATION PROCEDURE .....	33
1. OPERATION MODE/PARAMETER SETTING MODE .....	33
2. VIEWING PARAMETERS .....	33
3. CHANGING PARAMETERS .....	35
IV. SETTING INPUT AND OUTPUT TYPES .....	37
Changing input .....	37
Changing scale (voltage/current input) .....	41
Changing output (universal output) .....	42
V. FUNCTIONS .....	44
Lock .....	44
Auto-tuning .....	47
Control function .....	51
Alarm .....	55
Ramp soak .....	60
Two set-points .....	64
Analog output (AO) .....	65
Digital output .....	67
Manual operation .....	69
Remote SV .....	71
Output monitoring .....	72
VI. SET-UP PARAMETER .....	73
Input filter .....	73
PV shift .....	74
Control type .....	75
Output setting in input abnormal .....	76
Output limits .....	77
Set point value limits .....	78
Output cycle time .....	79
Direct/reverse control action .....	81

Control processing cycle time .....	82
<b>APPENDIX .....</b>	<b>83</b>
1. ERROR MESSAGES .....	83
2. POWER FAILURE .....	83
3. SPECIFICATIONS .....	84
4. TROUBLESHOOTING .....	89
5. PARAMETER LIST .....	91

# I. PREPARING THE OPERATION

---

We thank you for the purchase of this PYX (Fuzzy Temperature Controller).

Employing FUZZY LOGIC the PYX virtually eliminates system overshoot and effectively suppresses fluctuation of the process variable due to external disturbances.

Please read this manual, when programmed and operated within the guidelines set forth in this manual, your PYX controller will give you years of precise, reliable control.

## PYX

The product conforms to the requirements of the Electromagnetic compatibility Directive 89/336/EEC as detailed within the technical construction file number TN510401. The applicable standards used to demonstrate compliance are :

EN50081-1 : 1992 Conducted and Radiated emissions

EN50082-1 : 1992 Radiated immunity, ESD and FBT

(The unit meets Class A limits for Conducted Emissions.)

The unit also complies with the part of Immunity standards.

IEC1000-4-2 : 1995 level 3, IEC1000-4-3 : 1995 level 3

IEC1000-4-4 : 1995 level 3, IEC1000-4-8 : 1993 level 4

\* E.U. indicates Engineering Units.

# 1. THE BASIC INSTALLATION PROCEDURE

Is given here as to the basic flow from the installation to operate the PYX. For detailed description of each step, see the pages correspondent. See the section “Operation Procedure” on the pages 33 to 36 for calls and changes the specific parameter.

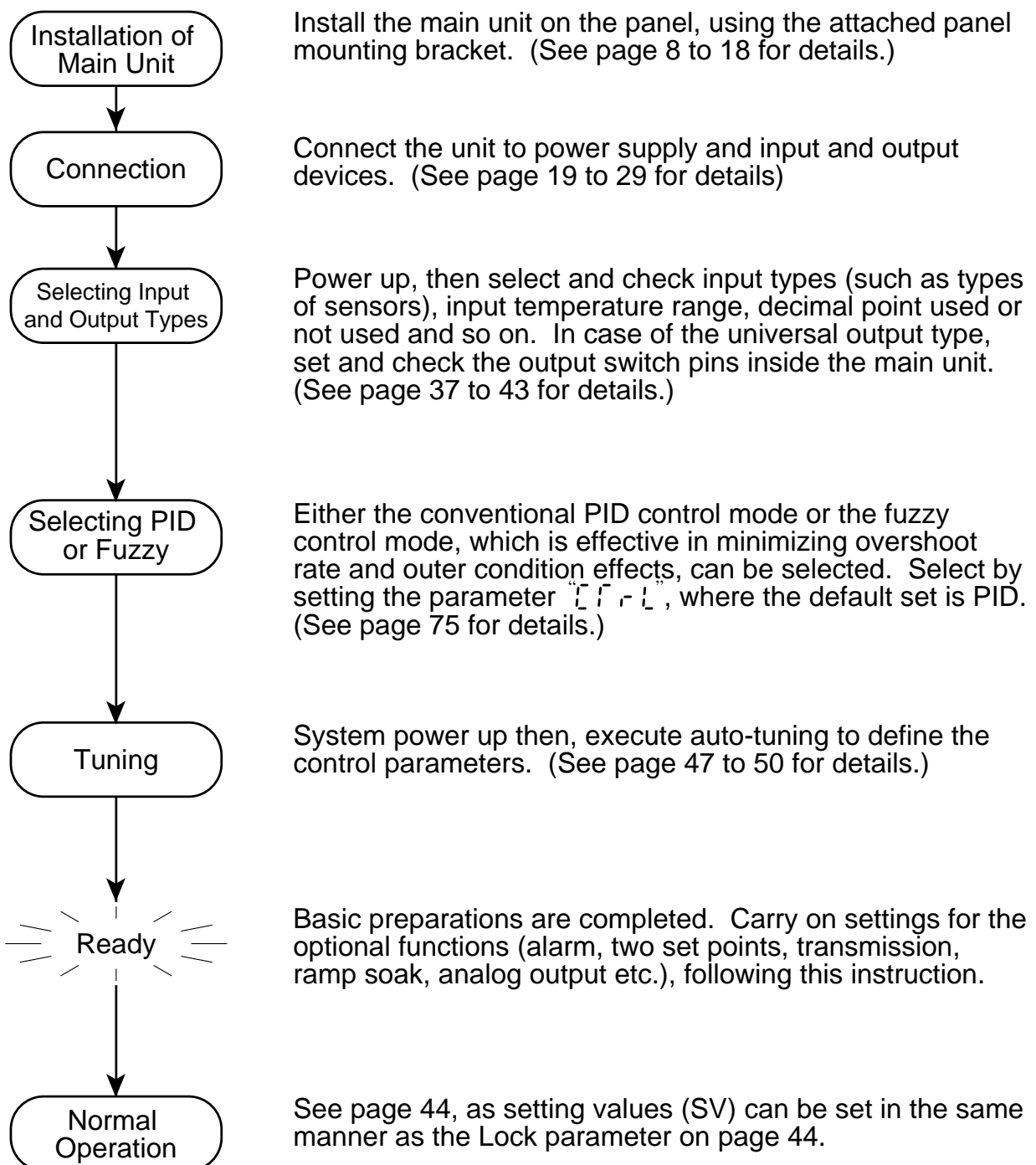

## 2. CHECK OF SPECIFICATIONS

Please make sure that specifications of this product is according with your request. The product specifications are provided on the main unit as model configuration following.

### 2.1 PYX4 MODEL CONFIGURATION

1	2	3	4	5	6	7	8	9	10	11	12	13	Contents
P	Y	X	4				1						
				T									Input type
				A									TC/PT input
				M									Voltage/Current input
													TC/PT/Voltage/Current multi input
					Y								Control output1
					A								Without
					B								Relay (SPST) rev. act.
					C								Relay (SPST) dir. act.
					D								SSR drive rev. act.
					E								SSR drive dir. act.
					F								Current (DC 4~20mA) rev. act.
					G								Current (DC 4~20mA) dir. act.
					H								Relay (SPDT) rev. act.
													Relay (SPDT) dir. act.
						Y							Control output2
						A							Without
						B							Relay (SPST) rev. act.
						C							Relay (SPST) dir. act.
						D							SSR drive rev. act.
													SSR dirve dir. act.
								0					Alarm function
								1					Without
								2					1pt.
								3					2pts.
								4					HB alarm
													HB alarm + 1pt.
								*					Input type code
													See Page 21.
									*				Input range code
													See Page 21.
										Y			Additional function
										P			Without
										Q			2 set points
										R			4 ramp soak with start/reset
										S			RS-485 transmission
										M			RS-485 transmission + 4 ramp soak
										N			RS-485 transmission
										A			RS-485 transmission + 4 ramp soak
										B			Auxiliary analog output
										C			Auxiliary analog output + 4 ramp soak
													Remote SV
													Front panel
										J			Japanese
										E			English (°C)
										F			English (°F)
										K			English (%)

Note 1: Fuji Electric CC data line protocol

Note 2: Modbus<sup>®</sup> RTU protocol

## 2.2 PYX5/9 MODEL CONFIGURATION

1	2	3	4	5	6	7	8	9	10	11	12	13	Contents
P	Y	X					1	-					
			5										Front panel dimensions: 48×96 mm 96×96 mm
			9										Input type TC/Pt input Voltage/Current input TC/Pt/Voltage/Current multi-input
				T									Control output 1 Without SSR/SSC drive rev. act. SSR/SSC drive dir. act. Current (DC4-20mA) rev. act. Current (DC4-20mA) dir. act. Relay rev. act. (SPDT) Relay dir. act. (SPDT) Universal output rev. act. Universal output dir. act.
				A									
				M									
					Y								
					C								
					D								
					E								
					F								
					G								
					H								
						Y							Control output 2 Without SSR drive rev. act. SSR drive dir. act. Current (DC4-20mA) rev. act. Current (DC4-20mA) dir. act. Relay rev. act. (SPDT) Relay rev. dir. (SPDT)
						C							
						D							
						E							
						F							
						G							
						H							
							0						Alarm function Without 1pt. 2pts. HB alarm HB alarm + 1pt.
							1						
							2						
							3						
							4						
								*					Input type code See Page 21.
									*				Input range code See Page 21.
										Y			Additional functions Without 2 set points 4 ramp soak with start/reset RS-485 transmission RS-485 transmission + 4 ramp soak } Note 1 RS-485 transmission RS-485 transmission + 4 ramp soak } Note 2 Auxiliary analog output Auxiliary analog output + 4 ramp soak Remote SV
										P			
										Q			
										R			
										S			
										M			
										N			
										A			
										B			
										C			
											J		Front panel Japanese
											E		English (°C)
											F		English (°F)
											K		English (%)

Note 1: Fuji Electric CC data line protocol

Note 2: Modbus<sup>®</sup> RTU protocol



### 3. ACCESSORIES

In addition to the main unit, the following accessories are shipping in the same package.

Accessories	Quat.
Instruction manual (this manual) (INP-TN1PYX-E)	1
Panel mounting bracket set	1
Current input resistance (250Ω) * Not delivered for TC/PT input type	1

\* Suffix means revision control

### 4. INSTALLATION

#### 4.1 INSTALLATION PLACE

Please verify if where the controller is mounted there is no:

- (1) splash of water,
- (2) mechanical vibration,
- (3) extreme temperature
- (4) no corrosive gases,
- (5) dust or oil smoke,
- (6) electric noise.

## 4.2 INSTALLATION PROCEDURE

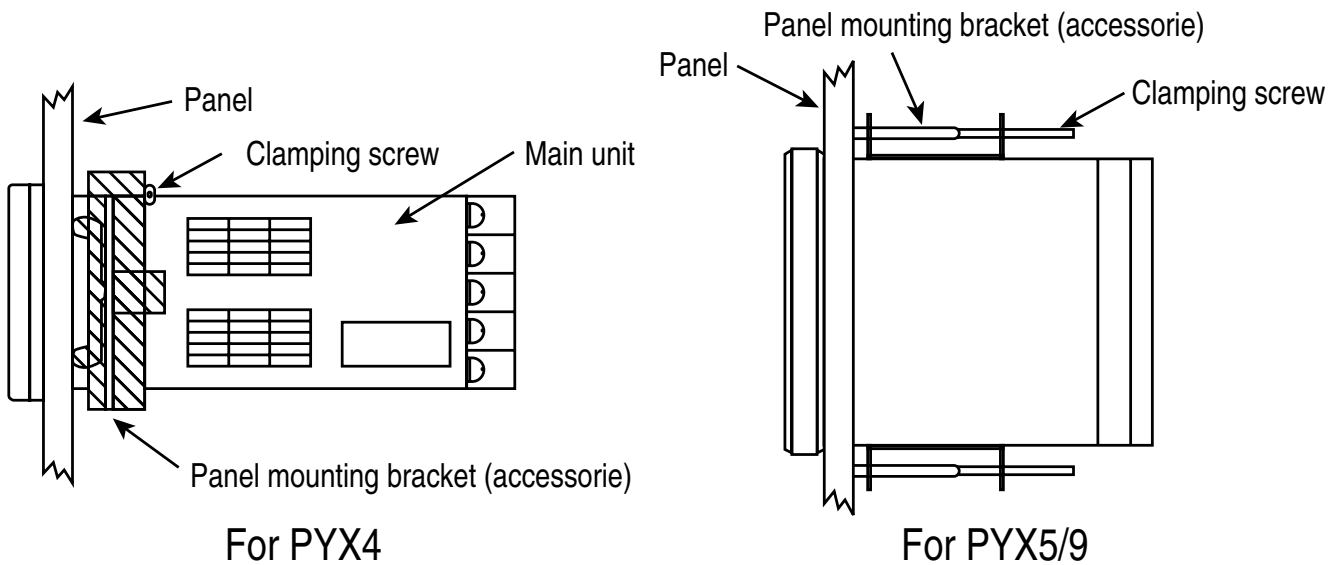



- For PYX4  
Slide the enclosed plastic panel mounting bracket (shipped with every PYX4) up the back of the controller until it makes contact with the back of the panel. Push the mounting bracket until the tabs seat themselves in the molded tab ridges, located on the front of the controller's outer case. Tighten the two screw on the mounting bracket for added pressure; do not use excessive force.
- For PYX5/9  
The mounting bracket's tabs fit into the two holes on both the top and bottom of the controller's outer case. With an instrument screwdriver, turn the screw in the mounting bracket until the end of it touches the back of the panel. Do this to both brackets. Making sure that the face of the controller is flush and straight, tighten both mounting bracket screws. Your controller should now be firmly set. If the controller is still loose, tighten the mounting bracket screw a little more. Do not use excessive force.

## 4.3 CAUTION ON SAFETY

**First of all, read this "Caution on Safety" carefully, and then use the instrument in the correct way.**

The cautionary descriptions listed here contain important information about safety, so they should always be observed. Those safety precautions are classified in 2 ranks, WARNING and CAUTION.

The following shows the meaning of WARNING and CAUTION.

 <b>WARNING</b>	Wrong handling may cause a dangerous situation, in which there is a possibility of death or heavy injury.
 <b>CAUTION</b>	Wrong handling may cause a dangerous situation, in which there is a possibility of injury or physical damage.

### 1. **WARNING**

#### 1.1 Caution on wiring

- 1) For the safe operation of the controller, where the temperature probe is to be installed into an environment where voltage exceed 50VDC, it is essential that reinforced isolation or basic isolation and earth the maintained between all connections to the rear of the temperature controller, and that supplementary isolation is required for the alarm outputs.

The outputs from the controller are all less than 50VDC.

When wiring the power supply terminal, use vinyl insulated 600 volt cable or equivalent. A switch breaking both poles of the mains supply should be installed together with a fuse with a rating of 250 volt 1 Amp. The fuse should be installed between the mains switch and the controller.

The level of insulation provided by the temperature controller is:-

MAIN = BASIC HEATER = BASIC INPUTS = BASIC
--

Prior to operation of the installed system the wiring should be checked to ensure that the required levels of insulation have been provided.

- 2) When a fault in the instrument is likely to lead to a serious trouble, use a suitable protective circuit on the outside for protection against trouble.
- 3) This unit is not provided with power switch, fuse, etc. These parts can be installed separately, if required (fuse rating; 250V, 1A).
- 4) Use of Fuji's Z-Trap is recommended to protect the relay output from switching surge and to ensure a long life.

Type:        ENC241D - 05A (power voltage; 100V)  
              ENC471D - 05A (power voltage; 200V)

Mounting position:    Connected to relay control output terminals

ex) PYZ4  
Socket (ATX2PSB)

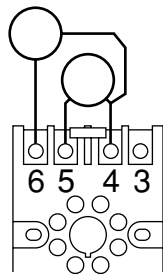

PYZ9

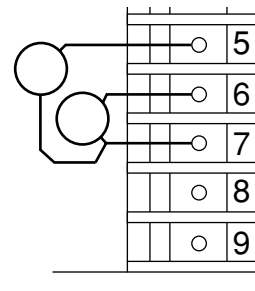

## 1.2 Operating condition

Operating temperature    : -10 to 50°C

Operating humidity        : 90%RH or less (non condensing)

Installation category     : II

Pollution degree         : 2

## 1.3 Power source

- 1) Use a power source of rated voltage to prevent damage or trouble.
- 2) Do not turn ON the power until the wiring is completed to prevent shock hazard or trouble.

## 1.4 Prohibition of use in gas

The instrument is not an intrinsic safety explosion - proof type. Do not use it in a place exposed to combustible or explosive gas.

## 1.5 Contact to unit

- 1) This unit must not be disassembled, modified or repaired to prevent malfunction, shock hazard or fire accident.
- 2) When the power is ON, do not touch the terminals to prevent shock hazard or malfunction.

## 1.6 Caution on maintenance

- 1) Before mounting or removing the module or unit, turn OFF the power in advance to prevent shock hazard, malfunction or trouble.
- 2) Periodical maintenance is recommended to ensure continuous and safe operation of the instrument. Some parts of the instrument are limited in life or are subject to secular change.



## WARNING

It is essential that, when the controller is introduced into a system which uses or generates a hazardous voltage, the minimum creepage and clearances specified in the table below are maintained on the temperature probe. A hazardous voltage is one that exceeds 42.4V peak AC or 60V DC. **If you have any doubt, seek advice from a competent engineer before installing the controller into the host equipment.**

The equipment must be installed such that with the exception of the connection to the mains, creepage and clearance distances shown in the table below are maintained between the temperature probe and any other assemblies which use or generate a voltage shown in the

table below. Failure to maintain these minimum distances would invalidate the EN61010 safety approval.

Clearance (mm)	Creepage (mm)	Voltage used or generated by the other assemblies
0.2	1.2	Up to 50V <sub>rms</sub> or V DC
0.2	1.4	Up to 100V <sub>rms</sub> or V DC
0.5	1.6	Up to 150V <sub>rms</sub> or V DC
1.5	3.0	Up to 300V <sub>rms</sub> or V DC
For a host or other assemblies fitted in the system, using or generating voltages greater than 300V(rms or DC), advice from a competent engineer must be obtained before installation of the relevant equipment.		Above 300V <sub>rms</sub> or V DC

It is essential that following the installation of the system, and prior to powering the system up that it is tested to determine that the correct level of isolation is present to protect the user and other equipment against the hazards of electric shock and fire.

An explanation of creepage and clearance is given in the following diagram.

## EXAMPLE INSTALLATION DIAGRAM TO MAINTAIN SAFETY OF CONTROLLER

Example of how to install Controller into an environment where hazardous voltages may exist is shown below.

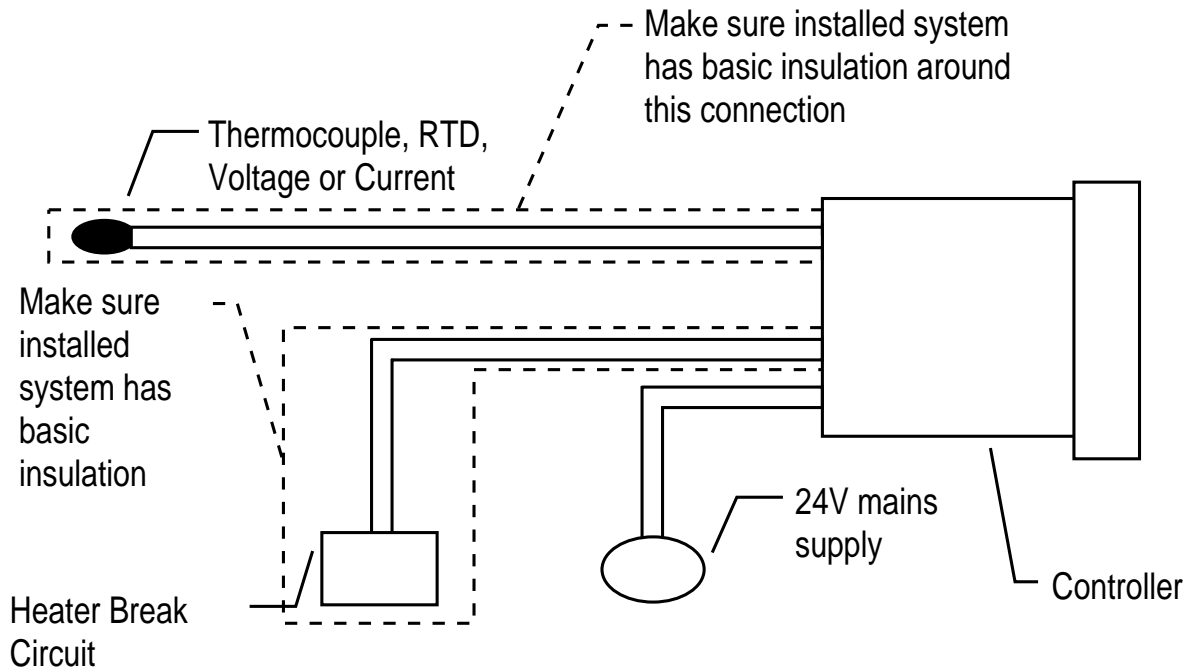

Example Diagram To Explain The Meaning Of Creepage and Clearance Distances Is Shown Below

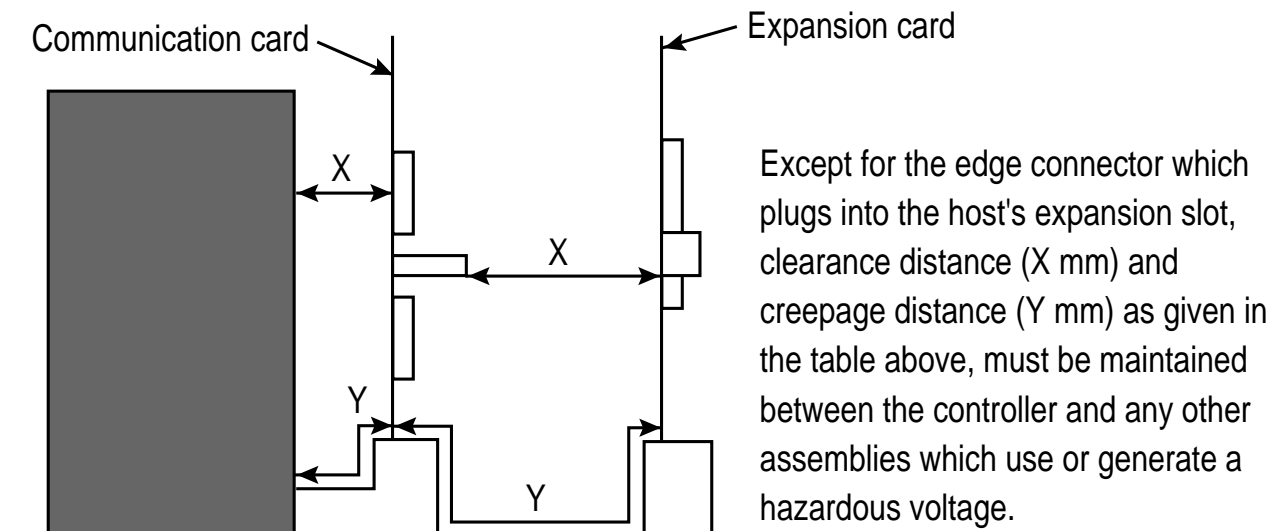

## 2. CAUTION

### 2.1 Caution on handling

- 1) Do not install the unit in any of the following places.
  - A place where the ambient temperature exceeds the range of -10 ~ 50°C
  - A place where the ambient humidity exceeds 90%RH
  - A place where temperature changes suddenly or dew condensation occurs
  - A place exposed to corrosive gases (sulfuric gas, ammonia, etc.) or combustible gases
  - A place where vibration or shock is likely to be directly transmitted to the body.
  - A place exposed to water, oil, chemicals, vapor, steam, etc.
  - A place with much dust, salt or iron component
  - A place with much inductive disturbance, static electricity, magnetism or noise
  - A place exposed to direct sunlight
  - A place where heat such as radiant heat stays

#### 2) Mounting

- PYX5/9

For mounting, attach the supplied mounting brackets (2 units) on top and bottom and tighten with a screwdriver. Tightening torque is about 147N.cm (1.5kg.cm). (The case is made of plastic. Care should be taken not to tighten forcedly)



- PYX4

Insert the supplied mounting frame from the rear side and push it in until the main unit is secured firmly to the panel. If it has a slight play, tighten the 2 screws until the play is eliminated. (If the screws are tightened forcedly, the mounting frame may be slipped off the stopper)

- 3) When the unit is exposed to water, it may lead to a short-circuit or fire hazard. Contact your dealer for inspection.

## 2.2 Caution on cable connection

- 1) For thermocouple input, use a suitable compensating cable.
- 2) For resistance bulb input, use a cable with a small lead wire resistance and without resistance difference between 3 wires.
- 3) When external wiring has much noise, use the following step. When a conducted as load of digital output such as relay contact output or alarm output, connect a surge absorber to the conductor coil. (Example: ENC471D-05A for 200V AC)
- 4) When the power source has much noise, use an insulating transformer together with a noise filter. Noise filter should be mounted on a panel which has been earthed. The wiring between the noise filter output and the instrument power terminals should be as short as possible. Do not connect a fuse or switch to the noise filter output wiring, as it affects the performance of the filter.
- 5) Use of a twisted cable for the instrument power source provides better effects (short twist pitch is effective for noise).
- 6) When a heater burnout alarm is provided, the heater power and controller power should be connected using the same power line.
- 7) Time for preparation of contact output is required at power ON. When the output signal is used for an external interlock circuit, etc., connect a delay relay to the circuit.

## 2.3 Other

When cleaning the instrument, do not use organic solvents such as alcohol, benzene, etc. Use neutral detergent.

### **3. Caution on key operation / trouble**

- (1) Alarm function should be set correctly. Otherwise, alarm output cannot be obtained at the time of occurrence of trouble. Be sure to check the function prior to operation.
- (2) Do not stop the device forcedly during auto - tuning, as it affects the control action. When it needs to stop forcedly, be sure to turn OFF the power in advance.
- (3) If the input cable is disconnected, the display shows UUUU or LLLL. When replacing the sensor, be sure to turn OFF the power.

## 4.4 PANEL CUT DIMENSIONS

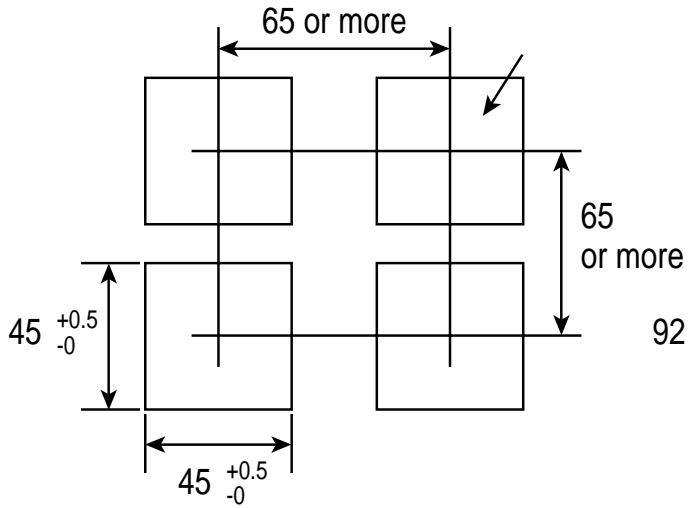

For PYX4

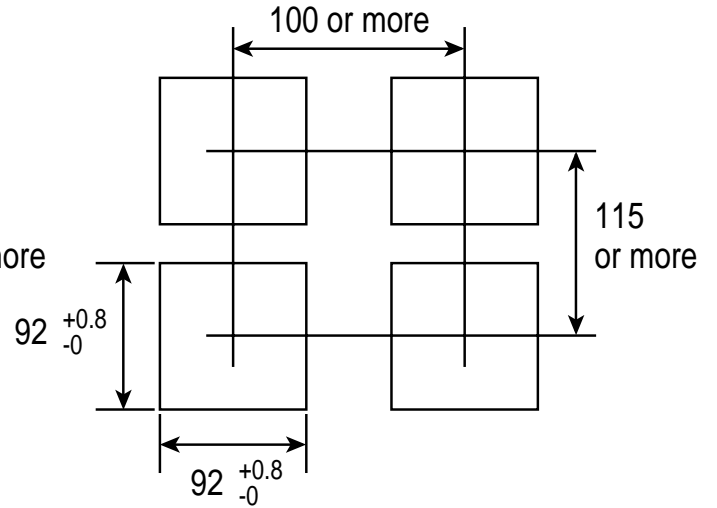

For PYX9

When mounting one unit

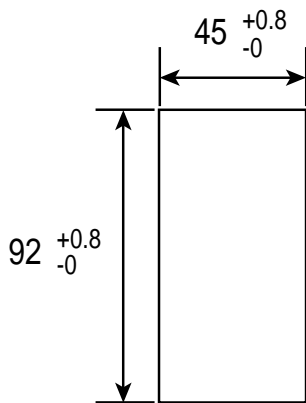

When mounting multiple n units ( $2 \leq n \leq 6$ )

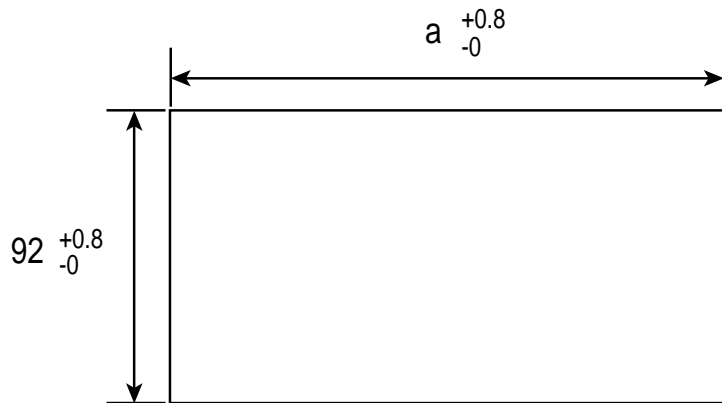

Units	2	3	4	5	6
a	93	141	189	237	285

For PYX5

Units (mm)

# 5. WIRING

## 5.1 PYX4 WIRING DIAGRAM

[When the output 1 is relay (SPST) output, SSR drive output or current output]

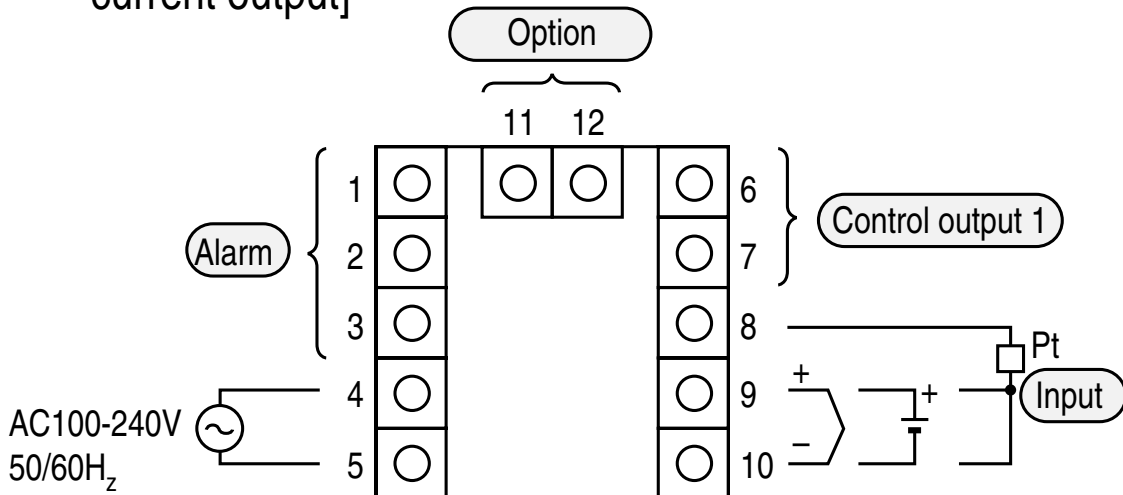

### Input

TC input

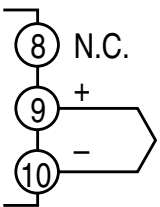

Pt input

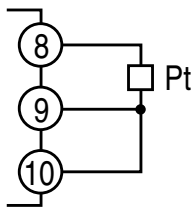

Voltage input

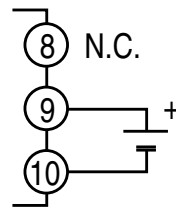

Current input

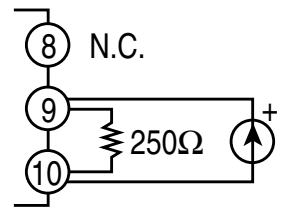

- NOTE:**
- For current input (4-20mA), use the accessory resistance (250Ω).
  - Make sure that the setting pin is in the appropriate position according to page 40.

## Control output 1

For relay output

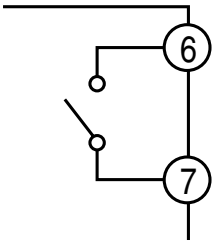

For SSR drive output

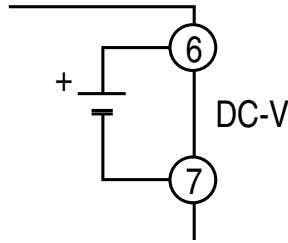

For current output

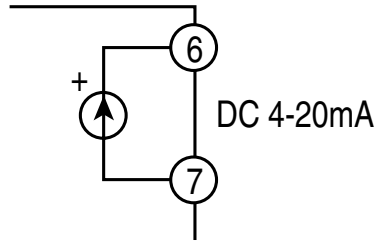

## Alarm

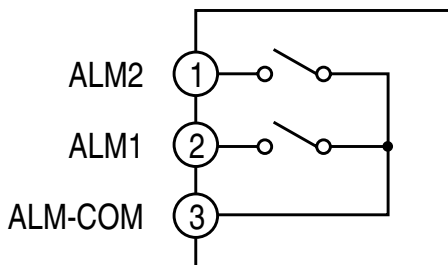

*NOTE: Only ALM 1 is available in the case of the digital output type.*

## Option

For control output 2 (relay output)

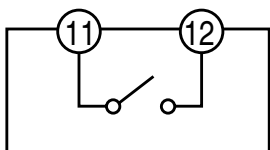

For control output 2 (SSR drive output)

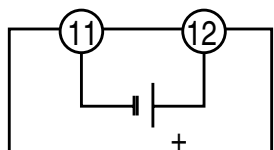

For digital input

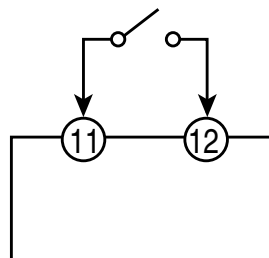

For AO output

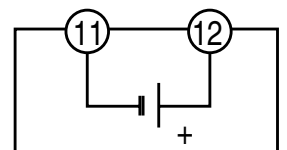

For current transformer input

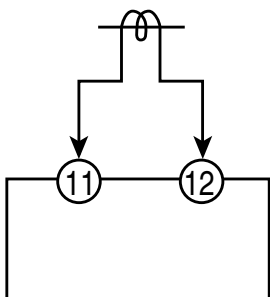

For RS485 transmission

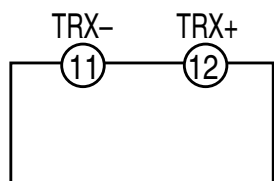

For remote SV input

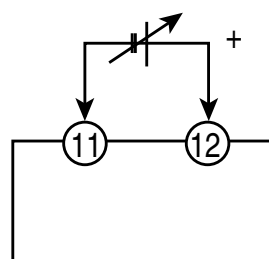

## 5.2 PYX4 WIRING DIAGRAM

[When the output 1 is relay (SPDT) output]

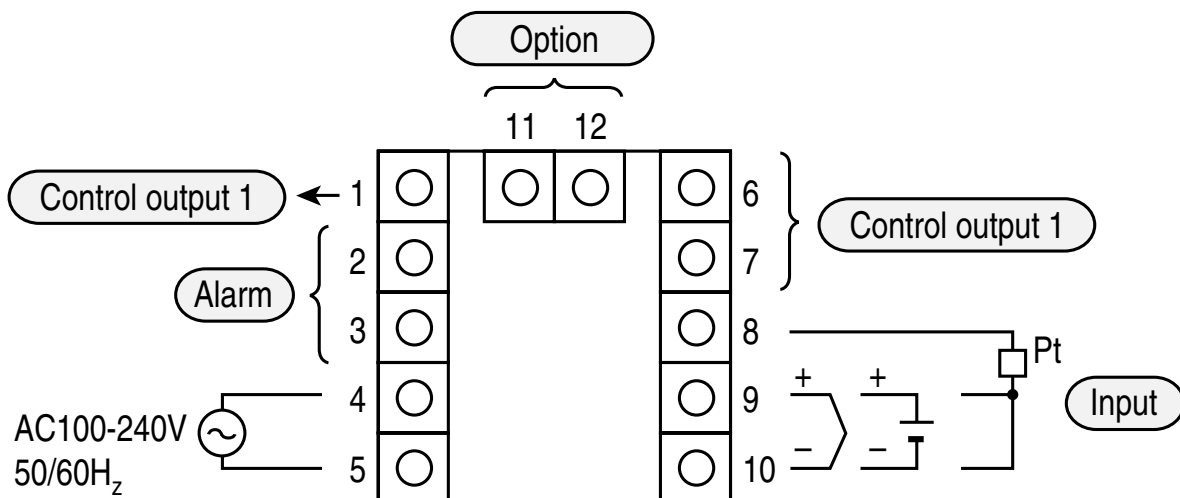

### Input

TC input

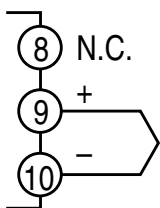

Pt input

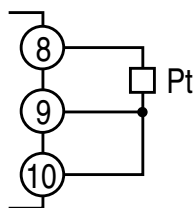

Voltage input

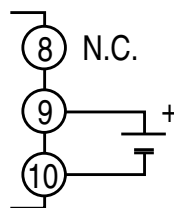

Current input

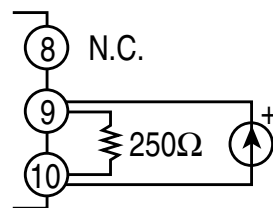

- NOTE:**
- For current input (4-20mA), use the accessorie resistance (250Ω).
  - Make sure that the setting pin is in the appropriate position according to page 40.

Control output 1

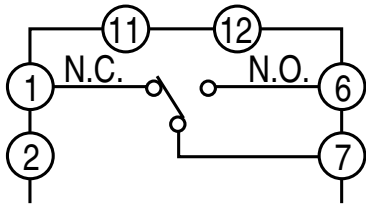

Alarm

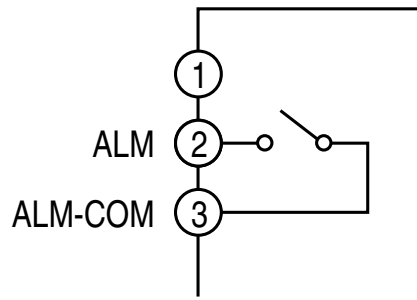

Option

For control output 2 (relay output)

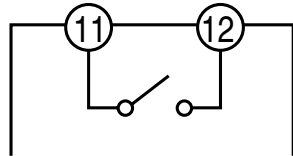

For control output 2 (SSR drive output)

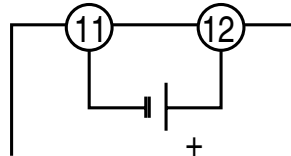

For digital input

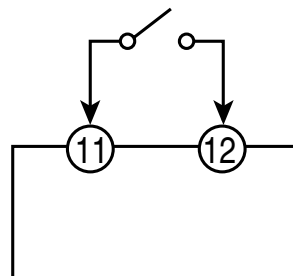

For AO output

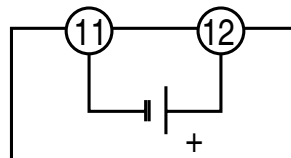

For current transformer input

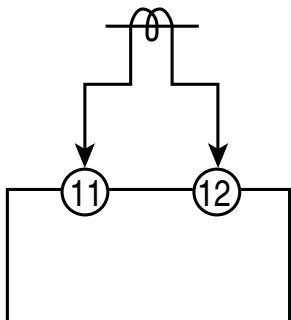

For RS485 transmission

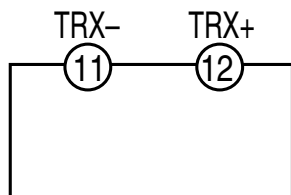

For remote SV input

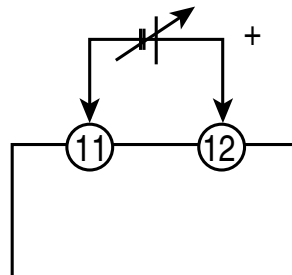

## 5.3 PYX5/9 WIRING DIAGRAM

(Not universal output)

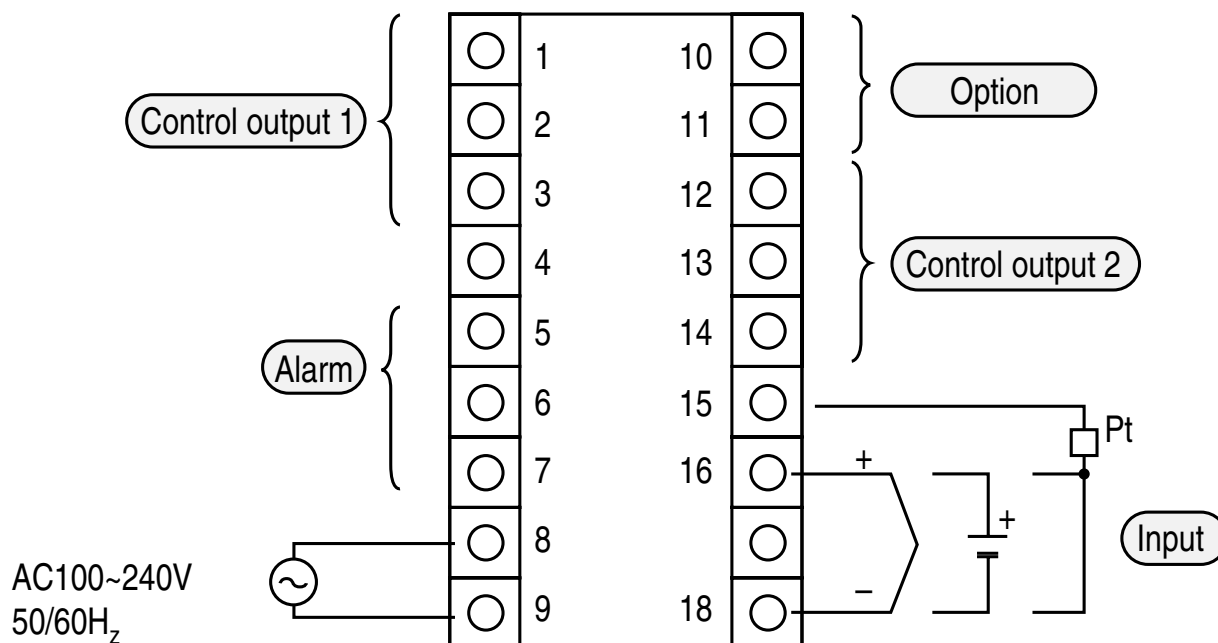

### Output

For TC input

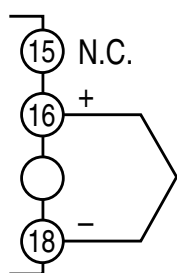

For Pt input

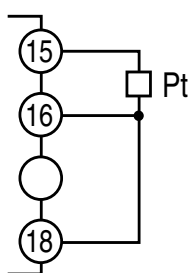

For voltage input

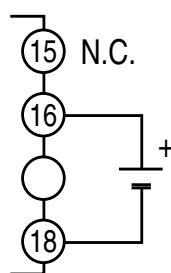

For current input

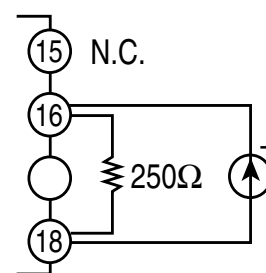

- NOTE:**
- For current input (4-20mA), use the accessory resistance (250Ω).
  - In the case of multi-input, make sure that the setting pin is in the appropriate position according to page 40.



## Control output 1

For relay output

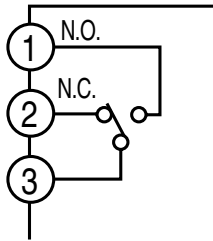

For SSR drive output

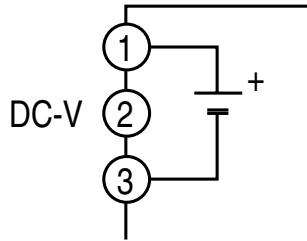

For current output

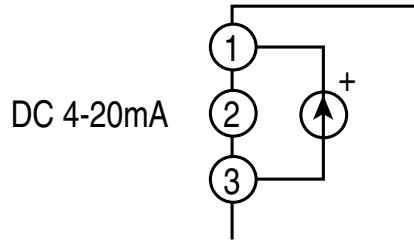

## Control output 2

For relay output

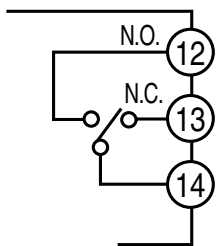

For SSR drive output

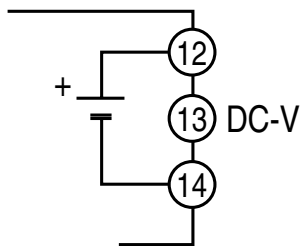

For current output

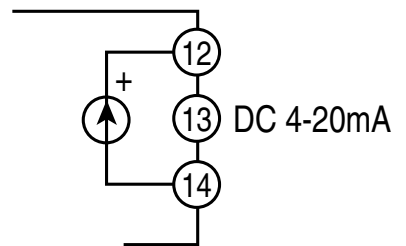

## Alarm

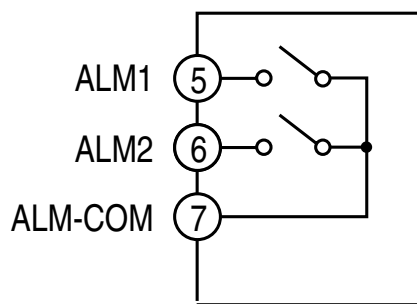

Option

For digital input

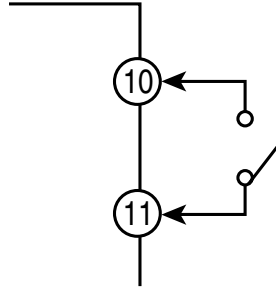

For AO output

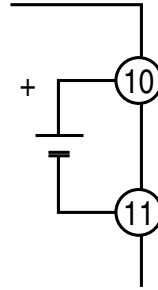

For current transformer input

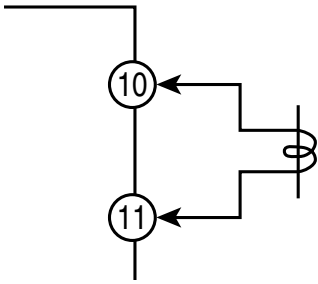

For RS485 transmission

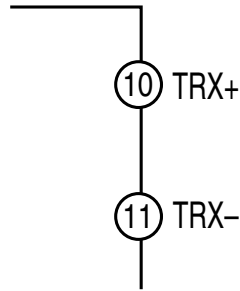

For remote SV input

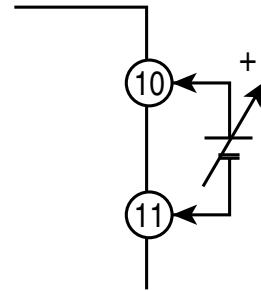

## 5.4 PYX5/9 WIRING DIAGRAM

(universal output)

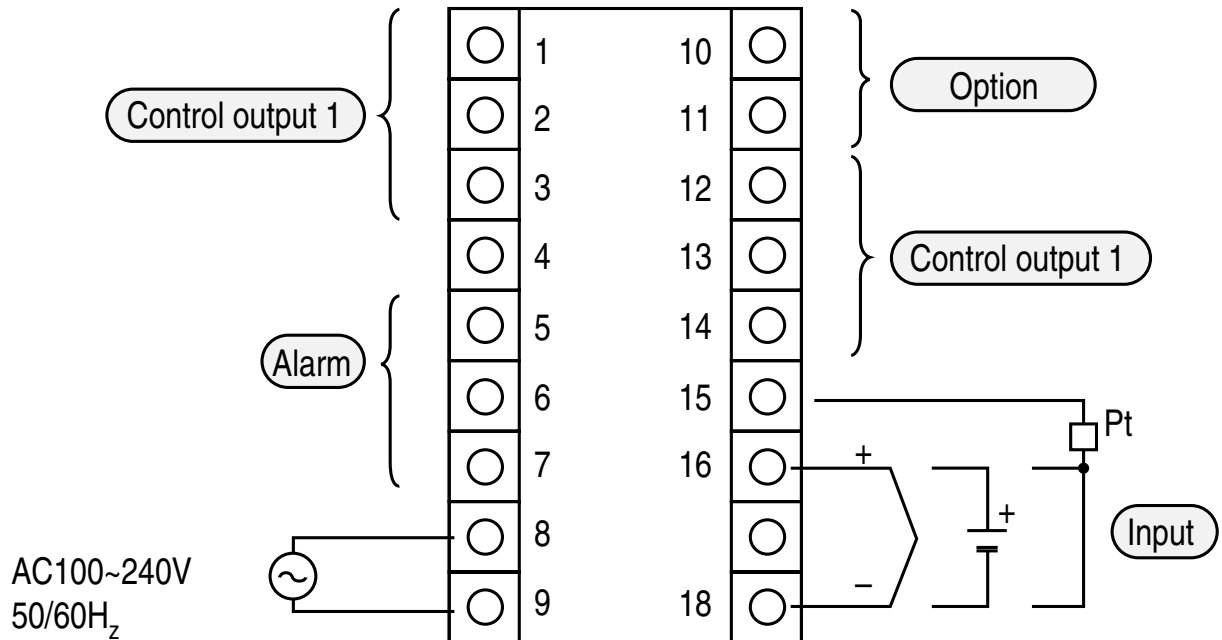

Input

For TC input

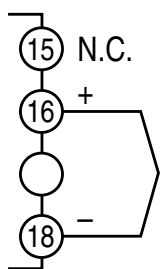

For Pt input

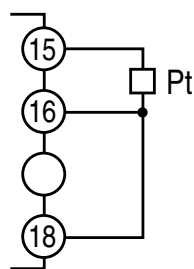

For voltage input

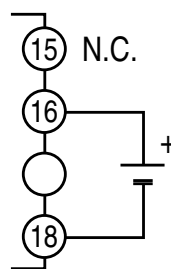

For current input

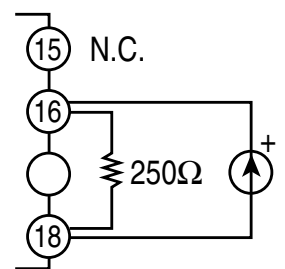

- NOTE:**
- For current input (4-20mA), use the accessorie resistance (250Ω).
  - In the case of multi-input, make sure that the setting pin is in the appropriate position according to page 40.

## Control output 1

For relay output

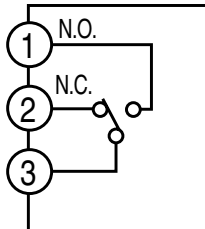

For SSR drive output

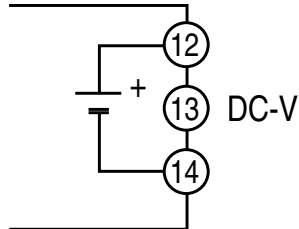

For current output

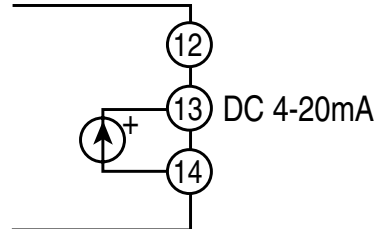

## Alarm

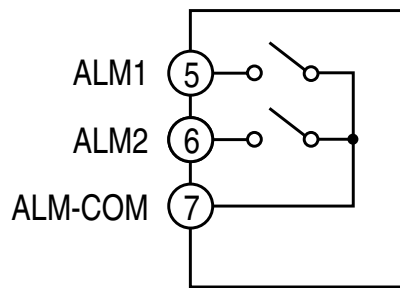

## Option

For digital input

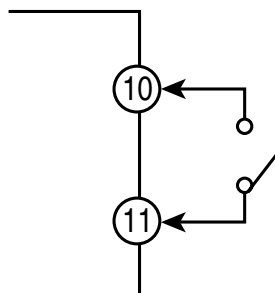

For AO output

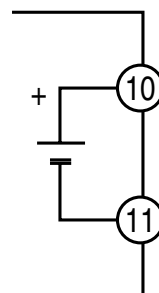

For current transformer input

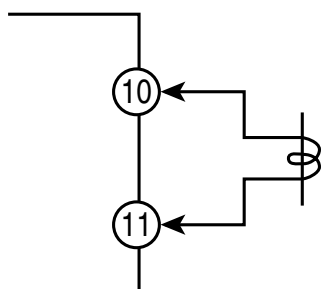

For RS485 transmission

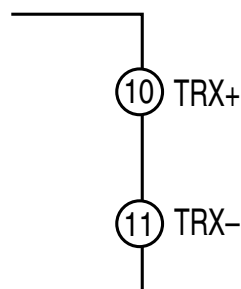

For remote SV input

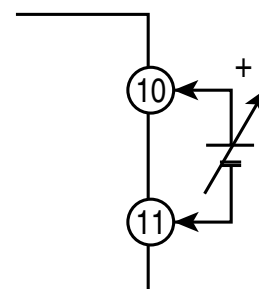

## 5.5 NOTES

Connection:

- No power switch and fuse are provided on this product. Install them separately if necessary.
- Use designated compensating wire in the case of thermocouple input.
- Use wire with line resistance lower than  $10\ \Omega$  for thermoresistance input.
- To avoid noise induction to input wires separate from the power and output wires also connected to your controller.
- In case of model equipped with heater break alarms, the power supply used should be the same for the PYX and Heater.
- Use shielded wires for input wires. Keep them away from output wires.

Noise:

Take the following measures when there is serious noise induction in the external wiring:

- When using a contactor as a load on digital output such as relay contact output and alarm output, supplement a surge absorber to the coil side of the contactor.  
Z-Trap (ENB461D-14A for AC220V) manufactured by Fuji Electric
- In the case of noise induction from the power supply, the use of an insulated transformer and a noise filter is recommended.  
Noise Filter (ZMB22R5-11) manufactured by TDK
- It is efficacious against noise induction to twist the power wires.

### Connection of Load Circuit:

- When the frequency of operation is rather high, in the case of proportional operation for instance, maximum load with respect to the capacity of the output relay will result in shorter life. Use an auxiliary relay in such a case. Type SSR is recommended.

electromagnetic switch: proportion cycle 20 sec. and above

SSR: proportion cycle 2 sec. and above  
(approximately)

contact output life: mechanical: 10 million times (no load)

electrical: 100 thousand times (nominal  
load)

- Relay contacts will be worn out with time. After certain period has passed, locking (a phenomenon in which a contact cannot be released once switched on) may happen. It is advisable to provide an external safety device to protect the system just in case locking happens.

# II. FRONT PANEL LAYOUT

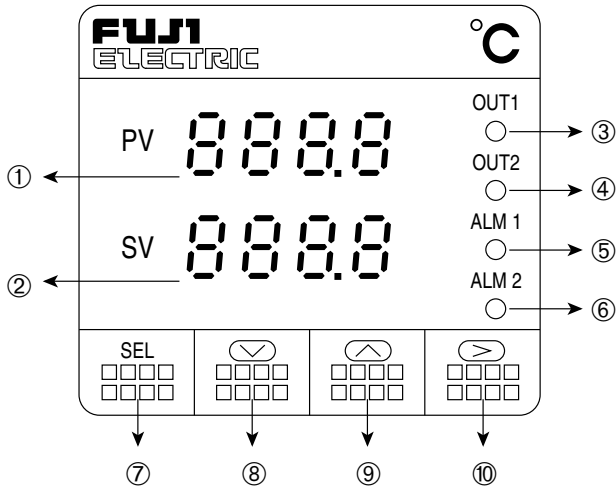

- ① PV value display
- ② Set point value display
- ③ Control output 1 monitor lamp
- ④ Control output 2 or remote operation monitor lamp
- ⑤ Alarm 1 lamp
- ⑥ Alarm 2 lamp
- ⑦ SELECT/Registration
- ⑧ DOWN key
- ⑨ UP key
- ⑩ CARRIAGE/Registration

PYX4

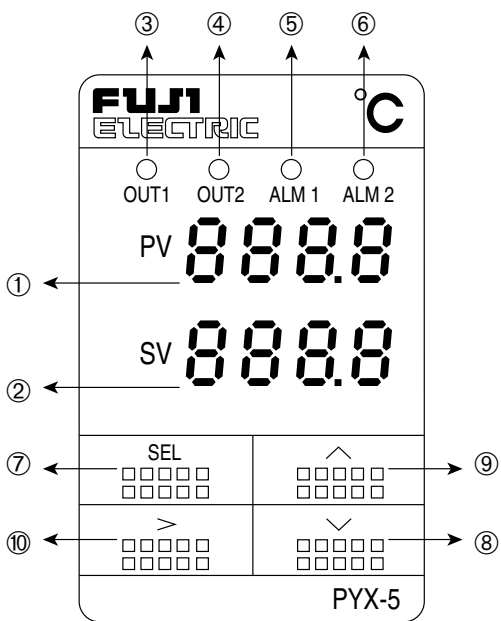

PYX5

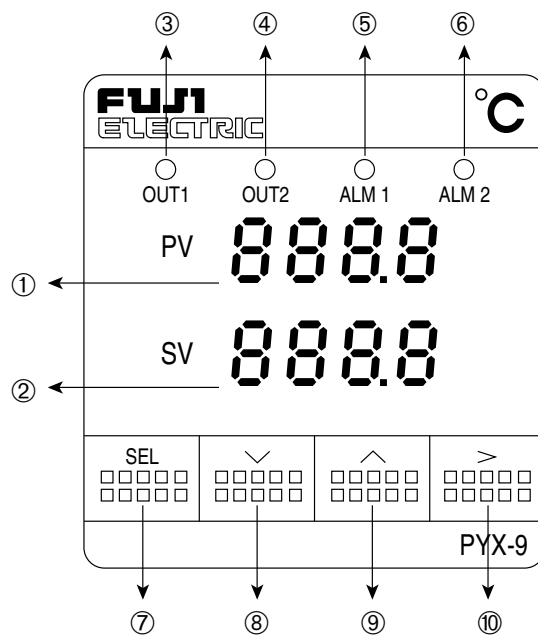

PYX9

① PV value display

PV 888.8

Displays the measured value, as well as the failure information. When more than one failure occurs simultaneously, the failure information of the highest priority alone will be displayed.

Display	Meaning	Priority
<i>F A L T</i>	Main unit failure	 High
<i>H b r t</i>	Heater disconnected	
<i>L P b r</i>	Control loop failure	
		Low

② Set point value display

SV 888.8

Displays the set point value.

(During auto-tuning or manual operation, the display of “*T U n E*” or “*T A n*” and set point value alternate.)

③ Control output-1 monitor lamp

Output 1(OUT1)



Lights when Output 1 is ON. (it does not light for the current output type.)

④ Control output 2 or remote operation monitor lamp



This lamp lights when Output 2 is ON or during remote operation. (it does not light for the single output type.)

Dual Control type

Output 2(OUT2)



Acts as the control output 2 monitor lamp.

Remote SV type

REM



Acts as the remote operation monitor lamp.



⑤ Alarm-1 monitor lamp

ALM 1



Lights when the alarm-1 relay operates

⑥ Alarm 2 monitor lamp

ALM 2



Lights when the alarm-2 relay operates

⑦ SELECT/Registration

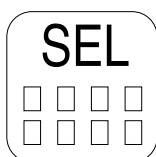

Used to switch from the operation mode to parameter setting mode, to select parameters, and to Registration set values.

Keeping pressing this key for about 3 sec switches between the operation mode and parameter setting mode.

⑧ DOWN key

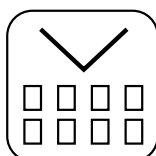

Used to select parameters and to decrease set values.

Continuing to press this key results in auto-repeat.

⑨ UP key

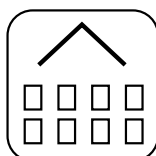

Used to select parameters and to increase set values.

Continuing to press this key results in auto-repeat.

⑩ CARRIAGE/Registration

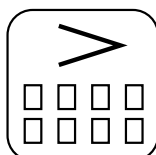

Used for preset value digit carrying or for preset value Registration.

### III. OPERATION PROCEDURE

---

#### 1. OPERATION MODE/PARAMETER SETTING MODE



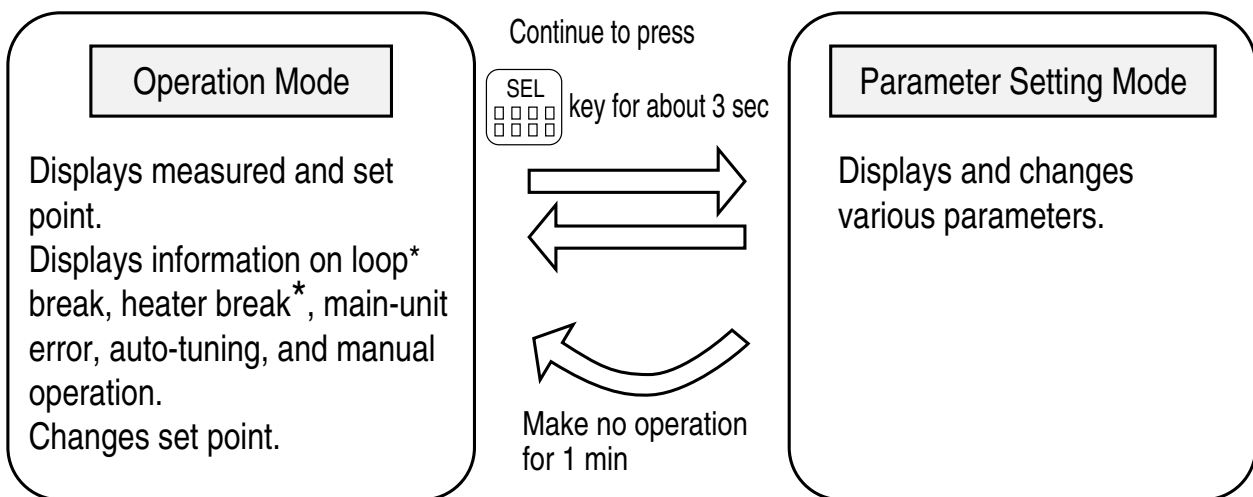

The operation of this device includes **the Operation Mode** where measured and set values are displayed and **the Parameter Setting Mode** where various parameters are set.

To switch between **the operation** and **parameter setting modes**, continue to press the  key for about 3 sec.



\* indicates an option.

#### 2. VIEWING PARAMETERS

1. Enter the parameter setting mode. (continue to press  key for about 3 sec)
2. Display the target parameter with the , , or  key.

*NOTES: No parameter is displayed if its parameter lock setting is illegal or if its corresponding option has been mounted in the system.*

Operation Mode

---

Parameter Setting Mode

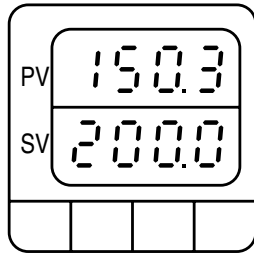

\* The numeric value shown in the left-hand figure is only an example.

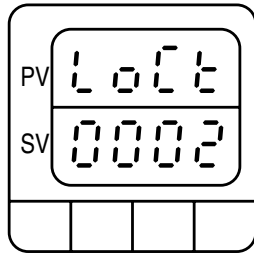
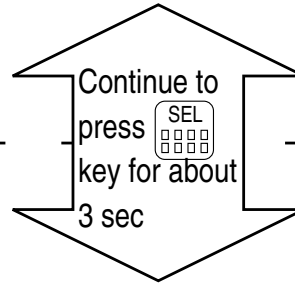

“LoCt”  
parameter

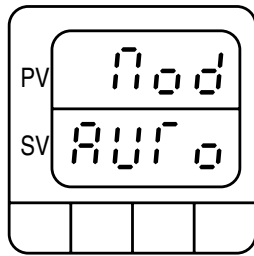
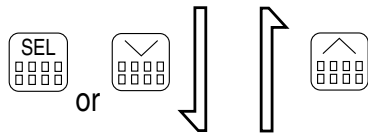



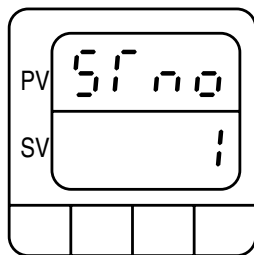
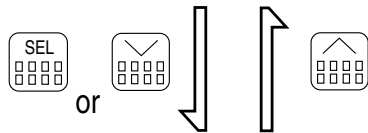
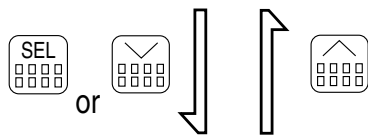

“Mod”  
parameter



“Sf no”  
parameter

\*Not displayed unless the transmission option is provided.

### 3. CHANGING PARAMETERS

1. Display the parameter to be set (to be changed) on the screen, as described in the Section 2. "Viewing Parameter" (page 33).
2. Select the digit to be set (to be changed ), with the  key (the selected digit flickers).
3. Set (to be changed ) the data with the  and  keys.
4. Press the  key, or repeat pressing the  key until it stops flickering (the set (changed) data is registered).

*NOTES: If no operation is made for about one minute during data setting (changing), control automatically returns to the operation mode. The data being changed (set) at this time is invalidated.*

## Example

<<Changing “Lock” from 1 to 2>>

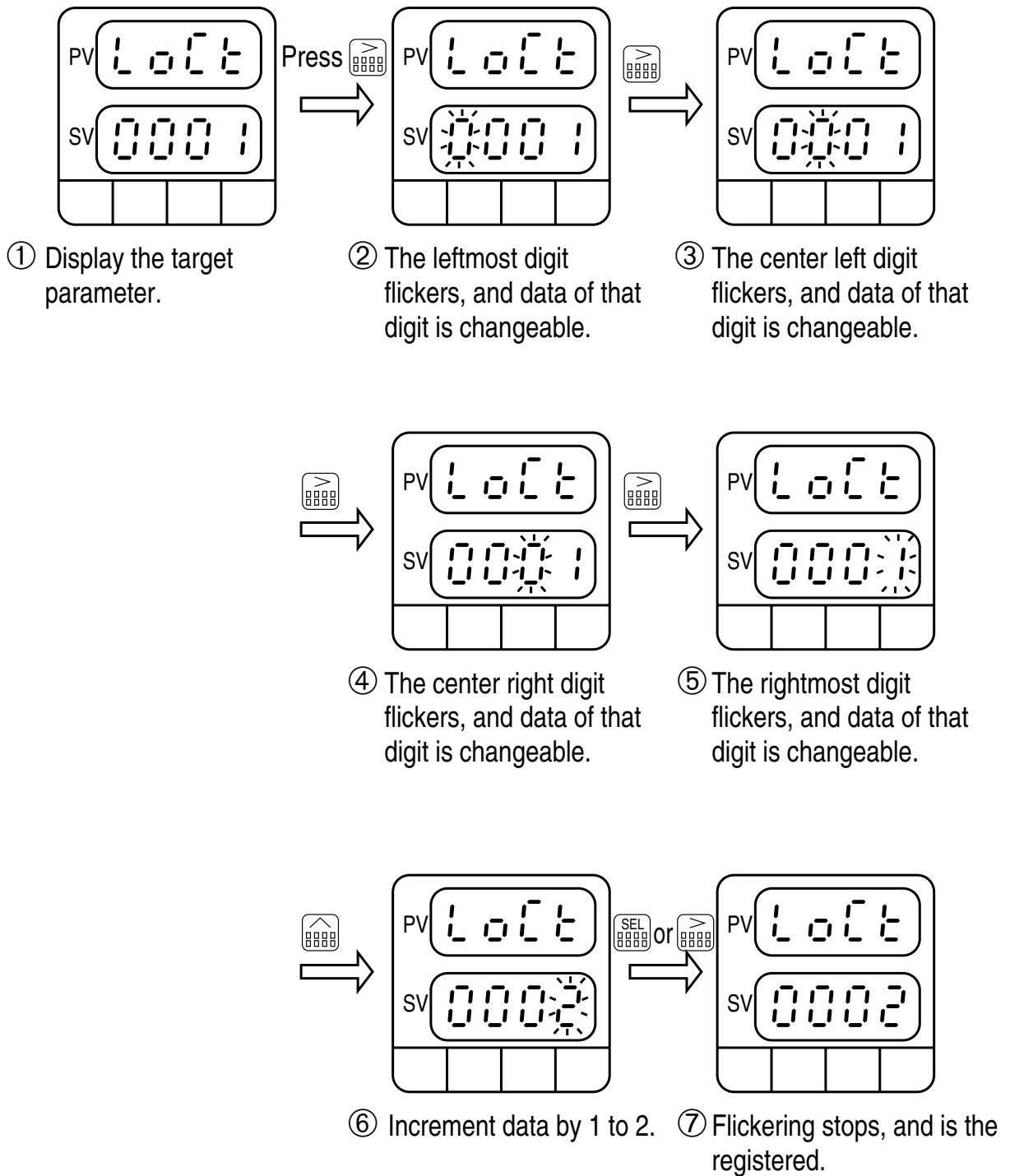

## IV. SETTING INPUT AND OUTPUT TYPES

After completing wiring, make sure that the measured value is of the right type before operating the device.

### Changing input

Parameter to be used

PuT

### Setting the Input type ( PuT )

It refers to setting the input type (range), presence or absence of decimal-point, and units of display ( $^{\circ}\text{C}/^{\circ}\text{F}$ ).

### Setting procedure

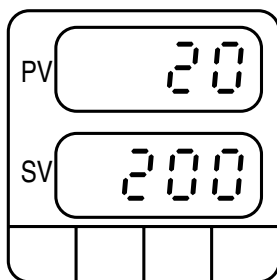

1. Turn the power of PYX (LEDs go on after a few sec).

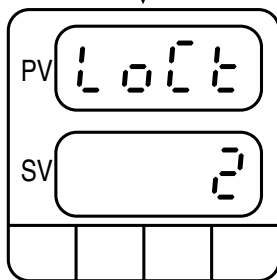

2. Continue to press the  key for about 3 sec (parameter LoLt is displayed).

At that time, if “3” is displayed steps 3 and 4 need not be executed.

3. Press the  key 4 times (the right most digit flickers).

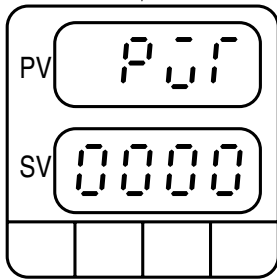
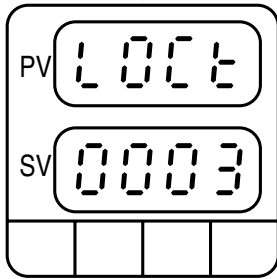
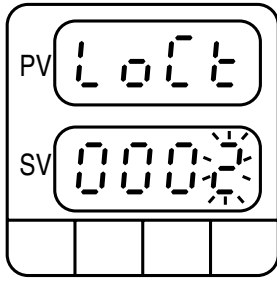

4. Change the lower display to “0003” with the and keys, and stop flickering and register the value with the and keys.

5. Repeat pressing the key until parameter “Pur” is displayed.

6. Set parameter “Pur” to the desired specifications following.

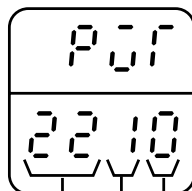

Example: Setting of K thermocouple for 0.0-400.0 °C range

Display unit	
0	°C display
1	°F display

Decimal-point display	
0	No decimal point
1	0.1°C/°F display

Input type code

## Input signal and measurement range

Input signal		Input type code	Measurement range (°C)	Measurement range (°F)	0.1°C display	0.1°F display
Thermo-resistance JIS	Pt100	00	0~150°C	32~302°F	○	○
	Pt100	01	0~300°C	32~572°F	○	○
	Pt100	02	0~500°C	32~932°F	○	○
	Pt100	03	0~600°C	32~1112°F	○	×
	Pt100	04	-50~100°C	-58~212°F	○	○
	Pt100	05	-100~200°C	-148~392°F	○	○
	Pt100	06	-150~600°C	-238~1112°F	○	×
	Pt100	07	-150~850°C	-238~1562°F	○	×
Thermo-resistance old JIS	JPt100	10	0~150°C	32~302°F	○	○
	JPt100	11	0~300°C	32~572°F	○	○
	JPt100	12	0~500°C	32~932°F	○	○
	JPt100	13	0~600°C	32~1112°F	○	×
	JPt100	14	-50~100°C	-58~212°F	○	○
	JPt100	15	-100~200°C	-148~392°F	○	○
	JPt100	16	-150~600°C	-238~1112°F	○	×
Thermo-couple	J	20	0~400°C	32~752°F	○	○
	J	21	0~800°C	32~1472°F	○	×
	K	22	0~400°C	32~752°F	○	○
	K	23	0~800°C	32~1472°F	○	×
	K	24	0~1200°C	32~2192°F	×	×
	R	25	0~1600°C	32~2912°F	×	×
	B	26	0~1800°C	32~3272°F	×	×
	T	27	-199.9~200°C	-328~392°F	○	×
	T	28	-150~400°C	-238~752°F	○	×
	E	29	0~800°C	32~1472°F	○	×
	E	2A	-199.9~800°C	-328~1472°F	○	×
	S	2B	0~1600°C	32~2912°F	×	×
	N	2C	0~1300°C	32~2372°F	×	×
	U	2D	-199.9~400°C	-328~752°F	○	×
	WRe5-26 PL-II	2E 2F	0~2300°C 0~1300°C	32~4172°F 32~2372°F	×	×
Power supply voltage	DC1-5V DC0-5V	40 41	-1999 to 9999 (Possible scaling range)	○: Enabled ×: Disabled		
Power supply current	DC4-20mA	40*				* For current input, mount the 250Ω resistance on input terminals, and apply the 1-5V voltage input.

NOTES: •The 0.1°C/F display is impossible for all over the 1000°C/F span.



**NOTES:** Make sure to switch the input selection SW referencing the following table when changing the type of input by changing the parameter "PUI".

Switching from Pt or TC input to voltage/current input	Re-position the input switch pin on "V" side.
Switching from voltage/current input to Pt/TC input	Re-position the input switch pin on Pt/TC side.
Other types of switching	Input pin re-positioning is not necessary.

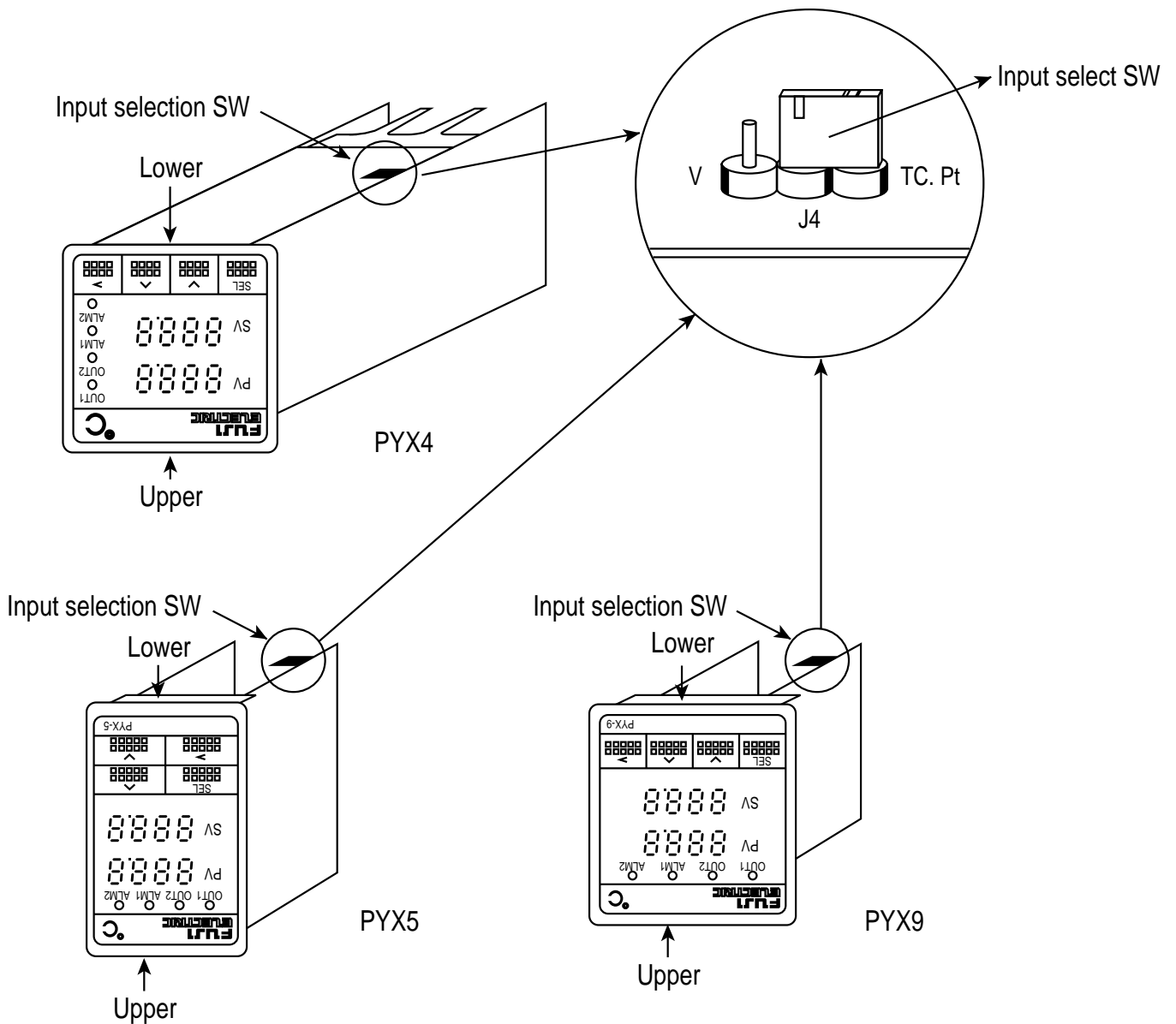

Parameter to be used

## Changing scale (voltage/current input)

$P_{UF}$  /  $P_{Ub}$  /  $P_{Ud}$

If it is used for voltage or current input, input scaling is possible.

### Input scaling

Engineering dimensions can be set to voltage or current input.

### Setting procedure

$P_{UF}$  (maximum value on scale): Engineering value equivalent to the 100% input is set (-1999 ~ 9999).

$P_{Ub}$

(minimum value on scale): Engineering value

$P_{Ud}$

equivalent to the 0% input is set (-1999 ~ 9999).

(decimal-point location): Decimal point location is set (see below). (0 ~ 2)

1.234

$P_{Ud}$
0
1
2

(No decimal point)

**NOTES:** When setting the scale, set it so that the difference between  $P_{UF}$  and  $P_{Ub}$  (span) does not exceed 9999. The following condition must always be satisfied when setting is made:  $P_{UF}$  is larger than  $P_{Ub}$ .

**Changing output (universal output)**

**none**

In case of the universal output type, the type of the control output 1 can be selected from the relay (SPDT) output, the SSR drive output and the current (4-20mA) output. Follow the table below when switching.

Desire type of control output 1	Switching
Relay (SPDT) output	Switch the pin "J2" in the figure below to the "RY" position.
SSR drive output	Switch the pin "J2" in the figure below to the "SSR" position.
Current (4-20mA) output	No switching required.

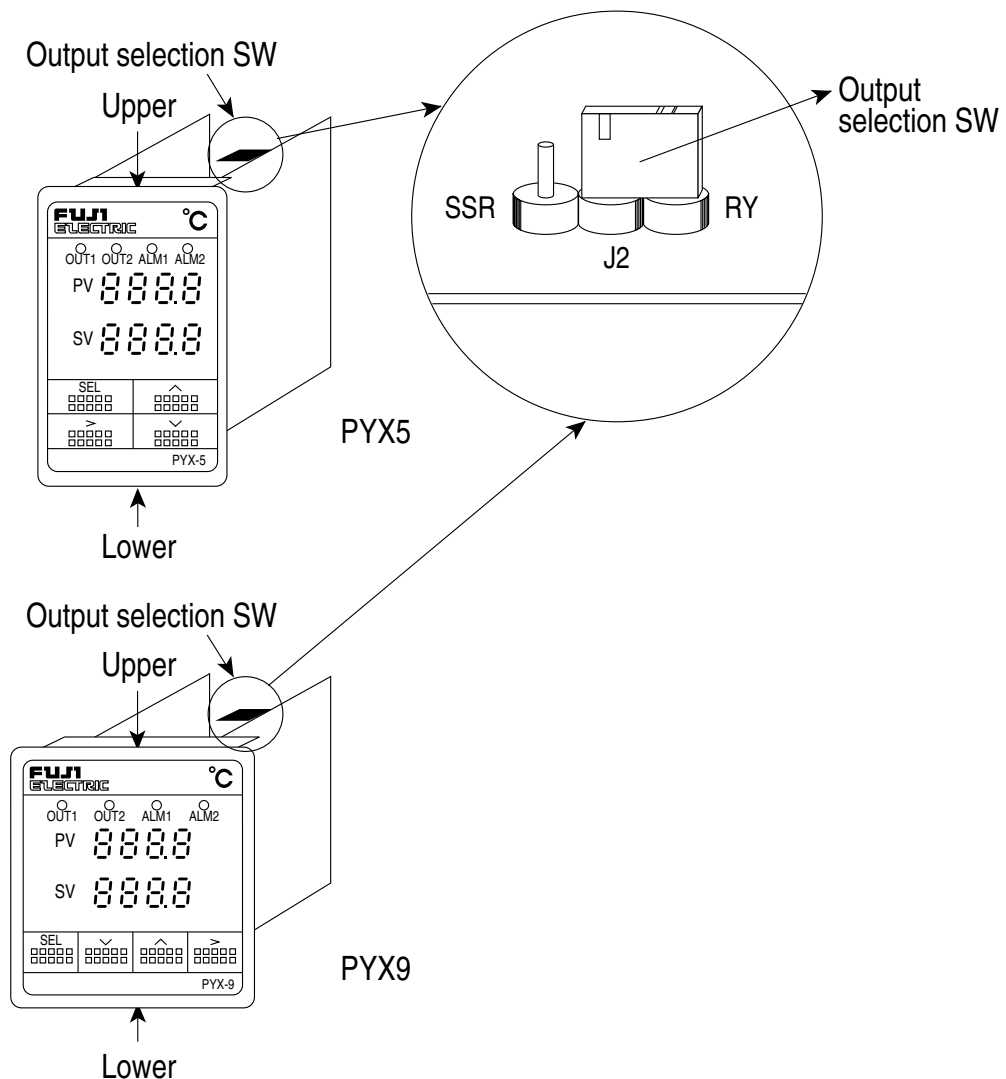

## NOTES:

1. *The output terminal for each output type is independent in the case of the universal output. Make sure that connections are properly made according to the page 27.*
2. *The current (4-20mA) output is made regardless of the position of the switching pin "J2" in the case of the universal output. However, only one type of output can be concurrently used among the relay output, the SSR drive output and the current output.*

# V. FUNCTIONS

Lock

Parameter to be used  
LoCt

The lock function is to suppress display of those parameters which are not used frequently in normal operations, and thereby to prevent parameter miss-settings.

There are four lock levels: 0 to 3. Parameters corresponding to each lock level are displayed. Setting the lock level to 0 disables changing of all parameters other than "LoCt".

<Parameters for each lock level>

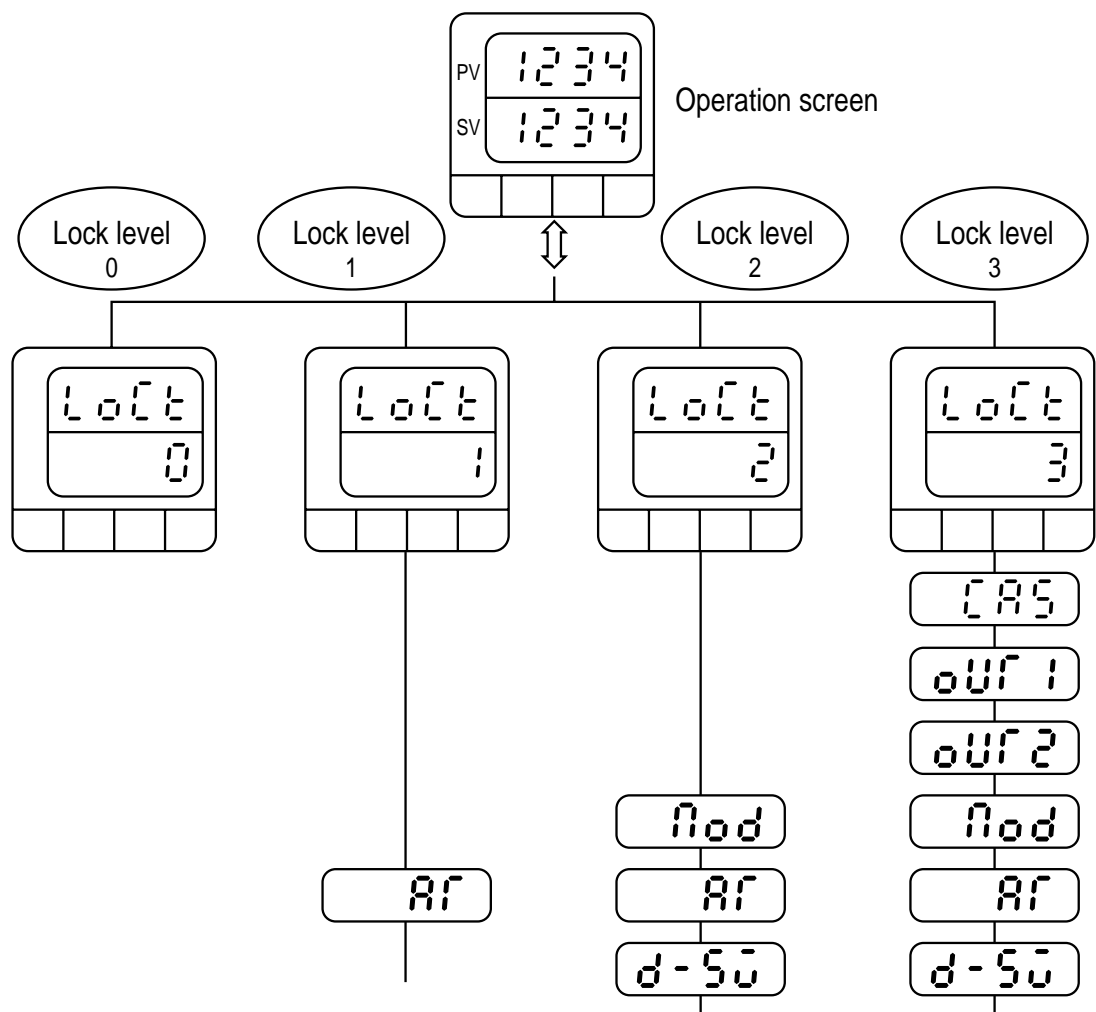

SRAF  
~  
rN45

SRAF  
~  
rN45

SRAF  
~  
rN45

P-on

P-on

P

P

hys

hys

i

i

d

d

Cool

Cool

db

Ar

NA<sub>n</sub>

AL IF  
~  
A23h

AL IF  
~  
A23h

Loop

Loop

hb-A

hb-A

CF

CF

P<sub>0</sub>F

P<sub>0</sub>F

P<sub>0</sub>b

P<sub>0</sub>d

FF

SFF

S<sub>0</sub>-h

S<sub>0</sub>-L

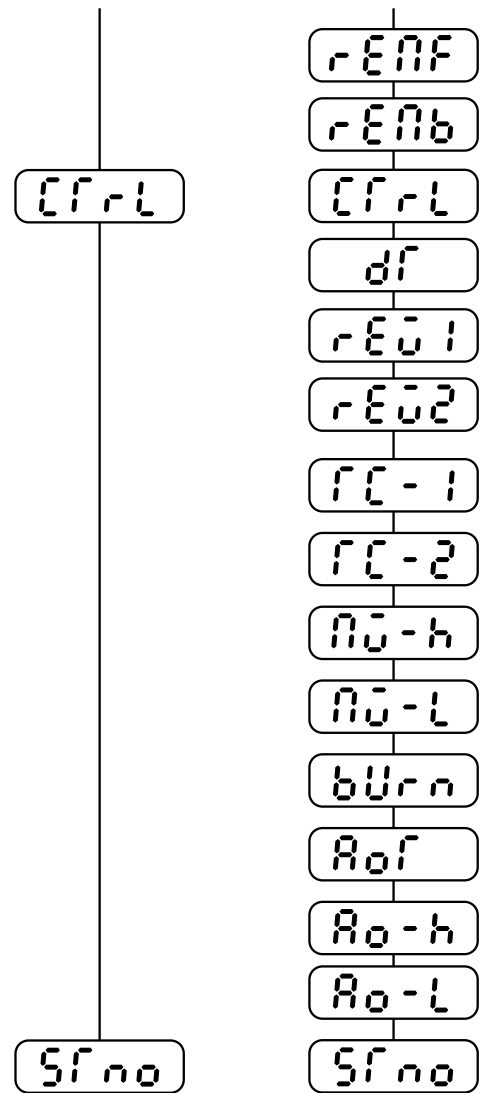

*NOTE: Some parameters may not be displayed, depending upon the option composition.*

Lock level	Use
0	(Setting of no parameter allowed) Use this level to lock all parameters.
1	(Setting of only set point allowed) Use this level when no parameter other than the set point is changed.
2	(Setting of normally set parameters allowed) Use this when normal parameters are set or changed.
3	(Setting of all parameters allowed) Use this when the set-up parameters are set or changed.

**Auto-tuning****AT**Autotuning function

This is the function implemented by the controller itself to automatically perform ON/OFF control, identify the process, and determine control constants (P, I, D, Cool, Ar).

Operating procedure**AT** (Autotuning Command)

Setting	Operation
<b>OFF</b>	Provides normal control.
<b>ON</b> (Standard type)	Perform auto-tuning while targeting the present [set point value (SV)].
<b>LO</b> (Low PV type)	Performs auto-tuning while targeting the present [set point value (SV) - 10%FS].

(Autotuning command) Setting “**ON**” or “**LO**” in the autotuning command starts autotuning (during autotuning, “**TUNE**” and the set value alternate in display on the run screen). Autotuning terminates automatically.

Supplementary descriptions

1. There are two types of auto-tuning (AT): ① Standard type (including over-shoot) and ② Low PV type (suppressing overshoot).

Type ① is the system in which the measured value (PV) exceeds the set point value (SV) (overshoot) during autotuning. Use this type where overshoot is permitted.

Type ② is the system in which ON-OFF control is provided by centering upon the value 10% (/full-scale) lower than the set point value (SV). Use this type where overshoot is to be suppressed.



For single output

① Standard type (including overshoot)

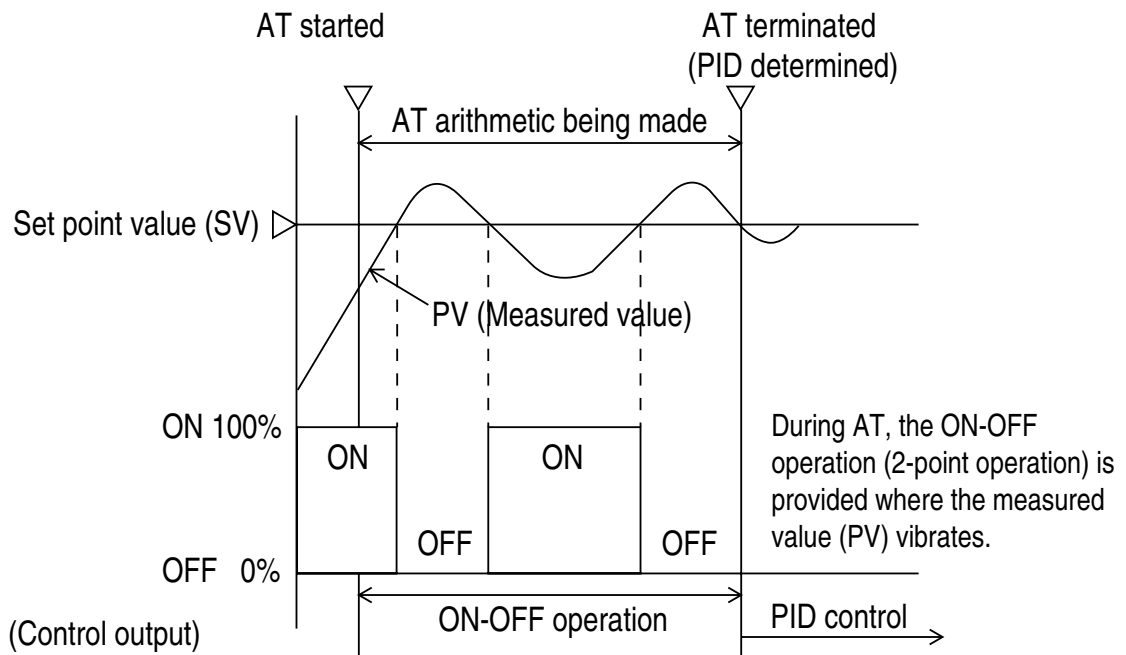

② Low PV type (suppressing overshoot)

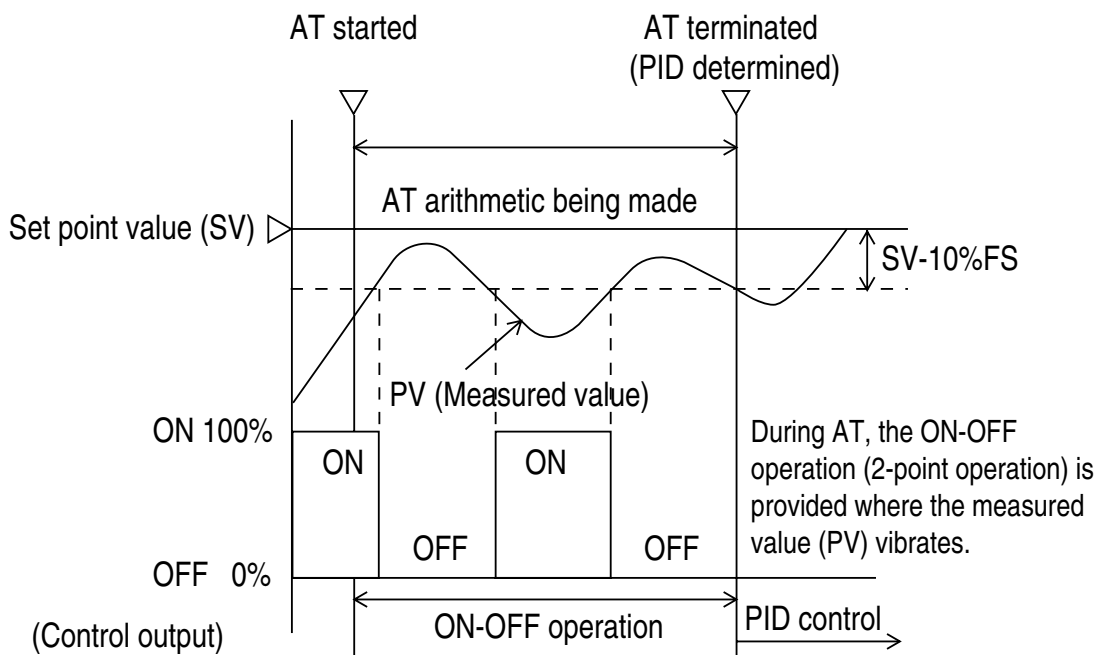

## For dual output

### ① Standard type (including overshoot)

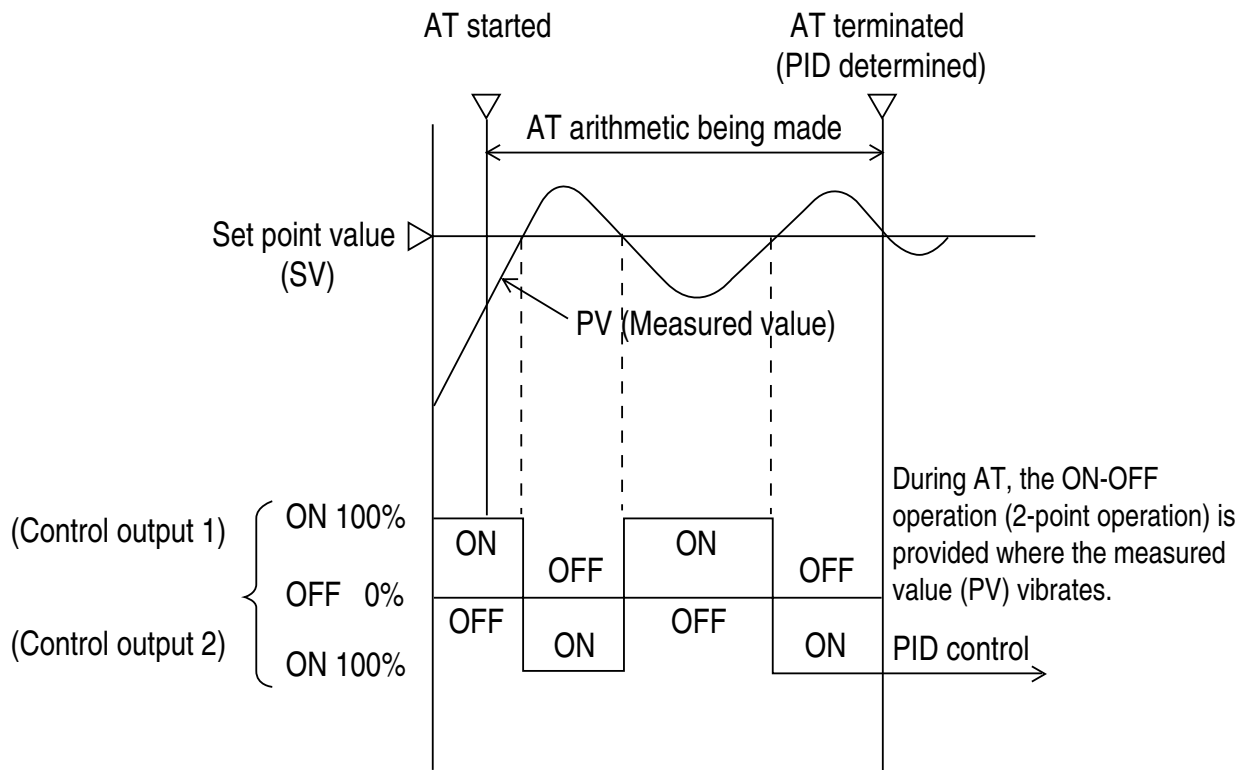

### ② Low PV type (suppressing overshoot)

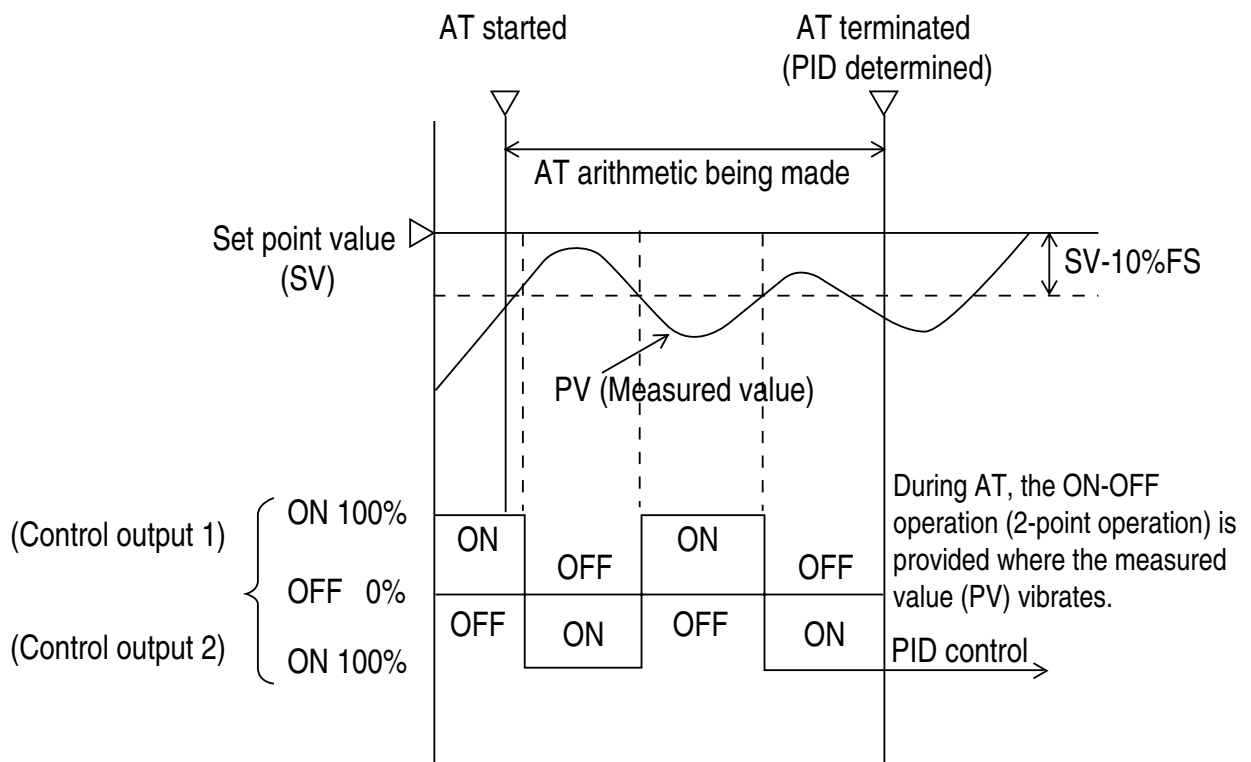

## NOTES

1. *Avoid applying the auto-tuning to the following processes.*
  - (a) *The process must not be disturbed due to temporary ON-OFF control output from PYX.*
  - (b) *Process featuring very quick response such as pressure/flow rate process.*
  - (c) *Process where overshoot must not be generated*
2. *Auto-tuning cannot be executed under the following conditions. If the auto-tuning is already being executed, stop it.*
  - (a) *Manual operation*
  - (b) *Measured value (PV) error occurring*
  - (c) *When the set value (SV) has changed by more than 0.5%FS per 0.5 second during auto-tuning*
  - (d) *Auto-tuning not terminated within 12 hours*
3. *Do not execute auto-tuning when the ramp soak function is being used (i.e. when the parameter “P r o t” is not “o f f”), since it may result in incorrect tuning.*
4. *When the operation condition is changed, restart the auto-tuning*
5. *When the auto-tuning terminates abnormally, the PID value takes the value prior to auto-tuning, in such cases as abnormal termination of auto-tuning. The same applies when the auto-tuning command is switched to “o f f” during auto-tuning.*

## Control function

P / I / d / A r / n a n  
/ h y s / C o o l / d b

1. Normal PID control

P

(Proportional band)

Set the proportional band using the ratio (%) with respect to the input full scale (0.0-999.9%).

Setting P to 0.0 provides the 2-point (ON-OFF) control. The 2-point control is not available in the fuzzy control mode. This parameter is automatically set with auto-tuning.

I

(Integral time)

Set the integral time in sec units (0-3200 sec).

Setting I to 0 provides no integral operation. This parameter is automatically set with auto-tuning.

d

(Derivative time)

Set the derivative time in 0.1-sec units (0.0-999.9 sec).

Setting d to 0.0 provides no derivative operation. This parameter is automatically set with auto-tuning.

Ar

(Anti-reset wind up)

When control operation involves integral operation, the initial over-integral causes overshoot to occur. Overshoot is prevented by limiting the integral range. Set setting value (SV) high and low limits with engineering units. (0~100%FS E.U.)

This parameter is automatically set by executing auto-tuning.

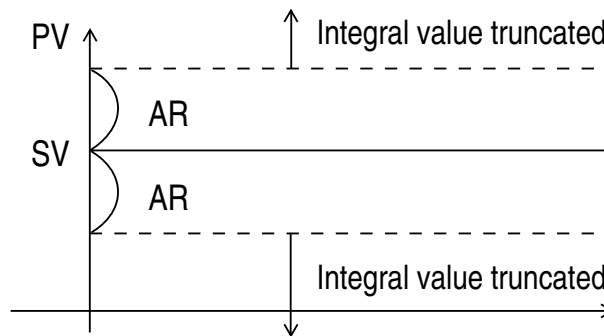

Man

(Manual resetting value)

When control includes only the P operation, it generates offset. To eliminate this, add the manual resetting value to the manipulated value (MV). (-100.0~100.0%)

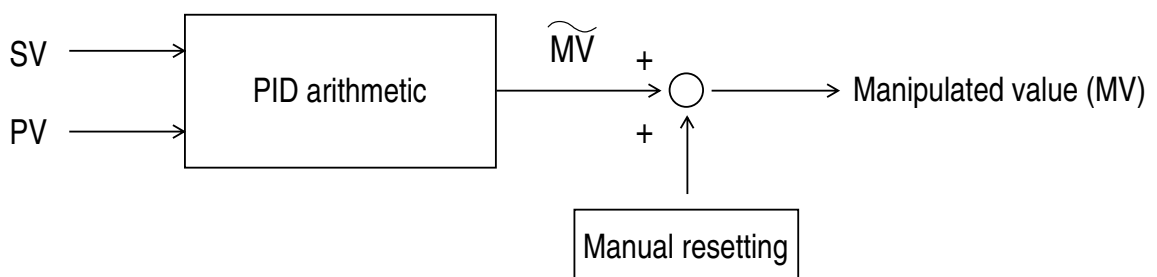

## 2. 2-POINT (ON-OFF) CONTROL

When PID control is specified as the control type, setting P to 0.0 provides the 2-point (ON-OFF) control operation.

**HYS** (2-point operation hysteresis)

Set the 2-point operation hysteresis with engineering values. (0~100% FS D.E.U.)

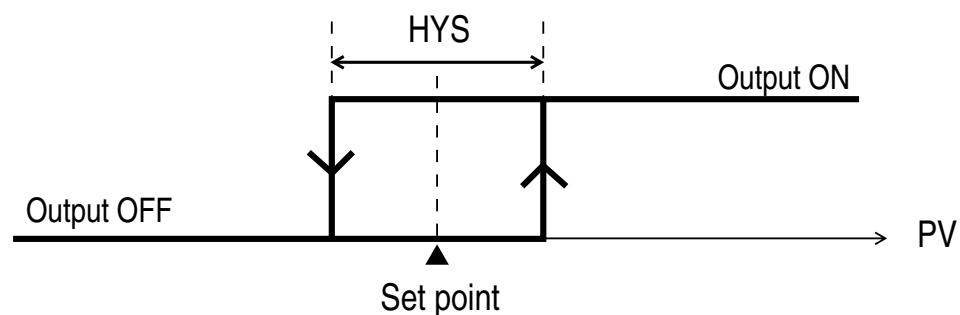

## 3. FUZZY CONTROL

Employing Fuzzy Logic control eliminates system overshoot and effectively suppresses fluctuation of the process variable due to external disturbances. See the section describing control type setting (page75).

### NOTES

1. *The dual output type does not allow use of fuzzy control.*
2. *Though the fuzzy control also requires setting of parameters P, I, and D, these values can be set to those being used in PID control. Auto tuning is also available.*

## 4. DUAL CONTROL

\* This function is an option.

If the process heats itself, cooling control is needed in addition to heating control. The dual control is used for control of that process.

COOL

(Cooling-side proportional band coefficient)

Set the cooling-side proportion band coefficient (0.1~10.0). This parameter is automatically set with auto-tuning.

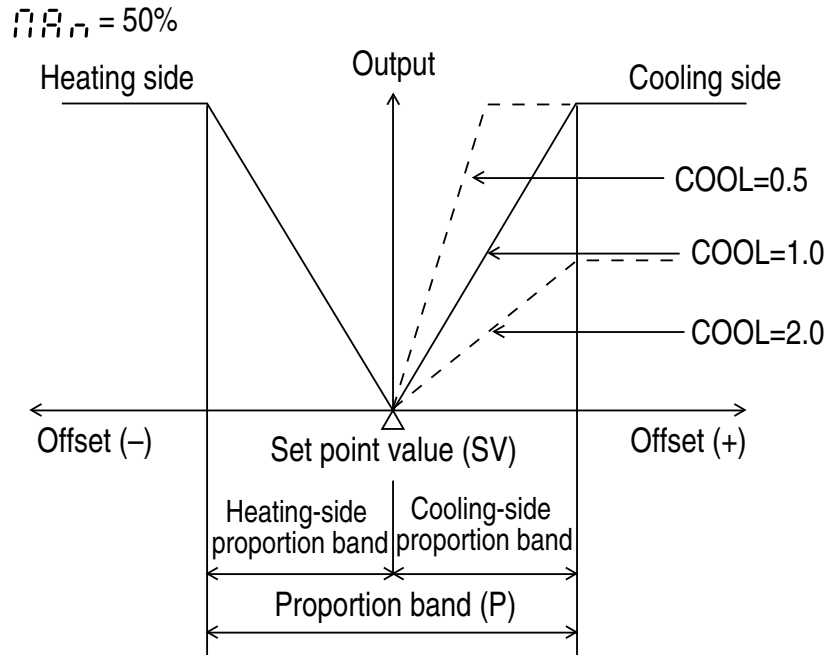

db

(Dead/overlap band)

Used to separate (dead) and overlap the heating and cooling side output as shown in the figure below (-50 ~ +50%)

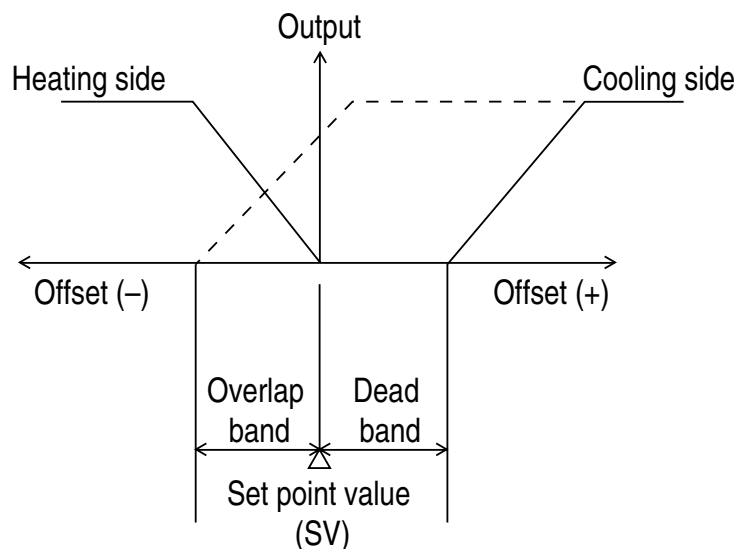

Parameter to be used

## Alarm

\* This function is an option.

AL 1F/AL 2F  
 AL 11/AL 12/AL 13/AL 21/AL 22/AL 23  
 A 11h/A 12h/A 13h/A 21h/A 22h/A 23h  
 Loop/hb - A/C F

This device provides the multi-alarm function (option) that allows simultaneous detection of a maximum of 4 types of alarming.

### Multi-alarming

It allows a maximum of 4 types of alarm settings (among which, one is dedicated to loop/heater disconnection), detects those types of alarm individually, and makes logical OR before outputting it to the alarm relay.

(Multi-alarm)

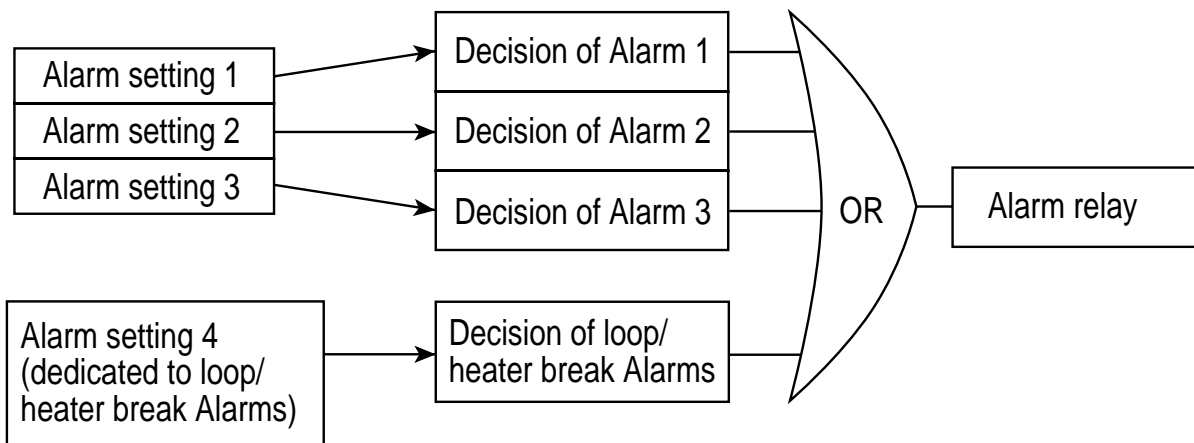

### Operation procedure

AL 1F (Alarm-1 type)

AL 2F (Alarm-2 type)

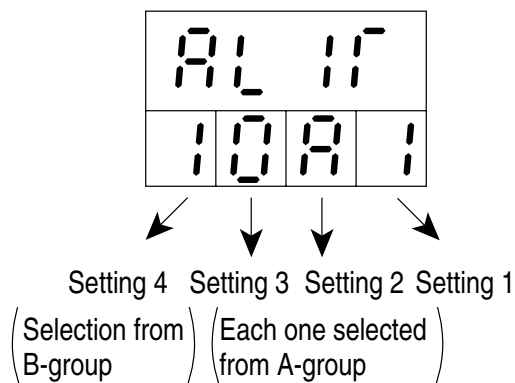

\* For the setting in the above figure, the result of ORing of the heater break alarm, "holding"-featured low-limit deviation alarm, and high-limit absolute alarm is output.



Set one type code in each digit (settings 1 to 4). When a code that is not in the table is specified, it will be regarded as “no alarm (code: 0)”.

(A-group alarm)

Code	Type	
0	No alarm	No alarm used
1	High limit absolute value	
2	Low limit absolute value	
9	Low limit absolute value with holding feature	
3	High limit deviation	
4	Low limit deviation	
A	Low limit deviation with holding feature	
5	High limit deviation (inverted)	
6	Low limit deviation (inverted)	
B	Low limit deviation (inverted) with holding feature	
7	High/low limit deviation	
C	High/low limit deviation with holding feature	
8	High/low limit deviation (inverted)	
D	High/low limit deviation (inverted) with holding feature	
E	SV high limit absolute value	
F	SV low limit absolute value	

**NOTE:** SV high limit absolute and SV low limit absolute alarms can be set only in the remote SV type.

(B-group alarm)

Code	Type
0	No alarm
1	Heater break detection
2	Loop break detection
3	Heater break detection + Loop break detection

*NOTES: Any code setting does not result in heater break detection unless the heater break option is provided.*

*AL 1 1* (alarm 1 - set point 1) Sets the value for alarm.

*AL 1 2* (alarm 1 - set point 2)

*AL 1 3* (alarm 1 - set point 3)

*AL 2 1* (alarm 2 - set point 1)

*AL 2 2* (alarm 2 - set point 2)

*AL 2 3* (alarm 2 - set point 3)

*A 1 1h* (alarm 1-hysteresis 1) Sets the hysteresis for alarm.

*A 1 2h* (alarm 1-hysteresis 2)

*A 1 3h* (alarm 1-hysteresis 3)

*A 2 1h* (alarm 2-hysteresis 1)

*A 2 2h* (alarm 2-hysteresis 2)

*A 2 3h* (alarm 2-hysteresis 3)

**L O O P** (loop break detection time)

The loop break detection time is set in minutes and seconds. By setting 00.00, the alarm will be turned ON only at an abnormal input (overrange/underrange, burn-out etc.). (00.00~99.59)

**H B - A** (heater break detection current value)

The heater break detection current value is set in the unit of ampere. (1~50A)

**I I** (heater current value)

Displays the current in the heater. This parameter cannot be changed. (0~50A)

### Supplementary descriptions

1. If during normal operation, the output (MV value) to switch to less 0% or more 100%, and the input (PV value) not moved more than  $\pm 3\%$ FS elapsed the time defined in “**L O O P**” parameter, then the “**L P B r**” message will appear and loop break alarm turns ON.
2. This device provides the heater current monitor function (for only the heater break option-fitted type). The current value is displayed in parameter “**I I**”. This can be used as reference when determining the heater break detection current value.
3. The heater current measured value is read only when the control output-1 relay is on. When that relay is off, the value at the point immediately before the relay is set off is retained.

4. Detection of the heater current requires the following current transformer (to be purchased separately).

Heater current value	Types
For 1~30A	CTL-6-SF
For 20~50A	CTL-12-S36-8F

5. Heater break alarm is not available in the following cases.

- 1) Control output 1 is SSR drive output or current output.
- 2) Control output 1 is relay (1c contact) output and the heater is ON on the contact N.C. (normally close) side.
- 3) The output proportion cycle time of control output 1 is lower than 20 seconds.

## Ramp soak

Parameter to be used

```

STAR/TCNE/Pr oG/P-on
S01 /S02 /S03 /S04
T01r /T02r /T03r /T04r
T01S /T02S /T03S /T04S
    
```

\* This function is an option.

### Ramp soak function

Function to automatically change the set point value (SV) with elapsing of time, in accordance with the preset pattern, as shown below. This device allows a maximum of 4 ramp soak programs.

The first ramp starts at the value measured immediately before the program is executed (PV).

After the program ends, the manipulate value is output according to ("burr n") setting. If you want to continue the control with the setting value (SV) immediately prior to the end of the program, set the parameter "burr n" to 0 (control continue). Note that, with this setting, the control will be continued even if abnormal input takes place.

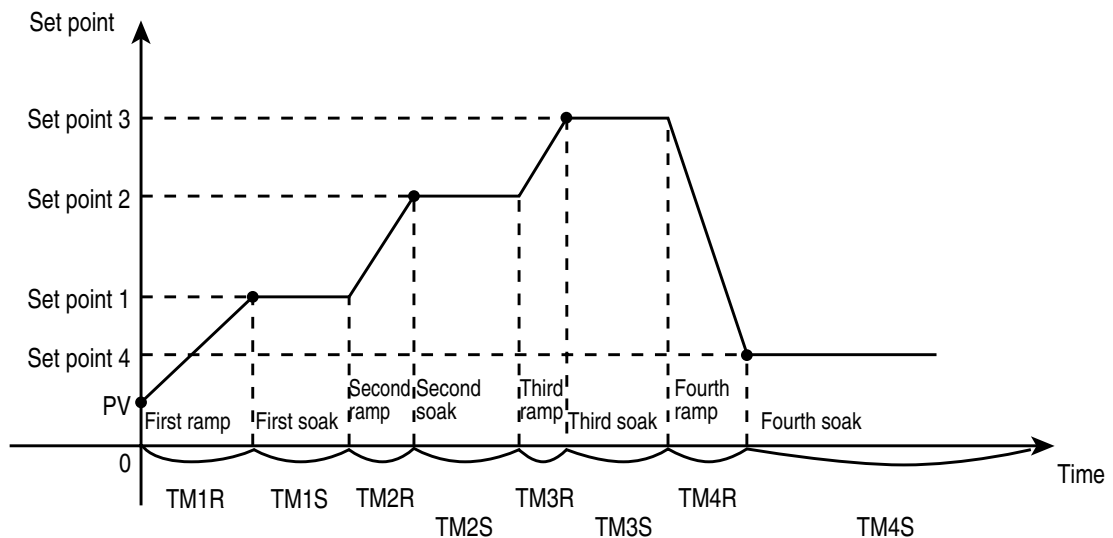

Ramp.... Region in which the SP changes toward the target value.

Soak.... Region in which the SP keeps unchanged at the target value.

Powering on can automatically trigger the program run (power-on start function). External contact signals (option) also run the program (start/reset).

Operating procedure

**P r o G** (ramp soak command) Switches the program operation modes.

<b>o f f</b>	Local operation
<b>r u n</b>	Program run
<b>h o l d</b>	Program temporary halt

**P - o n** (power-on start command) Set this to determine whether the power-on start should be made. (Yes/No)

**S 0 1** (first-ramp target value) Sets the target value (SV) during each ramp. (0~100%FS E.U.)

**S 0 2** (second-ramp target value)

**S 0 3** (third-ramp target value)

**S 0 4** (fourth-ramp target value)

**r n 1 r** (first ramp segment time) Sets the duration (in hours and minutes) of each time segment

**r n 1 s** (first soak segment time)

**r n 2 r** (second ramp segment time)

**r n 2 s** (second soak segment time)

**r n 3 r** (third ramp segment time)

`r n35` (third soak segment time)

`r n4r` (fourth ramp segment time)

`r n45` (fourth soak segment time)

`r nE` (time for rest of the program) The time for rest of the program is displayed as follows. This parameter cannot be set.

When the time for rest is 100 hours or more: “100h”  
(example: for 100 hours)

When the time for rest is less than 100 hours: “99.59”  
(example: for 99 hours and 59 min)

`Sr Rr` (present point of program) It displays the program run status as shown in the following table. This parameter cannot be set.

<code>“ off”</code>	Stop	<code>“3-rP”</code>	Third ramp running
<code>“1-rP”</code>	First ramp running	<code>“3-5t”</code>	Third soak running
<code>“1-5t”</code>	First soak running	<code>“4-rP”</code>	Fourth ramp running
<code>“2-rP”</code>	Second ramp running	<code>“4-5t”</code>	Fourth soak running
<code>“2-5t”</code>	Second soak running	<code>“End”</code>	Program end

When using the start/reset function, connect an external terminal with reference to the section “5. Wiring” starting on the page 19. The operations will be as follows. External contact input takes place at the time when the contact status (ON/OFF) changes (edge detection).

External contact (digital input DI)	Operation
ON → OFF	Program stops. “OFF”
OFF → ON	Program runs. “run”

**NOTE:**

1. Do not use the auto-tuning function while the ramp soak function is ON (“run” is not “OFF”).
2. The ramp soak command “run” will be set off, once the power supply is switched “OFF”.



Parameter to be used

## Two set-points

d - 50

\* This function is an option.

### Two set-points

Changes setpoint with external contact input (Digital Input). See “5. Wiring” starting on the page 19 for connection of an external contact.

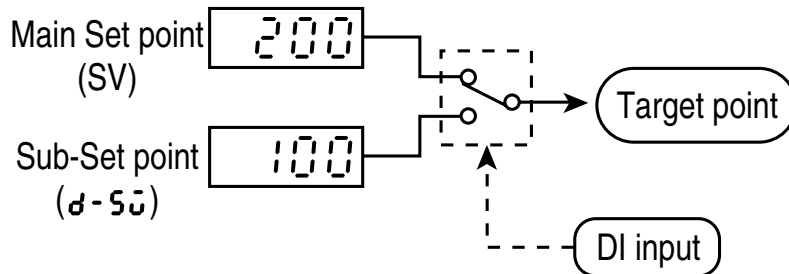

### Operating procedure

d - 50 (sub-set point)

Set the sub-Set point in parameter “d - 50”. The target value is the sub-Set point value while DI input is on and, while it is off, the main Set point value is the target value.

Target value	Main Set point	Sub-Set point	Main Set point
	OFF	ON	OFF
DI input	OFF	ON	OFF

**Analog output (AO)****AOI / AO-H / AO-L**

\* This function is an option.

AO output function

Function to externally output the PV, SV, or MV value with DC1~5V signals. AO output can be scaled.

Operating procedure

**AOI** (AO output type)

Set the parameter “**AO-I**” to the desired output signal type.

<b>PV</b>	Measured Value
<b>SV</b>	Setting Value
<b>MV</b>	Manipulated Value

**AO-H** (scale high limit)

**AO-L** (scale low limit)

Set the parameters “**AO-H**” and “**AO-L**” to the signal type values (%) corresponding to the 5V and 1V output respectively of AO. (Percentage against the input range is set when the signal type is PV or SV, the % value with respect to the input range is set.)

Example: Input .... K thermocouple, 0 ~ 800°C range

1~5V signals are to be output when PV values are at 200 - 600°C.

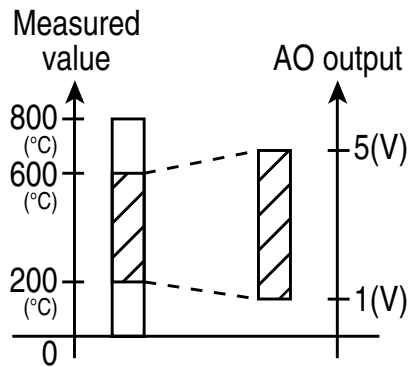

{ AO signal type . . . PV value  
 600°C → 75% of input range  
 200°C → 25% of input range

(Setting)

$R_{of}$  . . . "PU"  
 $R_{o-h}$  . . . 75.0%  
 $R_{o-l}$  . . . 25.0%

NOTE:

1.  $R_{o-h}$  must be greater than  $R_{o-l}$ .

**Digital output**

51 n0

\* This function is an option.

Digital transmission function

Using the RS-485 communication, this function allows remote control for parameter settings and process monitoring. This employs the multi-drop system, and allows connection of a maximum of 31 units. The communication protocol conforms to the Fuji Electric CC data line protocol or Modbus<sup>®</sup>RTU (Radio Terminal Unit) protocol. Select model configuration when you order (See page 6 or 7). For details, refer to the Fuji Electric PYX Transmission Protocol Specifications (TN508165-E).

Operating procedure

51 n0 (station No.)                      Set the station number (1~31).

Perform transmission in accordance with the PYX Transmission Protocol Specifications. In case of Fuji Electric CC data line protocol, the available commands are for polling (parameter read), selecting (parameter write) and control (parameter save). In case of Modbus<sup>®</sup>RTU (Radio Terminal Unit) protocol, they are for polling (parameter read) and selecting (parameter write, including parameter save <fix>). Communication settings are fixed as described below. Make sure that the host side has the same settings.

Transmission signal	.....	RS-485
Transmission rate	.....	9600 bps
Parity	.....	Odd
Stop bit	.....	1 bit

## NOTES:

1. For the control (parameter save) operation, a maximum of 5 sec is required for the interval from receiving a command to completing the operation. **Before ending of that interval, never turn the power for this device off** (otherwise, the memory contents are destroyed and disabled).
2. This unit requires a time length of 100 to 120mS as the interval from completing reception of a command from the host before returning the response. It also requires 20mS before it is able to receive the next command after completing a reply.

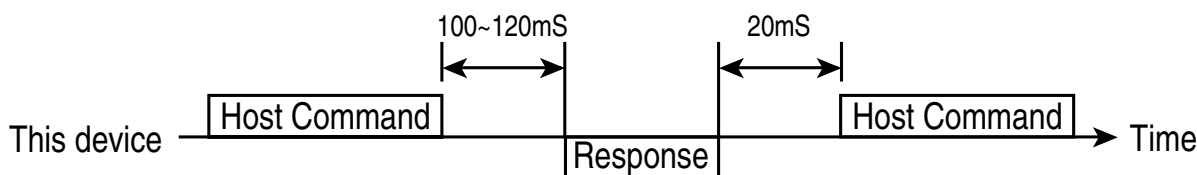

*Modbus<sup>®</sup> is a registered trademark of Gould Modicon.*

Parameter to be used

## Manual operation

**Run** /Set Point value (MV)

### Manual mode

Direct manipulation

### Operating procedure

**Run** (control mode)

Switches the control mode

<b>Run</b>	Automatic control
<b>MAN</b>	Manual control

(During manual mode, the Set point value and “**MAN**” alternate in display on the Run screen.)

Set point value

**8888**

Set the manipulated variable to be output in “%” units into the SP field of the operation screen. (-3.0-103.0%)

### Supplementary descriptions

1. The normal PID or fuzzy control status is called the auto mode (“**Run**”), and manual operation status is referred to as the manual mode (“**MAN**”).

**NOTE:**

1. For the dual control type, the manual control mode is not available.
2. Though the display of manual output can be set in 0.1% unit, the actual output resolution is 1%.
3. Autotuning cannot be executed in the manual mode.
4. Power supply is off during manual operation, the value of “*MAN*” becomes 0.0%.
5. When the manipulated variable is changed during manual operation, the proportion cycle being output at that changing point is followed by the next proportion cycle which starts the actual output of changed MV.

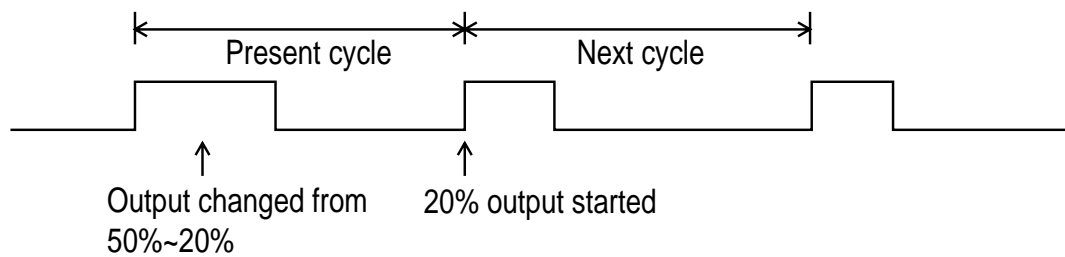

Parameter to be used

## Remote SV

Mod / Set value /  
CAS / -ENF / -ENB

\* This function is an option.  
Remote SV function

This function is used to input a signal of 1 to 5 VDC externally, and changes and controls the set value (SV) according to the input voltage. This is useful for cascade control etc.

### Operating procedure

Mod (Select the control mode) Sets the control mode

AUT	Enables automatic control. (See Page 69 for details.)
MAN	Enables manual control. (See Page 69 for details.)
-EN	Enables remote control.

Set value 888.8

The set value (SV) by remote input is displayed during remote control. (The keys on the front panel are disabled during remote control.)

CAS (Remote control set value)

The set value (SV) by remote input, regardless of the current mode. This parameter cannot be changed.

-ENF (Scale high limit)

The remote set values (SV) corresponding to the remote input 5V and 1V as the parameter “-ENF” and “-ENB” respectively. (0 to 100% FS E.U.)

-ENB (Scale low limit)

### Supplementary descriptions

1. See Page 69 for “AUT” and “MAN” (automatic and manual modes).
2. When the mode is switched to “AUT” (the automatic mode) during “-EN” (remote operation), the set value (SV) of the automatic mode will be the same as the set value of the remote control. (The set value will be switched by bumpless).
3. The set value will be the low limit when the remote input is disrupted.
4. Fuzzy control can be used for set value (SV) changes in steps.

### **NOTES:**

1. -ENF must be greater than -ENB.
2. Caution is required when executing auto-tuning during remote operation, since auto-tuning will be disrupted if the set value (SV) changes by more than 0.5%FS per 0.5 second before the completion of auto-tuning.



## Output monitoring

out 1/out 2

### Output monitor function

Numerically displays the MV being output.

### Operating procedure

out 1 (MV for output1)

The currently output value of single-output or dual-output heating-side MV is displayed in percent. (-3.0 to 103.0%)

out 2 (MV for output2)

The currently output value of dual-output cooling-side MV is displayed in percent. (-3.0 to 103.0%)

### NOTES:

1. Neither out 1 nor out 2 can be set.
2. out 2 is not displayed with the single-output type.

## VI. SET-UP PARAMETER

---

Parameter to be used

Input filter

$\tau$   $F$

### Input filter

When a PV value becomes unstable due to effects of noise, the filter helps suppress the unstable status.

### Setting procedure

$\tau$   $F$  (input filter constant) Set the filter time constant in sec units (0.0 ~ 900.0 (sec)).

$\tau$   $F$  = 0, input filter function is not active.

The filter effects increase as this setting becomes larger, and decrease as it becomes smaller.

Smaller	←	Time constant	→	Larger
Faster	←	Response	→	Slower
Little	←	Effect	→	Great

Parameter to be used

**PV shift**

**SFT**

### PV shift

Shifts the PV. Use this function when the PV is to be adjusted according to a recorder or an indication instrument, or when the sensor is not in the right position and therefore the PV must be adjusted.

### Setting procedure

**SFT**

(PV shift value)

Set the shift value to be added to PV. (-50 ~ 50%FS E.U.)

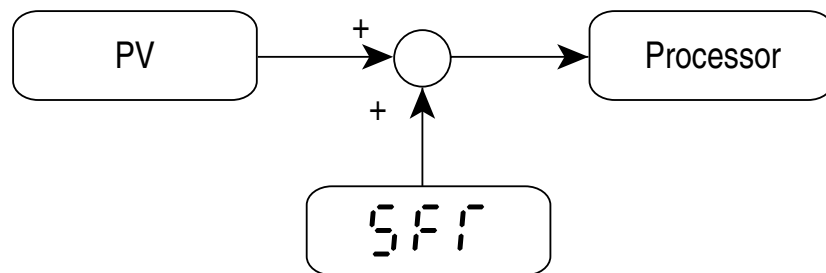

**Control type**
Control type

In addition to **PID control**, this device is fitted with the **fuzzy control** suitable for suppressing overshoot. One of the two can be selected as the control type.

Setting procedure

(control type)

Select the control type.

	PID control
	Fuzzy control

**NOTES:**

1. When control is made with the fuzzy, the PID parameter must be set as with PID control. However, it need not be tuned particularly for the fuzzy. (The values are allowed to be the same as those for PID control.)
2. The fuzzy control mode also allows use of the autotuning function.
3. Fuzzy control cannot be used in the dual output type.
4. The two-set-point function is not available in the fuzzy control mode.
5. Fuzzy control can only be used when the set values change in steps. Attention is required when the ramp soak function or remote SV function is used.

## Output setting in input abnormal

**burrn**

### Input abnormal-time output

In the event of an input PV error (e.g. thermocouple burn-out, sensor disconnection or short-circuit, over-input, under-input etc.), or after the ramp soak function (option) program ends, the value specified in advance as the parameter “**burrn**” is output as the manipulated value.

### Setting procedure

**burrn** (input abnormal-time output selection code)

Set the code number (0 ~ 4) by referencing the following table.

Code No.	Control output 1	Control output 2
0	Going on control	Going on control
1	-3%	-3%
2	103%	103%
3	-3%	103%
4	103%	-3%

### *Supplement:*

1. Set the parameter **burrn** to “0” when the control is desired to be continued after the ramp soak function (option) program terminates, with the set value prior to the program termination.

### **NOTES:**

1. The parameter “**burrn**” specifies only one type of output for both cases of abnormal input and program end. In other words, the same operation will be made after an input error and after the program ends.

## Output limits

$$\overline{MV} - h / \overline{MV} - l$$

### Output limit

Function to limit the manipulated variable. Used to limit the output range to favor conditions of the process or operation terminal.

### Setting procedure

$\overline{MV} - h$  (MV high limit)

$\overline{MV} - l$  (MV low limit)

Set the manipulated-variable high and low limits (-3.0 ~ 103.0%).

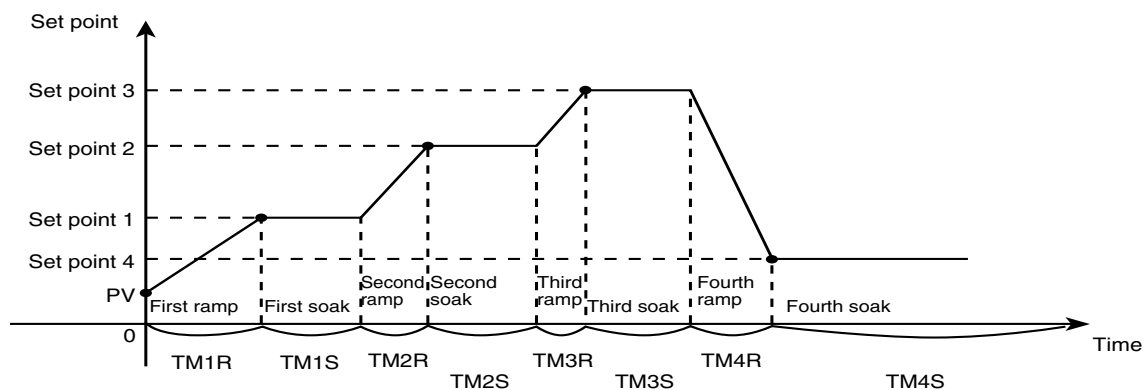

Ramp..... Region in which the SP changes toward the target value.

Soak..... Region in which the SP keeps unchanged at the target value.

**NOTES 1:** Setting must always be made to satisfy the condition of

$$\overline{MV} - h > \overline{MV} - l.$$

2: Limiting is not valid during manual operation.

3: Auto-tuning provides the 0-100% range output regardless of limiting.

4: The limiter is not valid for the 2 point (ON/OFF) control.

5: The loop break detection cannot be performed when " $\overline{MV} - l$ " exceeds 100.0% or does not reach 0.0%.

Parameter to be used

## Set point value limits

$SP-H / SP-L$

### Set point limit

Function to limit the range in which Set point can be set.

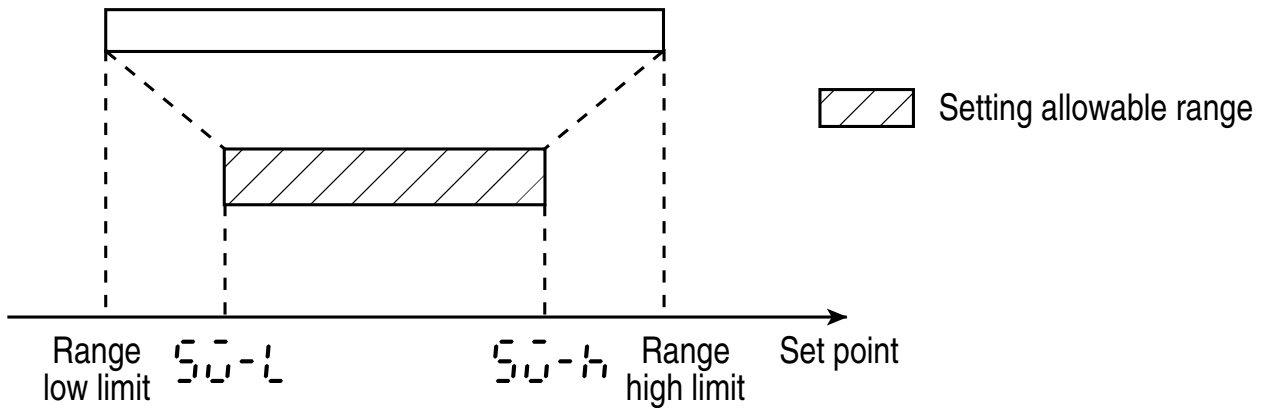

### Setting procedure

$SP-H$  (Set point high limit)

$SP-L$  (Set point low limit)

Set the Set point high and low limits within the input scale 0 ~ 100% range. (0 ~ 100%FS E.U.)

**NOTES:** Setting must be made to satisfy the condition of  $SP-H > SP-L$ .

**Output cycle time**

P1 - 1 / P1 - 2

Output proportion cycle time

The relay/SSR drive output delivers the manipulated variable (0 ~ 100%) as the proportion of output-off time and output-on time. The sum of output-on time and output-off time lengths, that is the on/off cycle time is called the output proportion cycle time.

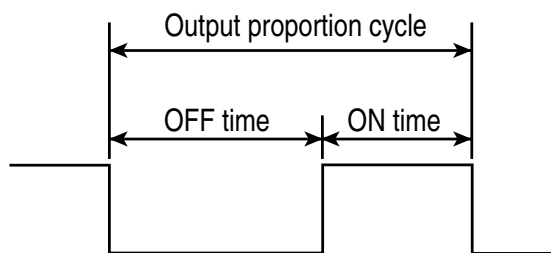
Setting procedure

P1 - 1 (Output 1 side proportion cycle time)

The output proportion cycle time is set in sec units (1 ~ 120 sec).

P1 - 2 (Output 2 side proportion cycle time)

Normally the following output proportion cycle time values must be specified.

Relay output	20 seconds
SSR drive output	2 seconds



*Supplement:*

1. *" $\Gamma \square - 1$ " and " $\Gamma \square - \bar{c}$ " are not displayed in the case of current output.*
2. *" $\Gamma \square - \bar{c}$ " is not displayed in the case of single output type.*

**Direct/reverse control action**

r E 0 1 / r E 0 2

Selecting direct/reverse operation

Selects the direct operation mode (cooling control) or the reverse operation mode (heating control).

Setting

r E 0 1 (operation on the control output 1 side)

Set the operation modes for control 1 and 2 as indicated below.

r E 0 2 (operation on the control output 2 side)

r E 0	Reverse operation (heating control)
n o r 1	Direct operation (cooling control)

**NOTE:**

1. r E 0 2 is not displayed in the case of single output type.

Parameter to be used

## Control processing cycle time

$dT$

### Control processing cycle time

This function is not supported now.

Please set 0.5 sec. to “dT” parameter.

Cf. Delivery value of “dT” parameter is 0.5 sec..

# APPENDIX

---

## 1. ERROR MESSAGES

Display	Cause	Control output
UUUU	1. Thermocouple sensor burn out 2. Thermoresistance sensor disconnection 3. Input exceeding 105% of the input range	The value preset in parameter "burn" is output. For details, see "Output setting in input abnormal" on page76.
LLLL	1. Thermoresistance sensor disconnection 2. Thermoresistance sensor short-circuit 3. Input under -5% of the input range	
Hbrt	1. Heater disconnection	Going on control
LPbr	1. Control loop error (cause not specifically determined)	
FAIL	1. Memory data destroyed	Going on control

If display indicates an error, remove its cause as soon as possible.

## 2. POWER FAILURE

- a) Operation of this device is not affected in case of instantaneous power failure with a duration of 20ms or less.
- b) In case of power failure with a duration of 20ms or more, operation is made in the same manner as when re-powering on is made.

### 3. SPECIFICATIONS

- Input block
  - Indication accuracy
    - Thermocouple input  
 $\pm 0.5\%FS \pm 1 \text{ digit} \pm 1$  (at 23°C)  
 \* B thermocouple 0 ~ 400°C  $\pm 5\%$   
 R thermocouple 0 ~ 500°C  $\pm 1\%$
    - Thermoresistance input  
 $\pm 0.5\%FS \pm 1 \text{ digit}$  (at 23°C)
    - Voltage input, current input (externally mounted resistance use)  
 $\pm 0.5\%FS \pm 1 \text{ digit}$  (at 23°C)
  - Temperature drift
    - $\pm 0.3\%FS/10^\circ\text{C}$
  - Reference contact temperature compensation adjustment
    - $\pm 1.0^\circ\text{C}$
  - Input sampling cycle time
    - 500msec
  - Input impedance
    - Thermocouple: 1M $\Omega$  or above
    - Current input: externally mounted resistance of 250 $\Omega$
    - Voltage input: 1M $\Omega$  or above
  - Allowable signal source resistance
    - Thermocouple: 250 $\Omega$  or below
    - Voltage input: 1k $\Omega$  or below
  - Allowable wiring resistance
    - Thermoresistance: 10 $\Omega$  or below (for one wire)

- Output block
  - Control output
    - Relay contact output
 

Proportion cycle time:	20 ~ 120sec
Contact structure:	SPST, SPDT
Contact capacity:	AC220V/DC30V 3A (resistance load)
(Standard load)	AC220V/DC30V 1A (inductive load)
Minimum switching current:	100mA (DC24V)
Mechanical life:	20 million cycles or more
Electrical life:	100 thousand cycles or more (Standard load)
    - Voltage pulse output (SSR/SSC drive output)
 

Proportion cycle time:	1 ~ 120sec
ON voltage:	DC9V ~ 24V
OFF voltage:	DC0.5V or below
Maximum current:	DC20mA
Load resistance:	600Ω or above
    - Current output (DC4 ~ 20mA)
 

Ensured output range:	DC3.52mA ~ 20.48mA (-3 ~ 103%)
Accuracy:	±5%FS
Linearity:	±2%FS
Resolution:	1.0%FS
Follow-up speed:	2 sec or below
Load resistance:	600Ω or below
- Display block
  - Display system
    - 7-segment, 4-digit × 2-stage, red, green
- Power supply block
 

Power supply voltage	AC100 ~ 240V, Free power supply
Power supply voltage variation	within -15% ~ +10%
Power supply frequency	50/60Hz (±5%)
Power consumption	AC100V: 10VA or below AC240V: 18VA or below

- External dimensions: (W × H × D) mm:
  - 48 × 48×120.5 (PYX4)
  - 48 × 96×112 (PYX5)
  - 96 × 96×112 (PYX9)
- Weight:
  - Approx. 200g (PYX4)
  - Approx. 300g (PYX5)
  - Approx. 400g (PYX9)
- Mounting method: Panel-installed type
- External terminals: screw terminals M3.5
- Ambient temperature -10 ~ 50°C
- Ambient humidity 90%RH or below (no condensation)
- Warm up 2 hours or above
- Insulation resistance DC500V, 20MΩ or above
- Control function (PID or fuzzy control selectable)
  - Basic PID type (Position type)
    - Proportional band (P): 0.0 ~ 999.9%, P=0 ON/OFF control
    - Integration time (I): 0 ~ 3200 sec, I=0 integration off
    - Derivative time (D): 0 ~ 999.9 sec, D=0 derivative off
  - Fuzzy control
- Digital filter
  - First-order time-lag filter
  - 0.0 ~ 900.0 sec, Set resolution 0.1 sec (0: OFF)
- PV input compensation
- Over-range, under-range
  - PV shift (±50%FS)
  - Outside the range of -5 ~ 105%

- Alarm output (ALM1, ALM2 option)
  - Output update cycle time: 500msec
  - Relay contact output ×2-pts SPST contact
    - Contact capacity: AC220V/DC30V 1A (resistance load)
    - (Standard load) AC220V/DC30V 0.3A (inductive load)
  - Minimum switching current: 100mA (DC24V)
  - Mechanical life: 12 million cycles (200 times/min.)
  - Electrical life: 100 thousand cycles (Standard load, 20 times/min.)
- Loop break alarm output (Option)
  - Output update cycle time: 500msec
  - Alarm setting range: 0.0 ~ 99 min 59 sec
  - Relay contact output: Alarm relay also used for this
- Heater break alarm input signal (option)
  - 1 ~ 30A: CT (CTL-6-SF)
  - 20 ~ 50A: CT (CTL-12-S36-8F) used
  - \*However, the output proportion cycle time must be 20 sec or above.
- Heater break alarm output (option)
  - Output update cycle time: 500msec
  - Alarm setting range: 1 ~ 50A
  - The alarm output relay is also used for this output.
- Ramp/soak function (option)
  - Program pattern count: 1 pattern
  - Number of ramps/soaks per pattern: Maximum of 4
  - Time indication range: 0 hour 0 min - 799 hours
  - Memory backup: EEP-ROM
  - OFF/run by digital input possible (only when start/reset option is provided)



- Auxiliary analog output (option)
  - Number of channels: 1
  - Output type: DC1 ~ 5V
    - Ensured output range: DC0.88V ~ 5.12V (-3 ~ 103%)
    - Accuracy:  $\pm 0.5\%FS$
    - Ripple voltage: P-P 1.0%FS or below (50Hz or below)
    - Temperature drift:  $\pm 0.3\%FS/10^{\circ}C$
    - Load resistance: 500k $\Omega$  or above
  - Attached function: scaling function
  - Output update cycle time: 500msec
- Digital input (Input by contact)
  - DC15V~21V 5mA
- Transmission function (option)
  - RS-485 (2-wire system)
    - Transmission system: Half-duplex, bit serial
    - Synchronous system: start-stop synchronization
    - Coding: data length 8-bit  
Parity odd
    - Transmission rate: 9600BPS
    - Number of units connectible: 31 units
    - Transmission distance: 500m
- Remote SV function (option)
  - Instruction setting accuracy:  $\pm 0.5\%FS \pm 1$  digit (at 23 $^{\circ}C$ )
  - Input filter: Digital filter (First-order time-lag filter) time constant 1 second
  - Sampling cycle time: 500msec
  - Temperature drift:  $\pm 0.3\%FS/10^{\circ}C$
  - Input impedance: 1M $\Omega$  or above
  - Allowable signal: 1K $\Omega$  or below  
source resistance
  - Attached function: Scaling function

## 4. TROUBLESHOOTING

Phenomenon	Possible cause	User response
Required parameter not displayed	<ul style="list-style-type: none"> <li>• Wrong lock level is specified.</li> </ul>	<ul style="list-style-type: none"> <li>• Set the right lock level. (See Page 44~46.)</li> </ul>
Set point not changed	<ul style="list-style-type: none"> <li>• Set point limits not correct</li> <li>• Ramp/soak command set to other than □ F F (for the type with the ramp/soak function)</li> </ul>	<ul style="list-style-type: none"> <li>• Set the correct Set point limits. (See Page78.)</li> <li>• Set the ramp/soak command to □ F F . (See Page 60~63.)</li> </ul>
Setting of alarm not displayed	<ul style="list-style-type: none"> <li>• Alarm type set to "No alarm" (Code: 0)</li> </ul>	<ul style="list-style-type: none"> <li>• Set the alarm type to be set. (See Page 55~59.)</li> </ul>
"L P b r" display flickering	<ul style="list-style-type: none"> <li>• Input error</li> <li>• Heater break</li> <li>• Control loop illegally connected</li> </ul>	<ul style="list-style-type: none"> <li>• Check the input or sensor connection and input switch pin setting (for multi-input type). (See Page 19~29, 40.)</li> <li>• Replace the heater.</li> <li>• Set the correct control loop.</li> </ul>
"F A L T" display flickering	E E P - R O M data destroyed	<ul style="list-style-type: none"> <li>• Replace the main unit.</li> </ul>
"U U U U" or "L L L L" display output	<ul style="list-style-type: none"> <li>• Input error</li> <li>• Input switch pin illegally set (for multi-input type)</li> </ul>	<ul style="list-style-type: none"> <li>• Check the input or sensor connection. (See Page 19~29.)</li> <li>• Set the input switch pin correctly. (See Page 40.)</li> </ul>
"----" displayed	<ul style="list-style-type: none"> <li>• Input value incapable of being displayed in four digits</li> </ul>	<ul style="list-style-type: none"> <li>• Make sure the input is appropriate.</li> </ul>

Phenomenon	Possible cause	User response
Autotuning not available	<ul style="list-style-type: none"> <li>• Input error</li> <li>• Ramp/soak command set to other than "0 F F"</li> <li>• Manual run being performed</li> <li>• Set point changed during autotuning</li> <li>• Because of the too slow process, autotuning is not terminated within 12 hours.</li> </ul>	<ul style="list-style-type: none"> <li>• Check the input or sensor connection. (See page 19~29.)</li> <li>• Check the input switch pin correctly. (See page 40.)</li> <li>• Set the ramp/soak command to "0 F F" during autotuning. (See page 60~63.)</li> <li>• Switch the manual run mode to the automatic run mode. (See page 69.)</li> <li>• Do not change the Set point value during autotuning.</li> <li>• Autotuning is not available. Perform manual tuning. (See page 51~54.)</li> </ul>
"F F" Set point not raised (for the type fitted with heater break alarming)	<ul style="list-style-type: none"> <li>• The control output relay has been switched on not long enough.</li> <li>• Output proportion cycle time too short</li> </ul>	<ul style="list-style-type: none"> <li>• If the control output relay does not get triggered at least 1 sec after powering on, the correct heater current value cannot be detected. (See page 58.)</li> <li>• Set the output proportion cycle time of "F F - I" to 20 sec or more. (See page 79.)</li> </ul>
Loop break detection not available	<ul style="list-style-type: none"> <li>• Output limit setting is illegal</li> </ul>	<ul style="list-style-type: none"> <li>• Loop break detection is not available when "F F - H" is smaller than 100.0 or "F F - L" is larger than 0.0. (See page 77.)</li> </ul>
Digital transmission not properly performed	<ul style="list-style-type: none"> <li>• Host-side setting is wrong.</li> <li>• Station number is wrong.</li> <li>• Polarity of transmission connection is wrong.</li> </ul>	<ul style="list-style-type: none"> <li>• Give the right transmission setting to the host. (See page 67~68.)</li> <li>• Set the right station number. (See page 67~68.)</li> <li>• Check if the transmission connection are all right. (See pages 19~29.)</li> </ul>

## 5. PARAMETER LIST

Display	Name		Lock level	Description	Initial value during shipment	Remarks								
LOCK	LOCK	Lock level	0	Parameter locking (setting range: 0 ~ 3)	2									
CAS	CAS	Remote set value	3	Displays the set value (SV) by remote input. (Displayed range: 0 to 100% FS E.U.)	–	Not displayed when the remote SV function is disabled.								
OUT 1	OUT1	Control output 1 output value	3	Displays the output value of Copntrol Output 1. (display range: –3.0 ~ 103.0%)	–	No setting								
OUT 2	OUT2	Control output 2 output value	3	Displays the output value of Copntrol Output 2. (display range: –3.0 ~ 103.0%)	–	No setting Not displayed unless control output 2 is provided.								
Mod	MOD	Control mode	2	<table border="1"> <thead> <tr> <th>Setting</th> <th>Mode</th> </tr> </thead> <tbody> <tr> <td>“AUTO”</td> <td>Auto</td> </tr> <tr> <td>“MAN”</td> <td>Manual</td> </tr> <tr> <td>“REN”</td> <td>Remote</td> </tr> </tbody> </table>	Setting	Mode	“AUTO”	Auto	“MAN”	Manual	“REN”	Remote	“AUTO”	“REN” not displayed when the remote SV function is disabled.
Setting	Mode													
“AUTO”	Auto													
“MAN”	Manual													
“REN”	Remote													
AT	AT	Autotuning command	1	<table border="1"> <thead> <tr> <th>Setting</th> <th>Autotuning</th> </tr> </thead> <tbody> <tr> <td>“OFF”</td> <td>Stop</td> </tr> <tr> <td>“ON”</td> <td>Normal autotuning</td> </tr> <tr> <td>“Lo”</td> <td>Low-PV type autotuning</td> </tr> </tbody> </table>	Setting	Autotuning	“OFF”	Stop	“ON”	Normal autotuning	“Lo”	Low-PV type autotuning	“OFF”	
Setting	Autotuning													
“OFF”	Stop													
“ON”	Normal autotuning													
“Lo”	Low-PV type autotuning													
d-SV	D-SV	Sub-Set point	2	2-setting function sub-set point (setting range: 0 ~ 100%FS E.U.)	0%FS E.U.	Not displayed unless the 2-setting function is provided.								
STAT	STAT	Ramp/soak present point	1	Ramp/soak proceeding status is displayed with a symbol. No setting (display: OFF/1-RP/1-SK/2-RP/2-SK/3-RP/3-SK/4-RP/4-SK/END)	–									
TIME	TIME	Ramp/soak remaining-operation time	1	The ramp/soak proceeding status is displayed with the time for remaining operation. When the time for remaining operation exceeds 100 hours, the hours display of "xxxh" is made. When the time is under 100 hours, the hour/min display of "xx.xx" is made. No setting.	–	Not displayed unless the ramp/soak function is provided.								

\* See page 44~46 for lock level.

\* E.U.: Engineering Units

\* D.E.U. : Deviation engineering Units

Display	Name		Lock level	Description	Initial value during shipment	Remarks								
Pr oG	PROG	Ramp/soak command	1	<table border="1"> <thead> <tr> <th>Setting</th> <th>Operation</th> </tr> </thead> <tbody> <tr> <td>"OFF"</td> <td>Function OFF</td> </tr> <tr> <td>"Run"</td> <td>Run</td> </tr> <tr> <td>"hold"</td> <td>Temporary stop</td> </tr> </tbody> </table>	Setting	Operation	"OFF"	Function OFF	"Run"	Run	"hold"	Temporary stop	"OFF"	Not displayed unless the ramp/soak function is provided.
Setting	Operation													
"OFF"	Function OFF													
"Run"	Run													
"hold"	Temporary stop													
SV 1	SV-1	First target value	1	First-ramp target value (setting range:0~100%FS E.U.)	0%FS E.U.									
r n 1r	TM1R	First ramp time	1	First-ramp segment time (hour/min) (setting range:00.00~99.59)	00.00									
r n 1S	TM1S	First soak time	1	First-soak segment time (hour/min) (setting range:00.00~99.59)	00.00									
SV 2	SV-2	Second target value	1	Second-ramp target value (setting range:0~100%FS E.U.)	0%FS E.U.									
r n 2r	TM2R	Second ramp time	1	Second-ramp segment time (hour/min) (setting range:00.00~99.59)	00.00									
r n 2S	TM2S	Second soak time	1	Second-soak segment time (hour/min) (setting range:00.00~99.59)	00.00									
SV 3	SV-3	Third target value	1	Third-ramp target value (setting range:0~100%FS E.U.)	0%FS E.U.									
r n 3r	TM3R	Third ramp time	1	Third-ramp segment time (hour/min) (setting range:00.00~99.59)	00.00									
r n 3S	TM3S	Third soak time	1	Third soak segment time (hour/min) (setting range:00.00~99.59)	00.00									
SV 4	SV-4	Fourth target value	1	Fourth-ramp target value (setting range:0~100%FS E.U.)	0%FS E.U.									
r n 4r	TM4R	Fourth ramp time	1	Fourth-ramp segment time (hour/min) (setting range:00.00~99.59)	00.00									
r n 4S	TM4S	Fourth soak time	1	Fourth-soak segment time (hour/min) (setting range:00.00~99.59)	00.00									
P - o n	P-ON	Power-on start	2	Ramp/soak power-on start command (setting range:NO/YES)	NO									
P	P	Proportional band	2	setting range:0.0~999.9%	5.0	'0' for ON-OFF control								

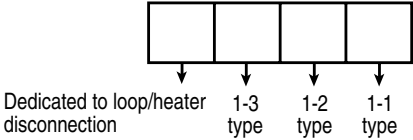
Display	Name		Lock level	Description	Initial value during shipment	Remarks
hys	HYS	2-point operation hysteresis	2	(setting range:0~100%FS D.E.U.)	0.5%FS D.E.U.	Not displayed except when P = 0.
i	I	Integration time	2	(setting range:0~3200sec)	240	At '0', integration operation turns off.
d	D	Derivative time	2	(setting range:0.0~999.9sec)	60.0	At 0, derivative operation turns off.
cool	COOL	Control output 2 proportional band coefficient	2	Control output 2 proportional band coefficient. '0' for 2-point operation (setting range: 0.0~10.0)	1.0	Not displayed unless control output 2 is provided.
db	DB	Dead band	3	Control output 2 shift value (setting range:-50~50%)	0.0	
Ar	AR	Anti-resetting wind up	3	The integration range is set (setting range: 0.0~100.0% D.E.U.)	100% FS (D.E.U.)	
man	MAN	Manual resetting value	3	MV shift (setting range:-100.0~100.0%)	0.0	
AL 11	AL1T	Types of alarm-1	2		0003 1000 for the HB fitted	Not displayed unless alarm 1 is provided.
AL 11	AL11	Alarm 1-1 Set point	2	Set point of Alarm 1-1 (setting range: 0~100%FS E.U.)	10 °C/°F. (0%FS E.U. for the HB-fitted)	Not displayed when alarm 1 is not provided, and when setting is not made for alarm 1-1.
A 11h	A11H	Alarm 1-1 hysteresis	3	Hysteresis for alarm 1-1 (setting range: 0~100%FS D.E.U.)	0.5%FS (D.E.U.)	

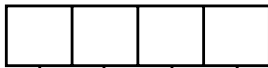
Display	Name		Lock level	Description	Initial value during shipment	Remarks
AL 12	AL12	Alarm 1-2 Set point	2	Alarm 1-2 Set point (setting range: 0~100%FS E.U.)	0%FS E.U.	Not displayed when alarm 1 is not provided, or when setting is not made for alarm 1-2.
A 12H	A12H	Alarm 1-2 hysteresis	3	Alarm 1-2 hysteresis (setting range: 0~100%FS D.E.U.)	0.5%FS (D.E.U.)	
AL 13	AL13	Alarm 1-3 Set point	2	Alarm 1-3 Set point (setting range: 0~100%FS E.U.)	0%FS E.U.	Not displayed when alarm 1 is not provided, or when setting is not made for alarm 1-3.
A 13H	AL13H	Alarm 1-3 hysteresis	3	Alarm 1-3 hysteresis (setting range: 0~100% FS D.E.U.)	0.5%FS (D.E.U.)	
AL 2T	AL2T	Type of alarm 2	2	 <p>Dedicated to loop/heater disconnection      2-3 type      2-2 type      2-1 type</p>	0004 1000 for the HB-fitted	Not displayed unless alarm 2 is provided.
AL 21	AL21	Alarm 2-1 Set point	2	Set point of alarm 2-1 (setting range: 0~100%FS E.U.)	10 °C/°F. (0%FS E.U. for the HB-fitted)	Not displayed when alarm 2 is not provided, and when setting is not made for alarm 2-1 and alarm 2.
A 21H	A21H	Alarm 2-1 hysteresis	3	Hysteresis for alarm 2-1 (setting range: 0~100%FS D.E.U.)	0.5%FS (D.E.U.)	
AL 22	AL22	Alarm 2-2 Set point	2	Alarm 2-2 Set point (setting range: 0~100%FS E.U.)	0%FS E.U.	Not displayed when alarm 2 is not provided, or when setting is not made for alarm 2-2.
A 22H	A22H	Alarm 2-2 hysteresis	3	Alarm 2-2 hysteresis (setting range: 0~100%FS D.E.U.)	0.5%FS (D.E.U.)	

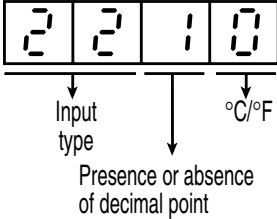
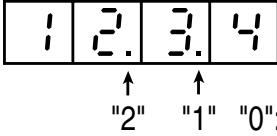
Display	Name		Lock level	Description	Initial value during shipment	Remarks
AL23	AL23	Alarm 2-3 Set point	2	Alarm 2-3 Set point (setting range: 0~100FS E.U.)	0%FS E.U.	Not displayed when alarm 2 is not provided, or when setting is not made for alarm 2-3.
AL23H	AL23H	Alarm 2-3 hysteresis	3	Alarm 2-3 hysteresis (setting range: 0~100FS D.E.U.)	0.5%FS (D.E.U.)	
Loop	Loop	Loop break alarm Set point	2	Loop break alarm detection time (min/sec) (setting range: 00.00~99.59)	00.00	Not displayed unless alarming is provided.
hb - A	HB-A	Heater break alarm Set point	2	Heater break alarm detection current (setting range: 1~50A)	50A	Not displayed unless heater break alarming is provided.
CT	CT	Heater current	2	Heater current monitor No setting (display range: 0~50A)	-	
PVT	PVT	PV type	3	Input type, presence or absence of decimal point, and °C/°F specified  	2200 unless otherwise specified (K thermocouple, 0 - 400 °C)	
PVF	PVF	Full scale	3	Scaling full scale (setting range: -1999~9999)	1000	Displayed only in the voltage or current input mode.
PVB	PVB	Base scale	3	Scaling base scale (setting range: -1999~9999)	0	
PVD	PVD	Scaling decimal-point location	3	Scaling decimal-point location  	1	
TF	TF	Input filter	3	Input filter time constant Setting 0.0 turns the filter off. (setting range: 0.0~900.0sec)	5.0	



Display	Name		Lock level	Description	Initial value during shipment	Remarks
SFT	SFT	PV shift	3	PV shift value (setting range:-50~50%FS D.E.U.)	0%FS (D.E.U.)	
SV-H	SV-H	Set point high limit	3	Set point high limit (setting range:0~100%FS E.U.)	100%FS	
SV-L	SV-L	Set point low limit	3	Set point low limit (setting range:0~100%FS E.U.)	0%FS E.U.	
REMF	REMF	Remote scaling full scale	3	The full scale for remote input scaling (Set range: 0 to 100% FS E.U.)	100% FS industrial value	Not displayed when the remote SV function is disabled
REMB	REMB	Remote scaling base scale	3	The base scale for remote input scaling (Set range: 0 to 100% FS E.U.)	0% FS industrial value	
CTRL	CTRL	Control operation system	2	Control operation algorithm selected (setting range: PID/FUZY)	PID	
DT	DT	Control operation cycle time	3		0.5 sec	
REV1	REV1	Control output 1 direct/reverse operation selection	3	(Setting range: REV/NORM)		
REV2	REV2	Control output 2 direct/reverse operation selection	3	(Setting range: REV/NORM)		Not displayed when control output 2 is not provided.
TC-1	TC-1	Control output 1 output proportion cycle time	3	(Setting range: 1~120 sec)	Relay output: 20 sec, SSR drive: 2 sec	Not displayed when output 1 is 4 - 20mA.
TC-2	TC-2	Control output 2 output proportion cycle time	3	(Setting range: 1~120 sec)	Relay output: 20 sec, SSR drive: 2 sec	Not displayed when 4 - 20mA output or without control output 2.

Display	Name		Lock level	Description	Initial value during shipment	Remarks																		
MV-H	MV-H	MV high limit	3	(setting range: -3.0~103.0%)	100.0																			
MV-L	MV-L	MV low limit	3	(setting range: -3.0~103.0%)	0.0																			
BURN	BURN	Output setting in input abnormal	3	<table border="1"> <thead> <tr> <th>Setting</th> <th>Output 1</th> <th>Output 2</th> </tr> </thead> <tbody> <tr> <td>0</td> <td>Going on control</td> <td>Going on control</td> </tr> <tr> <td>1</td> <td>-3.0%</td> <td>-3.0%</td> </tr> <tr> <td>2</td> <td>103.0%</td> <td>103.0%</td> </tr> <tr> <td>3</td> <td>-3.0%</td> <td>103.0%</td> </tr> <tr> <td>4</td> <td>103.0%</td> <td>-3.0%</td> </tr> </tbody> </table>	Setting	Output 1	Output 2	0	Going on control	Going on control	1	-3.0%	-3.0%	2	103.0%	103.0%	3	-3.0%	103.0%	4	103.0%	-3.0%	1	
Setting	Output 1	Output 2																						
0	Going on control	Going on control																						
1	-3.0%	-3.0%																						
2	103.0%	103.0%																						
3	-3.0%	103.0%																						
4	103.0%	-3.0%																						
AOT	AOT	AO output type	3	<table border="1"> <thead> <tr> <th>Setting</th> <th>AO source</th> </tr> </thead> <tbody> <tr> <td>PV</td> <td>PV</td> </tr> <tr> <td>SV</td> <td>SV</td> </tr> <tr> <td>MV</td> <td>MV</td> </tr> </tbody> </table>	Setting	AO source	PV	PV	SV	SV	MV	MV	"PV"	Not displayed unless AO is provided										
Setting	AO source																							
PV	PV																							
SV	SV																							
MV	MV																							
A0-H	A0-H	AO scaling full scale	3	AO output scaling full scale (setting range: 0.0~100.0%)	100.0																			
A0-L	A0-L	AO scaling base scale	3	AO output scaling base scale (setting range: 0.0~100.0%)	0.0																			
STNO	STNO	Station No.	2	Transmission originating station number (setting range: 1~31)	1	Not displayed unless transmission is provided.																		