

MXL-INSTPRA
REV 3
02/20



TYPE PRA DIGITAL REGISTER

INSTRUCTION MANUAL



- FLOWRATE INDICATOR
- TOTALIZER
- 4-20mA OUTPUT
- PULSE OUTPUT
- LOW & HIGH FLOWRATE ALARMS

To the Owner

Please read and retain this instruction manual to assist you in the operation of this product.

This Instruction Manual provides instruction guide on the operation and programming of the type PRA, 12mm LCD Digital Register.

Should you require further assistance please contact you local Macnaught representative.

Macnaught offer a comprehensive set of web based support materials to compliment our product range. Access the website by scanning the QR code.



WWW.MACNAUGHTUSA.COM

INDEX

Introduction	3
Functions and Features.....	3
Configuration.....	3
Display and mounting information.....	3
Installation.....	3
Warranty.....	3
Technical Specifications	4
General.....	4
Display.....	4
Inputs.....	5
Outputs.....	5
Set-up functions	6
Explanation of Set-up functions	7
Flow Rate/Total/ Batch/ Accumulated Total.....	7
Low/ High flowrate Alarms.....	7
Meter K-Factor.....	8
4 - 20 mA (Analog) output.....	8
Pulse output.....	9
Terminal connectors	10
Programming Set-up level	11
Modes of operation.....	11
Function of buttons.....	11
Entering and Exiting Setup mode.....	11
K-factor programming	12
How to find a k-factor of your meter.....	12
Entering K-factor in the display.....	12
Gallons to Litre conversion.....	12
Dimensions	13
Exploded view	13
Ordering code	13
Service kits	13
Troubleshooting	14
Replacing the battery.....	14
Notes	15

INTRODUCTION

FUNCTIONS AND FEATURES

The flow rate / totalizer model PRA is a microprocessor driven instrument designed to display flow rate, total and accumulated total.

This product has been designed with a focus on:

- Ultra-low power consumption to allow long-life battery powered applications.
- The glass reinforced polypropylene housing offers IP67 environmental protection.
- Transmitting possibilities with analog and pulse outputs.
- Alarm contacts for high and low flow rates.

CONFIGURATION OF THE UNIT

The PRA has been designed to be implemented in many types of applications. For that reason, a SETUP-level is available to configure your PRA according to your specific requirements.

It includes several important features, such as K-factors, measurement units etc. All settings are stored in EEPROM memory and will not be lost in the event of power failure.

DISPLAY INFORMATION

The unit has a large transfective LCD with various kinds of symbols and digits to display measuring units, status information and key-word messages.

Flowrate and total are displayed on 12mm digits.

A backup of the total and accumulated total in EEPROM memory is made every minute.

MOUNTING EXAMPLES

Mounting on MX meter body



Mounting on wall mount bracket



DISPLAY EXAMPLES

Flow rate example



Total example

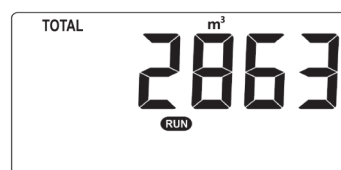

Display features Decimals and various units of measurement

Note !

INSTALLATION

The display has a unique M-lock mounting feature. It can be installed on

- MX meter body
- MX wall mount bracket

To install, secure the display on the cam and rotate quarter turn clock-wise (90 degrees)

To uninstall, hold the display and rotate quarter turn anti clock-wise (90 degrees)



There are no tools required to install/ remove the display

WARRANTY

For warranty terms & conditions, visit <https://www.macnaughtusa.com/warranty>

TECHNICAL SPECIFICATIONS

GENERAL

Display

Type	High intensity reflective numeric and alphanumeric LCD, UV-resistant
Digits	Seven 12mm (0.47") and seven 8mm (0.31"). Various symbols and measuring units
Refresh rate	Flow Rate: Once per second
	Total: 8 times/second after key press to one second

Enclosure

General	Polypropylene housing with Polycarbonate window, EPDM gaskets. UV stabilized
Control keys	Two industrial micro-switch keys. UV-resistant keypad.
IP Classification	IP67
Cable entry	(2) x M12 * 1.5
Backlight	No
Ex approvals	No

Temperature

Operational	-20°C to +80°C (-4°F to +176°F)
-------------	---------------------------------

Power supply options

Battery	Lithium battery - life-time depends upon settings - up to 3 years @ 20°C
	Battery specs: 3.6 VDC, 'A' size, type: ER17505 (Ordering code: DR012S)
External	18 - 30 VDC.

Terminal connections

Type	Terminal strip. Wire max. 1mm ²
------	--

Data protection

Type	Backup of all settings and running totals in flash memory
------	---

Environment

Electromagnetic compatibility	Compliant ref: EN 61326-1:2006, EN61010-1:2001
-------------------------------	--

DISPLAY

Flow rate / Total / Batch total / Accumulated total (Note: Total and Batch total can be reset to zero)

Digits	7 digits
Units	L - m ³ - UKGAL - USGAL - UKbbl - USbbl - OILbbl
Decimals	0 - 1 - 2 or 3

Flow Rate

Time units	/sec - /min - /hr
------------	-------------------

Operator functions

Displayed functions	Flow Rate.
	Total (can be reset to zero by the operator).
	Batch total (can be reset to zero by the operator)
	Accumulated total (non resettable)

TECHNICAL SPECIFICATIONS

INPUT

Input	
Input	Reed switch (from flow meter)
Frequency	Total: minimum 0 Hz - maximum 120 Hz for total
	Flow Rate: 0.01 Hz – maximum 120 Hz
K-Factor	0000.001 - 9,999.999 pulses per Litre

OUTPUTS

Analog Output

Function	This function transmits flow rate	
Type	4-20mA output, passive, loop powered	
Power Supply	24VDC	
Accuracy	10 bit resolution. Error < 0.05% - update 8 times a second Software function to calibrate 4.00 mA and 20.00 mA levels precisely within set-up	

Pulse Output (Programmable)

Function	This function transmits accumulated total	
Type	Transistor output, passive, isolated	
Power Supply	Max. 50V DC	
Max. Load	20mA	
Max. Frequency	100Hz	
Pulse Length	User definable - between 5 milli-seconds up to 1 second	
Isolation	100V DC maximum	

Low Flowrate Alarm (Programmable)

Function	This function transmits alarm in an event of low flowrate	
Type	Transistor output, passive, isolated	
Power Supply	Max. 50V DC	
Max. Load	20mA	
Isolation	100V DC maximum	

High Flowrate Alarm (Programmable)

Function	This function transmits alarm in an event of high flowrate	
Type	Transistor output, passive, isolated	
Power Supply	Max. 50V DC	
Max. Load	20mA	
Isolation	100V DC maximum	

Zero Flowrate Alarm

Function	This function displays alarm on LCD in an event of zero flowrate	
Type	Visual only (on LCD screen)	



Transistor and analog outputs requires independent external power supplies to operate.



Note !

High and Low flowrate alarm functions has an additional feature of a delay before the alarm is activated (0 - 99 seconds)

SET-UP FUNCTIONS

1 Total/ Batch Total			Default value
1.1	Unit	L - m3 - UKGAL - USGAL - UKbbl –USbbl - OILbbl	L
1.2	Decimals	0 - 1 - 2 - 3	0
2 Accumulated Total			
2.1	Unit	L - m3 - UKGAL - USGAL - UKbbl –USbbl - OILbbl	L
2.2	Decimals	0 - 1 - 2 - 3	0
3 Flow Rate			
3.1	Unit	L - m3 - UKGAL - USGAL - UKbbl –USbbl - OILbbl	L
3.2	Time Period	Second - Minute - Hour	Minutes
3.3	Decimals	0 - 1 - 2 - 3	0
3.4	Calculation	per 1 - 255 pulses (Default 10)	10
3.5	Cut-off	0.1 - 999.9 seconds (Default 30)	30
4 Alarm			
4.1	Flow Alarm	Operate - Hidden - Off	Operate
4.2	Zero Flow Display	On - Off	On
4.3	Low Flow Alarm	0 (unit / time)	0
4.4	High Flow Alarm	0 (unit / time)	99999
4.5	Alarm Delay	0 - 99 seconds	0
5 Meter			
5.1	*K-Factor (Pulses per Litre)	0000.000 to 9999.999	'1' or as per factory settings
6 Analog Output			
6.1	Low Flow - 4mA	0000.000 - 9,999,999 (unit / time)	0
6.2	High Flow - 20mA	0000.000 - 9,999,999 (unit / time)	99999
6.3	Low Calibration - 4mA	0 - 9999	633
6.4	High Calibration - 20mA	0 - 9999	3214
7 Pulse Output			
7.1	Decimals	0 - 1 - 2 - 3	0
7.2	Pulse Width	0.005 - 1.000 seconds	0
7.3	Amount - Pulse per (X)	x,xxx,xxx quantity	1000
8 OTHERS			
8.1	Type	drA	drA
8.2	Software Version	03.xx.xx	03.xx.xx
8.3	Serial No.	xxxxxxx	xxxxxxx



IMPORTANT

The settings for Total, Accumulated Total and Flow rate are entirely separate. In this way, different units of measurement and decimals can be used for each e.g. gallons for total and liters for flow rate.

The K-Factor in 5.1 must be entered in pulses per litre (PPL). Entering the k-factor in pulses per gallon (PPG) will result in inaccurate readings. Refer to page 12 for detailed instruction on entering the k-factor.



***The k-factor in 5.1 MUST ALWAYS be entered in pulses per LITRE, regardless of units in 1.1, 2.1 and 3.1**

Note !

EXPLANATION OF SET-UP FUNCTIONS

1 Total/ Batch Total		
1.1	Unit	This determines the measurement unit for Total and Batch total. The following units can be selected: L - m3 - UKGAL - USGAL - UKbbl –USbbl - OILbbl
1.2	Decimals	This determines the number of digits and decimal points for total and batch total. The following decimals can be selected (for 0, 1, 2 and 3 respectively) 0000000 - 111111.1 - 22222.22 - 3333.333
2 Accumulated Total		
2.1	Unit	This determines the measurement unit for Accumulated Total. The following units can be selected: L - m3 - UKGAL - USGAL - UKbbl –USbbl - OILbbl
2.2	Decimals	This determines the number of digits and decimal points for accumulated total. The following decimals can be selected (for 0, 1, 2 and 3 respectively) 0000000 - 111111.1 - 22222.22 - 3333.333
3 Flow Rate		
3.1	Unit	This determines the measurement unit for flow rate. The following units can be selected: L - m3 - UKGAL - USGAL - UKbbl –USbbl - OILbbl
3.2	Time Period	This determines the time unit for flow rate The following units can be selected: /SEC (Second) - /MIN (Minute) - / HR (Hour)
3.3	Decimals	This determines the number of digits and decimal points for flow rate. The following decimals can be selected (for 0, 1, 2 and 3 respectively) 0000000 - 111111.1 - 22222.22 - 3333.333
3.4	Calculation	The flow rate is calculated by measuring the time between a number of pulses, for example 10 pulses. The more pulses the more accurate the flow rate will be. The maximum value is 255 pulses. Note: the lower the number of pulses, the higher the power consumption of the unit will be (important for battery powered applications). Note: for low frequency applications (below 10Hz): do not program more than 10 pulses else the update time will be very slow. Note: for high frequency application (above 1kHz) do program a value of 100 or more pulses.
3.5	Cut-off	With this setting, you determine a minimum flow requirement thresh-hold, if during this time less than XXX-pulses (setup 3.4) are generated, the flow rate will be displayed as zero. The cut-off time has to be entered in seconds - maximum time is 999 seconds (about 15 minutes).
4 Alarm (Transistor output according to the Low/ High flowrates)		
4.1	Alarm	This enables/ disables the alarm feature. The following settings can be selected: Off: Function disabled. Operate: Function enabled. Hidden: Does not display alarms on LCD.
4.2	Zero Flowrate Alarm	This function displays alarm on LCD in an event of zero flowrate On: An alarm will be generated as long as there is no flowrate. Off: No alarm Note: Zero flow alarm works only when 4.3 has a value greater than zero. Note: The alarm is visual only, there is no contact output for this alarm.

EXPLANATION OF SET-UP FUNCTIONS

4.3	Low Flowrate Alarm	Enter Low flowrate value here. An alarm will be generated as long as the actual flow rate is lower than this number. With value 0.0 this function is disabled.
4.4	High Flowrate Alarm	Enter High flowrate value here. An alarm will be generated as long as the actual flow rate is higher than this number. With value 0.0 this function is disabled.
4.5	Delay	This function allows a delay period before the alarm is activated 0 - 99 seconds.
5 METER		
5.1	*K-Factor (Pulses per Litre)	With the K-factor, the flow meter pulse signals are converted to a flow rate. The more accurate the K-factor, the more accurate the functioning of the system will be. The setting allows a K Factor with up to 3 decimal places and 4 whole numbers e.g. 1234.123 Please note that the K-Factor entered in 5.1 must be in pulses per litre (PPL). Entering the k-factor in pulses per gallon (PPG) will result in inaccurate readings. Refer to page 12 for detailed instruction on entering the k-factor.
6 Analog Output (4-20mA signal according to the flow rate)		
6.1	Minimum Flowrate	Enter here the flow rate at which the output should generate 4mA - in most applications at flow rate "zero". Note: Units will be automatically picked from sections 3.1, 3.2 and 3.3 Important: In an event if the actual flow rate goes further below than the program value, the unit will not generate less than 4mA. As an example, if 6.1 is set at 10 ltr/min and the actual flow rate goes down upto 9 ltr/min, or even lower, the unit will still generate 4mA. An easy way to tackle this is to program this value a little lower, say for example, 9.5 ltr/min, this way it can be detected that the actual flow rate is below required minimum rate.
6.2	Maximum Flowrate	Enter here the flow rate at which the output should generate 20mA - in most applications at maximum flow. Note: Units will be automatically picked from sections 3.1, 3.2 and 3.3 Important: In an event if the actual flow rate goes further high than the program value, the unit will not generate higher than 20mA. As an example, if 6.2 is set at 100 ltr/min and the actual flow rate goes high upto 101 ltr/min, or even higher, the unit will still generate 20mA. An easy way to tackle this is to program this value a little higher, say for example, 100.5 ltr/min, this way it can be detected that the actual flow rate is above required maximum rate.
6.3	Calibration/ Tuning (4mA)	When the display reaches the minimum flowrate (as defined in 6.1), the analog output should be precisely 4mA. However, this value might differ slightly due to external influences for example temperature or loop characteristics etc. In this case, 6.3 can be used to tune to 4mA precisely. Note: This is a tuning parameter and only to be used if required. Warning: Before tuning the signal, be sure that the analog signal is not being used for any application. How to Tune: Once you are in the SETUP PROG mode, ± 4 mA can be tuned to exact 4mA by incrementing/ decrementing the digits on the LC display. The tuning is directly active and immediate. Press and release 'P' and 'S' buttons simultaneously to save changes. Note: If required, the analog output can be programmed 'up-side-down'. In that case, 4mA represents the maximum flow rate and 20mA represents the minimum flow rate.

EXPLANATION OF SET-UP FUNCTIONS

6.4	Calibration/ Tuning (20mA)	<p>When the display reaches the maximum flowrate (as defined in 6.2), the analog output should be precisely 20mA. However, this value might differ slightly due to external influences for example temperature or loop characteristics etc. In this cae, 6.4 can be used to tune to 20mA precisely.</p> <p>Note: This is a tuning parameter and only to be used if required.</p> <p>Warning: Before tuning the signal, be sure that the analog signal is not being used for any application.</p> <p>How to Tune: Once you are in the SETUP PROG mode, $\pm 20\text{mA}$ can be tuned to exact 20mA by incrementing/ decrementing the digits on the LC display. The tuning is directly active and immediate. Press and release 'P' and 'S' buttons simultaneously to save changes.</p> <p>Note: If required, the analog output can be programmed 'up-side-down'. In that case, 4mA represents the maximum flow rate and 20mA represents the minimum flow rate.</p>
7 Pulse Output (Transistor output according to the accumulated total)		
7.1	Decimals	This determines the number of decimal points to be used in section 7.3
7.2	Pulse Width	<p>Range: 0.005 to 1.000 seconds (i.e. 5 milli seconds to 1 second)</p> <p>This value determines the time that the output will be active; in other words the pulse duration.</p> <p>A value 0.0 disables the whole pulse output function</p> <p>The pulse signal always has a 50% duty cycle</p> <p>Note: Care should be taken while programming this value as the frequency could go out of range and pulses could be missed.</p>
7.3	Amount - Pulse per (X)	<p>Enter here the value of (X) This setting generates ONE pulse for every (X) amount of volume passed.</p> <p>For example;</p> <p>If (X) is entered as 0.1 and the units are set in litres, the module will generate ONE pulse per every 0.1 litres. In other words, it will generate 10 pulses per litre ($1 \div 0.1 = 10$)</p> <p>If (X) is entered as 5 and the units are set in gallons, the module will generate ONE pulse per every 5 gallons. In other words, it will generate 0.2 pulses per gallon ($1 \div 5 = 0.2$)</p> <p>Note: Measurement units (e.g. Litres/ Gallons) will be automatically picked from section 1.1</p> <p>Note: Decimal points will be picked from section 7.1</p> <p>Warning: The minimum value that can be set for (X) is 0.001, with this value the module will generate ONE pulses every 0.001 units of measurement.</p> <p>Note: This function is not meant to increase the resolution or k-factor. It is advised not to exceed flow meter's k-factor.</p>



IMPORTANT

The settings for Total, Accumulated Total and Flow rate are entirely separate. In this way, different units of measurement and decimals can be used for each e.g. gallons for total and liters for flow rate.

The K-Factor in 5.1 must be entered in pulses per litre (PPL). Entering the k-factor in pulses per gallon (PPG) will result in inaccurate readings. Refer to page 12 for detailed instruction on entering the k-factor.



Note !

***The k-factor in 5.1 MUST ALWAYS be entered in pulses per LITRE, regardless of units in 1.1, 2.1 and 3.1**

TERMINAL CONNECTORS

Sensor Input		Pulse Output		Low Alarm Output		High Alarm Output		Analog output & Power Supply	
1	2	3	4	5	6	7	8	9	10
		-	+	-	+	-	+	-	+

Terminals 1 - 2 Sensor input (from flow meter)

The unit can only accept a Reed switch input, this sensor has been selected as the most common sensor and requires very little power with small effect on battery life.

The 2 position terminal block is not polarity conscious so the reed switch wires can be connected in any order.



For meter mounted displays, these terminals come connected from factory. No further connections are required by end-user.

For remote displays, Reed switch (from flow meter) to be connected by the end-user.

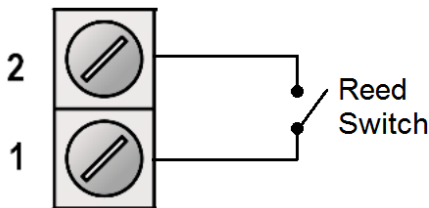

Connecting any other type of sensor could cause damage to the unit

Terminals 3 - 4 Pulse Output (Programmable)

This function transmits accumulated total. The output is transistor based - passive (requires external power)

Below is a typical connection drawing;

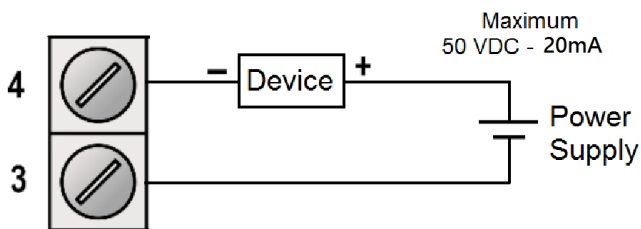

Terminals 5 - 6 Low Alarm Output (Programmable)

This function transmits alarm in an event of low flowrate. The output is transistor based - passive (requires external power)

Below is a typical connection drawing;

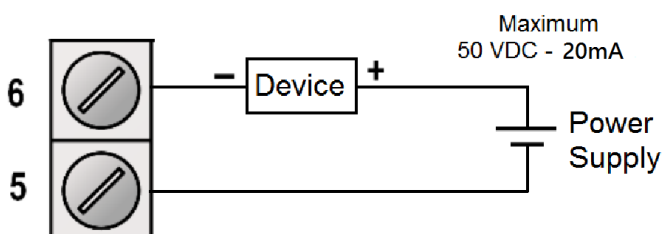

Terminals 7 - 8 High Alarm Output (Programmable)

This function transmits alarm in an event of high flowrate. The output is transistor based - passive (requires external power)

Below is a typical connection drawing;

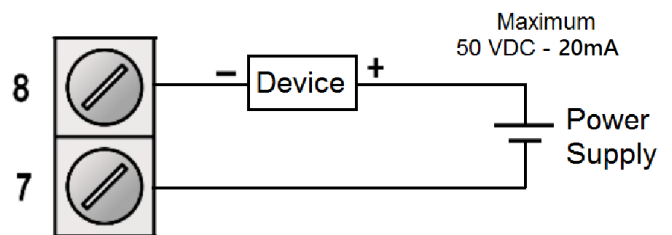

Terminals 9 - 10 Analog Output & Power Supply

Terminals 9 and 10 offers two functions;

- Analog output (Output)
- Power Supply (Input)

As Analog Output, the unit generates 4 - 20 mA proportional to the flow rate. The output is passive and loop powered.

Below is a typical connection drawing;

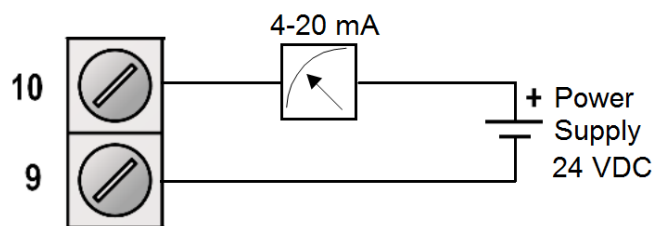

As power supply input, the unit accepts external power supply of 18 - 30VDC. Do connect the "-" to terminal 9 and the "+" to terminal 10. When power is applied to these terminals, the (optional) internal battery will be disabled / enabled automatically to extend the battery life time.

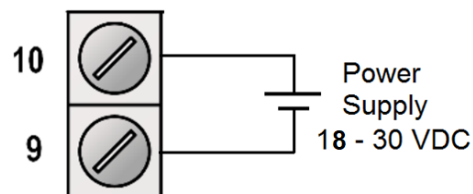

Battery is optional to use if external power is applied.

PROGRAMMING SET-UP LEVEL

This chapter describes the daily use and programming of the PRA Digital Register. The instructions are meant for users / operators.

MODES OF OPERATION

RUN mode: This is the normal operating mode. **RUN** icon on the screen represents this mode.

SETUP mode: This mode is to view settings. **SET-UP** icon on the screen represents this mode.

SETUP PROG mode: This mode is to modify settings. **SET-UP** **PROG** icon on the screen represents this mode.

FUNCTION OF THE BUTTONS

Below are the functions of 'P' and 'S' buttons during different modes of operation.

Mode	P	S	P S (Press and release simultaneously)
RUN	Toggle screens; Flowrate, Total, Batch and Accumulated total Access to Setup mode	Toggle screens; Flowrate, Total, Batch and Accumulated total	Resets Total and Batch total (Press P for NO or S for YES when prompted)
SETUP	Toggle sub-functions Access to Run mode	Toggle main-functions	Access to Setup-Prog mode (while in a sub-function)
SETUP PROG	Apply a new value to a sub-function	Apply a new value to a sub-function	Save changes

Setup mode is reached by pressing the 'P' button for 7 seconds; at which time, setup will be displayed on the LC display. In order to return to the Run mode, 'P' will have to be pressed for 3 seconds. Alternatively, if no keys are pressed for 2 minutes, the unit will exit setup mode automatically.

Setup can be reached at all times while the display remains fully operational.

ENTERING INTO SETUP MODE

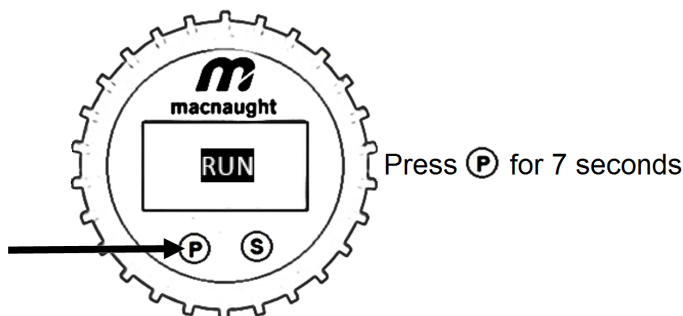

EXITING FROM SETUP MODE

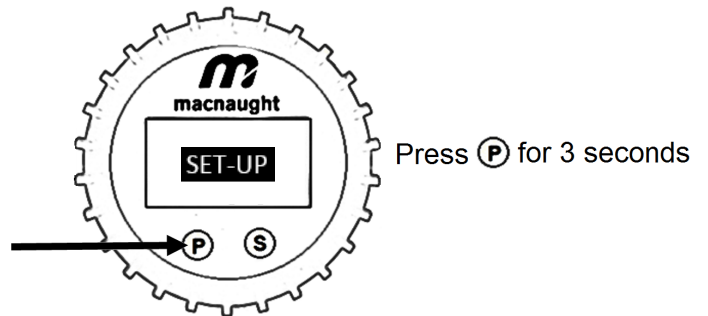

Once programming is done, visit the parameters again to make sure the changes are saved correctly.

K-FACTOR PROGRAMMING

HOW TO FIND A K-FACTOR OF YOUR METER

The K-factor could be found on either of;

- Flow meter's body
- Flow meter's test report
- Contact Macnaught providing the Serial Number of the flow meter

PROGRAMMING K-FACTOR IN THE DISPLAY

Always enter the K-factor in **pulses per LITRE (PPL)**. Entering the k-factor in pulses per gallon (PPG) will result in inaccurate readings.

Follow below steps to enter the k-factor if you are in RUN mode

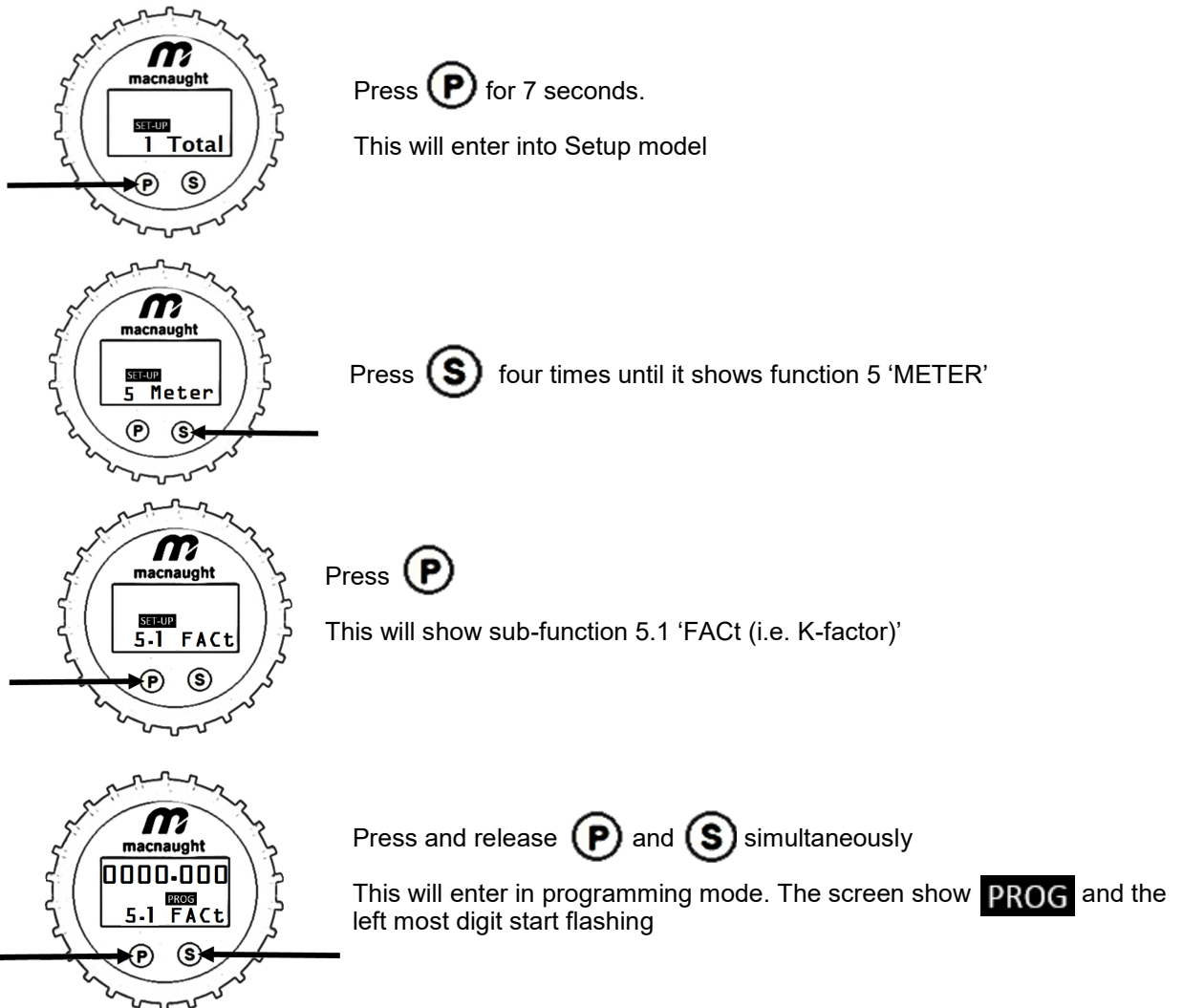

Press **P** to change the numeric value and press **S** to move to the next digit.

Once the k-factor is entered, press and release **P** and **S** simultaneously. This will save the changes.

Press **P** for 3 seconds to go to the Run mode

PPG to PPL Conversion

If the flow meter's body or test report shows the k-factor in pulses per gallon (PPG), it needs to be converted into pulses per LITRE (PPL) first.

Divide the PPG k-factor by **3.7854** to convert into PPL.

As an example: If the PPG k-factor is 136.70, the PPL k-factor is 36.112



The display accepts k-factor in pulses per LITRE only

Note! Once the programming is done, visit the parameters again to make sure the changes are saved correctly

DIMENSIONS

Display

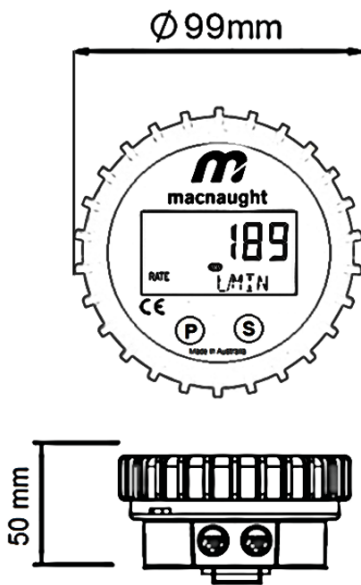

Wall Mount bracket

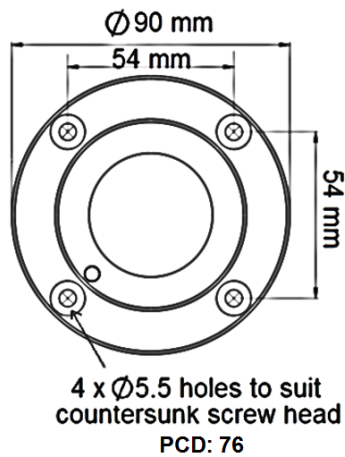

Display with Wall Mount bracket

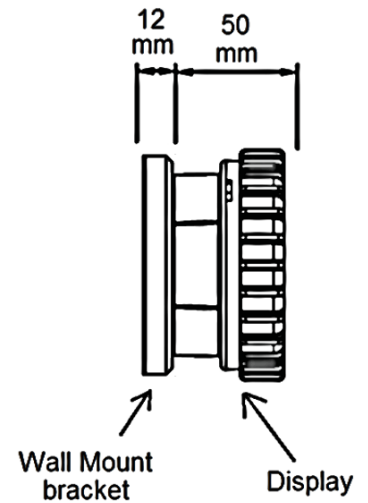

EXPLODED VIEW

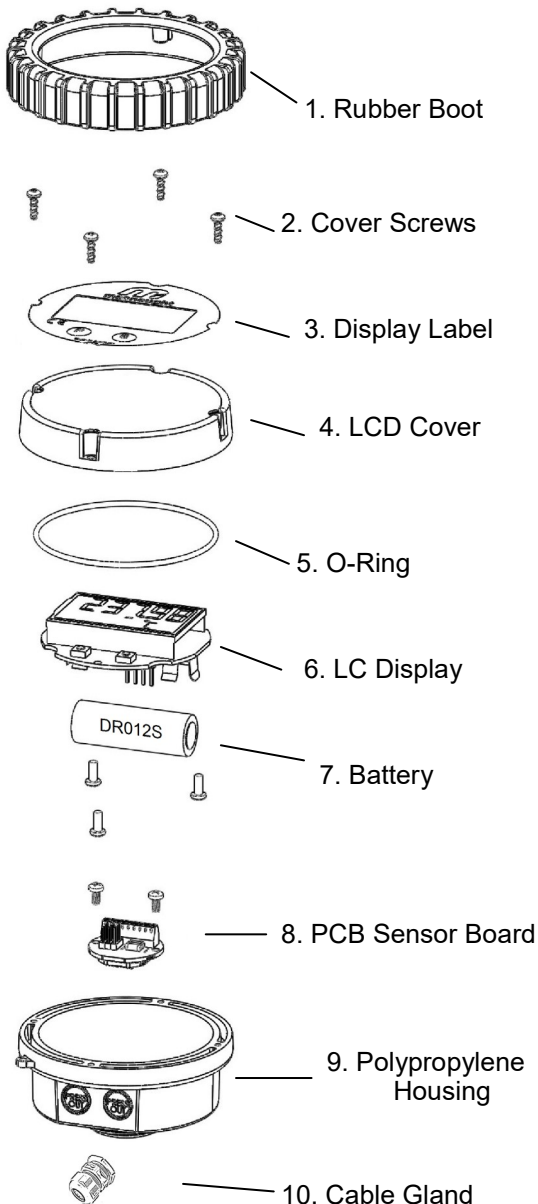

ORDERING CODE

Part Number	Item Description
MXD-ES	Display
MXS-WMB	Wall mount bracket
PRA-RMP	Display + Wall mount bracket



Wall mount bracket is required for remote installation

SERVICE KITS

Kit Part Number	Item Description	Item Number
DR012S	Battery	7
MXS-PCB-RH	PCB Sensor Board	8
MXS-PCB-PR	PCB Sensor Board	8
	PP Housing	9
MS1279S	Display Label	3
MS685S	Cable gland - M12	10
MXS-DIS-PRA	Cover Screws	2
	Display Label	3
	LCD Cover	4
	O-Ring	5
	LC Display	6
	Battery	7



PCB Sensor Board has 1 x Reed switch and 1 x Hall effect sensor as standard (unless a special board is requested)

Note!

TROUBLESHOOTING

DISPLAY IS BLANK

The battery could either be dead or not connected properly. Inspect/ replace the battery.

DISPLAY SHOWS INCORRECT READING

Check the k-factor. Make sure the decimals are taken care of. It should be in pulses per litre.

DISPLAY SHOWS NO FLOW

Check the wiring between the PCB sensor board (Item no 8) and LC display board (Item no 6). Check for loose connections and clean the terminals if required. Replace the PCB sensor board if wiring and programming are ok.

bAt LOW ALARM

This is Low Battery alarm. Replace the battery.

RPL bAt ALARM

This is the final warning of low battery. The unit will shutdown any time. Replace battery.

REPLACING THE BATTERY

The battery is located on the rear side of LC display (item no 6). This can be accessed by removing the rubber boot (item no 1) and screws (item no 2). After replacing the battery (Part no: DR012S), make sure the o-ring (item no 5) stays intact with the LCD cover. Apply a thin layer of grease to the o-ring if required. Re-install the cover, screws and boot. See illustration below;

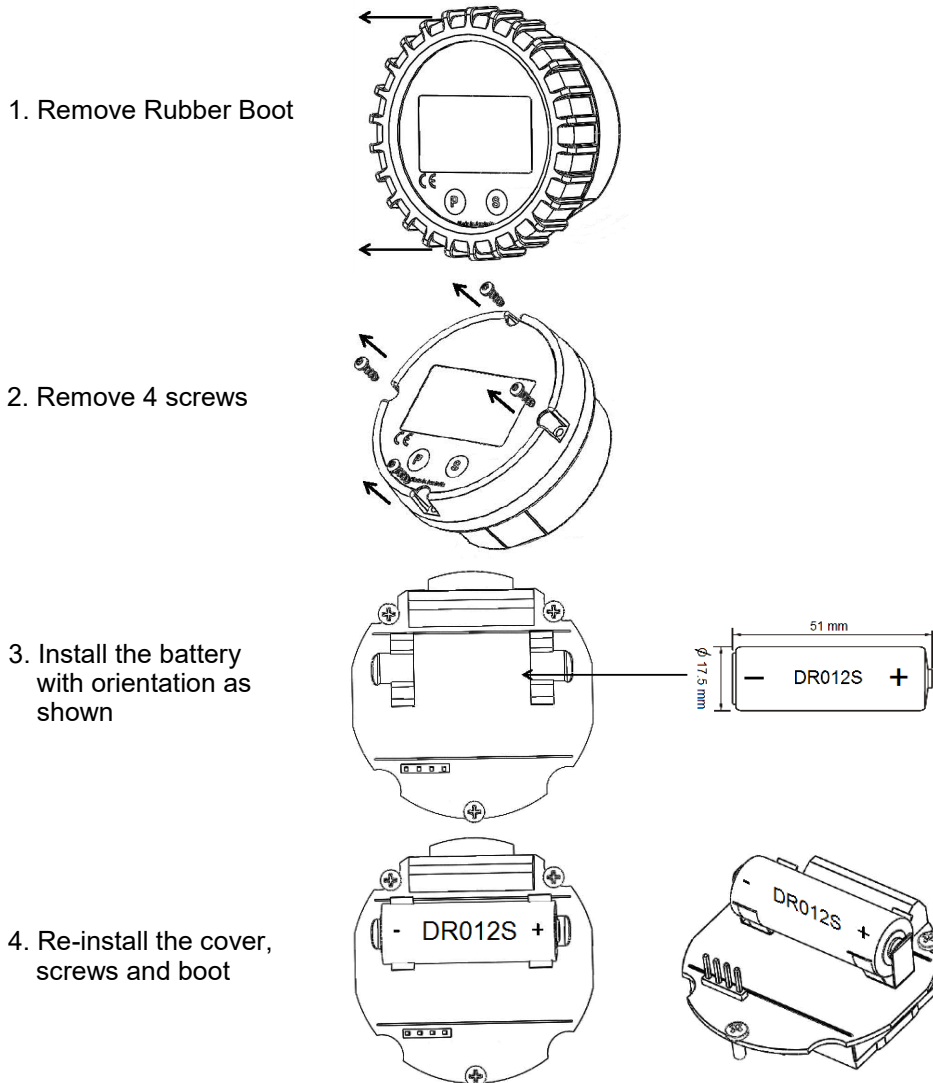

Backup of settings and running totals are stored in flash memory. The display will retain these values in an event if battery is removed for replacement.

Note !

NOTES

For your record, it is advisable to note down any changes in the parameters

PO/ Reference no: _____
 Flow Meter model: _____
 Flow meter Serial: _____

1	Total/ Batch Total		Default value	Date: _/ _/ _ Enter your settings here	Date: _/ _/ _ Enter your settings here
1.1	Unit	L - m3 - UKGAL - USGAL - UKbbl - USbbl - OILbbl	L		
1.2	Decimals	0 - 1 - 2 - 3	0		
2	Accumulated Total				
2.1	Unit	L - m3 - UKGAL - USGAL - UKbbl - USbbl - OILbbl	L		
2.2	Decimals	0 - 1 - 2 - 3	0		
3	Flow Rate				
3.1	Unit	L - m3 - UKGAL - USGAL - UKbbl - USbbl - OILbbl	L		
3.2	Time Period	Second - Minute - Hour	Minutes		
3.3	Decimals	0 - 1 - 2 - 3	0		
3.4	Calculation	per 1 - 255 pulses (Default 10)	10		
3.5	Cut-off	0.1 - 999.9 seconds (Default 30)	30		
4	Alarm				
4.1	Flow Alarm	Operate - Hidden - Off	Operate		
4.2	Zero Flow Display	On - Off	On		
4.3	Low Flow Alarm	0 (unit / time)	0		
4.4	High Flow Alarm	0 (unit / time)	99999		
4.5	Alarm Delay	0 - 99 seconds	0		
5	Meter				
5.1	*K-Factor (Pulses per Litre)	0000.000 to 9999.999	'1' or as per factory settings		
6	Analog Output				
6.1	Low Flow - 4mA	0000.000 - 9,999,999	0		
6.2	High Flow - 20mA	0000.000 - 9,999,999	99999		
6.3	Low Calib - 4mA	0 - 9999	633		
6.4	High Calib - 20mA	0 - 9999	3214		
7	Pulse Output				
7.1	Decimals	0 - 1 - 2 - 3	0		
7.2	Pulse Width	0.005 - 1.000 seconds	0		
7.3	Amount (Pulse per)	x,xxx,xxx quantity	1000		

WEEE Directive - Waste Electrical and Electronic Equipment

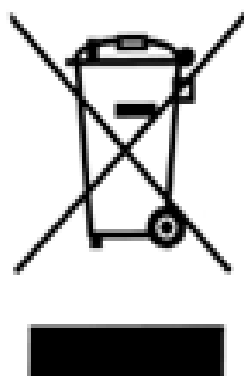

The WEEE Directive requires the recycling of waste electrical and electronic equipment in the European Union.

Whilst the WEEE Directive does not apply to some of Macnaught's products, we support its policy and ask you to be aware of how to dispose of this product.

The crossed out wheellie bin symbol illustrated and found on our products signifies that this product should not be disposed of in general waste or landfill.

Please contact your local dealer national distributor or Macnaught Technical Services for information on product disposal.



Macnaught Americas
614 South Ware Boulevard
Tampa Florida USA, 33619

T: +1813 628 5506
E: info@macnaughtusa.com
W: www.macnaughtusa.com