

## Electrical Connection Accesories

M12 Power/Output Cables & Connectors



measuring  
•  
monitoring  
•  
analyzing

807.xxx/ZUB



- Round Connectors M12 x 1:  
4, 5, and 8 pins
- Straight and 90° Angled Connectors
- Cable Lengths: 2 m (6.6 ft), 5 m (16.6 ft),  
and 10 m (32.8 ft)  
(Custom Length Available upon Request)
- Nickel-Plated Brass Coupling Nut





KOBOLD companies worldwide:

AUSTRALIA, AUSTRIA, BELGIUM, BULGARIA, CANADA, CHINA, CZECHIA, FRANCE, GERMANY, GREAT BRITAIN, HUNGARY, INDIA, INDONESIA, ITALY, MALAYSIA, MEXICO, NETHERLANDS, PERU, POLAND, REPUBLIC OF KOREA, RUSSIA, SPAIN, SWITZERLAND, THAILAND, TUNISIA, TURKEY, USA, VIETNAM

KOBOLD Instruments, Inc.  
1801 Parkway View Drive  
Pittsburgh, PA 15205  
☎ Main Office:  
1.800.998.1020  
1.412.788.4890  
✉ info@koboldusa.com  
www.koboldusa.com

M12x1 Connector with cable, According to IEC 61076-2-101

Round Connector, M12x1 Socket, Straight			
			
<b>Cable Models*</b>	807.037: 2 m (6.6 feet) 807.037/5M: 5 m (16.4 feet) 807.037/10M: 10 m (32.8 feet)	807.007: 2 m (6.6 feet) 807.007/5M: 5 m (16.4 feet) 807.007/10M: 10 m (32.8 feet)	807.008: 2 m (6.6 feet) 807.008/5M: 5 m (16.4 feet) 807.008/10M: 10 m (32.8 feet)
<b>Outer Jacket/Body</b>	PVC jacketed cable/ PUR molded body	PVC jacketed cable/ PUR molded body	PVC jacketed cable/ PUR molded body
<b>Male Insert</b>	PUR	PUR	PUR
<b>Coupling Nut</b>	Brass, nickel-plated	Brass, nickel-plated	Brass, nickel-plated
<b>O-Ring</b>	FKM	FKM	FKM
<b>Cable Diameter (OD)</b>	4.8 mm	5.3 mm	5.9 mm
<b>Wire Gauge</b>	22 AWG	22 AWG	24 AWG
<b>Number of Pins</b>	4	5	8
<b>Protection</b>	IP 67	IP 67	IP 67
<b>Voltage Rating</b>	250 V	250 V	30 VAC / 36 VDC
<b>Current Rating</b>	4 A	4 A	1.5 A
<b>Ambient Temperature</b>	-40... 194 °F	-40... 194 °F	-40... 194 °F

Round Connector, M12x1 Socket, Angled			
			
<b>Cable Models*</b>	807.037/90D: 2 m (6.6 feet) 807.037/90D5M: 5 m (16.4 feet) 807.037/90D10M: 10 m (32.8 feet)	807.007/90D: 2 m (6.6 feet) 807.007/90D5M: 5 m (16.4 feet) 807.007/90D10M: 10 m (32.8 feet)	807.008/90D: 2 m (6.6 feet) 807.008/90D5M: 5 m (16.4 feet) 807.008/90D10M: 10 m (32.8 feet)
<b>Outer Jacket/Body</b>	PVC jacketed cable/ PUR molded body	PVC jacketed cable/ PUR molded body	PVC jacketed cable/ PUR molded body
<b>Male Insert</b>	PUR	PUR	PUR
<b>Coupling Nut</b>	Brass, nickel-plated	Brass, nickel-plated	Brass, nickel-plated
<b>O-Ring</b>	FKM	FKM	FKM
<b>Cable Diameter (OD)</b>	4.8 mm	5.3 mm	5.9 mm
<b>Wire Gauge</b>	22 AWG	22 AWG	24 AWG
<b>Number of Pins</b>	4	5	8
<b>Protection</b>	IP 67	IP 67	IP 67
<b>Voltage Rating</b>	250 V	250 V	30 VAC / 36 VDC
<b>Current Rating</b>	4 A	4 A	1.5 A
<b>Ambient Temperature</b>	-40... 194 °F	-40... 194 °F	-40... 194 °F

\* Custom length available upon request

M12x1 Round Terminal

M12x1 Round Terminal Exploded View

Round Terminal, M12x1 Socket, Straight		
<b>Model</b>	ZUB-KAB12D500	ZUB-KAB12D800
<b>Way of Connection</b>	M12 Thread	M12 Thread
<b>Male Insert</b>	PBT / PA66	PA
<b>Coupling Nut</b>	PA66	Brass, nickel-plated
<b>Cable Diameter (OD)</b>	4 - 6 mm	6 - 8 mm
<b>Cross Section of Wire</b>	Max. 0.75 mm <sup>2</sup>	Max. 0.5 mm <sup>2</sup>
<b>Number of Pins</b>	5	8
<b>Protection</b>	IP 67	IP 67
<b>Voltage Rating</b>	60 V	30 V
<b>Current Rating</b>	4 A	2 A
<b>Ambient Temperature</b>	-40... 185 °F	-13... 185 °F

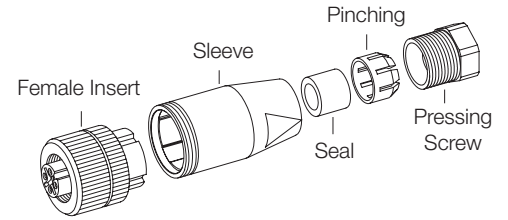

Pin Assignment and Wire Color

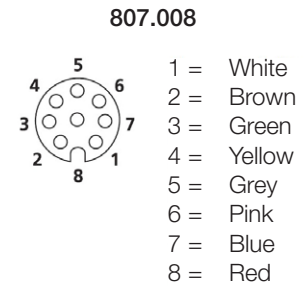
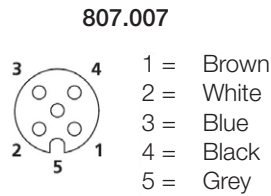
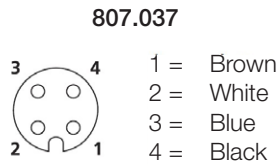

Dimensions mm [inches], M12x1 Connector with cable

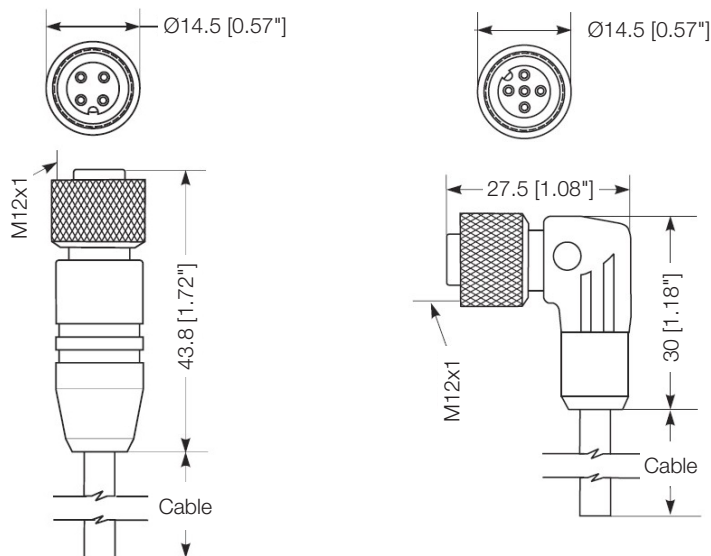

No responsibility taken for errors; subject to change without prior notice.