

HIGH-PRESSURE-CALIBRATOR

STANDARD- AND FULL-VERSION



**INCLUDED IN DELIVERY:
HIGH PRESSURE CALIBRATOR
STANDARD-VERSION**

- 1 Calibrator
- 1 Carrying Case
- 1 Test-Unit Adapter G 1/4" / G 1/2"
- 1 Test-Unit Adapter G 1/4" / G 1/8"
- 1 Spare Battery (3,6 V)
- 1 Allen Wrench
- 1 Manual
- 1 Test Certificate

... in addition for version with

Logger-Option:

- K101-Cable (RS 232)
- 2 Program Discs:
 - Logger Windows
 - Logger MS-DOS

**INCLUDED IN DELIVERY:
HIGH PRESSURE CALIBRATOR
FULL-VERSION**

- 1 Calibrator
- 1 Carrying Case
- 1 Test-Unit Adapter G 1/4" / G 1/2"
- 1 Test-Unit Adapter G 1/4" / G 3/8"
- 1 Pressure Switch Adapter
- 1 Adapter (4...20 mA / 0...20 mA)
- 1 Adapter (0...10 V / 0...20 V)
- 1 Mains Adapter
- 1 Spare Battery (3,6 V)
- 1 Allen Wrench
- 1 Manual
- 1 Test Certificate

... in addition for version with

Logger-Option:

- K101-Cable (RS 232)
- 2 Program Discs:
 - Logger Windows
 - Logger MS-DOS

LIST OF CONTENTS:

Outline Drawing	1	Executing Storage of Measured Values	12
		– REC-Mode	
General Description	2		
		Measuring the Linearity*	13*
Operating the Calibrator	3	– LIN-Mode*	
– Turn-On			
– Connecting Test-Units		Calculating the Linearity*	14*
– Executing Functions and Commands		– LIN-Mode*	
– Pressure Generation			
– Turn-Off		Adjusting the Display-Resolution	15
		– RESO-Mode	
Description of the Functions	4		
		Permanently Setting new Zero Reference	15
Measuring Mode	5	– ZERO-Mode	
– MANO-Mode			
		Data Transfer to PC	16
Temporarily Setting new Zero Reference	6		
– TARA-Mode		Maintenance	17
		– Priming the Pressure System	
Selection of Pressure Unit	6	– Testing of Battery Capacity	
– UNIT-Mode		– Battery Change	
		– Restarting the Calibrator	
Preparing the Leak-Test	7	– External Supply of Test-Units	
– LEAK-Mode		– Overflow/Overpressure Limit	
		– Service	
Executing the Leak-Test	8		
– LEAK-Mode		Operating Guide/Functions	18
Testing of Pressure Switches*	9*	Technical Data	19
– PST-Mode*			
		Declaration of Conformity	20
Preparing Storage of Measured Values	11		
– REC-Mode			

OUTLINE DRAWING

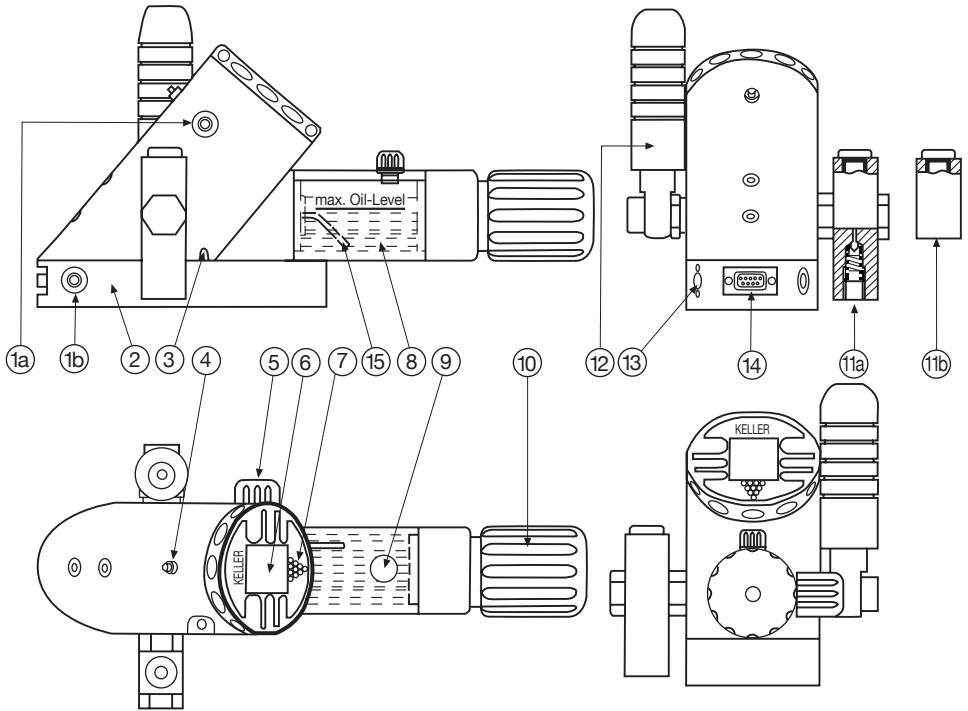

- | | |
|--|---|
| <ul style="list-style-type: none"> 1a) Connector for RS 232 Output (Standard Version) 1b)* Connector for RS 232 Output (Full-Version) 2) Instrument Base (with battery compartment*) 3)* LED-Diode 4) HOLD-Key (H-Key) 5) Shut-off Valve 6) Display 7) Function-Key (F-Key) 8) Oil Chamber 9) Oil Refill Screw 10) Oil Screw Compressor | <ul style="list-style-type: none"> 11a) Outlet Pressure Port (G 1/4", female) with Hexagon Plug (200 bar and 350 bar Calibrator with Overpressure Valve) 11b) Outlet Pressure Port (G 1/4", female) with Hexagon Plug (700 bar Calibrator without Overpressure Valve) 12) Priming Pump 13)* Input Plug for external Power Supply to Transmitter/Switch under Test 14)* Electrical Connection for Test-Unit Adapters (Transmitters or Pressure Switches) 15) Return Pipe |
|--|---|

* Full-Version only

High-Pressure-Calibrator Ranges: 200 bar, 350 bar, 700 bar (Sealed Gauge)

The calibrator combines a number of functions and performance features. Please take your time reading this manual thoroughly prior to setting the calibrator into operation. The safety instructions on page 17 are meant to enhance your safety and to maintain the functions as well as the accuracy of the calibrator and its internal sensor.

The instrument is battery powered, thus very well suited for outdoor use.

The calibrator itself is powered by a 3,6 V battery. Test-units (transmitters or electronic switches) can either be powered by the internal 9 V batteries or external power supply.*

The high pressure calibrator generates pressure with both the integrated priming pump and the oil screw compressor. The pressure can be fine adjusted.

The high technology integrated in this instrument allows it to measure precisely both the pressure generated and the output signal of a test-unit connected.

Thus, test-units can be measured and their characteristics can exactly be documented.

The calibrator has an internal memory for recording data. It can either be filled with the linearity measurements (function $L(N)$)*, the switching points of a pressure switch (function P_{ST})* or with continuously measured recordings. This data can later be transferred to a PC for evaluation via RS 232 serial interface.

The calibrator is operated with the function key (F-key), marked by a pointed triangle.

An additional key, the HOLD-key, will freeze the display at any time during operation.

TURN-ON

The calibrator is turned on by pressing the function key once.

CONNECTING TEST-UNITS*

Adapter:

Included in the delivery of the calibrator are different test-unit adapters, one for each of the following transmitter types:

- 4...20 mA / 0...20 mA transmitter
- 0...10 V / 0...20 V transmitter
- Pressure switch

Plug the test-unit adapter into socket 14.

ELECTRICAL CONNECTION OF TEST-UNIT*

Select the correct adapter. Wire the transmitter/switch under test to the adapter. Check that polarity is observed and that good connections are made.

PRESSURE CONNECTION FOR THE TEST-UNIT**

Your test-unit can be connected with the calibrator via the pressure connection 11a resp. 11b.

PRESSURE GENERATION

Attention: To avoid an overpressure within the oil chamber, the oil refill screw (9) must be open when operating the calibrator!

Generate pressure with the priming pump (12) up to approx. 10 bar.

Increase or reduce pressure with screw compressor (10).

DECREASING THE PRESSURE

- 1) To return pressure to zero, **completely** screw back compressor (10).
- 2) Open shut-off valve (5).

Do not open (5) when system is under high pressure! (Especially when using an external pressure source, damage/injury may result).

If you are not able to reach the desired pressure, read the chapter "Maintenance" on page 17 on how to completely prime the pressure system.

EXECUTING FUNCTIONS AND COMMANDS

Read the following chapter to get acquainted with the functions.

TURN-OFF

Press the function key until the command OFF appears on the display. Release the key immediately and the instrument turns off.

** To avoid leakage and damage of the check valve, the test-unit has to be cleaned prior to connecting it to the calibrator.

For a better understanding, the operating elements are described again:

FUNCTION-KEY (F-Key)

The function key on the front of the instrument, marked by a pointed triangle, serves to operate the instrument.

HOLD-KEY (H-Key)

The HOLD-Key, integrated in the back of the instrument housing, freezes the values during the MANO-Mode. It has additional functions in other modes (see following pages).

COMMAND STRUCTURE

When keeping the F-Key pressed, the functions EXE, OFF, MANO, TARA, UNIT, LEAK, PST*, REC, LIN*, ZERO, RESO and ascending numbers appear successively on the display. Releasing the F-Key at a displayed function activates and leads into the function. This cycle (constantly pressing the F-Key and letting it go at a desired function) is called **activation** (e.g. to activate MANO --> Press F-Key until display shows MANO --> Release the F-Key).

Within specific functions, the F-Key can execute additional commands (EXE, STEP, RESET).

Activating OFF turns off the instrument. When starting the instrument again, the display will automatically lead into the function from which the instrument was previously turned off.

Activate MANO if normal operation is desired.

EXE: In MANO-Mode: To reset peak- and trough-pressure.

OFF: To turn off the instrument.

MANO: To display the actual pressure generated, the units, peak- and trough pressure.

TARA: To set a new, *volatile* reference for the zero point (Tare).

UNIT: To display the pressure in different units (BAR, PSI, kPA, MWC...).

LEAK: To measure the pressure changes over a programmable time.

PST*: To test pressure switches.

REC: To record the measured values in programmable intervals.

LIN*: To determine the linearity of a test-unit.

RESO: To reduce the resolution by factor 10 or to return to the original resolution.

ZERO: To write a new zero point into the *non-volatile* memory.

28, 29... Ascending numbers (have no function).

The MANO-Mode is the standard mode of the calibrator. In this mode, the calibrator shows on the upper display the actual pressure generated. The smaller displays below indicate the peak and trough values. The measured values on the smaller displays always appear with a reduced resolution. Activating EXE resets the peak- and trough values, meaning that they are reset to the actual pressure.

Full-Version only: If a transmitter is connected, the display automatically indicates the value of the transmitter in mA or V on the lower left display. The lower right display shows the temperature.

Pressing the HOLD-Key (H-Key) freezes the measured values. The actual pressure is now shown on the lower right display. Pressing the H-Key again leads back into the MANO-Mode with the peak- and trough values reset to the actual pressure (same as EXE).

MANO-MODE

DISPLAY WITHOUT TRANSMITTER

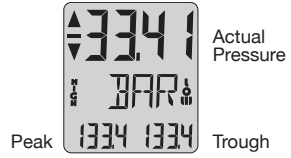
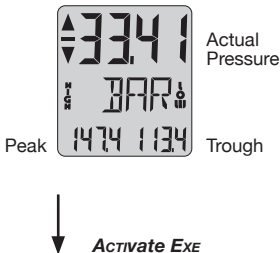

↓
Press H-Key

HOLD-MODE



↙
**With H-Key back to
MANO-Mode**

MANO-MODE

DISPLAY WITH TRANSMITTER (Full-Version only)

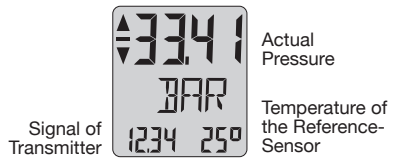

↓
Press H-Key

HOLD-MODE

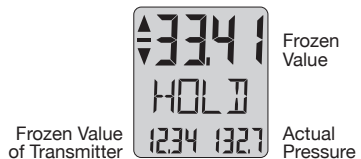

▲ = Is being read as a "1" between 100 bar and 200 bar when displaying with increased resolution --> 133.41 bar

The TARA-Mode serves to set a temporary zero reference. Unlike to the ZERO-Mode, this new zero reference will not remain after the instrument has been turned off.

Activate TARA:



Actual Pressure



MANO-MODE



With the command EXE the new zero is being determined and stays as a reference until a new TARA is being executed or until the instrument is turned off.

The program returns to the MANO-Mode.

The UNIT-Mode allows the selection of one of four pressure units.

Activate UNIT:



Activate MANO to return to the MANO-Mode with the new selected unit.

Please note that, depending on pressure range, the units can differ from the above.

The LEAK-Mode serves to measure a pressure change over a programmable time. The unit to be tested has to be connected to the calibrator.

Setting the Test Time:

Activate LEAK:



Second digit is flashing,
EXE increases digit...
With STEP to next digit.

When the test time is set, activate PREP. The display is now back in PREP-Mode.



Actual
Pressure



Activate SEL



Flashing. EXE changes
to hr (hours),
EXE again to day.



Activate STEP



First digit is flashing, EXE
increases digit.
With STEP to next digit.



Activate STEP



The test time is now programmed (35:00). The start of the leak-test is described on the next page.

Start of the LEAK-Test:

After setting the test time, the display is in the PREP-Mode:



Actual
Pressure



**Press H-Key
or activate RUN**

After the test, the measured values are frozen in. Activate PREP to return to the PREP-Mode from the END display.

A new test can be started as follows (also when measurements are running).

- Press the H-Key or
- Activate RUN with the F-Key

At any time, you may return to the MANO-Mode by activating MANO.

Activating MANO interrupts a running leak-test.

During Test:



Pressure at
test start

After Test:

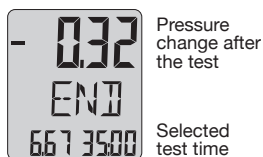

Pressure at
test start

PST-MODE

(FULL-VERSION ONLY)

This mode allows the testing of mechanical and electronic switches. The display always indicates the switch status and the switch pressure points. The actual status (OPEN/CLOSE) and the switch pressure are being displayed with each change of status in the pressure switch.

The actual pressure is always indicated on the top display.

All switch points are being recorded and can be written into a PC and displayed on the screen (only with Logger-Option). Activating END followed by the activation of another function quits the PST-Mode and leads into the new selected function.

Activate Pst:



Actual Pressure

Connect pressure switch.



**Press H-Key
or activate Run**
(recording of switch pressure points starts)

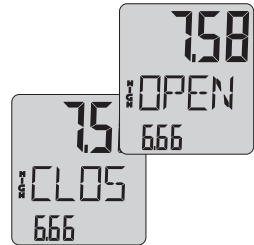
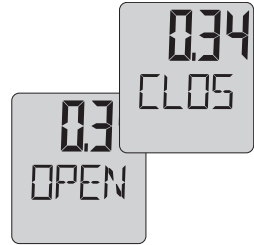

The pressure switch closes.
The status and the switch pressure are displayed.

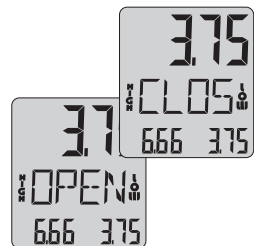

The pressure switch opens.
The status and the switch pressure are displayed.



Press H-Key
(recording of switch pressure points ends)

PST-MODE

(FULL-VERSION ONLY)



In the STOP mode, a new switch can be connected without influence on status or recording.



Press H-Key



New start of measurement

Back to the MANO-Mode:

Activate END -->



Activate MANO

Note:

The test measurements can be started in each position of the connected pressure switch.

The first point is automatically written into the small right display (Low) if the measurement started at high pressure and the pressure switch was switching at a lower pressure.

An increase of pressure from this status writes the new switch point automatically into the small left display (High). The pressure decreasing again results in writing the new switch point into the Low again.

This allows various switch points to be registered from the same pressure switch. They are being recorded in the memory in pairs.

Activating RUN can start a new measurement at any point of the function.

In the REC- (or Record) Mode, the measured values can be stored. The number of measurements and the interval (in minutes and seconds) are programmable.

Subsequently, one storage cycle over the number of measurements is called a “recording”.

Full-Version only:

If no transmitter is connected, only the actual pressure will be stored when recording. When recording with a connected transmitter, three values will be stored per recording: Actual pressure, signal of transmitter and temperature. Please note that when recording with three values per recording, the storage requirements are tripling (1000 measurements with three values each lead to 3000 measuring values).

Adjustment of the Storage Parameters:

Activate REC:

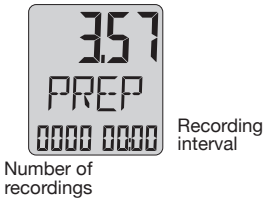

↓ **Activate SEL**



First digit is flashing;
EXE increases digit.
With STEP to next digit.

↓ **Activate STEP**



Second digit is flashing;
EXE increases digit.
With STEP to next digit...

After setting the number of recordings, set the recording interval in min:sec in the same way. The adjustment of the storage parameters can be terminated by activating PREP.

The display is now in the PREP-Mode. The newly set storage parameters are shown in the display:

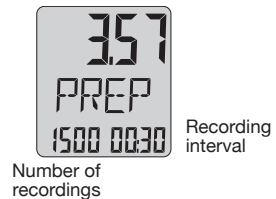

– The start of the recording is described on the next page.

Start of the Recordings:

After the adjustment of the storage parameters, the display is in the PREP-Mode:

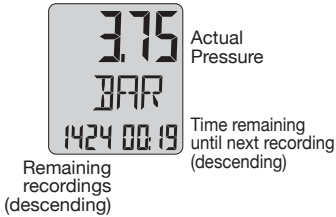
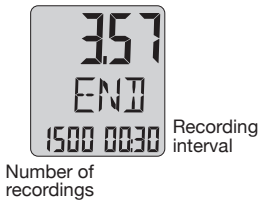
**During Recording:****After Recording:**

The display END indicates the end of the recording. Activate PREP to return to the PREP-Mode from the END display.

At any time, a record can prematurely be terminated by activating RES.

In the REC-Mode you may also display the temperature.

Pressing the H-key at PREP display indicates the temperature on the lower right display.

To quit the REC-Mode, activate PREP, followed by the activation of any function.

LIN-MODE

(FULL-VERSION ONLY)

The linearity mode allows the determination of the linearity error of a test-unit. The linearity is calculated as terminal linearity, that means, the line is set between the first and the last measuring point.

The linearity error is indicated as a percentage of the span between the first and the last measuring value. Maximal 10 linearity values are allowed.

After having activated LIN, activating the command SAVE writes the actual values of the reference pressure and of the test-unit into the memory. This cycle can be quit by activating SAVE.

The Linearity Test:

Activate LIN:



Actual Pressure

Number of measuring point

Output signal of test-unit



Press H-Key or activate SAVE
Values are written into the memory



New number indicates: Values are registered



Pressure increase >>>

Press H-Key or activate SAVE



Second value is registered

Calculating the Linearity:

After registration of the measuring points, the calculation of the linearity is initiated with the command **CALC**.

After the calculation, the pressure and measuring point with the highest linearity error are shown:

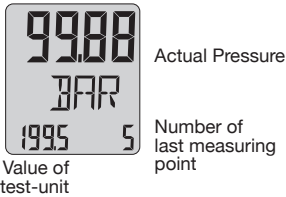

↓
Activate CALC

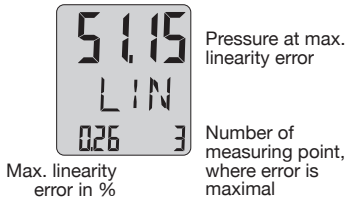

From this position, the linearity of all other measuring points can be called upon:



↓
Activate EXE

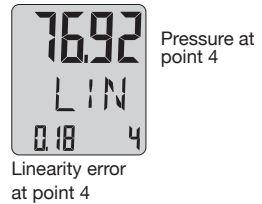

↓
Activate EXE to go to points 5, 1, 2...

↓
Activate PREP for new linearity test

RESO-Mode:

The activation of RESO reduces the resolution by factor 10 or sets the display back to the original resolution.



↓
Activate RESO



↓
Activate RESO

**ZERO-Mode:**

Ambient pressure changes, dependency of position or the influence of temperature can result in zero shifts.

These shifts can be permanently corrected as follows.

Activate ZERO:

Actual
Zero

↓
Activate EXE



The new zero is set and permanently stored. This zero will be maintained when turning off the instrument.

The programme automatically returns to the MANO-Mode after setting the new zero.

DATA TRANSFER TO PC

(only with Logger-Option)

In order to transfer the data from the calibrator into a PC, a special cable (K101) and a special software is required. The transfer of the data is accomplished over a RS 232 serial interface connected to the calibrator via socket 1a or 1b.

LOGGER-SOFTWARE

This software serves to transfer the data to a PC, offering many further processing possibilities of the read-out data.

The LOGGER-Software meets all the requirements of modern Windows-Software:

- Graphical Display
- Tabulated Display
- Export into other Windows-Programs
- Storage into Files

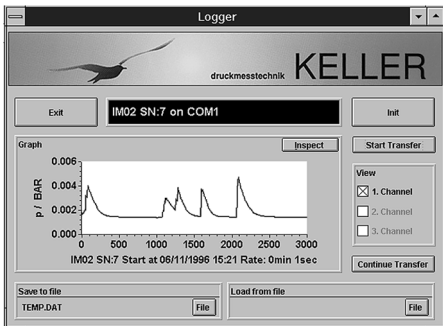

The transfer of the data always starts at the last recording and can be extended to read out the entire memory. The memory may be read out as many times as needed.

TIME ALLOCATION

After each recording (LIN*, PST*, REC), the calibrator writes the status of the calibrator's time meter into the memory. When transferring, the absolute time-axis is calculated from the time set in the PC, the time meter of the calibrator and the recorded time. The calibrator should therefore not be turned off between the recording and the transfer.

During the recording process, five additional recording locations for the storage of time are used for each complete recording cycle.

MEMORY

Each of the functions LIN*, PST* and REC fill the memory. New data is always stored after the last recorded value, continuously filling the memory. Since these instruments feature a ring-memory, new data will only overwrite the oldest data. This ensures that the maximal amount of the most recent data is always at your disposal when the memory is full.

TOTAL STORAGE LOCATIONS

Standard: 900

Extended: 8000

(only with memory option)

* Full-Version only

PRIMING THE PRESSURE SYSTEM

Completely release pressure. Open valve (5) and screw (9). If the pressure is not zero, activate first TARA and then EXE.

Purge air from the system by repeatedly pressing the priming pump (12). The system is free of air when air bubbles cease coming out of the return pipe (15). Close shut-off valve (5).

BATTERIES

The calibrator houses a 3,6 V battery behind the display for the calibrator functions, and two 9 V batteries* for the test-unit supply.

3,6 V BATTERY

The calibrator will not indicate a battery low. If the display starts to fade, it is an indication that the battery charge is weakening. At this point, we recommend changing the battery. The batteries can be acquired from KELLER.

3,6 V BATTERY CHANGE

Turn the display ring beyond the limit stop. It will detach from the main housing. Disconnect the battery connections and remove the old battery. Insert the new battery. Set the display ring back in place.

2 x 9 V BATTERY CHANGE*

The LED diode is also an indicator for the test-unit supply. The batteries have to be changed if the LED does not illuminate when connecting your test-unit. Open the battery compartment of the instrument base and change the batteries.

RESTARTING THE CALIBRATOR

If it should occur that the programme is locked, meaning that the instrument does not react anymore when operating the F-Key, in most cases an interruption of the power supply can activate the instrument again.

Just follow the procedure described for the 3,6 V battery change and disconnect the instrument from the battery for at least 20 seconds. After reconnection, start the instrument again.

EXTERNAL TEST-UNIT SUPPLY*

An external supply can be plugged to connection (13), e.g. 13 V for KELLER transmitters.

The adapter plug, included in the delivery, automatically interrupts the 9 V battery supply.

When testing mechanical switches, the mains adapter should be used.

OVERFLOW/OVERPRESSURE LIMIT

The calibrator displays the pressure until 5 to 10% above the indicated pressure range. If this range is being exceeded, the display indicates "OVFL" (overflow). Do not increase the applied pressure any more!

If the pressure exceeds the indicated pressure range by more than 20%, the sensor may be destroyed.

SERVICE

KELLER pressure calibrators are maintenance-free. The cycle for recalibration depends on the application conditions. Recommended recalibration cycle: 1 year.

* Full-Version only

TURN-ON

The calibrator is turned on by pressing the function key (7) once.

FUNCTIONS AND COMMANDS

The functions and commands are activated with the F-key (activation: release F-key when desired command is shown on display).

PRESSURE GENERATION

Generate pressure with the priming pump (12) up to approx. 10 bar. Increase or reduce pressure with screw compressor (10).

DECREASING THE PRESSURE

Completely screw back compressor (10).

Open shut-off valve (5).

Do not open when system is under high pressure! (Especially when using an external pressure source, damage/injury may result)

CONNECTING TRANSMITTERS*

Plug in transmitter adapter. Internal supply is OK, when LED (3) lights. Connect the transmitter. The lower left display now indicates the output of the transmitter in mA or V.

CONNECTING PRESSURE SWITCHES*

Plug in the pressure switch adapter. Internal supply is OK, when LED (3) lights. Connect the pressure switch to adapter.

FUNCTIONS

MANO:

Display of pressure, max. and min. pressure. EXE resets peak- and trough values.

With test-unit connected*: Display of actual pressure, transmitter signal and temperature.

HOLD:

Activated with the H-Key; display of pressure and of test-unit signal are frozen and the actual pressure is indicated on lower right display.

Pressing H-Key again leads back to MANO-mode with max./min. values reset.

TARA:

Sets the pressure display to zero (Tare).

Activate TARA, execute with EXE (page 6).

UNIT:

Setting the pressure units (page 6).

LEAK:

Pressure changes over time (page 7/8).

PST*:

Testing of pressure switches (page 9/10).

REC:

Recording of measured values (page 11/12).

LIN*:

Determining test-unit linearity (page 13/14).

RESO:

Reducing/increasing resolution (page 15).

ZERO:

Setting a new permanent zero (page 15).

* Full-Version only

TECHNICAL DATA

Total Accuracy of displayed Pressure ⁽¹⁾	±0,1% FS (Full Scale), from 0...50 °C
Total Accuracy of displayed Test Unit Signal	±0,1% FS ±1 Digit
Resolution of Display	
200 bar Calibrator	10 mbar
350 bar Calibrator	100 mbar
700 bar Calibrator	100 mbar
Overpressure	FS + 10%
Selectable Pressure Units	BAR / PSI / kPA / mWC (others on request)
Measurement Cycle	2 Measurements per Second
Displayed Temperature	Temperature of Reference Sensor in °C
Storage Temperature	-20...60 °C
Operating Temperature	0...50 °C
Compensated Temperature Range	0...50 °C
Air Humidity	5...95% Relative Humidity
Memory	900 Storage Places (8000 optional)
Power Supply of Calibrator-Electronics	Lithium-Battery 3,6 V (not rechargeable)
Lithium-Battery-Life	> 200 Days at continuous operation
Power Supply of Transmitter	2 x 9 V Batteries (not rechargeable)
Total Oil Chamber Volume	57 ml
Oil Type	Type HLP 22 BP
Dead Volume	7,7 ml
Total Weight, including Batteries	≈ 3,9 kg
Dimensions (L x W x H)	315 (337) x 153 x 205 mm
Protection (only Standard)	IP 65

⁽¹⁾ Includes linearity, repeatability, hysteresis, temperature error and resolution of the display

DECLARATION OF CONFORMITY

Herewith we declare, that the following products or product range



HIGH PRESSURE CALIBRATORS
Standard- and Full-Version
according to drawing 80139.3

meet the basic requirements for the electromagnetic compatibility, which are established in the guidelines of the European Community (89 / 336 / EWG).

This declaration is valid for High Pressure Calibrators, Standard- or Full-Version, of which a drawing, marked with the CE sign, exists, and which are produced according to this drawing. This explanation has no validity without such a drawing.

As criteria for the electromagnetic compatibility, the following norms are applied:

EN - 61000 - 6 - 1
EN - 61000 - 6 - 3

This declaration is given for the manufacturer

Keller AG für Druckmesstechnik
St. Gallerstrasse 119
CH - 8404 Winterthur

in full responsibility by

Keller GmbH
Schwarzwaldstrasse 17
D - 79798 Jestetten

Jestetten / May 22, 2006

A handwritten signature in black ink, appearing to read 'H.W. Keller', written in a cursive style.

H.W. Keller
Geschäftsführer
with legally effective signature

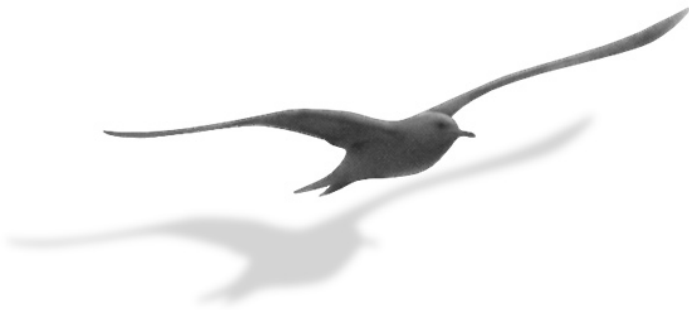

www.keller-druck.com