



dew.IQ

Moisture analyzer

User's manual

910-295 Rev. C

dew.iQ

Moisture analyzer

User's manual

910-295 Rev. C
October 2017



[no content intended for this page]

Contents

Chapter 1. Features and capabilities

1.1	Introduction	1
1.2	Electronics	1
1.3	Probes	2

Chapter 2. Installation

2.1	Introduction	3
2.2	Selecting the analog recorder output	4
2.3	Mounting the electronics	8
2.3.1	Panel mount	8
2.3.2	Rack mount	12
2.3.3	Bench mount	13
2.3.4	Wall mount	14
2.4	Mounting the sample system	15
2.5	Installing the probe	16
2.6	Wiring the system	18
2.6.1	Connecting an M series probe	21
2.6.2	Connecting an IQ probe	24
2.6.3	Connecting the analog output	27
2.6.4	Connecting the alarm relays	27
2.6.5	Connecting the input power	30

Chapter 3. Initial setup and operation

3.1	Using the dew.IQ	35
3.1.1	Starting up	36
3.1.2	Accessing the menus	36
3.1.3	Entering numeric values	37
3.2	Setting up the display	38
3.2.1	Selecting the primary units	38
3.2.2	Setting the decimal places	39
3.2.3	Adjusting the contrast	39
3.3	Setting up the analog output	40
3.3.1	Entering the output menu	40
3.3.2	Selecting the output units	40
3.3.3	Selecting an output type	41
3.3.4	Changing the output span	41
3.3.5	Changing the output zero	42
3.3.6	Testing the output	43
3.3.7	Trimming the output	44
3.4	Setting up the measurement alarms	46
3.4.1	Selecting an alarm output	46
3.4.2	Selecting the alarm status	47
3.4.3	Selecting the alarm units	47

3.4.4	Selecting an alarm type	48
3.4.5	How the alarm types work	49
3.4.6	Setting the alarm span	50
3.4.7	Setting the alarm zero	50
3.4.8	Testing the alarm relays	51
3.5	Viewing system information	52
3.5.1	Checking the ID	52
3.5.2	Checking the status	53
3.5.3	Checking the software version	53
3.5.4	Checking the probe	54
3.5.5	Checking the wiring	55
3.6	Locking the main menu	55

Chapter 4. Data logging

4.1	Checking the data log status	57
4.2	The log settings menu	57
4.3	Setting the log units	57
4.4	Setting the log interval	59
4.5	Setting a log field separator	59
4.6	Setting the log status flags	60
4.7	Managing log files	61
4.7.1	Creating a new log	61
4.7.2	Pausing or closing a log	62
4.7.3	Resuming a log	63
4.7.4	Viewing the log directory	63
4.7.5	Deleting log files	64
4.8	Ejecting the MicroSD card	65
4.9	Viewing data log files	66

Chapter 5. Programming the settings menu

5.1	Entering your passcode	67
5.2	Setting the fault alarm	68
5.2.1	Setting the fault alarm status	68
5.2.2	Setting the fault alarm type	69
5.2.3	Setting the fault alarm options	70
5.2.4	Testing the fault alarm	70
5.3	Setting AutoCal	70
5.4	Entering calibration data for an M series probe	72
5.4.1	Selecting the number of points	72
5.4.2	Selecting the calibration point	73
5.4.3	Entering the MH calibration	73
5.4.4	Entering the dew point calibration	74
5.5	Viewing calibration data for an IQ probe	75
5.5.1	Selecting the calibration point	73
5.5.2	Reading the FH value	76
5.5.3	Reading the DP value	76

5.6 Reading and setting the calibration references	77
5.6.1 Setting the calibration high reference	78
5.6.2 Setting the calibration low referencfe.....	78
5.7 Entering an M series probe serial number	79
5.8 Setting the volume mixing ratio	80
5.8.1 Setting the pressure units.....	80
5.8.2 Setting the pressure value	81
5.8.3 Setting the k x PPMv multiplier.....	81
5.9 Setting the system clock	82
5.9.1 Setting the hour.....	82
5.9.2 Setting the minutes	83
5.9.3 Setting the month.....	83
5.9.4 Setting the date.....	84
5.9.5 Setting the year	84
5.10 Selecting the probe type	85
5.11 Setting the constant DP °C offset	86

Chapter 6. Service and maintenance

6.1 Introduction	87
6.2 The service menu	87
6.3 Troubleshooting common problems	88
6.4 Replacing/recalibrating moisture probes	89
6.5 Cleaning the dew.IQ front panel	90

Chapter 7. Specifications

7.1 Electronics	91
7.2 Moisture measurement	93

Appendix A. Outline and installation drawings

95

Appendix B. Menu maps

103

Appendix C. Reading the MicroSD card.....

107

C.1 Removing the MicroSD card	107
C.2 Connecting the MicroSD card to a PC	109
C.3 Accessing the log files	110
C.4 Setting up a log file	113

Default factory passcode

125

Chapter 1. Features and capabilities

1.1 Introduction

The **dew.IQ** is a single-channel hygrometer that measures moisture content in gases. It is suitable for a wide range of process conditions in applications that require real-time moisture measurement.

The **dew.IQ** accepts any calibration range provided with Panametrics probes (see Chapter 7, Specifications for more information). It comes equipped with two high/low alarm relays, one fault alarm relay, and a single analog output. It also has on-board data logging capability using a micro SD card.

1.2 Electronics

You can program the meter using the keys on the front panel (see Figure 1 below). The **dew.IQ** universal power supply accepts voltages from 100 to 240 VAC, or you may order the 24 VDC configuration.

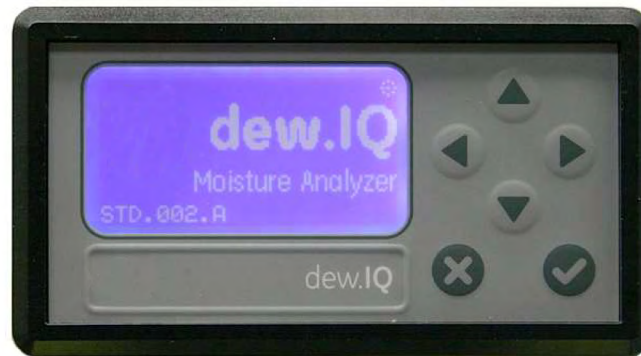

Figure 1: Front panel

1.3 Probes

The moisture probe is the part of the system that comes in direct contact with the process. The **dew.IQ** uses any Panametrics **M Series** probe (see Figure 2 below) or an **IQ.probe** (see Figure 3 below) to measure dew point temperature in °c or 0 F. The sensor assembly is secured to the probe mount and is protected with a sintered stainless steel shield (see Figure 2 below).

Note: Other types of shields are available upon request.

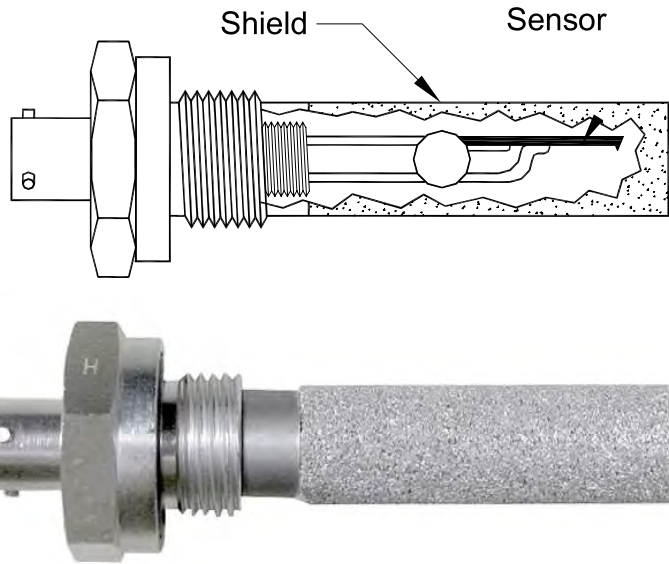

Figure 2: M series probe



Figure 3: IQ.probe

Chapter 2. Installation

2.1 Introduction

Installing the **dew.IQ** includes the following steps :

- Selecting the analog recorder output (see page 4)
- Mounting the electronics (see page 8)
- Mounting the sample system (see page 15)
- Installing the probe (page 16)
- Wiring the system (see page 18)



WARNING!

To ensure safe operation, the **dew.IQ** must be installed and operated as described in this manual. Also, be sure to follow all applicable local safety codes and regulations for installing electrical equipment.

2.2 Selecting the analog recorder output

Note: By default, the analog recorder output is set to the current output.

Note: Customers must provide their own cable for connecting the analog recorder output. Cables ranging from 16 to 26 AWG are acceptable.

The **dew.IQ** has one isolated analog recorder output. The analog recorder output provides either a current or voltage signal, as determined by the position of switch S1 on the main PC board.

Complete the following steps to check or reset switch **S1** (see Figure 8 on page 7):



WARNING!

Never connect line voltage or any other power input to the analog recorder output terminals.

1. Make sure the **dew.IQ** is turned **OFF** and unplugged. For wall mount and bench mount units, remove the **dew.IQ** from its enclosure before proceeding (see the appropriate figures in Appendix A).



WARNING!

The **dew.IQ** must be isolated or disconnected from all voltage sources before changing the recorder output.

2.2 Selecting the analog recorder output (cont.)

2. Remove the screw at the top of the back panel (see Figure 4 below).

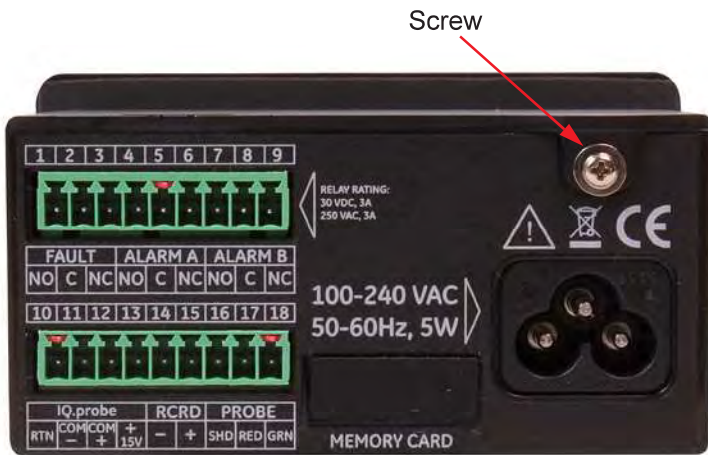

Figure 4: Back Panel (AC cord version shown)

3. Lift the back edge of the top cover (see Figure 5 below).



Figure 5: Lifting the Back Edge of the Cover

2.2 Selecting the analog recorder output (cont.)

- Slide the cover toward the back of the **dew.IQ** (see Figure 6 below).



Figure 6: Sliding the Cover to the Rear

- Lift the cover away from the enclosure (see Figure 7 below).



Figure 7: Removing the Cover

2.2 Selecting the analog recorder output (cont.)

6. Locate switch **S1** (see the highlighted area in Figure 8 below).



CAUTION!

Use proper ESD grounding prior to setting the switch.

7. Set switch **S1** to the desired position: **V** for voltage or **I** for current.

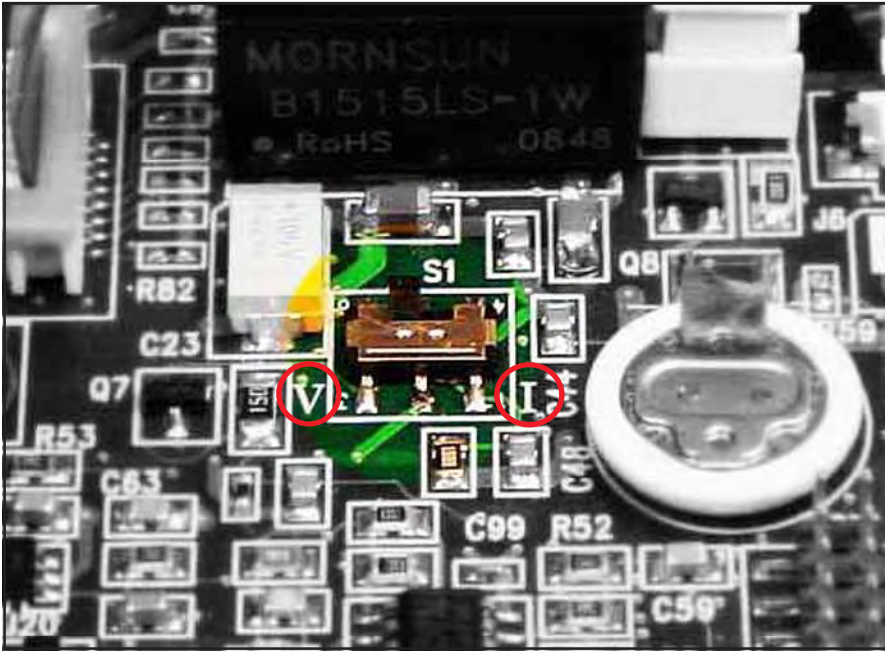

Figure 8: Switch S1 on the Main PC Board

8. After setting the switch, reinstall the cover and secure it with the rear enclosure screw. For wall mount and bench mount units, reinstall the **dew.IQ** in its enclosure (see the appropriate figures in Appendix A).

2.3 Mounting the electronics

The **dew.IQ** is available in the following configurations:

- “Panel Mount” on page 8
- “Rack Mount” on page 12
- “Bench Mount” on page 13
- “Wall Mount” on page 14

Proceed to the appropriate section for mounting your **dew.IQ** electronics.

2.3.1 Panel mount

The panel mount unit can be installed in a panel up to 0.25 in. (6 mm) thick. See Figure 43 on page 100, for the required panel cutout dimensions.

IMPORTANT:

For **Type 4X** and **IP66** installation, the **dew.IQ** must be mounted in a rigid, flat panel using the panel gasket and both mounting brackets provided.



2.3.1 Panel Mount (cont.)

To mount the **dew.IQ** in a panel with a 3.69" (94 mm) x 1.81" (46 mm) opening, refer to the figures and complete the following steps :

1. Remove the side panel mount label prior to installation.



Figure 9: Removing Side Panel Mount Label

2. Slide the gasket along the **dew.IQ** and place it around the back of the display (see Figure 10 below).



Figure 10: Installing the Gasket Behind the Display

2.3.1 Panel mount (cont.)

3. Slide the **dew.IQ** into the panel cutout (see Figure 11 below).



Figure 11: Sliding the **dew.IQ** into the Panel Cutout

4. Behind the panel, insert the mounting brackets into the side holes provided (see Figure 12 below).

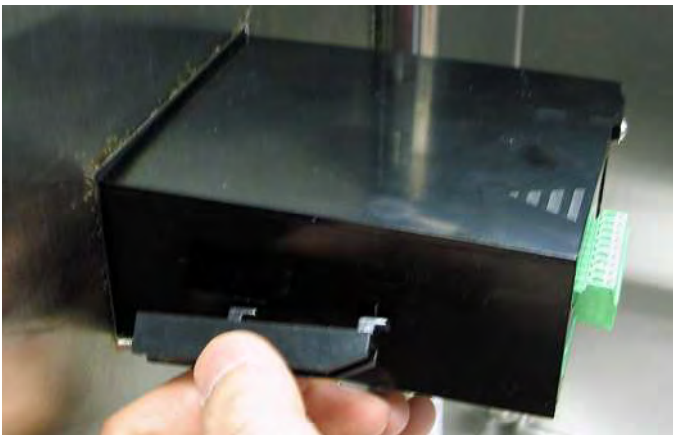

Figure 12: Installing the Mounting Brackets

2.3.1 Panel mount (cont.)

5. Hold the chassis and lock each mounting bracket in place by sliding it toward the rear of the **dew.IQ** (see Figure 13 below).



Figure 13: Locking the Mounting Brackets in Place

6. Use a screwdriver to extend the bracket screws to the back of the panel and secure the **dew.IQ** in the panel cutout (see Figure 14 below).



Figure 14: Securing the **dew.IQ** to the Panel

2.3.1 Panel mount (cont.)

- Using a feeler gauge behind the display, check the gasket compression, and tighten the bracket screws until the gap is $0.028'' (0.71 \text{ mm}) \pm 0.002'' (0.05 \text{ mm})$, as shown in see Figure 15 below.



Figure 15: Checking the Gasket Compression

2.3.2 Rack mount

The rack mount **dew.IQ** is a half-rack sized component designed for mounting in a standard instrument rack. See Figure 42 on page 99, for the dimensions.



2.3.3 Bench mount

The bench mount **dew.IQ** can be placed on any clean, flat, horizontal surface that provides adequate clearance around the unit for proper operation and configuration. See Figure 44 on page 101, for the dimensions.



2.3.4 Wall mount

The wall mount **dew.IQ** consists of a panel mount unit pre-installed in a standard Type 4X, IP66 wall mount enclosure. See Figure 39 on page 96, Figure 40 on page 97 and Figure 41 on page 98 for dimensions and installation notes.



The enclosure should be mounted on a vertical surface that provides adequate clearance for proper operation and configuration by completing the following steps:

1. Loosen the four (4) screws on the front of the enclosure, pull the door straight forward until it stops and then swing the door open (it is hinged on the left side).
2. Install four (4) self-drilling wall anchors in your mounting location per the hole pattern shown in Figure 39 on page 96.
3. Mount the enclosure on the wall using four (4) #8 x 1-1/2" machine screws in the four mounting holes provided.
4. Prior to operation, the door must be closed and secured with the four screws located at the corners.

2.4 Mounting the sample system

The sample system is normally fastened to a flat metal plate that has four mounting holes. Upon request, Panametrics can also provide the sample system in an enclosure. A typical sample system is shown in Figure 16 below.

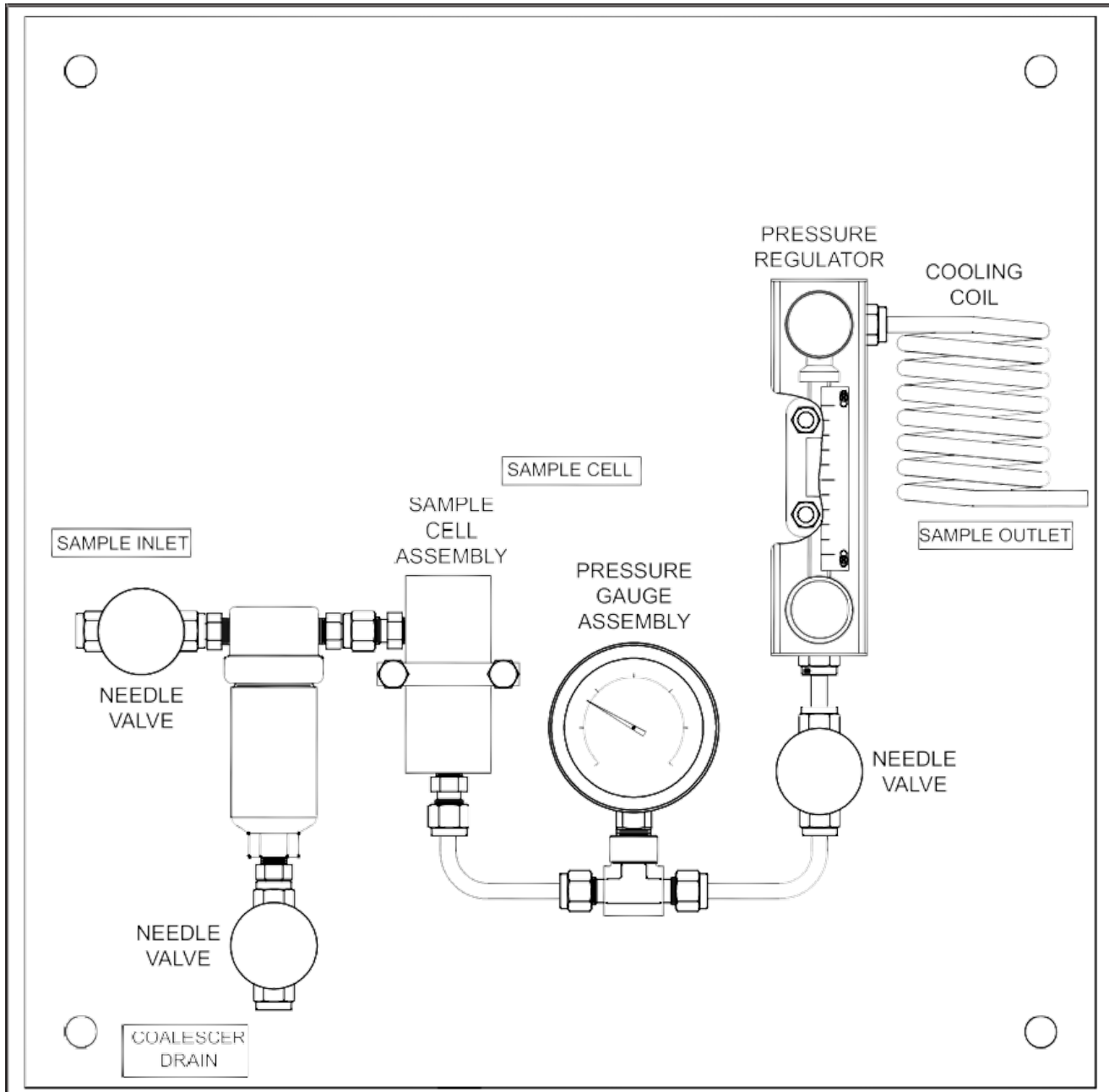

Figure 16: Typical Sample System

2.4 Mounting the sample system (cont.)

Complete the following steps to mount the sample system:

1. Fasten the sample system plate or enclosure to a vertical wall or panel with a bolt in each of the four corners.
2. Connect the sample system inlet to the process and the outlet to the return, using appropriate stainless steel fittings and tubing.



CAUTION!

Do not start the process flow through the system until the probe has been properly installed (see the following section).

2.5 Installing the probe

The following probes are available for use with the **dew.IQ**

- M Series probe (see Figure 2 on page 2)
- IQ.probe (see Figure 3 on page 2)

Panometrics probes are usually installed in a sample system to protect the probe from any damaging elements in the process. The probe is mounted in a cylindrical container called the **sample cell**, which is included as part of your sample system.

Standard **M Series** probes and the **IQ.probe** are mounted in the sample system or the process line with 3/4-16 straight threads that are sealed with an o-ring. Other fittings are available for special applications.



CAUTION!

If the probe is to be mounted directly in the process line, without a sample system, consult Panometrics for proper installation instructions and precautions.

2.5 Installing the probe (cont.)

Refer to Figure 17 below, and complete these steps to install the probe in the sample cell:

1. Insert the probe into the sample cell and thread the probe into the sample cell fitting. Make sure you do not cross the threads.
2. Tighten the probe securely.
3. Identify the sample cell inlet port as the connection that is perpendicular to the installed probe.



CAUTION!

For maximum protection of the aluminum oxide sensor, the probe shield should always be left in place.

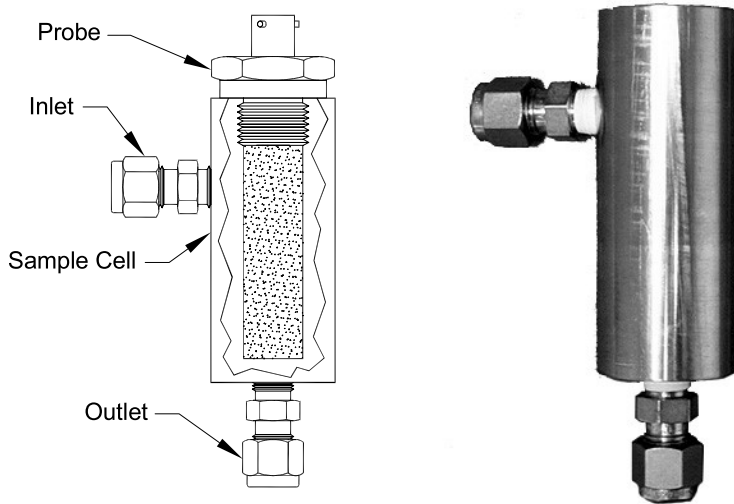

Figure 17: Probe/Sample Cell Assembly

2.6 Wiring the system

Wiring the **dew.IQ** system includes the following steps:

- Connecting the probe (see page 21 or page 24)
- Connecting the analog recorder output (see page 27)
- Connecting the alarms (see page 27)
- Connecting the input power (see page 30)



WARNING!

To ensure safe operation, the **dew.IQ** must be installed and operated as described in this manual. Also, be sure to follow all applicable local safety codes and regulations for installing electrical equipment.



WARNING!

For wall mount units, refer to Figure 41 on page 98 for the service loop required on all cable connections.

Refer to Figure 18 or Figure 19 on page 19 or Figure 20 on page 20 and Figure 45 on page 102 when making the electrical connections .



CAUTION!

This symbol in the three following figures is a reminder that the **dew.IQ** components can be damaged if electrical connections are not made correctly.

2.6 Wiring the system (cont.)

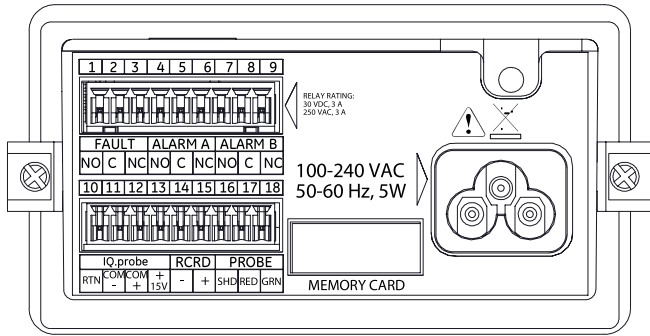

Figure 18: Electrical Connections (AC Power Cord Units)

Note: Figure 18 above, Figure 19 below and Figure 20 on page 20 show the three different power connections available for the **dew.IQ**. Be sure to use the figure that corresponds to your unit. All other electrical connections are identical for the three versions.

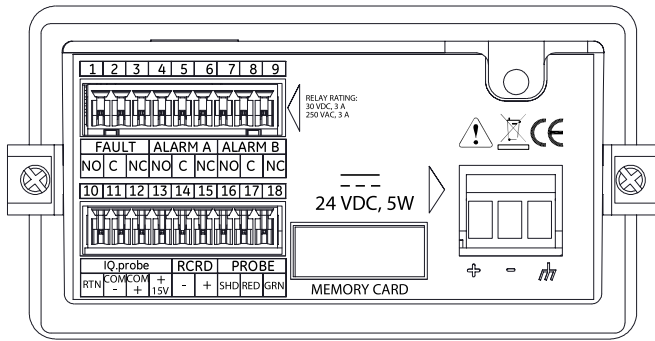

Figure 19: Electrical Connections (DC Power Terminals Units)

2.6.1 Connecting an M series probe

The **M Series** probe must be connected to the **dew.IQ** with a continuous run of Panametrics two-wire shielded cable. When connecting the probe, protect the cable from excessive strain (bending, pulling, etc.) and avoid subjecting the cable to temperatures above 65°C (149°F) or below -50°C (-58°F).

Note: Standard factory-assembled cables (see Figure 21 below) are available from Panametrics in lengths up to 600 m (2000 ft).



Figure 21: Two-Wire, Shielded, M Series Probe Cable

To connect the probe cable, refer to the accompanying photographs and complete the following steps:

1. Insert the end of the probe cable with the bayonet-type connector onto the probe and twist the shell clockwise until it snaps into a locked position (approximately 1/8 turn).

IMPORTANT:

Ensure that the power is **OFF** before proceeding .

2.6.1 Connecting an M series probe (cont.)

IMPORTANT:

To maintain good contact at the terminal block and to avoid damaging the pins on the wiring connector, pull the connector straight off (not at an angle) the terminal block, and make the cable connections while the connector is off the unit. After the wiring is complete, push the connector straight onto the terminal block (not at an angle).

2. Remove the connector from the lower terminal block on the rear of the **dew.IQ** (see Figure 22 below).

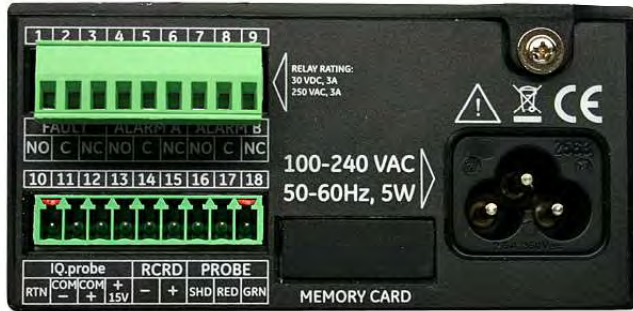

Figure 22: Bottom Connector Removed

3. Refer to Figure 23 below and Figure 24 on page 23 to connect the end of the probe cable with the three leads to pins 16, 17 and 18 on the lower terminal block.

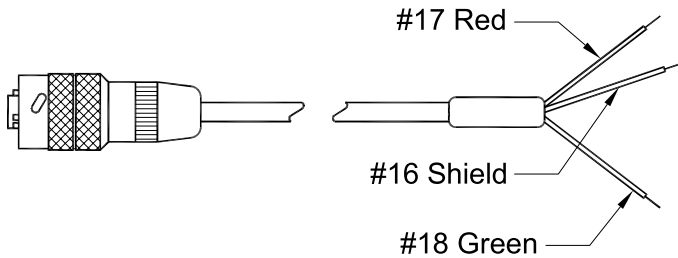

Figure 23: M Series Probe Cable Connections

2.6.1 Connecting an M series probe (cont.)

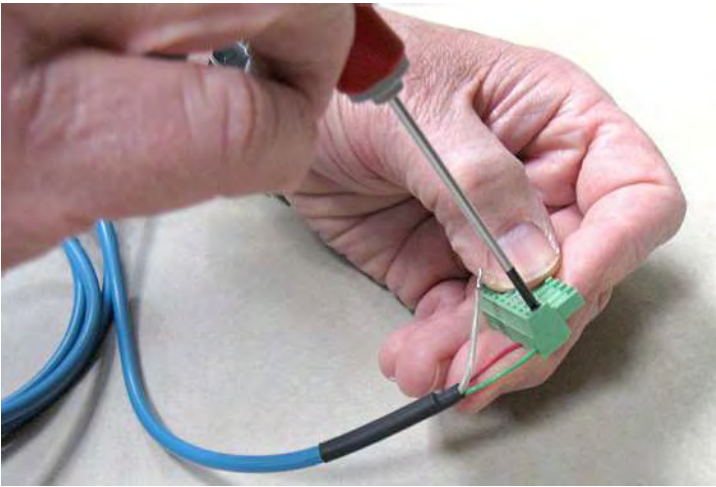

Figure 24: Making Probe Cable Connections to the Connector

4. Reinsert the connector into the lower terminal block on the rear of the **dew.IQ** (see Figure 25 below).



Figure 25: Reinserting the Connector into the Terminal Block

2.6.2 Connecting an IQ.probe

Complete the following steps to wire an **IQ.probe** to the **dew.IQ**

1. Insert the end of probe cable (see Figure 26 below) with the connector onto the probe and twist the connector head clockwise until it is secure.

IMPORTANT:

Ensure that the power is **OFF** before proceeding .



Figure 26: Four-Wire, IQ.probe Cable

2.6.2 Connecting an IQ.probe (cont.)

IMPORTANT:

To maintain good contact at the terminal block and to avoid damaging the pins on the wiring connector, pull the connector straight off (not at an angle) the terminal block, and make the cable connections while the connector is off the unit. After the wiring is complete, push the connector straight onto the terminal block (not at an angle).

- Remove the connector from the lower terminal block on the rear of the **dew.IQ** (see Figure 27 below).



Figure 27: Bottom Connector Removed

- Refer to Table 1 below and Figure 28 on page 26 to connect the end of the probe cable with the four leads to pins 10, 11, 12 and 13 on the lower terminal block.

Wire Color	Pin Number	Function
Brown	10	RTN
Black	11	COM-
White	12	COM+
Blue	13	+ISV
Bare Wire*	no connection	Shield

*The cable shield lead requires no connection to the **dew.IQ** and should be wrapped around the base of the other four leads.

Table 1: IQ.probe Wiring Connections

2.6.2 Connecting an IQ.probe (cont.)

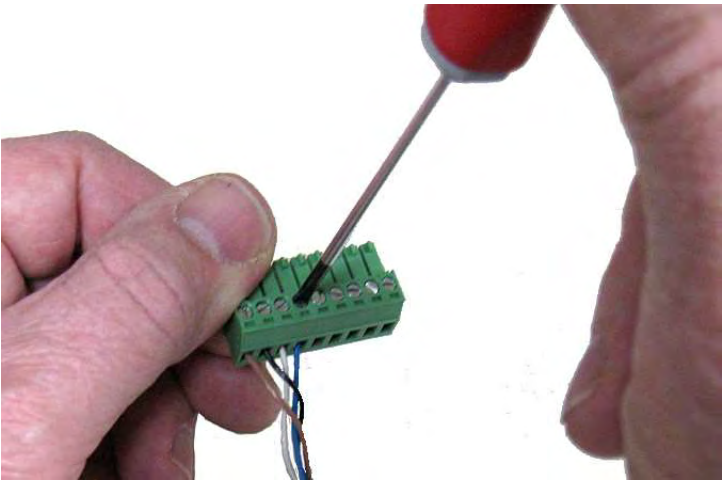

Figure 28: Wiring the Cable to the Connector

4. Reinsert the connector into the lower terminal block on the rear of the **dew.IQ** (see Figure 29 below).



Figure 29: Reinserting the Connector into the Terminal Block

Note: If there is a No Link error for the **IQ.probe**, check the wiring connections and make sure there is no short between +15V and RTN.

2.6.3 Connecting the analog output

IMPORTANT:

Ensure that the power is **OFF** before proceeding.

Refer to Table 2 below to connect your analog recorder to pins 14 and 15 on the lower terminal block on the back of the **dew.IQ** (see Figure 22 on page 22 or Figure 27 on page 25).

IMPORTANT:

To maintain good contact at the terminal block and to avoid damaging the pins on the wiring connector, pull the connector straight off (not at an angle) the terminal block, and make the cable connections while the connector is off the unit. After the wiring is complete, push the connector straight onto the terminal block (not at an angle).

Wire Color	Pin Number	Function
Black	14	Signal-
Red	15	Signal+

Table 2: Pin Assignments for Analog Output

2.6.4 Connecting the alarm relays

Note: The cable for connecting the alarm relays is supplied by the customer. Acceptable cables range from 16 to 26AWG.

The **dew.IQ** has one fault alarm relay and two high/low alarm relays. Each alarm relay is a single-pole, double-throw contact set with the following contacts (see Table 3 below for the connector pin assignments):

- Normally Open (**NO**)
- Common (**C**)
- Normally Closed (**NC**)

Contact	Fault Alarm	Alarm A	Alarm B
Normally Open	1	4	7
Common	2	5	8
Normally Closed	3	6	9

Table 3: Pin Assignments for Alarm Relay Contacts

2.6.4.1 Connecting the high/low alarms (A and B)

IMPORTANT:

Ensure that the power is **OFF** before proceeding.

Each of these alarms can be set to trip on either a high or low condition. For a high alarm, the alarm will trip if the input exceeds the setpoint. For a low alarm, the alarm will trip if the input drops below the setpoint.

To wire the high/low alarm relays, complete the following steps:

1. Remove the connector from the upper terminal block on the rear of the **dew.IQ** (see Figure 30 below).

IMPORTANT:

To maintain good contact at the terminal block and to avoid damaging the pins on the wiring connector, pull the connector straight off (not at an angle) the terminal block, and make the cable connections while the connector is off the unit. After the wiring is complete, push the connector straight onto the terminal block (not at an angle).



Figure 30: Removing the Upper Connector

2. Make the Alarm A and Alarm B connections to upper terminal block connector, as indicated in Table 3 on page 27.
3. Reinsert the connector into the upper terminal block on the rear of the **dew.IQ**

2.6.4.2 Connecting the fault alarm

If enabled, the **dew.IQ** fault alarm trips when one or more of the following faults occurs: power failure, range error (configurable) or watchdog function system reset

Note: The watchdog function is a supervisory circuit that automatically resets the unit whenever a system error occurs.

The fault alarm has two possible operating modes:

- **Fail-Safe Mode:** Using pins 2 and 3 provides a “normally closed” contact. When the **dew.IQ** is operating in a non-fault state, the fault alarm relay is energized to open the contact between pins 2 and 3. When a fault occurs, the fault alarm relay is de-energized to close the contact between pins 2 and 3 and trigger the alarm.
- **Non-Fail-Safe Mode:** Using pins 1 and 2 provides a “normally open” contact. When the **dew.IQ** is operating in a non-fault state, the fault alarm relay is de-energized with an open the contact between pins 1 and 2. When a fault occurs, the fault alarm relay is energized to close the contact between pins 1 and 2 and trigger the alarm.

IMPORTANT:

Ensure that the power is off before proceeding.

To wire the fault alarm relay, complete the following steps:

1. Remove the connector from the upper terminal block on the rear of the **dew.IQ** (see Figure 30 on page 28).

IMPORTANT:

To maintain good contact at the terminal block and to avoid damaging the pins on the wiring connector, pull the connector straight off (not at an angle) the terminal block, and make the cable connections while the connector is off the unit. After the wiring is complete, push the connector straight onto the terminal block (not at an angle).

2. Make the fault alarm connections to upper terminal block connector, as indicated in Table 3 on page 27.
3. Reinsert the connector into the upper terminal block on the rear of the **dew.IQ**

2.6.5 Connecting the input power

There are three input power configurations available for the **dew.IQ**

- AC power cord (not used for wall mount units)
- DC power terminals (available for all configurations)
- AC power terminals (available for all configurations)

Proceed to the appropriate section to connect your input power.

2.6.5.1 Connecting the AC power cord

To install the AC power cord included with the **dew.IQ**, simply plug the female connector end of the cable into the male connector on the rear panel of the **dew.IQ** (see Figure 31 below and Figure 32 on page 31).

Note: This configuration is not used for AC powered wall mount units.



Figure 31: Inserting the AC Power Cable

2.6.5.1 Connecting the AC power cord (cont.)



Figure 32: The AC Power Cable Installed

2.6.5.2 Connecting the DC power terminals

The DC power cable (with 14 to 26 AWG conductors) is supplied by the customer. To connect the power cable to the **dew.IQ** input power terminals (see Figure 19 on page 19) complete the following steps:

1. Remove the input power connector from the rear panel of the **dew.IQ** (see Figure 33 below).



Figure 33: Removing the DC Power Connector

2.6.5.2 Connecting the DC power terminals {cont.}

- Strip the three power cable conductors by about 3/8" (10 mm).
- Insert each wire into the appropriate connector pin (see Table 4 below) and tighten each screw to secure the wires in place.

Wire Color	Pin	Function
R	+	
Black		V
Green	GND Symbol	Ground

Table 4: Pin Assignments for DC Power Connector

IMPORTANT:

Be sure that the **dew.IQ** chassis ground connection is properly grounded.

- Reinsert the power connector into the rear panel of the **dew.IQ** as shown in Figure 34 below.



Figure 34: Reinserting the DC Power Connector

2.6.5.3 Connecting the AC power terminals

IMPORTANT:

Unlike the DC power connector, which has screw terminals, the AC power connector has spring finger terminals. It is essential that this connector be removed from the **dew.IQ** for wiring to avoid putting stress on the PCB, which may cause damage to the board.

The AC power cable (with 14 to 26 AWG conductors) is supplied by the customer. To connect the power cable to the **dew.IQ** input power terminals, see Figure 20 on page 20 and complete the following steps:

1. Remove the input power connector from the rear panel of the **dew.IQ**, as shown in Figure 35 below.



Figure 35: Removing the AC Power Connector

2.6.5.3 Connecting the AC power terminals (cont.)

- Strip the three power cable conductors by about 3/8" (10 mm).
- Using a small screwdriver to assist in opening each spring finger terminal, insert each wire into the appropriate connector pin (see Table 5 below).

Wire Color	Pin	Function
Black	L1	Line
White	1 2/N	Line 2 (230 VAC) or Neutral
Green	G	Ground

Table 5: Pin Assignments for AC Power Connector

- Reinsert the power connector into the rear panel of the **dew.IQ**

Chapter 3. Initial setup and operation

3.1 Using the dew.IQ

All programming of the **dew.IQ** is done via the front panel keypad and display, as illustrated below.

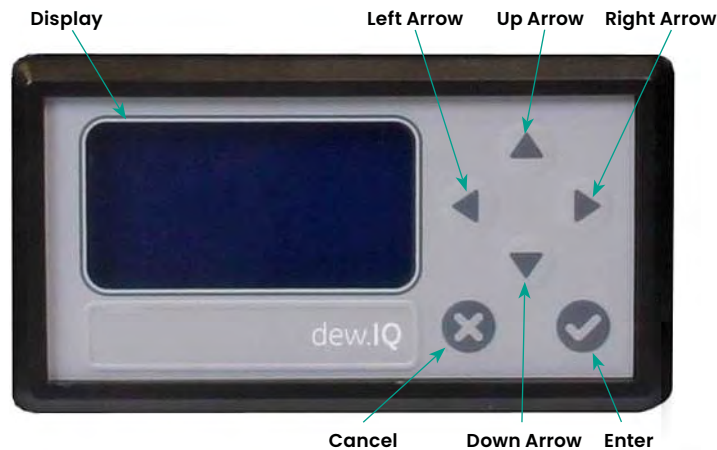

The front panel components perform the following functions:

- **Display** - The programming menus and options are shown on the LCD display screen.
- **Enter** - In most instances, press this key to save an entry and/or to advance to the next screen.
- **Cancel** - In most instances, press this key to reject an entry and/or to return to the previous screen.
- **Left/Right Arrow Keys** - Use these keys to move the cursor along a row one character at a time in the direction indicated.
- **Up/Down Arrow Keys** - Use these keys to move the cursor between rows one row at a time in the direction indicated.

Note: In those instances when the keys behave in a manner unique to a specific screen, the differences will be described in that section.

3.1.1 Starting up

After installation, the **dew.IQ** moisture analyzer can be configured to meet the user's requirements. While programming the instrument, refer to one of the following menu maps:

- Figure 46 on page 104 when using an **M Series** probe (this probe is used for the programming examples in this chapter.)
- Figure 47 on page 105 when using an **IQ.probe**

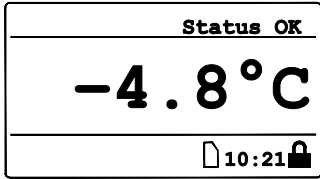

Upon the application of power, the **dew.IQ** performs some self checks and then displays a measurement mode screen like the one below.



After startup, the **Main Menu** needs to be unlocked. To unlock the menu, press:

 Cancel,  Enter,  Cancel.

3.1.2 Accessing the menus

After unlocking the menu (as confirmed by the absence of the padlock icon in the lower right corner), press **Cancel**  to display the Main Menu (see Figure 36 below). Use the arrow keys to select the desired menu option and press **Enter**  to access the highlighted option. Pressing **Cancel**  from the Main Menu returns the screen to the Measurement Display.

Note: Menu items followed by an ellipsis (i.e., a series of three dots) have submenus, while those without it take immediate action.

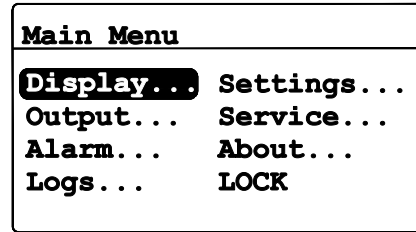

3.1.3 Entering numeric values

The **dew.IQ** has no numeric keypad. Numeric values are entered using a “combination lock” entry (see Figure 37 below as an example):

1. Use the **left** ◀ and **right** ▶ arrow keys to select the digit to change. The digit selected will be indicated with an
2. Use the **up** ▲ and **down** ▼ arrow keys to increment or decrement the selected digit.

Note: If incrementing or decrementing a digit would cause the numeric value to leave its allowable range (maximum or minimum value), the digit will not change.

3. After you have completed your numeric entry, press **Enter** ✓ to save the new value and return to the previous screen, or press **Cancel** ✕ to leave the original value intact and return to the previous screen.

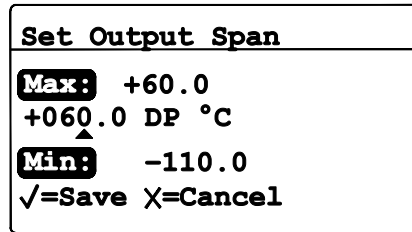

Figure 37: Numeric Entry

3.2 Setting up the display

Main Menu	
Display...	Settings...
Output...	Service...
Alarm...	About...
Logs...	LOCK

When the screen is unlocked, press the **Cancel**  key and the Main Menu appears with several options. To set up the display, select Display... and press **Enter**  following screen appears:

3.2.1 Selecting the primary units

Display Menu
Unit Select
Decimal
Contrast

To select the units for the primary display, select Unit Select and press **Enter** . The following screen appears:

Select Display Unit:	
DP °C	PPMvNG
DP °F	PPBv
PPMv	MMSCFig
mg/m ³	MMSCFng
g/m ³	Equiv DP °C
kg/m ³	Equiv DP °F
MH	

Use the arrow keys to select the desired units and press **Enter** . The screen returns to the Display Menu.

Note: If the IQ.probe is being used, FH replaces MH.

3.2.2 Setting the decimal places

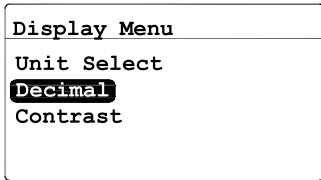

To set the decimal places for unit values, from the Display Menu use the arrow keys to select **Decimal** and press **Enter** (✓). The following screen appears:

Note: The decimal places setting determines the number of digits displayed to the right of the decimal point (".") for the value, if possible.

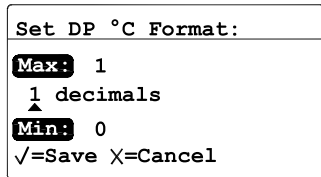

Use the arrow keys to change the number of decimal places and press **Enter** (✓), or press **Cancel** (✗) if no changes are desired. The screen returns to the Display Menu.

3.2.3 Adjusting the contrast

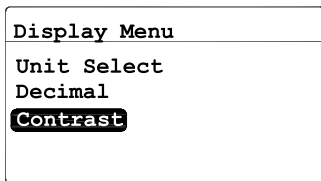

To adjust the display contrast, from the Display Menu use the arrow keys to select **Contrast** and press **Enter** (✓). The following screen appears:

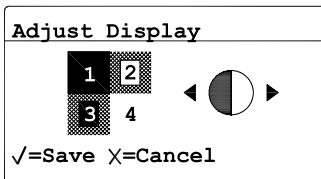

Use the **Right/Left** arrow keys to increase or decrease the display contrast. Press **Enter** (✓) to save the changes, or press **Cancel** (✗) to discard the changes. The screen returns to the Display Menu.

3.3 Setting up the analog output

3.3.1 Entering the output menu

Main Menu	
Display...	Settings...
Output...	Service...
Alarm...	About...
Logs...	LOCK

To set up the output, from the Main Menu choose Output... and press **Enter** ✓. The following screen appears:

3.3.2 Selecting the output units

Output Menu	
Units	Test
Type	Trim...
Upper	
Lower	

From the Output Menu, select Units and press **Enter** ✓. The following screen appears:

Select Output Unit:	
DP °C	g/m ³
DP °F	kg/m ³
PPMv	MH
mg/m ³	

Use the arrow keys to select the desired units and press **Enter** ✓. The screen returns to the Output Menu.

Note: If the IQ.probe is being used , FH replaces MH.

3.3.3 Selecting an output type



IMPORTANT:

Before changing the analog output type, refer to “Selecting the Analog Recorder Output” on page 4 to make sure that **Switch S1** is set correctly (**V** for voltage or **I** for current).

Output Menu	
Units	Test
Type	Trim...
Upper	
Lower	

To change the output type, from the Output Menu select Type and press **Enter** . A screen similar to the following appears:

Output Menu	
Select Output Type:	
4-20mA	0-20mA 0-2V
√=Accept X=Cancel	



Use the arrow keys to select a new output type. Press **Enter**  to save the selection (or **Cancel**  to keep the previous value), and return to the Output Menu.

3.3.4 Changing the output span

Output Menu	
Units	Test
Type	Trim...
Upper	
Lower	

To adjust the output span, from the Output Menu select Upper and press **Enter** . A screen similar to the following appears:

Set Output Span	
Max:	+60.0
	+060.0 DP °C
Min:	-110.0
√=Save X=Cancel	

Use the left and right arrow keys to select each digit to be changed and the up and down arrow keys to increase or decrease its value. Press **Enter**  to save (or **Cancel**  to keep the previous value), and return to the Output Menu.

3.3.5 Changing the output zero

Output Menu	
Units	Test
Type	Trim...
Upper	
Lower	

To adjust the output zero, from the Output Menu select Lower and press **Enter** . A screen similar to the following appears:

Set Output Zero	
Max:	+60.0
	-110.0 DP °C
Min:	-110.0
√=Save X=Cancel	

Use the left and right arrow keys to select each digit to be changed and the up and down arrow keys to increase or decrease its value. Press **Enter**  to save the new value (or **Cancel**  to keep the previous value), and return to the Output Menu.

3.3.6 Testing the output

To verify proper operation of connected recording or SCADA equipment, the **dew.IQ** can output test signals of known value. Based on the percent of range selected, the Test Menu causes the **dew.IQ** to output test signals that can be easily calculated. As examples, the test signals for three commonly used range percentages are shown in Table 6 below.

Output Type	0%	50%	100%
0-20mA	0.00mA	10.00mA	20.00 mA
4-20mA	4.00mA	12.00 mA	20.00 mA
0-2V	0.00 v	1.00V	2.00 V

Table 6: Output Test Value Examples

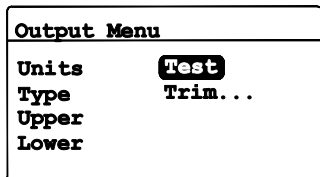

To test the system output, from the Output Menu select Test and press **Enter** . The **dew.IQ** will check the output settings, and a screen similar to the following appears:

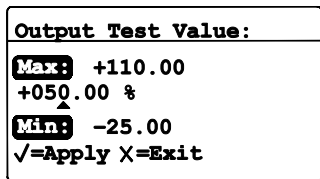

Use the left and right arrow keys to select each digit to be changed, and the up and down arrow keys to increase or decrease its value. Press **Enter** to save the new value (or **Cancel** to keep the previous value), and return to the Output Menu.

3.3.7 Trimming the output

The Trim Menu enables the operator to compensate for differences in the 0/4-20 mA or 0-2V **dew.IQ** test outputs and the readings on a connected output device. To trim the analog output:

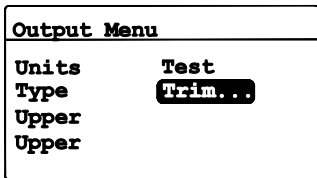

Select Trim from the Output Menu and press **Enter** . The following screen appears:

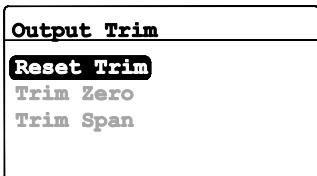

When performing a Trim operation, the **dew.IQ** requires you to first reset the trim. To reset the trim output, select Reset Trim and press **Enter** . The following screen appears:

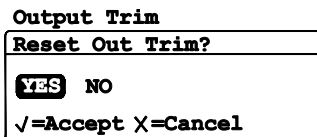

Use the left or right arrow keys to select YES and press **Enter** . This cancels any previous trim values, and returns the **dew.IQ** to its factory adjustment. The display returns to the previous screen.

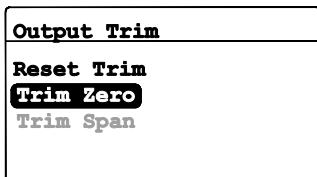

To trim the zero value, select Trim Zero and press **Enter** . A screen similar to the following appears:

This step causes the **dew.IQ** to output 4.000 mA or 0.4 Von the output being trimmed. The output value should then be read using the connected analog device or a DVM.

3.3.7 Trimming the output (cont.)

Enter the value read from the connected equipment as the Zero Trim value, as follows:

Note: Since you cannot trim 0 mA or 0 V for negative offsets, trim for the lower end of the scale is always at the 4 mA or 0.4 V output.

Enter Out Reading:	
Max:	5.2000
	04.0000 mA
Min:	3.0000
√=Save X=Cancel	

Use the left and right arrow keys to select each digit to be changed, and the up and down arrow keys to increase or decrease its value. Press **Enter** ✓ to save (or **Cancel** ✕ to keep the previous value).

Output Trim	
Reset Trim	
Trim Zero	
Trim Span	

The Output Trim menu returns with Trim Span highlighted. To change the span value, press **Enter** ✓. A screen similar to the following appears:

This step causes the **dew.IQ** to output 20.000 mA or 2 V on the output being trimmed. The output value should then be read using the connected analog device or a DVM. Enter the value read from the connected equipment as the Span Trim value, as follows:

Enter Out Reading:	
Max:	22.2000
	20.0000 mA
Min:	10.0000
√=Save X=Cancel	

Use the left and right arrow keys to select each digit to be changed, and the up and down arrow keys to increase or decrease its value. Press **Enter** ✓ to save the new value (or **Cancel** ✕ to keep the previous value).

Trimming is complete. To verify the accuracy, see “Testing the Output” on page 43.

3.3.7 Trimming the output (cont.)

Example:



1. Trim is reset, then Trim Zero is selected. The connected output device reports 3.977 mA.
2. The operator enters "3.977" as the Zero Trim value.
3. Trim Span is selected. The connected output device reports 19.985 mA.
4. The operator enters "19.985" as the Span Trim value.
5. The **dew.IQ** adjusts the output accordingly to align the output with the readings by the connected output device or a DVM.
6. Using the Test Menu, the operator verifies that a test value of 0% now reads 4.000 mA at the connected output device, and a test value of 100% now reads 20.000 mA.

3.4 Setting up the measurement alarms

The **dew.IQ** has with two programmable high/low alarms and one fault alarm relay. Use the instructions in this section to set up these alarms.

3.4.1 Selecting an alarm output

Alarm Menu [A]	
Select	Upper
Status	Lower
Units	Test
Type...	

To set up the alarms, on the Main Menu choose Alarm and press **Enter** . Then, from the Alarm Menu choose Select and press **Enter** . A screen similar to the following appears:

Alarm Menu [A]	
Select Alarm:	
A	B
√=Accept X=Cancel	

Use the arrow keys to select the output (A or B) to be set up and press **Enter** . The display returns to the Alarm Menu.

3.4.2 Selecting the alarm status

Alarm Menu [A]	
Select	Upper
Status	Lower
Units	Test
Type...	

To select the alarm status, from the Alarm Menu select Status and press **Enter** . The following screen appears:

Alarm Menu [A]	
Set Alarm Status:	
OFF	ON
√=Accept X=Cancel	



Use the arrow keys to select OFF or ON and press **Enter** . The display returns to the Alarm Menu.

3.4.3 Selecting the alarm units

Alarm Menu [A]	
Select	Upper
Status	Lower
Units	Test
Type...	

To select the alarm units, from the Alarm Menu select Units and press **Enter** . The following screen appears:

Select Alarm Unit:	
DP °C	g/m³
DP °F	kg/m ³
PPMv	MH
mg/m ³	

Use the arrow keys to select the desired alarm units. Press **Enter**  to save the selection (or **Cancel**  to keep the previous value), and return to the Alarm, Menu.

Note: If the IQ.probe is being used, FH replaces MH.

3.4.4 Selecting an alarm type

Alarm Menu [A]	
Select	Upper
Status	Lower
Units	Test
Type...	

To change the alarm type, from the Alarm Menu select Type and press **Enter** ✓. A screen similar to the following appears:

Select Alarm Type:
Setpoint
In Band
Out Band

Use the arrow keys to select an alarm type (see “How the Alarm Types Work” on page 49). Press **Enter** ✓ to save (or **Cancel** ✕ to keep the previous value), and return to the Alarm Menu.

3.4.5 How the alarm types work

The available alarm types (see Figure 38 below) for the **dew.IQ** are:

- **Setpoint:** The alarm activates when the selected parameter exceeds the upper limit. It deactivates when the selected parameter is less than the lower limit.
- **Inner Band:** The alarm activates when the selected parameter is between the upper limit and the lower limit. It deactivates when the selected parameter exceeds the upper limit or is less than the lower limit.
- **Outer Band:** The alarm activates when the selected parameter exceeds the upper limit or is below the lower limit. It deactivates when the selected parameter is between the upper limit and the lower limit.

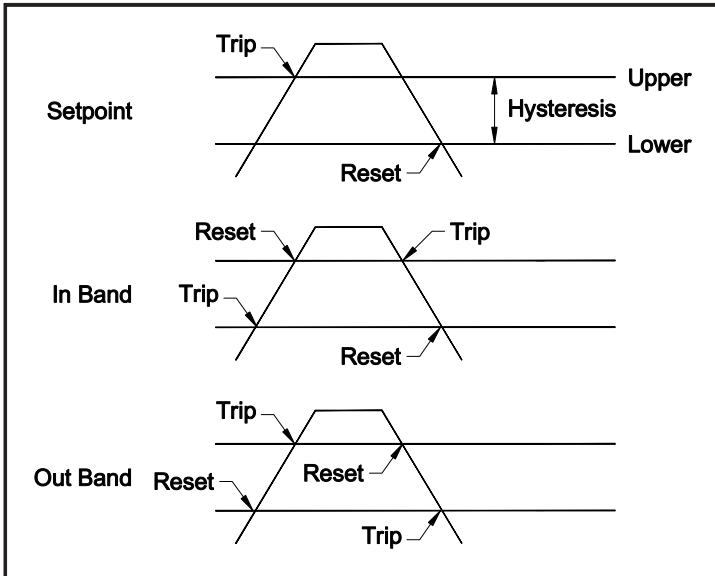



Figure 38: Available Alarm Types

3.4.6 Setting the alarm span

Alarm Menu [A]	
Select	Upper
Status	Lower
Units	Test
Type...	

To adjust the alarm span, from the Alarm Menu select Upper and press **Enter** . A screen similar to the following appears:

Enter MAX Alm Value	
Max:	+60.0
	+000.0 DP °C
Min:	-110.0
	√=Save X=Cancel

Use the left and right arrow keys to select each digit to be changed and the up and down arrow keys to increase or decrease its value. Press **Enter**  to save the new value (or **Cancel**  to keep the previous value), and return to the Alarm Menu.

3.4.7 Setting the alarm zero

Alarm Menu [A]	
Select	Upper
Status	Lower
Units	Test
Type...	

To adjust the alarm zero, from the Alarm Menu select Lower and press **Enter** . A screen similar to the following appears:

Enter MIN Alm Value	
Max:	+60.0
	+000.0 DP °C
Min:	-110.0
	√=Save X=Cancel

Use the left and right arrow keys to select each digit to be changed and the up and down arrow keys to increase or decrease its value. Press **Enter**  to save the new value (or **Cancel**  to keep the previous value), and return to the Alarm Menu.

3.4.8 Testing the alarm relays

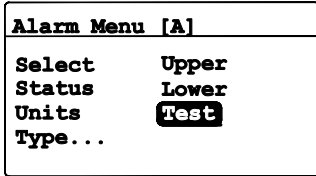

To test the alarm relay and devices connected to it, from the Alarm Menu select Test and press Enter . A screen similar to the following appears:

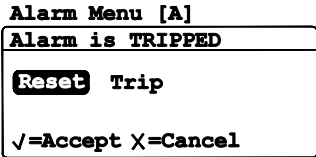

Use the left and right arrow keys to select Reset or Trip and press Enter . If Reset was selected, the message Alarm is RESET appears. If Trip was selected, the message Alarm is Tripped appears. Press **Cancel** to return to the Alarm Menu.

3.5 Viewing system information

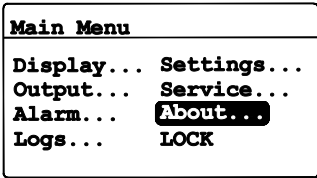

To view the **dew.IQ** system information, from the Main Menu choose About... and press **Enter** ✓. Proceed to the following sections.

Note: The information in the following screens are examples only. Your **dew.IQ** will display the information for your specific unit.

3.5.1 Checking the ID

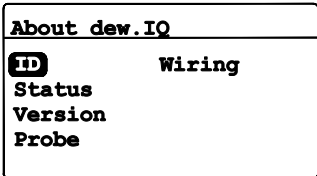

To check the identity information of the **dew.IQ**, from the About **dew.IQ** menu select ID and press **Enter** ✓. A screen similar to the following appears:

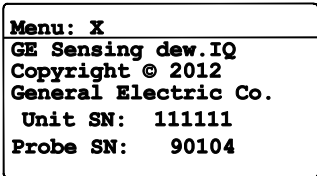

The information includes serial numbers for the **dew.IQ** unit and the attached probe. To return to the About **dew.IQ** menu, press **Cancel** ✕.

3.5.2 Checking the status

```
About dew.IQ
ID           Wiring
Status
Version
Probe
```

To check the status of the MicroSD card, from the About **dew.IQ** menu select Status and press Enter . A screen similar to the following appears:

```
Menu: X
Uptime: 0d 00h
SD Card Installed.
Format is FAT16
0.27 MB used
244.68 MB free
```

The information includes the format, amount of used space and amount of free space for an installed SD card. To return to the About **dew.IQ** menu, press **Cancel** .

3.5.3 Checking the software version

Note: The information in the following screens is a typical example only. Your unit always displays your actual information .

```
About dew.IQ
ID           Wiring
Status
Version
Probe
```

To check the software version of the **dew.IQ**, from the About **dew.IQ** menu select Version and press Enter . A screen similar to the following appears:

```
Menu: X
Prog:       STD.001.A
```

The information includes the program number (i.e., the firmware version). To return to the About **dew.IQ** menu, press **Cancel** .

3.5.4 Checking the probe

Note: The information in the following screens is a typical example only. Your unit always displays your actual information.

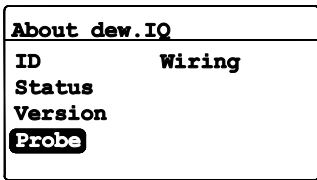

To check the probe details, from the About dew. IQ menu select Probe and press **Enter** . A screen similar to one of the following appears:

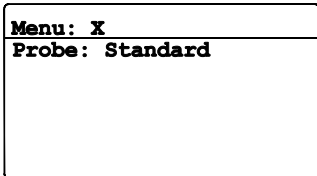

For an M Series probe, this probe information is shown. To return to the About **dew.IQ** menu, press **Cancel** .

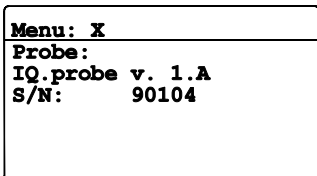

For an IQ.probe, this probe information is shown. To return to the About **dew.IQ** menu, press **Cancel** .

3.5.5 Checking the wiring

About dew.IQ	
ID	Wiring
Status	
Version	
Probe	

To view the **dew.IQ** wiring diagram, from the About **dew.IQ** menu select Wiring and press **Enter** . A screen similar to the following appears:

Menu: x									
1	FAULT	ALM A	ALM B	9					
	NO C	NC	NO C	NC	NO C	NC			
10	IQ.PROBE	RCDR	H2O	PROBE	18				
	+ C-	C+V+	- +	SHL	RED	GRN			

When you are ready to return to the **dew.IQ** Main menu, press **Cancel**  twice.

3.6 Locking the main menu

Main Menu	
Display...	Settings...
Output...	Service...
Alarm...	About...
Logs...	LOCK

To lock out access to changing menu settings, from the Main Menu choose LOCK and press **Enter** . The display returns to normal measurement mode.

Note: To unlock the menu, refer to "Starting Up" on page 36.

[no content intended for this page]

Chapter 4. Data logging

4.1 Checking the data log Status

```
Logging Menu
Status
Manage...
Settings...
Eject Card
```

To check the data log status, from the Logging Menu select Status and press **Enter** ✓. A screen similar to the following appears:

```
Data Log RUNNING
File: 01270803
Interval: 60 secs
Size: 23 KB
```

The current data log status is displayed. After about 10 seconds or upon pressing **Enter** ✓ (whichever occurs first), the screen returns to the **Logging Menu**.

4.2 The log settings menu

Note: To access the Settings... option in the Logging Menu, the log file must be stopped (see “Pausing or Closing a Log” on page 62).

4.3 Setting the log units

```
Logging Menu
Status
Manage...
Settings...
Eject Card
```

From the Logging Menu select Settings... and press **Enter** ✓. The following screen appears:

```
Set Log Params
Units
Interval
FieldSep
Flags
```

To set units to log, from the Set Log Params menu, select Units and press **Enter** ✓. The following screen appears:

4.3 Setting the log units (cont.)

Units to Log:	
1	DP °C
2	DP °F
3	-----
4	-----

Use the arrow keys to select the unit to log, and press **Enter** . The following screen appears:

Units to Log:	
Choose Unit Action:	
Modify	Remove
√=Accept X=Cancel	



To change the unit setting, select Modify and press **Enter** . The following screen appears:

Select Unit #1:	
DP °C	g/m ³
DP °F	kg/m ³
PPMv	MH
mg/m ³	

Use the arrow keys to select the first unit to be logged and press **Enter** . The screen returns to the Units to Log menu.

Note: If the IQ.probe is being used, FH replaces MH.

Units to Log:	
Choose Unit Action:	
Modify	Remove
√=Accept X=Cancel	



To remove a unit, from the Units to Log menu, select Remove and press **Enter** . Select the unit to be removed, press **Enter** , to delete the selected unit. Press **Cancel**  to return to the Set Log Params menu.

4.4 Setting the log interval

```
Set Log Params
Units
Interval
FieldSep
Flags
```

To set the log interval, from the Set Log Params menu, select Interval and press **Enter** . The following screen appears:

```
Set Log Interval
Max: 86400
00005 seconds
Min: 1
√=Save X=Cancel
```

Use the left and right arrow keys to select each digit to be changed and the up and down arrow keys to increase or decrease its value. Press **Enter**  to save the new value (or **Enter**  to keep the previous value), and return to the Set Log Params menu.

4.5 Setting a log field separator

```
Set Log Params
Units
Interval
FieldSep
Flags
```

To designate a text character to separate the log fields, from the Set Log Params menu select FieldSep and press **Enter** . The following screen appears:

```
Set Log Params
Field Separator:
Comma Tab
√=Accept X=Cancel
```

Use the arrow keys to select the text character used to separate the log fields and press **Enter** . The screen returns to the Set Log Params menu.

4.6 Setting the log status flags



The flags used to identify the log status are as follows:

- Range Err
- Over Range
- Under Range
- No Comm
- No Link
- Bad CRC
- Bad Message
- Auto Cal
- No Refs
- No Data
- No Cal
- Write Err
- Read Err
- ADC Failure
- Cal Error

Set Log Params
Units
Interval
FieldSep
Flags

To turn log status flags on or off, from the Set Log Params menu select Flags and press **Enter** . The following screen appears:

Set Log Params
Log Status Flags:
Off On
√=Accept X=Cancel

Use the arrow keys to select OFF or ON and press **Enter** . The screen returns to the Set Log Params menu. Then, press **Cancel**  to return to the Logging Menu.

4.7 Managing log files

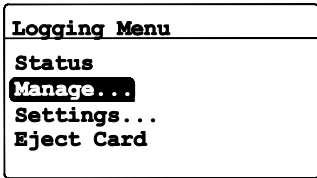

To manage the log file status, from the Logging Menu select Manage and press **Enter** . If no log has been created, the following screen appears:

4.7.1 Creating a new log

Note: The New Log option is available only if there are no logs currently running or paused. All running or paused logs must be closed before proceeding. Note that a closed log cannot be resumed.

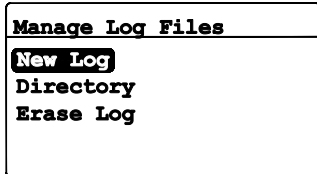

To create a new log, from the Manage Log Files menu select New Log and press **Enter** . A screen similar to the following appears:

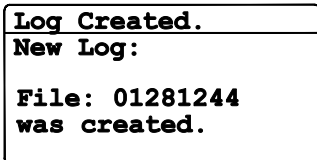

A file name, which corresponds to the date and time the log is started, is assigned to the new log by the **dew.IQ**. For example, a log started on May 1 at 4:37 pm will be named 05011637. After about 10 seconds or upon pressing **Cancel**  (whichever occurs first), the screen returns to the Manage Log Files menu.

Note: When a new log is created, the New Log option in the Manage Log Files menu changes to a Pause/Close option.

4.7.2 Pausing or closing a log

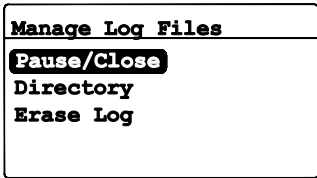

After a new log is created, it can be paused or closed at any time. To pause or close a log, from the Manage Log Files menu select Pause/Close and press **Enter** . The following screen appears:

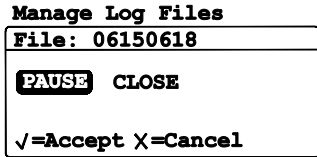

The log file name is shown in the header. Select Pause or Close and press **Enter** . The screen returns to the Manage Log Files menu.

Note: After a log is paused, the Pause/Close option in the Manage Log Files menu changes to a Resume/Close option.

4.7.3 Resuming a log

```
Manage Log Files
Resume/Close
Directory
Erase Log
```

A paused log can be resumed or closed at any time. To resume or close a log, from the Manage Log Files menu select Resume/Close and press **Enter** . The following screen appears:

```
Manage Log Files
File: 06150618
RESUME CLOSE
√=Accept X=Cancel
```

Select Resume or Close and press **Enter** . The screen returns to the Manage Log Files menu.

Note: After a log is resumed, the Manage Log Files menu displays the Pause/Close option again.

Note: If a log is running and the **dew.IQ** reboots due to a power failure, the log returns to its status prior to the power failure.

4.7.4 Viewing the log directory

```
Manage Log Files
New Log
Directory
Erase Log
```

To view the existing log file names, select Directory and press **Enter** . A screen similar to the following appears :

```
File Listing
1 01270801 5 01281240
2 01270802 6 01281241
3 01270803 7 01281242
4 01281238 8 01281243
1/27/2010 08:01 162 bytes
```

When a log file is highlighted, the date, time and size of that log file is shown at the bottom of the screen . Use the arrow keys to move from one log file to another. To return to the Manage Log Files menu, press, **Cancel** .

4.7.5 Deleting log files



Manage Log Files
Pause/Close
Directory
Erase Log

To erase existing log files, from the Manage Log Files menu, select Erase Log and press **Enter** . The File Listing screen appears:

File to Erase:	
1 01270801	5 01281240
2 01270802	6 01281241
3 01270803	7 01281242
4 01281238	8 01281243
1/27/2010 08:01 162 bytes	

Using the arrow keys, move to the name of the log file to be deleted and press **Enter** . The following screen appears:

File to Erase:	
ERASE Log 01281243?	
YES	NO
√=Accept X=Cancel	

Using the arrow keys, select YES to erase the log file, or NO to keep the log file. Press **Enter**  and the screen returns to File Listing. If YES was selected, the erased log file is no longer listed. If NO was selected, the log file is still listed. Press **Cancel**  to return to the Manage Log Files menu.

4.8 Ejecting the MicroSD card

Ejecting the MicroSD card requires two steps:

1. Closing all active logs. Complete this step by following the instructions in “Pausing or Closing a Log” on page 62.
2. Ejecting the MicroSD card. Accomplish this as follows:

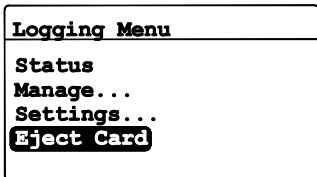

IMPORTANT:

Physically removing the MicroSD card from the **dew.IQ** without first closing all active logs and ejecting the card will not damage either the card or the **dew.IQ**, but it may result in data loss.

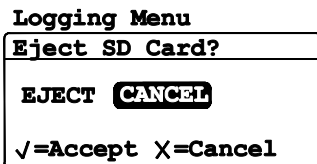

To eject the SD card, from the Logging Menu, select Eject Card and press **Enter** . The following screen appears:



Use the arrow keys to select EJECT or CANCEL and press **Enter** . The screen returns to the Logging Menu. Press **Cancel**  to return to the Main Menu.

If EJECT was selected above, the MicroSD card may now be physically removed from the **dew.IQ**. To remove and read the card see Appendix C, “Reading the MicroSD Card” on page 107.

4.9 Viewing data log files

Any standard MicroSD card reader may be used to read the **dew.IQ** MicroSD card on a PC. The log files are stored in text format , and any word processing or spreadsheet program may be used to read the data.

See "Reading the MicroSD Card " on page 107, for instructions and examples on how to work with the **dew.IQ** log files.

Chapter 5. Programming the settings menu

5.1 Entering your passcode

To access the Settings Menu, proceed as follows:

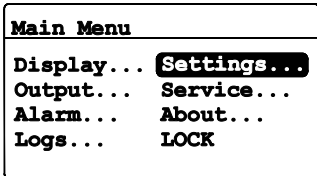



To access the Settings menu, from the Main Menu select Settings... and press **Enter** .

The Settings Menu is the only user menu that requires a passcode. The passcode is a four-digit number that enables only authorized users to enter setup data. The **dew.IQ** prompts you to enter your passcode whenever you attempt to program most of the Settings Menu options, as shown below.

IMPORTANT:

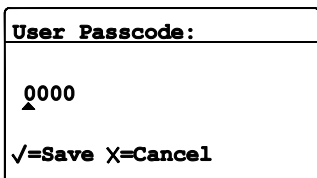
See page 125 near the end of this manual for your factory default passcode.



Use the left and right arrow keys to select each digit to be changed and the up and down arrow keys to increase or decrease its value. After the passcode has been entered, press **Enter**  to proceed.



Note: The AutoCal, Clock and DpC Offset submenus do not require a passcode for access.

Note: After entering your passcode, all menus that require the passcode for access will display a **U** in the lower right corner to indicate that the Settings menu has been Unlocked.

5.2 Setting the fault alarm

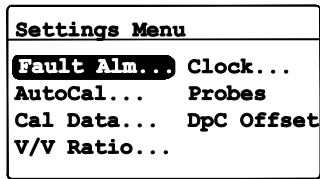
Note: Access to this menu requires a passcode (see “Entering Your Passcode” on page 67).



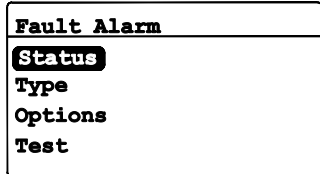

To configure the fault alarm, from the Settings Menu select Fault Alarm and press **Enter** . Then, enter your passcode and press **Enter** .

5.2.1 Setting the fault alarm status

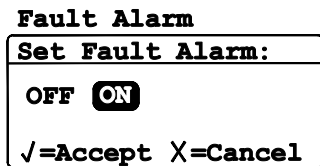

To check the status of the fault alarm, from the Fault Alarm menu, select Status and press **Enter** . The following screen appears:



To change the status of the fault alarm, select OFF or **ON** and press **Enter** . The screen returns to the Fault Alarm menu.

5.2.2 Setting the fault alarm type

Note: For more information on alarm types, see “How the Alarm Types Work” on page 49.

Fault Alarm
Status
Type
Options
Test

To check or change the fault alarm type, select Type and press **Enter** . The following screen appears:

Fault Alarm
Fault Relay:
Fail-Safe Normal
√=Accept X=Cancel



To change the type of fault alarm used, select the non-highlighted option and press **Enter** . The screen returns to the Fault, Alarm menu.

5.2.3 Setting the fault alarm options

Fault Alarm
Status
Type
Options
Test

To check or change the Fault Alarm options, select Options and press **Enter** . The following screen appears:

Fault Alarm
Alarm on Range Error
Yes No
√=Accept X=Cancel

To set the Alarm on Range Error response, select Yes or No and press **Enter** . The screen returns to the Fault Alarm menu. Then, press **Cancel**  to return to the Settings Menu.

5.2.4 Testing the fault alarm

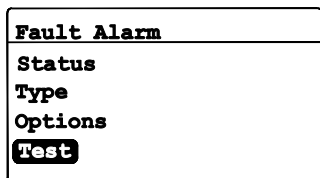

To test the Fault Alarm, select Test and press **Enter** ✓. The following screen appears:

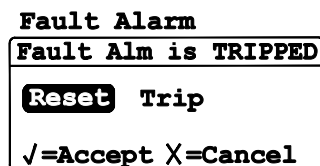

To reset the fault alarm, select Reset and press **Enter** ✓. To trip the fault alarm, select Trip and press **Enter** ✓. Press **Cancel** ✕ twice to return to the Settings Menu.

5.3 Setting AutoCal

Note: Access to this menu does not require a passcode.

Note: The AutoCal Settings menu is only available for an M Series probe. This menu is not available for an IQ probe.

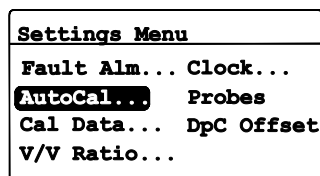

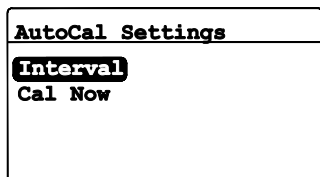

To change the AutoCal settings, from the Settings Menu select AutoCal and press **Enter** ✓. The following screen appears:



To change the AutoCal interval settings, select Interval and press **Enter** ✓. A screen similar to the following appears:

5.3 Setting AutoCal (cont.)

Enter AutoCal Interval	
Max: 72	
08 Hours	
Min: 0	
√=Save X=Cancel	

Use the left and right arrow keys to select each digit to be changed and the up and down arrow keys to increase or decrease its value. Press **Enter**  to save the new value (or **Cancel**  to keep the previous value), and return to the AutoCal Settings menu.

AutoCal Settings	
Interval	
Cal Now	

To manually initiate an immediate one-time AutoCal, select Cal Now and press **Enter** . A screen similar to the following appears:

AutoCal Settings	
AutoCal Now	
Yes No	
√=Accept X=Cancel	

To initiate the AutoCal, select Yes. To cancel the AutoCal select No. Press **Enter**  to confirm your selection and return to the AutoCal Settings menu.

5.4 Entering calibration data for an M Series probe

Note: Access to this menu requires a passcode (see “Entering Your Passcode” on page 67).

Note: If you are using an IQ.probe, see “Viewing Calibration Data for an IQ.probe” on page 75.

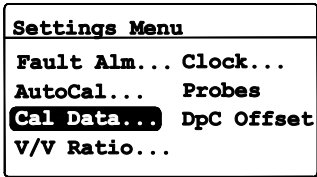

To enter M Series probe calibration data, from the Settings Menu select Cal Data and press **Enter** (✓). Then, enter your passcode and press **Enter** (✓). The following screen appears:

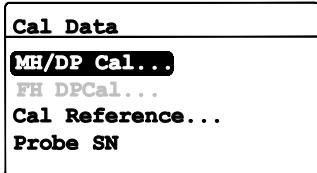

For a standard M Series probe, the MH/DP Cal option is highlighted by default. Press **Enter** (✓) and continue to the next section.

5.4.1 Selecting the number of points

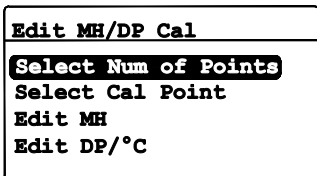

To select the number of points, highlight Select Num of Points and press **Enter** (✓). The following screen appears:

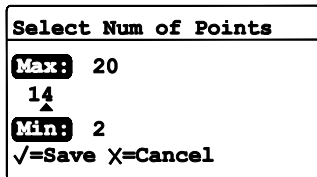

Use the left and right arrow keys to select each digit to be changed and the up and down arrow keys to increase or decrease its value. Press **Enter** (✓) to save the new value (or **Cancel** (✗) to keep the previous value), and return to Edit MH/DP Cal.

5.4.2 Selecting the calibration point

```
Edit MH/DP Cal
Select Num of Points
Select Cal Point
Edit MH
Edit DP/°C
```

To select the calibration point, highlight Select Cal Point and press **Enter** ✓. The following screen appears:

```
Select Hygro Cal Point
Max: 13
 00
^
Min: 0
√=Save X=Cancel
```

Use the left and right arrow keys to select each digit to be changed and the up and down arrow keys to increase or decrease its value. Press **Enter** ✓ to save the new value (or **Cancel** ✗ to keep the previous value), and return to the Edit MH/DP Cal menu.

5.4.3 Entering the MH calibration

```
Edit MH/DP Cal
Select Num of Points
Select Cal Point
Edit MH
Edit DP/°C
```

To enter the MH calibration value for the selected point, highlight Edit MH and press **Enter** ✓. The following screen appears:

```
Set MH [00]
Max: 4.0000
0.0000
^
Min: 0.0000
√=Save X=Cancel
```



Use the left and right arrow keys to select each digit to be changed and the up and down arrow keys to increase or decrease its value. Press **Enter** ✓ to save the new value (or **Cancel** ✗ to keep the previous value), and return to the Edit MH/DP Cal menu.

5.4.4 Entering the dew point calibration

```
Edit MH/DP Cal
Select Num of Points
Select Cal Point
Edit MH
Edit DP/°C
```

To enter the dew point calibration value for the selected point, highlight Edit DP/°C and press **Enter** . The following screen appears:

```
Set DP/°C [00]
Max: +100.00
-110.00 °C
Min: -200.00
√=Save X=Cancel
```

Use the left and right arrow keys to select each digit to be changed and the up and down arrow keys to increase or decrease its value. Press **Enter**  to save the new value (or **Cancel**  to keep the previous value), and return to the Edit MH/DP Cal menu. Press **Cancel**  to return to the Data menu.

5.5 Viewing calibration data for an IQ.probe

Note: Access to this menu requires a passcode (see “Entering Your Passcode” on page 67).

Note: If you are using an M Series probe, see “Entering Calibration Data for an M Series Probe” on page 72.

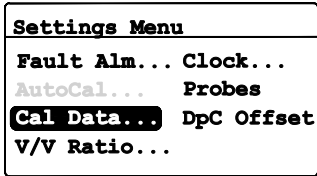

To view the IQ.probe calibration data, from the Settings Menu select Cal Data and press **Enter** ✓. Then, enter your passcode and press **Enter** ✓. The following screen appears:

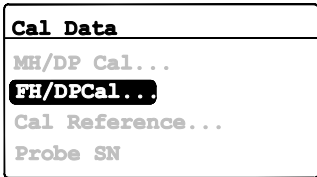

For an IQ.probe, the FH/DP Cal option is highlighted by default. Press **Enter** ✓ and continue to the next section.

5.5.1 Selecting the calibration point

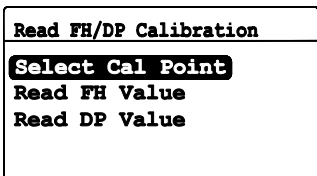

To select the calibration point, highlight Select Cal Point and press **Enter** ✓. The following screen appears:

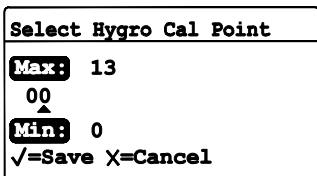

Use the left and right arrow keys to select each digit and the up and down arrow keys to increase or decrease its value. Press **Enter** ✓ to save the new value (or **Cancel** ✕ to keep the previous value), and return to Read FH/DP Calibration.

5.5.2 Reading the FH value

Read FH/DP Calibration
Select Cal Point
Read FH Value
Read DP Value

To view the FH calibration value for the selected point, highlight Read FH and press **Enter** ✓. The following screen appears:

Viewing FH [00]
Read Only
10.6821
X=Exit

The FH value is for viewing only. When you are ready, press **Cancel** ✕ to return to the Read FH/DP Calibration menu.

5.5.3 Reading the DP value

Read FH/DP Calibration
Select Cal Point
Read FH Value
Read DP Value

To view the DP calibration value for the selected point, highlight Read DP and press **Enter** ✓. The following screen appears:

Viewing DP [00]
Read Only
-110.00
X=Exit

The DP value is for viewing only. When you are ready, press **Cancel** ✕ to return to the Read FH/DP Calibration menu. Press **Cancel** ✕ twice to return to the Settings Menu.

5.6 Reading and setting the calibration references

Note: This section applies only to an M Series probe. The Cal Reference menu is not available for an IQ.probe

Note: Access to this menu requires a passcode (see “Entering Your Passcode” on page 67).

IMPORTANT:

The dew.IQ is factory programmed with high and low reference MH values. These values are generated from a factory lab calibration and should not be changed without first consulting Panametrics technical support. Changes to these values will alter the accuracy of your measurements.

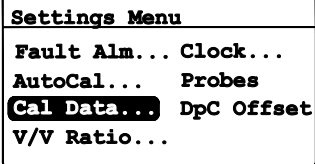

To update the calibration references, from the Settings Menu select Cal Data and press **Enter** ✓. Then, enter your passcode and press **Enter** ✓. The following screen appears:

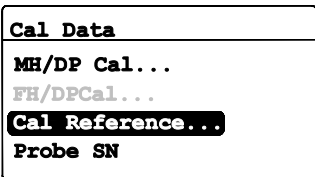

To view or edit the calibration reference settings, select Cal Reference and press **Enter** ✓. Proceed to the next section.

5.6.1 Setting the calibration high reference

Edit Cal Refs
High Reference
Low Reference

To update the high reference setting, from the Edit Cal Refs menu select High Reference and press **Enter** . A screen similar to the following appears :

High MH Ref.
Max: 15.0000
3.0419 MH
Min: 0.0000
√=Save X=Cancel

Use the left and right arrow keys to select each digit to be changed and the up and down arrow keys to increase or decrease its value. After the changes have been made, press **Enter** . The screen returns to the Edit Cal Refs menu.

5.6.2 Setting the calibration low reference

Edit Cal Refs
High Reference
Low Reference

To update the low reference setting, from the Edit Cal Refs menu select Low Reference and press **Enter** . A screen similar to the following appears :

Low MH Ref.
Max: 15.0000
0.1752 MH
Min: 0.0000
√=Save X=Cancel

Use the left and right arrow keys to select each digit to be changed and the up and down arrow keys to increase or decrease its value. After the changes have been made, press **Enter** . The screen returns to the Edit Cal Refs menu.

5.7 Entering an M Series probe serial number

Note: This section applies only to an M Series probe. The Probe SN menu is not available for an IQ probe

Note: Access to this menu requires a passcode (see “Entering Your Passcode” on page 67).

Settings Menu
Fault Alm... Clock...
AutoCal... Probes
Cal Data... DpC Offset
V/V Ratio...

To update the probe serial number, from the Settings Menu select Cal Data and press **Enter** ✓. Then, enter your passcode and press **Enter** ✓. The following screen appears:

Cal Data
MH/DP Cal...
FH/DPCal...
Cal Reference
Probe SN

To view or edit the probe serial number, select Probe SN and press **Enter** ✓. The following screen appears:

Enter M2 Probe SN
Max: 99999999
10000000 ▲
Min: 0
√=Save X=Cancel

Use the left and right arrow keys to select each digit to be changed and the up and down arrow keys to increase or decrease its value. After the changes have been made, press **Enter** ✓. The screen returns to the Cal Data menu.

5.8 Setting the volume mixing ratio

Note: Access to this menu requires a passcode (see “Entering Your Passcode” on page 67).

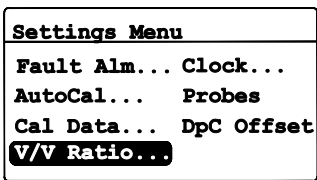

To set the volume mixing ratio, from the Settings Menu select VN Ratio and press **Enter** . Then, enter your passcode and press **Enter** . Proceed to the following sections.

5.8.1 Setting the pressure units

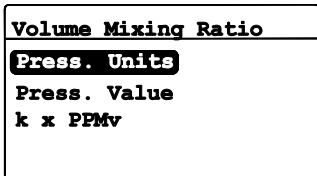

To set the pressure units, select Press. Units and press **Enter** . The following screen appears:

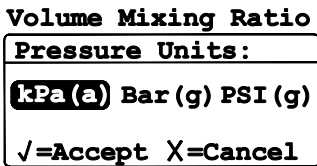

Use the left and right arrow keys to highlight the desired units. Press **Enter** to save the new units (or **Cancel** to keep the previous units) and return to the Volume Mixing Ratio menu.

5.8.2 Setting the pressure value

Volume Mixing Ratio
Press. Units
Press. Value
k x PPMv

To set the pressure value, select Press. Value and press **Enter** ✓. The following screen appears:

Line Pressure:
Max: 70000.000
00101.325 kPa(a)
Min: 0.000
√=Save X=Cancel

Use the left and right arrow keys to select each digit to be changed and the up and down arrow keys to increase or decrease its value. Press **Enter** ✓ to save the new value (or **Cancel** ✕ to keep the previous value) and return to the **Volume Mixing Ratio** menu.

5.8.3 Setting the k x PPMv multiplier

Volume Mixing Ratio
Press. Units
Press. Value
k x PPMv

To set the multiplier value, select k x PPMv and press **Enter** ✓. The following screen appears:

k x PPMv Multiplier
Max: 100.000
001.000
Min: 0.001
√=Save X=Cancel

Use the left and right arrow keys to select each digit to be changed and the up and down arrow keys to increase or decrease its value. Press **Enter** ✓ to save the new value (or **Cancel** ✕ to keep the previous value) and return to the Volume Mixing Ratio menu.

5.9 Setting the system clock

Note: Access to this menu does not require a passcode.

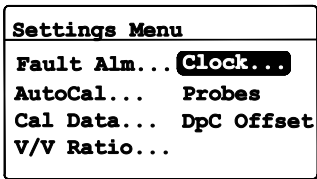

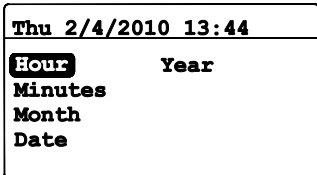

To set the system clock, from the Settings Menu select Clock and press **Enter**  to display the current day, date and time. To make changes, see the following sections.

5.9.1 Setting the hour

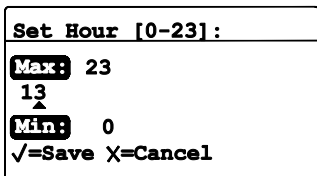

To change the hour, select Hour and press **Enter** . The following screen appears:



Use the left and right arrow keys to select each digit to be changed and the up and down arrow keys to increase or decrease its value. Press **Enter**  to save the new value (or **Cancel**  to keep the previous value) and return to the previous menu.

5.9.2 Setting the minutes

Thu 2/4/2010 13:44	
Hour	Year
Minutes	
Month	
Date	

To change the minutes, select **Minutes** and press **Enter** ✓. The following screen appears:

Set Minutes [0-59]:	
Max: 59	
44	▲
Min: 0	
√=Save X=Cancel	

Use the left and right arrow keys to select each digit to be changed and the up and down arrow keys to increase or decrease its value. Press **Enter** ✓ to save the new value (or **Cancel** ✕ to keep the previous value) and return to the previous menu.

5.9.3 Setting the month

Thu 2/4/2010 13:44	
Hour	Year
Minutes	
Month	
Date	

To change the month, select **Month** and press **Enter** ✓. The following screen appears:

Set Month [1-12]:	
Max: 12	
02	▲
Min: 1	
√=Save X=Cancel	



Use the left and right arrow keys to select each digit to be changed and the up and down arrow keys to increase or decrease its value. Press **Enter** ✓ to save the new value (or **Cancel** ✕ to keep the previous value) and return to the previous menu.

5.9.4 Setting the date

Thu 2/4/2010 13:44	
Hour	Year
Minutes	
Month	
Date	

To change the date, select Date and press **Enter** . The following screen appears:

Set Date:	
Max:	28
	04
Min:	1
√=Save X=Cancel	



Use the left and right arrow keys to select each digit to be changed and the up and down arrow keys to increase or decrease its value. Press **Enter**  to save the new value (or **Cancel**  to keep the previous value) and return to the previous menu.

5.9.5 Setting the year

Thu 2/4/2010 13:44	
Hour	Year
Minutes	
Month	
Date	

To change the year, select Year and press **Enter** . The following screen appears:

Set Year:	
Max:	2099
	2010
Min:	2007
√=Save X=Cancel	

Use the left and right arrow keys to select each digit to be changed and the up and down arrow keys to increase or decrease its value. Press **Enter**  to save the new value (or **Cancel**  to keep the previous value) and return to the previous menu.

5.10 Selecting the probe type

Note: Access to this menu requires a passcode (see “Entering Your Passcode” on page 67).

IMPORTANT:

Changing the probe type will reset the analog output, measurement alarms, fault alarm and output range to their factory default settings.

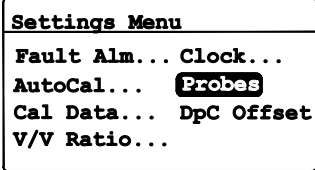

To select the probe type, from the Settings Menu select Probes and press **Enter** ✓. Then, enter your passcode and press **Enter** ✓. The following screen appears:

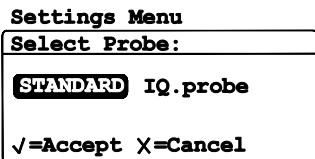

Use the left or right arrow key to select the correct probe type and press **Enter** ✓. The dew.IQ will reboot in 5 seconds.

5.11 Setting a constant DP °C offset

Note: Access to this menu does not require a passcode.



This feature enables the user to add a constant DP °C offset to all **dew.IQ** readings. It allows for positive or negative offset limiting up to $\pm 50^{\circ}\text{C}$. The constant offset only applies within the calibrated range of the probe, and the measurement alarms will use the constant offset within that range.

Use the following procedure to set the DP °C Offset:

Settings Menu	
Fault Alm...	Clock...
AutoCal...	Probes
Cal Data...	DpC Offset
V/V Ratio...	

To set a constant DP °C offset, from the Settings Menu select DpC and press **Enter** . The following screen appears:

Enter Td Offset:	
Max:	+50.00
	+05.00 °C
Min:	-50.00
√=Save X=Cancel	

Use the left and right arrow keys to select each digit to be changed and the up and down arrow keys to increase or decrease its value. Press **Enter**  to save the new value (or **Cancel**  to keep the previous value) and return to the previous menu.

Chapter 6. Service and maintenance

6.1 Introduction

The **dew.IQ** is designed to be maintenance and trouble free. However, because of severe process conditions and other factors, minor problems may occur from time to time. Some of the most common problems and recommended maintenance procedures are discussed in this chapter. If you cannot find the information you need in this chapter, please consult Panametrics for help.



CAUTION!

Do not attempt to troubleshoot the **dew.IQ** beyond the instructions in this chapter. If you do, you may damage the unit and void the warranty.

This chapter covers the following topics:

- "The Service Menu" on page 87
- "Troubleshooting Common Problems" on page 88
- "Replacing/Recalibrating Moisture Probes" on page 89
- "Cleaning the **dew.IQ** Front Panel" on page 90

Proceed to the appropriate section to perform any of the above tasks .

6.2 The service menu

The **dew.IQ** Service menu is intended for use only by trained service engineers and requires the use of a Factory-Level Passcode for access.

Service Passcode:
0000
√=Save X=Cancel

Use the left and right arrow keys to select each digit to be changed and the up and down arrow keys to increase or decrease its value. After the passcode has been entered, press **Enter**  to proceed.

6.3 Troubleshooting common problems

If the **dew.IQ** measurements read too wet or too dry, or if they do not make sense, there may be a problem with a process component of the probe. See Table 7 below to trouble shoot and solve such problems.

Possible cause	Response and action
Symptom: The accuracy of the moisture sensor is questioned	
There is insufficient time for the system to equilibrate.	<p>Response: Reads too wet during dry down conditions or too dry in wet up conditions.</p> <p>Action: Change the flow rate. A change in dew point indicates the sample system is not at equilibrium or there is a leak. Allow sufficient time for sample system to equilibrate and moisture reading to become steady. Check for leaks.</p>
Dew point at the sampling point is different from the dew point of the main stream.	<p>Response: Reads too wet or too dry.</p> <p>Action: Readings may be correct if the sampling point and main stream do not run under the same process conditions. The different process conditions cause readings to vary. If sampling point and main stream conditions are the same, check sample system pipes, and any pipe between the sample system and main stream for leaks. Also, check sample system for absorbing water surfaces, such as rubber or plastic tubing, paper-type filters, or condensed water traps. Remove or replace the contaminating parts with stainless steel parts.</p>
Sensor or sensor shield is affected by process contaminants.	<p>Response: Reads too wet or too dry</p> <p>Action: Clean the sensor and the sensor shield, then reinstall the sensor.</p>
Sensor is contaminated with conductive particles.	<p>Response: Reads high dew point</p> <p>Action: Return probe to factory for evaluation</p>
Sensor is corroded.	<p>Response: Reads too wet or too dry</p> <p>Action: Return probe to factory for evaluation</p>
Stream particles causing abrasion.	<p>Response: Reads too wet or too dry</p> <p>Action: Return probe to factory for evaluation</p>

Table 7: Troubleshooting Guide for Common Problems

6.4 Replacing/recalibrating moisture probes

For maximum accuracy, moisture probes should be returned to the factory for recalibration every 6-12 months, depending on the application. Under very severe conditions, more frequent calibrations are recommended. However, under very mild conditions, less frequent calibrations are necessary. Contact a Panametrics applications engineer for your specific recommended calibration frequency.

All new or recalibrated moisture probes must be installed in accordance with the instructions in Chapter 2, Installation.

IMPORTANT:

To maintain good contact at the terminal block and to avoid damaging the pins on the wiring connector, pull the connector straight off (not at an angle) the terminal block. Make the cable connections while the connector is off the unit. After the wiring is complete, push the connector straight onto the terminal block (not at an angle).

After the probe has been installed and wired, enter the probe calibration curve data as described in Chapter 5, Programming the Settings Menu. Each probe is shipped with its own Calibration Data Sheet, which includes the serial number for that probe.

6.5 Cleaning the dew.IQ front panel

When necessary, use the procedure below to clean the front panel of the **dew.IQ**. You will need the following items :

- Clean, lint-free cloth
- Cleaning solution (soap and warm water)

To clean the front panel, complete the following steps:

1. Moisten the cloth with the cleaning solution.
2. Gently wipe the front panel clean .
3. Use a dry cloth to dry the front panel.

Chapter 7. Specifications

7.1 Electronics

Intrinsic Safety

External safety barrier for moisture input (optional on M Series probe)

European Compliance

See the EU Declaration of Conformity at the downloads page of our website www.bakerhughes.com

Input

Moisture signal from an M Series probe or a probe

Analog Output

Single internal isolated recorder output, internally optically isolated, 10-bit (0.1%) resolution

Switch-Selectable Output Ranges

0-2 V, 10 k Ω minimum load resistance

0-20 mA, 400 Ω maximum series resistance 4-20 mA, 400 Ω maximum series resistance

The outputs are user-programmable within the range of the instrument and the corresponding sensor or transmitter.

Alarm Relays

One fail-safe system fault relay,

Two standard Form C SPDT relays, rated for 3 A at 250 VAC/30 VDC

The alarm relays may be set to any level within the range of the instrument and are programmable from the front panel.

7.1 Electronics (cont.)

Alarm Setpoint Repeatability

±0.2°F (±0.1°C) dew point

Datalogger

32 GB capacity with MicroSD card, 4 GB MicroSD card included

Display

128 x 64 matrix LCD

Display Functions

Dew point temperature °F or °C, ppmv with a constant pressure input, or sensor signals for diagnostics

Power Requirements

Universal power supply,

100-240 VAC @ 50-60 Hz or 24 VDC nominal

Temperature

Operating: -20° to 60°C (-4° to 140°F)

Storage: -40° to 70°C (-40° to 158°F)

Warm-Up Time

Meets specified accuracy within three minutes

Configurations

Panel Mount: front panel rated Type 4X and IP66

Half-Rack: 9.5"

Bench Top

Wall Mount: rated Type 4X and IP66

7.2 Moisture measurement

Sensor Type

Thin-film aluminum oxide

Moisture Probe Compatibility

Compatible with all Panametrics M-Series aluminum oxide moisture probes and the **IQ.probe**

Dew/Frost Point Temperature

Overall range capability: -110° to 60°C (-166° to 140°F)

Standard: -80 to 20°C (-112 to 68°F) with data to -110°C (-166°F)

Ultra-Low: -110 to -50°C (-166 to -58°F)

High Range Data: -80 to 60°C (-112 to 140°F)

Calibrated Accuracy at 77°F (25°C)

±2°C (±3.6°F) from -65° to 10°C (-85° to 50°F)

±3°C (±5.4°F) from -80° to -66°C (-112° to -87°F)

Repeatability

±0.5°C (±0.9°F) from -65° to 10°C (-85° to 50°F)

±1.0°C (±1.8°F) from -80° to -66°C (-112° to -87°F)

[no content intended for this page]

Appendix A. Outline and installation drawings

This appendix includes the following **dew.IQ** drawings:

- “Wall Mount Outline & Installation (ref. dwg. 712-1823, 1 of 3)” on page 96
- “Wall Mount Outline & Installation (ref. dwg. 712-1823, 2 of 3)” on page 97
- “Wall Mount Outline & Installation (ref. dwg. 712-1823, 3 of 3)” on page 98
- “Rack Mount Outline & Installation (ref. dwg. 712-1824)” on page 99
- “Panel Mount Outline & Installation (ref. dwg. 712-1825)” on page 100
- “Bench Top Outline & Installation (ref. dwg. 712-1826)” on page 101
- “Interconnection Diagram (ref. dwg. 702-1381)” on page 102

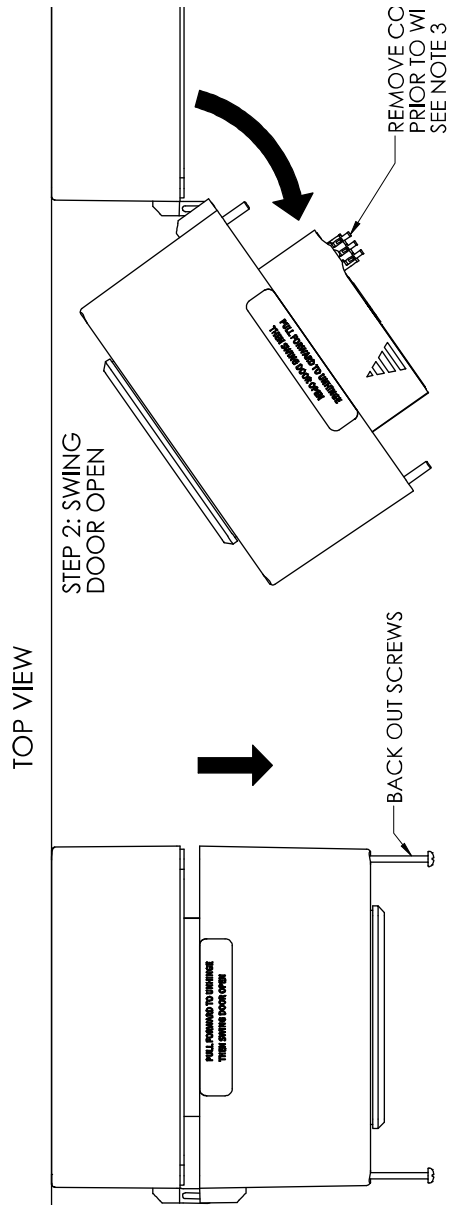

JUNCTION HOLE PATTERN

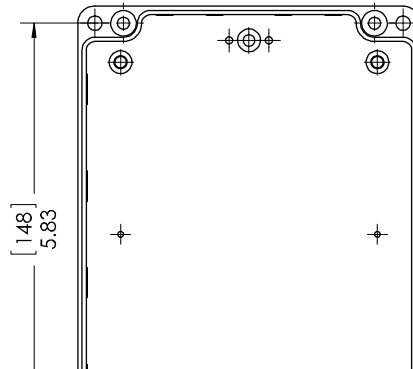

NOTES:

1. ALL DIMENSIONS ARE IN [MILLIMETERS] INCHES
2. RECOMMENDED MOUNTING HARDWARE:
 - SELF-DRILLING DRYWALL ANCHORS 4x
 - #8 x 1-1/2" MACHINE SCREWS 4x
3. REMOVE TERMINAL BLOCK CONNECTOR PRIOR TO WIRING. 18 AWG CONDUCTOR POWER CORD REQUIRED.

Figure 39: Wall Mount Outline and Installation (ref. dwg. 712-1823, 1 of 3)

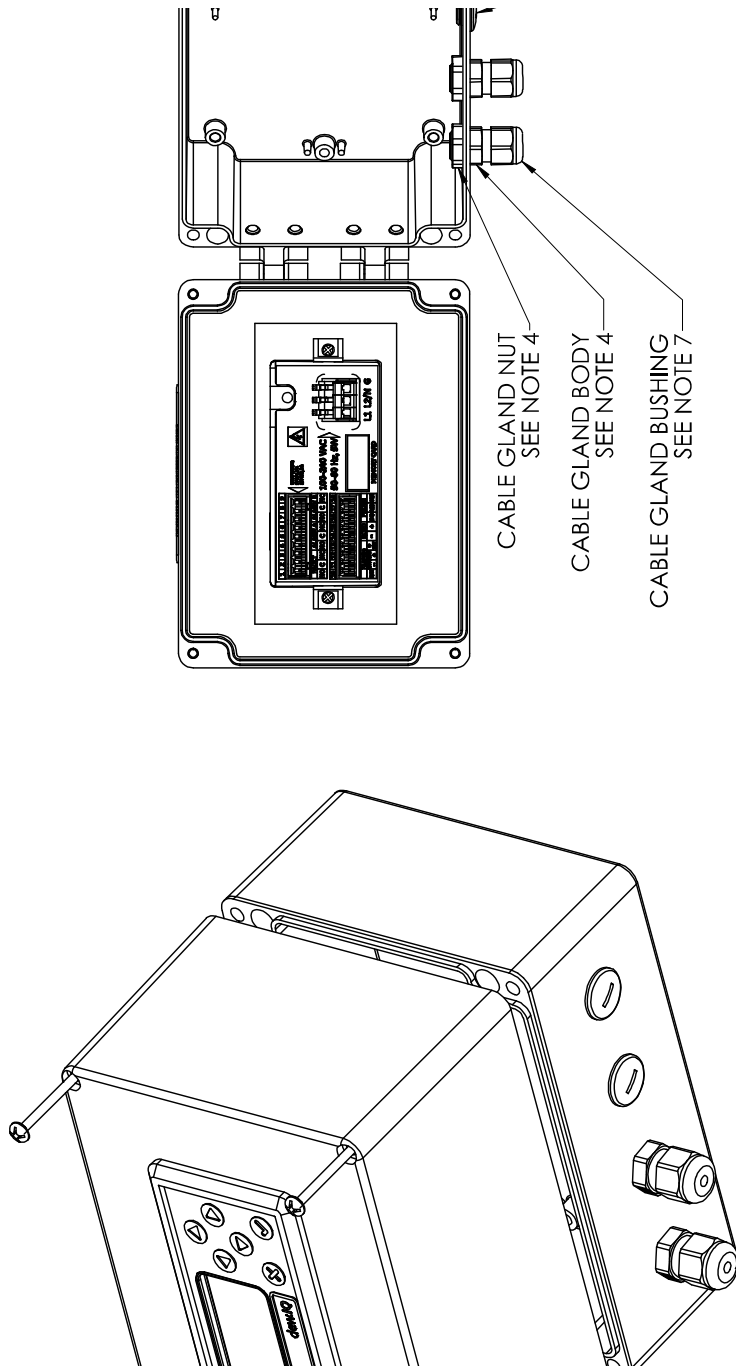

NOTES (CONT.):

4. THREAD CABLE GLAND BODY INTO ENCLOSURE. TIGHTEN ALL CABLE GLAND BODIES TO 11 in-lbs +/- 1 in-lb TO ENSURE PROPER C RING COMPRESSION. HAND-TIGHTEN CABLE GLAND NUT ON INSID OF ENCLOSURE.
5. PLUG ALL UNUSED PORTS. TIGHTEN PLUGS TO 11 in-lbs +/- 1 in-lb TO ENSURE PROPER O-RING COMPRESSION.

Figure 40: Wall Mount Outline & Installation (ref. dwg. 712-1823, 2 of 3)

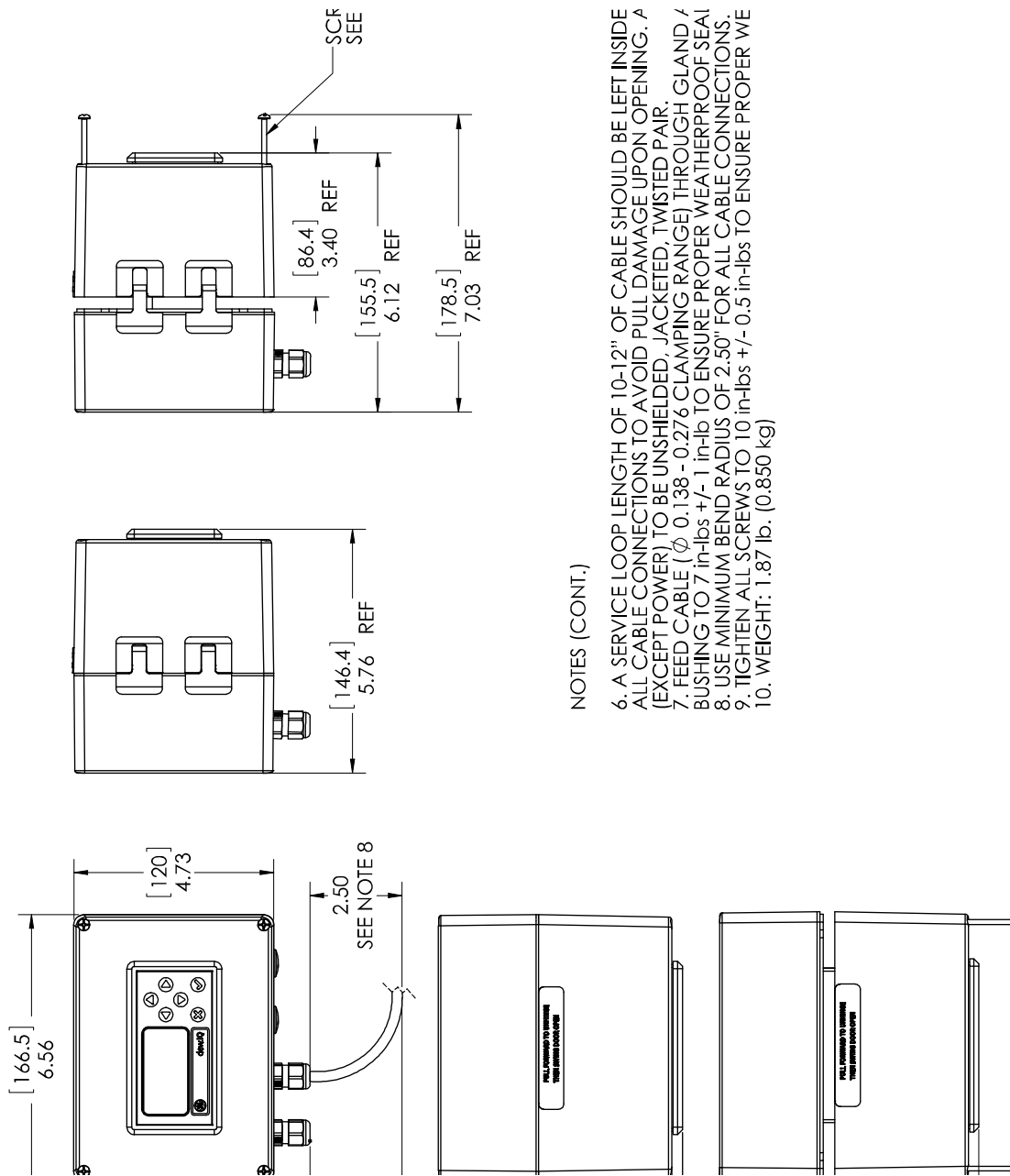

Figure 41: Wall Mount Outline & Installation (ref. dwg. 712-1823, 3 of 3)

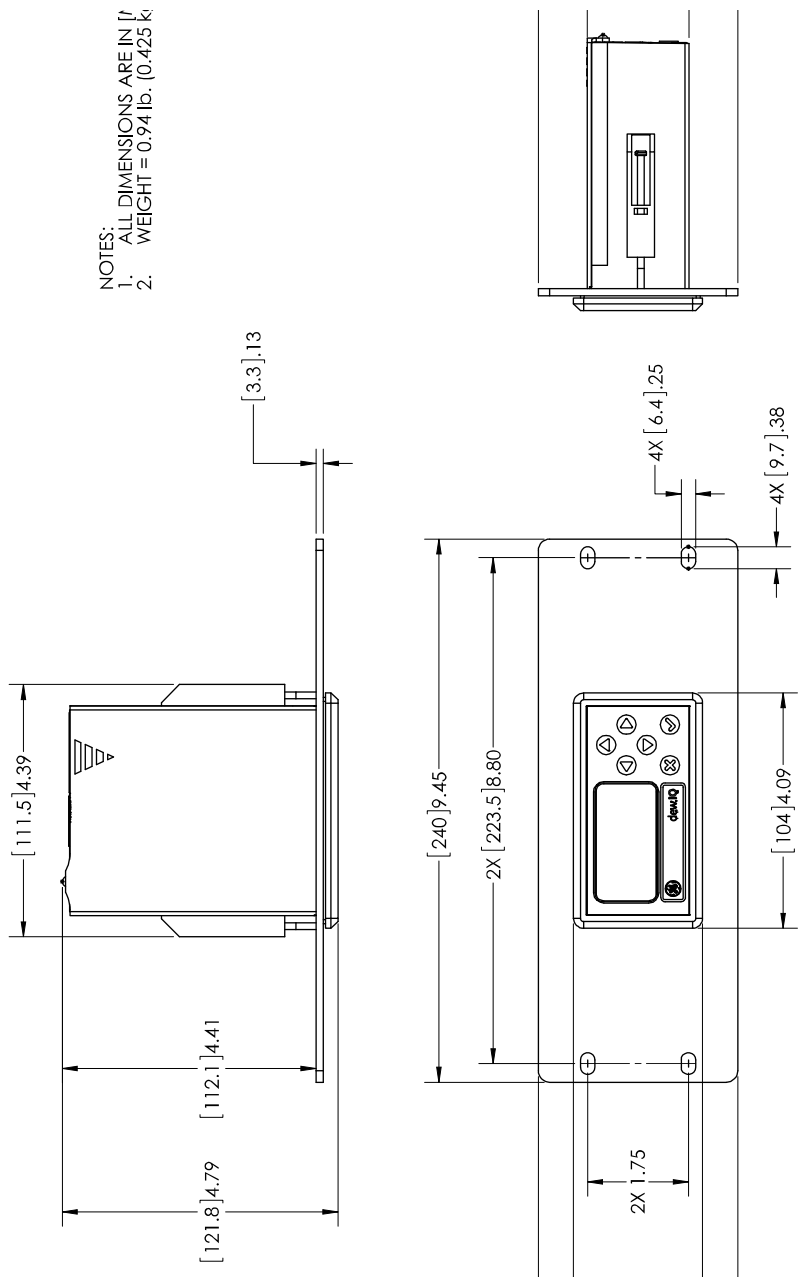

Figure 42: Rack Mount Outline & Installation (ref. dwg. 712-1824)

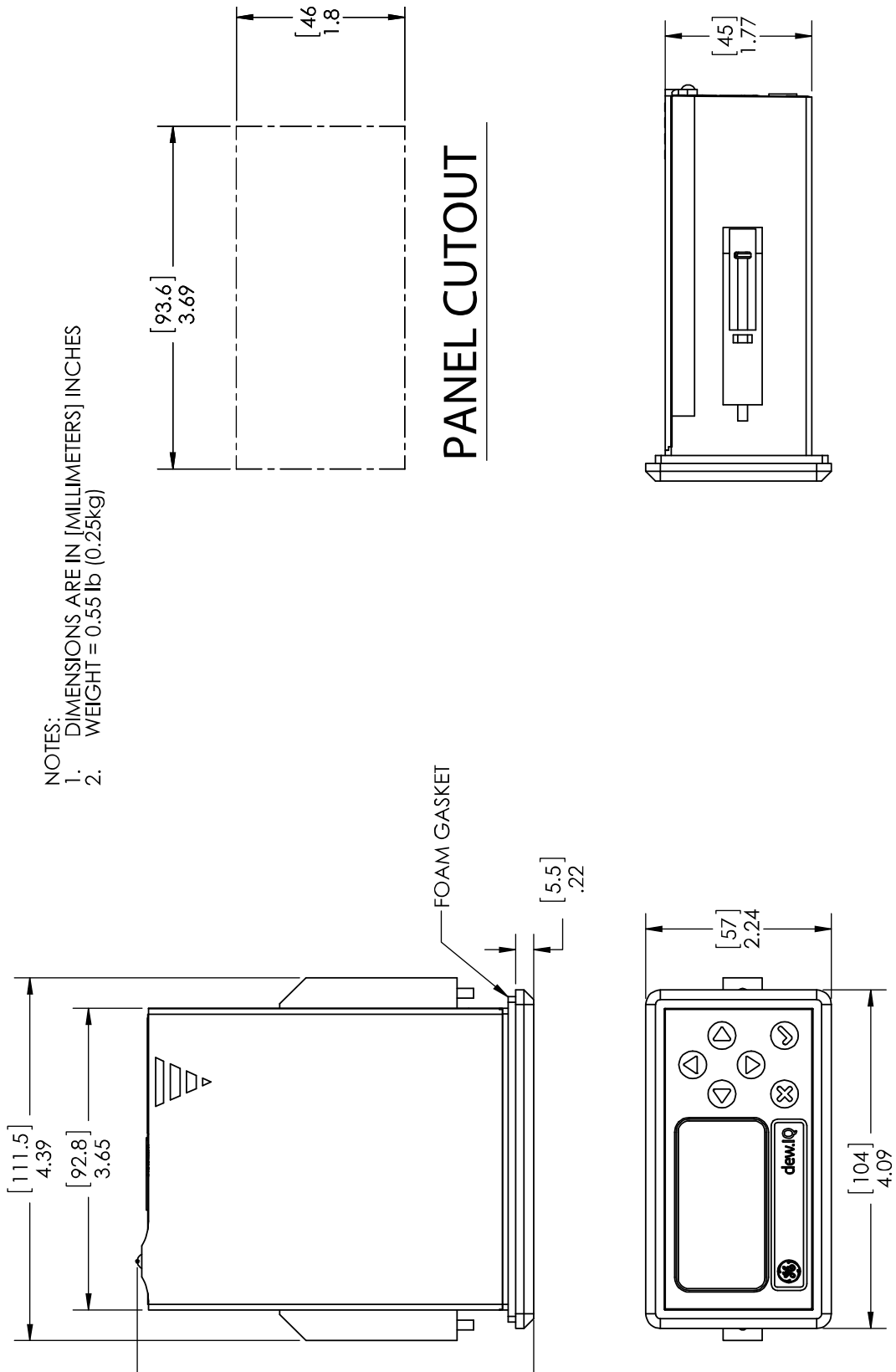

Figure 43: Panel Mount Outline & Installation (ref. dwg. 712-1825)

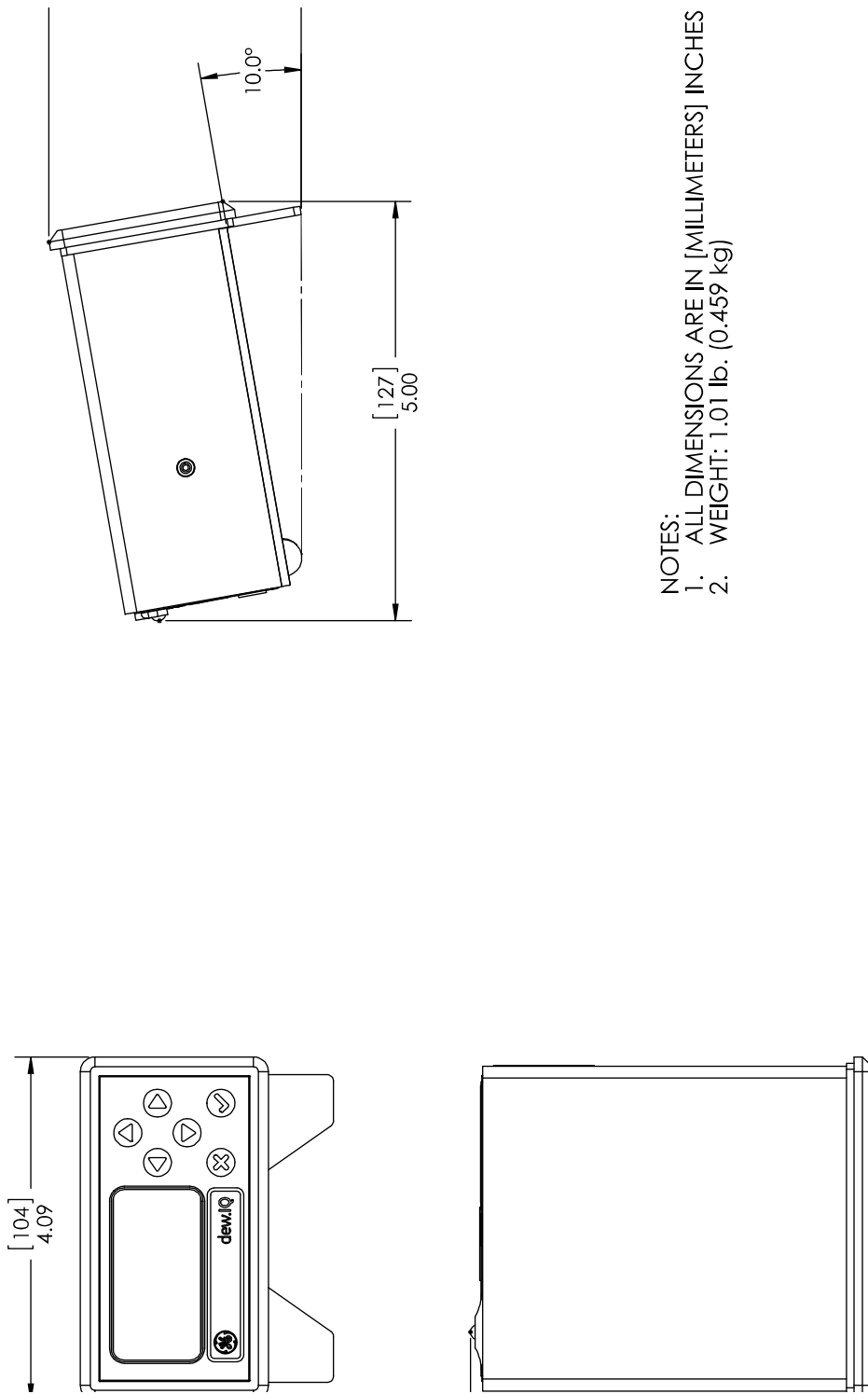
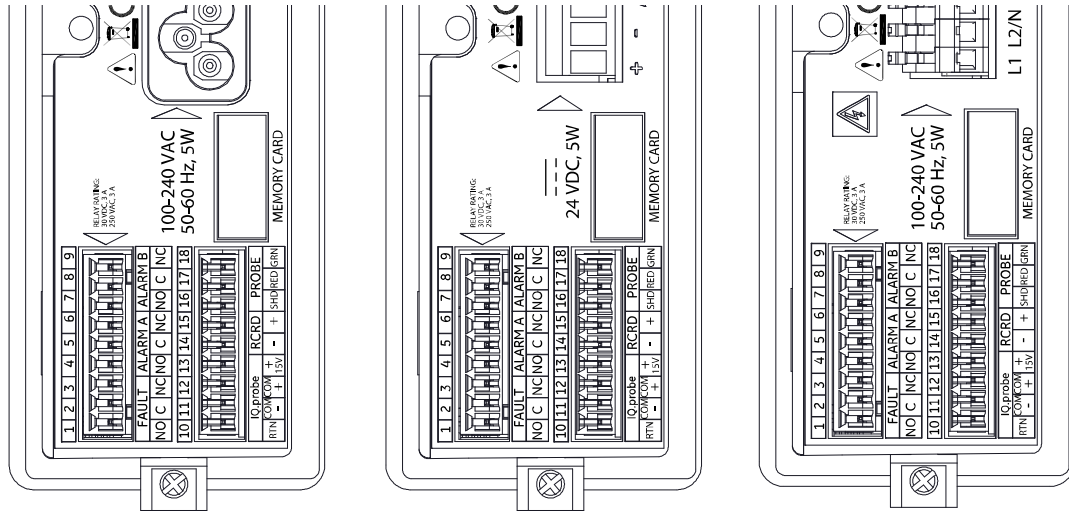
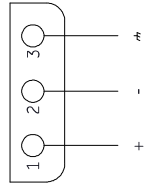

Figure 44: Bench Top Outline & Installation (ref. dwg. 712-1826)



TERMINAL BLOCK - DC POWER



TERMINAL BLOCK - AC POWER

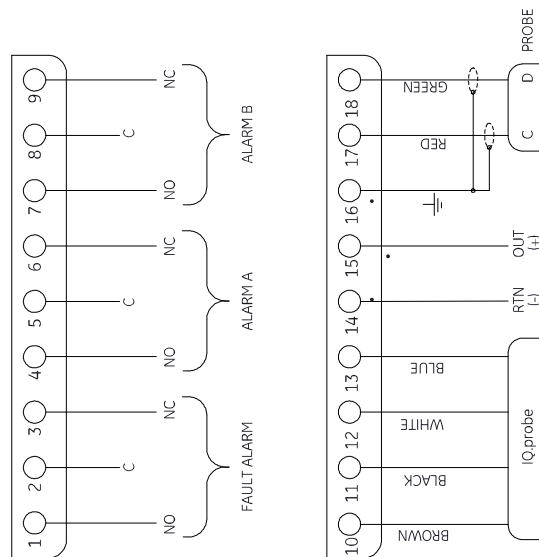
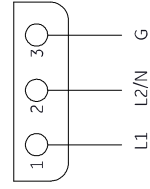

Figure 45: Interconnection Diagram (ref. dwg. 702-1381)

Appendix B. Menu maps

This appendix includes the following **dew.IQ** menu maps:

- “Main Menu Map Using M Series Probe” on page 104
- “Main Menu Map Using IQ.probe” on page 105

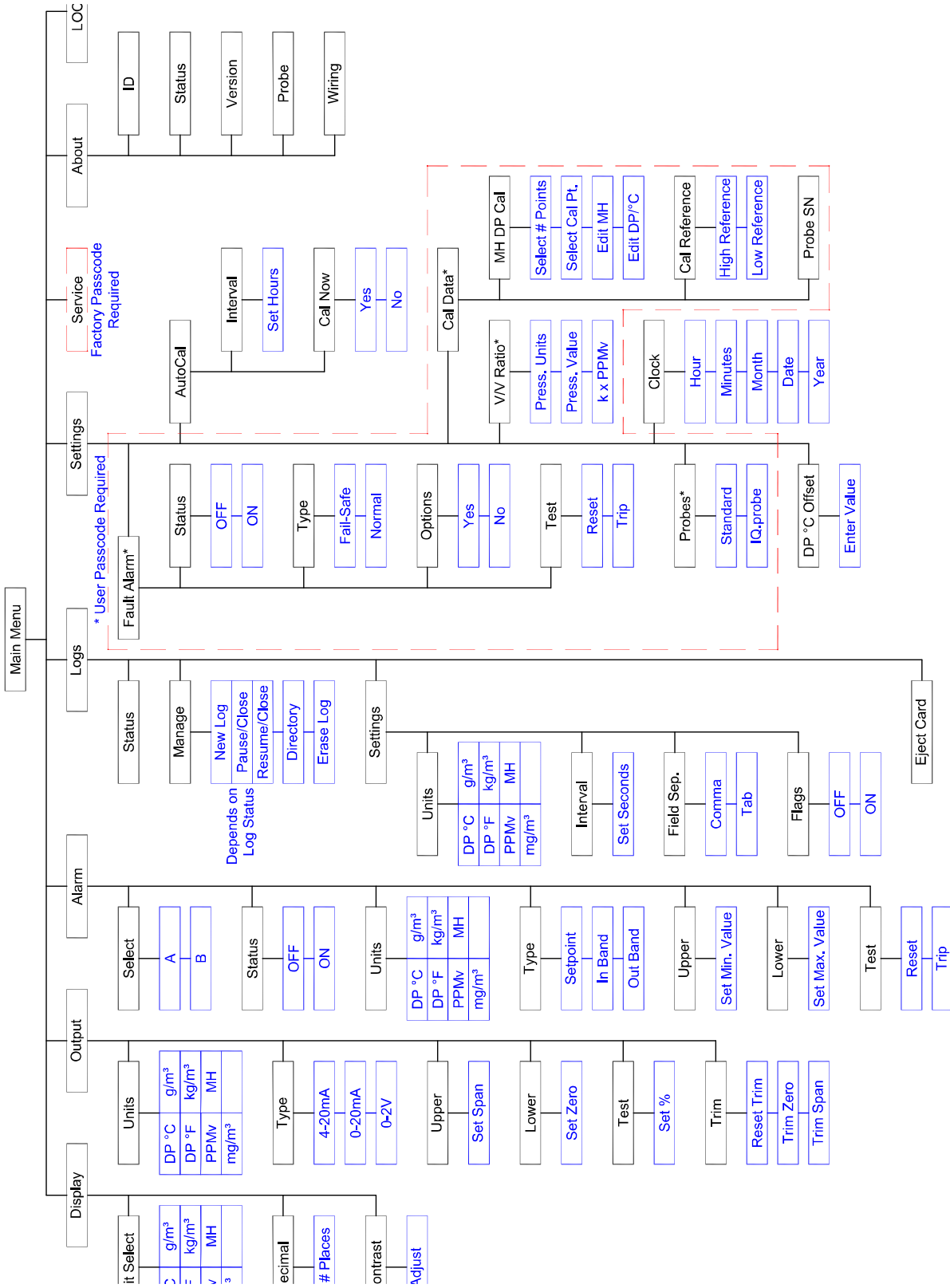

Figure 46: Main Menu Map Using M Series Probe

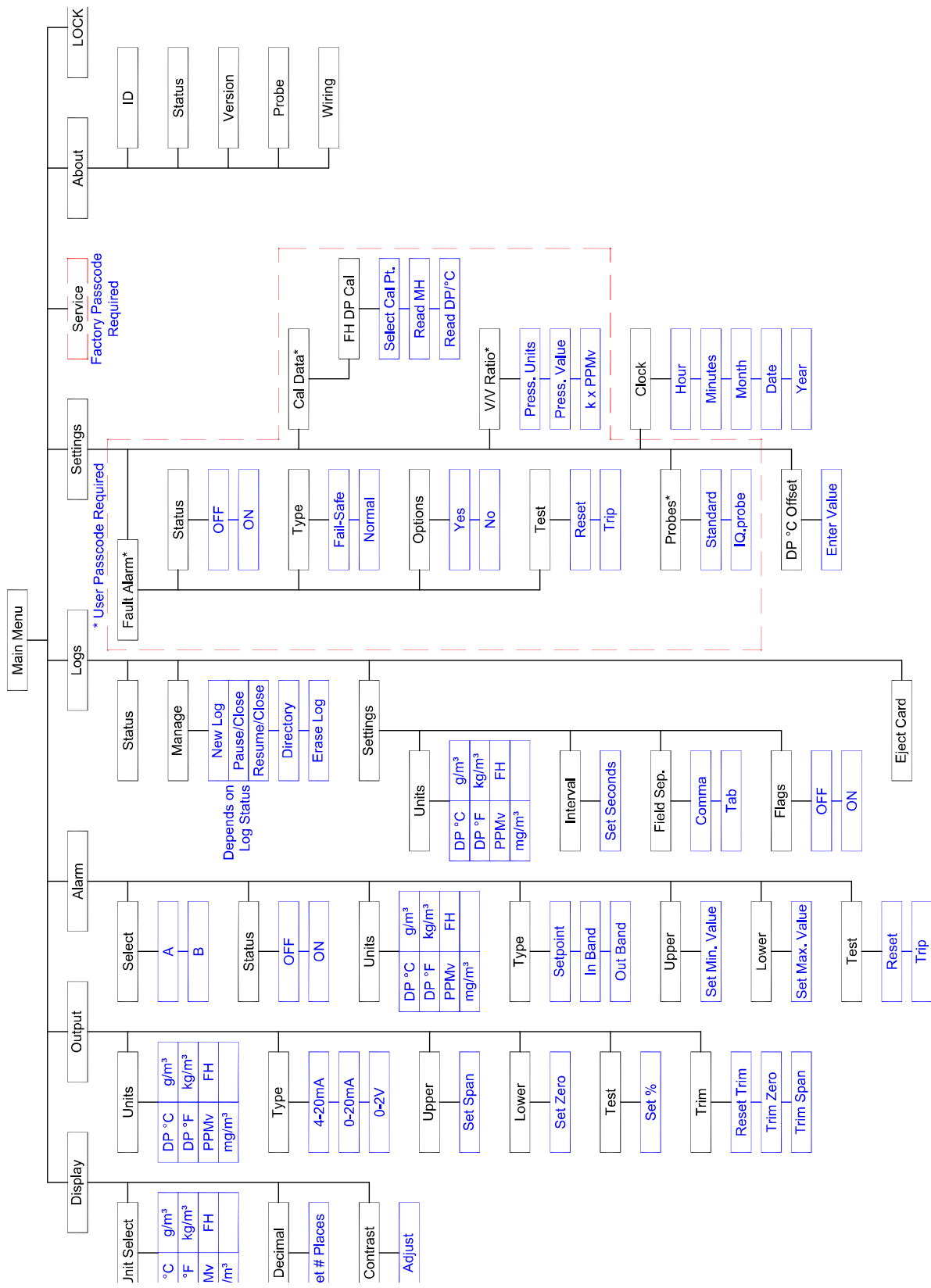

Figure 47: Main Menu Map Using IQ.probe

[no content intended for this page]

Appendix C. Reading the MicroSD card

C.1 Removing the MicroSD card

IMPORTANT:

Before physically removing the MicroSD Card, refer to "Ejecting the MicroSD Card" on page 65.

1. Locate the memory card in the lower center of the rear panel of the **dew.IQ** and pull the left side of the flexible cover. The cover is hinged on the right side (see Figure 48 and Figure 49 below).



Figure 48: Pulling the Flexible Cover



Figure 49: The Exposed Memory Card Holder

C.1 Removing the MicroSD card (cont.)

2. Push in the memory card until it clicks and then release it (see Figure 50 below).



Figure 50: Pushing in on the MicroSD Card

3. After the MicroSD card is partially ejected, pull it from the **dew.IQ** chassis (see Figure 51 below).

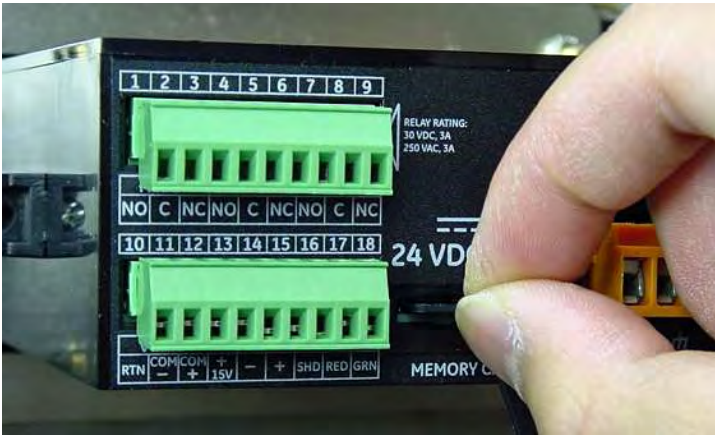

Figure 51: Removing the MicroSD Card

C.2 Connecting the MicroSD card to a PC

1. Plug the MicroSD card into a card reader (see Figure 52 below)



Figure 52: Plugging the MicroSD Card into a Card Reader

2. Connect the card reader to a PC (see Figure 53 below).



Figure 53: Plugging the Card Reader into a PC

C.3 Accessing the log files

1. From the PC, open **My Computer** and find the card reader in the "Devices with Removable Storage" section. (see Figure 54 below).



Figure 54: Locating the Card Reader

C.3 Accessing the log files (cont.)

- Click on the Removable Disk icon and a window similar to Figure 55 below opens. The available log files are listed in the window.

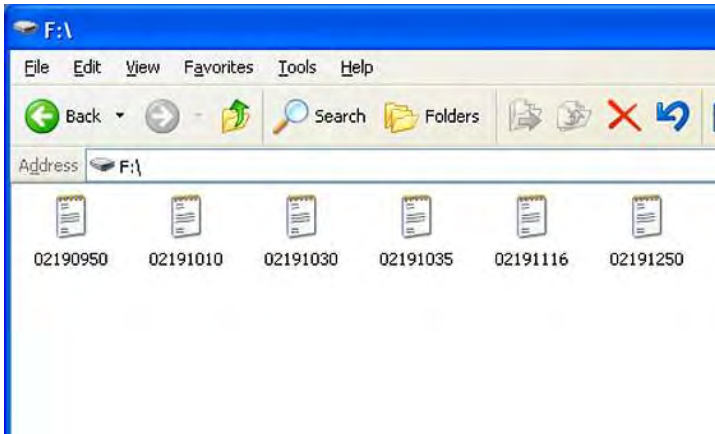
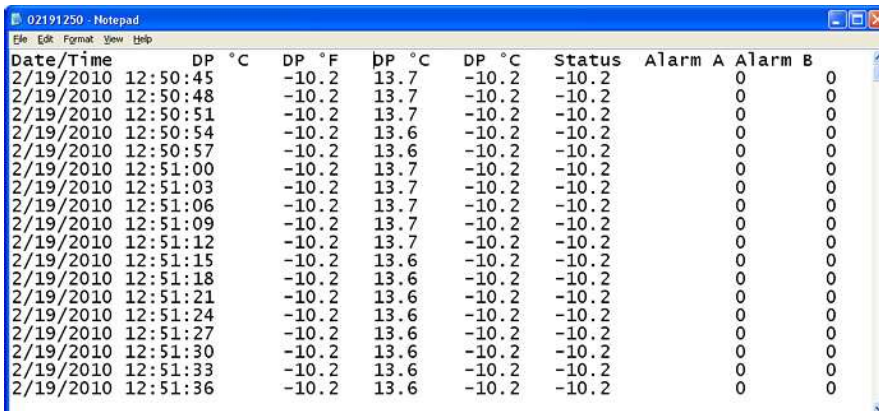

Figure 55: List of Log Files

- Click on the desired log file and a window similar to Figure 56 below opens. The data in the log file is listed in the window.



Date/Time	DP °C	DP °F	DP °C	DP °C	Status	Alarm A	Alarm B
2/19/2010 12:50:45	-10.2	13.7	-10.2	-10.2	-10.2	0	0
2/19/2010 12:50:48	-10.2	13.7	-10.2	-10.2	-10.2	0	0
2/19/2010 12:50:51	-10.2	13.7	-10.2	-10.2	-10.2	0	0
2/19/2010 12:50:54	-10.2	13.6	-10.2	-10.2	-10.2	0	0
2/19/2010 12:50:57	-10.2	13.6	-10.2	-10.2	-10.2	0	0
2/19/2010 12:51:00	-10.2	13.7	-10.2	-10.2	-10.2	0	0
2/19/2010 12:51:03	-10.2	13.7	-10.2	-10.2	-10.2	0	0
2/19/2010 12:51:06	-10.2	13.7	-10.2	-10.2	-10.2	0	0
2/19/2010 12:51:09	-10.2	13.7	-10.2	-10.2	-10.2	0	0
2/19/2010 12:51:12	-10.2	13.7	-10.2	-10.2	-10.2	0	0
2/19/2010 12:51:15	-10.2	13.6	-10.2	-10.2	-10.2	0	0
2/19/2010 12:51:18	-10.2	13.6	-10.2	-10.2	-10.2	0	0
2/19/2010 12:51:21	-10.2	13.6	-10.2	-10.2	-10.2	0	0
2/19/2010 12:51:24	-10.2	13.6	-10.2	-10.2	-10.2	0	0
2/19/2010 12:51:27	-10.2	13.6	-10.2	-10.2	-10.2	0	0
2/19/2010 12:51:30	-10.2	13.6	-10.2	-10.2	-10.2	0	0
2/19/2010 12:51:33	-10.2	13.6	-10.2	-10.2	-10.2	0	0
2/19/2010 12:51:36	-10.2	13.6	-10.2	-10.2	-10.2	0	0

Figure 56: Log File Data

C.3 Accessing the log files (cont.)

4. The **dew.IQ** log files can be opened with a spreadsheet program, such as Microsoft Excel. Launch the spreadsheet program and select **Open** (see Figure 57 below).

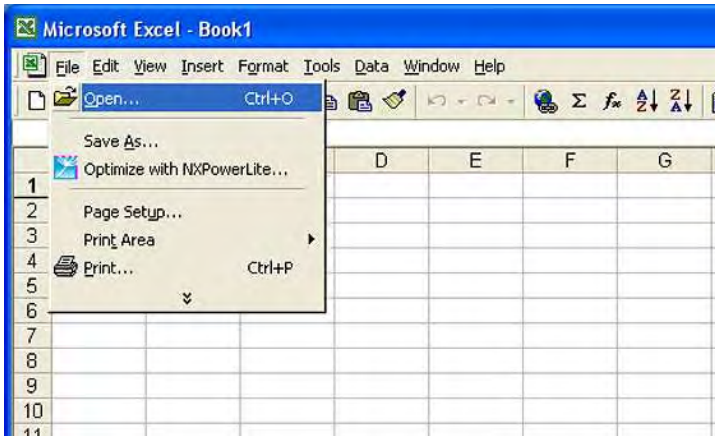

Figure 57: Opening a Log File in Microsoft Excel

5. Click on the name of the desired log file (see Figure 58 below).

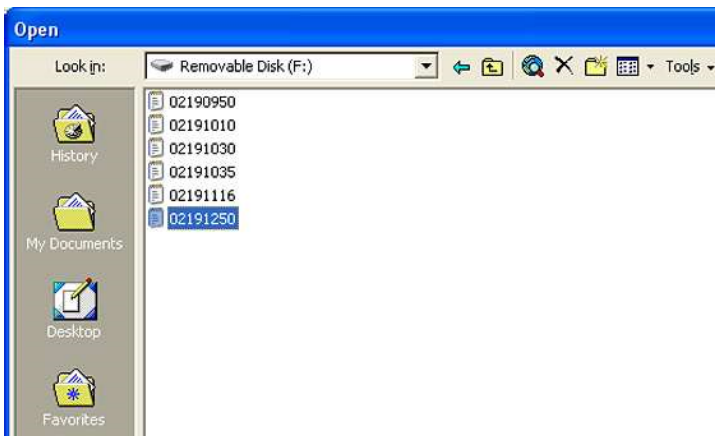

Figure 58: Selecting the Log File to Open

C.4 Setting up a log file

1. Make sure that the file type is set to "All Types" and then open the selected log file by double clicking on the file name. A window similar to the one in Figure 59 below will open.

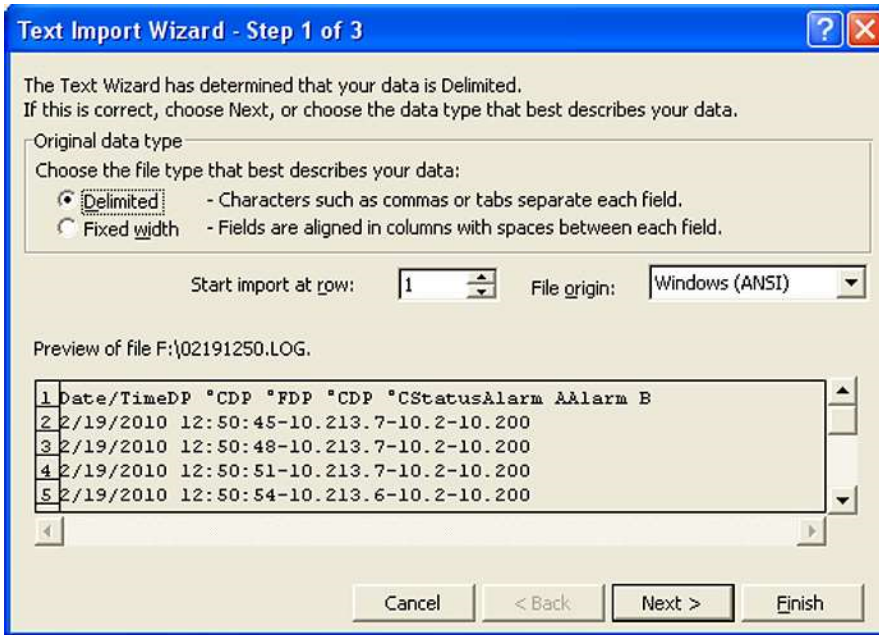

Figure 59: Microsoft Excel Import Wizard - Step 1

C.4 Setting Up a log file (cont.)

2. Follow the directions on the screen, make changes if necessary, and then click on **Next**. A window similar to the one in Figure 60 below will open.



Figure 60: Microsoft Excel Import Wizard - Step 2

C.4 Setting Up a log file (cont.)

3. Select the desired data delimiters, and click on **Next >**. A window similar to the one in Figure 61 below will open.
4. Select each column and set the desired data format for that column (see Figure 61 below).

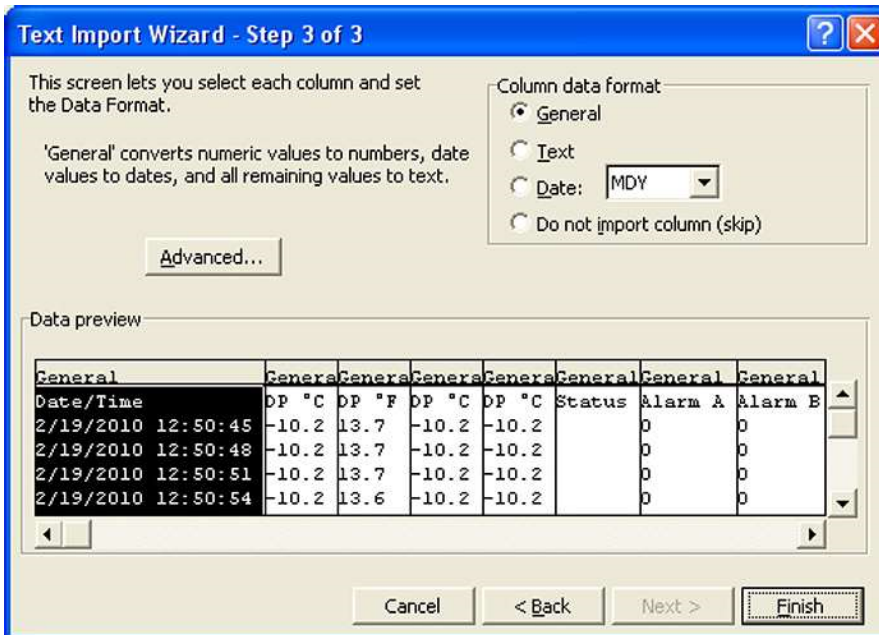
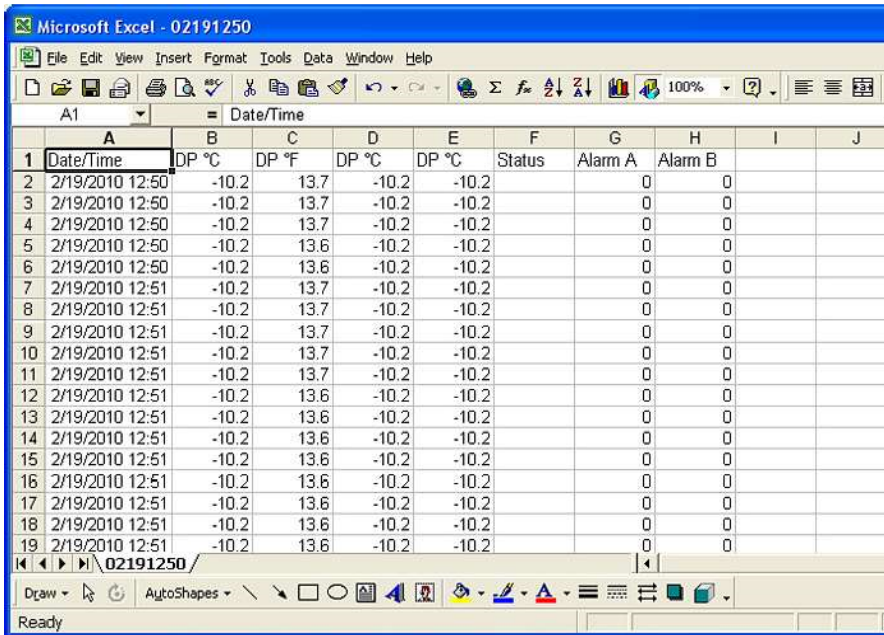

Figure 61: Microsoft Excel Import Wizard - Step 3

C.4 Setting Up a log file (cont.)

- When the setup is complete, click on Finish, and a window similar to Figure 62 below will open . The log file is now properly formatted for graphing or analysis, and the results may be saved as a standard spreadsheet file for future use.



The screenshot shows a Microsoft Excel spreadsheet with the following data:

	A	B	C	D	E	F	G	H	I	J
1	Date/Time	DP °C	DP °F	DP °C	DP °C	Status	Alarm A	Alarm B		
2	2/19/2010 12:50	-10.2	13.7	-10.2	-10.2		0	0		
3	2/19/2010 12:50	-10.2	13.7	-10.2	-10.2		0	0		
4	2/19/2010 12:50	-10.2	13.7	-10.2	-10.2		0	0		
5	2/19/2010 12:50	-10.2	13.6	-10.2	-10.2		0	0		
6	2/19/2010 12:50	-10.2	13.6	-10.2	-10.2		0	0		
7	2/19/2010 12:51	-10.2	13.7	-10.2	-10.2		0	0		
8	2/19/2010 12:51	-10.2	13.7	-10.2	-10.2		0	0		
9	2/19/2010 12:51	-10.2	13.7	-10.2	-10.2		0	0		
10	2/19/2010 12:51	-10.2	13.7	-10.2	-10.2		0	0		
11	2/19/2010 12:51	-10.2	13.7	-10.2	-10.2		0	0		
12	2/19/2010 12:51	-10.2	13.6	-10.2	-10.2		0	0		
13	2/19/2010 12:51	-10.2	13.6	-10.2	-10.2		0	0		
14	2/19/2010 12:51	-10.2	13.6	-10.2	-10.2		0	0		
15	2/19/2010 12:51	-10.2	13.6	-10.2	-10.2		0	0		
16	2/19/2010 12:51	-10.2	13.6	-10.2	-10.2		0	0		
17	2/19/2010 12:51	-10.2	13.6	-10.2	-10.2		0	0		
18	2/19/2010 12:51	-10.2	13.6	-10.2	-10.2		0	0		
19	2/19/2010 12:51	-10.2	13.6	-10.2	-10.2		0	0		

Figure 62: Successful Log File Import

Index

A

About Menu.....	52
Alarm Menu.....	46
Alarm Relays	
Alarm Types.....	49
Fault Alarm.....	29
Fault Alarm, Checking Status.....	68
Fault Alarm, Setting.....	68
Fault Alarm, Setting Options.....	69
Fault Alarm, Setting Type.....	69
Fault Alarm, Testing.....	70
Measurement, Selecting an Output.....	46
Measurement, Selecting Status.....	47
Measurement, Selecting Type.....	48
Measurement, Selecting Units.....	47
Measurement, Setting the Span.....	50
Measurement, Setting the Zero.....	50
Measurement, Setting Up.....	46
Specifications.....	91
Testing.....	51
Wiring.....	27
Alarm Types Explained.....	49
Alarms	
See Alarm Relays	
Analog Output	
Changing the Span.....	41
Changing the Zero.....	42
Ranges.....	91
Selecting I or V.....	4
Selecting Type.....	41
Selecting Units.....	40
Setting Up.....	40
Signal Specifications.....	91
Testing.....	43
Trimming.....	44
AutoCal	
Initiate Now.....	71
Setting.....	70

B

Bench Mount, Installation.....	13
--------------------------------	----

C

Cable	
IQ.probe.....	24
M Series Probe.....	21
Calibration	
Entering Data, M Series Probe.....	72
Probe, Factory.....	89
Reading and Setting References.....	77
Viewing Data, IQ.probe.....	75
Clock, Setting.....	82
Contrast, Adjusting.....	39

D

Data logging	
Programming.....	57
Specifications.....	92
dew.IQ	
Configurations.....	8, 92
Features.....	1
Removing the Top Cover.....	5
Wiring Connections.....	18

Display Menu

Adjusting the Contrast.....	39
Programming.....	38
Selecting Primary Units.....	38
Setting Number of Decimal Places.....	39
Document Number.....	i
Drawings, Outline and Installation.....	95

E

Ejecting the MicroSD Card.....	65
Electronics	
Features.....	1
Mounting.....	8
Specifications.....	91
European Compliance.....	91

F

Fault Alarm	
Description	29
Setting	68
Wiring	29
Features & Capabilities	1

G

Gasket, Panel Mount Installation	9
--	---

H

ID, Checking	52
Initial Setup	35
Input Power, Specifications	92
Installation	
Bench Mount	13
Drawings	95
Panel Mount	8
Probe	16
Rack Mount	12
Wall Mount	14
Interconnection Diagram	102
Intrinsic Safety	91
IQ.probe	
Photograph	2
Viewing Calibration Data	75

K

k x PPMv Multiplier, Setting	81
------------------------------------	----

L

Lock Menu	55
Logs	
Checking the Status	57
Creating a New Log	61
Deleting Log Files	64
Managing Log Files	61
Menu	57
Setting a Field Separator	59
Setting Status Flags	60
Setting the Interval	59
Setting Units	57
Settings Menu	57
Viewing Log Files	63, 66

M

M Series Probe	
Entering Clibration Data	72
Photograph	2
Main Menu	
About Menu	52
Accessing	36
Alarm Menu	46
Display Menu	38
Lock Menu	55
Logs Menu	57
Menu Map, IQ.probe	105
Menu Map, M Series Probe	104
Output Menu	40
Service Menu	87
Settings Menu	67

Menu Map

Main Menu, IQ.probe	105
Main Menu, M Series Probe	104

MicroSD Card

Accessing the Log Files	110
Checking Status	53
Connecting to a PC	109
Ejecting	65
Reading	107
Removing	107
Setting Up a Log File	113

Moisture Measurement, Specifications	93
--	----

Moisture Signal, Specifications	91
---------------------------------------	----

Mounting

Electronics	8
Sample System	15

Multiplier, Setting k x PPMv	81
------------------------------------	----

N

Numeric Values, Entering	37
--------------------------------	----

O

Offset, Entering Constant DP °C	86
Outline and Installation Drawings	95
Output Menu	40

P

Panel Mount	
Gasket	9
Installation	8
Passcode	
Factory Level	87
User, Entering	67
User, Factory Default	125
PC Board	
Access	5
SI Location	7
Power Input	
Connecting AC Cord	30
Connecting AC Terminals	33
Connecting DC Terminals	31
Probe	
Checking Information	54
Entering Calibration Data, M Series	72
Entering Serial Number, M Series	79
Installing	16
IQ.probe Cable	24
IQ.probe Wiring	24
M Series Probe Cable	21
M Series Probe Wiring	21
Mounted in Sample Cell	17
Replacing/Recalibrating	89
Probe Types	
IQ.probe	2
M Series	2
Selecting	85
Problems, Troubleshooting	88
Publication Date	i

R

Rack Mount, Installation	12
Ranges, Analog Output	91
Recalibrating the Probe	89
Recorder	
see Analog Output	
References, Calibration	77
Replacing the Probe	89

S

Sample Cell	
Description	16
Photograph	17
Sample System, Mounting	15
Serial Number	
Entering for M Series Probe	79
Viewing for IQ.probe	54
Service Menu	87
Settings Menu	67
Software Version, Checking	53
Specifications	91
Alarm Relays	91
Analog Output Signal	91
Data Logging	92
Electronics	91
European Compliance	91
Input Power	92
Intrinsic Safety	91
Moisture Measurement	93
Moisture Signal	91
Temperature	92
Warm-Up Time	92
Starting Up	36
Support	
Customer Support Centers	2
Switch SI	7
System Information	52
Checking MicroSD Card Status	53
Checking the ID	52
Checking the Probe	54
Checking the Software Version	53
Checking the Wiring Diagram	55

T

Temperature, Specifications	92
Testing	
Analog Output	43
Fault Alarm	70
Measurement Alarms	51
Trimming, Analog Output	44
Troubleshooting Guide	88

V

Volume Mixing Ratio, Setting	80
------------------------------------	----

W

Wall Mount, Installation	14
--------------------------------	----

Warm-Up Time	92
--------------------	----

Wiring

Alarm Relays	27
--------------------	----

Checking the Diagram	55
----------------------------	----

dew.IQ	18
---------------------	----

Diagram, AC Cord	19
------------------------	----

Diagram, AC Terminals	20
-----------------------------	----

Diagram, DC Terminals	19
-----------------------------	----

Interconnection Diagram	102
-------------------------------	-----

IQ.probe	24
----------------	----

M Series Probe	21
----------------------	----

Power Input, AC Cord	30
----------------------------	----

Power Input, AC Terminals	33
---------------------------------	----

Power Input, DC Terminals	31
---------------------------------	----

Default factory passcode

Your passcode is 2719

Please remove this page and put it in a safe place for future reference.

[no content intended for this page]

Customer support centers

Americas

U.S.A.

The Boston Center
1100 Technology Park Drive
Billerica, MA 01821

U.S.A.

Tel: +1 800 833 9438 (toll-free)

Tel: +1 978 437 1000

E-mail: mstechsupport@bhge.com

Europe

Ireland

Sensing House
Shannon Free Zone East
Shannon, County Clare
Ireland

Tel: +353 61 61470200

E-mail: mstechsupport@bhge.com

Panametrics, a Baker Hughes Business, provides solutions in the toughest applications and environments for moisture, oxygen, liquid and gas flow measurement. Experts in flare management, Panametrics technology also reduces flare emissions and optimizes performance.

With a reach that extends across the globe, Panametrics' critical measurement solutions and flare emissions management are enabling customers to drive efficiency and achieve carbon reduction targets across critical industries including: Oil & Gas; Energy; Healthcare; Water and Wastewater; Chemical Processing; Food & Beverage and many others.

Join the conversation and follow us on LinkedIn
[linkedin.com/company/panametricscompany](https://www.linkedin.com/company/panametricscompany)