

Thank you for purchasing our CW120 or CW121 Clamp-on Power Meter. This Operation Guide explains the fundamental operations of the CW120 and CW121 so as to get you started using the CW120 or CW121 even if you are a first-time user.

For more information of measurement and details of each function, see the User's Manual, IM CW120-E. To ensure safe and correct use of the CW120 and CW121, thoroughly read the handling precautions in User's Manual, IM CW120-E, before use.

Before starting measurement with your CW120 or CW121, fill in the Setting Check Sheet in the back of this guide with your particular settings, to facilitate setting on site without error.

Contents

1. Functions and Operation Flow	2
2. Operation Keys and Terminals	4
3. Display <Section 2.4>	5
4. Browsing Measured Values <Sections 8.2 and 9.3>	6
5. Changing Range Settings <Sections 6.2 and 6.3>	6
6. Changing Wiring Method <Section 6.4>	7
7. Changing Settings <Chapter 7>	8
8. Saving Data	9
9. Starting and Ending Integration <Section 9.2>	10
10. Meanings of Messages <Section 2.4>	10
Setting Check Sheet	11

Throughout this manual, references to sections or chapters of the User's Manual (IM CW120-E) are enclosed in angle brackets, such as <Chapter 4>.

1. Functions and Operation Flow

● Schematic Function Diagram

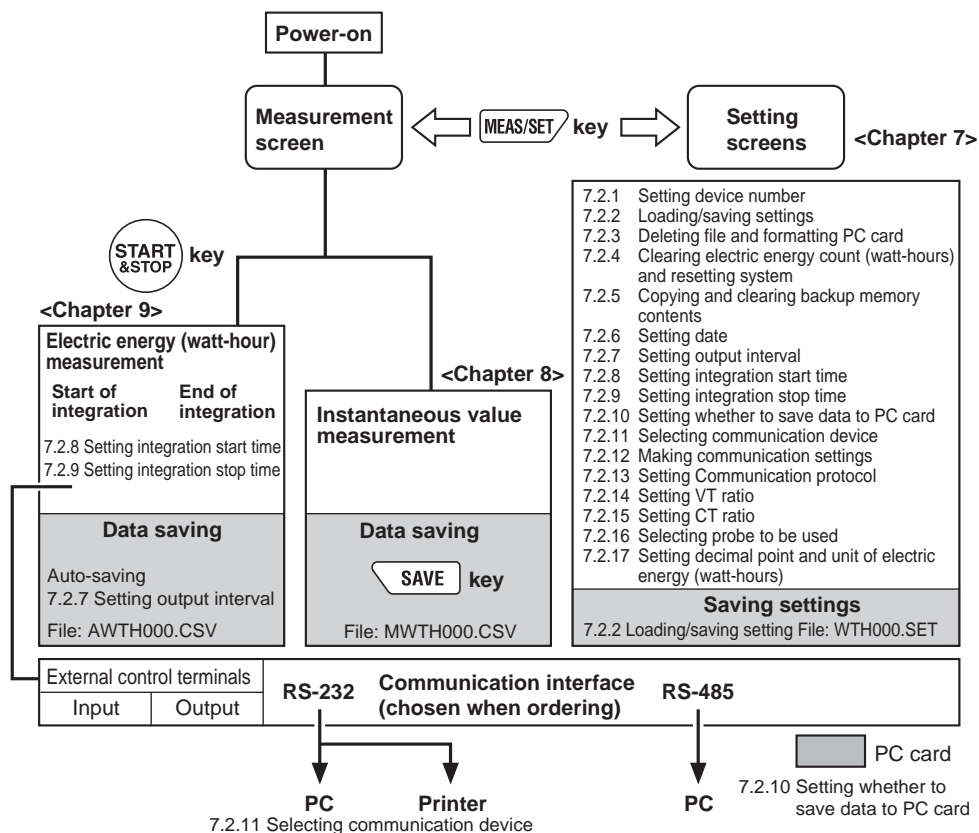

● On-screen Information (Measured Data)

Instantaneous value measurement

Item	Unit	Displayed Name
Rms voltage	V	V1, V2, V3 (differs depending on the wiring method)
Rms current	A	A1, A2, A3 (differs depending on the wiring method)
Active power	W	W, W1, W2, W3 (differs depending on the wiring method)
Reactive power	Var	Var, Var1, Var2, Var3 (differs depending on the wiring method)
Power factor	—	PF, PF1, PF2, PF3 (differs depending on the wiring method)
Frequency	Hz	Hz (input frequency of V1)

Electric energy measurement

Item	Unit	Displayed Name
Active electric energy	Wh	Wh, Wh1, Wh2, Wh3 (differs depending on the wiring method)
Regenerative electric energy	Wh	Only saved; not displayed

Six items of instantaneous value measurement

● Basic Operation Flow

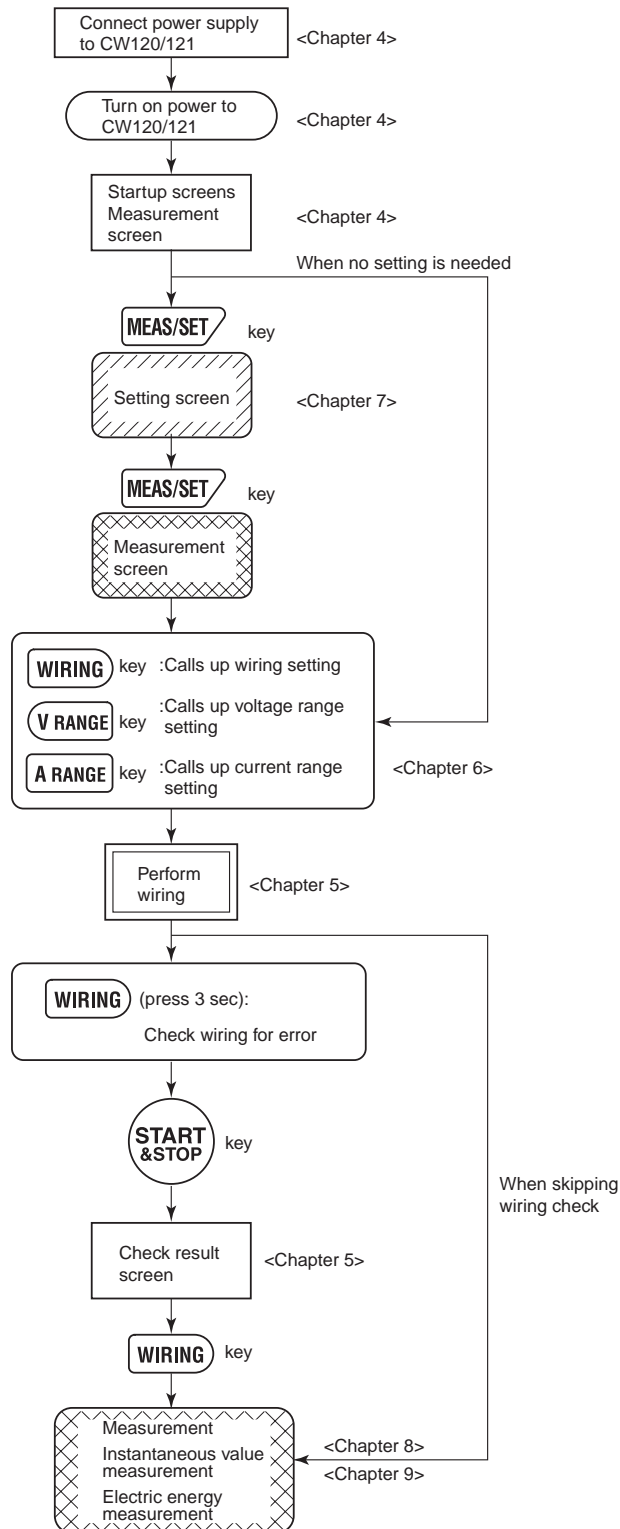

2. Operation Keys and Terminals

● Keys

Section numbers enclosed in angle brackets indicate references in the User's Manual (IM CW120-E).

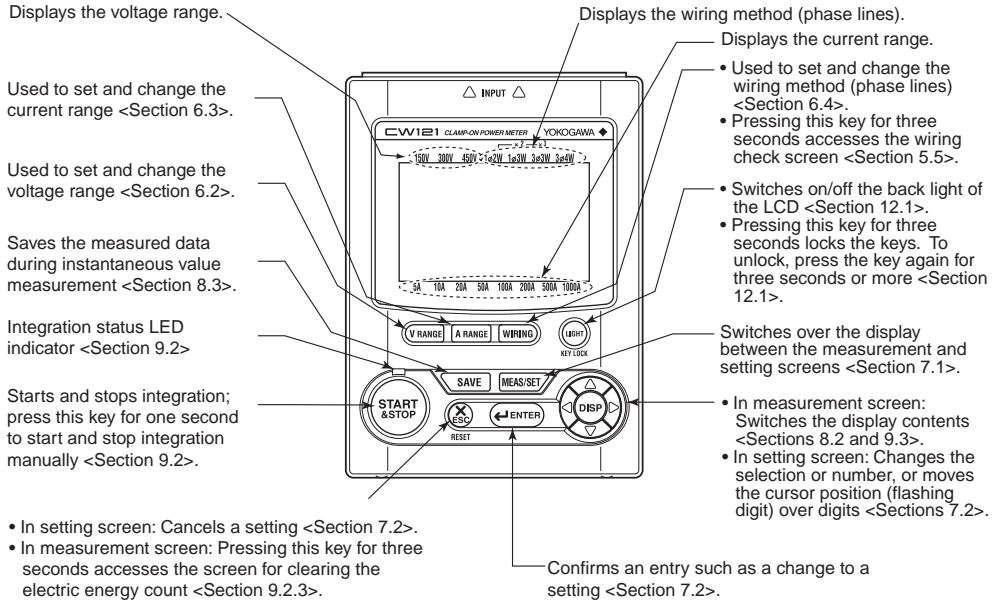

● Input Connectors

Voltage input terminals Current input terminals

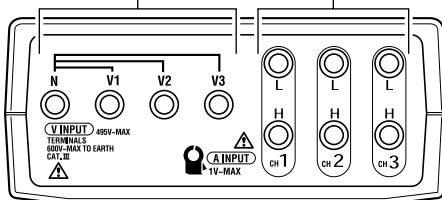

CW120: Supports from single-phase two-wire to three-phase three-wire circuits

Voltage input terminals: N, V1, V2

Current input terminals: CH1, CH2

CW121: Supports from single-phase two-wire to three-phase four-wire circuits

Voltage input terminals: N, V1, V2, V3

Current input terminals: CH1, CH2, CH3

● Side Panels

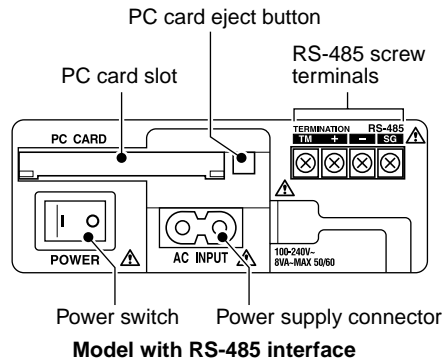
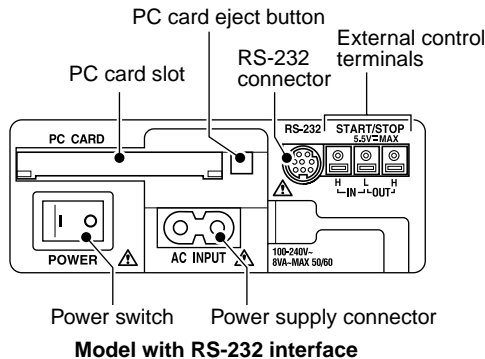

3. Display <Section 2.4>

When all segments light

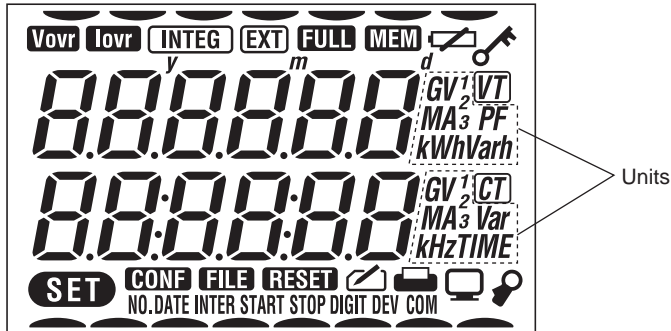

● Indications during Measurement

Displayed Mark

INTEG	Lights when integration is carried out; flashes when integration is on stand-by.
EXT	Lights when integration is controlled by external signals.
FULL	Lights when PC card memory is full.
MEM	Lights when the backup memory contains data.
	Lights when the battery voltage is low.
	Lights when the keys are locked.
	Lights when data saving to the PC card is enabled; flashes during access to the PC card.
	Flashes during access to the PC when a PC is selected as the communication device.
	Flashes during access to the printer when a printer is selected as the communication device.
VT	Lights when the VT ratio is set at a value other than 1.
CT	Lights when the CT ratio is set at a value other than 1.

● Indications of Setting Items

Mark appearing during setting mode: **SET**

Setting Item	Displayed Mark
Device number	NO.
Loading and saving of settings	CONF
Deletion of measured-data file and formatting of PC card	FILE
Clearance of electric energy count (watt-hours) and resetting of system	RESET
Copying and clearance of backup memory	MEM
Date	DATE
Output interval	INTER
Integration start date and time	START
Integration stop date and time	STOP
Whether to save data to PC card	
Selection of communication device	DEV
Communication settings	COM
Communication protocol	Proto
VT ratio setting	VT
CT ratio setting	CT
Probe selection	
Decimal position and unit selections for electric energy (watt-hours)	DIGIT

4. Browsing Measured Values <Sections 8.2 and 9.3>

Press  (one of the UP/DOWN/LEFT/RIGHT keys) when the measurement screen is displayed.

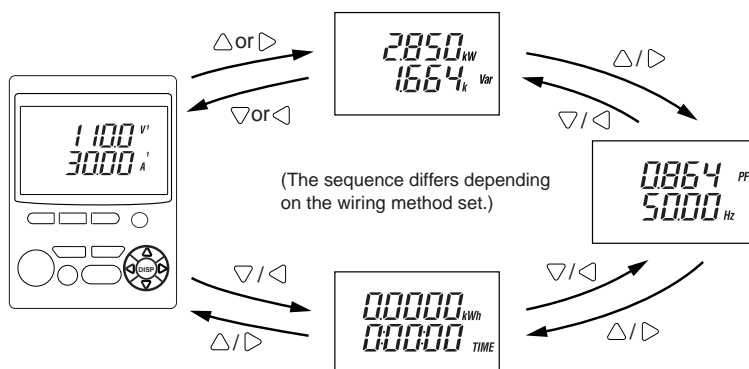

5. Changing Range Settings <Sections 6.2 and 6.3>

Press the **V RANGE** or **A RANGE** key when the measurement screen is displayed.

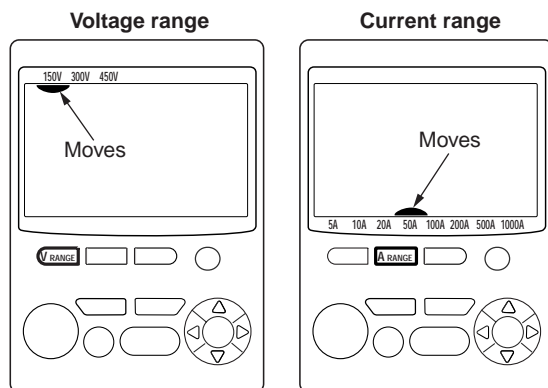

The current ranges that can be selected vary with the clamp-on current probe used, i.e., with the clamp setting.

When clamp setting = 50 A (probe 96033):
5, 10, 20, or 50 A

When clamp setting = 200 A (probe 96030):
20, 50, 100, or 200 A

When clamp setting = 500 A (probe 96031):
50, 100, 200, or 500 A

When clamp setting = 1000 A (probe 96032):
200, 500, or 1000 A

6. Changing Wiring Method <Section 6.4>

Press the **WIRING** key when the measurement screen is displayed.

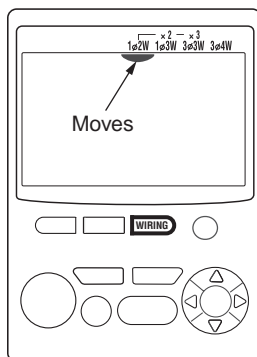

Moves to indicate the wiring method currently selected.

The available selections differ depending on the model:

CW120: 1ø2W, 1ø3W, 3ø3W or 1ø2W×2

CW121: 1ø2W, 1ø3W, 3ø3W, 3ø4W, 1ø2W×2, or 1ø2W×3

7. Changing Settings <Chapter 7>

Pressing **MEAS/SET** switches over the display between the measurement and setting screens.

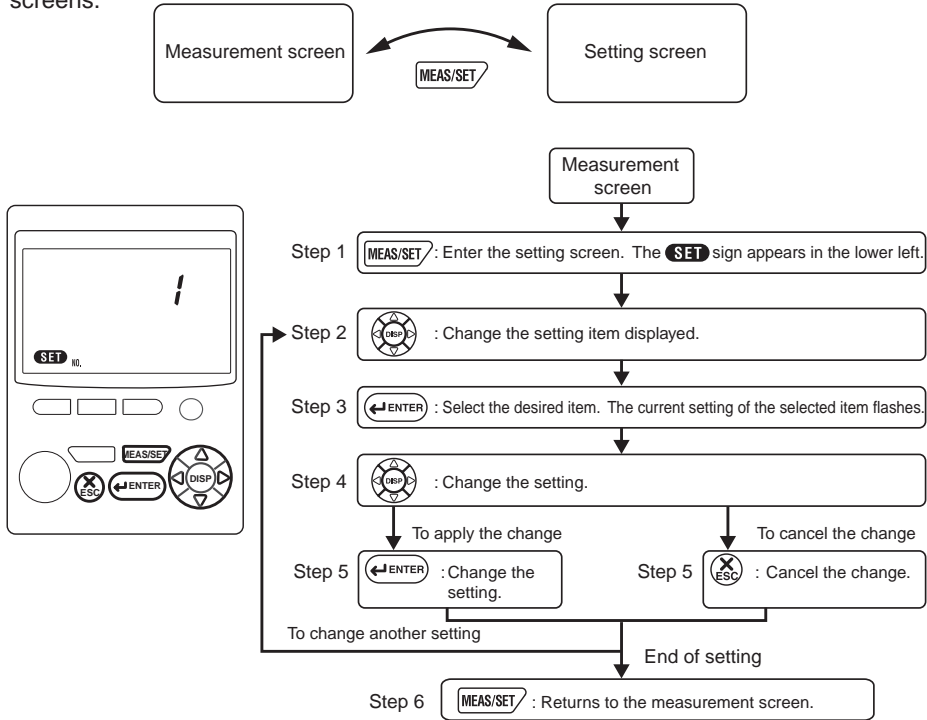

Display Mark	Setting Item	Reference Section
NO.	Device number setting	<7.2.1>
CONF	Loading (<i>LOAD</i>) and saving (<i>SAVE</i>) of settings	<7.2.2>
FILE	Deletion of measured-data file (<i>DELETE</i>) and formatting of PC card (<i>Init</i>)	<7.2.3>
RESET	Clearance of electric energy count (<i>intELe</i>) and resetting of system (<i>SYSt</i>)	<7.2.4>
MEM	Copying of data in backup memory to PC card (<i>DATA COPY</i>) Deletion of data from backup memory (<i>DATA DEL</i>)	<7.2.5>
DATE	Date and time setting	<7.2.6>
INTER	Data saving interval setting	<7.2.7>
START	Integration start date and time setting	<7.2.8>
STOP	Integration stop date and time setting	<7.2.9>
	On/off setting of data saving to PC card (<i>RECOOn</i> or <i>RECOFF</i>)	<7.2.10>
DEV	Communication device selection between PC and printer (<i>PC</i> or <i>Prn</i>)	<7.2.11>
COM	Communication settings (baud rate, data bits, etc.)	<7.2.12>
<i>Proto</i>	Communication protocol setting	<7.2.13>
VT	VT ratio setting when using an external voltage transformer	<7.2.14>
CT	CT ratio setting when using an external current transformer	<7.2.15>
	Clamp-on current probe selection	<7.2.16>
DIGIT	Decimal point position and unit selections for electric energy (<i>Std</i> for automatic selection)	<7.2.17>

8. Saving Data

● During Instantaneous Value Measurement <Section 8.3>

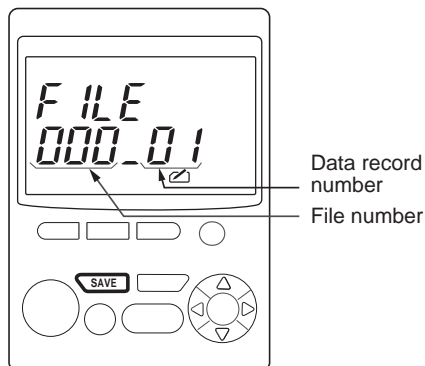

- Press the **SAVE** key. The information as shown left appears on the screen for about 2 seconds and all the measured values are saved to the PC card.
- The file number is the smallest, unused number from 000 to 029.
- Measured values can be saved up 99 times (i.e., for up to 99 records) per file.
- To change the file number, press the **WIRING** key. For other methods, see <Section 8.3>.

● During Electric Energy Measurement (Continuous Measurement) <Section 9.4>

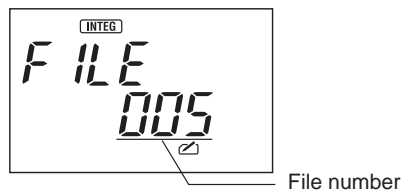

- The information as shown left appears on the screen for about 2 seconds when starting electric energy measurement. Then, after entering the integration standby state, the power meter will save the measured values to the PC card at the preset output interval.
- Example of display during the integration standby state (left): The start date and time is set to a future point of time.

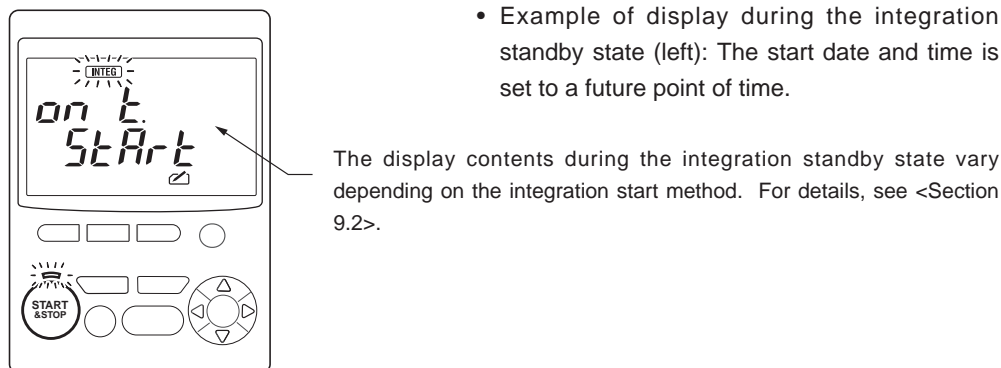

9. Starting and Ending Integration <Section 9.2>

Manual Starting and Ending

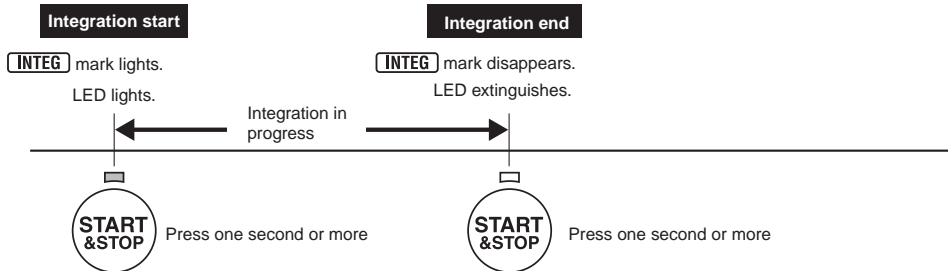

Automatic Starting and Ending at Specified Times

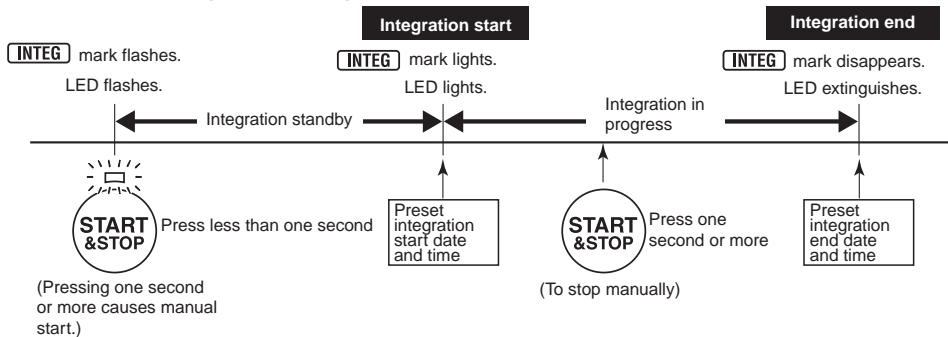





10. Meanings of Messages <Section 2.4>

Displayed Message	Meaning	Reference Sections
<i>on t. StArT</i>	Appears during standby of integration when set to start at a set date and time.	<9.2>
<i>IntEr. StArT</i>	Appears during standby of integration when a past point of time is set as the integration start time and date and integration will begin at the nearest appropriate time (determined by the output interval).	<9.2>
<i>IntEG. End</i>	Appears when integration has finished normally with the set integration start/stop dates and times.	<9.2>
<i>P_FA IL</i>	Appears when a power failure has occurred (or the power has been turned off) during standby or integration.	<9.7>
<i>dAtA CoPY</i>	Appears when the backup data is copied from the backup memory to the PC card.	<7.2.5>
<i>CArd Err.</i>	Appears when a PC card is not inserted.	<8.3, 9.4>
<i>FILE 000_01</i>	Shows the file number and data record number when saving measured instantaneous values.	<8.3>
<i>FILE 000</i>	Shows the file number when integration begins in the case that data saving to a PC card is enabled but the filename is not specified.	<9.4>
<i>FILE dEF InE</i>	Appears when integration begins in the case that data saving to a PC card is enabled and the filename is specified. The digits following "FILE" indicate "defined."	<9.4>

Setting Check Sheet

Setting file number	
Site	
Written by	
Date (day/month/year)	

Item	User's Setting	Available Setting	Default	Reference Sect. in IM CW120-E
WIRNING		1ø2W, 1ø3W, 3ø3W, or 3ø4W (3ø4W is available only for CW121.)	3ø3W	6.3
V RANGE		150 V, 300 V, or 450 V	150 V	6.4
A RANGE	5-50 A probe	5 A, 10 A, 20 A, or 50 A	200 A	6.4
	20-200 A probe	20 A, 50 A, 100 A, or 200 A		
	50-500 A probe	50 A, 100 A, 200 A, or 500 A		
	200-1000 A probe	200 A, 500 A, or 1000 A		
Setting Screen SET				
Device number	NO.	001 to 999	1	7.2.1
Output interval	INTER	1, 2, 5, 10, 15, or 30 seconds; 1, 2, 5, 10, 15, or 30 minutes; or 1 hour	30 minutes	7.2.7
Integration start date and time	START	/ / / : : : (year/month/day hour:minute:second)	Current time	7.2.8
Integration end date and time	STOP	/ / / : : : (year/month/day hour:minute:second)	Output interval after current time	7.2.9
Data saving to PC card		rEC.on: Save data to the PC card. rEC.oFF: Do not save data to the PC card.	rEC.on	7.2.10
Communication device selection	DEV	PC: Connect a PC. Prn: Connect a printer.	PC	7.2.11
Communication settings	COM	bps	Baud rate: 1200, 2400, 4800, 9600, 19200 or 38400 bps	9600 bps
		bits	Data bits: 7 or 8	8
			Parity: Even (E), odd (o), or none (n)	None (n)
		bits	Stop bits: 1 or 2	1
Communication protocol setting	<i>Prcka</i>	orG.Pro: CW120/121 Pr201: Power monitor PR201 PC.S.off: PC link (without checksum) PC.S.on: PC link (with checksum) nod.ASC: MODBUS (ASCII) nod.rtU: MODBUS (RTU)	orG.Pro	7.2.13
VT ratio		1 to 10000	1	7.2.14
CT ratio		1.00 to 10000.0 (in 0.01 increments)	1	7.2.15
Clamp-on current probe selection		Probe selection and available ranges 50 A (Model 96033): 5/10/20/50 A 200 A (Model 96030): 20/50/100/200 A 500 A (Model 96031): 50/100/200/500 A 1000 A (Model 96032): 200/500/1000 A	200 A	7.2.16
Decimal point position and unit of electric energy	DIGIT	Std.: Standard setting (automatic decision). Decimal point position: 000.000, 0000.00, 00000.0, or 000000 Unit: Wh, kWh, MWh, or GWh	Std. (automatic decision)	7.2.17

Make a copy of this sheet for use.

For the details of respective settings, see Chapter 7, "Making Settings."

● Record of File Names Used

Instantaneous value measurement Saving with <input type="button" value="SAVE"/> key File name: MWTHxxx.CSV ↵ File number		Electric energy measurement File name: AWTHxxx.CSV ↵ File number	
File Number	Site	File Number	Site

MEMO

Questions and repairs

If you have a question about the product or an inquiry about a repair, contact the vendor from which you purchased the instrument.