

Before Use

Before starting measurement with your CW120 or CW121, fill in the Setting Check Sheet in the back of the *Operation Guide* (IM CW120P-E) with your particular settings, to facilitate setting on site.

Introduction

Thank you for purchasing our CW120 or CW121 Clamp-on Power Meter. This User's Manual explains the functions of the CW120/121, as well as the operating methods and handling precautions. Before using the CW120/121, read this manual thoroughly to ensure correct use of the instrument.

The Operation Guide manual, available separately in addition to this manual, describes the basic procedures for performing such tasks as measurement operations and settings. Use the Operation Guide together with this in-depth manual.

When you have finished reading this manual, carefully store it in a convenient place for future reference.

Notes

The contents of this manual are subject to change without prior notice. In addition, figures and illustrations representing display appearances in this manual may differ from the actual appearances.

Every effort has been made to ensure the accuracy of this manual. If you notice any errors or have any questions, however, please contact one of the Yokogawa sales offices listed on the back cover of this manual or the sales representative from which you purchased the instrument.

The contents of this manual may not be transcribed or reproduced, in part or in whole, without prior permission.

Trademark Acknowledgments

All company and product names appearing in this document are trademarks or registered trademarks of their respective holders.

Revision Information

December 2001: 1st Edition

June 2003: 2nd Edition

— — — : 3rd Edition

May 2007: 4th Edition

Checking Items in the Package

After opening the package, check the product as follows before use. If the delivered product is the wrong model, any item is missing, or the appearance is defective, contact the vendor from which you purchased the product.

CW120/121 Main Unit

Check the model and suffix (specifications) codes in the MODEL and SUFFIX fields of the nameplate at the back of the instrument to ensure that the instrument is exactly as specified in your purchase order.

Model and Suffix Codes

Model	Suffix Code	Specification
CW120		Clamp-on power meter for single-phase two-wire, single-phase three-wire, three-phase three-wire, and single-phase tow-wire ×2* circuits
CW121		Clamp-on power meter for single-phase two-wire, single-phase three-wire, three-phase three-wire, three-phase four-wire, single-phase tow-wire ×2*, and single-phase tow-wire ×3* circuits
Power cord	-D	UL/CSA standard
	-F	VDE standard
	-H	GB standard
	-R	SAA standard
	-S	BS standard
Communication interface	-1	With RS-232-C interface
	-2	With RS-485 interface
Option codes	/C1	Clamp-on current probe for 20/200 A (2 pieces/set)
	/C2	Clamp-on current probe for 20/200 A (3 pieces/set)
	/C3	Clamp-on current probe for 50/500 A (2 pieces/set)
	/C4	Clamp-on current probe for 50/500 A (3 pieces/set)
	/C5	Clamp-on current probe for 200/1000 A (2 pieces/set)
	/C6	Clamp-on current probe for 200/1000 A (3 pieces/set)
	/C7	Clamp-on current probe for 5/50 A (2 pieces/set)
	/C8	Clamp-on current probe for 5/50 A (3 pieces/set)

* "×2", "×3" means multiple-system load measurements.

No. (serial number):

Refer to this serial number on the nameplate when contacting the vendor about the instrument.

Accessories

Make sure that the package contains all the accessories listed below and that they are all free from any damage.

Product Name	Part Number	Qty	Remarks
1. Power cord (One of the four options)	B9988YA		-D: UL/CSA standard
	B9988YB		-F: VDE standard
	B9988YJ		-H: GB standard
	B9988YC		-R: SAA standard
	B9988YD		-S: BS standard
2. Voltage probes (for CW120)	91018	3	Color: Black, red, yellow
Voltage probes (for CW121)	91007	4	Color: Black, red, yellow, blue
3. User's Manual	IM CW120-E	1	
4. Operation Guide	IM CW120P-E	1	
5. Set Up Disk		2	TOOL BOX

1.

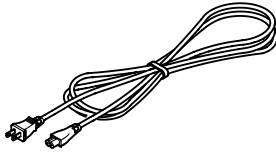

2.

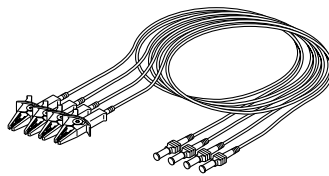

3.

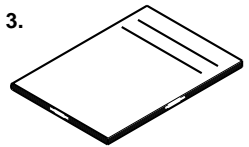

4.

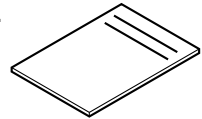

Checking Items in the Package

Peripherals (Optional)

The products listed below are available as optional peripherals. For technical and ordering inquiries concerning the peripherals, contact the vendor from which you purchased the instrument. If you purchased any one of the optional peripherals together with the CW120/121, make sure it is free from any damage.

Product Name	Part Number	Minimum Order Qty	Remarks
Clamp-on current probe for 20/200 A	96030	1	See the option codes for a choice of probe kits. Applicable to CE or UL.
Clamp-on current probe for 50/500 A	96031	1	See the option codes for a choice of probe kits. Applicable to CE or UL.
Clamp-on current probe for 200/1000 A	96032	1	See the option codes for a choice of probe kits. Not applicable to CE and UL.
Clamp-on current probe for 5/50 A	96033	1	See the option codes for a choice of probe kits. Applicable to CE. Not applicable to UL.
Power supply cable	98030	1	Not applicable to CE and UL
Voltage probes (for CW121)	91007	4	1 set
Voltage probes (for CW120)	91018	3	1 set
RS-232C cable	91011	1	D-sub 9 pin
RS-232 serial printer cable	91010	1	
Printer	97010	1	With 1 thermal paper roll and 1 battery pack
AC adapter (for printer)	94006	1	Power supply 200-240 V AC
AC adapter (for printer)	94007	1	Power supply 100-120 V AC
Thermal printer paper	97080	10 rolls	
Carrying case	93022	1	For CW120 Series
Meter case	93023	1	For CW120 Series
Memory Card (128 to 512 MB)	97033 to 35	1	With PC card adapter
Application Software	AP240	1	

TIP

Keep the packing box in case you need to transport the instrument.

Housing CW120/121 and Accessories

The optional carrying case can accommodate the CW120 or CW121 main unit with its current-sensing clamp-on probes and voltage probes connected to the unit. The case can also hold such accessories as manuals and PC cards, and so is useful for transporting a complete set of tools necessary for measurement.

The optional meter case can be used as a stand during measurement as shown below right. It also has a magnetic rear plate and so can be stuck to the door of a power distribution panel or the like.

Note: Keep the meter case away from objects vulnerable to a magnetic field, such as floppy disks.

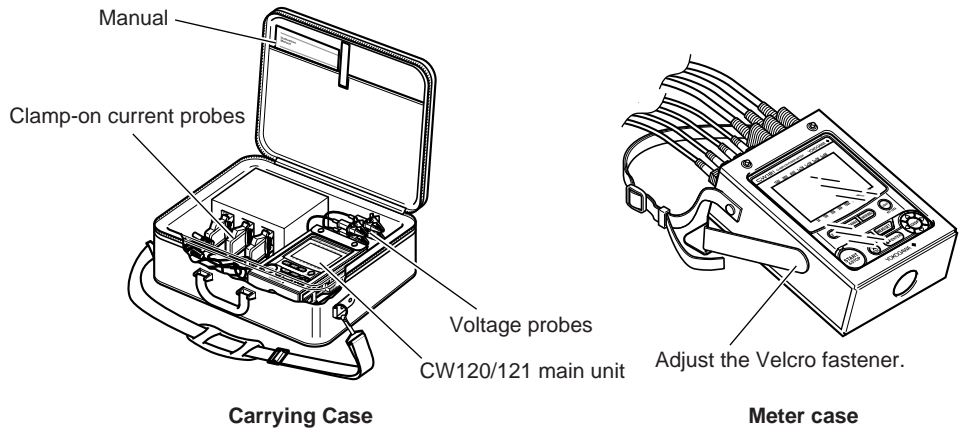

Precautions for Safe Use of the Instrument

When operating the instrument, be sure to observe the cautionary notes given below to ensure correct and safe use of the instrument. If you use the instrument in any other way than instructed in this manual, the instrument's protective measures may be impaired. Yokogawa is by no means liable for any damage resulting from use of the instrument in contradiction to these cautionary notes.

The following safety symbols are used in the instrument and this manual.



Danger! Handle with Care.

This symbol indicates that the operator must refer to an explanation in the instruction manual in order to avoid risk of injury or death of personnel or damage to the instrument.



Direct Current

This symbol indicates DC voltage/current.



Alternating Current

This symbol indicates AC voltage/current.



ON

This symbol indicates On (power).



OFF

This symbol indicates Off (power).



Double Insulation

This symbol indicates double insulation.



WARNING

Indicates a hazard that may result in the loss of life or serious injury of the user unless the described instruction is abided by.



CAUTION

Indicates a hazard that may result in an injury to the user and/or physical damage to the product or other equipment unless the described instruction is abided by.



NOTE

Indicates information that is essential for handling the instrument or should be noted in order to familiarize yourself with the instrument's operating procedures and/or functions.

TIP

Indicates information that complements the present topic.

SEE ALSO

Indicates the reference location(s) for further information on the present topic.

Strictly observe the following cautionary notes in order to avoid the risk of injury or death of personnel or damage to the instrument due to such hazards as electrical shock.

WARNING

● Removal of Case from the Instrument

- Do not remove the case from the instrument or disassemble/modify the instrument itself.
- Some parts of the inside of the instrument contain high-voltage and, therefore, access to the internal assembly is extremely hazardous. For inspection and/or adjustment of the internal assembly, contact the vendor from which you purchased the instrument.

● Use of the Instrument in a Gas Atmosphere

Do not operate the instrument in a location where any flammable or explosive gas/vapor is present. It is extremely hazardous to operate the instrument in such an atmosphere.

● Inspection of Power Source

- Before turning on the instrument, always make sure the voltage of the power source to be applied matches the instrument's supply voltage.

● Use of Clamp-on Current Probes

- When using clamp-on current probes, keep the circuit voltage below 600 V AC in order to avoid possible short-circuits or accidents resulting in injury or death.
- Ensure that the rated current of the circuit you measure matches the rating of the current probe.
- Avoid using the instrument if it has been exposed to rain or moisture or if your hands are wet.
- Do not use clamp-on current probes with any non-insulated conductors.

● Measures In Case of Anomalies

If the instrument begins to emit smoke, becomes too hot, or gives off an unusual smell, immediately turn it off and disconnect the power cord from the outlet. Also turn off power to the object under measurement that is connected to the instrument's input terminals. Never attempt to use the instrument again. If any such anomalies as noted above occurs, contact the vendor from which you purchased the instrument. Do not attempt to repair the instrument yourself, as doing so is extremely dangerous.

● Handling of Power Cord

- Use only the cord supplied from Yokogawa M&C to prevent electric shocks and fire.
- Do not place any load on the power cord or allow the power cord to come into accidental contact with any heat source. When unplugging the power cord from the outlet, hold its plug, rather than holding and pulling the cord itself.
- If the power cord is damaged, contact the vendor from which you purchased the instrument.

● Fuses

Fuses built into this instrument for protection cannot be replaced by the user. When any built-in fuses need to be replaced such as because they have blown, contact the vendor from which you purchased the instrument.

Utilisation en Toute Securite

Les précautions suivantes doivent être prises pendant l'exploitation, la maintenance et les réparations. YOKOGAWA ne pourra en rien être déclaré responsable si ces précautions ne sont pas respectées par l'utilisateur.

- Symboles utilisés sur les appareils et dans les Manuels d'instruction.



Explication: ce symbole indique que l'opérateur doit se reporter à une explication donnée par le manuel d'instruction afin d'éviter un accident au personnel ou de protéger l'appareil.



Courant continu: Ce symbole indique une tension/intensité C.C.



Courant alternatif: Ce symbole indique une tension/intensité C.A.



MARCHE: Ce symbole indique la mise sous tension.



ARRET: Ce symbole indique la mise hors tension.



Double isolation: Ce symbole indique une double isolation.

AVERTISSEMENT

Indique un danger. Attire l'attention sur une utilisation, sur une procédure qui pourrait être dangereuse pour le personnel.

ATTENTION

Indique un danger. Attire l'attention sur une utilisation, sur une procédure qui pourrait être préjudiciable au produit.

 **AVERTISSEMENT**

● Retrait du boîtier de l'instrument

- Ne pas retirer le boîtier de l'instrument et ne pas essayer non plus de démonter/modifier l'instrument lui-même.
- L'instrument renferme des composants parcourus par des tensions élevées. Il est donc extrêmement dangereux d'accéder à ses circuits internes. Pour vérifier et/ou régler les circuits internes, contacter le revendeur auprès duquel a été acheté l'instrument.

● Utilisation de l'instrument dans une atmosphère gazeuse

Ne pas utiliser l'instrument dans un endroit qui renferme des gaz/vapeurs inflammables ou explosifs. Il est extrêmement dangereux d'utiliser l'instrument dans une telle atmosphère.

● Vérification de la source d'alimentation

- Avant de mettre l'instrument sous tension, toujours s'assurer que sa tension correspond à celle de la source d'alimentation.

● Utilisation des sondes d'intensité à pince

- Lors de l'utilisation des sondes d'intensité à pince, maintenir la tension du circuit au-dessous de 600 V CA afin d'écartier tout risque de court-circuit ou d'accident susceptible de provoquer des blessures qui peuvent éventuellement s'avérer mortelles.
- Assurez-vous d'utiliser un capteur de courant dont le calibre correspond au niveau d'intensité à mesurer.
- Éviter d'utiliser l'instrument si celui-ci a été exposé à la pluie ou à l'humidité, ou encore si vos mains sont humides.
- Ne pas utiliser les sondes d'intensité à pince avec des conducteurs non isolés.

● Mesures à prendre en cas d'anomalies

Si l'instrument est brûlant, dégage de la fumée ou une odeur inhabituelle, le mettre immédiatement hors tension et débrancher le cordon d'alimentation de la prise secteur. Mettre également hors tension le circuit sur lequel est effectuée la mesure et qui est raccordé aux bornes d'entrée de l'instrument. Ne surtout pas essayer d'utiliser l'instrument à nouveau. Si l'une de ces anomalies est détectée, contacter le revendeur auprès duquel a été acheté l'instrument. Ne pas essayer de le réparer soi-même, car cela est extrêmement dangereux.

● Manipulation du cordon d'alimentation

- Afin de prévenir tout feu ou choc électrique, n'utilisez que le cordon fourni par Yokogawa M&C.
- Ne déposer aucune charge sur le cordon d'alimentation et éviter tout contact fortuit entre celui-ci et une source de chaleur. Pour débrancher le cordon de la prise secteur, tirer sur sa fiche, mais jamais sur le fil proprement dit. Si le cordon d'alimentation est endommagé, contacter le revendeur auprès duquel a été acheté l'instrument.

● Fusibles

Les fusibles de protection montés sur cet instrument ne peuvent pas être remplacés par l'utilisateur. Si, par suite de claquage, un fusible doit être remplacé, veuillez contacter le vendeur auprès de qui vous avez acheté l'instrument.

Contents

Introduction	1
Checking Items in the Package	2
Precautions for Safe Use of the Instrument	6
Chapter 1. Product Overview	1-1
1.1 Product Overview	1-1
Chapter 2. Components and Indications	2-1
2.1 Front Panel and Connector Block	2-1
2.2 Connecting Input Signals	2-3
2.3 Operation Keys and Display	2-5
2.4 Overrange and Other Marks Shown during Measurement	2-6
Chapter 3. Precautions for Safe Measurement	3-1
3.1 Handling Precautions	3-1
3.2 Installation Procedure	3-3
3.3 Maintaining High Precision of Measurement	3-5
Chapter 4. Connecting Power Supply and Turning Power On/Off	4-1
4.1 When Using AC Power Supply	4-1
4.2 When Supplying Power from Voltage Input	4-3
4.3 Startup Screens	4-4
4.4 Basic Operation Flow	4-6
Chapter 5. Wiring	5-1
5.1 Precautions for Wiring the Circuit under Test	5-1
5.2 Diagrams of Basic Wiring	5-2
5.3 Wiring the Circuit under Test with External VT/CT	5-4
5.4 Indication and Change of Wiring Method	5-5
5.5 Wiring Check Function	5-6
Chapter 6. Setting Ranges and Wiring Method	6-1
6.1 Ranges and Display Digits	6-1
6.2 Changing Voltage Range Setting	6-6
6.3 Changing Current Range Setting	6-7
6.4 Changing Wiring Method Setting	6-10
Chapter 7. Making Settings	7-1
7.1 Setting Items and Item Selection	7-1
7.2 Setting Each Item	7-4
7.3 Setting Name of Measured-data File	7-33

Chapter 8. Instantaneous Value Measurement	8-1
8.1 Measuring Instantaneous Values	8-1
8.2 Switching Display Contents	8-2
8.3 Saving Data	8-5
8.4 Frequency Measurement	8-8
8.5 Sampling Cycle and Integration Cycle	8-9
Chapter 9. Electric Energy Measurement	9-1
9.1 Measuring Electric Energy	9-1
9.2 Starting and Stopping Integration	9-3
9.3 Switching Display Contents	9-10
9.4 Saving Data	9-13
9.5 Backup Memory	9-16
9.6 External Control Input/Output	9-19
9.7 Meter Actions upon Power Failure and Recovery	9-22
Chapter 10. PC Card	10-1
10.1 PC Card Specifications	10-1
10.2 Inserting and Removing PC Card	10-2
10.3 Storage Capacity	10-3
10.4 Formatting PC Card	10-4
10.5 Saving and Loading from/to PC Card	10-5
10.6 Interface with Personal Computer	10-7
Chapter 11. Communication Functions	11-1
11.1 RS-232	11-1
11.2 RS-485	11-6
11.3 Data Format	11-9
Chapter 12. Auxiliary Functions	12-1
12.1 Convenient Functions	12-1
12.2 Using Optional Printer	12-3
Chapter 13. Troubleshooting	13-1
13.1 Corrective Measures in Case of Failure	13-1
13.2 Error Codes	13-2
13.3 Disposing the Product	13-3
Chapter 14. Specifications	14-1
14.1 Specifications of CW120/121	14-1
14.2 Specifications of Clamp-on Current Probes	14-9
Appendix 1. Circuit Block Diagram	App1-1
Appendix 2. Communication Commands	App2-1
1. Commands	App2-2
1.1 Messages	App2-2
1.2 Commands	App2-4
1.3 Response	App2-5
1.4 Data	App2-6

1
2
3
4
5
6
7
8
9
10
11
12
13
14
App
Index

1.5	Messages on RS-485	App2-8
1.6	Communication Commands	App2-9
1.7	Detailed Description of Communication Commands	App2-12
1.7.1	COMMunicate Group	App2-12
1.7.2	SYSTem Group	App2-13
1.7.3	INTEgrate Group	App2-15
1.7.4	MEASure Group	App2-17
1.7.5	STATus Group	App2-17
1.7.6	MEMOry Group	App2-18
1.7.7	CARD Group	App2-18
1.7.8	Common Group	App2-19
2.	Error Messages	App 2-20
3.	Command Effectiveness Tables	App 2-24
Appendix 3. File Structures and Data Items Printed		App3-1
1.	Overview	App 3-2
2.	Measured Data	App 3-3
2.1	File Format	App 3-3
2.1.1	File Identifier	App 3-3
2.1.2	File Type	App 3-3
2.1.3	Measurement Mode	App 3-3
2.1.4	Data Field Titles and Data Formats	App 3-4
2.1.5	Records of Power Failure/Restoration Information	App 3-5
2.2	Print Format	App 3-6
2.2.1	Print Item Titles and Data Formats	App 3-6
3.	Settings	App 3-8
3.1	File Format	App 3-8
3.2	Output Format and Data Values	App 3-9
3.3	Print Format	App 3-11
4.	Automatic File Naming	App 3-12
Appendix 4. Reactive Power		App4-1
Index		Index-1

1.1 Product Overview

The CW120/121 clamp-on power meters measure the fundamental electric power factors, namely, instantaneous power-related values and electric energy (watt-hours).

- CW120: Supports single-phase two-wire, single-phase three-wire, three-phase three-wire, and single-phase tow-wire \times 2 circuits.
- CW121: Supports single-phase two-wire, single-phase three-wire, three-phase three-wire, three-phase four-wire, single-phase tow-wire \times 2, and single-phase tow-wire \times 3 circuits.

The following explains the features of the CW120/121, shows a schematic diagram of their functions, and describes the contents displayed on the screen in each measurement mode.

Features

● A Wealth of Functions

- Fast data saving for a long time: Data can be saved at 1-second intervals at fastest. A PC card slot for large removable memories such as flash ATA and compact flash cards allows measurement over a long time.
- Instantaneous value saving: Simply pressing the SAVE key will save the measured values.
- Wiring error check: The connections are checked and any error is displayed before the start of measurement.

● Broad Ranges

- Voltage range: 150/300/450 V
- Current range: 4 types of clamp-on probes can be used.
 - 96033 clamp-on probe: 5/10/20/50 A
 - 96030 clamp-on probe: 20/50/100/200 A
 - 96031 clamp-on probe: 50/100/200/500 A
 - 96032 clamp-on probe: 200/500/1000 A

● Ease of Data Processing and Communication

Data can be saved to a PC card. Via communication, data can be transferred to a personal computer and the measurement conditions can be set from a computer. As the communication interface, you can choose (when ordering) RS-232 or RS-485; the RS-485 interface allows multiple CW120s and CW121s to be connected on the same line for remote monitoring.

1.1 Product Overview

- **Compact Design**

- The CW120/121 are sufficiently compact to be installed inside a cubicle or power distribution panel during measurement.
- The 96033 current-sensing probe with a 5 to 50 A range is designed for use in a narrow space, so is useful for measurement inside a power distribution panel with dense wiring.

- **Easy-to-see Display Screen**

Despite the compact body, the large back-lit LCD enables easy measurement in a dark place.

● Schematic Function Diagram

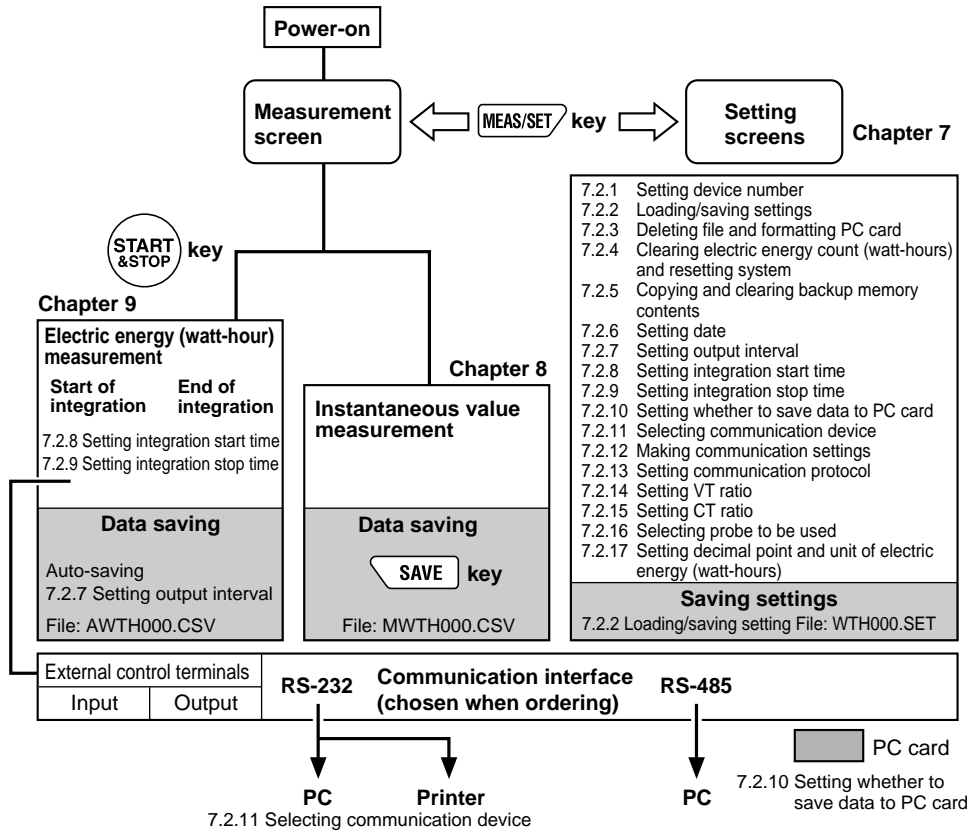

● On-screen Information (Measured Data)

There are two measurement modes: instantaneous measurement and electric energy measurement. In the latter mode, the power is continuously measured and integrated during the preset start and stop times.

Instantaneous value measurement

Item	Unit	Displayed Name
Rms voltage	V	V1, V2, V3 (differs depending on the wiring method)
Rms current	A	A1, A2, A3 (differs depending on the wiring method)
Active power	W	W, W1, W2, W3 (differs depending on the wiring method)
Reactive power	Var	Var, Var1, Var2, Var3 (differs depending on the wiring method)
Power factor	—	PF, PF1, PF2, PF3: PowerFactor (differs depending on the wiring method)
Frequency	Hz	Hz (input frequency of V1)

1.1 Product Overview

Electric energy measurement

Item	Unit	Displayed Name
Active electric energy	Wh	Wh, Wh1, Wh2, Wh3 (differs depending on the wiring method)
Regenerative electric energy	Wh	Only saved; not displayed
Six items of instantaneous value measurement		

The screen changes sequentially each time a cursor-movement (UP, DOWN, LEFT, or RIGHT) key is pressed as follows (display contents differ depending on the wiring method):

Phase Wires	Display Position	Displayed Item					
		Screen 1	Screen 2	Screen 3	Screen 4	Screen 5	Screen 6
Single-phase two wires (1Ø2W)	Upper row	V1	W	PF	Wh	/	/
	Lower row	A1	Var	Hz	TIME		
Single-phase three wires (1Ø3W) Three-phase three wires (3Ø3W)	Upper row	V1	A1	W	PF	Wh	/
	Lower row	V2	A2	Var	Hz	TIME	
Three-phase four wires (3Ø4W)	Upper row	V1	V3	A2	W	PF	Wh
	Lower row	V2	A1	A3	Var	Hz	TIME
Single-phase tow-wires ×2 (1Ø2W×2)	Upper row	V1	W1 W2	PF1 PF2	Wh1 Wh2	/	/
	Lower row	A1 A2	Var1 Var2	Hz	TIME		
Single-phase tow-wires ×3 (1Ø2W×3)	Upper row	V1	W1 W2 W3	PF1 PF2 PF3	Wh1 Wh2 Wh3	/	/
	Lower row	A1 A2 A3	Var1 Var2 Var3	Hz	TIME		

2.1 Front Panel and Connector Block

● Dimensions

Connector Block

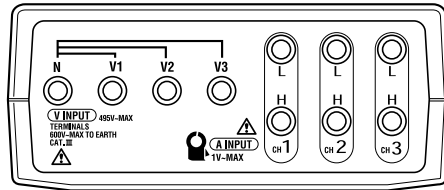

Unit: mm (approx. inches)

Front View

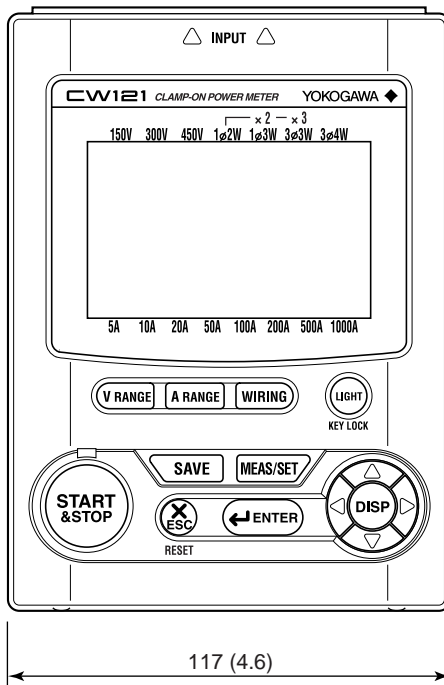

Side View

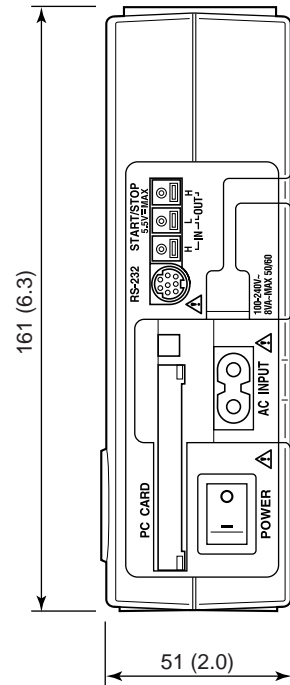

2.1 Front Panel and Connector Block

● Connector Block

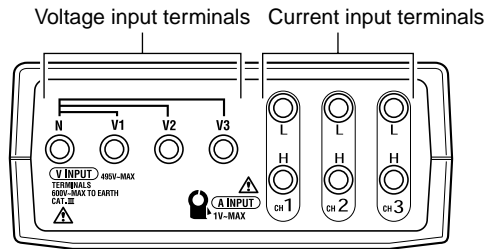

CW120: Supports from single-phase two-wire to three-phase three-wire circuits

Voltage input terminals: N, V1, V2

Current input terminals: CH1, CH2

CW121: Supports from single-phase two-wire to three-phase four-wire circuits

Voltage input terminals: N, V1, V2, V3

Current input terminals: CH1, CH2, CH3

● Side Panels

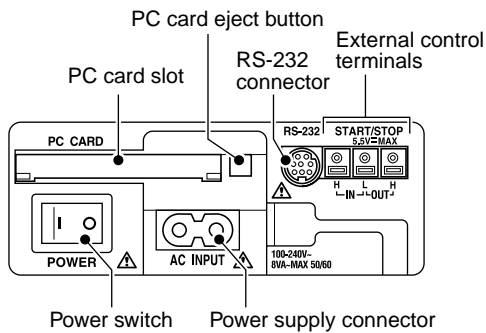

Model with RS-232 interface

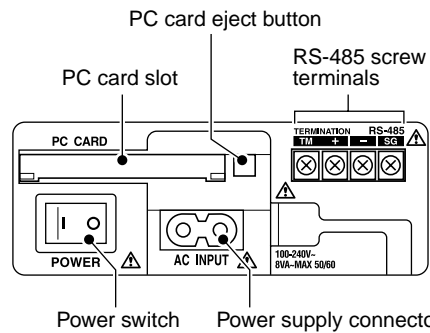

Model with RS-485 interface

RS-232 interface

RS-232 connector

: Used to connect to a PC or printer (optional).

Internal control input (IN) terminals

: Used to connect the integration start/stop input signals.

Internal control output (OUT) terminals

: Used to connect the integration start/stop output signals.

SEE ALSO

For details of external control input/output, see Section 9.6, "External Control Input/Output."

RS-485 interface

RS-485 screw terminals

: Used to connect a shielded cable and terminator.

SEE ALSO

For details of the RS-485 interface, see Section 11.2, "RS-485."

2.2 Connecting Input Signals

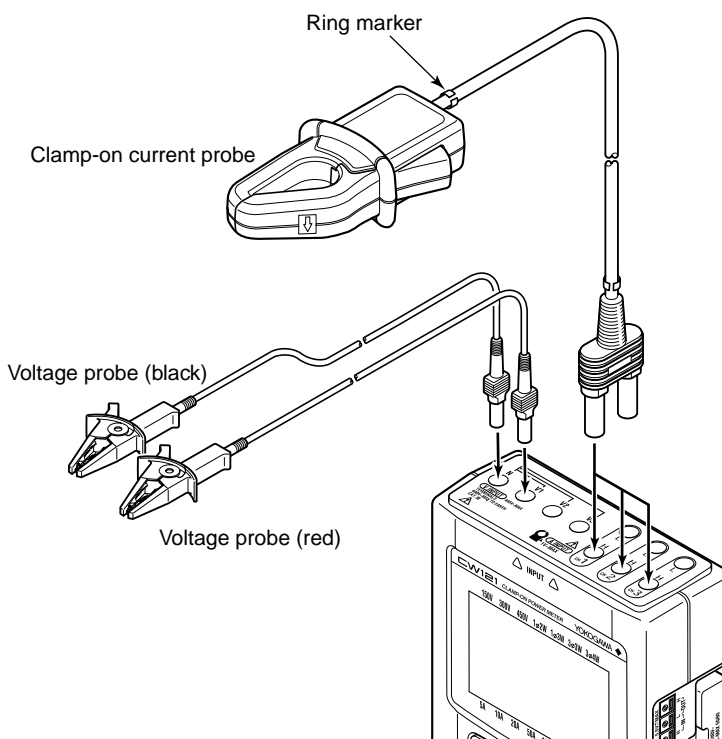

⚠ WARNING

- Thoroughly read Section 5.1, "Precautions for Wiring the Circuit under Test."
- When connecting the CW120/121, turn off the circuit under test. It is extremely dangerous to connect or disconnect probes to/from a live circuit.
- Be extremely careful not to connect any voltage-mode circuit to the current input terminals or any current-mode circuit to the voltage input terminals. Miswiring can result in not only damage to the circuit or equipment under test but also injury to personnel.
- Do not connect any probes which are not necessary (i.e., not used) for the current measurement, even though multiple probes can be connected to the CW120/121 at the same time.
- Do not use any probe other than the clamp-on current probes or voltage probes supplied.
- Do not use a clamp-on current probe for a non-insulated conductor.
- Ensure that the rating of the clamp-on current probe you use matches the rating of the measured current.
- Before connecting a clamp-on current probe to the CW120/121, make sure the plug is inserted with the correct H/L polarities.

2.2 Connecting Input Signals

● Differentiating between Voltage Probes

Voltage probes are differentiated by color for correct connections.

- Probe for terminal N: Probe with a black alligator plug
- Probes for terminals V1 to V3: Probes with a red, yellow, or blue alligator plug

Accompanying probes

CW120: Three (black, red, and yellow)

CW121: Four (black, red, yellow, and blue)

● Differentiating between Clamp-on Current Probes

Use accompanying ring markers (of four different colors) to differentiate clamp-on current probes for correct connections.

CW120: Terminals CH1 to CH2

CW121: Terminals CH1 to CH3

Use of Ring Markers

Attach ring markers of the same color to both ends of the probe cable for easy identification.

CAUTION

Be careful not to damage a probe when attaching ring markers.

2.3 Operation Keys and Display

● Keys

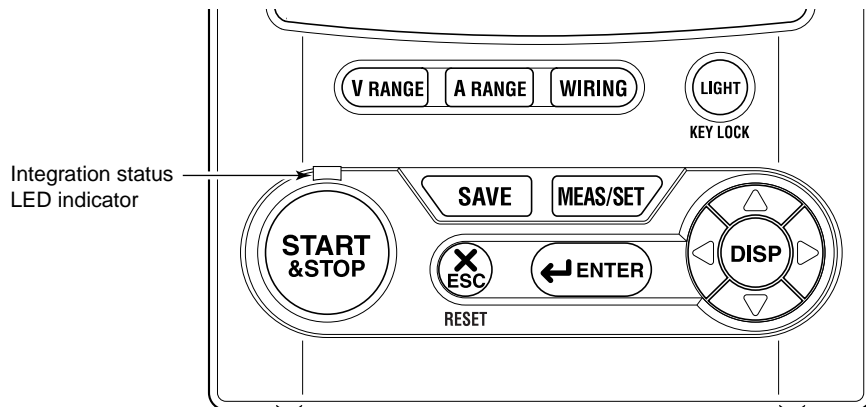

Name	Key Symbol	Description
V RANGE key		Used to set and change the voltage range.
A RANGE key		Used to set and change the current range.
WIRING key		Used to set and change the wiring method (phase lines). Also used to check the wiring. Pressing this key for three seconds or more accesses the wiring check screen.
LIGHT key		Switches on/off the backlight of the LCD. Also used to lock and unlock the keys. Pressing this key for three seconds locks the keys. To unlock, press the key again for three seconds or more.
SAVE key		Saves the measured data during instantaneous value measurement.
MEAS/SET key		Switches over the display between the measurement and setting screens.
START&STOP key		Starts and stops integration.
ENTER key		Confirms an entry such as a change to a setting.
ESC (escape) key		Cancels a setting and returns to the preceding screen. Also used to clear the electric energy count (watt-hours). Pressing this key for three seconds or more accesses the screen for clearing the electric energy count.
Cursor movement keys (UP/DOWN/LEFT/RIGHT keys)		In measurement screen: Switches the display contents. In setting screen: Changes the selection or number, or moves the cursor position (flashing digit) over digits.

Integration status LED indicator: Lit when the integration is carried out, and flashes when it is on stand-by.

2.4 Overrange and Other Marks Shown during Measurement

WARNING

When the overrange mark appears with the range set to a maximum, it means that the input exceeds the maximum allowable level of the CW120/121. Do not apply an input level higher than the maximum allowable input level.

CAUTION

When measuring an input signal level exceeding the rated range, use a voltage transformer (VT) or current transformer (CT). When using a VT or CT, thoroughly read Section 5.3, “Wiring the Circuit under Test with External VT/CT.”

● Overrange Indications

Vovr: Indicates an overvoltage.

This mark appears in the following conditions.

150/300 V range: If the sampled value exceeds 200% of the rated voltage or if the rms value of the measured voltage exceeds 110% of the rated range

450 V range: If the sampled value exceeds 156% of the rated voltage or if the rms value of the measured voltage exceeds 110% of the rated range

Iovr: Indicates an overcurrent.

This mark appears if the sampled value exceeds 300% of the rated current or if the rms value of the measured current exceeds 110% of the rated range.

TIP

The **Vovr** mark appears when any one of the input signals from terminals V1 to V3 satisfies the conditions noted above.

The **Iovr** mark appears when any one of the input signals from terminals CH1 to CH4 satisfies the conditions noted above.

ORF indication

The CW120/121 show  instead of a usual number representing the measured value if any one of the following conditions is met.

The number representing the measured value exceeds 9999, the maximum number displayed.

2.4 Overrange and Other Marks Shown during Measurement

Voltage - 150/300 V range:

If the sampled value exceeds 200% of the rated voltage or if the rms value of the measured voltage exceeds 130% of the rated range

Voltage - 450 V range:

If the sampled value exceeds 156% of the rated voltage or if the rms value of the measured voltage exceeds 110% of the rated range

Current:

If the sampled value exceeds 300% of the rated voltage or if the rms value of the measured voltage exceeds 130% of the rated range

● Indications When the Measured Value Is Too Small

Displayed Item	Condition	Indication
Voltage	$\leq 1.5 \text{ V}$	0 V
Current	$\leq 0.4\%$ of rated range	0 A
Active power	$\leq 0.17\%$ of rated range	0 W
Reactive power	$\leq 0.17\%$ of rated range	0 Var
Active electric energy	$\leq 0.17\%$ of rated range	0 Wh (integration stopped)

Displayed Item	Condition	Indication
Reactive power	V1 input $\leq 10\%$ of rated range; or frequency $\leq 40 \text{ Hz}$ or $\geq 70 \text{ Hz}$	---- Var
Power factor	The voltage or current is displayed as $\square r$; or V1 input $\leq 10\%$ of rated range; or frequency $\leq 40 \text{ Hz}$ or $\geq 70 \text{ Hz}$	---- PF
Frequency	$\leq 40 \text{ Hz}$ or $\geq 70 \text{ Hz}$	---- Hz

TIP

Even when an instantaneous value is displayed as $\square r$, the integration calculation is carried out continuously. The accuracy of the electric energy value, however, is undefined in this case.

2.4 Overrange and Other Marks Shown during Measurement

● Indications of Setting Items

Mark appearing during setting mode: **SET**

Setting Item	Displayed Mark
1. Device number	NO.
2. Loading and saving of settings	CONF
3. Deletion of measured-data file and formatting of PC card	FILE
4. Clearance of electric energy count (watt-hours) and resetting of system	RESET
5. Copying and clearance of backup memory	MEM
6. Date	DATE
7. Output interval	INTER
8. Integration start date and time	START
9. Integration stop date and time	STOP
10. Whether to save data to PC card	
11. Selection of communication device	DEV
12. Communication settings	COM
13. Communication protocol setting	Proto
14. VT ratio setting	VT
15. CT ratio setting	CT
16. Probe selection	
17. Decimal position and unit selections for electric energy (watt-hours)	DIGIT

● Indications during Measurement

Displayed Mark

	Lights when integration is carried out; flashes when integration is on stand-by.
	Lights when integration is controlled by external signals.
	Lights when PC card memory is full.
	Lights when the backup memory contains data.
	Lights when the battery voltage is low.
	Lights when the keys are locked.
	Lights when data saving to the PC card is enabled; flashes during access to the PC card.
	Flashes during access to the PC when a PC is selected as the communication device.
	Flashes during access to the printer when a printer is selected as the communication device.
	Lights when the VT ratio is set at a value other than 1.
	Lights when the CT ratio is set at a value other than 1.

Indications for current settings of voltage range, current range, and wiring method:

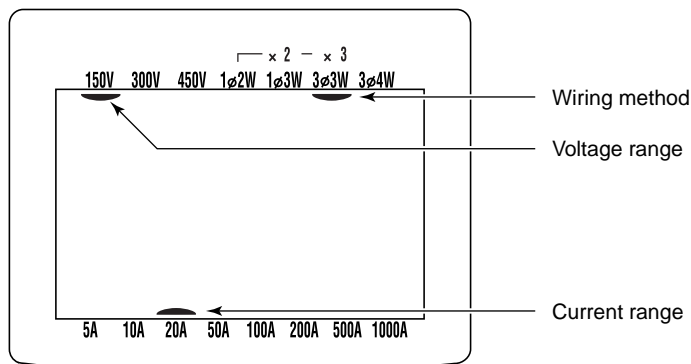

● Meanings of Messages

Displayed Message	Meaning
on t. StArT	Appears during standby of integration when set to start at a set date and time.
IntEr. StArT	Appears during standby of integration when a past point of time is set as the integration start time and date and integration will begin at the nearest appropriate time (determined by the output interval).
IntEG. End	Appears when integration has finished normally with the set integration start/stop dates and times.
P_FAIL	Appears when a power failure has occurred (or the power has been turned off) during standby or integration.
dAtA CoPY	Appears when the backup data is copied from the backup memory to the PC card.
CArd Err.	Appears when a PC card is not inserted.
FILE 000_01	Shows the file number and data record number when saving measured instantaneous values.
FILE 000	Shows the file number when integration begins in the case that data saving to a PC card is enabled but the filename is not specified.
FILE dEF InE	Appears when integration begins in the case that data saving to a PC card is enabled and the filename is specified. The digits following "FILE" indicate "defined."

3.1 Handling Precautions

If you are a first-time user, be sure to read “Precautions for Safe Use of Instrument” on pages 4 and 5, Section 5.1, “Precautions for Wiring the Circuit under Test,” and Section 5.3, “Wiring the Circuit under Test with External VT/CT.”

- **Do not place any load on the instrument.**

Do not place any other equipment of a vessel filled with water on the instrument. Otherwise, the instrument may become defective.

- **Moving the instrument**

Before moving the instrument, make sure the power cord and all other cables are disconnected.

- **Input Terminals**

Do not bring any electrified substance close to the signal terminals. Otherwise, the internal circuitry may be destroyed. Do not apply any mechanical shock to the signal terminals. Otherwise, such impact may be transformed into electrical noise and input to the instrument.

- **Protection of Case and Operation Panel**

Do not spray any volatile chemical on the case or operation panel. Do not leave any rubber or vinyl product in contact with the instrument for a prolonged period. Otherwise, the instrument may be discolored or deformed.

- **Cleaning**

When cleaning the case and/or operation panel, disconnect the power cord from the outlet. Then, wipe the surfaces of the case and/or operation panel with a soft clean cloth. Do not use chemicals such as benzine or paint thinner. Otherwise, the instrument may be discolored or deformed.

- **Display Screen**

When the instrument is shipped from the factory, the display screen is covered with a protective film. Remove the film before you begin using the instrument.

3.1 Handling Precautions

- **After Use**

After use, disconnect the power cord from the outlet.

Precautions for Use of the Clamp

CAUTION

- The clamping CT (current transformer) is precision assembled to ensure high performance. When using the clamp, do not apply any intense mechanical shock, vibration or force to the clamping CT.
 - If dust or any other foreign matter gets in the clamping CT, do not shut the clamping cores tight. First remove the dust and then make sure the clamping cores on both sides close smoothly.
-
-

3.2 Installation Procedure

Install the CW120/121 in a location that satisfies the following conditions.

- **Indoors**

- **Ambient Temperature and Humidity**

- Ambient temperature: 0°C to 50°C
- Ambient humidity: 5 to 85 % RH (no condensation)

When it is applied to UL.

- Ambient temperature: 0°C to 40°C
- Ambient humidity: 5 to 85 % RH (no condensation)

Maximum relative humidity 80 % RH for temperature up to 31 °C decreasing linearly to 50 % RH relative humidity at 40 °C.

- **Altitude of Location**

- Altitude: 2000 m or less

- **Measurement Category (CAT.)**

The measurement category of the CW120/121 is III.

Measurement category		Remarks	Description
II	CAT.II	For measurements performed on circuits directly connected to the low voltage installation.	Appliances, portable equipments, etc.
III	CAT.III	For measurements performed in the building installation.	Distribution board, circuit breaker, etc.
IV	CAT.IV	For measurements performed at the source of the low-voltage installation.	Overhead wire, cable systems, etc.

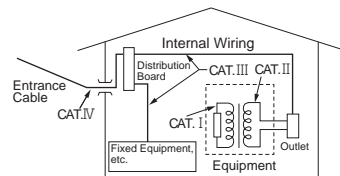

3.2 Installation Procedure

- **Installation Category (CAT.)**

- Voltage measurement circuit: CAT.III (Max. input voltage: 600 Vrms)
- Power supply : CAT.II (Max. input voltage: 264 Vrms)

Installation Category		Description
II	CAT.II	Applies to electrical equipment which is supplied from the fixed installation like distribution board.
III	CAT.III	Applies to electrical equipment which is power-supplied from a cable way ranging from the primary stage and branch point of equipment directly introducing electricity from a distribution board to the wall outlet.
IV	CAT.IV	Applies to electrical equipment which is power-supplied from a cable way ranging from the entrance cable of a building to a primary overcurrent protection.

- **Pollution Degree**

“Pollution degree” describes the degree to which a solid, liquid, or gas which deteriorates dielectric strength or surface resistivity is adhering. “2” applies to normal indoor atmosphere.

Normally, only non-conductive pollution occurs. Occasionally, however, temporary conductivity caused by condensation must be expected.

The CW120/121 meet the “Pollution degree 2”.

CAUTION

- When using or installing two or more CW120/121 power meters, leave a distance of at least 10 mm (0.4") between them.
 - When putting a power meter inside a power distribution panel or the like, leave a space of at least 10 mm (0.4") from a wall and ensure that excess pressure may not be applied to the protruding plugs and jacks on the terminals.
-
-

- **Level Location**

Do not install the CW120/121 in an unstable or inclined location; inaccurate measurements may result.

- **Other Conditions**

Do not install the CW120/121 in a location that is:

- exposed to direct sunlight or close to a heat source;
- close to a noise source such as high-voltage equipment or a power source;
- exposed to a relatively large amount of lampblack, steam, dust, or corrosive gas;
- exposed to frequent mechanical vibration;
- close to a source of strong electromagnetic fields; or
- unstable.

3.3 Maintaining High Precision of Measurement

To achieve a high precision of measurement, use the CW120/121 under the following conditions.

- Ambient temperature: $23^{\circ} \pm 5^{\circ}\text{C}$
- Ambient humidity: 35 to 75% RH (no condensation)

When installing the CW120/121 in a location where the ambient relative humidity is 30% or less, use such equipment as an anti-static mat to prevent electrostatic discharge.

If you move the CW120/121 from an area of low temperature and humidity to an area of high temperature and humidity or if there is a sudden change in the ambient temperature, condensation may occur in the meter. If this happens, let the meter stand for at least one hour to allow it to adapt to the new ambient temperature and for condensation to evaporate. Then, start operating the meter.

● **Relationship between Clamp and Conductor**

1. When performing a measurement, hold the clamp-on probe so that the conductor cable runs through the center of the clamping CT.
2. Ensure that the orientation of the clamp to the direction of the conductor cable (from the power supply to the load) is correct, as shown in the figure.
3. Ensure that the clamping CT is properly closed.

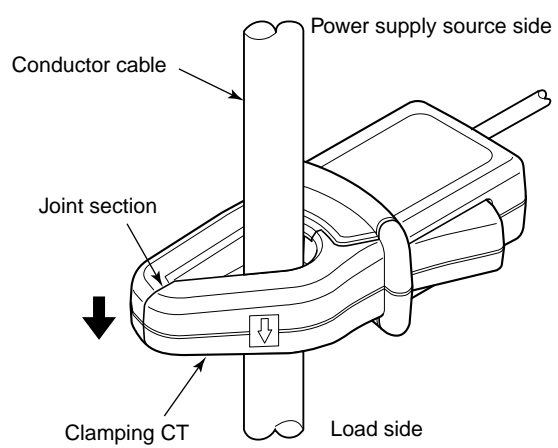

4.1 When Using AC Power Supply

● Before Connecting Power Supply

There is a danger of electric shock or damage to the meter. Observe the following warning notes.

WARNING

- Use only the dedicated power cord supplied by the manufacturer.
- Before connecting the power cord, make sure the power-source voltage matches the rated supply voltage.
- Before connecting the power cord, also make sure the power switch of the CW120 or CW121 is turned off.
- If the CW120 or CW121 will not be used for a prolonged period, disconnect the power cord from the outlet.
- Do not place any load on the power cord or allow the power cord to come into accidental contact with a heat source.
- Be sure to hold the plug of the power cord, rather than holding and pulling the cord itself, when disconnecting it from the outlet.

● Procedure for Connecting Power Cord

Follow the steps below to connect the power cord.

1. Make sure the power switch of the CW120/121 is turned off.
2. Plug one end of the power cord supplied with the CW120/121 into the power supply jack on the side of the CW120/121.
3. Plug the other end of the power cord into a power outlet that meets the requirements below.

Required Power Ratings

Rated supply voltage	100 to 240 V AC
Allowable supply voltage range	90 to 264 V AC
Rated power supply frequency	50 or 60 Hz
Allowable supply frequency range	48 to 63 Hz
Maximum power consumption	8 VA (at 240 V AC)

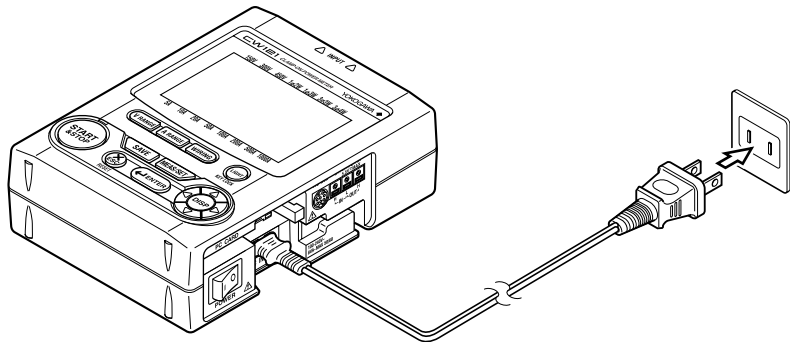



NOTE

- When plugging and unplugging the power cord into/from the CW120 or CW121, ensure that the PC card eject button is depressed.
 - The CW120 or CW121 will not work if the fuse built into the power supply circuit of the CW120 or CW121 has blown.
 - Built-in fuses cannot be replaced by the user. For replacement, contact the vendor from which you purchased the instrument.
-
-

4.2 When Supplying Power from Voltage Input

NOTE

The 98030 power supply cable is not applicable to CE and UL.

● Before Connecting Power Supply

There is a danger of electric shock or damage to the meter. Observe the following warning notes.

WARNING

- Use only the optional power cable (part No. 98030) supplied by the manufacturer.
- Make sure the voltage of the circuit to be measured matches the rated supply voltage (i.e., 100 to 240 V AC).
- Before connecting to the circuit to be measured, make sure the power to the circuit is turned off.
- Before connecting the power cable, make sure the power switch of the CW120 or CW121 is turned off.
- Do not place any load on the power cord or allow the power cord to come into accidental contact with a heat source.

● Procedure for Connecting 98030 Power Supply Cable

Follow the steps below to connect the 98030 power supply cable.

1. Make sure the power switch of the CW120/121 is turned off.
2. Insert the plug of the 98030 power supply cable into the power supply jack on the side of the CW120/121.
3. Insert the black banana plug of the power supply cable into terminal N of the CW120/121, and red banana plug into terminal V1.
4. Connect the black plug of the voltage probe to the black banana plug, and the red plug of the probe to the red banana plug.
5. Check that the power to the circuit to be measured is turned off, and then connect the voltage probes to the circuit.

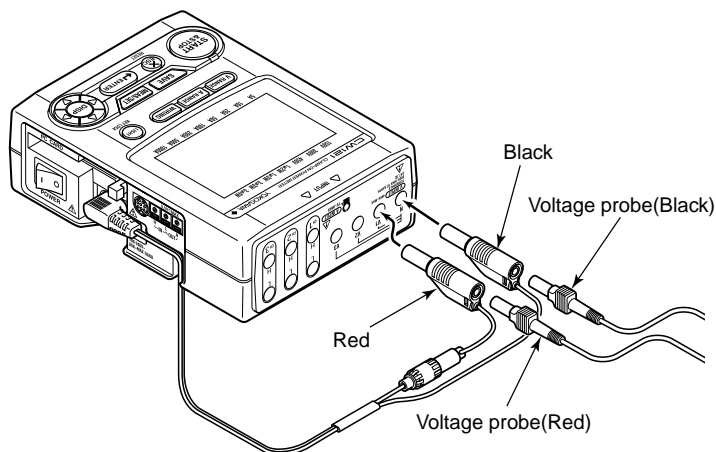

4.3 Startup Screens

When you turn on the power to the CW120 or CW121, the screens shown in (1) to (3) below appear sequentially in order.

(1) All-segment On

All segments light for approximately 2 seconds, then the screen changes to the model and version display.

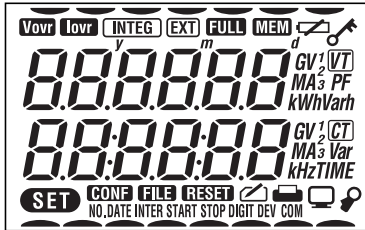

(2) Model and Version Display Screen

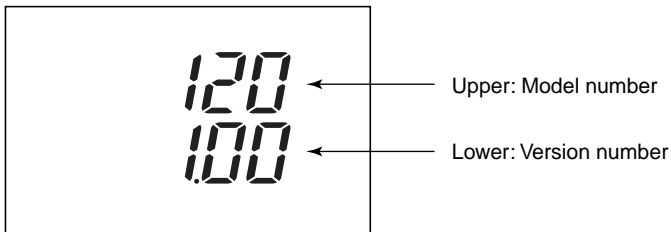

While the display is turning on all segments and showing the model and version numbers, the CW120/121 performs a self-test. If no error is found, the measurement screen appears.

(3) Measurement Screen

Example of measurement screen

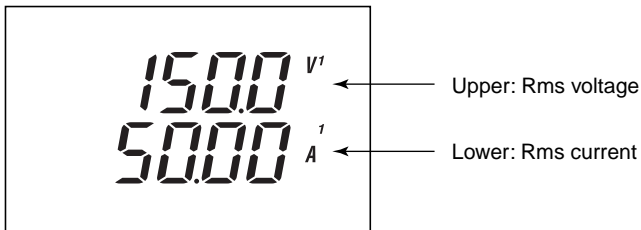

● **Self-test Details and Error Handling**
Test Items and Errors

No.	Test Item	Error Number(s)
1	Backup SRAM check	<i>Err.001</i>
2	EEPROM check	<i>Err.002</i> to <i>Err.005</i>
3 _@	Real-time clock check	<i>Err.006</i> to <i>Err.007</i>
4	Setting check	<i>Err.009</i> to <i>Err.010</i>
5	External memory controller check	<i>Err.008</i>

If an error is found during the self-test, an error number is displayed. Confirm the error number and press any key, then the screen changes to the measurement screen.

 **NOTE**

- If an error is found with any of test item Nos. 1, 3, and 4 (backup SRAM check, real-time clock check, and setting check), the settings, date, and time will be initialized.
- The above situation may occur when the backup battery has become flat. When the  (low battery) sign is displayed on the screen, the backup battery needs to be replaced.
- The backup battery cannot be replaced by the user. For replacement, contact the vendor from which you purchased the instrument.
- The backup battery life is about 10 years.

SEE ALSO

For details of errors and the countermeasures, see Chapter 13, "Troubleshooting."

4.4 Basic Operation Flow

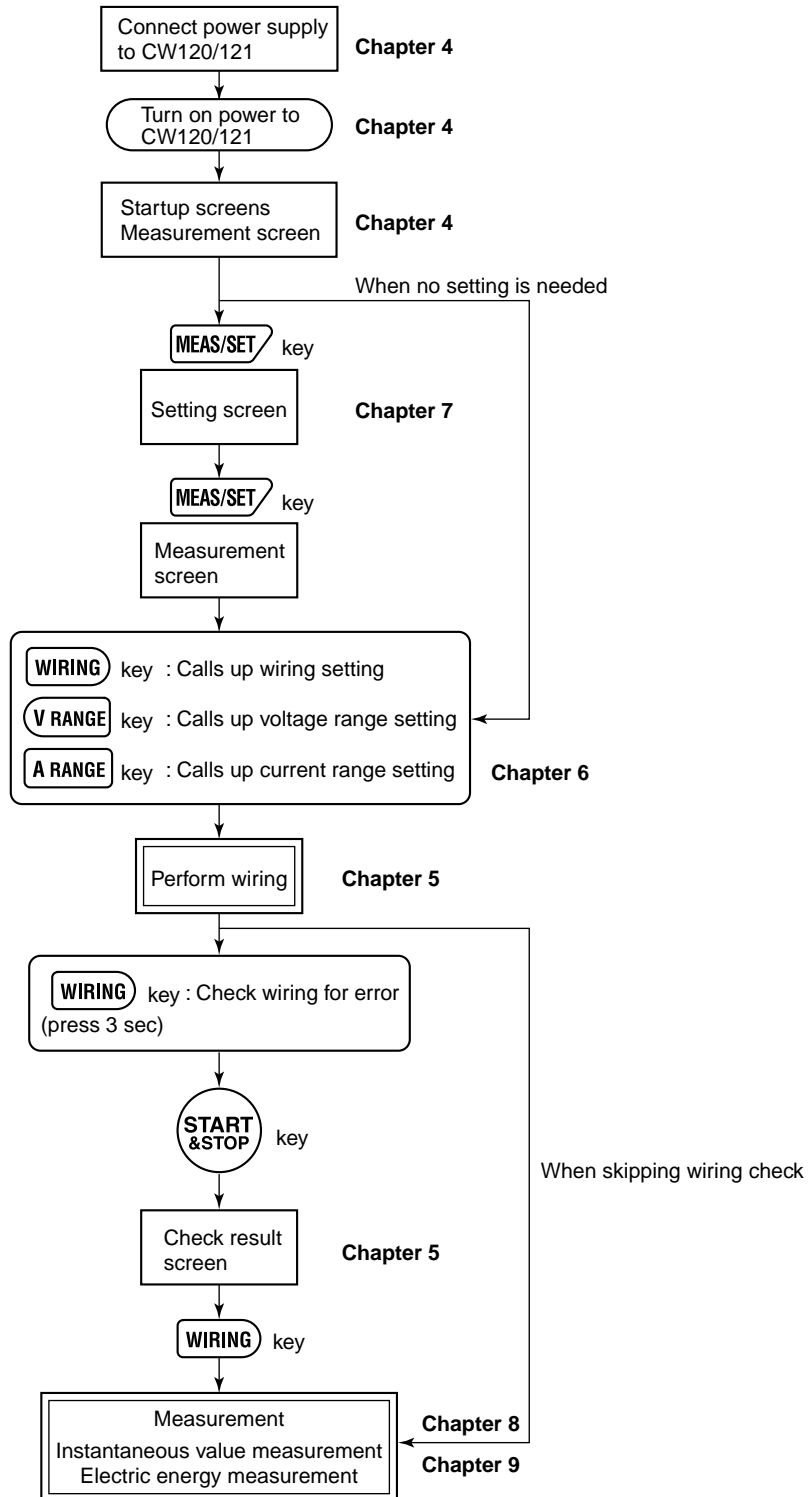

5.1 Precautions for Wiring the Circuit under Test

WARNING

- When wiring the CW120 or CW121, or when it is turned off, turn off the circuit under test. It is highly dangerous to connect or disconnect voltage or clamp-on current probes without first turning off the circuit under test.
- Be extremely careful not to connect any voltage-mode circuit to the current input terminals or any current-mode circuit to the voltage input terminals. Miswiring can result in not only damage to the circuit under test or equipment under test but also injury to personnel.
- Do not apply any input level higher than the following to the voltage or current input terminals (the upper limit differs depending on the probe used):

Maximum allowable input (continuous)

Voltage input:	495 Vrms
Current input –for 96033 probe:	130 Arms
for 96030 probe:	250 Arms
for 96031 probe:	625 Arms
for 96032 probe:	700 Arms (1000 Arms for 5 minutes)

Input ratings for each range

Voltage input:	150/300/450 V
Current input –for 96033 probe:	5/10/20/50 A
for 96030 probe:	20/50/100/200 A
for 96031 probe:	50/100/200/500 A
for 96032 probe:	200/500/1000 A

SEE ALSO

For details, see Chapter 14, “Specifications.”

WARNING

- If using an external voltage transformer (VT) or current transformer (CT), make sure the transformer can adequately withstand the voltage being measured. Be extremely careful not to allow the secondary stage of the CT to become open-circuited while the CT is being electrified. Otherwise, a high-voltage may develop on the secondary stage, causing extreme danger.
- The maximum allowable input voltage range of the external control input terminals is -0.5 to 5.5 V. Do not apply voltages exceeding this range, otherwise the input circuitry may be damaged. (When wiring the input terminals, ensure that you wire the right terminals.)
- Do not use any probe other than the voltage probes supplied with the CW120/121 or dedicated clamp-on current probes.
- Do not use a clamp-on probe with any non-insulated conductors.

5.2 Diagrams of Basic Wiring

This section explains the methods of basic wiring using illustrations.

Single-phase two wires (1Ø2W)

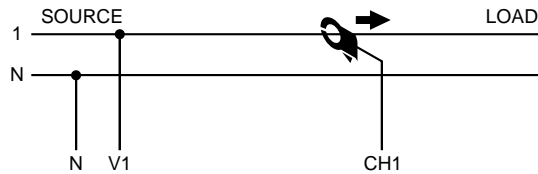

Single-phase three wires (1Ø3W)

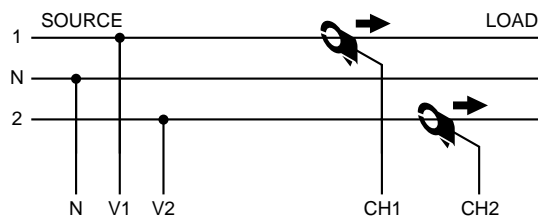

Three-phase three wires (3Ø3W)

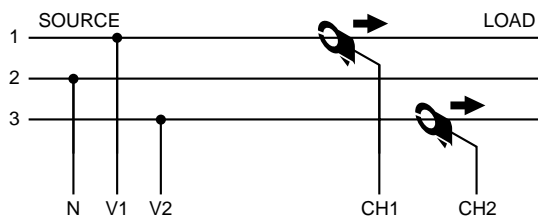

Three-phase four wires (3Ø4W): Only for CW121

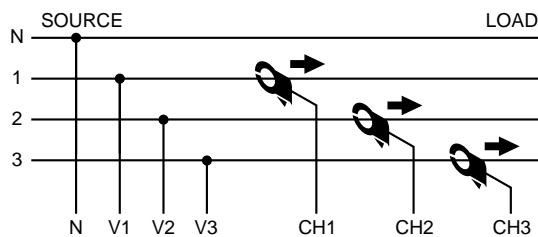

Single-phase two-wires x2 (1Ø2W x2)

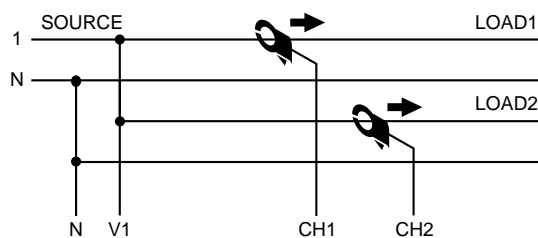

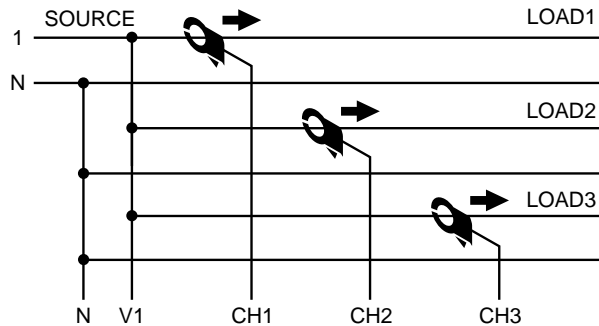
Single-phase tow-wires ×3 (1Ø2W ×3): Only for CW121

The table below shows the correspondences between the voltage/current units (sets of a unit + input number) displayed on the screen and the input terminals for voltage and clamp-on current probes.

Wiring Method (Phase Lines)	Voltage Inputs	Current Inputs
Single-phase two wires (1Ø2W)	Terminals: N-V1 Units: V1	Terminals: CH1 Units: A1
Single-phase three wires (1Ø3W)	Terminals: N-V1, N-V2 Units: V1, V2	Terminals: CH1, CH2 Units: A1, A2
Three-phase three wires (3Ø3W)	Terminals: N-V1, N-V2 Units: V1, V2	Terminals: CH1, CH2 Units: A1, A2
Three-phase four wires* (3Ø4W)	Terminals: N-V1, N-V2, N-V3 Units: V1, V2, V3	Terminals: CH1, CH2, CH3 Units: A1, A2, A3
Single-phase tow-wires ×2 (1Ø2W ×2)	Terminals: N-V1 Units: V1	Terminals: CH1, CH2 Units: A1, A2
Single-phase tow-wires* ×3 (1Ø2W ×3)	Terminals: N-V1 Units: V1	Terminals: CH1, CH2, CH3 Units: A1, A2, A3

* Only for CW121

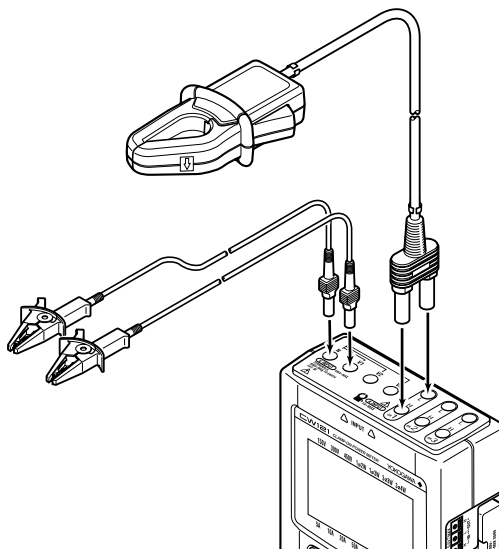

5.3 Wiring the Circuit under Test with External VT/CT

WARNING

- When using an external current transformer (CT), be careful not to allow the secondary stage of the CT to become open-circuited while the primary stage is being electrified. Otherwise, a high-voltage may develop on the secondary stage, causing extreme danger.
- A measuring current flows through the bold lines shown in the figure below. For these lines, use wires having an adequate margin of current-carrying capacity.

If the maximum voltage or current level being measured exceeds the maximum measurement range of the CW120/121, use an external voltage transformer (VT) or current transformer (CT). This strategy enables the voltage or current levels beyond the maximum range to be measured.

When to use a VT and how?

If the maximum voltage of the circuit exceeds 450 V, connect an external VT and connect the secondary stage of the VT to the voltage input terminals.

When to use a CT and how?

If the maximum current of the circuit exceeds the following value, connect an external CT and clamp the secondary stage wire of the CT with a current probe.

96033 probe:	50 A (rated at 5/10/20/50 A)
96030 probe:	200 A (rated at 20/50/100/200 A)
96031 probe:	500 A (rated at 50/100/200/500 A)
96032 probe:	1000 A (rated at 200/500/1000 A)

Example for single-phase two wires (1Ø2W)

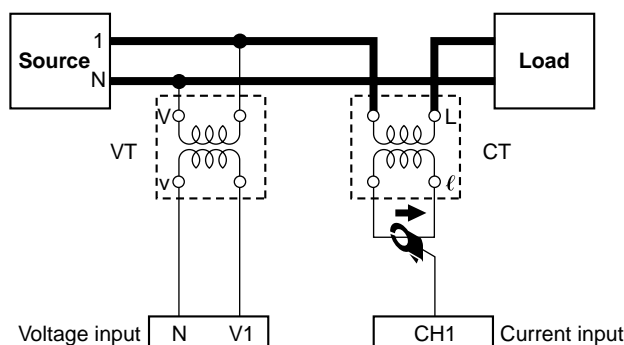

Scaling

When using a VT and/or CT, you can set the VT ratio and/or CT ratio to display the readings of the primary circuit voltages and currents. (This is called the scaling function.)



SEE ALSO

For details of how to set the CT and VT ratios, see Sections 7.2.14 and 7.2.15, "Setting VT Ratio" and "Setting CT Ratio."

5.4 Indication and Change of Wiring Method

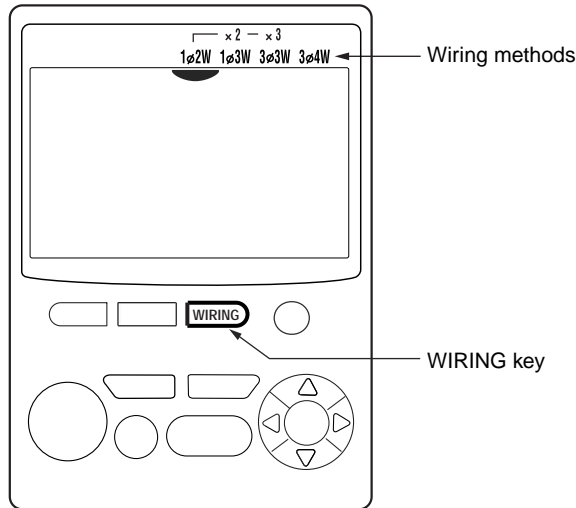
The abbreviations for wiring methods are labeled immediately above the screen as 1Ø2W, 1Ø3W, 3Ø3W, 3Ø4W, 1Ø2W×2, and 1Ø2W×3 (3Ø4W, 1Ø2W×3 are not included for the CW120), and the  sign on the screen indicates the wiring method currently selected in the CW120/121.



To change the wiring method, press the  key. Each time you press the WIRING key, the  moves to change the selected wiring method.

Indication of wiring method.

<1Ø2W x2>
CW120

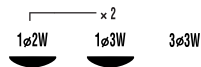

CW121

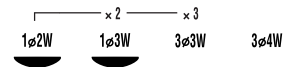

<1Ø2W x3>
CW121

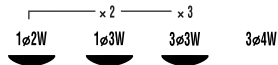

5.5 Wiring Check Function

WARNING

- It is important to check the wiring for correct and safe measurement. Check the wiring with reference to Chapter 3, “Precautions for Safe Measurement,” Section 5.1, “Precautions for Wiring the Circuit under Test,” and Section 5.3, “Wiring the Circuit under Test with External VT/CT.”
 - Check the connections of voltage probes, and for clamp-on current probes, check the models (ratings), H/L polarities of the plugs and jacks, and the arrow symbols on the clamps corresponding to the source-to-load directions of the circuit.
 - Do not use a clamp-on current probe with any non-insulated conductor.
-

● Check Items

The following items are checked and judged, and then the result of each check item will be displayed as shown on the next page.

For each voltage input:

1. Existence of input voltages
2. Frequency detection
3. Voltage phase sequence

For each current input:

1. Existence of input currents
2. Clamp directions

NOTE

- Measurement is not performed during the wiring check.
 - The wiring check cannot be carried out during continuous measurement.
-

● Check Items and Criteria

Voltage Inputs

Item	Criteria	Error Message (in lower row)
1. Existence of voltage inputs	<ul style="list-style-type: none"> If an input level is 10% or less of the range, then an error results. Else, the frequency detection takes place. 	Error message <i>Lo_Err</i> v
2. Frequency detection	<ul style="list-style-type: none"> If the frequency of input V1 exceeds the 40 to 70 Hz range, then an error results. Else, the voltage phase sequence check takes place. 	Error message <i>Err.</i> Hz
3. Voltage phase sequence	For 1Ø2W or 1Ø3W: <ul style="list-style-type: none"> This item is not checked. For 3Ø3W: <ul style="list-style-type: none"> If V2 leads V1 by more than approximately 80 degrees or less than approximately 40 degrees, an error results. For 3Ø4W (only for the CW121): <ul style="list-style-type: none"> If V2 lags behind V1 by more than approximately 140 degrees or less than approximately 100 degrees, an error results. Or if V3 leads V1 by more than approximately 140 degrees or less than approximately 100 degrees, an error results. 	Error message <i>Err.</i> v
	<ul style="list-style-type: none"> Else, "Good" is displayed. 	<i>Good</i> v

Current Inputs

Item	Criteria	Error Message (in lower row)
1. Existence of input currents	<ul style="list-style-type: none"> If an input level is 1% or less of the range, then an error results. Else, the clamp direction check takes place. 	Error message <i>Lo_Err</i> A
2. Clamp directions	<ul style="list-style-type: none"> For any wiring method other than 3Ø3W, if the power of one or more phases is negative, an error results. For 3Ø3W, if the whole power is negative, an error results. 	Error message <i>Err.</i> A
	<ul style="list-style-type: none"> Else, "Good" is displayed. 	<i>Good</i> A

 **NOTE**

- As the wiring is judged on the above criteria, an error may result even when wiring is correct or wrong wiring may pass the check.
- When a measured value appears to be abnormal, check the above criteria and wiring again.

5.5 Wiring Check Function

● Carrying out Wiring Check

- (1) When the measurement screen is displayed, press the **WIRING** key for at least three seconds, and “**CHEC.**” appears on the screen and flashes.

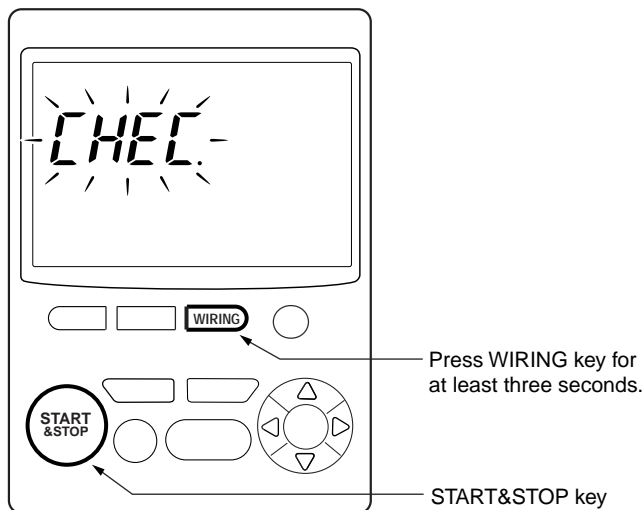

- (2) Press the **START & STOP** key. Then, “**CHEC.**” stops flashing and the wiring check begins.

- (3) When no error has been found, “**Good**” is displayed on both the upper and lower rows. Press the **WIRING** key to return to the measurement screen.

When no error

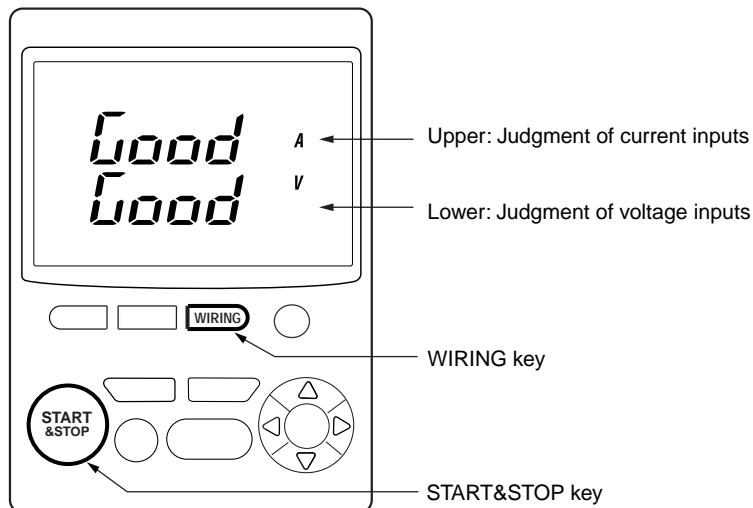

When an error is displayed, refer to the table on page 5-8 and check the meaning of the error. Check and correct the connections, then press the  key to carry out the wiring check again.

To return to the measurement screen, press the  key.

Example of error indications

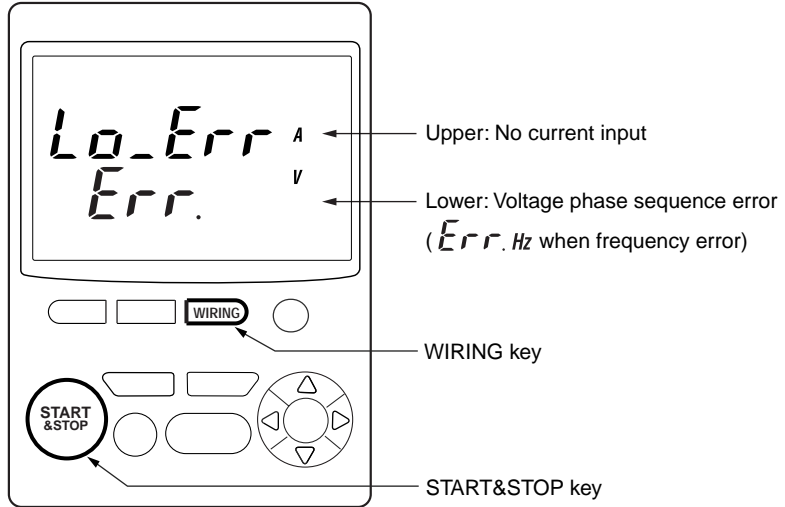

6.1 Ranges and Display Digits

The following describes the voltage, current, power, and electric energy ranges.

- **Voltage Range**

150/300/450 V

- **Current Range**

96033 clamp-on probe: 5/10/20/50 A

96030 clamp-on probe: 20/50/100/200 A

96031 clamp-on probe: 50/100/200/500 A

96032 clamp-on probe: 200/500/1000 A

- **Range of Active and Reactive Powers**

The range of active and reactive powers is determined by the voltage range, current range, and wiring method set as follows:

Wiring Method (Phase Lines)	Power Range
Single-phase two wires Single-phase two-wires × 2 Single-phase two-wires × 3*	Voltage range × current range
Single-phase three wires Three-phase three wires	Voltage range × current range × 2
Three-phase four wires*	Voltage range × current range × 3

*Only for CW121

6.1 Ranges and Display Digits

● Range Table (Table of Full Scales) – Rated Power

The table below shows the rated powers corresponding to combinations of voltage and current ranges.

Voltage (V) Range	Phase Lines	Current (A) Range							
		96032 Probe (200–1000 A)							
		96031 Probe (50–500 A)							
		96030 Probe (20–200 A)							
		96033 Probe (5–50 A)							
		5.000 A	10.00 A	20.00 A	50.00 A	100.0 A	200.0 A	500.0 A	1.000 kA
150 V	1Ø2W								
	1Ø2W ×2	750.0 W	1.500 kW	3.000 kW	7.500 kW	15.00 kW	30.00 kW	75.00 kW	150.0 kW
	1Ø2W ×3*								
	1Ø3W	1.500 kW	3.000 kW	6.000 kW	15.00 kW	30.00 kW	60.00 kW	150.0 kW	300.0 kW
	3Ø3W	1.500 kW	3.000 kW	6.000 kW	15.00 kW	30.00 kW	60.00 kW	150.0 kW	300.0 kW
	3Ø4W*	2.250 kW	4.500 kW	9.000 kW	22.50 kW	45.00 kW	90.00 kW	225.0 kW	450.0 kW
300 V	1Ø2W								
	1Ø2W ×2	1.500 kW	3.000 kW	6.000 kW	15.00 kW	30.00 kW	60.00 kW	150.0 kW	300.0 kW
	1Ø2W ×3*								
	1Ø3W	3.000 kW	6.000 kW	12.00 kW	30.00 kW	60.00 kW	120.0 kW	300.0 kW	600.0 kW
	3Ø3W	3.000 kW	6.000 kW	12.00 kW	30.00 kW	60.00 kW	120.0 kW	300.0 kW	600.0 kW
	3Ø4W*	4.500 kW	9.000 kW	18.00 kW	45.00 kW	90.00 kW	180.0 kW	450.0 kW	900.0 kW
450 V	1Ø2W								
	1Ø2W ×2	2.250 kW	4.500 kW	9.000 kW	22.50 kW	45.00 kW	90.00 kW	225.0 kW	450.0 kW
	1Ø2W ×3*								
	1Ø3W	4.500 kW	9.000 kW	18.00 kW	45.00 kW	90.00 kW	180.0 kW	450.0 kW	900.0 kW
	3Ø3W	4.500 kW	9.000 kW	18.00 kW	45.00 kW	90.00 kW	180.0 kW	450.0 kW	900.0 kW
	3Ø4W*	6.750 kW	13.50 kW	27.00 kW	67.50 kW	135.0 kW	270.0 kW	675.0 kW	1.350 MW

* Only for CW121

TIP

For reactive power, the same table applies but the units of measurement are different.

Units of reactive power: Var, kVar, MVar

If either or both of the VT and CT ratios are set to a value other than 1, and if the product of the following formula exceeds 9999, the decimal point is incremented by one:

Rated power in table × VT ratio × CT ratio × 1.3

- **Display Digits**

The tables below show the display digits, decimal point positions, and units of measurement.

Voltage – Maximum Display Digits: 4

Range × VT Ratio (× 1.3)*	Decimal Point Position and Unit
150 to 999.9 V	999.9 V
1 to 9.999 kV	9.999 kV
10 to 99.99 kV	99.99 kV
100 to 999.9 kV	999.9 kV
1 to 4.5 MV	4.500 MV

Current – Maximum Display Digits: 4

Range × CT Ratio (× 1.3)*	Decimal Point Position and Unit
5 to 9.999 A	9.999 A
10 to 99.99 A	99.99 A
100 to 999.9 A	999.9 A
1 to 9.999 kA	9.999 kA
10 to 99.99 kA	99.99 kA
100 to 999.9 kA	999.9 kA
1 to 9.999 MA	9.999 MA
10 MA	10.00 MA

Frequency – Maximum Display Digits: 4

Input Frequency	Decimal Point Position and Unit
40 to 70 Hz	70.00 Hz

Power – Maximum Display Digits: 4

Rated Power × VT Ratio × CT Ratio (× 1.3)*	Decimal Point Position and Unit
975 to 999.9 W	999.9 W
1 to 9.999 W	9.999 W
10 to 99.99 W	99.99 W
100 to 999.9 W	999.9 W
1 to 9.999 kW	9.999 kW
10 to 99.99 kW	99.99 kW
100 to 999.9 kW	999.9 kW
1 to 9.999 MW	9.999 MW
10 to 99.99 MW	99.99 MW
100 to 999.9 MW	999.9 MW
1 to 9.999 GW	9.999 GW
10 to 99.99 GW	99.99 GW
100 to 999.9 GW	999.9 GW
1000 to 9999 GW	9999 GW

* Multiply by 1.3 only when the CT or VT ratio is a value other than 1.

6.1 Ranges and Display Digits

TIP

For reactive power, the same table as for the power applies but the units of measurement are different.

Units of reactive power: Var, kVar, MVar, GVar

Power Factor – Maximum Display Digits: 4

Power Factor	Decimal Point Position and Unit
-1 to 1	1.000

● Decimal Point Position and Unit for Electric Energy

The decimal point position and unit of measurement for electric energy can be set via the screen (see Section 7.2.17, “Selecting Decimal Point Position and Unit for Electric Energy”).

- Decimal point: Selectable from 000.000, 0000.00, 00000.0, and 000000
- Unit: Selectable from Wh, kWh, MWh, and GWh

By selecting **STANDARD**, you can also let the CW120/121 automatically set them as follows.

Rated Power × VT Ratio × CT Ratio (× 1.3)*	Decimal Point Position and Unit for Electric energy (Max. Count)
1 to 9.999 W	0.00 to 9999.99 Wh
10 to 99.99 W	0.0 to 99999.9 Wh
100 to 999.9 W	0.000 to 999.999 kWh
1 to 9.999 kW	0.00 to 9999.99 kWh
10 to 99.99 kW	0.0 to 99999.9 kWh
100 to 999.9 kW	0.000 to 999.999 MWh
1 to 9.999 MW	0.00 to 9999.99 MWh
10 to 99.99 MW	0.0 to 99999.9 MWh
100 to 999.9 MW	0.000 to 999.999 GWh
1 to 9.999 GW	0.00 to 9999.99 GWh
10 to 99.99 GW	0.0 to 99999.9 GWh
100 to 999.9 GW	0 to 999999 GWh

* Multiply by 1.3 only when the CT or VT ratio is a value other than 1.

SEE ALSO

For the setting procedures, see Chapter 7, “Making Settings.”

When the electric energy count has reached the maximum, the count will be reset to zero as illustrated below.

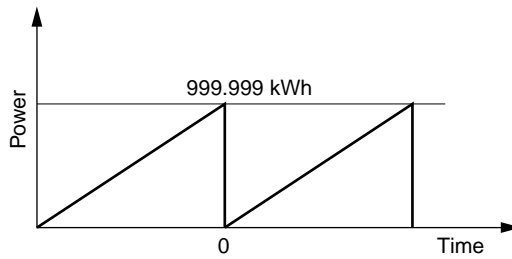

WARNING

When newly starting integrating power, clear the electric energy count (and the elapsed time of integration). Otherwise, the electric energy count will be added to the previous value. For details of how to clear the electric energy count, see Section 9.2.3, “Clearing Electric Energy Count,” or Section 7.2.4, “Clearing Electric Energy Count and Resetting System,” in Chapter 7, “Making Settings.”

6.2 Changing Voltage Range Setting

● Procedure to Change Voltage Range Setting

- (1) The  sign is displayed uppermost on the screen, under the voltage range currently selected. To change the range, press the **V RANGE** key when the measurement screen is displayed.

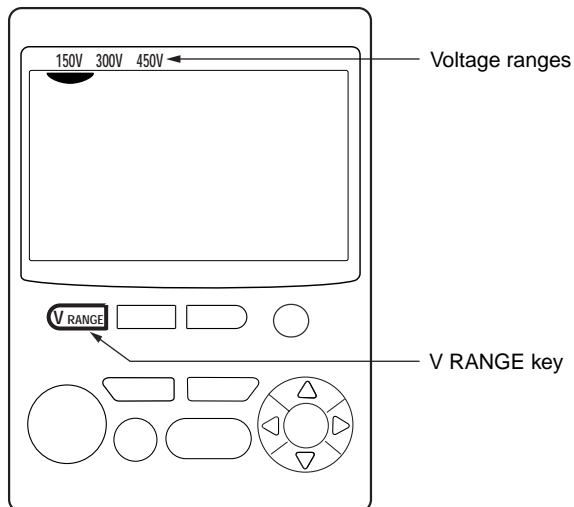

Each press of the **V RANGE** key changes the range selection sequentially as follows:

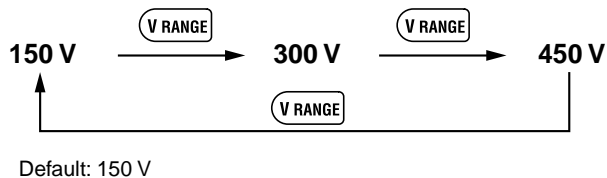

TIP

- If a change to the range setting is incompatible with the conditions derived from other settings, **SEtErr** is displayed and the change is ineffective. First change other settings such as the current range, VT ratio, CT ratio, and wiring method, then change the voltage range.
- The voltage range cannot be changed during continuous measurement.
- The voltage range cannot be changed when the electric energy count is not zero. Pressing the **V RANGE** key at this time causes **Err.300** to appear on the screen (this will disappear and the measurement screen will return when any key is pressed). Clear the electric energy count first. For details of how to do this, see Section 9.2.3, "Clearing Electric Energy Count," or Section 7.2.4, "Clearing Electric Energy Count and Resetting System," in Chapter 7, "Making Settings."

6.3 Changing Current Range Setting

● Procedure to Change Current Range Setting

- (1) The  sign is displayed lowermost on the screen, above the current range currently selected. To change the range, press the **A RANGE** key when the measurement screen is displayed.

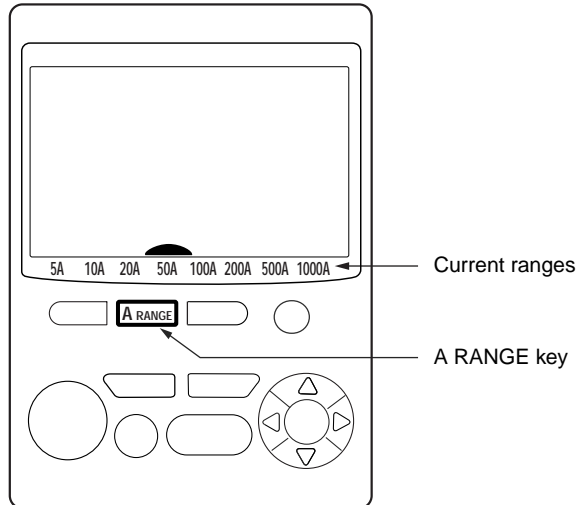

Each press of the **A RANGE** key changes the range selection sequentially as follows:

When the 96030 clamp-on probe is selected for use

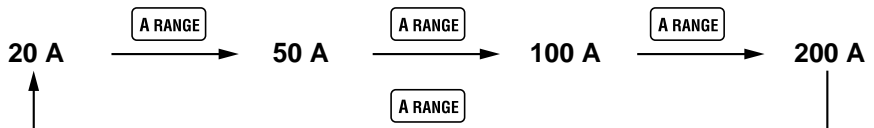

Default: 20 A

TIP

- If a change to the range setting is incompatible with the conditions derived from other settings, **SEtErr** is displayed and the change is ineffective. First change other settings such as the current range, VT ratio, CT ratio, and wiring method, then change the voltage range.
- The voltage range cannot be changed during continuous measurement.
- The voltage range cannot be changed when the electric energy count is not zero. Pressing the **A RANGE** key at this time causes **Err300** to appear on the screen (this will disappear and the measurement screen will return when any key is pressed). Clear the electric energy count first. For details of how to do this, see Section 9.2.3, "Clearing Electric Energy Count," or Section 7.2.4, "Clearing Electric Energy Count and Resetting System," in Chapter 7, "Making Settings."

6.3 Changing Current Range Setting

When the 96033 clamp-on probe is selected for use

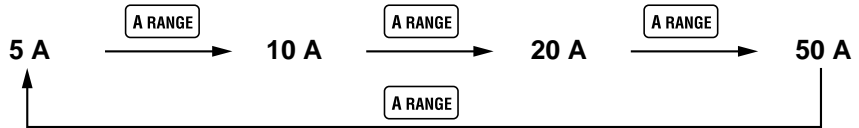

Default: 5 A

When the 96031 clamp-on probe is selected for use

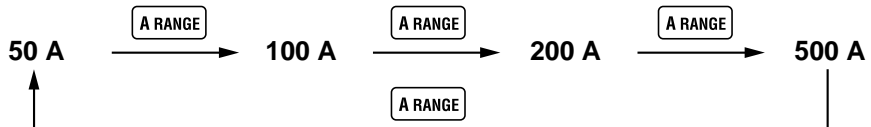

Default: 50 A

When the 96032 clamp-on probe is selected for use

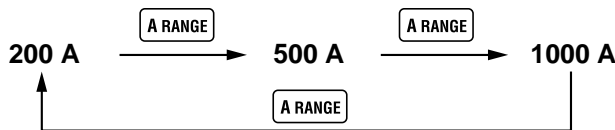

Default: 200 A

- **Selecting Clamp-on Current Probe to Be Used**

The current ranges that can be selected vary with the clamp-on current probe used. The probe selection can be changed from a setting screen.

Clamp-on Current Probe Models and Ratings

Clamp-on Current Probe Model	Setting	Rating (Ranges)
96033	50 A	5/10/20/50 A
96030	200 A	20/50/100/200 A
96031	500 A	50/100/200/500 A
96032	1000 A	200/500/1000 A

Default: 200 A

Procedure to Change Probe Selection

- (1) Press the **MEAS/SET** key when the measurement screen is displayed. The screen switches to the setting item selection screen and the **SET** sign appears in the lower left of the screen.
- (2) Using the \triangle ∇ \triangleleft \triangleright keys, make the \bullet mark (in the lower right) and its current setting appear on the screen. Then, press the **ENTER** key. The number representing the currently selected clamp model flashes.

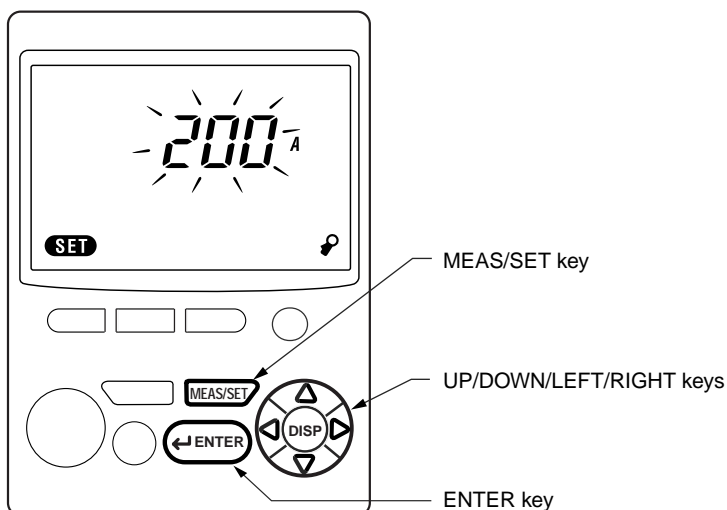

(3) Using the \triangle ∇ \triangleleft \triangleright keys, select the number corresponding to the desired clamp-on current probe.

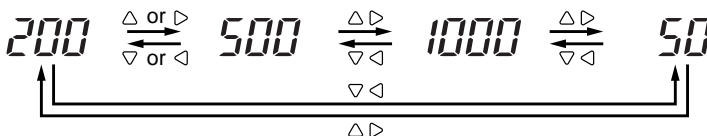

(4) Press the \leftarrow ENTER key.

(5) Press the MEAS/SET key to return to the measurement screen. The range is changed according to the new probe selected.

SEE ALSO

For details of the clamp selection, see Chapter 7, "Making Settings."

TIP

- If a change to the clamp-on current probe selection is incompatible with the conditions derived from other settings, the change is ineffective. First change other settings such as the voltage range, VT ratio, CT ratio, and wiring method, then change the probe selection.
- The current probe cannot be changed during continuous measurement.
- The current probe cannot be changed when the electric energy count is not zero, and an attempt to change causes *Err.300* to appear on the screen (this will disappear and the measurement screen will return when any key is pressed). Clear the electric energy count first. For details of how to do this, see Section 9.2.3, "Clearing Electric Energy Count," or Section 7.2.4, "Clearing Electric Energy Count and Resetting System," in Chapter 7, "Making Settings."

6.4 Changing Wiring Method Setting

● Procedure to Change Wiring Method Setting

- (1) The  sign is displayed uppermost on the screen, above the wiring method currently selected. To change the method, press the **WIRING** key when the measurement screen is displayed.

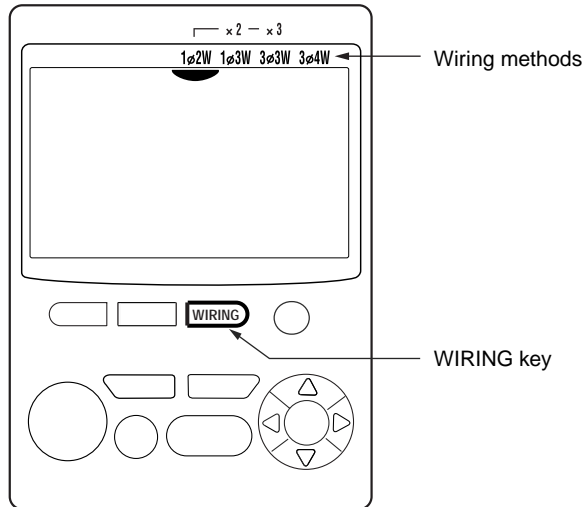

Each press of the **WIRING** key changes the wiring method selection sequentially as follows:

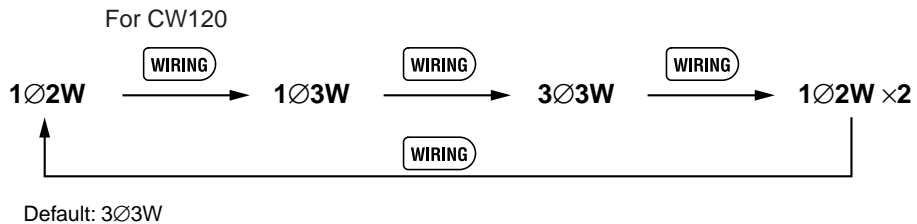

TIP

- If a change to the wiring method setting is incompatible with the conditions derived from other settings, the change is ineffective. First change other settings such as the voltage range, current range, VT ratio, and CT ratio, then change the wiring method.
- The wiring method cannot be changed during continuous measurement.
- The wiring method cannot be changed when the electric energy count is not zero. Pressing the **WIRING** key at this time causes *Err.300* to appear on the screen (this will disappear and the measurement screen will return when any key is pressed). Clear the electric energy count first. For details of how to do this, see Section 9.2.3, “Clearing Electric Energy Count,” or Section 7.2.4, “Clearing Electric Energy Count and Resetting System,” in Chapter 7, “Making Settings.”

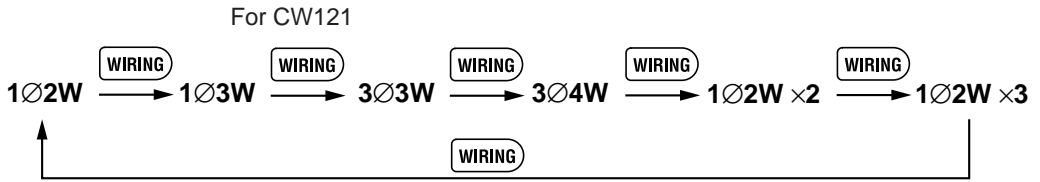

Default: 3Ø3W

SEE ALSO

For details of the wiring methods, see Chapter 5, "Wiring."

Indication of wiring method.

<1Ø2W x2>
CW120

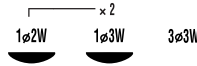

CW121

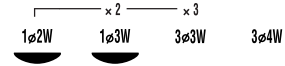

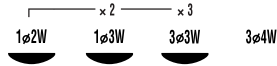

<1Ø2W x3>
CW121



7.1 Setting Items and Item Selection

● Setting Items

Before starting measurement, the following measurement condition and data saving settings should be made as necessary.

Setting Item	Display Mark
1. Device number	NO.
2. Loading and saving of settings	CONF
3. Deletion of measured-data file and formatting of PC card	FILE
4. Clearance of electric energy count and resetting of system	RESET
5. Copying and clearance of backup memory	MEM
6. Date	DATE
7. Output interval	INTER
8. Integration start date and time	START
9. Integration stop date and time	STOP
10. Data saving to PC card	
11. Communication device selection	DEV
12. Communication settings	COM
13. Communication protocol setting	<i>Proto.</i>
14. VT ratio setting	VT
15. CT ratio setting	CT
16. Clamp-on current probe selection	
17. Decimal point position and unit selections for electric energy	DIGIT

TIP

The Setting Check Sheet in the back of *Operation Guide* (IM CW120P-E) lists necessary settings and their available selections. Use this sheet for grasping the setting conditions and for efficient setting on site.

7.1 Setting Items and Item Selection

● Keys Used for Setting

The keys used for setting are described below.

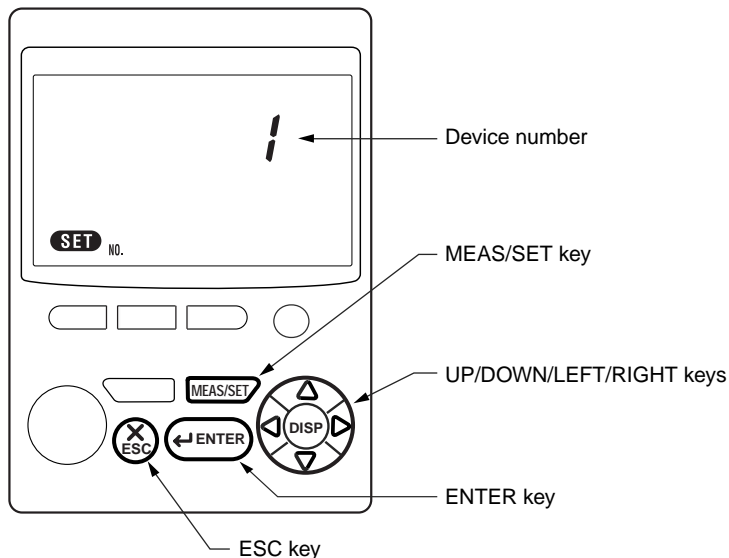

key

Used to toggle the display between measurement and setting screens. The **SET** mark is displayed on a setting screen.

key

Used to fix a selection.

key

Used to cancel a setting. Pressing this key returns to the preceding screen.

keys

Used to:

- Change the setting item displayed.
- Change a number.
- Change a setting.

keys

Used to:

- Change the setting item displayed.
- Select a digit.
- Change a setting.

● Setting Procedure

- (1) Press the **MEAS/SET** key. The display changes from the measurement screen to the screen for setting (the setting item selection screen) and the **SET** sign appears in the lower left.

Device number setting screen

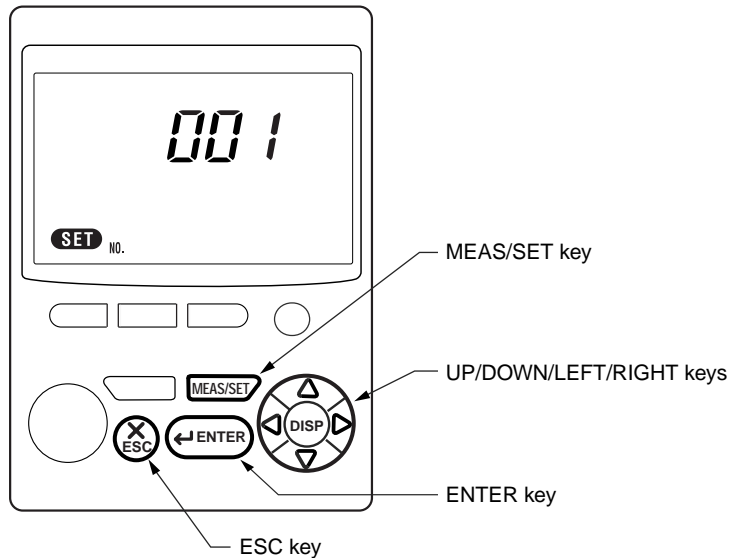

- (2) Using the \triangle ∇ \triangleleft \triangleright keys, select the desired item, and then press the **ENTER** key. Each time one of the \triangle ∇ \triangleleft \triangleright keys is pressed, the setting item changes sequentially as follows.

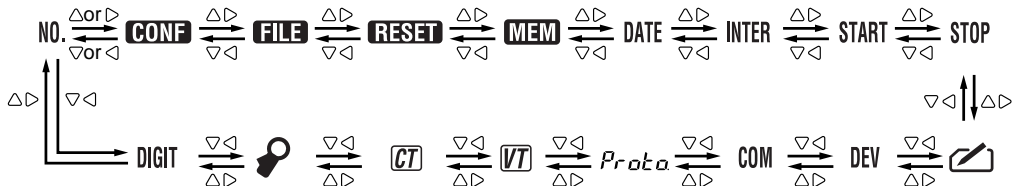

To cancel a setting after pressing the **ENTER** key, press the **ESC** key. The setting item selection screen then returns.

- (3) After making necessary changes to the settings, press the **MEAS/SET** key to return to the measurement screen.

TIP

- The MEM (backup memory setting) is skipped if no data exists in the backup memory (and the MEM mark is not lit on the measurement screen).
- The DEV (communication device) setting is skipped if your CW120/121 model has an RS-485 interface.
- The setting item that is selected by default when the screen changes from the measurement screen, is the item selected last time the measurement screen was returned from a setting screen.
- In the electric energy measurement mode, the settings can be viewed only for checking and cannot be modified.

7.2 Setting Each Item

7.2.1 Setting Device Number (NO.)

Description

The device number is used for identifying each power meter (CW120/121) when monitoring a specific power with two or more CW120s and CW121s, and also used as the device address when using RS-485 communication.

The device number consists of three digits. It is set to 001 by default and can be set to any number from 001 to 999.

TIP

When using RS232 communication, in cases when the communication protocol is other than CW120/121 exclusive, Device number is used as the Device Address.

Communication protocols and device number limits

Communication Protocol	Device number limits
CW120/121-dedicated communication	1 to 999
Power monitor (PR201) communication	1 to 31
PC link communication without checksum	1 to 99
PC link communication with checksum	1 to 99
MODBUS communication (ASCII mode)	1 to 247
MODBUS communication (RTU mode)	1 to 247

Procedure

- (1) Using the \triangle ∇ \triangleleft \triangleright keys in the setting item selection screen, make the NO. mark and its corresponding setting appear on the screen. Then, press the \leftarrow ENTER key. The rightmost digit begins flashing.

Device Number Setting Screen

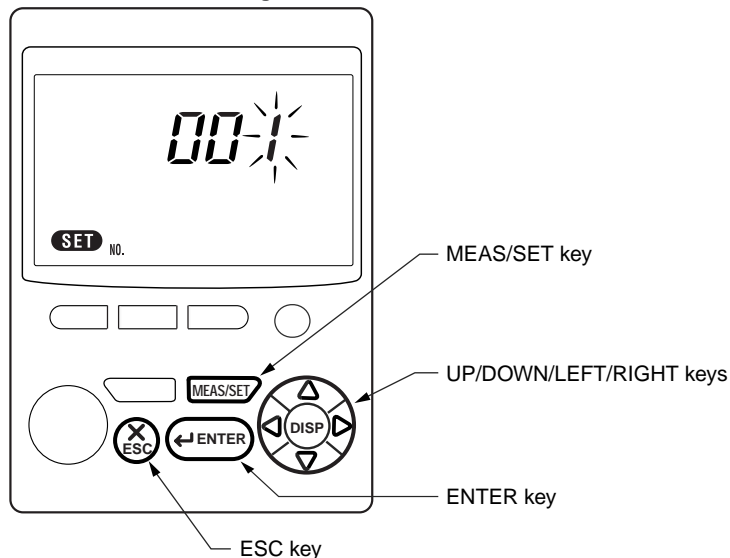

- (2) Using the ◀ ▶ keys, select the digit to be changed. The selected digit flashes.
- (3) Using the △ ▽ keys, change the number of the selected digit.
- (4) After making necessary changes, press the ◀ENTER key. The new device number is then set and the setting item selection screen returns.

To cancel the changes, press the ⓧ key. The setting item selection screen also returns.

7.2.2 Loading and Saving Settings (CONF)

Description

Select *LoAd* to load settings from a PC card.

Select *SAvE* to save settings to a PC card.

The file number consists of three digits and can be set to any number from 000 to 029.

TIP

Name of setting file: WTH nnn .SET where nnn is the file number you set, from 000 to 029

Procedure

- (1) Using the △ ▽ ◀ ▶ keys in the setting item selection screen, make the **CONF** mark to appear on the screen. Then, press the ◀ENTER key. *LoAd* begins flashing.

Loading/Saving Selection Screen

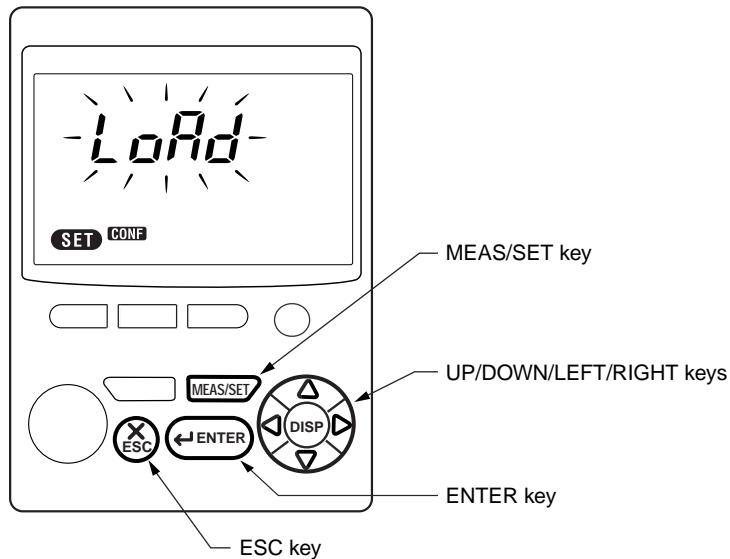

- (2) Using the ◀ ▶ keys, select *LoAd* or *SAvE*.

7.2 Setting Each Item





- (3) Press the  key to confirm the selection. A three-digit number appears on the lower row, allowing you to set the file number of the file to/from which you want to save/load settings.

To cancel loading/saving, press the  key. The setting item selection screen returns.

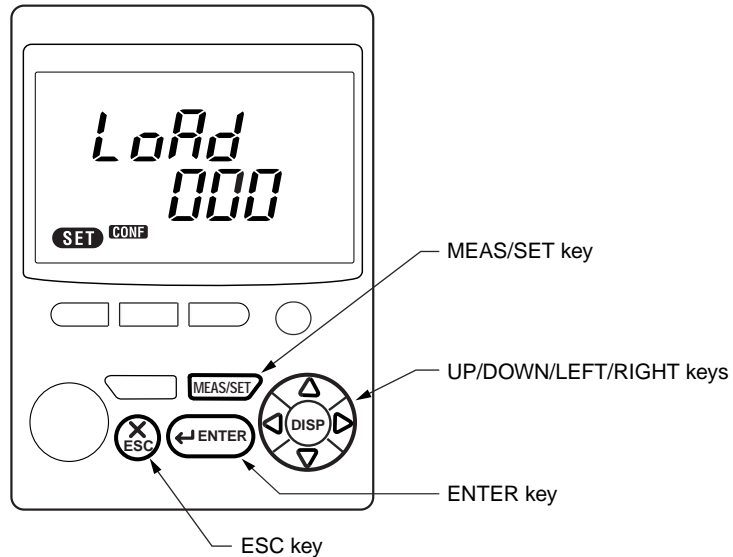
Loading

File Number Setting Screen for Loading



- (4) Specify the file number in accordance with the steps below.
- (5) Using the   keys, select the digit to be changed. The selected digit flashes.
- (6) Using the   keys, change the number of the selected digit.
- (7) After making necessary changes, press the  key. The settings are then loaded and the setting item selection screen returns.

You cannot select the file number of a file that does not exist. Selecting such a file number returns to the screen for file number setting.

To cancel loading, press the  key. The screen in step (1) returns.

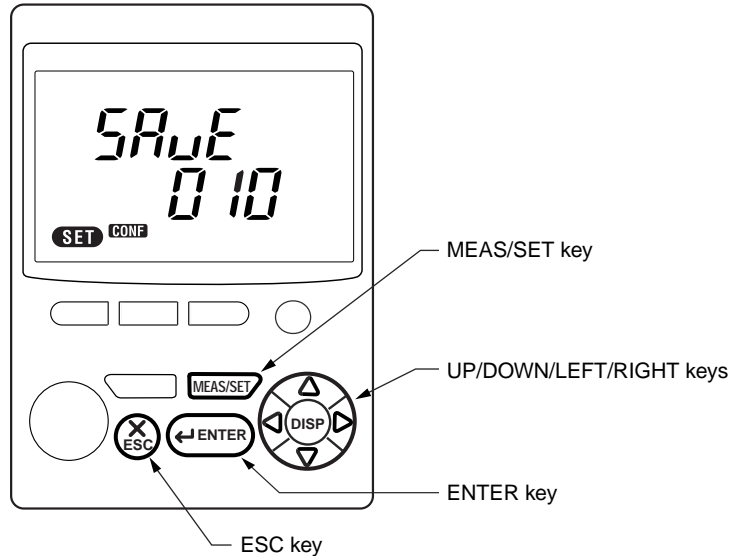
Saving**File Number Setting Screen for Saving**

- (4) Specify the file number in accordance with the steps below.
- (5) The smallest file number within the unused numbers from 000 to 029 is displayed.
- (6) If the displayed number is fine, press the **ENTER** key.
- (7) If you want to specify a different file number, using the **◀ ▶** keys, select the digit to be changed. The selected digit flashes.
- (8) Using the **△ ▽** keys, change the number of the selected digit.
- (9) After making necessary changes, press the **ENTER** key. The settings are then saved and the setting item selection screen returns.
You cannot select a file number that has already been used. Selecting such a file number returns to the screen for file number setting.
To cancel saving, press the **ESC** key. The screen in step (1) returns.

NOTE

- When the number of setting files residing in the inserted PC card has reached 30, you can no longer save the settings. Attempting to save settings causes *Err. 103* to appear (this will disappear and the previous screen will return when any key is pressed). Delete an unnecessary file or files and try saving again.
- The loading cannot be performed when the electric energy count and the integration time are not zero. Attempting to load settings causes *Err. 300* to appear on the screen (this will disappear and the measurement screen will return when any key is pressed). Clear the electric energy count first. For details of how to do this, see Section 9.2.3, "Clearing Electric Energy Count," or Section 7.2.4, "Clearing Electric Energy Count and Resetting System," in this chapter.

TIP

- When the PC card is full, the **FULL** sign is displayed on the screen and the saving cannot be performed.
- Saving the settings when the communication device is set to a printer, prints the settings at the same time.

7.2.3 Deleting Measured-data Files and Formatting PC Card (**FILE**)

Description

Select *dEL ALL* to delete all the measured data saved in the PC card.
 Select *In It.* to format the PC card.

Procedure

- Using the \triangle ∇ \triangleleft \triangleright keys in the setting item selection screen, make the **FILE** mark to appear on the screen. Then, press the \leftarrow ENTER key. *dEL ALL* begins flashing.

Measured-data Deletion Screen

PC Card Formatting Screen

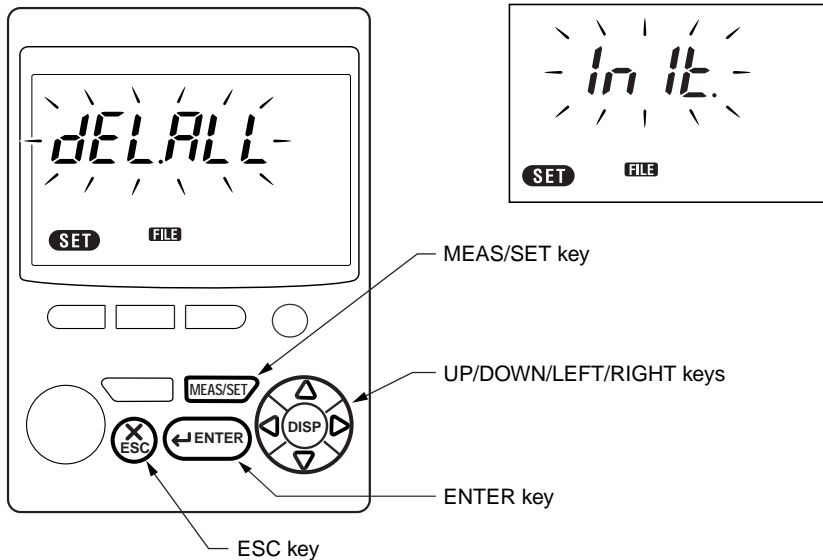

- Using the \triangle ∇ \triangleleft \triangleright keys, select *dEL ALL* if you want to delete the measured data or *In It.* if you want to format the PC card.
- Press the \leftarrow ENTER key. The selected action takes place and the setting item selection screen returns.
 To cancel the data deletion or formatting, press the \otimes key. The setting item selection screen also returns.

7.2.4 Clearing Electric Energy Count and Resetting System (**RESET**)

Description

Select *IntEG.* to clear the electric energy count (watt-hours).

Select *SYSt.* to reset the system.

Clearing the electric energy count means to reset all of the electric energy count, elapsed time of integration, and regenerative energy count to zeros.

Resetting the system means to perform the same actions as clearing the electric energy count and initialize the settings to the defaults, except for the date, time, and device number.

Procedure

- Using the \triangle ∇ \triangleleft \triangleright keys in the setting item selection screen, make the **RESET** mark to appear on the screen. Then, press the \leftarrow ENTER key. *IntEG.* begins flashing.

Electric Energy Count Clearance Screen

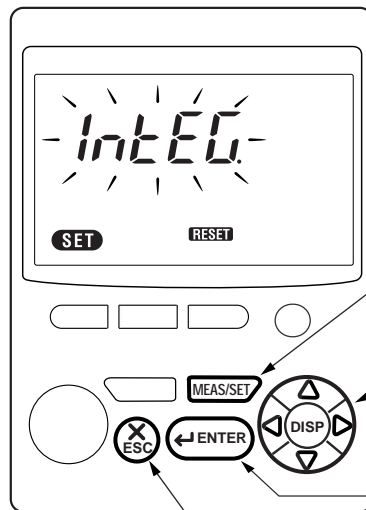

System Resetting Screen



MEAS/SET key

UP/DOWN/LEFT/RIGHT keys

ENTER key

ESC key

- Using the \triangle ∇ \triangleleft \triangleright keys, select *IntEG.* if you want to clear the electric energy count or *SYSt.* if you want to reset the system.

- Press the \leftarrow ENTER key. The selected action takes place and the setting item selection screen returns.

To cancel clearing the electric energy count or resetting the system, press the \odot key. The setting item selection screen also returns.

NOTE

The electric energy count can also be cleared by simply pressing the \odot key for three seconds or more in the measurement screen. For this, see Section 9.2.3, "Clearing Electric Energy Count."

7.2.5 Copying and Clearing Backup Memory Contents (MEM)

Description

The CW120/121 have a memory for backing up the PC card. When the PC card becomes full or is removed, data is saved to the backup memory. For details, see Section 9.5, "Backup Memory."

When no data resides in the backup memory, namely, when the **MEM** mark is not displayed on the measurement screen, this setting item cannot be called.

Select *DATA COPY* to copy the data in the backup memory to the PC card. Select *DATA DEL.* to delete the data from the backup memory.

Procedure

- Using the \triangle ∇ \triangleleft \triangleright keys in the setting item selection screen, make the **MEM** mark to appear on the screen. Then, press the \leftarrow ENTER key. *DATA COPY* appears and *COPY* flashes.

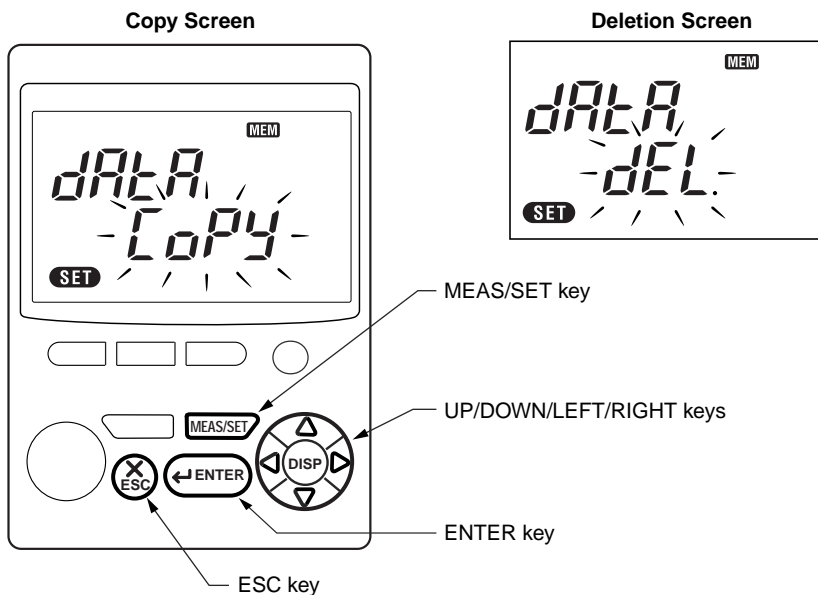

- Using the \triangle ∇ \triangleleft \triangleright keys, select *COPY* if you want to copy the data in the backup memory to the PC card or *DEL.* if you want to delete the data from the backup memory.
- Press the \leftarrow ENTER key. The selected action takes place and the setting item selection screen returns.
To cancel copying or deleting data, press the \otimes key. The setting item selection screen also returns.

7.2.6 Changing Date and Time (DATE)

Description

The CW120/121 have a clock, which is adjusted to the Japan standard time by default (factory setting). To change the date and time, follow the procedure below.

Procedure

- Using the \triangle ∇ \triangleleft \triangleright keys in the setting item selection screen, make the **DATE** mark and the current data and time settings appear on the screen. Then, press the \leftarrow ENTER key. The day indication flashes.

Date and Time Change Screen

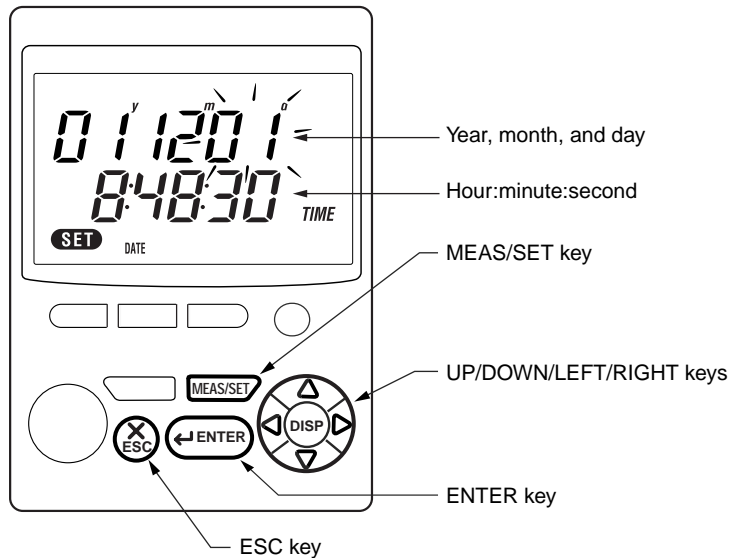

- Using the \triangleleft \triangleright keys, select an item — year, month, day, hour, minute, or second — you want to change. The selected item flashes.
- Using the \triangle ∇ keys, change the value of the selected item. When changing a number, pressing the \triangle ∇ key continuously will make quick changes.
- After making all necessary changes, press the \leftarrow ENTER key. The date and time settings are changed and the setting item selection screen returns. To cancel the changes, press the \otimes key. The setting item selection screen also returns.

TIP

- For the year, set the last two digits. The range of the year setting is 00 to 99 (years 2000 to 2099).
- To make the changes effective, press the \leftarrow ENTER key synchronously with a time signal from a TV broadcast or the like.

7.2 Setting Each Item

7.2.7 Setting Output Interval (INTER)

Description

When saving (outputting) data in the electric energy measurement mode, the interval of saving (outputting) data needs to be set. This output interval is set to 30 minutes by default and can be selected from:

- 1, 2, 5, 10, 15, and 30 seconds,
- 1, 2, 5, 10, 15, and 30 minutes, and
- 1 hour.

Procedure

- (1) Using the \triangle ∇ \triangleleft \triangleright keys in the setting item selection screen, make the **INTER** mark and the current interval setting appear on the screen. Then, press the \rightarrow ENTER key. The current setting flashes.

Output Interval Setting Screen

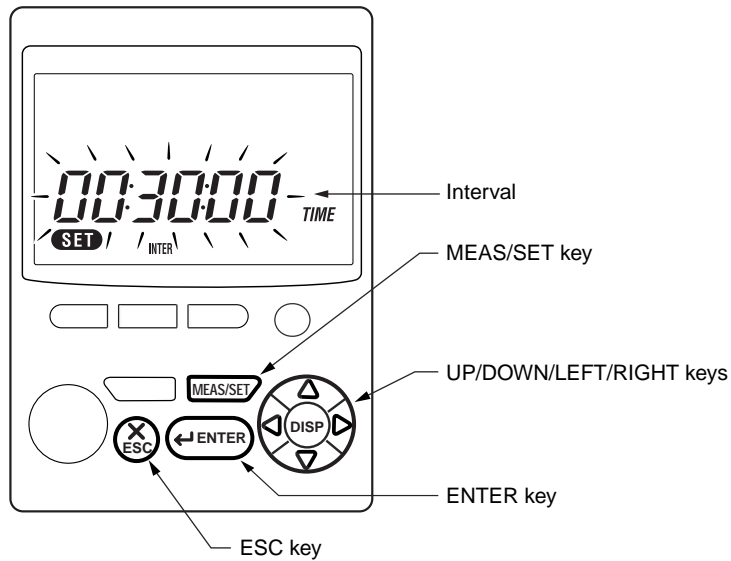

(2) Using the \triangle ∇ \triangleleft \triangleright keys, select the desired interval. The displayed interval time changes sequentially as follows.

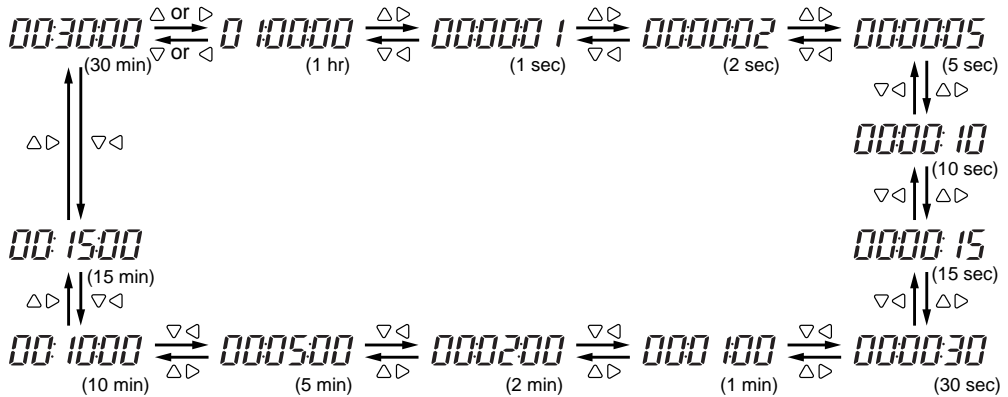

(3) After selecting the desired interval, press the \leftarrow ENTER key. The interval is changed accordingly and the setting item selection screen returns.

To cancel the change, press the ESC key. The setting item selection screen also returns.

NOTE

When setting the output interval to 2 minutes or less, note the following.

- Depending on the number of files residing in the PC card and the free space in it, the data at the beginning may not be saved (for example, after approximately fifty-thousand samples have been saved at one-second intervals). If this occurs, *Err201* appears on the screen and data saving is stopped.
- Especially when setting the interval to 1 second, make sure that:
 - There is no file in the PC card (format the PC card to delete all files).
 - The PC card is inserted when starting the integration.
 - Do not remove the PC card during electric energy measurement.
 - Do not activate communication.
 - Do not perform excessive key actions.

Only if data saving to the PC card is enabled (see Section 7.2.10), data is saved to the PC card at the specified interval.

7.2.8 Setting Integration Start Date and Time (START)





Description

There are three ways to start integration:

- Automatic starting at the specified time on the specified date
- Manual starting by pressing the  key for one second or more
- Remote starting by inputting a signal at the external control terminals





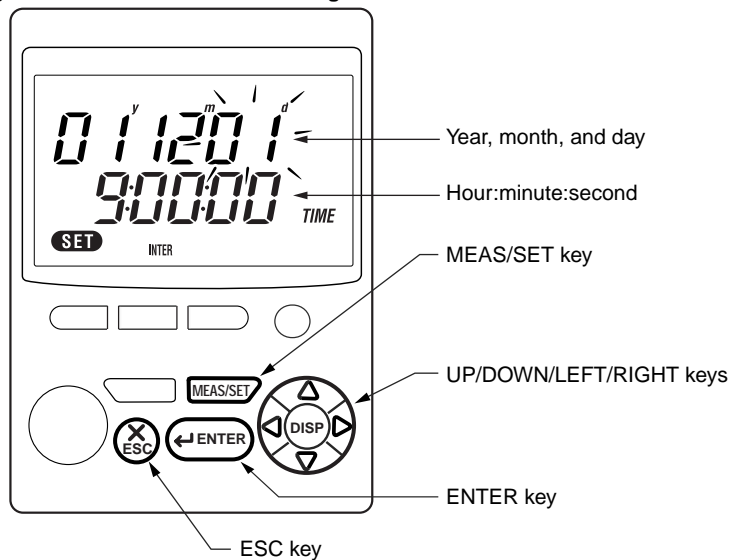

The following describes the start date and time setting for the first way.

Procedure

- (1) Using the     keys in the setting item selection screen, make the **START** mark and the current settings of the start date and time appear on the screen. Then, press the  key. The day setting flashes.

Integration Start Date and Time Change Screen



- (2) Using the   keys, select an item — year, month, day, hour, minute, or second — you want to change where the year, month, and day are shown with superscripts **y**, **m**, and **d** to avoid confusion. The selected item flashes.
- (3) Using the   keys, change the value of the selected item. When changing a number, pressing the   key continuously will make quick changes.

(4) After making all necessary changes, press the  key. The start date and time settings are changed and the setting item selection screen returns.

To cancel the changes, press the  key. The setting item selection screen also returns.

 **NOTE**

Set a valid date and time.

- If the start date and time are set to before the current time, or if the specified start date and time has passed before a start after setting, integration will start at the appropriate time determined by the output interval.
 - If the start date and time are set to the same as the stop date and time or to later than the stop date and time, the stop date and time are automatically set to the point after the output interval from the start date and time.
 - Resetting the system changes the integration start date and time to the current time.
-

TIP

For the year, set the last two digits. The range of the year setting is 00 to 99 (years 2000 to 2099).

SEE ALSO

For details of the start and stop of integration, see Section 9.2, "Starting and Stopping Integration."

7.2.9 Setting Integration Stop Date and Time (STOP)





Description

There are three ways to stop integration:

- Automatic stopping at the specified time on the specified date
- Manual stopping by pressing the  key for one second or more
- Remote stopping by inputting a signal at the external control terminals







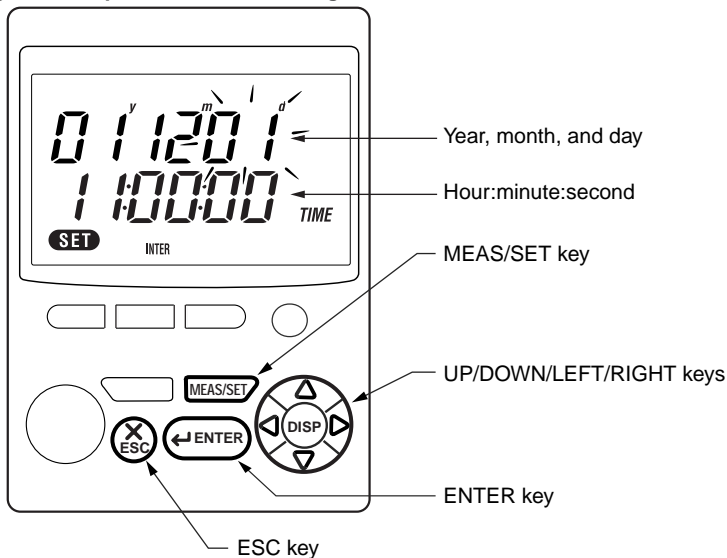

The following describes the stop date and time setting for the first way.

Procedure

- (1) Using the     keys in the setting item selection screen, make the **STOP** mark and the current settings of the stop date and time appear on the screen. Then, press the  key. The day setting flashes.

Integration Stop Date and Time Change Screen



- (2) Using the   keys, select an item — year, month, day, hour, minute, or second — you want to change where the year, month, and day are shown with superscripts **y**, **m**, and **d** to avoid confusion. The selected item flashes.
- (3) Using the   keys, change the value of the selected item. When changing a number, pressing the   key continuously will make quick changes.
- (4) After making all necessary changes, press the  key. The stop date and time settings are changed and the setting item selection screen returns.
To cancel the changes, press the  key. The setting item selection screen also returns.

 **NOTE**

Set a valid date and time.

- You cannot set the stop date and time to the same time or before the start date and time.
 - Resetting the system changes the integration stop date and time to 30 minutes after the current time (since the output interval is initialized to the default, 30 minutes).
-

TIP

For the year, set the last two digits. The range of the year setting is 00 to 99 (years 2000 to 2099).

SEE ALSO

For details of the start and stop of integration, see Section 9.2, "Starting and Stopping Integration."

7.2.10 Enabling/Disabling Data Saving to PC Card (📄)

Description

This determines whether to save the measured data during electric energy measurement to the PC card.

Select *rECLon* to enable (switch on) saving.

Select *rECLoFF* to disable (switch off) saving.

By default, the saving is enabled (switched on).

Procedure

- (1) Using the \triangle ∇ \triangleleft \triangleright keys in the setting item selection screen, make the 📄 mark and the current on/off setting appear on the screen. Then, press the \leftarrow ENTER key. The setting flashes.

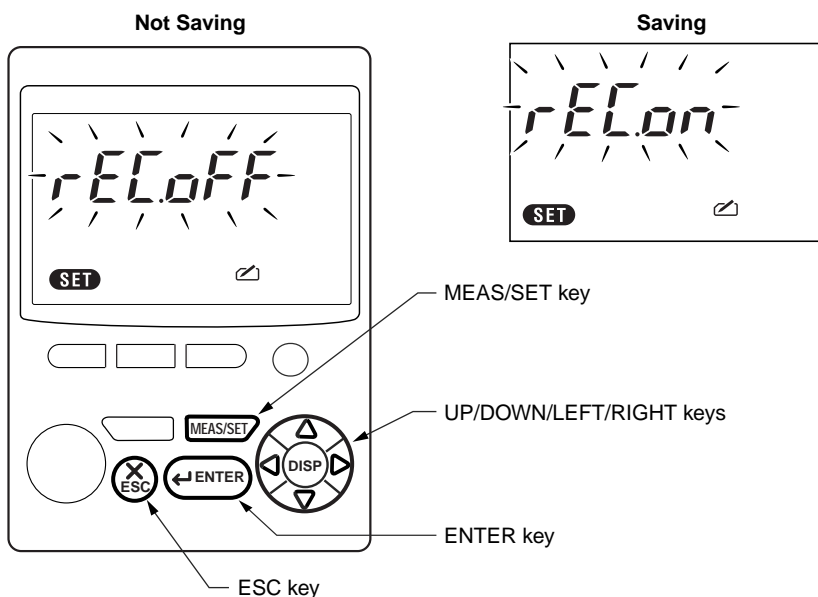

- (2) Using the \triangle ∇ \triangleleft \triangleright keys, select *rECLon* if you want to enable saving or *rECLoFF* if you want to disable saving.
- (3) After making a change, press the \leftarrow ENTER key. The change is made effective and the setting item selection screen returns. To cancel the change, press the \otimes key. The setting item selection screen also returns.

NOTE

- When the saving is enabled (on), data is saved to the PC card in the output interval set (in Section 7.2 7).
- When the saving is enabled (on), the 📄 mark is displayed also in the measurement screen.

7.2.11 Selecting Communication Device (DEV)

Description

For RS-232 communication, you can select the device to connect to.

Select *PC* to connect to a personal computer.

Select *Prn* to connect to a printer.

By default, connection to a personal computer is selected.

For RS-485 communication, only connection to a personal computer is allowed, so this setting cannot be made.

Procedure

- Using the \triangle ∇ \triangleleft \triangleright keys in the setting item selection screen, make the **DEV** mark and the current device selection appear on the screen. Then, press the \leftarrow ENTER key. The selection flashes.

Selecting a Personal Computer

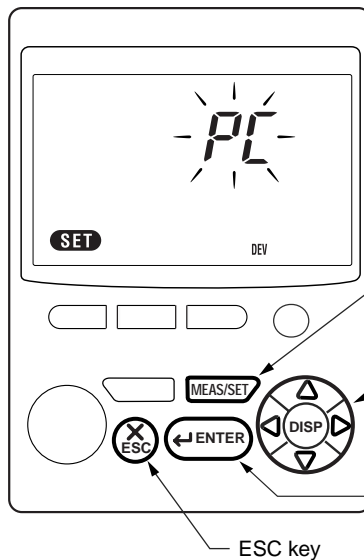

Selecting a Printer

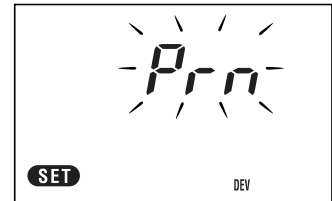

MEAS/SET key

UP/DOWN/LEFT/RIGHT keys

ENTER key

ESC key

- Using the \triangle ∇ \triangleleft \triangleright keys, select *PC* if you want to connect to a personal computer or *Prn* if you want to connect to a printer.
- After making a change, press the \leftarrow ENTER key. The change is made effective and the setting item selection screen returns.
To cancel the change, press the \otimes key. The setting item selection screen also returns.

NOTE

 when a personal computer is selected, or  when a printer is selected, flashes during access to the corresponding device.

SEE ALSO

For the computer connection, see Chapter 11, "Communication Functions."

For the printer connection, see Section 12.2, "Using Optional Printer."

7.2.12 Making Communication Settings (COM)

Description

Follow the procedure below to set the baud rate, data bits, parity bit, and stop bits to match the specifications of the device to connect to.

- Baud rate: 1200, 2400, 4800, 9600, 19200 or 38400 bps (9600 bps by default)
- Data bits: 7 or 8 (8 bits by default)
- Parity: n for no parity (default)
 E for even parity
 O for odd parity
- Stop bits: 1 or 2 (1 bit by default)

Procedure





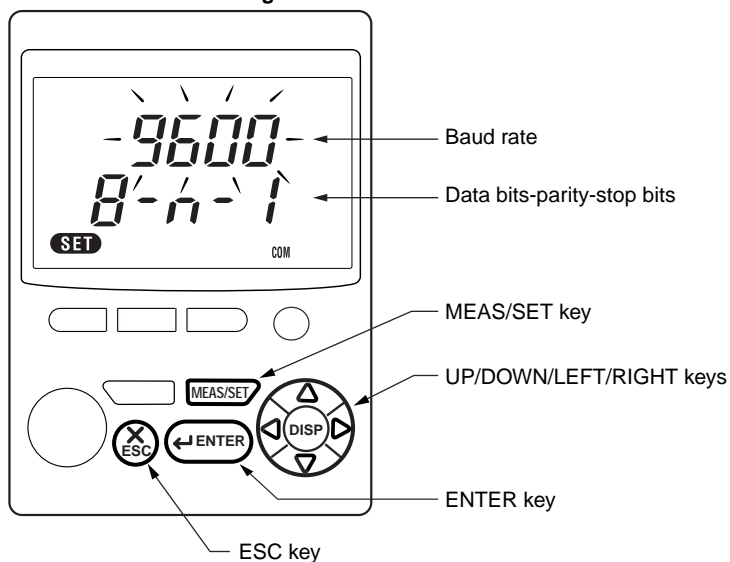



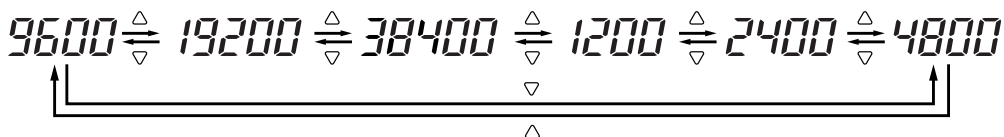

- (1) Using the \triangle ∇ \triangleleft \triangleright keys in the setting item selection screen, make the **COM** mark and the current communication settings appear on the screen. Then, press the \leftarrow ENTER key. The baud rate setting flashes.

Communication Setting Screen



- (2) If necessary, change the baud rate using the \triangle ∇ keys. The baud rate changes sequentially as follows.



- (3) Press the  key to move to the data bit setting. The leftmost number in the lower row flashes. If necessary, change the data bit setting using the   keys.
- (4) Press the  key to move to the parity bit setting. The middle number in the lower row flashes. If necessary, change the parity bit setting using the   keys.
- (5) Press the  key to move to the stop bit setting. The rightmost number in the lower row flashes. If necessary, change the stop bit setting using the   keys.
- (6) After making all necessary changes, press the  key. The settings are changed accordingly and the setting item selection screen returns. To cancel the changes, press the  key. The setting item selection screen also returns.

TIP

- You can move between the baud rate, data bit, parity bit, and stop bit settings from one to another in the reverse direction by using the  key.
- Resetting the system using a command via communication leaves the baud rate, data bit, parity bit, and stop bit settings unchanged.

7.2.13 Setting Communication Protocol (Proto)

Description

CW120/121 can configure the following 6 communication protocols.

Communication Protocols

Communication Protocol		Explanation
CW120/121-dedicated communication	<i>orUPro</i>	CW120/121-dedicated communication standard
Power monitor (PR201) communication	<i>Pr201</i>	Communication standard used for power monitor
PC link communication without sum check	<i>PC5off</i>	Without error check
PC link communication with sum check	<i>PC5on</i>	With error check
MODBUS communication (ASCII mode)	<i>modASC</i>	Communication using ASCII data
MODBUS communication (RTC mode)	<i>modrtU</i>	Communication using Binary data

Default: CW120/121-dedicated communication

Procedure

- Using the Δ ∇ \triangleleft \triangleright keys in the setting item selection screen, make the *Proto.* and the existing communication protocol setting appear on the screen. Then, press the \leftarrow ENTER key.

The communication protocol setting flashes.

Communication Protocol Setting Screen

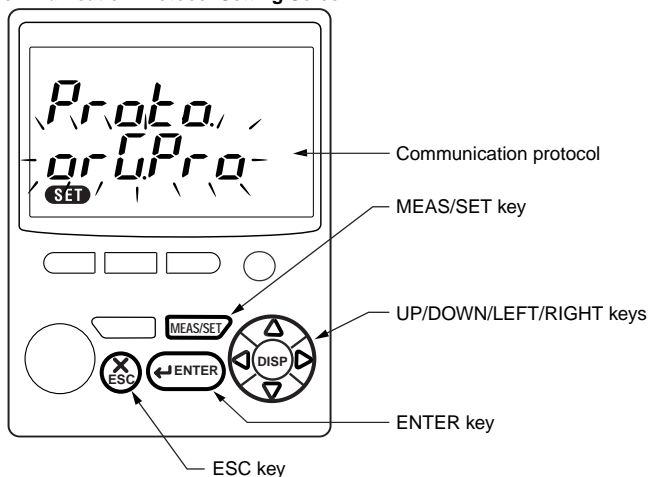

- Using the Δ ∇ \triangleleft \triangleright keys, select the communication protocol. The displayed communication protocol changes sequentially as follows.

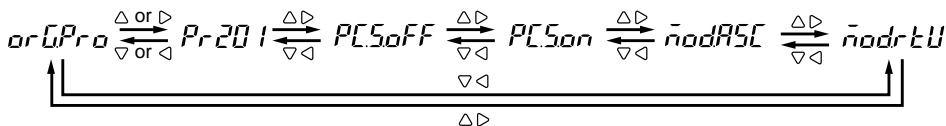

- After selecting the communication protocol, press the \leftarrow ENTER key. The communication protocol is changed accordingly and the setting item selection screen returns.

To cancel the change, press the X ESC key, The setting item selection screen also returns.

SEE ALSO

For details of the communication function, see the CW120/121 CLAMP-ON POWER METERS Communication Functions user's manual (IM CW120C-E).

7.2.14 Setting VT Ratio (VT)

Description

When installing an external voltage transformer (VT) and inputting the secondary-circuit output of the VT to the CW120/121, setting the VT ratio appropriately will display the reading correctly in the scale of the primary circuit, namely, will perform scaling.

The VT ratio can be set from 1 to 10000 and is set to 1 by default.

When not using a VT, set the VT ratio to 1.

Whenever the VT ratio is set to a value other than 1, the **VT** mark is displayed even in the measurement mode.

Procedure

- Using the \triangle ∇ \triangleleft \triangleright keys in the setting item selection screen, make the **VT** mark and the existing VT ratio setting appear on the screen. Then, press the **ENTER** key. The digit of the one place flashes.

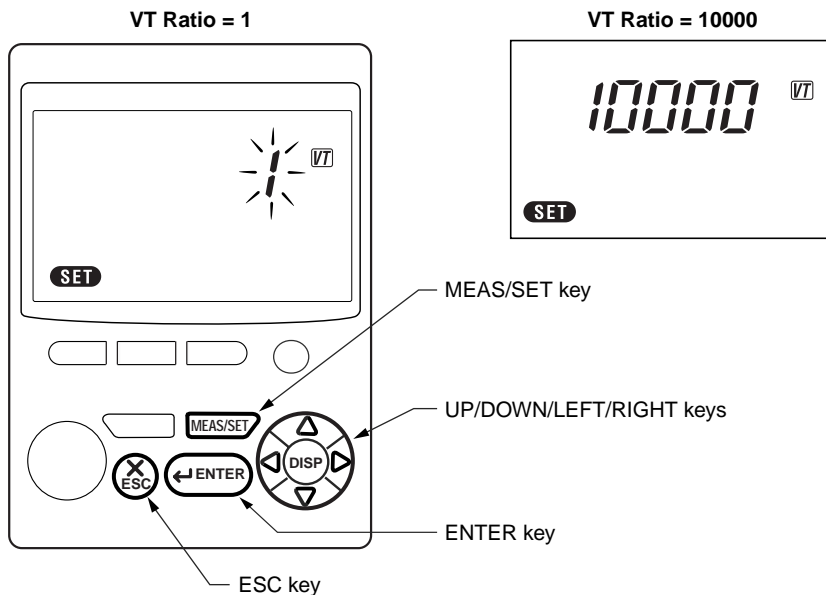

- Using the \triangleleft \triangleright keys, select the digit to be changed. The selected digit flashes.

- Using the \triangle ∇ keys, change the number.

- After making necessary changes, press the **ENTER** key. The VT ratio setting is changed accordingly and the setting item selection screen returns.

To cancel the changes, press the **ESC** key. The setting item selection screen also returns.

7.2 Setting Each Item

NOTE

- The VT ratio cannot be changed when the electric energy count or the elapsed time of integration is not zero. Attempting to change the ratio causes $Err.300$ to appear on the screen (this will disappear and the measurement screen will return when any key is pressed). Clear the electric energy count first. For details of how to do this, see Section 9.2.3, “Clearing Electric Energy Count,” or Section 7.2.4, “Clearing Electric Energy Count and Resetting System,” in this chapter.
 - A setting that causes the product of [VT ratio \times CT ratio \times rated power \times 1.3] to exceed 9999 GW is not allowed.
-
-

TIP

Example of VT ratio setting:

When using a 2200-to-110 V transformer, the transformer ratio is 20:1. So, set the VT ratio to 20.

Displayed values:

Range of voltage reading: Voltage range \times VT ratio

Range of current reading: Current range \times CT ratio

Range of power reading: Rated power \times VT ratio \times CT ratio

7.2.15 Setting CT Ratio (CT)

Description

When installing an external current transformer (CT) and inputting the secondary-circuit output of the CT to the CW120/121, setting the CT ratio appropriately will display the reading correctly in the scale of the primary circuit, namely, will perform scaling.

The CT ratio can be set from 1.00 to 10000.0 and is set to 1.00 by default.

When not using a CT, set the CT ratio to 1.00.

Whenever the CT ratio is set to a value other than 1.00, the **CT** mark is displayed even in the measurement mode.

Procedure

- (1) Using the \triangle ∇ \triangleleft \triangleright keys in the setting item selection screen, make the **CT** mark and the existing CT ratio setting appear on the screen. Then, press the **ENTER** key. The digit of the one place flashes.

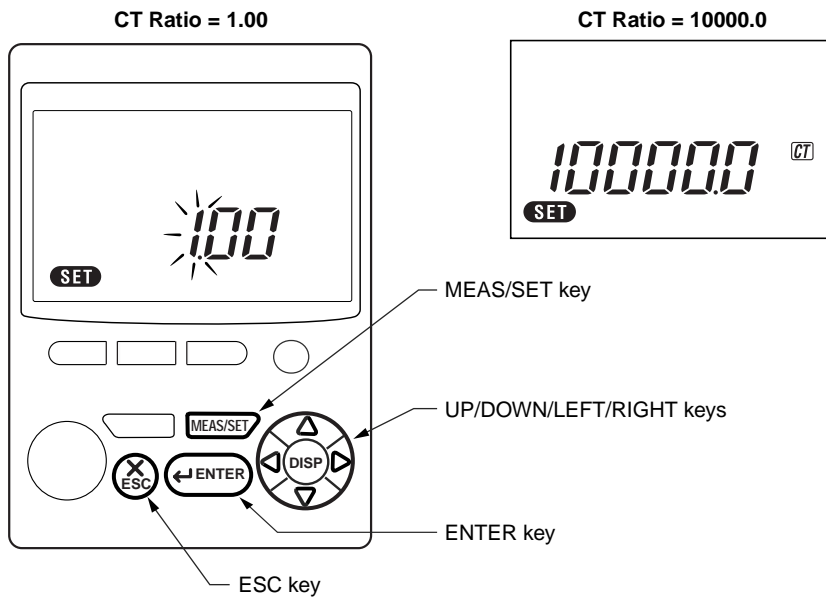

- (2) Using the \triangleleft \triangleright keys, select the digit to be changed. The selected digit flashes.

- (3) Using the \triangle ∇ keys, change the number.

- (4) After making necessary changes, press the **ENTER** key. The CT ratio setting is changed accordingly and the setting item selection screen returns.

To cancel the changes, press the **ESC** key. The setting item selection screen also returns.

7.2 Setting Each Item



NOTE

- The CT ratio cannot be changed when the electric energy count or the elapsed time of integration is not zero. Attempting to change the ratio causes $Err.300$ to appear on the screen (this will disappear and the measurement screen will return when any key is pressed). Clear the electric energy count first. For details of how to do this, see Section 9.2.3, “Clearing Electric Energy Count,” or Section 7.2.4, “Clearing Electric Energy Count and Resetting System,” in this chapter.
 - A setting that causes the product of $[VT \text{ ratio} \times CT \text{ ratio} \times \text{rated power} \times 1.3]$ to exceed 9999 GW is not allowed.
-

TIP

Example of CT ratio setting:

When using a 100-to-5 A transformer, the transformer ratio is 20:1. So, set the CT ratio to 20.

Displayed values:

Range of voltage reading: Voltage range \times VT ratio

Range of current reading: Current range \times CT ratio

Range of power reading: Rated power \times VT ratio \times CT ratio

7.2.16 Selecting Clamp-on Current Probe to Be Used (🔒)

Description

The following four models of clamp-on current probes can be connected to the CW120/121.

Selectable Clamp-on Current Probes

Clamp-on Current Probe Model	Setting	Rating (Ranges)
96033	50 A	5/10/20/50 A
96030	200 A	2/50/100/200 A
96031	500 A	50/100/200/500 A
96032	1000 A	200/500/1000 A

Default: 200 A

Procedure

- (1) Using the \triangle ∇ \triangleleft \triangleright keys, make the 🔒 mark (in the lower right) and its current setting appear on the screen. Then, press the \leftarrow ENTER key. The number representing the currently selected clamp model flashes.

Selecting Clamp-on Current Probe to Be Used

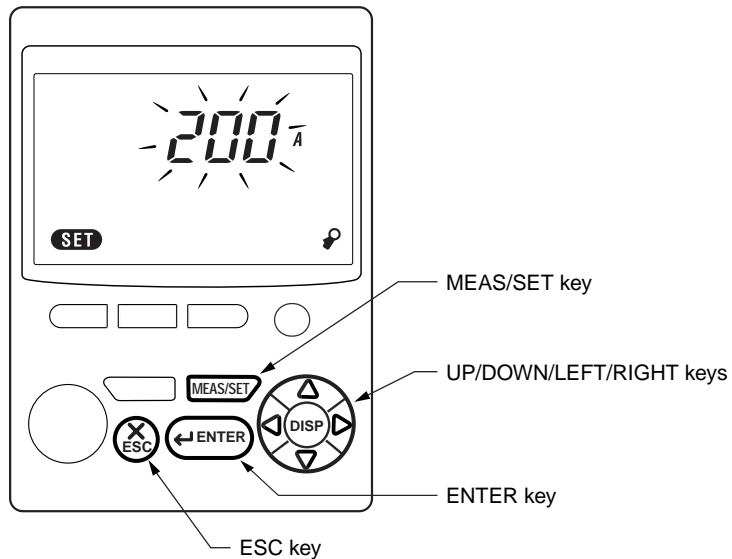

- (2) Using the \triangle ∇ \triangleleft \triangleright keys, select the number corresponding to the desired clamp-on current probe. The number changes sequentially as follows.

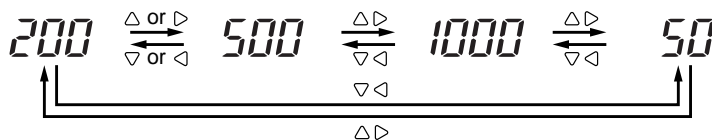

7.2 Setting Each Item

(3) After selecting the desired number, press the  key. The probe selection is changed accordingly and the setting item selection screen returns.

To cancel the change, press the  key. The setting item selection screen also returns.



NOTE

The clamp-on current probe selection cannot be changed when the electric energy count or the integration time is not zero. Attempting to change the selection causes *Err.300* to appear on the screen (this will disappear and the measurement screen will return when any key is pressed). Clear the electric energy count first. For details of how to do this, see Section 9.2.3, “Clearing Electric Energy Count,” or Section 7.2.4, “Clearing Electric Energy Count and Resetting System,” in this chapter.

TIP

A maximum of three clamp-on current probes may be connected though it varies with the wiring method; probes having different ratings cannot be used at the same time. Namely, the clamp-on probes used at the same time must be of the same model.

7.2.17 Setting Decimal Point Position and Unit of Electric Energy (DIGIT)

Description

You can set the decimal point position and unit of the electric energy readings.

Select *Std* (default) when using the standard settings. Selecting the standard setting lets the CW120/121 power meter determine the decimal point position and unit based on the product of [rated power × VT ratio × CT ratio × 1.3] as follows.

Rated Power × VT Ratio × CT Ratio × 1.3	Decimal Point Position and Unit
1 to 9.999 W	0.00 to 9999.99 Wh
10 to 99.99 W	0.0 to 99999.9 Wh
100 to 999.9 W	0.000 to 999.999 kWh
1 to 9.999 kW	0.00 to 9999.99 kWh
10 to 99.99 kW	0.0 to 99999.9 kWh
100 to 999.9 kW	0.000 to 999.999 MWh
1 to 9.999 MW	0.00 to 9999.99 MWh
10 to 99.99 MW	0.0 to 99999.9 MWh
100 to 999.9 MW	0.000 to 999.999 GWh
1 to 9.999 GW	0.00 to 9999.99 GWh
10 to 99.99 GW	0.0 to 99999.9 GWh
100 to 999.9 GW	0 to 999999 GWh

When specifying the desired decimal point position and unit, select:

- Decimal position setting from 000.000, 0000.00, 00000.0, and 000000.
- Unit from Wh, kWh, MWh, and GWh.

Procedure

- (1) Using the \triangle ∇ \triangleleft \triangleright keys, make the **DIGIT** mark and its current settings appear on the screen. Then, press the \leftarrow ENTER key. *Std* or the number representing the currently set decimal point position flashes.

When Setting Neither Decimal Point Position Nor Unit Specifically

When Using Standard Settings

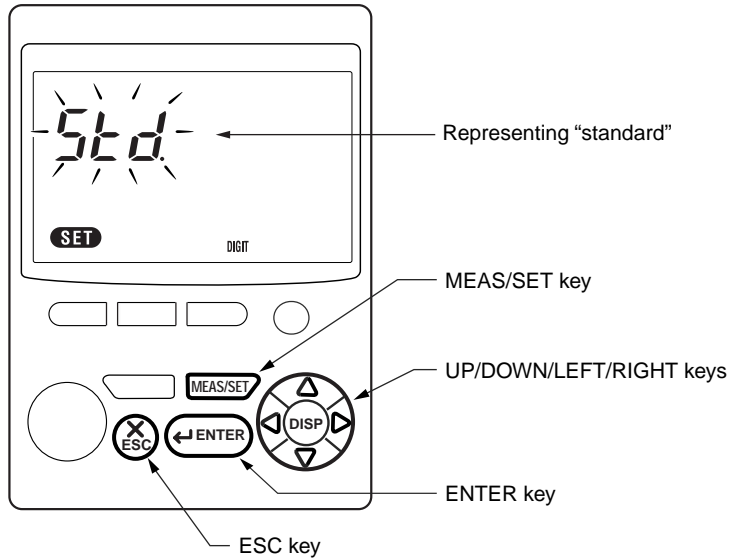

- (1) Using the \triangle ∇ \triangleleft \triangleright keys, select *Std.*
- (2) Then, press the \leftarrow ENTER key. The settings are changed accordingly and the setting item selection screen returns.
To cancel the change, press the \otimes ESC key. The setting item selection screen also returns.

7.2 Setting Each Item

When Setting Unit Specifically

- (1) After finishing changing the decimal point position setting, the unit setting starts flashing to allow you to change it.

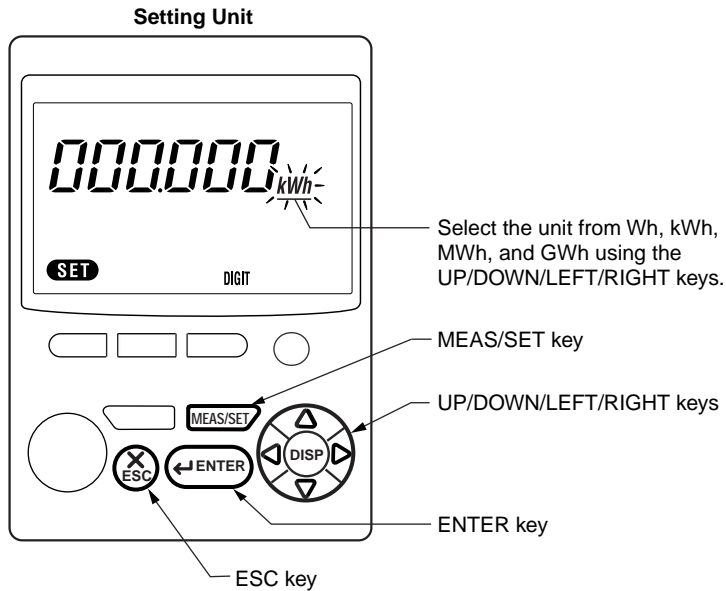

- (2) Using the \triangle ∇ \triangleleft \triangleright keys, change the unit.

- (3) Then, press the \leftarrow ENTER key. The setting is changed accordingly and the setting item selection screen returns.

To cancel the change, press the \otimes ESC key. The setting item selection screen also returns.

7.3 Setting Name of Measured-data File

When saving the measured data in the electric energy measurement mode, you can set the name of the file to which measured data is to be saved.

File name = xxxxxxxx.CSV

Name (xxxxxxx): Eight or less characters

Filename extension: Always CSV

Command: INTEgrate:STORe:FILEName *Filename*

When the file name is set, the set file name is displayed on the power meter's screen (called by pressing the  key) as shown below.

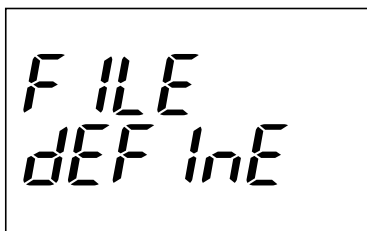

NOTE

- Once the file name is set, it remains the same even though integration is repeatedly performed, namely, the measured data will be added to the same file.
- To reset the file name setting, reset the system or set the file name to "".
- If the file name is not set, it will be assigned automatically.

SEE ALSO

For details of communication, see Chapter 11, "Communication Functions" and Chapter 12, "Communication Commands."

8.1 Measuring Instantaneous Values

The CW120/121 power meters have two modes for measurement:

1. **Instantaneous value measurement:** Measures the rms voltages and rms current of individual phases, and power, reactive power, power factor, and frequency.
2. **Electric energy measurement:** In addition to the values in the instantaneous value measurement mode, measures the electric energy. Measurement is performed continuously and integration is started and stopped by using the  keys.

This section describes instantaneous value measurement.

● Displayed Data

Item	Unit	Displayed Name
Rms voltage	V	V1, V2, V3 (differs depending on the wiring method).
Rms current	A	A1, A2, A3 (differs depending on the wiring method).
Active power	W	W, W1, W2, W3 (differs depending on the wiring method).
Reactive power	Var	Var, Var1, Var2, Var3 (differs depending on the wiring method).
Power factor	—	PF, PF1, PF2, PF3
Frequency	Hz	Hz (input frequency of V1)
Active electric energy (watt-hours)	Wh	Wh, Wh1, Wh2, Wh3
Elapsed time of integration	Hour: minute:second	00:00:00TIME
	Hour: minute	0000:00TIME
	Hour	00000hTIME

The display format changes over between the above automatically depending on the elapsed time.

● Measurement Procedure

1. Perform safety checks
with reference to Chapter 3, “Precautions for Safe Measurement.”
2. Turn on the power to CW120/121
with reference to Chapter 4, “Connecting Power Supply and Turning Power On/Off.”
3. Perform wiring
with reference to Chapter 5, “Wiring.”
4. Set the ranges and wiring method
with reference to Chapter 6, “Setting Ranges and Wiring Method.”
5. Set measurement conditions
with reference to Chapter 7, “Making Settings.”
6. **Measure instantaneous values.**

8.2 Switching Display Contents

Pressing one of the UP/DOWN/LEFT/RIGHT keys changes the display contents in order. The sequence differs depending on the wiring method set. For example, the sequence when the single-phase two-wire method is chosen is shown below. Even for the unseen data items, the respective calculations are performed internally.

Sequence of Display Contents Switching for Single-phase Two Wires

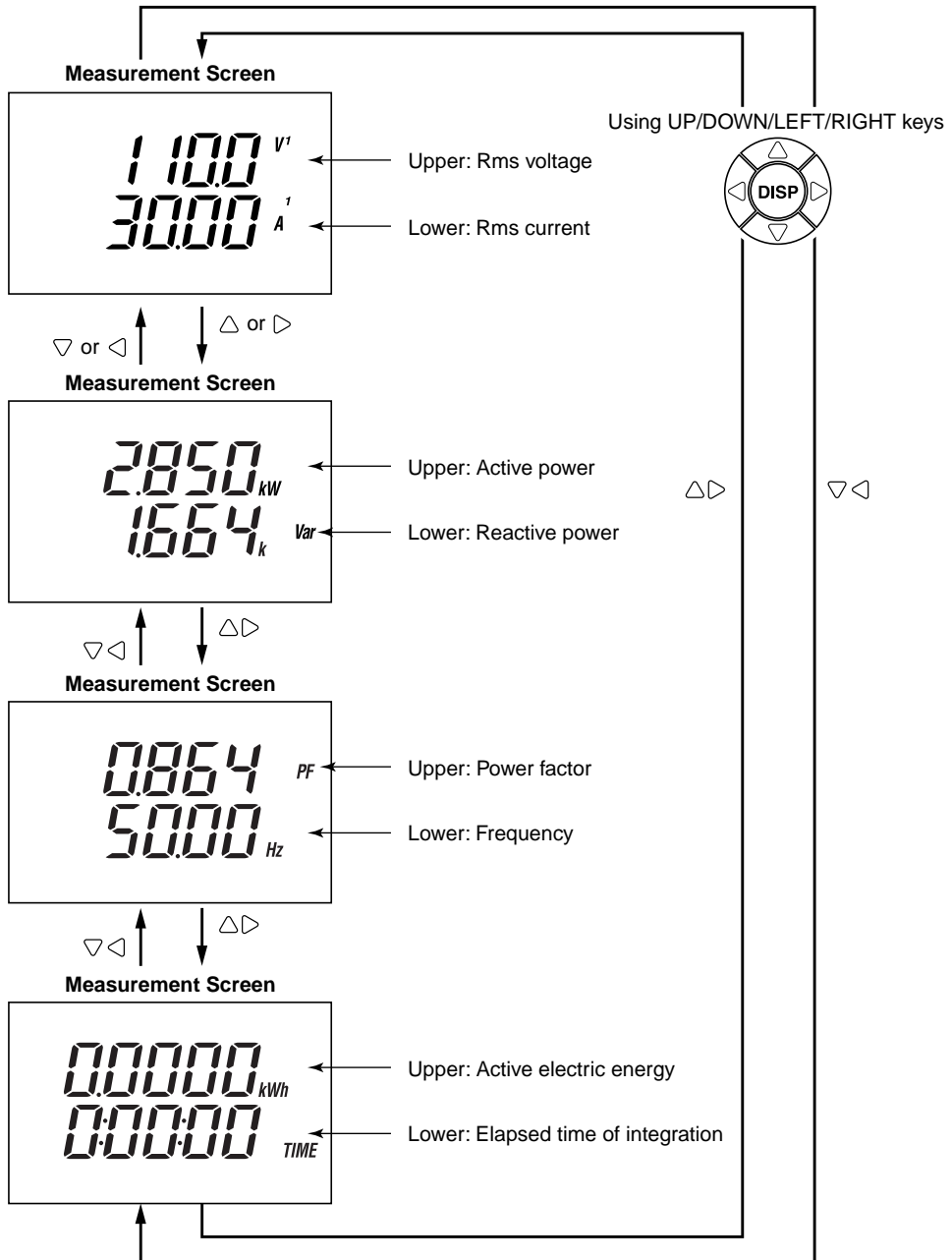

● Differences in Display Contents Depending on Wiring Method

Display contents differ depending on the wiring method as follows:

Phase Wires	Display Position	Displayed Item					
		Screen 1	Screen 2	Screen 3	Screen 4	Screen 5	Screen 6
Single-phase two wires (1Ø2W)	Upper row	V1	W	PF	Wh	/	/
	Lower row	A1	Var	Hz	TIME		
Single-phase three wires (1Ø3W) Three-phase three wires (3Ø3W)	Upper row	V1	A1	W	PF	Wh	/
	Lower row	V2	A2	Var	Hz	TIME	
Three-phase four wires (3Ø4W)	Upper row	V1	V3	A2	W	PF	Wh
	Lower row	V2	A1	A3	Var	Hz	TIME
Single-phase tow-wires x2 (1Ø2W x2)	Upper row	V1	W1	PF1	Wh1	/	/
	Lower row	A1 A2	W2	PF2	Wh2		
Var1			Hz	TIME			
Single-phase tow-wires x3 (1Ø2W x3)	Upper row	V1	W1	PF1	Wh1	/	/
			W2	PF2	Wh2		
Lower row	A1 A2 A3	Var1	Hz	TIME			
		Var2 Var3					

Name/Unit Appearing Next to Each Value

- V1, V2, V3: Input rms voltages
- A1, A2, A3: Input rms currents corresponding to CH1, CH2, and CH3, respectively
- W, W1, W2, W3: Active power (with minus sign in case of negative value)
- Var, Var1, Var2, Var3: Reactive power (with minus sign in case of negative value)
- PF, PF1, PF2, PF3: Power factor (with minus sign in case of negative value)
- Hz: Frequency
- Wh, Wh1, Wh2, Wh3: Active electric energy
- TIME: Elapsed time of integration

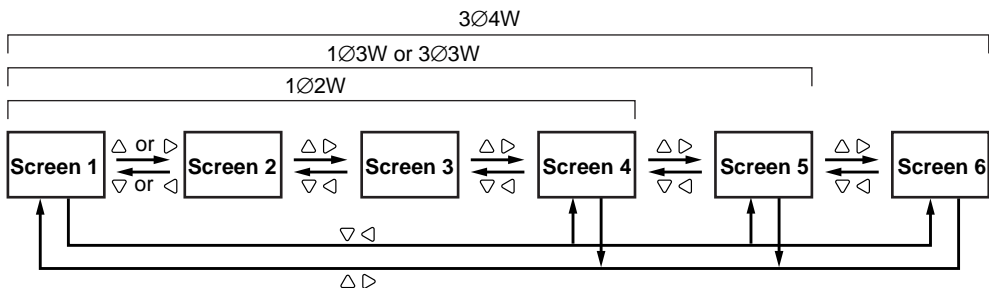

8.2 Switching Display Contents

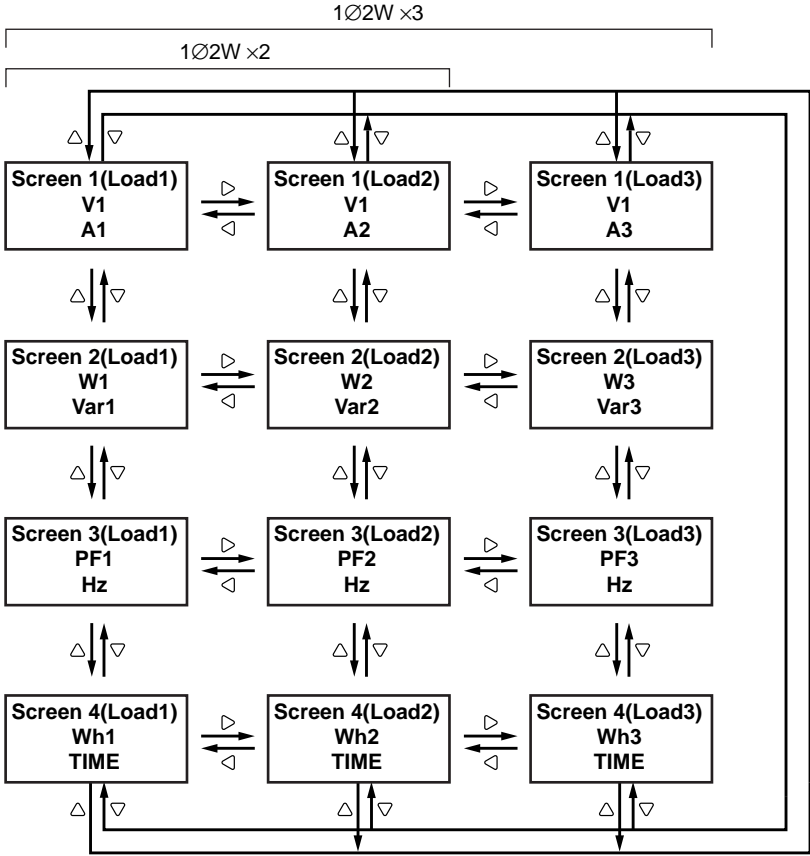

TIP

- The active electric energy and elapsed time of integration are displayed also during instantaneous value measurement.
- Polarities of Active Power, Reactive Power and Power Factor

	Lag		Lead	
	180	90	0	90
Phase difference	180	90	0	90
Active Power	-	+	+	-
Reactive Power	+	+	-	-
Power Factor	-	+	-	+

8.3 Saving Data

There are two ways to save measured data to the PC card:

1. Manual, on-demand saving by pressing the  key during instantaneous value measurement
2. Auto-saving at the preset output interval during electric energy measurement (continuous measurement)

This section describes the former way.

Procedure

Pressing the  key when the measurement screen is displayed during instantaneous value measurement causes a one-shot action of saving all the measured values. (This action is referred to as manual saving.)

- (1) When the measurement screen is displayed, press the  key. The file number then appears on the screen and all the measured values are saved.

File Number Display upon Manual Saving

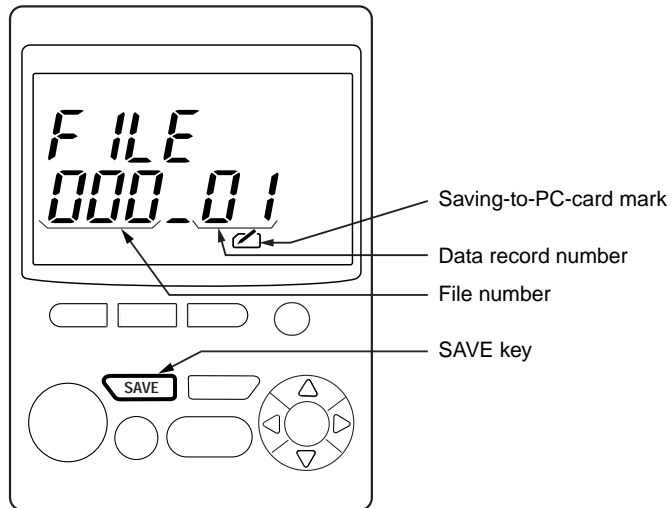

- (2) Pressing the  key again saves the measured values again with the data record number incremented but with the file number unchanged.

 **NOTE**

- The file name will be given automatically.
- The file number is renewed in the following cases: (1) the data record number has exceeded 99; (2) the wiring method has changed; (3) the **RESET** or **FILE** actions have been carried out in the setting screen; (4) the PC card is removed or a PC card is inserted; and (5) the power is turned off once and then back on.
- Up to 30 files can be saved to a PC card (corresponding to file numbers from 000 to 029); attempting to save too many files causes *Err. 103* to appear. This will disappear and the measurement screen will return when any key is pressed. Delete an unnecessary file or files and try saving again.
- If there is something wrong with the inserted PC card, data cannot be saved and *CardErr.* appears. (The measurement screen will return when any key is pressed.)
- When the PC card becomes full, the **FULL** mark appears and data will not be saved.
- Saving the measured data when the communication device is set to a printer, causes the  mark to flash and prints the data at the same time as the data saving.

File Name and Format

Measured data are saved to a CSV format file and the file name (“MWTH” followed by a number) is given automatically.

File name = MWTHxxx.CSV

Name (xxx): The smallest, unused number from 000 to 029

Filename extension: Always CSV

Example of Saved, Measured Data

Shown below is an example of a measured-data file (that was saved in a PC card) when opened from a spreadsheet application that has a CSV file converter. (The field configuration varies depending on the measurement conditions.)

OUTPUT DATE	OUTPUT TIME	INTEG START DATE	INTEG START TIME	ELAPSED TIME	V1	I1	P	Q	PF	F	Wh(+)	Wh(-)
2001/11/11	10:10:00	0000/00/00	0:00:00	0:00:00								
2001/11/11	10:15:00	0000/00/00	0:00:00	0:00:00								
2001/11/11	10:21:00	0000/00/00	0:00:00	0:00:00								

Header (measurement conditions)

- CW12x:** Indicates the model.
- File Type:** “2” indicates a file containing instantaneous values measured.
- Measure Mode:** “1” indicates electric energy measurement.

Fields of each data record

- OUTPUT DATE:** Date of output
- OUTPUT TIME:** Time of output
- INTEG START DATE:** Integration start date
- INTEG START TIME:** Integration start time
- ELAPSED TIME:** Elapsed time of integration

(The order of measured value fields below shows an example for the single-phase two-wire method.)

- V1:** Rms voltage (value appearing with “V1” on meter screen)
- I1:** Rms current (value appearing with “A1” on meter screen)
- P:** Active power (value appearing with “W” on meter screen)
- Q:** Reactive power (value appearing with “Var” on meter screen)
- PF:** Power factor (value appearing with “PF” on meter screen)
- F:** Frequency (value appearing with “Hz” on meter screen)
- Wh(+):** Active electric energy (value appearing with “Wh” on meter screen)
- Wh(-):** Regenerative electric energy (not appearing on meter screen)

SEE ALSO

For details, see Appendix 3, “File Structures and Data Items Printed.”

8.4 Frequency Measurement

The frequency of voltage input V1 is presented as the measured frequency. The frequency measurement is performed synchronously with the signal input.

When the V1 level is less than 10% of the rated voltage, the integration cycle is fixed to approximately 125 milliseconds.

Range of frequency measured: 45 to 65 Hz

Provision of Lowpass Filter

A lowpass filter with the cutoff frequency of 300 Hz is built into the frequency measurement circuit for eliminating noise from the input signal and assuring accurate frequency measurement.

8.5 Sampling Cycle and Integration Cycle

Synchronously with the zero crossing signal for the input voltage V1, the time period from when a cycle of zero-crossing begins until a cycle of zero crossing occurs immediately next after a specified period (100 milliseconds) has elapsed, is set to the integration cycle, and the rms voltage, rms current, and power are calculated.

Sampling frequency: Approx. 10 kHz

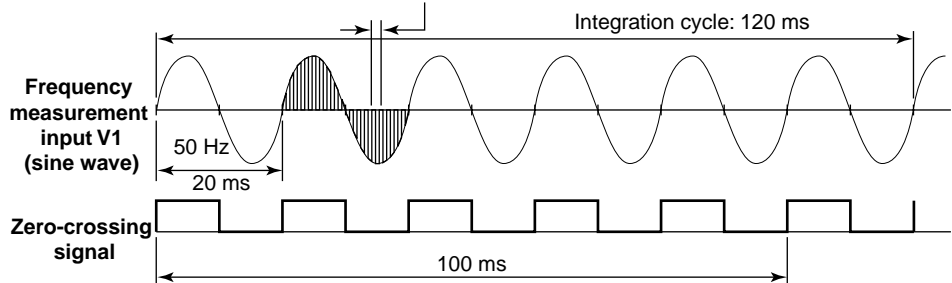



Examples

Frequency (Hz)	Integration Cycle (ms)	Number of Waves
50	120	6
60	116.67	7

9.1 Measuring Electric Energy

The CW120/121 power meters have two modes for measurement:

1. **Instantaneous value measurement:** Measures the rms voltages and rms current of individual phases, and power, reactive power, power factor, and frequency.
2. **Electric energy measurement:** In addition to the values in the instantaneous value measurement mode, measures the electric energy. Measurement is performed continuously and integration is started and stopped by using the   keys.

This section describes electric energy measurement.

● Displayed Data

As the values measured and displayed, those related to active electric energy are added to the values during instantaneous value measurement.

During Instantaneous Value Measurement

Item	Unit	Displayed Name
Rms voltage	V	V1, V2, V3 (differs depending on the wiring method)
Rms current	A	A1, A2, A3 (differs depending on the wiring method)
Active power	W	W, W1, W2, W3 (differs depending on the wiring method)
Reactive power	Var	Var, Var1, Var2, Var3 (differs depending on the wiring method)
Power factor	—	PF, PF1, PF2, PF3
Frequency	Hz	Hz (input frequency of V1)

During Electric Energy Measurement

Item	Unit	Displayed Name
Active electric energy	Wh	Wh, Wh1, Wh2, Wh3
Elapsed time of integration	Hour:minute:second Hour:minute Hour	00:00:00TIME 0000:00TIME 00000hTIME The display format changes over between the above automatically depending on the elapsed time.
(Regenerative electric energy)*	Wh	The values are not displayed on the screen, but only saved.

* Stands for the integrated, reversal power flow.

9.1 Measuring Electric Energy

● Measurement Procedure

1. Perform safety checks
with reference to Chapter 3, "Precautions for Safe Measurement."
2. Turn on the power to CW120/121
with reference to Chapter 4, "Connecting Power Supply and Turning Power On/Off."
3. Perform wiring
with reference to Chapter 5, "Wiring."
4. Set the ranges and wiring method
with reference to Chapter 6, "Setting Ranges and Wiring Method."
5. Set measurement conditions
with reference to Chapter 7, "Making Settings."
6. Call the measurement screen
with reference to Chapter 8, "Instantaneous Value Measurement."
7. **Measure the electric energy (watt-hours).**





NOTE

During integration (continuous measurement) or standby for integration, no settings can be modified but they can be viewed by pressing the  key for checking.



9.2 Starting and Stopping Integration

9.2.1 Starting Procedures

There are three ways to start integration:

- **Manual start:** Pressing the  key for one second or more starts integration.
- **Automatic start at the specified time on the specified date:** Setting the start date and time via the setting screen and pressing the  key puts the meter into the integration standby state. After this, when the specified time is reached, integration begins.
- **Remote start by external control signal:** A signal input from the external control terminals starts integration. For details, see Section 9.6, “External Control Input/Output.”

Manual Start

Press the  key for one second or more. Then, the **INTEG** mark appears on the screen, the LED status indicator immediately above the  key lights up, and integration starts. If data saving to the PC card is enabled (see Section 7.2.10), the file number of the file to which the data is to be saved is displayed at the same time. After two seconds, the file number display disappears and the measurement screen returns.

Display of File Number for Auto-saving

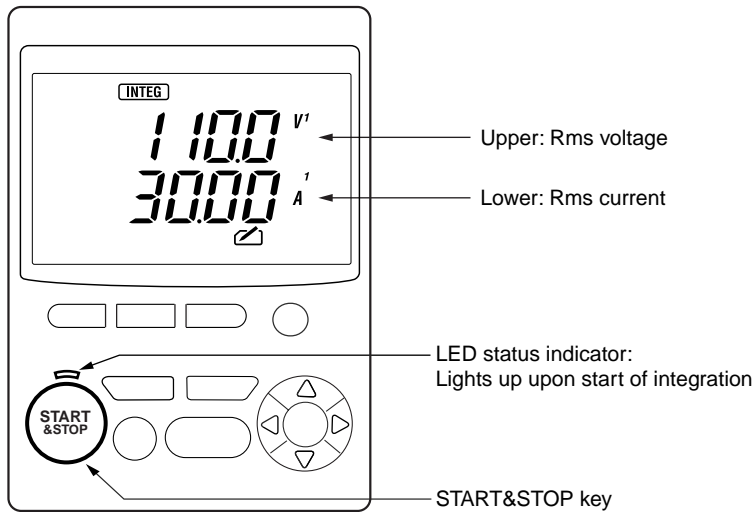
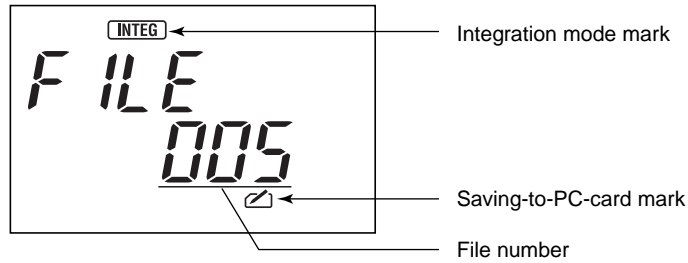

Automatic Start at Specified Time on Specified Date

In this method, you set the integration start date and time via the setting screen. For the setting procedure, see “Measurement Procedure” in Section 9.1, “Measuring Electric Energy,” and Section 7.2.8, “Setting Integration Start Date and Time.”

● **If Start Date and Time Are Set to Future Point of Time (Later than Current Time)**

Pressing the  key flashes the **INTEG** mark (on the screen) and LED status indicator. The file number of the file to which the data is to be saved is displayed for approximately two seconds (only if data saving to the PC card is enabled [see Section 7.2.10]), then the file number display disappears and *don't Start* appears, indicating that the power meter has entered the integration standby state.

Display of File Number for Auto-saving

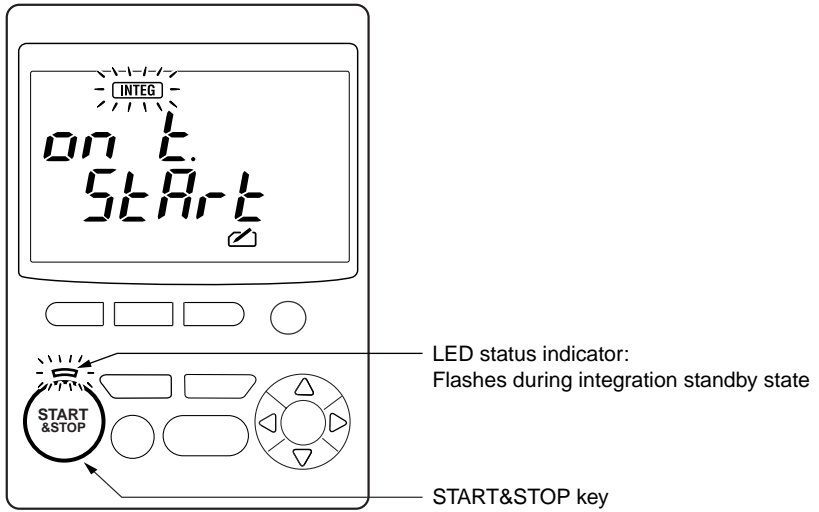
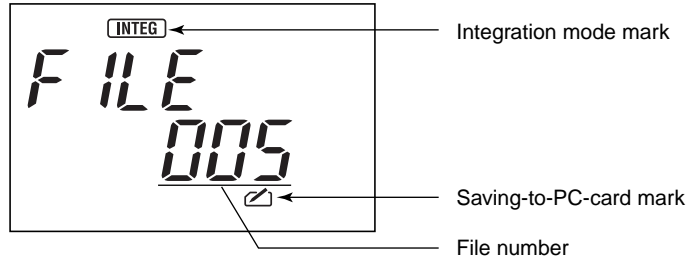

When the specified time on the specified date has been reached, integration begins.

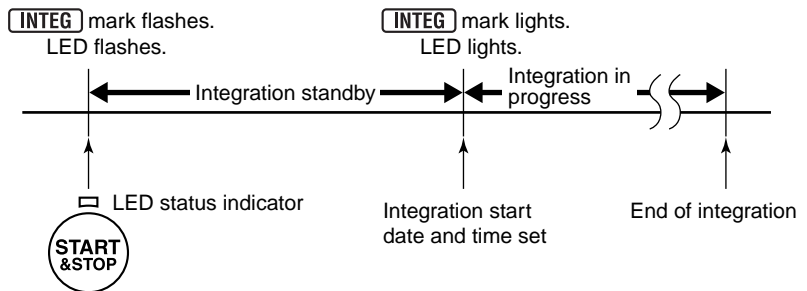

9.2 Starting and Stopping Integration

- **If Start Date and Time Are Set to Past Point of Time (Earlier than Current Time)**

Pressing the  key flashes the **INTEG** mark (on the screen) and LED status indicator. The file number of the file to which the data is to be saved is displayed for approximately two seconds (only if data saving to the PC card is enabled [see Section 7.2.10]), then the file number display disappears and *IntEr. StArT* appears, indicating that the power meter has entered the integration standby state.

Display of File Number for Auto-saving

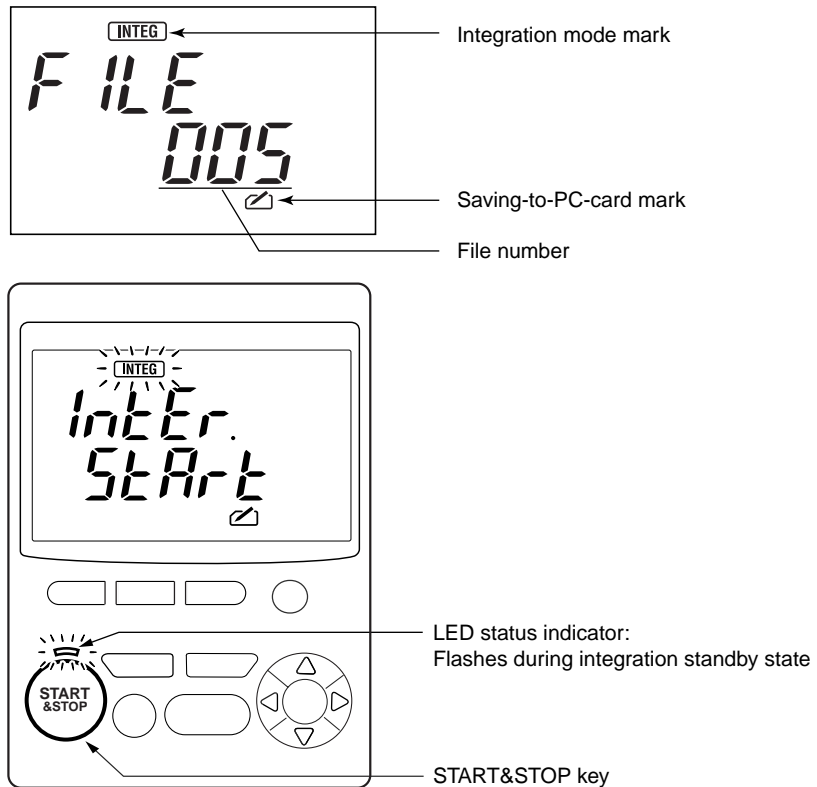

Integration will begin at an appropriate time determined from the output interval set.

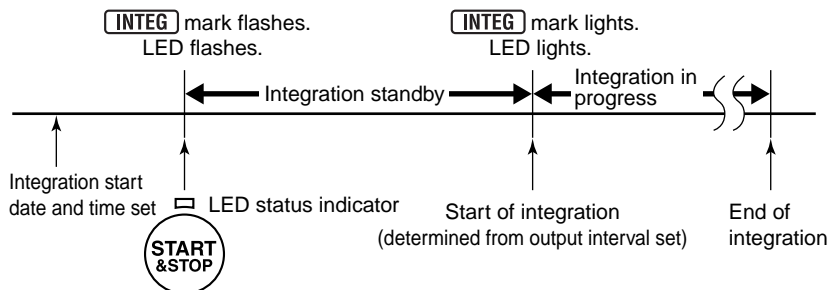

TIP

- When setting the integration start date and time, consider the time period you need to finish all actions for setting the date and time and putting the meter into the integration standby state. (The start date and time may be passed before finishing the setting.)
- If the start date and time are set to later than (in the future) the stop date and time, the stop date and time will be changed to the time after the start date and time for the output interval.
- The manual saving action takes precedence over the automatic start setting. Upon pressing the **START & STOP** key for one second or more to start saving manually, the start date and time settings become ineffective.
- To reset the integration standby state, press any key to return to the measurement screen, and then press the **START & STOP** key for one second or more. This will cause the **INTEG** mark to disappear and the LED status indicator to extinguish.

9.2.2 Stopping Procedures

There are three ways to stop integration:

- **Manual stop:** Pressing the **START & STOP** key for one second or more stops integration. (Use this method to abort integration.)
- **Automatic stop at the specified time on the specified date:** When the specified time on the specified date set via the setting screen is reached, integration stops. (The stop date and time settings are effective only when integration has begun automatically at the start date and time set.)
- **Remote stop by external control signal:** A signal input from the external control terminals stops integration. For details, see Section 9.6, “External Control Input/Output.”

Manual Stop

Press the **START & STOP** key for one second or more. Then, the **INTEG** mark disappears from the screen, the LED status indicator immediately above the **START & STOP** key extinguishes, and integration stops.

Aborting Integration

To abort integration before the set stop date and time have been reached, also press the **START & STOP** key for one second or more.

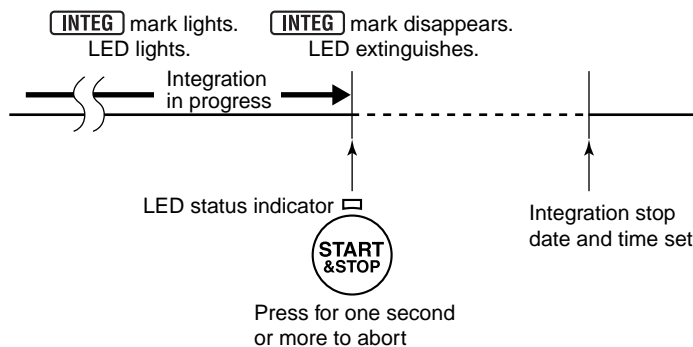

9.2 Starting and Stopping Integration

Automatic Stop at Specified Time on Specified Date

This is a method in which you set the integration stop date and time via the setting screen. The stop date and time settings are effective only when integration has begun automatically at the start date and time set. For the setting procedure, see “Measurement Procedure” in Section 9.1, “Measuring Electric Energy,” and Section 7.2.9, “Setting Integration Stop Date and Time.”

When the set stop time and date have been reached, the **INTEG** mark disappears from the screen, the LED status indicator immediately above the  key extinguishes, integration stops, and the screen changes as shown below, indicating that integration has stopped.

Screen Showing End of Integration



Pressing any key returns to the screen for instantaneous value measurement.

TIP

-
- Set the stop date and time such that the period from the start to the end of integration is not shorter than the output interval. Otherwise, only the data at the start and end times will be saved.
 - Manually starting integration makes the stop date and time settings ineffective. You need to stop integration manually in this case.
 - If the start date and time are set to later than (in the future) the stop date and time, the stop date and time will be changed to the time after the start date and time for the output interval.
 - If the integration starts at a time after (in the future) the set stop date and time, the stop date and time settings become ineffective. You need to stop integration manually in this case, too.
 - As the stop date and time, you cannot set a time earlier than (in the past) the start date and time.
-

9.2.3 Clearing Electric Energy Count

There are two ways to clear the electric energy count and elapsed time of integration:

1. In the measurement mode, press the  key for three seconds or more.
2. In the setting mode, choose the setting item for clearing the electric energy count and resetting the system, and perform the specified setting actions.



This section describes the former way. For the latter way, see Section 7.2.4, "Clearing Electric Energy Count and Resetting System."

Procedure

- (1) When the measurement screen is displayed, press the  (escape) key for three seconds or more. Then, the **RESET** mark appears and *IntEG* flashes on the screen.

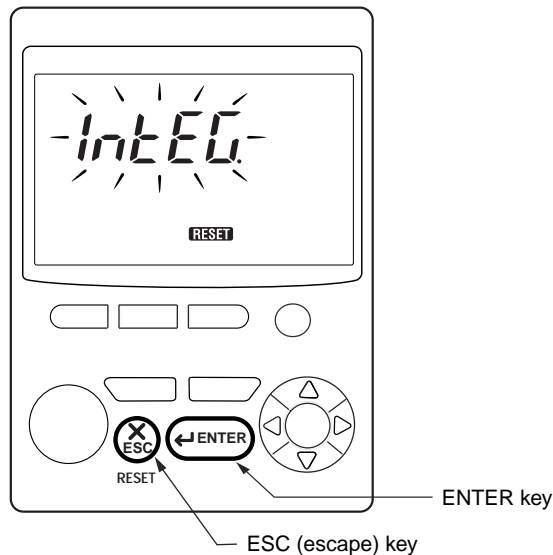
Electric Energy Count Clearance Screen



- (2) Press the  key. The electric energy count is cleared and the measurement screen returns. To cancel, press the  key. The measurement screen also returns.

9.3 Switching Display Contents

In the same way as during instantaneous value measurement, pressing one of the \triangle ∇ \triangleleft \triangleright keys changes the display contents in order. The sequence differs depending on the wiring method set. For example, the sequence when the single-phase two-wire method is chosen is shown below. Even for the unseen data items, the respective calculations are performed internally.

Sequence of Display Contents Switching for Single-phase Two Wires

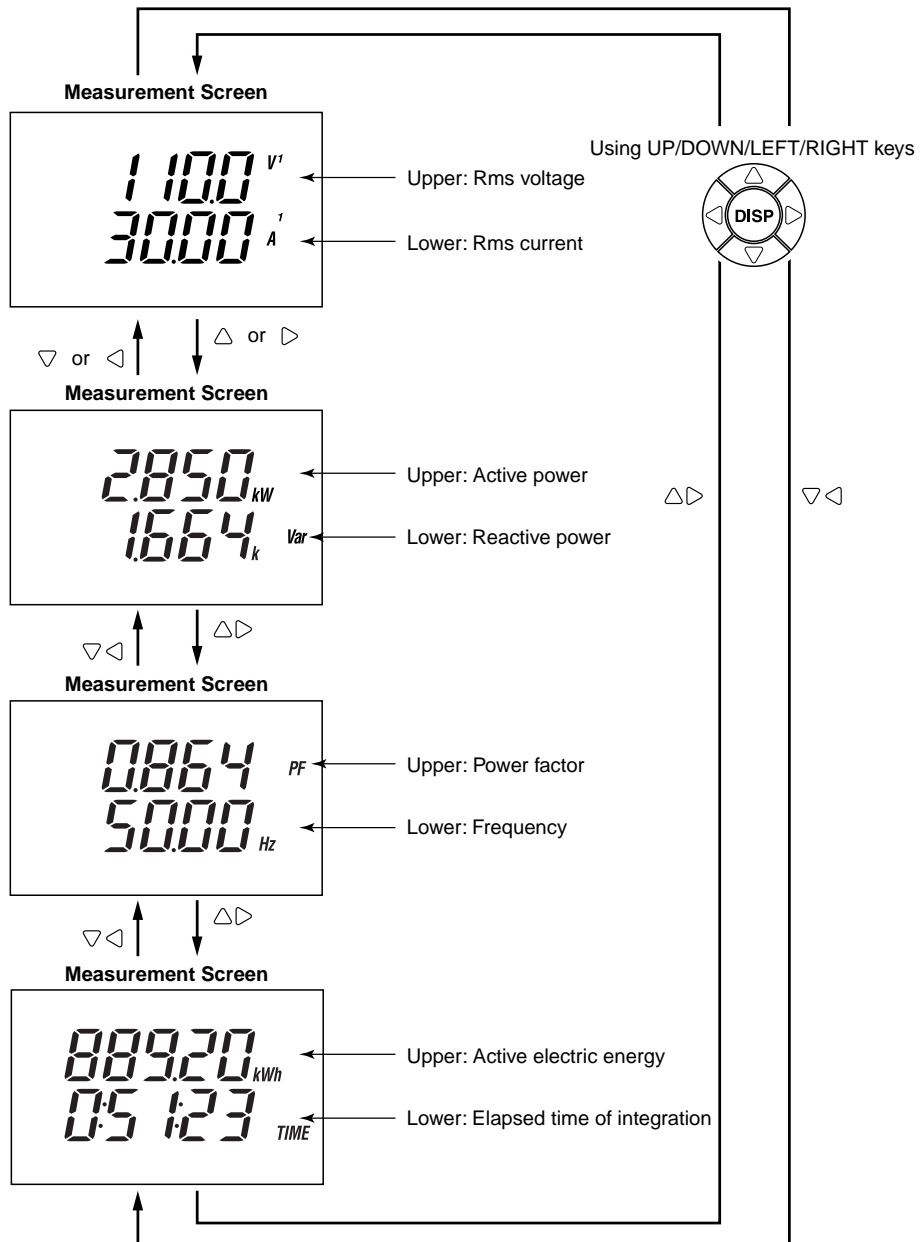

● Differences in Display Contents Depending on Wiring Method

Each time one of the \triangle ∇ \triangleleft \triangleright keys is pressed, the display contents change sequentially as follows:

Phase Wires	Display Position	Displayed Item					
		Screen 1	Screen 2	Screen 3	Screen 4	Screen 5	Screen 6
Single-phase two wires (1 ϕ 2W)	Upper row	V1	W	PF	Wh	/	/
	Lower row	A1	Var	Hz	TIME		
Single-phase three wires (1 ϕ 3W) Three-phase three wires (3 ϕ 3W)	Upper row	V1	A1	W	PF	Wh	/
	Lower row	V2	A2	Var	Hz	TIME	
Three-phase four wires (3 ϕ 4W)	Upper row	V1	V3	A2	W	PF	Wh
	Lower row	V2	A1	A3	Var	Hz	TIME
Single-phase tow-wires x2 (1 ϕ 2W x2)	Upper row	V1	W1 W2	PF1 PF2	Wh1 Wh2	/	/
	Lower row	A1 A2	Var1 Var2	Hz	TIME		
Single-phase tow-wires x3 (1 ϕ 2W x3)	Upper row	V1	W1 W2 W3	PF1 PF2 PF3	Wh1 Wh2 Wh3	/	/
	Lower row	A1 A2 A3	Var1 Var2 Var3	Hz	TIME		

Name/Unit Appearing Next to Each Value

- V1, V2, V3: Input rms voltages
- A1, A2, A3: Input rms voltages corresponding to CH1, CH2, and CH3, respectively
- W, W1, W2, W3: Active power (with minus sign in case of negative value)
- Var, Var1, Var2, Var3: Reactive power (with minus sign in case of negative value)
- PF, PF1, PF2, PF3: Power factor (with minus sign in case of negative value)
- Hz: Frequency
- Wh, Wh1, Wh2, Wh3: Active electric energy
- TIME: Elapsed time of integration

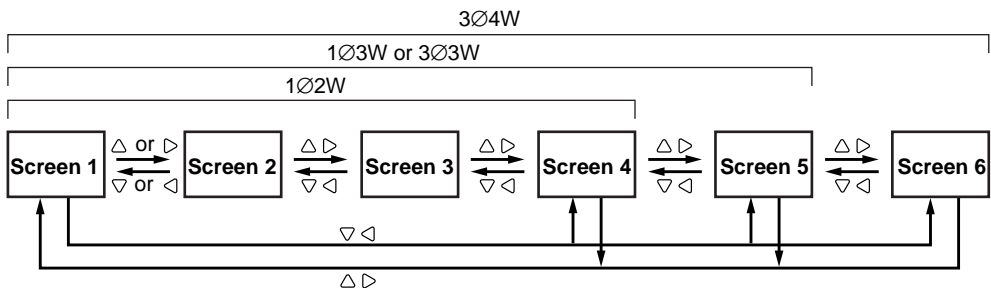

9.3 Switching Display Contents

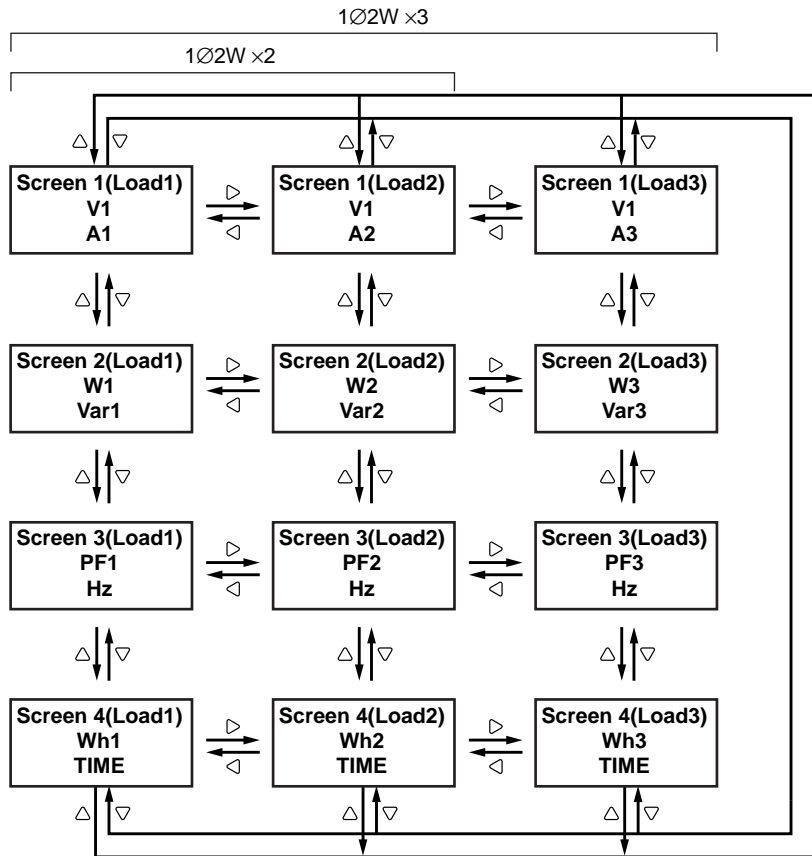

9.4 Saving Data

There are two ways to save measured data to the PC card:

1. Manual, on-demand saving by pressing the **SAVE** key during instantaneous value measurement
2. Auto-saving at the preset output interval during electric energy measurement (continuous measurement)

This section describes the latter way.

Procedure

Make settings so as to enable data saving to the PC card (see Section 7.2.10), and the data will be saved automatically.

Conditions Required for Data Saving

Start of integration:	Activated at the set date and time.
End of integration:	Activated at the set date and time.
Output interval:	Selected from 1, 2, 5, 10, 15, and 30 seconds, 1, 2, 5, 10, 15, and 30 minutes, and 1 hour.
Data saving to PC card:	Enabled (switched on).

For details of these settings, see Chapter 7, "Making Settings."

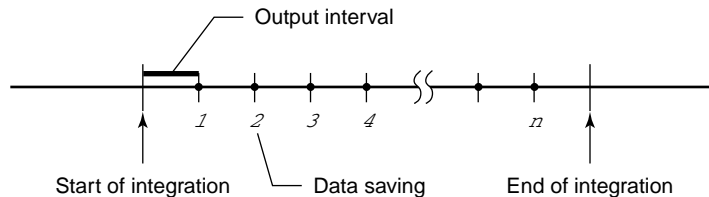

NOTE

- Up to 30 files with automatically given names can be saved to a PC card (corresponding to file numbers from 000 to 029); attempting to save too many files causes **Err. 103** to appear and the data will be saved to the backup memory. The error code will disappear and the measurement screen will return when any key is pressed.
- If a PC card is not inserted, **CardErr.** appears when integration begins and data will be saved to the backup memory. (The error code will disappear and the measurement screen will return when any key is pressed.)
- When the PC card becomes full, the **FULL** mark appears and data will be saved to the backup memory.

For details, see Section 7.2.5, "Copying and Clearing Backup Memory Contents," and Section 9.5, "Backup Memory."

9.4 Saving Data

File Name and Format

Data measured during electric energy measurement are saved to a CSV format file and the file name ("AWTH" followed by a number) is given automatically and can also be specified using a command via communication.

The file name can also be specified using a command via communication.

File name = AWTHxxx.CSV

Name (xxx): The smallest, unused number from 000 to 029

Filename extension: Always CSV

If data saving to the PC card is enabled, the file number of the file to which data is to be saved will be displayed on the screen when starting integration.

Display When File Name Is Given Automatically

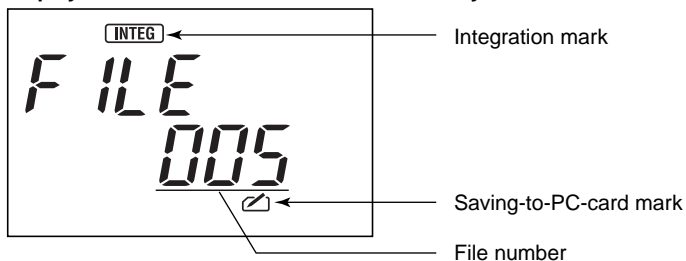

Display When File Name Is Specified

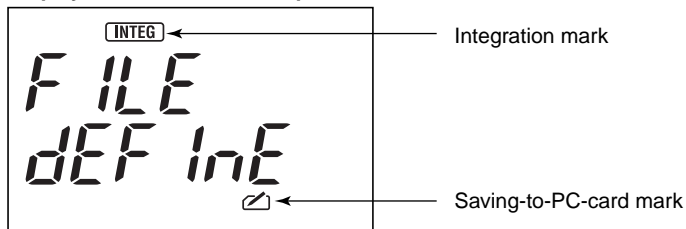

SEE ALSO

For details, see Section 7.3, "Setting Name of Measured-data File."

Example of Saved, Measured Data

Shown below is an example of a data file saved to a PC card when it is opened from a spreadsheet application that has a CSV file converter. (The field configuration varies depending on the measurement conditions.)

CW12x													
File Type	0												
Measure Mode	1												
OUTPUT DATE	OUTPUT TIME	INTEG START DATE	INTEG START TIME	ELAPSED TIME	V1	I1	P	Q	PF	F	Wh(+)	Wh(-)	
2001/12/01	09:10:00	2001/12/01	09:00:00	0:10:00									
2001/12/01	09:20:00	2001/12/01	09:00:00	0:20:00									
2001/12/01	09:30:00	2001/12/01	09:00:00	0:30:00									

Header (measurement conditions)

CW12x: Indicates the model.

File Type: "0" indicates a file containing values of integrated data (saved automatically).

Measure Mode: "1" indicates electric energy measurement.

Fields of each data record

OUTPUT DATE: Date of output

OUTPUT TIME: Time of output

INTEG START DATE: Integration start date

INTEG START TIME: Integration start time

ELAPSED TIME: Elapsed time of integration

(The order of measured value fields below shows an example for the single-phase two-wire method.)

V1: Rms voltage (value appearing with "V1" on meter screen)

I1: Rms current (value appearing with "A1" on meter screen)

P: Active power (value appearing with "W" on meter screen)

Q: Reactive power (value appearing with "Var" on meter screen)

PF: Power factor (value appearing with "PF" on meter screen)

F: Frequency (value appearing with "Hz" on meter screen)

Wh(+): Active electric energy (value appearing with "Wh" on meter screen)

Wh(-): Regenerative electric energy (not appearing on meter screen)

SEE ALSO

For details, see Appendix 3, "File Structures and Data Items Printed."

9.5 Backup Memory

The CW120/121 have a built-in memory for backing up the PC card and can be used for saving data up to 1500 times at 1φ2W×2, 1000 times at 1φ2W×3 or 3000 times at other type of connection. Data is saved to the backup memory in the following cases:

- When the PC card becomes full (the **FULL** mark appears).
- The PC card is removed during integration.

When data resides in the backup memory, the **MEM** mark is displayed. (The data stored in the backup memory is retained during power-off.)

The data in the backup memory is cleared whenever integration starts. Namely, starting integration when previous data is retained in the backup memory deletes it.

NOTE

When number of data save to the backup memory exceed each limit, *Err200* appears and the saving action is aborted.

The data in the backup memory is processed as follows.

● When a PC Card Having Sufficient Free Space Is Inserted during Integration

When a PC card is inserted, the data from that time on is saved to the PC card with the same file name as before. Then, when integration ends, the data stored in the backup memory will be copied to the bottom of the last file (i.e., data is added within the last file) in the PC card. During this copying action, *DATA COPY* is displayed on the screen and it will change to *IntEGEnd*, indicating that integration has ended.

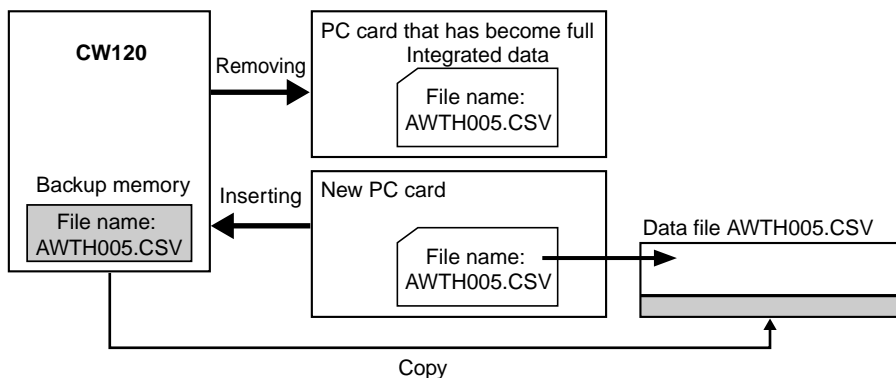

- **When a PC Card Having Sufficient Free Space Is Not Inserted during Integration**

Data is continuously saved to the backup memory. If integration ends after the PC card has become full or when it is not inserted, you need to carry out either of the procedures below.

If Data Is Needed

Follow the procedure below to copy the data from the backup memory to a formatted, new PC card.

- (1) Insert a new, formatted PC card.
- (2) Press the **MEAS/SET** key to call the setting item selection screen.
- (3) Using the **△ ▽ ◀ ▶** keys, select **MEM** (make the **MEM** mark appear).
- (4) Press the **←ENTER** key. **COPY** then flashes on the screen.
- (5) Press the **←ENTER** key again. The data is then copied from the backup memory to the PC card with the same file name. The **MEM** mark will disappear, indicating that the copy has finished and data in the backup memory has been cleared.
- (6) Press the **MEAS/SET** key to return to the measurement screen.

Screen for Copying Data

Screen for Copying Data

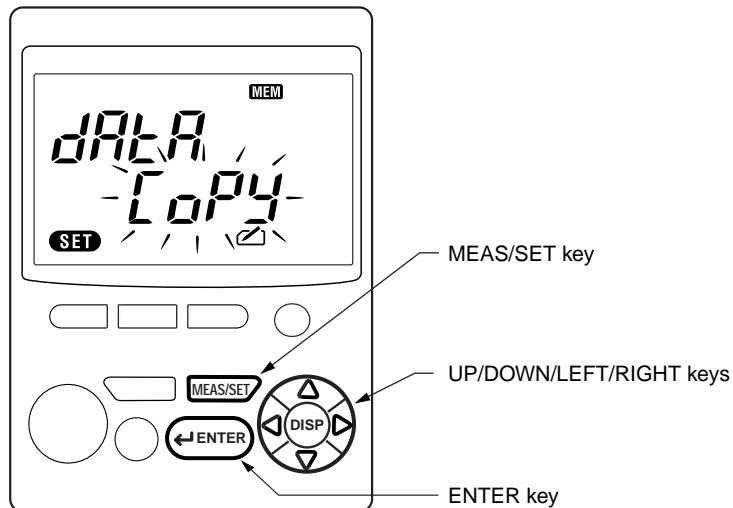

SEE ALSO

Section 7.2.5, "Copying and Clearing Backup Memory Contents"

NOTE

If a file having the same file name resides in the PC card, the data is copied (added) to the bottom of that file.

9.5 Backup Memory

If Data Is Not Needed

Follow the procedure below to clear the data in the backup memory.

- (1) Press the **MEAS/SET** key to call the setting item selection screen.
- (2) Using the \triangle ∇ \triangleleft \triangleright keys, select **MEM** (make the **MEM** mark appear).
- (3) Press the **←ENTER** key. **COPY** then flashes on the screen.
- (4) Using the \triangle ∇ \triangleleft \triangleright keys, change **COPY** to **dEL.**
- (5) Press the **←ENTER** key. The data is then cleared from the backup memory.
- (6) Press the **MEAS/SET** key to return to the measurement screen.

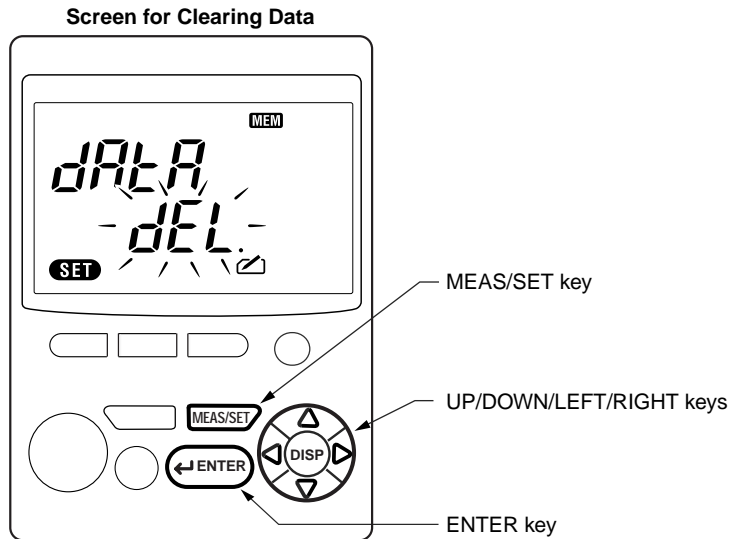

SEE ALSO

Section 7.2.5, "Copying and Clearing Backup Memory Contents"

NOTE

Starting the next integration will also clear the data in the backup memory.

9.6 External Control Input/Output

9.6.1 Remote Control

Integration (continuous measurement) can be started and stopped remotely. The external control input must be a 0/5 V (Low/High) level voltage signal or an open/close (short-circuit) contact. The external control output is a 0/5 V (Low/High) level voltage signal. Only the models with the RS-232 interface have external control input/output terminals.

Input

While the external control input signal is at the low level or is closed, integration (continuous measurement) is performed. While the external control input signal is at the high level or is open, instantaneous value measurement is performed.

Output

While integration (continuous measurement) is performed, the output is at the low level. While instantaneous value measurement is performed, the output is at the high level.

The **EXT** mark is displayed when integration is controlled by the external control signal.

• Input Circuit

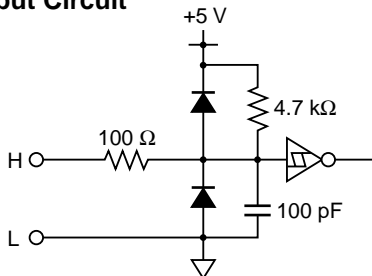

• Terminal Arrangement

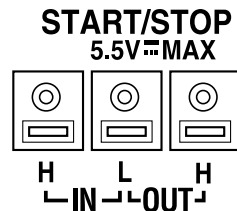

• Output Circuit

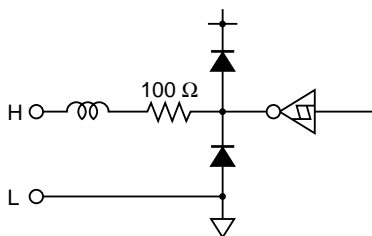

• Example of Input Signal Changes

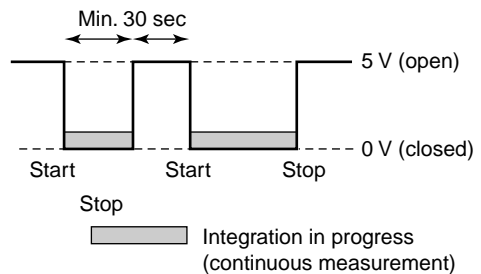

9.6 External Control Input/Output

Remote integration start/stop control takes precedence over manual start/stop and automatic start/stop at specified times. Remote control takes effect even during the integration standby state and when a setting screen is displayed. However, it is ineffective when integration has already begun and is on.

- Monitoring time:
A start-to-stop period must be at least 30 seconds long. Do not change the input signal within 30 seconds.
- Input levels
Low: 0.0 to 0.8 V
High: 2.0 to 5.0 V
- Allowable voltage:
The allowable voltage for the input terminals is -0.5 to 5.5 V.

9.6.2 Controlling Multiple CW120s and/or CW121s

When performing measurement with multiple CW120s and/or CW121s, you can synchronously start and stop integration in all the CW120s and CW121s by connecting external control terminals.

● Connecting a Control Signal in Parallel to Control All Meters Synchronously

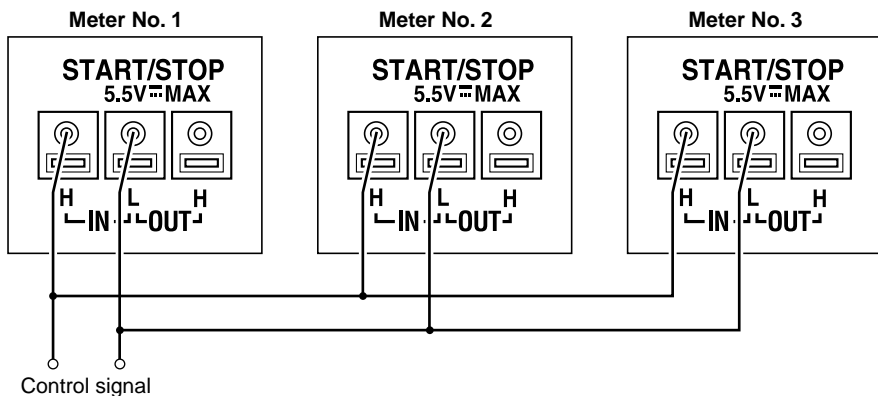

● Controlling Meter Nos. 2 and 3 by Control Signal of Meter No. 1

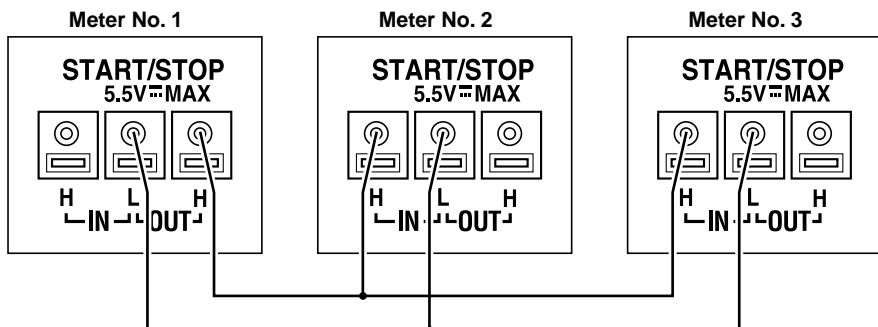

9.6.3 Wiring for Terminals

- **Wiring for External Control Input/Output Terminals**

With a flatblade screwdriver or the like, push in the rectangular dip beneath each terminal hole and insert a peeled signal wire. Releasing the screwdriver grips the wire.

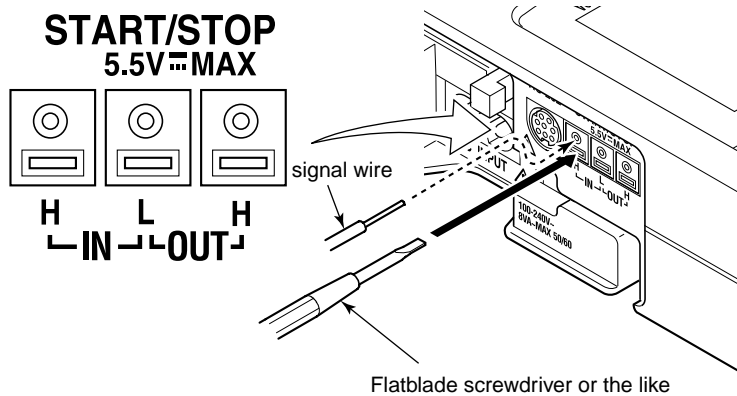

NOTE

- Do not apply a voltage exceeding the allowable voltage range (–0.5 to 5.5 V) to the control signal input terminal. The input circuit may be damaged.
- Do not confuse the input terminal with the output terminal.

- **Applicable Wires for Signal Wiring**

- Recommended wires:
 - Solid AWG 18 wires (1.0 mm diameter) or stranded 0.75 mm² wires
- Usable wires:
 - Solid AWG 26 to AWG 18 (0.4 to 1.0 mm diameter) wires
 - Stranded AWG 22 to AWG 20 (0.3 to 0.75 mm² diameter) wires with each strand thicker than 0.18 mm diameter
 - Standard peeling length: 10 mm

9.7 Meter Actions upon Power Failure and Recovery

The following describes the meter actions upon power failure and restoration concerning data saving. None of the following actions upon power failure and restoration takes place when a power failure has occurred during instantaneous measurement.

- **After Power Failure Occurred during Integration Standby State**

- If the power is restored before the preset integration start time:
P_FAIL is displayed and the meter enters the integration standby state. Pressing any key returns to the measurement screen, and integration will start when the preset date and time is reached.
- If the power is restored after the preset integration start time:
P_FAIL is displayed and the meter starts integration immediately after the power has been restored. Pressing any key returns to the measurement screen.

Power Restoration Display

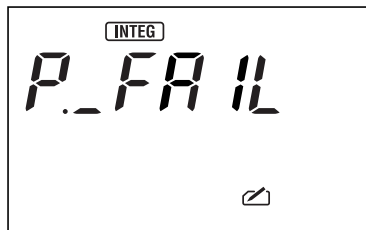

- **If Power Failure Has Occurred during Integration**

If data saving to the PC card is enabled (see Section 7.2.10), the active electric energy, regenerative energy, elapsed time of integration, and date and time of the power failure are saved. If a power failure has occurred during the saving action, it will be aborted and the data will be invalid. (This may result in destruction of the file.)

After the power restoration, the date and time of the restoration are saved, *P_FAIL* is displayed, and integration restarts in the same conditions as before the power failure. Pressing any key returns to the measurement screen.

Power Restoration Display

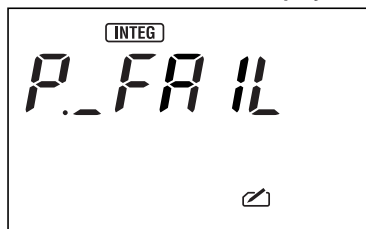

9.7 Meter Actions upon Power Failure and Recovery

Example of Power Failure/Restoration Data

CW12x				
File Type	0			
Measure Mode	1			
OUTPUT DATE	OUTPUT TIME	INTEG START DATE	INTEG START TIME	ELAPSED TIME
2001/12/01	09:10:00	2001/12/01	09:00:00	0:10:00
POWER OFF	2001/12/01	09:15:00		
POWER ON	2001/12/01	09:18:00		

POWER OFF: "2001/12/01" and "09:15:00" indicates that a power failure occurred at 09:15:00 on December 1, 2001.

POWER ON: "2001/12/01" and "09:18:00" indicates that the power was restored at 09:18:00 on December 1, 2001.

10.1 PC Card Specifications

The CW120/121 can save measured data and settings to a PC card as well as read saved settings from a PC card to apply them. The PC card interface of the CW120/121 complies with the following standards.

- PCMCIA
- Japan Electronic Industry Development Association (JEIDA)

Slots:	One Type II slot
Card type:	Flash ATA
Format:	MS-DOS

● **PC Card Models Whose Operations Have Been Verified**

- Compact flash card

Supplier	Model	Capacity
SanDisk Corporation, Japan	SDCFB-128	128 MB
	SDCFB-256	256 MB
	SDCFB-512	512 MB

10.2 Inserting and Removing PC Card

How to Insert a PC Card

To the PC card slot on the side of the CW120/121, insert a PC card with its front side up and in the direction of the arrow on top.

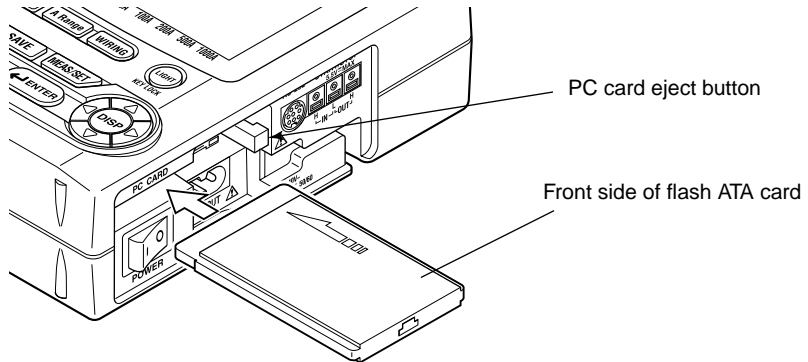

How to Remove a PC Card

Depress the eject button next to the card slot.

The eject button may be one of two positions: depressed and popped-out. (The figure above shows the depressed position.)

Drawn position: Depressing the button unlocks the card. Pull to remove the card.

Depressed position: Depressing the button changes the position to the popped-out position. Depress the button again to unlock the card, and then pull to remove the card.

NOTE

- Removing the PC card during access to it may destroy the saved files and damage the card itself. Before removing the card, ensure that:
 - Continuous measurement is not in progress.
 - Access to the card is not in progress (the  mark is not flashing).
- For details of handling the card, see the documentation supplied with the card.
- When transporting the CW120/121, remove the PC card from the slot.

10.3 Storage Capacity

The time span of data that can be saved varies depending on the output interval. The table below shows the approximate time spans over which data can be saved to a PC card for a few cases where there is no other file residing in the card.

Wiring Method	Memory	Interval Time	Stored Period
3Ø4W	32MB	1 Second	Approx 40 Hours
3Ø4W	32MB	10 Minutes	Approx 4 Months

 **NOTE**

To ensure that data can be saved, delete all files from the PC card other than measured-data files and setting files. Be careful that the total number of files in a card does not exceed 100.

10.4 Formatting PC Card

The CW120/121 can format a PC card in MS-DOS format. Format the card before using a newly purchased card, or to erase all files in the card.

Formatting a PC Card with CW120

- (1) Insert the PC card in the slot.
- (2) When the measurement screen is displayed, press the **MEAS/SET** key to call the setting item selection screen.
- (3) Select **FILE** (i.e., make the **FILE** mark appear).
- (4) Press the **ENTER** key. **DELALL** flashes on the screen.
- (5) Using the \triangle ∇ \triangleleft \triangleright keys, select *in it.*

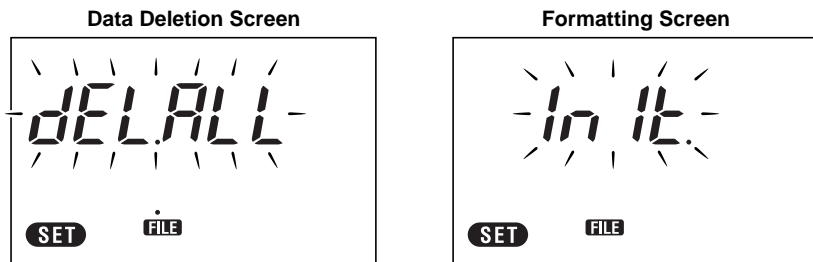

- (6) Press the **ENTER** key.
- (7) The  mark flashes, indicating that access to the PC card is in progress. When the mark stops flashing and disappears, the formatting has finished.
- (8) To return to the measurement screen, press the **MEAS/SET** key.

SEE ALSO

For details of the respective settings, see Section 7.2.3, "Deleting Measured-data Files and Formatting PC Card," in Chapter 7, "Making Settings."

● Saving and Loading Settings

Saving Settings

Select **CONF** in the setting item selection screen, select **SAVE**, specify the file number, and then perform saving.

File name: WTHxxx.SET

↑ File number from 000 to 029

Loading Settings

Select **CONF** in the setting item selection screen, select **LOAD**, specify the file number of one of the setting files saved in the PC card, and then perform loading.

File name: WTHxxx.SET

↑ File number from 000 to 029

SEE ALSO

For details of the respective settings, see Section 7.2.2, "Loading and Saving Settings," in Chapter 7, "Making Settings."

● Copying Data from Backup Memory

When data is saved during electric energy measurement, if the PC card becomes full or if the card is removed, the measured data is saved to the backup memory. This data contained in the backup memory can be copied to a PC card.

SEE ALSO

For details of how to copy data from the backup memory, see Section 7.2.5, "Copying and Clearing Backup Memory Contents."

10.6 Interface with Personal Computer

Data saved in a PC card can be processed on a PC. You can process measured data using a spreadsheet application and so on by inserting a PC card containing measured data into the PC card slot of a PC. Even when a PC card is left inserted in a CW120 or CW121, the measured data in the PC card can be read from a PC and the setting data can be written from the PC via RS-232* or RS-485* communication. (Specify which of the interfaces you need, when ordering.)

SEE ALSO

- For details of communication, see Chapter 11, "Communication Functions," and Appendix 2, "Communication Commands."
- For details of the format of saved files, see Appendix 3, "File Structures and Data Items Printed."

11.1 RS-232

The RS-232 interface allows the CW120/121 to be connected to a PC or printer.

● RS-232 Interface Specifications

Electromechanical specifications:	Compliant with EIA RS-232
Topology:	Point to point
Communication method:	Full duplex
Synchronization:	Asynchronous
Baud rate:	1200, 2400, 4800, 9600, 19200, 38400 bps
Start bits:	Fixed to 1 bit
Data bits:	7 or 8 bits
Parity:	Odd, even, or none
Stop bits:	1 or 2 bits
Connector:	Miniature DIN, 8 pins
Hardware handshake:	Whether to set CA (RTS) and CB (CTS) to true or use them as control signals can be chosen.
Software handshake:	Transmission/reception control by X-on and X-off signals is possible.
Reception buffer length:	1024 bytes



NOTE

The handshaking settings cannot be changed from the CW120/121. Modify the handshaking settings in a setting file and load the file to the CW120/121.

● RS-232 Interface Connections

When connecting a CW120 or CW121 to a computer or printer via its RS-232 interface, you need to make interface settings such as handshaking methods, data transmission speed (baud rate), and data bit length to match those settings in the computer. For details of these settings, see the pages that follow.

As the interface cable, use one of the cables dedicated for the CW120/121: the 91011 (with D-sub 9-pin connector for a PC), 91009 (with D-sub 25-pin connector for a PC) or 91010 (for a printer).

Connector Pins and Assigned Signals

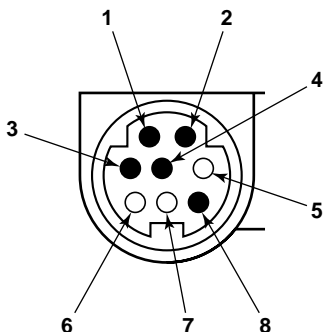

- 1. CTS (**C**lear **T**o **S**end): Input handshaking signal from the computer used when transmitting data to the computer
- 2. RXD (Receive [**rx**] **D**ata): Input data from the computer
- 3. RTS (**R**quest **T**o **S**end): Output handshaking signal to the computer used when receiving data from the computer
- 4. TXD (Transmit [**tx**] **D**ata): Output data to the computer
- 5-7. Unused
- 8. GND (Signal **G**round): Signal ground

Directions of Individual Signals

The figure below shows the directions of the individual signals used in the RS-232 interface.

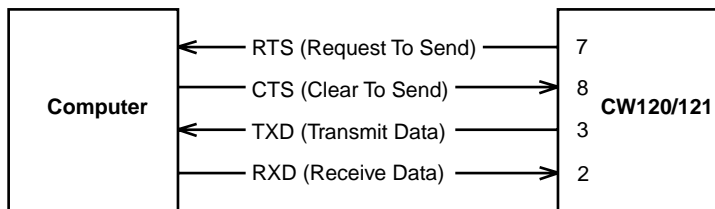

Correspondences of Signal Abbreviations between RS-232 Standard, CCITT Standard, and JIS (Japanese Industrial Standard)

Signal Names and Pin Assignment

Pin No. (in 9 Pins)	Abbreviations			Name
	RS-232	CCITT	JIS	
5	AB (GND)	102	SG	Signal Ground
3	BA (TXD)	103	SD	Transmit Data
2	BB (RXD)	104	RD	Receive Data
7	CA (RTS)	105	RS	Request To Send
8	CB (CTS)	106	CS	Clear To Send

● Allowable Combinations of Handshaking Methods

To assure data exchange via the RS-232 interface with a computer, both devices must follow a predetermined procedure (may be decided between both parties) by sending/receiving a series of electric signals. This series of exchanged signals is called a handshake. The handshake to be used may vary depending on the computer connected but must match the handshake performed by the computer. The following types of handshakes are possible with the CW120/121.

Possible Combinations of Handshaking Methods

Handshaking Method	Transmission Control (Control of Data Transmission to Computer)			Reception Control (Control of Data Reception to Computer)		
	Software Handshake	Hardware Handshake	No Handshake	Software Handshake	Hardware Handshake	No Handshake
	Quits Transmission upon Receipt of X-off; Restarts Transmission upon Receipt of X-on	Quits Transmission When CB (CTS) Becomes False; Restarts Transmission When It Becomes True			Sends X-off When Data in Reception Buffer Has Reached 3 Quarters of the Capacity; Sends X-on When Data in Reception Buffer Has Decreased to a Quarter of the Capacity	
OFF/OFF			○			○
XON/XON	○			○		
XON/RS	○				○	
CS/RS		○			○	

When Selecting OFF/OFF

- Transmission Control
No handshake is performed between the CW120/121 and computer. The CW120/121 handles the X-off and X-on codes from the computer as data and ignores CTS (CS in JIS).
- Reception Control
No handshake is performed between the CW120/121 and computer. After the reception buffer inside the CW120/121 becomes full, the overflowed data will be discarded. RTS (RS in JIS) is always true.

When Selecting XON/XON

- Transmission Control

A software handshake is performed between the CW120/121 and computer. When the CW120/121 receives the X-off code from the computer while transmitting data, the CW120/121 quits the transmission. Then, when it receives the X-on code next, it restarts the transmission. The CW120/121 ignores CTS (CS in JIS) from the computer.

- Reception Control

A software handshake is performed between the CW120/121 and computer. When the free space in the reception buffer decreases to 256 bytes, the CW120/121 transmits the X-off code to the computer. When the free space in the reception buffer increases to 768 bytes, the CW120/121 transmits the X-on code to the computer. RTS (RS in JIS) is always true.

When Selecting XON/RS

- Transmission Control

A software handshake is performed between the CW120/121 and computer. When the CW120/121 receives the X-off code from the computer while transmitting data, the CW120/121 quits the transmission. Then, when it receives the X-on code next, it restarts the transmission. The CW120/121 ignores CTS (CS in JIS) from the computer.

- Reception Control

A software handshake is performed between the CW120/121 and computer. When the free space in the reception buffer decreases to 256 bytes, the CW120/121 resets RTS (RS in JIS) to false. When the free space in the reception buffer increases to 768 bytes, the CW120/121 sets RTS to true.

When Selecting CS/RS

- Transmission Control

A software handshake is performed between the CW120/121 and computer. When the CW120/121 detects that CTS (CS in JIS) has become false while transmitting data, the CW120/121 quits the transmission. Then, when it detects that CTS has become true next, it restarts the transmission. The CW120/121 handles X-on/X-off codes sent from the computer as data.

- Reception Control

A software handshake is performed between the CW120/121 and computer. When the free space in the reception buffer decreases to 256 bytes, the CW120/121 resets RTS (RS in JIS) to false. When the free space in the reception buffer increases to 768 bytes, the CW120/121 sets RTS to true.

Precautions for Reception Control

While a CW120 or CW121 is controlling a data reception by a handshake, data may be sent from the computer even when the free space in the reception buffer is less than 256 bytes. In this case, regardless of whether a handshake for data reception is set, overflowed data will be discarded after the reception buffer becomes full. After free space appears in the reception buffer, data begins being stored to the buffer again.

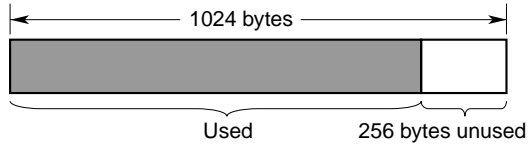

When performing a handshake, if the free space in the buffer has decreased to 256 bytes because the internal data transfer is too slow, the reception stops.

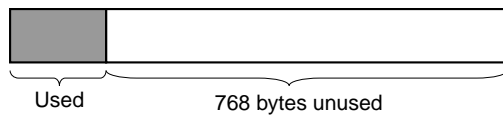

After the status above, when data was transfer internally and the free space in the buffer has increased to 768 bytes, the reception restarts.

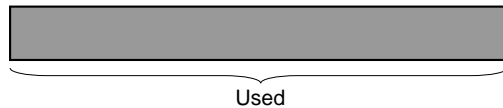

After the buffer has become full, regardless of whether a handshake for data receptions is set, overflowed data will not be stored and will be discarded.

TIP

When developing the computer's communication program, be careful about the data transmission rate so that the reception buffer either in the CW120/121 or in the computer will not become full.

11.2 RS-485

The RS-485 interface allows multiple CW120s and CW121s to be connected for remote monitoring.

- **RS-485 Interface Specifications**

Electromechanical specifications:	Compliant with EIA RS-485
Topology:	Multidrop
Communication method:	Half duplex
Synchronization:	Asynchronous
Baud rate:	1200, 2400, 4800, 9600, 19200, 38400 bps
Start bits:	Fixed to 1 bit
Data bits:	7 or 8 bits
Parity:	Odd, even, or none
Stop bits:	1 or 2 bits
Connector:	4 screw terminals (M3)
Hardware handshake:	Not available
Software handshake:	Not available
Error detection:	2-byte simple summation checksum
Reception buffer length:	1024 bytes
Maximum transmission distance:	1.2 km (when using shielded cable containing 2 twisted pairs of AWG 24 conductors)
Terminating resistor:	Approx. 120Ω built-in

● RS-485 Interface Connections

See the figure below for the wiring of RS-485 cables (in two-wire method) to connect to a personal computer. When using the RS-232 port of the PC, you need an RS-232/RS-485 converter.

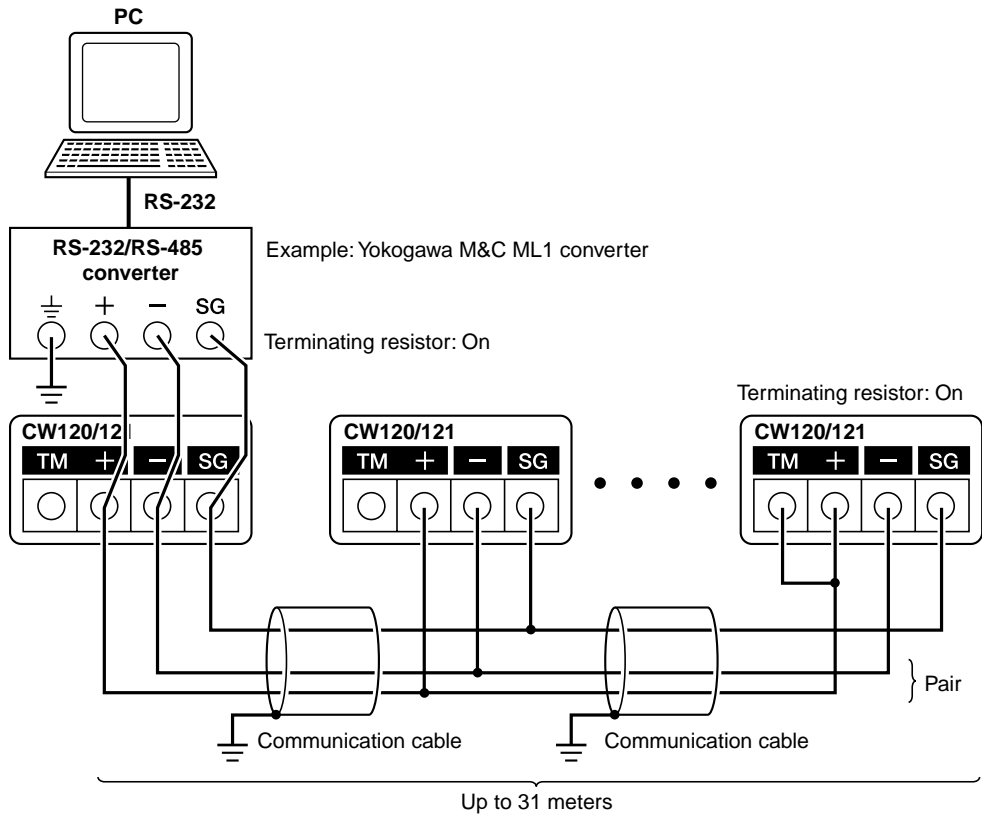

+: SD +(send data) / RD +(receive data)

-: SD -(send data) / RD -(receive data)

TM: Terminating resistor (short-circuiting with the + terminal switches on the terminating resistor).

SG: Signal ground

- **Device Address**

A device address needs to be assigned to each device on an RS-485 network. The device number set in each CW120/121 is identified as the device address.

SEE ALSO

For device address setting, see Section 7.2.1, "Setting Device Number," in Chapter 7, "Making Settings."



NOTE

The device number must be unique within the same system for correct communication.

- **Cable Used**

Use shielded cables containing 2 twisted pairs of AWG 24 conductors.



WARNING

Turn off the power when performing wiring for the terminals to avoid electric shock.

11.3 Data Format

The serial interface of the CW120/121 performs asynchronous transmission. In an asynchronous transmission, each character is carried in such a way that 7 or 8 data bits are preceded by a start bit and followed by a parity bit (optional), and 1 or 2 stop bits in order (see also the figure below).

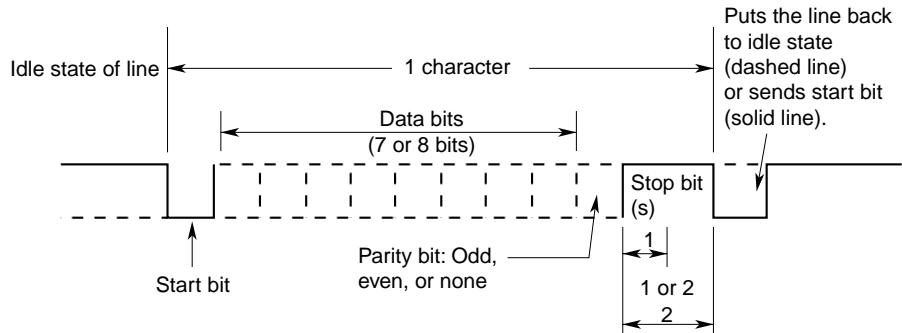

12.1 Convenient Functions

- **Clock**

The CW120/121 have a built-in clock, which is adjusted to the Japan standard time by default (factory setting). The date and time display formats are YY^yMM^mDD^d (YY is the last two digits of the year) and hh:mm:ss, as shown below. The accuracy of the clock is ± 100 ppm (typical).

Date and Time Setting Display

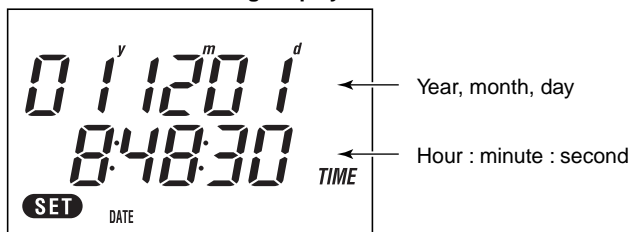

To change the date and time, use the setting screen.



SEE ALSO



For clock adjustment, see Section 7.2.6, “Changing Date and Time,” in Chapter 7, “Making Settings.”

- **Backlight for LCD**

You can turn on and off the backlight for the LCD by pressing the  key. When no key actions have been performed for 10 minutes or longer, the backlight is turned off automatically.

- **Key Lock**

Pressing the  key for three seconds or more locks the keys and causes the  (key lock) mark to appear on the screen.



To unlock, press the  key for three seconds or more. The keys are unlocked and the  (key lock) mark disappears from the screen.

TIP

Only the  key is usable during the key lock state.





12.1 Convenient Functions

● Clearance of All Settings and Data

Keep pressing the  and  keys and turn on the power switch, then all settings* will be initialized to the defaults, and the active electric energy, regenerative energy, elapsed time of integration, and data in the backup memory will be cleared.

* Except the date, time, and device number

Procedure

Hold down the  and  keys and turn on the power switch. Keep pressing the  and  keys until the model number appears on the screen.

Meter Actions

All LCD segments light up, and then the model number and version appear.

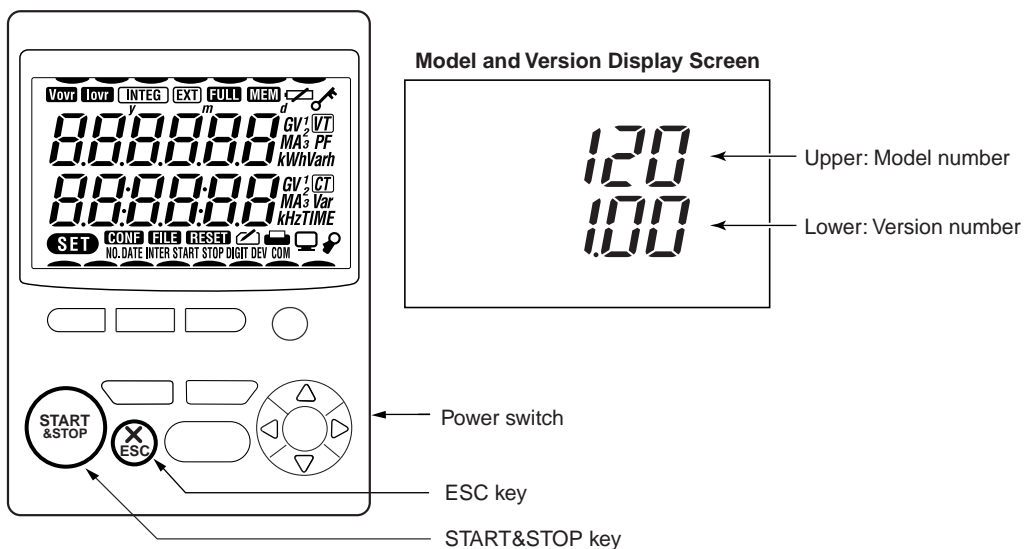

ALL CLEAR appears on the screen, and then the measurement screen is displayed.

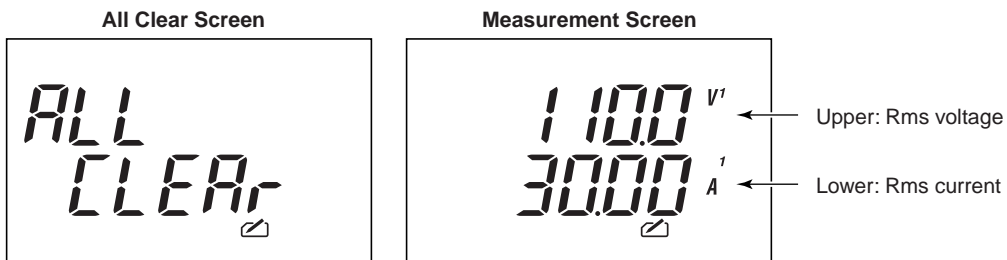

12.2 Using Optional Printer

Connecting an optional printer allows you to print measured data and settings. The printer can be connected only to a model with the RS-232 interface.

● Printer Specification

Model: Yokogawa M&C 97010 (Seiko Instruments DPU-414 printer)

Specifications:

Printing method:	Thermal serial dot printing
Number of columns to print:	80
Character presentation:	9x7 dots
Print speed:	52.5 mm/s
Paper width:	112 mm

● Connection

Use the RS-232 port.

Printer cable: Model 91010

1. Turn off the power to the printer. (The power lamp turns off.)
2. Connect the printer to the CW120/121 as shown in the figure below.

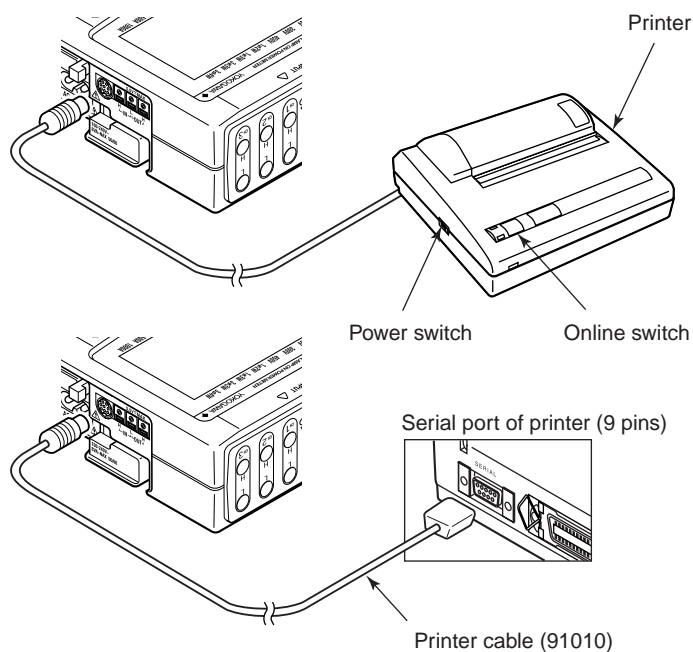

● Checking Printer Settings

1. Keep pressing the Online switch of the printer and turn on the power. Then, the printer settings are printed in English.
2. Check that the initial settings, as shown in parentheses inside the tables below, are left.

Printer Initial Settings (DIP Switch Settings)

DIP SW-1

Setting	Item	ON	OFF
1 (OFF)	Input type	Parallel	Serial
2 (ON)	Printing speed	High	Low
3 (ON)	Auto-loading	Enable	Disable
4 (OFF)	CR or CR/LF	CR/LF	CR
5 (ON)	Setting command	Enable	Disable
6 (OFF)	Printing density = 100%		
7 (ON)			
8 (ON)			

DIP SW-2

Setting	Item	ON	OFF
1 (OFF)	Print mode	40 columns	80 columns
2 (ON)	Backup of user-defined characters	Enable	Disable
3 (ON)	Character type	Normal	Special
4 (ON)	Character of zero	0	∅
5 (ON)	Encoding character set = Japanese		
6 (ON)			
7 (ON)			
8 (ON)			

DIP SW-3

Setting	Item	ON	OFF
1 (ON)	Data bits	8 bits	7 bits
2 (ON)	Parity (use/not use)	Not use	Use
3 (ON)	Parity (even/odd)	Odd	Even
4 (OFF)	Flow control	H/W BUSY	XON/XOFF
5 (OFF)	Baud rate = 9600 bps		
6 (ON)			
7 (ON)			
8 (ON)			

3. Turn off the power to the printer.

TIP

- For details of how to change the printer settings, see the documentation supplied with the printer.
- If the characters printed with the print mode selection in DIP SW-2 set to 80 columns (OFF) are too small to read, change the setting to 40 columns (ON).

- **Setting in CW120/121**

When using a printer, a setting needs to be made also in the CW120/121.

Procedure

With reference to Section 7.2.11, “Selecting Communication Device,” in Chapter 7, “Making Settings,” select a printer as the communication device.

Either a printer or personal computer can be connected via the RS-232 interface; select a printer when connecting to a printer.

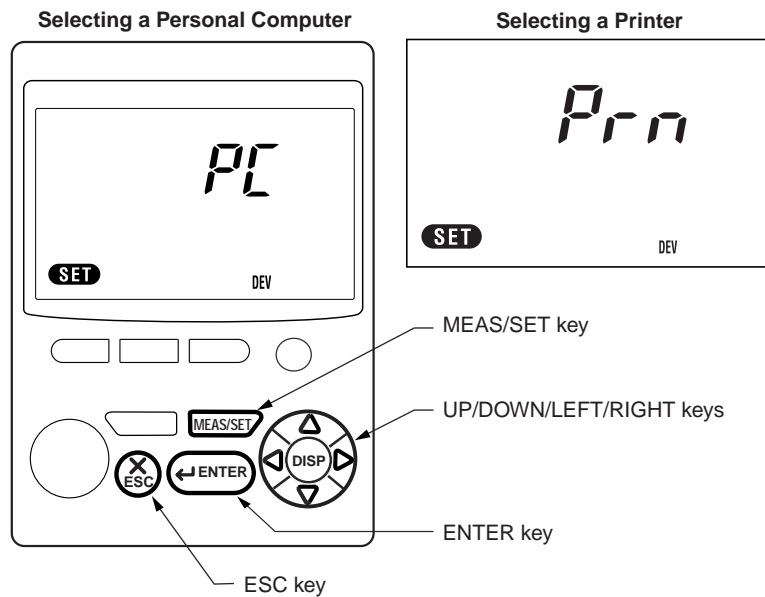

The  mark flashes on the screen during access to the printer.

12.2 Using Optional Printer

● Example of Printout

For instantaneous value measurement with 1(2W) wiring method

2001/12/01	11:00:00	—————→	Time of output
Integration start time		—————→	Integration start time
2001/12/01	10:00:00	—————→	
Elapsed time	1:00:00	—————→	Elapsed time of integration
Instantaneous values	V1	: 110.0	V
	I1	: 30.00	A
	P	: 2.850	kW
	Q	: 1.664	kVar
	PF	: 0.860	
Electric energies	F	: 50.00	Hz
	+Wh	: 889.20	KWh
	-Wh	: 0.00	KWh

P: Active power PF: Power factor
Q: Reactive power F: Frequency

SEE ALSO

For print data, see Appendix 3, "File Structures and Data Items Printed."

TIP



The printout above is an example when the print mode is set to 40 columns (ON) in DIP SW-2. See the DIP switch settings described on the page before the previous one.

13.1 Corrective Measures in Case of Failure

This section describes corrective measures in case a failure occurs with the CW120 or CW121.

If the meter does not operate properly after taking the corrective measures shown in the table below or any other failure that is not covered in this section occurs, contact the vendor from which you purchased the instrument.

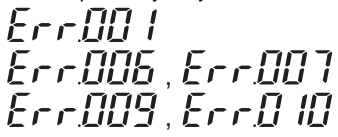
If an error code is displayed, refer to Section 13.2, "Error Codes."

Problem	Things to Check
1. The meter cannot be turned on.	<ul style="list-style-type: none"> • Check that the power cord is firmly plugged into the power outlet. • Check that you are not using power outside the allowable power supply voltage. • If neither of the above applies, the built-in fuse may have blown. Users are not authorized to replace a built-in fuse by themselves. Contact the vendor from which you purchased the instrument.
2. The settings are initialized when the power is turned on.	<ul style="list-style-type: none"> • If any one of the following error codes appears during the self-test after a power-on, the backup battery may have run flat. <p style="text-align: center;">  </p> <p>Users are not authorized to replace the backup battery by themselves. Contact the vendor from which you purchased the instrument. The life of the backup battery is about 10 years.</p>
3. Measurement values are erroneous.	<ul style="list-style-type: none"> • May be affected by noise. Check the installation environment. • Check that the measuring probes and the clamps are connected correctly. • Check that the ambient temperature and humidity are within the allowable ranges.
4. No key action is possible.	<ul style="list-style-type: none"> • Check that the  (key lock) mark is not displayed on the screen. • Some settings such as ranges can be changed only when the electric energy values and elapsed time of integration are zeros. Clear the integrated values.
5. Data cannot be saved to the backup memory.	<ul style="list-style-type: none"> • Turn the power off and back on again. In some cases, the initial self-test may correct the problem. • A power failure might have occurred when the memory was being accessed. Clear the backup memory contents via the setting screen. Note that this loses data saved in the backup memory.
6. The meter cannot be controlled through the serial interface.	<ul style="list-style-type: none"> • Check that the communication parameters are set correctly for both the computer and meter. • Check that the correct type of cable is used for the intended application.
7. An error code appears during the self-test.	<ul style="list-style-type: none"> • There is an error in the hardware. Contact the vendor from which you purchased the instrument.

13.2 Error Codes

Error Code	Description
<i>Err.001</i>	Error in SRAM with battery backup
<i>Err.002</i>	EEPROM has been initialized.
<i>Err.003</i>	Checksum error of EEPROM
<i>Err.004</i>	Illegal data in EEPROM
<i>Err.005</i>	Failure in writing to EEPROM
<i>Err.006</i>	RTC has been initialized.
<i>Err.007</i>	Error in RTC
<i>Err.008</i>	Error in PC card controller
<i>Err.009</i>	Settings have been initialized.
<i>Err.010</i>	Illegal settings
<i>Err.101</i>	Failure in writing to PC card
<i>Err.102</i>	Failure in reading from PC card
<i>Err.103</i>	Maximum number files in PC card exceeded
<i>Err.104</i>	A PC card other than a flash ATA card is inserted.
<i>Err.105</i>	PC card not yet formatted
<i>Err.106</i>	A PC card not supported is inserted.
<i>Err.107</i>	Failure in deleting a measured-value file
<i>Err.108</i>	Failure in saving the setting file
<i>Err.109</i>	Failure in loading the setting file
<i>Err.112</i>	PC card-related error other than above
<i>Err.200</i>	Data in internal memory exceeds the capacity.
<i>Err.201</i>	Failure in saving measured data within output interval
<i>Err.300</i>	The electric energy value or elapsed time of integration is not zero. No change to setting allowed.
<i>SEtErr</i>	The product of [rated power × VT ratio × CT ratio × 1.3] exceeds 9999 GW.

To return to the measurement screen from the error display, press any key.

13.3 Disposing the Product

Waste Electrical and Electronic Equipment (WEEE), Directive 2002/96/EC

This Product complies with the WEEE Directive (2002/96/EC) marking requirement.

The affixed product label (see below) indicates that you must not discard this electrical/electronic product in domestic household waste.

Product Category

With reference to the equipment types in the WEEE directive Annex 1, this product is classified as a "Monitoring and Control instrumentation" product.

To return unwanted products within the EU area, contact your local Yokogawa Europe B. V. office.

Do not dispose in domestic household waste.



14.1 Specifications of CW120/121

(1) Inputs

Item		Voltage Inputs	Current Inputs
Input type		Resistive potential division	Clamp sensing
Ratings (ranges)		150, 300, 450 V	96033 clamp-on probe: 5, 10, 20, 50 A 96030 clamp-on probe: 20, 50, 100, 200 A 96031 clamp-on probe: 50, 100, 200, 500 A 96032 clamp-on probe: 200, 500, 1000 A
Phase lines	CW120	Single-phase two wires, single-phase three wires, three-phase three wires, single-phase tow-wires ×2	
	CW121	Single-phase two wires, single-phase three wires, three-phase three wires, three-phase four wires, single-phase tow-wires ×2, single-phase tow-wires ×3	
Input resistance	CW120	Approximately 1.5 MΩ	Approximately 100 kΩ
	CW121	Approximately 1.3 MΩ	
Maximum allowed continuous input		495 Vrms	96033 clamp-on probe: 130 Arms 96030 clamp-on probe: 250 Arms 96031 clamp-on probe: 625 Arms 96032 clamp-on probe: 1000 Arms
A/D conversion		Simultaneous voltage/current input conversion, 12-bit resolution	

(2) Measurement Functions

Item		Voltage	Current/Active Power
Method		Digital sampling	
Frequency range		45 to 65 Hz (reciprocal method), detected from V1 input	
Crest factor		150 or 300 V range: 2 for rated input 450 V range: 1.56 for rated input	3 for rated input
Effective input range		10% to 110% of each rated range	
Display range	Lower limit	1.5 V for all rated ranges	0.4% of each range
	Upper limit	130% of each rated range for all ranges other than 450 V 110% of rated range for 450-V range	130% of each rated range
Temperature coefficient		±0.05% of rmg (range)/°C	±0.07% of rmg (range)/°C (including clamp-on probe)
Display update period		Approximately 1 second	

(3) Instantaneous Value Measurement

Measured parameters	Rms voltage (V), rms current (A), active power (W), frequency (Hz)
Measurement accuracy	At power factor = 1 (including clamp-on probes)
Voltage	±(0.3% rdg + 0.2% rng)
Current and active power	±(0.8% rdg + 0.4% rng) with probe 96030, 96031, or 96033 ±(1.2% rdg + 0.8% rng) with probe 96032
Frequency	±(0.1% rdg + 1 dgt)
Calculated parameters	Reactive power (Var), power factor
Calculation accuracy	(Value calculated from measurement) ± 1 dgt
Power factor effects	±1.0% rng $\cos\phi = \pm 0.5$ (relative to power factor 1) with probe 96030 ±2.0% rng $\cos\phi = \pm 0.5$ (relative to power factor 1) with probe 96031, 96032, or 96033
Reactive factor effects	±1.0% rng $\sin\phi = \pm 0.5$ (relative to reactive factor 1) with probe 96030 ±2.0% rng $\sin\phi = \pm 0.5$ (relative to reactive factor 1) with probe 96031, 96032, or 96033

(4) Equations

Rms voltage

$$V_{rms} = \sqrt{\frac{1}{T} \int_0^T v(t)^2 dt} = \sqrt{\frac{1}{T} \int_{t=0}^T v(t)^2 dt}$$

Rms current

$$A_{rms} = \sqrt{\frac{1}{T} \int_0^T i(t)^2 dt} = \sqrt{\frac{1}{T} \int_{t=0}^T i(t)^2 dt}$$

Active power

$$P = \frac{1}{T} \int_0^T v(t) \cdot i(t) dt = \frac{1}{T} \int_{t=0}^T v(t) \cdot i(t) dt$$

Single-phase three wires (1Ø3W) or three-phase three wires (3Ø3W): $\Sigma P = P1 + P2$
 Three-phase four wires (3Ø4W): $\Sigma P = P1 + P2 + P3$
 v(i), i(t): Input signals
 T: One cycle of input signal

Reactive power and power factor

	Reactive Power (Note 1)	Apparent Power	Power Factor (Note 2)
1Ø2W	$Q = \sqrt{((VA)^2 - P^2)}$	$VA = V \times A$	P / VA
1Ø3W	$Q_i = \frac{\sqrt{((VA_i)^2 - P_i^2)}}{i=1, 2}$ $\Sigma Q = Q_1 + Q_2$	$VA_i = V_i \times A_i$ $i=1, 2$ $\Sigma VA = VA_1 + VA_2$	$\Sigma P / \Sigma VA$
3Ø3W	$Q_i = \frac{\sqrt{((VA_i)^2 - P_i^2)}}{i=1, 2}$ $\Sigma Q = Q_1 + Q_2$	$VA_i = V_i \times A_i$ $i=1, 2$ $\Sigma VA = \sqrt{3}/2(VA_1 + VA_2)$	
3Ø4W	$Q_i = \frac{\sqrt{((VA_i)^2 - P_i^2)}}{i=1, 2, 3}$ $\Sigma Q = Q_1 + Q_2 + Q_3$	$VA_i = V_i \times A_i$ $i=1, 2, 3$ $\Sigma VA = VA_1 + VA_2 + VA_3$	
Calculation range	The rated value depends on the voltage and current ranges.	The rated value depends on the voltage and current ranges.	-1 to +1
Display resolution	Same as active power	Only calculated internally; not displayed nor saved as data.	±1.000

Note 1: In the case of distorted waves, there may be differences from other measuring instruments that are based on different measurement principles.

Note 2: The polarity each phase determined by the reactive power meter method is multiplied and the polarity is displayed.

Note 3: In the case of three-phase 3-wire and unbalanced inputs, there may be differences from other measuring instruments that are based on different measurement principles, or wiring.

(5) Electric Energy Measurement

Measured parameters Active electric energy, regenerative electric energy (not displayed, only saved as data)

Measurement accuracy Measurement accuracy for active power ±1 dgt (with standard settings)

Integration function settings

Start/stop Manual, specified time, external trigger (remote control)

Output interval Can be selected from 1, 2, 5, 10, 15, and 30 seconds, 1, 2, 5, 10, 15, and 30 minutes, and 1 hour.

Display digits Automatic decision based on the rated power. The maximum resolution can be set.

14.1 Specifications of CW120/121

(6) Display Functions

Display screen Backlit segmented LCD
 Maximum display digits 4 digits for data other than electric energy
 6 digits for electric energy

Ranges (ratings)

Voltage Range	Phase Lines	96032 Probe (200–1000 A)							
		96031 Probe (50–500 A)				96030 Probe (20–200 A)			
		96033 Probe (5–50 A)							
		5.000A	10.00A	20.00A	50.00A	100.0A	200.0A	500.0A	1.000kA
150.0 V	1 ϕ 2W								
	1 ϕ 2W \times 2	750.0 W	1.500 kW	3.000 kW	7.500 kW	15.00 kW	30.00 kW	75.00 kW	150.0 kW
	1 ϕ 2W \times 3*								
	1 ϕ 3W	1.500 kW	3.000 kW	6.000 kW	15.00 kW	30.00 kW	60.00 kW	150.0 kW	300.0 kW
	3 ϕ 3W	1.500 kW	3.000 kW	6.000 kW	15.00 kW	30.00 kW	60.00 kW	150.0 kW	300.0 kW
	3 ϕ 4W*	2.250 kW	4.500 kW	9.000 kW	22.50 kW	45.00 kW	90.00 kW	225.0 kW	450.0 kW
300.0 V	1 ϕ 2W								
	1 ϕ 2W \times 2	1.500 kW	3.000 kW	6.000 kW	15.00 kW	30.00 kW	60.00 kW	150.0 kW	300.0 kW
	1 ϕ 2W \times 3*								
	1 ϕ 3W	3.000 kW	6.000 kW	12.00 kW	30.00 kW	60.00 kW	120.0 kW	300.0 kW	600.0 kW
	3 ϕ 3W	3.000 kW	6.000 kW	12.00 kW	30.00 kW	60.00 kW	120.0 kW	300.0 kW	600.0 kW
	3 ϕ 4W*	4.500 kW	9.000 kW	18.00 kW	45.00 kW	90.00 kW	180.0 kW	450.0 kW	900.0 kW
450.0 V	1 ϕ 2W								
	1 ϕ 2W \times 2	2.250 kW	4.500 kW	9.000 kW	22.50 kW	45.00 kW	90.00 kW	225.0 kW	450.0 kW
	1 ϕ 2W \times 3*								
	1 ϕ 3W	4.500 kW	9.000 kW	18.00 kW	45.00 kW	90.00 kW	180.0 kW	450.0 kW	900.0 kW
	3 ϕ 3W	4.500 kW	9.000 kW	18.00 kW	45.00 kW	90.00 kW	180.0 kW	450.0 kW	900.0 kW
	3 ϕ 4W*	6.750 kW	13.50 kW	27.00 kW	67.50 kW	135.0 kW	270.0 kW	675.0 kW	1.350 MW

* Only for CW121

(7) Communication Functions

Electrical specifications Compliant with EIA RS-232 or EIA RS-485
 Synchronization Asynchronous
 Baud rate 1200, 2400, 4800, 9600, 19200, 38400 bps

(8) PC Card Interface

Slots One Type II PC card slot
 Applicable cards Flash ATA memory card
 Applications Saving measured data, saving and loading settings

(9) Wiring Error Check Functions

Check items	Existence of input voltages
	Frequency range
	Voltage phase sequence
	Existence of input currents
	Current-sensing clamp directions

(10) Scaling Function

The VT ratio and CT ratio can be set.

Setting ranges	VT ratio: 1 to 10000
	CT ratio: 1 to 10000 in 0.01 increments

(11) External Control Input/Output (provided only with model having RS-232 interface)

Can be used for remote start and end of integration for electric energy measurement.

External control input	TTL level or voltage-free contact
External control output	TTL level or contact

(12) Other Functions

Clock (accuracy: ± 100 ppm, typical), key-lock, system resetting

(13) General Specifications

Applicable locations:	Indoors, altitude of 2000 m or lower
Operating temperature and humidity ranges	0°C to 50°C, 5 to 85% RH (no condensation)
	When it is applied to UL.
	0°C to 40°C, 5 to 85% RH (no condensation)
	Maximum relative humidity 80% RH for temperature up to 31°C decreasing linearly to 50% RH relative humidity at 40°C.
Storage temperature and humidity ranges	-20°C to 60°C, 90% RH or less (no condensation)
Insulation resistance	50 M Ω or more at 500 V DC
	between voltage input terminals (short-circuited) and casing;
	between voltage input terminals (short-circuited) and current/communication/external control input/output terminals (short-circuited);
	between power line and casing; and
	between power line and current/communication/external control input/output terminals (short-circuited)

14.1 Specifications of CW120/121

Withstanding voltage	5550 V AC for 1 minute between voltage input terminals (short-circuited) and casing; 3220 V AC for 1 minute between voltage input terminals (short-circuited) and current/communication/external control input/output terminals (short-circuited); and 2300 V AC for 1 minute between power line and casing, and between power line and current/communication/external control input/output terminals (short-circuited)
Power supply	100 to 240 V AC \pm 10%, 50/60 Hz
Power consumption	Maximum 8 VA
External magnetic field effects	Within accuracy range at 400 A/m
Dimensions (W×H×D)	Approximately 117 × 161 × 51 mm
Weight	Approximately 0.6 kg
Terminals	
Voltage inputs	CW120: 3 jacks for banana plugs (safety terminals) CW121: 4 jacks for banana plugs (safety terminals)
Current inputs (H/L)	CW120: 2 pair jacks for banana plugs (safety terminals) CW121: 3 pair jacks for banana plugs (safety terminals)
External control input/output	
RS-485	3 screw-less terminals (H/L/H) 4 M3 screw terminals (+/-/SG/TM)
Connectors	
RS-232	Miniature DIN 8 pins
AC power supply	2 pins
Standard accessories	3 (CW120) or 4 (CW121) voltage-sensing probes Power cord User's Manual Simple setting software

Safety standards:	<p>Compliant with EN61010-1, EN61010-2-031 Measurement category CAT.III (Max. input voltage: 600 Vrms) Pollution degree 2 Compliant with UL3111-1 First Edition, CAN C22-2 No.1010.1-92</p> <ul style="list-style-type: none">• Voltage measurement circuit: Installation category III (Max. input voltage: 600 Vrms)• Power Supply Installation category II (Max. input voltage: 264 Vrms) Pollution degree 2
EMC (emission):	<p>Compliant with EN55011, Group 1, Class A; EN61326; EN61000-3-2; EN61000-3-3 The user must implement adequate measures to prevent influences from radio noise emission if necessary. Conditions of cable Measured input When using “Voltage Input Probes” and “Current-sensing Clamps” supplied with the CW120. External control input and output Shield cable: less than 3m</p>
EMC (immunity):	<p>Compliant with EN61326 Performance criterion under immunity test environments: B (self-returnable performance deterioration)</p>

14.1 Specifications of CW120/121

(14) CW120/121 Exterior

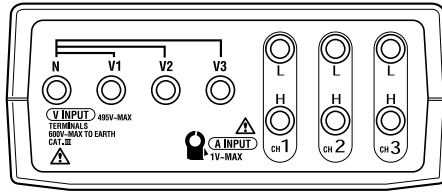

Unit: mm (approx. inches)

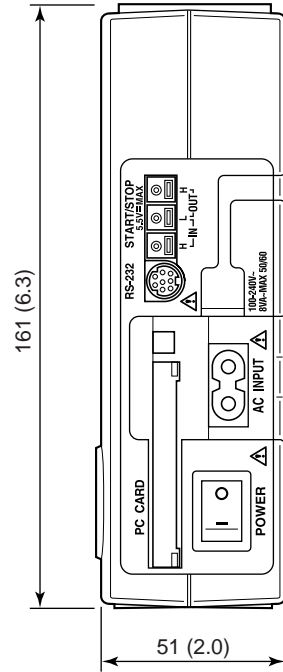
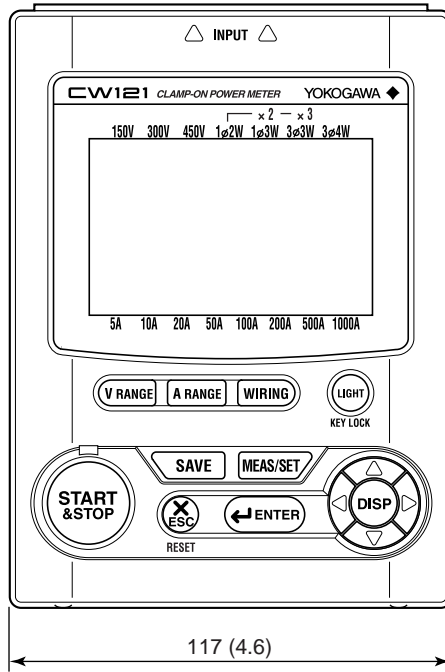

Note: This figure shows the CW121, but there is no difference in exterior from the CW120.

14.2 Specifications of Clamp-on Current Probes

(1) 96030 and 96031 Clamp-on Current Probes

Item	96030 96030/D (UL)	200A	96031 96031/D (UL)	500A
Measurement range	0 to 200 Arms AC (300 Apk)		0 to 500 Arms AC (750 Apk)	
Output voltage	0 to 0.5 Vrms AC (2.5 mV/A)		0 to 0.5 Vrms AC (1 mV/A)	
Accuracy	Amplitude	$\pm 1.5\%$ of rdg ± 0.4 mV (20 Hz to 45 Hz) $\pm 0.5\%$ of rdg ± 0.1 mV (45 Hz to 66 Hz) $\pm 0.8\%$ of rdg ± 0.2 mV (66 Hz to 1 kHz) $\pm 2.0\%$ of rdg ± 0.4 mV (1 kHz to 20 kHz)		$\pm 1.5\%$ of rdg ± 0.4 mV (20 Hz to 45 Hz) $\pm 0.5\%$ of rdg ± 0.1 mV (45 Hz to 66 Hz) $\pm 0.8\%$ of rdg ± 0.2 mV (66 Hz to 1 kHz)
	Phase	$\pm 0.5^\circ$ (45 Hz to 1 kHz)		$\pm 1^\circ$ (45 Hz to 1 kHz)
	Under the conditions of the temperature at $23^\circ\text{C} \pm 5^\circ\text{C}$, humidity at 35 to 75% RH, with sine wave input			
Temperature coefficient	$\pm 0.05\%/^\circ\text{C}$ in ranges of 5-18°C and 18-40°C			
Maximum allowed current	250 Arms AC (45 Hz to 1 kHz)		625 Arms AC (45 to 400 Hz)	
Output impedance	Approximately $6\ \Omega$		Approximately $2.4\ \Omega$	
External magnetic field effects	0.1 A equivalent or less (at 400 A/m, 50/60 Hz)		0.2 A equivalent or less (at 400 A/m, 50/60 Hz)	
Conductor position effects	$\pm 0.5\%$ (at 20 to 200 A, 45 Hz to 1 kHz)		$\pm 0.5\%$ (at 50 to 500 A, 45 Hz to 1 kHz)	
The RATED circuit-to-earth voltage	600 Vrms AC maximum			
Withstanding voltage	3.7 kVrms AC for 1 minute (core-to-casing, and core-to-output)			
Measurable conductor diameter	30 mm diameter maximum			
Operating temperature and humidity ranges	5° to 40°C, 35 to 80% RH (no condensation)			
Storage temperature and humidity ranges	-20° to 60°C, 90% RH or less (no condensation)			
Environmental conditions	Indoors, altitude of 2000 m or lower			
Dimensions (W × H × D)	Approximately 73 × 130 × 30 mm			
Weight	Approximately 300 g			
Output terminals	Banana plugs (safety terminals)			
Output cable length	Approximately 3 meters			
Standard accessories	One User's Manual, ring markers (4 colors × 2 each, L4007MG)			

14.2 Specifications of Clamp-on Current Probes

Safety standards:	Compliant with EN61010-1, EN61010-2-032 <ul style="list-style-type: none">• Measurement category II (The RATED circuit-to-earth voltage: 600 Vrms)• Measurement category III (The RATED circuit-to-earth voltage: 300 Vrms)• Pollution degree 2 When the current Clamp is 96030/D or 96031/D. UL3111-1 First Edition, UL3111-2-032 First Edition, CAN C22-2 No.1010.1-92 <ul style="list-style-type: none">• Installation category III (The RATED circuit-to-earth voltage: 600 Vrms)• Pollution degree 2
-------------------	--

EMC (emission):	Compliant with EN55011, Group 1, Class A; and EN61326 These products are goods in Class A (designed for industrial environments). For home use, the user must implement adequate measures to prevent influences from radio noise emission.
-----------------	---

EMC (immunity):	Compliant with EN61000-6-2, EN61326 Effect on measurement input under immunity environment: ±20% of range or less
-----------------	---

Dimensions of 96030 and 96031 Clamp-on Current Probes

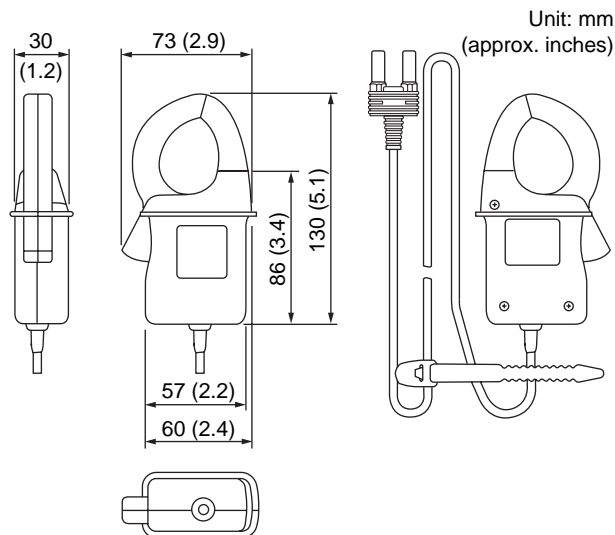

(2) 96032 Clamp-on Current Probe

Item		96032 (Max. 1000-A Range)
Measurement range		0 to 1000 Arms AC (1414 Apk) for 5 minutes
Output voltage		0 to 0.25 Vrms AC (0.25 mV/A)
Accuracy	Amplitude	$\pm 1.0\%$ of rdg ± 0.2 mV (45 Hz to 66 Hz)
	Phase	$\pm 1.0^\circ$ (for 50 A or higher, 45 Hz to 66 Hz)
		Under the conditions of the temperature at $23^\circ\text{C} \pm 5^\circ\text{C}$, humidity at 35 to 75% RH, with sine wave input
Temperature coefficient		0.05% of full scale/ $^\circ\text{C}$ in ranges of 5°C to 40°C
Maximum allowed current		1000 Arms AC for 5 minutes, 700 Arms AC continuous (45 Hz to 66 kHz)
Output impedance		Approximately 100Ω (maximum)
External magnetic field effects		0.5 A equivalent or less (at 400 A/m, 50/60 Hz)
Conductor position effects		$\pm 0.5\%$ (at 200 to 1000 A, 45 Hz to 66 kHz)
The RATED circuit-to-earth voltage		600 Vrms AC maximum
Withstanding voltage		2.2 kVrms AC for 1 minute (core-to-casing, and core-to-output)
Measurable conductor diameter		65 mm diameter maximum, 65×75 mm busbar maximum
Operating temperature and humidity ranges		5° to 40°C , 35 to 80% RH (no condensation)
Storage temperature and humidity ranges		-20° to 60°C , 90% RH or less (no condensation)
Environmental conditions		Indoors, altitude of 2000 m or lower
Dimensions (W \times H \times D)		Approximately $100 \times 172.5 \times 32$ mm
Weight		Approximately 500 g
Output terminals		Banana plugs (safety terminals)
Output cable length		Approximately 3 meters
Standard accessories		One User's Manual, ring markers (4 colors \times 2 each, L4007MG)

Dimensions of 96032 Clamp-on Current Probe

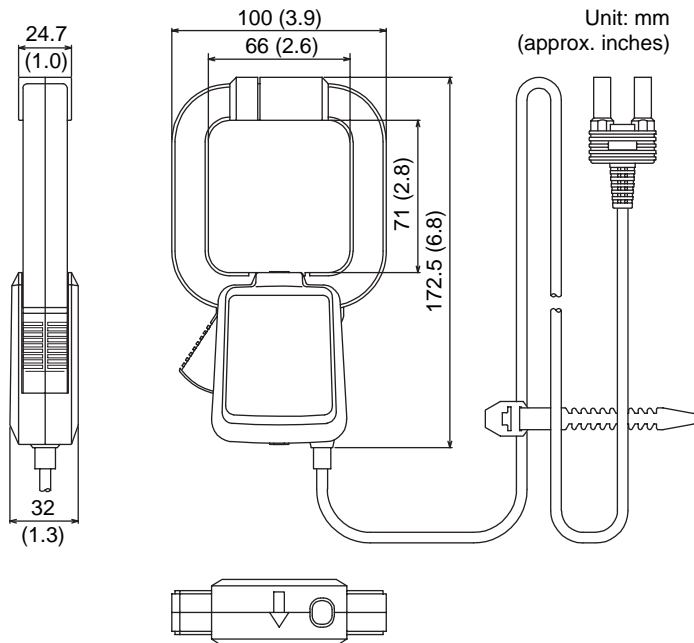

14.2 Specifications of Clamp-on Current Probes

(3) 96033 Clamp-on Current Probe

Item		96033 (Max. 50-A Range)
Measurement range		0 to 50 Arms AC
Output voltage		0 to 0.5 Vrms AC (10 mV/A)
Accuracy	Amplitude	$\pm 1.0\%$ of rdg ± 0.3 mV (20 Hz to 45 Hz) $\pm 0.5\%$ of rdg ± 0.1 mV (45 Hz to 66 Hz) $\pm 0.8\%$ of rdg ± 0.2 mV (66 Hz to 1 kHz) $\pm 1.0\%$ of rdg ± 0.3 mV (1 kHz to 5 kHz) $\pm 3.0\%$ of rdg ± 0.4 mV (5 kHz to 20 kHz)
	Phase	$\pm 1.0^\circ$ (for 1 to 50 A, 45 Hz to 1 kHz)
		Under the conditions of the temperature at $23^\circ\text{C} \pm 5^\circ\text{C}$, humidity at 35 to 75% RH, with sine wave input
Temperature coefficient		0.05% of full scale/ $^\circ\text{C}$ in ranges of 0°C to 50°C
Maximum allowed current		130 Arms AC (45 Hz to 1 kHz)
Output impedance		Approximately 18Ω
External magnetic field effects		0.1 A equivalent or less (at 400 A/m, 50/60 Hz)
Conductor position effects		$\pm 0.5\%$ (at 1 to 50 A, 45 Hz to 1 kHz)
The RATED circuit-to-earth voltage		300 Vrms AC maximum
Withstanding voltage		3.7 kVrms AC for 1 minute (core-to-casing, and core-to-output)
Measurable conductor diameter		18 mm diameter maximum
Operating temperature and humidity ranges		0° to 50°C , 5 to 85% RH (no condensation)
Storage temperature and humidity ranges		-20° to 60°C , 90% RH or less (no condensation)
Environmental conditions		Indoors, altitude of 2000 m or lower
Dimensions (W \times H \times D)		Approximately $52 \times 106 \times 25$ mm
Weight		Approximately 220 g
Output terminals		Banana plugs (safety terminals)
Output cable length		Approximately 3 meters
Standard accessories		One User's Manual, ring markers (4 colors \times 2 each, L4007MG)

Safety standards:	Compliant with EN61010-1, EN61010-2-032 <ul style="list-style-type: none"> • Measurement category III (The RATED circuit-to-earth voltage: 300 Vrms) • Pollution degree 2
EMC (emission):	Compliant with EN55011, Group 1, Class A; and EN61326 These products are goods in Class A (designed for industrial environments). For home use, the user must implement adequate measures to prevent influences from radio noise emission.
EMC (immunity):	Compliant with EN61326 Effect on measurement input under immunity environment: $\pm 20\%$ of range or less

Dimensions of 96033 Clamp-on Current Probe

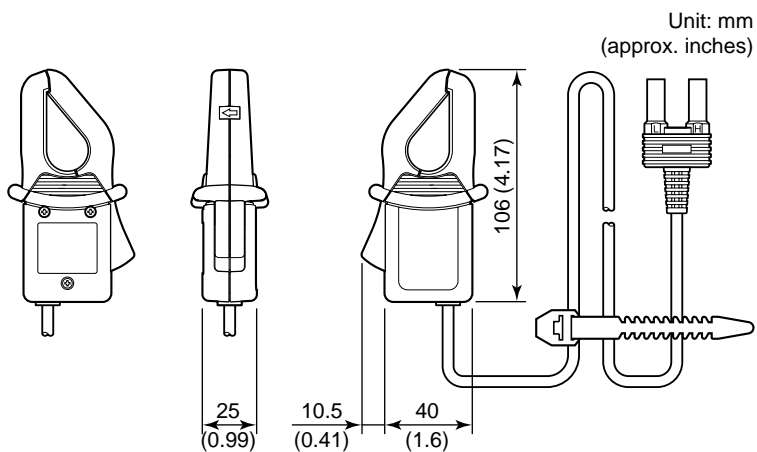

Appendix 1. Circuit Block Diagram

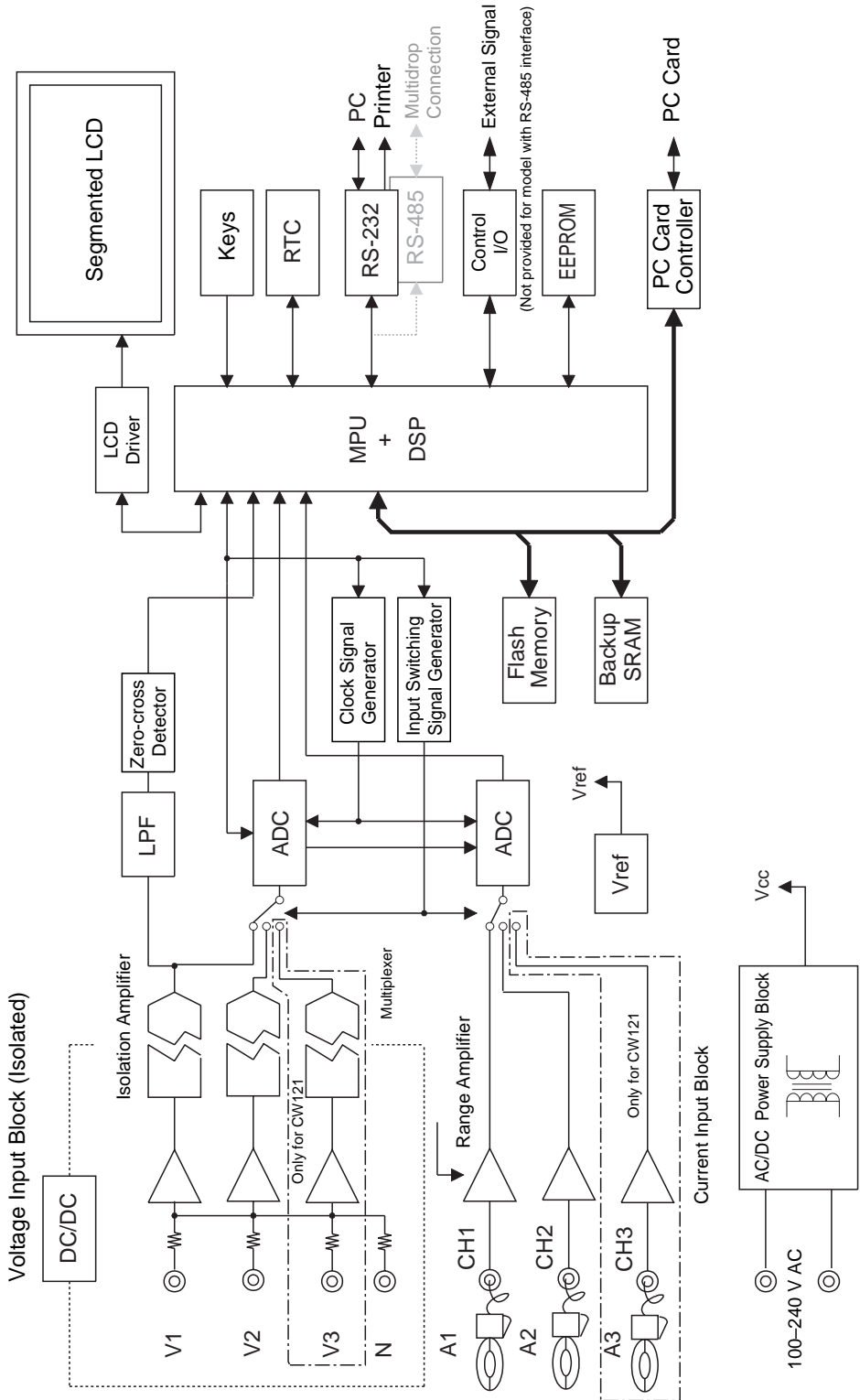

Appendix 2. Communication Commands

1. Commands	App2-2
1.1 Messages	App2-2
1.2 Commands	App2-4
1.3 Response	App2-5
1.4 Data	App2-6
1.5 Messages on RS-485	App2-8
1.6 Communication Commands	App2-9
1.7 Detailed Description of Communication Commands	App2-12
1.7.1 COMMunicate Group	App2-12
1.7.2 SYSTem Group	App2-13
1.7.3 INTEgrate Group	App2-15
1.7.4 MEASure Group	App2-17
1.7.5 STATus Group	App2-17
1.7.6 MEMORy Group	App2-18
1.7.7 CARD Group	App2-18
1.7.8 Common Group	App2-19
2. Error Messages	App 2-20
3. Command Effectiveness Tables	App 2-24

1. Commands

1.1 Messages

Messages

Communication between the CW120 clamp-on power meter and a personal computer is carried out in blocks of data called messages. Messages sent by the personal computer to the CW120 are called program messages, and messages received by the personal computer from the CW120 are called response messages.

If a received program message contains a query command (a command which requests a response), the CW120 returns a response message. A single response message is always returned in response to a single program message.

Program Messages

As explained above, program messages are sent from the personal computer to the CW120. The format of a program message is shown below.

```
<Program message unit>;<program message unit>;  
... ;<program message unit><PMT>
```

<Program message unit>

A program message is a train of zero or more program message units; each unit corresponds to one command. The CW120 executes the commands in the order that they are received. Each program unit is separated by a semicolon (;).

<PMT>

PMT is a terminator used to terminate each program message. For the CW120, the terminator is a string of CR (ASCII-code "0DH") and LF (ASCII-code "0AH") characters.

● Format of Program Message Unit

The format of a program message unit is shown below.

```
<Program header> space <program data>
```

<Program header>

The program header contains the command type.

<Program data>

If there are certain conditions for executing a command, they are appended as program data. The program data follows the program header and is separated from the program header by a space (ASCII-code "20H"). If there are multiple data, they are separated by a comma (,).

Response Messages

As explained earlier, response messages are sent by the CW120 to the personal computer. The format of a response message is shown below.

```
<Response message>;<response message>;  
... ;<response message><RMT>
```

<Response message unit>

A response message is a train of one or more response message units; each response message unit corresponds to one response. Each response unit is separated by a semicolon (;).

<RMT>

RMT is a terminator used to terminate each response message. For the CW120, the terminator is a string of CR (ASCII-code "0DH") and LF (ASCII-code "0AH") characters.

● Format of Response Message Unit

The format of a response message unit is shown below.

```
<Response header> space <response data>
```

<Response header>

It is possible to program the CW120 so a response header precedes the response data. Response data is separated from the header by a space.

<Response data>

Response data contains the contents of the response. If there are multiple data, they are separated by a comma (,).

If a program message contains multiple queries, the responses are made in the same order as the queries. For most queries, the CW120 returns only one response message unit. The CW120 returns more than one response message unit to some queries, however. The first query is always answered with the first response message unit. However, the nth query does not always agree with the nth response message unit. To be certain that the given response message unit corresponds to the correct query, place one query in each program message.

Precautions when Exchanging Messages

- You can send the next message at any time, if the previously sent message did not contain any queries.
- If the previous program message contained a query, you cannot send the next message until the entire response message is received. If you send the next program message before any response message is received or after only part of a message is received, an error will occur. The response message that was not received at all or completely will be discarded.
- If the personal computer tries to receive a response message when there is none, an error will occur. An error also occurs if the personal computer tries to receive a response message before it finishes sending the program message.

- If a program message contains multiple units and some of the units are incomplete, the CW120 will pick up the incomplete units and attempt to execute them. These attempts may not always be successful, however. In addition, even if the program message contained queries, they may not always be responded to.

Deadlock

The CW120 has receive and send buffers for storing program and response messages. Each buffer has a capacity of at least 1024 bytes. (The number of bytes available will vary depending on the operating condition of the CW120.) If both buffers become full at the same time, the CW120 becomes inoperative. This condition is called a deadlock. To resume normal operation, discard response messages. A deadlock will not occur, however, if the size of the program message including the PMT is kept below 1024 bytes. A deadlock never occurs if the program message does not contain any query.

1.2 Commands

Commands

There are two types of command (program header) that can be sent from the personal computer to the CW120. They differ in the format of their program headers.

Common Command Header

Commands defined in IEEE 488.2-1987 are called common commands. The header format of a common command is shown below. An asterisk (*) always precedes a common command.

*<Mnemonic>?

*<Mnemonic>

Compound Header

Commands other than common commands, that are dedicated to the CW120, are classified and arranged in a hierarchy according to their functions. The format of a compound header is shown below. A colon (:) is used to specify a lower-level header.

:<mnemonic>: <mnemonic>: ... :<mnemonic>?

:<mnemonic>: <mnemonic>: ... :<mnemonic>

Simple Header

A simple header is a functionally independent command with no hierarchical structure. The format of a simple header is shown below.

:<mnemonic>?

:<mnemonic>

When Concatenating Commands

● Command Group

A group of commands which share the same compound header is called a command group. A command group may contain sub-groups.

Example: Command group relating to electric energy measurement
INTEgrate?
INTEgrate:START:TIME
INTEgrate:STOP:TIME
INTEgrate:STORe?

● When Concatenating Commands of the Same Group

The CW120 stores information on which hierarchical level the command currently being executed belongs to, and performs analysis on the assumption that the next command will also belong to the same level. Therefore, you may omit the header of the next command if the two commands belong to the same group.

Example: INTEgrate:STORe:FILE FILE0;START:TIME 1999,1,1,0,0<PMT>

● When Concatenating Commands of Different Groups

Include a colon (:) before the header, if the following command does not belong to the same group as the preceding command.

Example: SYSTem:CURRent:AUTO ON;
:INTEgrate:START:EXECute<PMT>

● When Concatenating Common Commands

Common commands defined in IEEE 488.2-1987 are independent of hierarchy. A colon (:) is not necessary before a common command.

Example: INTEgrate:STORe:FILE FILE0;*CLS;
START:TIME 1999,1,1,0,0<PMT>

● When Separating Commands with <PMT>

If a terminator is used to separate two commands, each command is a separate message. Specify the command header for each command even when the commands from the same command group are being concatenated.

Higher-level Query

A query with a question mark (?) on the topmost-level command in a group is called a higher-level query. Executing a higher-level query allows all the setup data items available with the group to be received at one time.

A response to a higher-level query can be sent exactly as it was received, as a program message to the CW120.

Rules of Header Interpretation

The CW120 interprets a received header according to the following rules.

- Mnemonics are not case-sensitive.

Example: SYSTem can also be written as system or System.

- The lower-case portion of a header can be omitted.

Example: SYSTem can also be written as SYSTE or SYST.

- The question mark (?) at the end of the header denotes a query. You cannot omit the question mark.

Example: SYSTem? cannot be abbreviated to anything shorter than SYST?.

- If the x (numeric value) at the end of the header is omitted, it is assumed to be "1".

Example: If CHANnel<x> is written as CHAN, this represents CHAN1.

1.3 Response

Upon receiving a query from the personal computer, the CW120 returns a response message to the computer. A response message is sent in either of the following forms.

- Response consisting of a header and data
If the response can be used directly as a program message, the response message will include the command header.
- Response consisting of data only
If the response cannot be used directly as a program message (i.e., the response is a query-only command), the response message will include only the data. However, some query-only commands will include a header.

● When you want a response without a header

You can have the header removed from a response that has a header and data by using the COMMunicate:HEADer command.

● Abbreviated form

Usually, the lower-case letter portion of a response header is abbreviated when it is returned. You can have it not abbreviate the lower-case letters by using the COMMunicate:VERBose command.

1.4 Data

Data

The data section comes after the header. A space must be included between the header and the data. The data contains conditions and values. It is classified as follows.

Data	Description
<Decimal>	Value expressed as a decimal number
<Voltage>, <Current>, <Frequency>	Value with a physical dimension
<Character data>	Specified character string (mnemonic). Select from { }.
<Boolean>	Indicates ON/OFF. Specify with [ON], [OFF], or a value.
<Character string data>	Arbitrary character string
<Filename>	Denotes a file name.

<Decimal>

<Decimal> indicates a value expressed as a decimal number, as shown in the table below. Decimal values are given in the NR form specified in ANSI X3.42-1975.

Symbol	Description	Example
<NR1>	Integer	125 -1 +1000
<NR2>	Fixed-point number	125.0 -.90 +00.1
<NR3>	Floating-point number	125.0E+0 -9E-1 +.1E4
<NRf>	Any of the forms <NR1> to <NR3> is allowed.	

- <NRf> represents the case when any of the forms <NR1> to <NR3> can be used. The CW120 accepts decimal values from the personal computer in any form.
- The form, among <NR1> to <NR3>, used for the response message is predetermined for each query. The same form is used irrespective of whether the value is large or small.
- When using <NR3>, the "+" after the "E" can be omitted, but the "-" cannot.
- If a value outside the setting range is specified, the closest valid value will be used.
- If the value specified is beyond the precision of the CW120, the value will be rounded.

<Voltage>, <Time>, <Frequency>

<Voltage>, <Time> and <Frequency> indicate decimal values which have a physical dimension. <Multiplier> or <Unit> can be attached to the <NRf> form. The values are specified in any of the following forms.

Form	Example
<NRf><Multiplier><Unit>	5MV
<NRf><Unit>	5E-3V
<NRf><Multiplier>	5M
<NRf>	5E-3

<Multiplier>

The following multipliers are available.

Symbol	Word	Description
EX	Exa	10 ¹⁸
PE	Peta	10 ¹⁵
T	Tera	10 ¹²
G	Giga	10 ⁹
MA	Mega	10 ⁶
K	Kilo	10 ³
M	Mili	10 ⁻³
U	Micro	10 ⁻⁶
N	Nano	10 ⁻⁹
P	Pico	10 ⁻¹²
F	Femto	10 ⁻¹⁵

<Unit>

The following units are available.

Symbol	Word	Description
V	Volt	Voltage
A	Ampere	Current
HZ	Hertz	Frequency
KHZ	Kilohertz	Frequency

- <Multiplier> and <Unit> are not case-sensitive.
- "U" is used to indicate "μ".
- "MA" is used for Mega (M) to distinguish it from Mili. If used for current, however, "MA" is interpreted as Milliampere. To refer to Megaampere, write as "MAA".
- If both <Multiplier> and <Unit> are omitted, the default unit (V, A or Hz) will be used.

- Response messages are always expressed in the <NR3> form. The default unit is used without the <Multiplier> or the <Unit>.

<Character Data>

<Character data> is a data of specific characters (mnemonic). It is mainly used to indicate options and is chosen from character strings given in { }. For interpretation rules, see "Rules of Header Interpretation."

Form	Example
{V1 V2 V3}	V1

- As with the header, the COMMunicate:VERBoSe command can be used to select a full response or an abbreviated response.
- The COMMunicate:HEADer command has no effect on <character data>.

<Boolean>

<Boolean> is a type of data that indicates ON or OFF, and is expressed in one of the following forms.

Form	Example
{ON OFF <NRF>}	ON OFF 1 0

- When expressing <Boolean> in <NRf> form, OFF is selected if the rounded integer value is "0" and ON is selected if the rounded integer is "non 0."
- A response message is always "1" if the value is ON and "0" if it is OFF.

<Character String Data>

<Character string data> is an arbitrary character string unlike the <character data>, which uses only specific characters. The character string must be enclosed in single quotation marks (') or double quotation marks (").

Form	Example
<Character string data>	'ABC' "IEE488.2-1987"

- If a character string contains a double quotation mark ("), use two double quotation marks (" ") to indicate it. This rule also applies to a single quotation mark (') within a character string.
- Response messages always use double quotation marks (") around the character string.
- Since <Character string data> is an arbitrary character string, leaving the end single quotation mark (') or double quotation mark (") will cause the CW120 to interpret the program message unit as part of the <character string data>. As a result, errors may not be detected properly.

<Filename>

<Filename> is data that denotes a file name. It is expressed in one of the following forms.

Form	Example
{<NRF> <Character data> <Character string data>}	1 CASE "CASE"

- In the <NRf> form, a file name is an ASCII code obtained by rounding an 8-digit value into an integer (for example, "1" denotes "00000001."). A negative value is not allowed, however.
- In the <character data> or <character string data> form, a file name is the first eight characters.
- A response message is always returned in the <character string data> form.

1.5 Messages on RS-485

Messages

In the same way as in RS-232 communication, RS-485 communication between a CW120 (or CW121) and a personal computer is carried out in blocks of data called messages. In RS-485 communication, an STX (ASCII-code "02H"), the device address, the checksum, an ETX (ASCII-code "03H"), and a CR (ASCII-code "0DH") are attached to each program message sent from the personal computer and each message sent from the CW120 (or CW121) to the personal computer.

If a received program message contains a query command (a command which requests a response), the CW120 (or CW121) returns a response message. If a received program message does not contain a query command, the CW120 (or CW121) returns OK or ERROR as a response message. Also in response to a syntax error in a program message, the CW120 returns ERROR.

Program Messages to CW120/121 and Response from CW120/121

<STX><device address><program message><checksum><ETX><CR>

Range of data to calculate checksum

<STX><device address><response message><checksum><ETX><CR>

Range of data to calculate checksum

STX (start of text)	ASCII-code "02H"	1 byte
Device address	ASCII-codes "000" to "999"	3 bytes
Program message	Uppercase alphabetical and numerical characters	Variable
Checksum	ASCII-codes "00" to "FF"	2 bytes

A value calculated by summing up the specified block of data in hexadecimal and encoding the last two digits as ASCII code characters

ETX (end of text)	ASCII "03H"	1 byte
CR (terminator)	ASCII "0DH"	1 byte

1.6 Communication Commands

Command	Description
COMMunicate Group	
:COMMunicate?	Queries all the communication settings
:COMMunicate:HEADer	Sets/queries whether or not the header is returned in response to a query
:COMMunicate:STATus?	Queries status specific to the line
:COMMunicate:VERBose	Sets/queries whether the response to a query is returned in full or abbreviated form
SYSTem Group	
:SYSTem?	Queries all the system settings
:SYSTem:BACKlight	Sets/queries whether the LCD backlight is set to ON or OFF
:SYSTem:CLAMp	Sets/queries the type of clamp
:SYSTem:CURRent?	Queries all the settings relating to the current range
:SYSTem:CURRent:RANGe	Sets/queries the current range settings
:SYSTem:DATE	Sets/queries the date
:SYSTem:DISPlay?	Queries the type of screen
:SYSTem:KLOCK	Sets/queries the keylock function
:SYSTem:RESEt	Resets the system
:SYSTem:SCALing?	Queries all the settings relating to scaling
:SYSTem:SCALing:CT	Sets/queries the CT ratio
:SYSTem:SCALing:VT	Sets/queries the VT ratio
:SYSTem:TIME	Sets/queries the time
:SYSTem:VOLTage?	Queries all the settings relating to the voltage range
:SYSTem:VOLTage:RANGe	Sets/queries the voltage range
:SYSTem:WIRIng	Sets/queries the wiring
INTEGrate Group	
:INTEgrate?	Queries all the settings relating to electric energy measurement
:INTEgrate:CLEAr	Clears integrated values to zero
:INTEgrate:DISPlay?	Queries all the settings relating to measurement screen
:INTEgrate:DISPlay:LOAD	Sets/queries the load whose data is viewed
:INTEgrate:DISPlay:MODE	Sets/queries the mode of measurement screen
:INTEgrate:STARt?	Queries all the settings relating to the start of measurement
:INTEgrate:STARt:EXECute	Starts measurement
:INTEgrate:STARt:METHod	Sets/queries the method for starting measurement
:INTEgrate:STARt:TIME	Sets/queries the starting time of measurement
:INTEgrate:STATe?	Queries the measurement status
:INTEgrate:STOP?	Queries all the settings relating to the end of measurement
:INTEgrate:STOP:EXECute	Stops measurement
:INTEgrate:STOP:TIME	Sets/queries the ending time of measurement
:INTEgrate:STORe?	Queries all the settings relating to the data output, file name, and output interval
:INTEgrate:STORe:STATe	Sets/queries whether data output is set to ON or OFF
:INTEgrate:STORe:FILEName	Sets/queries the name of a file to be saved
:INTEgrate:STORe:INTERval	Sets/queries the output interval

Appendix 2. Communication Commands

Command	Description
:INTEgrate:WH?	Queries all the settings relating to the display digits and unit of electric energy
:INTEgrate:WH:DIGIT	Sets/queries the display digits of electric energy
:INTEgrate:WH:UNIT	Sets/queries the display unit of electric energy
MEASure Group	
:MEASure:INTEgrate?	Queries all the settings relating to Electric Energy Measure mode communication-output data
:MEASure:INTEgrate:ITEM?	Queries all the settings relating to Electric Energy Measure mode communication-output data items
:MEASure:INTEgrate:ITEM<Electric Energy Measure mode data item>	Sets/queries whether Electric Energy Measure mode communication-output data items are set to ON or OFF
:MEASure:INTEgrate:ITEM:ALL	Sets all effective Electric Energy Measure mode communication-output data to ON
:MEASure:INTEgrate:ITEM:CLEAR	Sets all effective Electric Energy Measure mode communication-output data to OFF
:MEASure:INTEgrate:ITEM:VALUe?	Queries the measurement data item set with a command that follows the :MEASure:INTEgrate:ITEM query
STATus Group	
: STATus?	Queries all the settings relating to the status of the communication function
: STATus:ERRor?	Queries the error code and message (head of the error queue)
: STATus:OMESsage	Queries whether or not to add to the message contents to the :STATus:ERRor? response
MEMORy Group	
: MEMORy?	Queries all the settings relating to the internal memory
: MEMORy:DATA?	Queries the number of data backed up in the internal memory
: MEMORy:SEND?	Transfers data backed up in the internal memory
CARD Group	
: CARD?	Queries all the settings relating to the PC card
: CARD:DELEte?	Deletes the file that was specified using the :CARD:FILEName and :CARD:TYPE commands
: CARD:DIREctory?	Queries all the file names that have been set using the :CARD:TYPE command
: CARD:FILEName	Sets/queries the names of all files that reside in the PC card
: CARD:FORMat	Formats the PC card
: CARD:PICKout?	Queries all the settings relating to transfer of a specified range of file contents
: CARD:PICKout:END	Sets/queries the transfer end point
: CARD:PICKout:SEND?	Transfers the specified range of the contents of the file that was specified using the :CARD:FILEName and :CARD:TYPE commands

Command	Description
:CARD:PICKout:START	Sets/queries the transfer start point
:CARD:SEND?	Transfers the contents of the file that was specified using the :CARD:FILENAME and :CARD:TYPE commands
:CARD:SETTING	Creates a setting file in the PC card and saves the current settings to it
:CARD:STATE	Queries the PC card status
:CARD:TYPE	Sets/queries which type of files in the PC card is to be accessed
Common Command Group	
*CLS	Clears the error queue
*IDN?	Queries the meter model

Output Queue and Error Queue

Output Queue

The output queue is provided to store response messages to queries. For example, when the :MEASure:INTEgrate:VALUe? query is sent to request output of measured data, the response data will be stored in the output queue until it is read out.

Data items are stored in sequence in the output queue and then read out on a first-in-first-out basis. The output queue is emptied in any of the following cases, in addition to a case when it is entirely read out.

- A new message is received from the personal computer.
- A deadlock occurs.
- The power is turned on again.

Error Queue

The error queue stores the error number and message when an error occurs. For example, if the personal computer sends an illegal program message, the error queue stores error number 113 and the error message "Undefined header." The contents of the error queue can be read using the STATus:ERRor? query. As with the output queue, messages in the error queue are read out on a first-in-first-out basis.

If the error queue overflows, the last message is replaced with message 350, "Queue overflow." The error queue is emptied in either of the following cases, in addition to a case when it is entirely read out).

- The *CLS command is received.
- The power is turned on again.

1.7 Detailed Description of Communication Commands

1.7.1 COMMunicate Group

The commands in the COMMunicate group are used to set or query communication parameters.

:COMMunicate?

Function Queries all the communication settings.

Syntax :COMMunicate?

Example :COMMUNICATE?
→:COMMUNICATE:HEADER
1;VERBOSE 1;STATUS 0

:COMMunicate:HEADer

Function Sets/queries whether or not the header is returned in response to a query.

Syntax :COMMunicate:HEADer
{<Boolean>}

Example :COMMUNICATE:HEADer?
:COMMUNICATE:HEADer?→
:COMMUNICATE:HEADer 1

:COMMunicate:STATus?

Function Queries the status specific to the line.

Syntax :COMMunicate:STATus?

Example :COMMUNICATE:STATUS?→
:COMMUNICATE:STATUS 0

Description The status bits have the following meanings.

Bit 0: Parity error

Bit 1: Framing error

Bit 2: BREAK character detected

Bit 3 and later: Always 0

If one of the causes noted above occurs, the corresponding status bit is set. The bit is cleared when the status is read.

:COMMunicate:VERBoSe

Function Sets/queries whether the response to a query is returned in full or abbreviated form.

Syntax :COMMunicate:VERBoSe
{<Boolean>}
:COMMunicate:VERBoSe?

Example :COMMUNICATE:VERBOSE ON
:COMMUNICATE:VERBOSE?→
:COMMUNICATE:VERBOSE 1

1.7.2 SYSTem Group

The commands in the SYSTem group set or query system parameters.

:SYSTem?

Function Queries all the system settings.

Syntax :SYSTem?

:SYSTem:BACKlight

Function Sets/queries whether the LCD backlight is set to ON or OFF.

Syntax :SYSTem:BACKlight?
:SYSTem:BACKlight
{<Boolean>}

:SYSTem:CLAMp

Function Sets/queries the type of clamp.

Syntax :SYSTem:CLAMp?
:SYSTem:CLAMp {<NRf>}
<NRf> = 0: 5 to 50 A
1: 20 to 200 A
2: 50 to 500 A
3: 200 to 1000 A

:SYSTem:CURRent?

Function Queries all the settings relating to the current range.

Syntax :SYSTem:CURRent?

:SYSTem:CURRent:RANGe

Function Sets/queries the current range.

Syntax :SYSTem:CURRent:RANGe?
:SYSTem:CURRent:RANGe
{<NRf>}
<NRf> = 0: 5 A
1: 10 A
2: 20 A
3: 50 A
4: 100 A
5: 200 A
6: 500 A
7: 1000 A

:SYSTem:DATE

Function Sets/queries the date.

Syntax :SYSTem:DATE?
:SYSTem:DATE {<NRf1>,
<NRf2>,<NRf3>}
<NRf1> = Year: 2000 to 2099
<NRf2> = Month: 1 to 12
<NRf3> = Day: 1 to 31

:SYSTem:DISPlay?

Function Queries the screen currently displayed.

Syntax :SYSTem:DISPlay?
<NRf> = 0: Instantaneous value or electric energy measurement screen
1: Wiring check

:SYSTem:KLOCK

Function Sets/queries whether the key-lock function is set to ON or OFF.

Syntax :SYSTem:KLOCK?
:SYSTem:KLOCK {<Boolean>}

:SYSTem:RESEt

Function Executes system resetting.

Syntax :SYSTem:RESEt

Appendix 2. Communication Commands

:SYSTEM:SCALing?

Function Queries all the settings relating to scaling.

Syntax :SYSTEM:SCALing?

:SYSTEM:SCALing:CT

Function Sets/queries the CT ratio.

Syntax :SYSTEM:SCALing:CT?
:SYSTEM:SCALing:CT {<NRf>}
<NRf> = 1.00 to 10000.00

:SYSTEM:SCALing:VT

Function Sets/queries the VT ratio.

Syntax :SYSTEM:SCALing:VT?
:SYSTEM:SCALing:VT {<NRf>}
<NRf> = 1 to 10000

:SYSTEM:TIME

Function Sets/queries the clock.

Syntax :SYSTEM:TIME?
:SYSTEM:TIME
{<NRf1>, <NRf2>, <NRf3>}
<NRf1> = hour: 0 to 23
<NRf2> = minute: 0 to 59
<NRf3> = second: 0 to 59

:SYSTEM:VOLTage?

Function Queries all the settings relating to the voltage range.

Syntax :SYSTEM:VOLTage?

:SYSTEM:VOLTage:RANGe

Function Sets/queries the voltage range.

Syntax :SYSTEM:VOLTage:RANGe?
:SYSTEM:VOLTage:RANGe
{<NRf>}
<NRf> = 0: 150 V
1: 300 V
2: 450 V

:SYSTEM:WIRIng

Function Sets/queries the wiring type.

Syntax :SYSTEM:WIRIng?
:SYSTEM:WIRIng {<NRf>}
<NRf> = 0: 1 ϕ 2W
1: 1 ϕ 3W
2: 3 ϕ 3W
3: 3 ϕ 4W
4: 1 ϕ 2W \times 2
5: 1 ϕ 2W \times 3

1.7.3 INTEgrate Group

The commands in the INTEgrate group set or query electric energy measurement parameters.

:INTEgrate?

Function Queries all the settings relating to electric energy measurement.

Syntax :INTEgrate?

:INTEgrate:CLEAr

Function Clears integrated values to zero.

Syntax :INTEgrate:CLEAr

:INTEgrate:DISPlay?

Function Queries all the settings relating to measurement screen.

Syntax :INTEgrate:DISPlay?

:INTEgrate:DISPlay:LOAD

Function Sets/queries the load whose data is viewed

Syntax :INTEgrate:DISPlay:LOAD?
:INTEgrate:DISPlay:LOAD
{<NRf>}
<NRf> = 0: Load 1
1: Load 2
2: Load 3

:INTEgrate:DISPlay:MODE

Function Sets/queries the type of measurement screen.

Syntax :INTEgrate:DISPlay:MODE?
:INTEgrate:DISPlay:MODE
{<NRf>}
<NRf> = 0: Display item 1
1: Display item 2
2: Display item 3
3: Display item 4
4: Display item 5
5: Display item 6

:INTEgrate:STARt?

Function Queries all the settings relating to the start of measurement.

Syntax :INTEgrate:STARt?

:INTEgrate:STARt:EXECute

Function Starts measurement.

Syntax :INTEgrate:STARt:EXECute

:INTEgrate:STARt:METhod

Function Sets/queries the method for starting measurement.

Syntax :INTEgrate:STARt:METhod?
:INTEgrate:STARt:METhod
{<NRf>}
<NRf> = 0: Time
1: Manual

:INTEgrate:STARt:TIME

Function Sets/queries the starting time of measurement.

Syntax :INTEgrate:STARt:TIME?
:INTEgrate:STARt:TIME
{<NRf1>, <NRf2>, <NRf3>,
<NRf4>, <NRf5>}
<NRf1> = Year: 2000 to 2099
<NRf2> = Month: 1 to 12
<NRf3> = Day: 1 to 31
<NRf4> = Hour: 0 to 23
<NRf5> = Minute: 0 to 59

:INTEgrate:STATe?

Function Queries the measurement status.

Syntax :INTEgrate:STATe?
:INTEgrate:STATe
<NR1> = 0: Stop
1: Ready for measurement
2: Integration in progress

Appendix 2. Communication Commands

:INTEgrate:STOP?

Function Queries all the settings relating to the end of measurement.

Syntax :INTEgrate:STOP?

:INTEgrate:STOP:EXECute

Function Stops measurement.

Syntax :INTEgrate:STOP:EXECute

:INTEgrate:STOP:TIME

Function Sets/queries the ending time of measurement.

Syntax :INTEgrate:STOP:TIME?
:INTEgrate:STOP:TIME
{<NRf1>, <NRf2>, <NRf3>,
<NRf4>, <NRf5>}
<NRf1> = Year: 2000 to 2099
<NRf2> = Month: 1 to 12
<NRf3> = Day: 1 to 31
<NRf4> = Hour: 0 to 23
<NRf5> = Minute: 0 to 59

:INTEgrate:STORE?

Function Queries all the settings relating to output destination and data items to be saved.

Syntax :INTEgrate:STORE?

:INTEgrate:STORE:STATE

Function Sets/queries whether data output is set to ON or OFF.

Syntax :INTEgrate:STORE:STATE?
:INTEgrate:STORE:STATE
{<Boolean>}

:INTEgrate:STORE:FILENAME

Function Sets/queries the name of a file to be saved.

Syntax :INTEgrate:STORE:FILE?
:INTEgrate:STORE:FILE
<Filename>
<Filename> = Up to 8 characters

:INTEgrate:STORE:INTERval

Function Sets/queries the output time interval.

Syntax :INTEgrate:STORE:INTERval?
:INTEgrate:STORE:INTERval
{<NRf1>, <NRf2>}
<NRf1> = Hour: 0 to 1000
<NRf2> = Minute: 0 to 59
<NRf3> = Second: 0 to 59

Remarks The valid setting is 1, 2, 5, 10, 15, 30 seconds, or 1, 2, 5, 10, 15, 30 minutes, or 1 hour.

:INTEgrate:WH?

Function Queries all the settings relating to the display digits and unit of electric energy.

Syntax :INTEgrate:WH?

:INTEgrate:WH:DIGit

Function Sets/queries the display digits of electric energy.

Syntax :INTEgrate:WH:DIGit?
:INTEgrate:WH:DIGit
{<NRf>}
<NRf> = 0: Standard
1: 000.000
2: 0000.00
3: 00000.0
4: 000000

:INTEgrate:WH:UNIT

Function Sets/queries the display unit of electric energy.

Syntax :INTEgrate:WH:UNIT?
:INTEgrate:WH:UNIT {<NRf>}
<NRf> = 0: Wh
1: kWh
2: MWh
3: GWh

1.7.4 MEASure Group

The commands in the MEASure group set or query parameters relating to data acquisition in each measurement mode.

:MEASure:INTEgrate?

Function Queries all the settings relating to the communication output data on electric energy measurement.

Syntax :MEASure:INTEgrate?

:MEASure:INTEgrate:ITEM?

Function Queries all the settings for data items of communication output data on electric energy measurement.

Syntax :MEASure:INTEgrate:ITEM?

:MEASure:INTEgrate:ITEM:<measured data items>

Function Sets/queries the ON/OFF statuses for data items of communication output data on electric energy measurement.

Syntax :MEASure:INTEgrate:ITEM
:<Measured data items>
{<Boolean>}

<Measured data items> =

0: V1	1: V2	2: V3
3: I1, I1-1	4: I2	5: I3
6: P, P-1	7: Q, Q-1	8: PF, PF-1
9: F	10: +Wh, +Wh-1	11: -Wh, -Wh-1
12: I1-2		
13: P-2	14: Q-2	15: PF-2
16: +Wh-2	17: -Wh-2	
18: I1-3		
19: P-3	20: Q-3	21: PF-3
22: +Wh-3	23: -Wh-3	

:MEASure:INTEgrate:ITEM:ALL

Function Sets all effective data items of communication output data on electric energy measurement to ON.

Syntax :MEASure:INTEgrate:ITEM
:ALL

:MEASure:INTEgrate:ITEM:CLEAr

Function Resets all effective data items of communication output data on electric energy measurement to OFF.

Syntax :MEASure:INTEgrate:ITEM
:CLEAr

:MEASure:INTEgrate:ITEM:VALUe?

Function Queries the measured values of the data items that were set to ON using the :MEASure:INTEgrate:ITEM:<items>, :MEASure:INTEgrate:ITEM:ALL, and :MEASure:INTEgrate:ITEM:CLEAr commands.

Syntax :MEASure:INTEgrate:ITEM
:VALUe?

1.7.5 STATus Group

:STATus?

Function Queries all the settings relating to the status of the communication function.

Syntax :STATus?

:STATus:ERRor?

Function Queries the error code and message (head of the error queue).

Syntax :STATus:ERRor?

Description

- If there is no error, '0, "No error" ' is returned.
- You can set whether or not to add the message contents using the "STATus:QMESsage" command.

:STATus:OMESsage

Function Sets/queries whether or not to add the message contents to the STATus:ERRor? response.

Syntax :STATus:OMESsage {<Boolean>}
:STATus:OMESsage?

1.7.6 MEMORy Group

The MEMORy group contains commands relating to acquisition of backup data in the internal memory.

:MEMORy:DATA?

Function Queries the number of data backed up in the internal memory.

Syntax :MEMORy:DATA?

:MEMORy:SEND?

Function Transfers the data backed up in the internal memory.

Syntax :MEMORy:SEND?
:MEMORy:SEND?
→ STX (ASCII-code "02H"), file contents, ETX (ASCII-code "03H")
The STX and ETX are not attached in RS-485 communication.

1.7.7 CARD Group

The CARD group contains commands relating to the inserted PC card.

:CARD:DELEte?

Function Deletes the file that was specified using the :CARD:FILEName and :CARD:TYPE commands.

Syntax :CARD:DELEte?

:CARD:DIREctory?

Function Queries all the file names that have been set using the :CARD:TYPE command.

Syntax :CARD:DIREctory?

:CARD:FILEName

Function Sets/queries the names of all files that reside in the PC card.

Syntax :CARD:FILEName?
:CARD:FILEName
{<Filename>}
<Measured data items> = Up to 8 characters

:CARD:FORMat

Function Formats the PC card.

Syntax :CARD:FORMat

:CARD:PICKout?

Function Queries all the settings relating to transfer of a specified range of file contents.

Syntax :CARD:PICKout?

:CARD:PICKout:END

Function Sets/queries the transfer end point.

Syntax :CARD:PICKout:END?
:CARD:PICKout:END {<Nrf>}
<Nrf> = 1 to 2147483647

:CARD:PICKout:SEND?

Function Transfers the contents (for the range specified using the :CARD:PICKout:START and :CARD:PICKout:END commands) of the file that was specified using the :CARD:FILEName and :CARD:TYPE commands.

Syntax :CARD:PICKout:SEND?
→ STX (ASCII-code "02H"), file contents, ETX (ASCII-code "03H")
The STX and ETX are not attached in RS-485 communication.

:CARD:PICKout:START

Function Sets/queries the transfer start point.

Syntax :CARD:PICKout:START
 :CARD:PICKout:START
 {<NRf>}
 <NRf> = 1 to 2147483647

:CARD:SEND?

Function Transfers the contents of the file that was specified using the :CARD:FILENAME and :CARD:TYPE commands.

Syntax :CARD:SEND?
 → STX (ASCII-code "02H"), file contents, ETX (ASCII-code "03H"), <RMT>
 The STX and ETX are not attached in RS-485 communication.

:CARD:SETting

Function Creates a setting file in the PC card and saves the current settings to it.

Syntax :CARD:SETting {<NRf>}
 <NRf> = 0 to 29 (file number)

:CARD:STATe

Function Queries the PC card status.

Syntax :CARD:STATe?
 :CARD:STATe {<NRf>}
 <NRf> = 0: A card is not set.
 1: A card is set.

:CARD:TYPE

Function Sets/queries which type of files in the PC card is to be accessed.

Syntax :CARD:TYPE
 :CARD:TYPE {<NRf>}
 <NRf> = 1: Auto-storing file
 3: File containing currently measured values
 4: Setting file

1.7.8 Common Group***CLS (ClearStatus)**

Function Clears the error queue.

Syntax *CLS

***IDN? (IDeNtify)**

Function Queries the meter model.

Syntax *IDN?

Description A reply sequence is returned as follows:

<Manufacturer>, <Model>, <Serial No.>, <Firmware version>.
 <Serial No.> is not returned in actual applications (always 0).

2. Error Messages

The following describes only errors messages relating to communication. These messages are divided into the following groups by the error code:

- Command syntax errors: Codes 100 to 199
- Communication execution errors: Codes 200 to 299
- Query errors: Codes 400 to 499
- Command execution errors: Codes 600 to 799
- System error: Code 912

Command Syntax Errors (Codes 100 to 199)

Code	Message	Countermeasure
102	Syntax Error	Check the command string. There is an error other than those corresponding to codes 103–158.
103	DATA SEPARATOR Invalid separator	Use commas to separate data (parameters) from each other.
104	DATA Data type error	Code the parameter in the correct data type.
108	DATA Parameter not allowed	Too many parameters are set. Check the number of parameters.
109	DATA Missing parameter	Code all the necessary parameters.
111	HEADER SEPARATOR Header separator error	Separate the header from data by a space.
112	mnemonic Program mnemonic too long	Check the mnemonic (an alphabetical letter followed by a number).
113	Undefined header	Check the header.
114	HEADER Header suffix out of range	Check the header.
120	Numeric data error	No mantissa is set in a numeric data. An <NRf> format parameter requires a numeric value.
123	Exponent too large	Reduce the number that follows "E" in an <NR3> format parameter.
124	Too many digits	Do not set a number in 256 digits or more.
128	Numeric data not allowed	Code the parameter in a format other than <NRf>.
131	Invalid suffix	Check the units (suffixes) of the voltage, current, and frequency.
134	Suffix too long	Check the units (suffixes) of the voltage, current, and frequency.
138	Suffix not allowed	A unit (suffix) cannot be used for any item other than voltage, current, and frequency.
141	Invalis character data	Choose a string from those given in braces {...}.
144	CHARACTER DATA Character data too long	Choose a string from those given in braces {...} and quote it using the exact spelling.
148	CHARACTER DATA Character data not allowed	Code the parameter in the correct format other than {...}.
150	STRING DATA String data error	Enclose the parameter in <character string> format in double quotes.
151	STRING DATA Invalid string data	The parameter in <character string> format is too long or contains an invalid string.
158	STRING DATA String data not allowed	Set the parameter in a format other than <character string>.

Appendix 2. Communication Commands

Communication Execution Errors (Codes 200 to 299)

Code	Message	Countermeasure
200	Execution error	The specified command cannot be carried out.
221	Setting conflict	Check the setting with other related settings.
222	Data out of range	Check the setting range.
223	Too much data	Check the byte length of the parameter.
224	Illegal parameter value	Check the setting range.
241	Hardware missing	Check the options equipped.

Query Errors (Codes 400 to 499)

Code	Message	Countermeasure
410	Query INTERRUPTED	Check the transmission-reception sequence.
420	Query UNTERMINATED	Check the transmission-reception sequence.
430	Query DEADLOCKED	Limit the length of each program message within 1024 bytes including the <PMT>.
440	Query UNTRMINATED after indefinite response	Do not code a query following “**IDN?”.

Command Execution Errors (Codes 600 to 799)

Code	Message	Countermeasure
600	<i>CArd Err.</i> PC card not ready.	The PC card is not set. Insert a PC card.
601	<i>Err. 101</i> PC card write error.	A writing access is disabled since the PC card was removed during access or the card is damaged. Insert a card that is not damaged.
602	<i>Err. 102</i> PC card read error.	A reading access is disabled since the PC card was removed during access or the card is damaged. Insert a card that is not damaged.
603	<i>Err. 103</i> Directory full.	The number of files that can be created in the card has exceeded the limit. Delete unnecessary files or use a different card.
604	<i>Err. 104</i> Invalid PC card.	The inserted PC card is not a flash ATA memory card. Insert a flash ATA memory card.
605	<i>Err. 105</i> Card not formatted.	The inserted PC card has not yet been formatted in MS-DOS format. Format it with the power meter.
606	<i>Err. 106</i> Can not use this card.	A PC card not supported by the power meter is inserted.
607	<i>Err. 112</i> PC card error.	An error relating to the PC card, other than the above, has occurred.

System Error (Code 912)

Code	Message	Countermeasure
912	Fatal error Communication-driver	Needs to be serviced.

Other Errors (Codes 350 and 390)

Code	Message	Countermeasure
350	Queue overflow	Read the error queue.
390	Overrun error(RS-232)	Decrease the baud rate.

3. Command Effectiveness Tables

(1) COMMunicate Group

Command \ Status	Integration in Progress	Integration Stopped	Wiring Check	Setting
: COMMunicate?	✓	✓	✓	✓
: HEADer?	✓	✓	✓	✓
: HEADer	✓	✓	✓	✓
: STATus?	✓	✓	✓	✓
: VERBose?	✓	✓	✓	✓
: VERBose	✓	✓	✓	✓

✓ : Effective
 Blank: Ineffective

(2) SYSTEM Group

Status Command	Integration in Progress	Integration Stopped	Wiring Check	Setting
: SYSTem?	✓	✓	✓	✓
: BACKlight?	✓	✓	✓	✓
: BACKlight	✓	✓	✓	✓
: CLAMp?	✓	✓	✓	✓
: CLAMp		Cond.		
: CURRent?	✓	✓	✓	✓
: CURRent				
: RANGe?	✓	✓	✓	✓
: RANGe		Cond.		
: DATE?	✓	✓	✓	✓
: DATE		✓		
: DISPlay?	✓	✓	✓	✓
: KLOCK?	✓	✓	✓	✓
: KLOCK	✓	✓		
: RESEt		✓		
: SCALing?	✓	✓	✓	✓
: SCALing				
: CT?	✓	✓	✓	✓
: CT		Cond.		
: VT?	✓	✓	✓	✓
: VT		Cond.		
: TIME?	✓	✓	✓	✓
: TIME		✓		
: VOLTage?	✓	✓	✓	✓
: VOLTage				
: RANGe?	✓	✓	✓	✓
: RANGe		Cond.		
: WIRing?	✓	✓	✓	✓
: WIRing		Cond.		

✓ : Effective
 Blank : Ineffective
 Cond.: Conditional; setting is not allowed during integration

Appendix 2. Communication Commands

(3) INTEgrate Group

Command \ Status	Integration in Progress	Integration Stopped	Wiring Check	Setting
: INTEgrate?	✓	✓	✓	✓
: CLEAR		✓		
: DISPlay?	✓	✓	✓	✓
: DISPlay				
: LOAD?	✓	✓	✓	✓
: LOAD		✓		
: MODE?	✓	✓	✓	✓
: MODE		✓		
: START?	✓	✓	✓	✓
: START				
: EXECute		✓		
: METHod?	✓	✓	✓	✓
: METHod		✓		
: TIME?	✓	✓	✓	✓
: TIME		✓		
: STATE?	✓	✓	✓	✓
: STOP?	✓	✓	✓	✓
: STOP				
: EXECute	✓			
: TIME?	✓	✓	✓	✓
: TIME		✓		
: STORE?	✓	✓	✓	✓
: STORE				
: STATE?	✓	✓	✓	✓
: STATE		✓		
: FILEname?	✓	✓	✓	✓
: FILEname		✓		
: INTErval?	✓	✓	✓	✓
: INTErval		✓		
: WH?	✓	✓	✓	✓
: WH				
: DIGI?	✓	✓	✓	✓
: DIGI		✓		
: UNIT?	✓	✓	✓	✓
: UNIT		✓		

✓ : Effective
Blank: Ineffective

(4) MEASure Group

Command \ Status	Integration in Progress	Integration Stopped	Wiring Check	Setting
: MEASure				
: INTEGrate?	✓	✓	✓	✓
: INTEGrate				
: ITEM?	✓	✓	✓	✓
: ITEM				
:	✓	✓		
:	✓	✓		
: ALL	✓	✓		
: CLEAR	✓	✓		
: VALUe?	✓	✓		

✓ : Effective
Blank: Ineffective

(5) STATus Group

Command \ Status	Integration in Progress	Integration Stopped	Wiring Check	Setting
: STATus?	✓	✓	✓	✓
: STATus	✓	✓	✓	✓
: ERRor?	✓	✓	✓	✓
: OMESsage?	✓	✓	✓	✓
: OMESsage	✓	✓	✓	✓

✓ : Effective
Blank: Ineffective

(6) MEMOrY Group

Command \ Status	Integration in Progress	Integration Stopped	Wiring Check	Setting
: MEMOrY				
: DATA?	✓	✓	✓	✓
: SEND?		✓		

✓ : Effective
Blank: Ineffective

Appendix 2. Communication Commands

(7) CARD Group

Command \ Status	Integration in Progress	Integration Stopped	Wiring Check	Setting
: CARD?	✓	✓	✓	✓
: DELEte		✓		
: DIREctory?		✓		
: FILEname?	✓	✓	✓	✓
: FILEname		✓		
: FORMat		✓		
: PICKout?	✓	✓	✓	✓
: PICKout				
: END?	✓	✓	✓	✓
: END	✓			
: SEND?		✓		
: START?	✓	✓	✓	✓
: START		✓		
: SEND?		✓		
: SETT	✓			
: STATE?	✓	✓	✓	✓
: TYPE?	✓	✓	✓	✓
: TYPE		✓		

✓ : Effective
Blank: Ineffective

(8) Common Command Group

Command \ Status	Integration in Progress	Integration Stopped	Wiring Check	Setting
*CLS	✓	✓	✓	✓
*IDN?	✓	✓	✓	✓

✓ : Effective
Blank: Ineffective

Appendix 3. File Structures and Data Items Printed

- 1. Overview App 3-2
- 2. Measured Data App 3-3
 - 2.1 File Format App 3-3
 - 2.1.1 File Identifier App 3-3
 - 2.1.2 File Type App 3-3
 - 2.1.3 Measurement Mode App 3-3
 - 2.1.4 Data Field Titles and Data Formats App 3-4
 - 2.1.5 Records of Power Failure/Restoration Information App 3-5
 - 2.2 Print Format App 3-6
 - 2.2.1 Print Item Titles and Data Formats App 3-6
- 3. Settings App 3-8
 - 3.1 File Format App 3-8
 - 3.2 Output Format and Data Values App 3-9
 - 3.3 Print Format App 3-11
- 4. Automatic File Naming App 3-12

1. Overview

There are two types of data sets that may be saved to a file and printed: one is measured data, and the other is settings. Measured data is saved by a user action during instantaneous value measurement or automatically during electric energy measurement.

(1) Measured Data

- Manual saving:
Pressing the SAVE key outputs the measured data to a file.
- Automatic saving:
Measured data is output to a file periodically at a specified interval after measurement begins.

(2) Settings

The current settings of measurement conditions are output to a file or printer.

2. Measured Data

2.1 File Format

Measured-data files are in CSV format. Each file contains the file identifier, file type number, measurement mode, titles of measured data items (data field titles), and measured values. From the second and subsequent times when data is saved to the same file, only the measured values are added.

“CW12x” ← File identifier characters
 “File Type”,0 ← File type number
 “MeasureMode”,1 ← Measurement mode
 “OUTPUT DATE”,“OUTPUT TIME”,...(data title)...,Wh(-) ← Title of measured data items (data field titles)
 yyyy/mm/dd,hh:mm:ss,...(measured value)...,x.xxxxxE+xx ← Measured value record 1
 yyyy/mm/dd,hh:mm:ss,...(measured value)...,x.xxxxxE+xx ← Measured value record 2

2.1.1 File Identifier

Characters for identifying that the file was created by a CW120 or CW121 are output.

File identifier: CW12x

2.1.2 File Type

The file type identification code is output following “FileType”.

Identification Code	File Type
0	File containing data saved automatically
2	File containing current measured data saved manually
3	File containing settings

2.1.3 Measurement Mode

The mode identification code is output following “MeasureMode”.

Identification Code	File Type
1	Electric energy measurement

Appendix 3. File Structures and Data Items Printed

2.1.4 Data Field Titles and Data Formats

No.	Title	Data Format	Output Availability	Depending on Wiring Method		
				1Ø2W	1Ø3W 3Ø3W	3Ø4W
1	OUTPUT DATE	yyyy/mm/dd	Output date		✓	
2	OUTPUT TIME	hh:mm:ss	Output time		✓	
3	INTEG START DATE	yyyy/mm/dd	Integration start date		✓	
4	INTEG START TIME	hh:mm:ss	Integration start time		✓	
5	ELAPSED TIME	hhhh:mm:ss	Elapsed time of integration		✓	
6	V1	±0.000E ±00	Voltage 1 (V)	✓	✓	✓
7	V2	±0.000E ±00	Voltage 2 (V)		✓	✓
8	V3	±0.000E ±00	Voltage 3 (V)			✓
9	I1	±0.000E ±00	Current 1 (A)	✓	✓	✓
10	I2	±0.000E ±00	Current 2 (A)		✓	✓
11	I3	±0.000E ±00	Current 3 (A)			✓
12	P	±0.000E ±00	Active power (W)		✓	
13	Q	±0.000E ±00	Reactive power (Var)		✓	
14	PF	±0.000 ±00	Power factor		✓	
15	F	±0.000E ±00	Frequency (Hz)		✓	
16	Wh (+)	±0.00000E ±00	Active electric energy (Wh)		✓	
17	Wh (-)	±0.00000E ±00	Regenerative electric energy (Wh)		✓	

Note: An invalid or overflowed value is output as "----" or "OR".

No.	Title	Data Format	Output Availability	Depending on Wiring Method	
				1Ø2W ×2	1Ø2W ×3
1	OUTPUT DATE	yyyy/mm/dd	Output data	✓	
2	OUTPUT TIME	hh:mm:ss	Output time		
3	INTEG START DATE	yyyy/mm/dd	Integration data		
4	INTEG START TIME	hh:mm:ss	Integration time		
5	ELAPSED TIME	hhhhh:mm:ss	Elapsed time of integration		
6	V1	±0.000E ±00	Voltage 1 (V)		
7	I1-1	±0.000E ±00	Current 1 (A)		
8	P-1	±0.000E ±00	Active power (W)		
9	Q-1	±0.000E ±00	Reactive power (Var)		
10	PF-1	±0.000E ±00	Power factor		
11	F	±0.000E ±00	Frequency (Hz)		
12	Wh (+)-1	±0.00000E ±00	Active electric energy (Wh)		
13	Wh (-)-1	±0.00000E ±00	Regenerative electric energy (Wh)		
14	I1-2	±0.000E ±00	Current 1 (A)		
15	P-2	±0.000E ±00	Active power (W)		
16	Q-2	±0.000E ±00	Reactive power (Var)		
17	PF-2	±0.000E ±00	Power factor		
18	Wh (+)-2	±0.00000E ±00	Active electric energy (Wh)		
19	Wh (-)-2	±0.00000E ±00	Regenerative electric energy (Wh)		
20	I1-3	±0.000E ±00	Current 1 (A)		
21	P-3	±0.000E ±00	Active power (W)		
22	Q-3	±0.000E ±00	Reactive power (Var)		
23	PF-3	±0.000E ±00	Power factor		
24	Wh (+)-3	±0.00000E ±00	Active electric energy (Wh)		
25	Wh (-)-3	±0.00000E ±00	Regenerative electric energy (Wh)		

Note: An invalid or overflowed value is output as "----" or "OR".

2.1.5 Records of Power Failure/Restoration Information

After a power failure during automatic saving was in progress, the times when the power failure and restoration occurred are output as power failure/restoration information in the following format before new data values are output:

```

"CW12x"
"File Type",0
"MeasureMode",1
"OUTPUT DATE","OUTPUT TIME",...(data title)...,Wh(-) ← Title of measured data items (data field titles)
yyyy/mm/dd,hh:mm:ss,...(measured value)...,x.xxxxxE+xx ← Data values before power failure
"POWER OFF",yyyy/mm/dd,hh:mm:ss ← Power failure information
"POWER ON",yyyy/mm/dd,hh:mm:ss ← Power restoration information
yyyy/mm/dd,hh:mm:ss,...(measured value)...,x.xxxxxE+xx ← New data values after restoration
    
```

2.2 Print Format

A single item is printed per line. Each numeric value is printed in significant digits.

yyyy/mm/dd	hh:mm:ss	Printing date
Integration start time		Integration start time
yyyy/mm/dd	hh:mm:ss	
Elapsed time	hhhhh:mm:ss	Elapsed time of integration

2.2.1 Print Item Titles and Data Formats

No.	Title	Data Format	Output Availability	Depending on Wiring Method		
				1Ø2W	1Ø3W 3Ø3W	3Ø4W
1		yyyy/mm/dd hh:mm:ss	Output date and time		✓	
2	Integration start time	yyyy/mm/dd hh:mm:ss	Integration start date and time		✓	
3	Elapsed time	hhhhh:mm:ss	Elapsed time of integration		✓	
4	V1	It is same as displayed on the screen.	Voltage 1 (V)	✓	✓	✓
5	V2		Voltage 2 (V)		✓	✓
6	V3		Voltage 3 (V)			✓
7	I1		Current 1 (A)	✓	✓	✓
8	I2		Current 2 (A)		✓	✓
9	I3		Current 3 (A)			✓
10	P		Active power (W)		✓	
11	Q		Reactive power (Var)		✓	
12	PF		Power factor		✓	
13	F		Frequency (Hz)		✓	
14	Wh(+)		Active electric energy (Wh)		✓	
15	Wh(-)		Regenerative electric energy (Wh)		✓	

Note: An invalid or overflowed value is printed as "----" or "OR".

Appendix 3. File Structures and Data Items Printed

No.	Title	Data Format	Output Availability	Depending on Wiring Method		
				1Ø2W ×2	1Ø2W ×3	
1		yyyy/mm/dd hh:mm:ss	Output data and time	✓	✓	
2	Integration start time	yyyy/mm/dd hh:mm:ss	Integration start data and time			
3	Elapsed time	hhhhh:mm:ss	Elapsed time of integration			
4	V1	It is same as displayed on the screen.	Voltage 1 (V)			
5	I1-1		Current 1 (A)			Load1
6	P-1		Active power (W)			
7	Q-1		Reactive power (Var)			
8	PF-1		Power factor			
9	F		Frequency (Hz)			
10	+Wh-1		Active electric energy (Wh)			Load1
11	-Wh-1		Regenerative electric energy (Wh)			
12	I1-2		Current 1 (A)			Load2
13	P-2		Active power (W)			
14	Q-2		Reactive power (Var)			
15	PF-2		Power factor			
16	+Wh-2		Active electric energy (Wh)			
17	-Wh-2		Regenerative electric energy (Wh)			Load3
18	I1-3		Current 1 (A)			
19	P-3		Active power (W)			
20	Q-3		Reactive power (Var)			
21	PF-3		Power factor			
22	+Wh-3		Active electric energy (Wh)			
23	-Wh-3		Regenerative electric energy (Wh)			

Note: An invalid or overflowed value is output as "----" or "OR".

3. Settings

3.1 File Format

Setting files are text files. In the same way as in measured-data files, the contents of each setting file begin with the file identifier, file type number, and measurement mode.

```
"CW12x"  
FileType           3  
MeasureMode       1  
Wiring            x  
SetVRange         x  
MeasVRange        x  
                  .  
                  .  
                  .  
Vt                x  
Ct                x  
ClampType         x  
No                x  
Device            x  
BaudRate          x  
DataLength        x  
Parity            x  
StopBit           x  
Handshaking       x  
                  x: Setting
```

3.2 Output Format and Data Values

Item Title	Setting	Description	Meaning of Settings
Wiring	0 to 5	Phase lines	0: Single-phase two wires 1: Single-phase three wires 2: Three-phase three wires, two currents 3: Three-phase four wires 4: Single-phase two wires ×2 5: Single-phase two wires ×3
SetVRange	1 to 4	Set voltage range	1: 150 V 2: 300 V 3: 450 V
MeasVRange	1 to 4	Voltage measurement range	1: 150 V 2: 300 V 3: 450 V
SetARange	1 to 8	Set current range	1: 5 A 2: 10 A 3: 20 A 4: 50 A 5: 100 A 6: 200 A 7: 500 A 8: 1000 A
MeasARange	1 to 8	Current measurement range	1: 5 A 2: 10 A 3: 20 A 4: 50 A 5: 100 A 6: 200 A 7: 500 A 8: 1000 A
DOut	0 or 1	Data output	0: Off 1: On
DOut_FileName	xxxxxxx	File name	Up to 8 characters
Integ_StartDate	yyyy/mm/dd	Integration start date	yyyy = year from 2000 to 2099; mm = month; dd = day
Integ_StartTime	hh:mm:ss	Integration start time	hh = hour; mm = minute; ss = second
Integ_EndDate	yyyy/mm/dd	Integration end date	yyyy = year from 2000 to 2099; mm = month; dd = day
Integ_EndTime	hh:mm:ss	Integration end time	hh = hour; mm = minute; ss = second
Integ_Interval	hhhh:mm:ss	Output interval	hhhh = hours; mm = minutes; ss = seconds
WhDigit	0 to 4	Display digits of electric energy	0: Standard 1: 000.000 2: 0000.00 3: 00000.0 4: 000000
WhUnit	0 to 3	Display unit of electric energy	0: Wh 1: kWh 2: MWh 3: GWh

Appendix 3. File Structures and Data Items Printed

Item Title	Setting	Description	Meaning of Settings
Vt	1 to 10000	VT ratio	
Ct	1.00 to 10000.00	CT ratio	
No	1 to 999	Device number	
ClampType	0 to 3	Clamp-on probe type	0: 50-A probe 1: 200-A probe 2: 500-A probe 3: 1000-A probe
Device	0 or 1	Connected device	0: Printer 1: PC
BaudRate	0 to 4	Baud rate	0: 1200 bps 1: 2400 bps 2: 4800 bps 3: 9600 bps 4: 19200 bps 5: 38400 bps
DataLength	7 or 8	Data bits	7 or 8 bits
Parity	0 to 2	Parity	0: None 1: Even 2: Odd
StopBit	1 or 2	Stop bits	1 or 2 bits
Handshaking	0 to 3	Flow control	0: ON/OFF 1: XON/XOFF 2: XON/RS 3: CS/RS

3.3 Print Format

The print format is as shown below.

```

yyyy/mm/dd  hh:mm:ss
Wiring                : x
SetVRange             : x
MeasVRange            : x
.
.
.
Vt                    : x
Ct                    : x
ClampType             : x
No                    : x
Device                : x
BaudRate              : x
DataLength            : x
Parity                : x
StopBit               : x
Handshaking           : x
                        x: Setting
    
```

4. Automatic File Naming

When the file name is not specified (though users can specify the name only for automatic saving), the power meter automatically names the file as follows:

Automatic saving:	AWTHxxx.CSV
Manual saving of instantaneous values:	MWTHxxx.CSV
Setting file:	WTHxxx.SET

where xxx is the smallest, unused number from 000 to 029.

Appendix 4. Reactive Power

• Reactive Power

The calculation obtains the reactive power through the following formula from apparent power VA (the product of the rms values of the voltage and current) and active power P. Even if differing frequency elements are included in the voltage and current, it is calculated as the rms value.

To determine lead/lag of the voltage and current, calculation by the reactive power method is performed separately, and the polarity obtained by this method is used for polarity (SQ).

When the current lags behind the voltage : No polarity display

When the current leads the voltage : Polarity display is – (minus).

$$Q = SQ \sqrt{(VA)^2 - P^2}$$

Q = Reactive power

SQ = Polarity obtained through
the reactive power method

VA = Apparent power

P = Active power

The power factor is also obtained from the apparent power and the active power, and this power factor is called the rms value power factor. It is an operation that is used commonly. The polarity obtained with the reactive power method is used to be able to determine lead/lag of the power factor polarity as well.

• The reactive power method

The calculation shifts the current phase 90°, in the same manner as a common wattmeter, and measures the reactive power directly.

$$Q = \frac{1}{T} \int_0^T v(t) \times i(t + \frac{T}{4}) dt$$

Q = Reactive power

v(t), i(t) = Input signal

T = 1 cycle of input signal

Index

A

AC power 4-1, 14-6

B

Backlight 2-5, 12-1

Backup memory 1-3, 2-8, 2-9, 7-1,
7-3, 7-10, 9-13, 9-16, 9-17,
9-18, 10-6, 12-2, 13-1

C

Clamp-on current probe to be used

 Selecting 6-8, 7-27

Clearance of all settings and data 12-2

Clock 7-11, 12-1, 14-5, App1-1

Communication device 1-3, 2-8, 7-1,
7-3, 7-7, 7-19, 8-6, 12-5

Communication settings 1-3, 2-8, 7-1,
7-20

Connector 2-1, 2-2, 11-1, 11-2, 11-6,
14-6

CT 1-3, 2-6, 2-8, 3-5, 5-1, 5-4,
6-2, 6-3, 6-4, 6-6, 6-7, 6-9,
6-10, 7-1, 7-24, 7-25, 7-26,
7-29, 13-2, 14-5, App3-10

Current range 1-1, 2-5, 2-8, 4-6,
6-1, 6-2, 6-6, 6-7, 6-10, 7-24,
7-26, App3-9

Current ranges 6-8

Current transformer 2-6, 5-1, 5-4, 7-25

D

Data

 Displayed 8-1, 9-1

 Saving 1-1, 1-3, 2-8, 2-9, 7-1,
7-12, 7-13, 8-5, 8-6, 9-3,
9-4, 9-6, 9-13, 9-16, 10-5

Date 1-3, 2-8, 2-9, 4-5, 7-1, 7-9,
7-11, 8-7, 9-15, 9-22, 12-1,
12-2, App3-4, App3-6

Decimal point position 6-3, 6-4, 7-1,
7-29, 7-30, 7-31, 7-32

Device address 7-4, 11-8, App2-8

Device number 2-8, 7-1, 7-2, 7-3, 7-4,
7-9, 11-8, 12-2, App3-10

Dimensions 2-1, 14-6, 14-9, 14-10,
14-11, 14-12, 14-13

Display digits 6-1, 6-3, 6-4, 14-3, 14-4,
App2-10, App2-16, App3-9

E

Electric energy

 Clearing 1-3, 2-5, 7-9, 9-9

Electric energy measurement 1-3, 1-4,
4-6, 7-12, 7-13, 7-18, 7-33,
8-1, 8-5, 8-7, 9-1, 9-13, 9-15,
10-5, 10-6, 14-3, 14-5,
App2-13, App2-17,
App3-2, App3-3

Energy measurement 9-14

Energy measurement mode 7-3

External control 1-3, 2-2, 5-1, 7-14,
7-16, 9-3, 9-7, 9-19, 9-20,
9-21, 14-5, 14-6

F

File name 7-33, 8-6, 9-14, 9-16, 9-17,
10-5, 10-6, App2-9,
App2-10, App2-18, App3-9

Formatting 7-1

Frequency measurement 8-8, 8-9

I

Installation 3-3, 13-1

Instantaneous value measurement
1-3, 1-4, 2-5, 4-6, 8-1, 8-4,
8-5, 9-1, 9-8, 9-10, 9-13,
9-19, 10-5, 12-6, 14-2, App3-2

Integration

 Starting and stopping 9-3

Integration start date 8-7

Integration start date and time 2-8, 2-9,
 7-1, 7-14, 7-15, 8-7, 9-4, 9-5,
 9-6, 9-7, 9-15, App3-4,
 App3-6, App3-9
 Integration stop date and time 2-8,
 7-1, 7-16, 7-17, 9-7, 9-8

K

Key 2-5
 Key lock 12-1, 13-1

L

Loading 2-8, 7-1, 7-5

M

Maximum allowable input 2-6, 5-1
 Maximum allowable input voltage 5-1
 Measured file 13-2
 Measured-data file
 Naming 7-33
 Measured-data file
 Deleting 7-8, 13-2
 Measuring electric energy 9-1

N

Naming App3-12

O

Output interval 1-3, 2-8, 2-9, 7-1,
 7-12, 7-13, 7-15, 7-17, 7-18,
 8-5, 9-6, 9-7, 9-8, 9-13,
 10-5, 13-2, 14-3,
 App2-9, App3-9

P

PC card 4, 1-1, 1-3, 2-2, 2-8, 2-9, 4-2,
 7-1, 7-5, 7-7, 7-8, 7-10, 7-13,
 7-18, 8-5, 8-6, 9-3, 9-4, 9-6,
 9-13, 9-14, 9-15, 9-16, 9-17,
 9-22, 10-1, 10-2, 10-3, 10-4,
 10-5, 10-6, 10-7, 13-2, 14-4,
 App1-1, App2-10, App2-11,
 App2-18, App2-19, App2-23
 Enabling/Disabling data saving .. 7-18
 Formatting 1-3, 2-8, 7-8, 10-4

Personal computer 1-1, 7-19, 10-7,
 11-7, 12-5, App2-8
 Power failure and recovery
 Actions upon 9-22
 Power supply 2-2, 3-3, 3-5, 4-1, 4-2,
 4-3, 4-6, 13-1, 14-6, App1-1
 Printer 1-3, 2-2, 2-8, 7-7, 7-19, 8-6,
 11-1, 12-3, 12-4, 12-5,
 App1-1, App3-2, App3-10

R

Ranges 1-1, 6-1, 6-8, 7-27, 8-1, 9-2,
 13-1, 14-1, 14-4, 14-5, 14-9,
 14-11, 14-12
 Regenerative electric energy 1-4, 8-7,
 9-1, 9-15, 14-3,
 App3-4, App3-6
 Regenerative energy 7-9, 9-22, 12-2
 Resetting system 1-3, 7-9
 RS-232 2-2, 7-19, 9-19, 10-7, 11-1,
 11-2, 11-3, 11-7, 12-3, 12-5,
 14-4, 14-6, App2-8
 RS-485 2-2, 7-3, 7-4, 7-19, 10-7,
 11-6, 11-7, 11-8, 14-4, 14-6,
 App1-1, App2-8,
 App2-18, App2-19

S

Sampling 8-9, 14-1
 Self-test 4-4, 4-5, 13-1
 Setting decimal point position 7-29
 Setting device number 1-3
 Setting item 2-8, 6-8, 7-1, 7-2, 7-3,
 7-4, 7-5, 7-6, 7-7, 7-8, 7-9,
 7-10, 7-11, 7-12, 7-13, 7-14,
 7-15, 7-16, 7-18, 7-19, 7-20,
 7-21, 7-23, 7-25, 7-28, 7-30,
 7-31, 7-32, 9-9, 9-17, 9-18,
 10-4, 10-6
 Settings
 Loading 10-6, 14-4
 Loading/saving 1-3
 Saving 1-3, 2-8, 7-1, 7-5, 7-7, 10-6
 Startup screens 4-4, 4-6

T

Terminating resistor 11-6, 11-7

U

Unit 1-3, 1-4, 2-8, 5-3, 6-2, 6-3,
6-4, 7-1, 7-29, 7-30, 7-31,
7-32, 8-1, 8-3, 9-1, 9-11,
App2-10, App2-16,
App2-21, App3-9

V

Voltage and current ranges 6-2, 14-3
Voltage range 1-1, 2-5, 2-8, 4-1, 4-6,
6-1, 6-6, 6-7, 6-9, 6-10, 7-24,
7-26, 9-21, 14-4, App3-9
Voltage transformer 2-6, 5-1, 5-4, 7-23
VT 1-3, 2-6, 2-8, 5-1, 5-4, 6-2,
6-3, 6-6, 6-7, 6-9, 6-10, 7-1,
7-23, 7-24, 7-26, 7-29, 13-2,
14-5, App3-10

W

Wiring 1-1, 1-2, 2-5, 4-6, 5-1, 5-4,
5-6, 5-7, 5-8, 5-9, 6-11, 8-1,
9-2, 9-21, 11-7, 11-8, 14-5,
App2-13, App2-24,
App2-25, App2-26,
App2-27, App2-28, App3-9
Check Function 5-6
Diagrams 5-2
Method 1-3, 1-4, 2-5, 2-8, 5-3,
5-5, 5-7, 6-1, 6-6, 6-7,
6-9, 6-10, 7-28, 8-1, 8-2,
8-3, 8-6, 9-1, 9-2, 9-10,
9-11, 12-6, App3-4, App3-6
Methods 5-2

YOKOGAWA 
Yokogawa Meters & Instruments Corporation

Yokogawa Meters & Instruments Corporation

International Sales Dept.

Tachihi Bld. No.2, 6-1-3, Sakaecho, Tachikawa-shi, Tokyo 190-8586 Japan
Phone: 81-42-534-1413, Facsimile: 81-42-534-1426

YOKOGAWA CORPORATION OF AMERICA (U.S.A.)
Phone: 1-770-253-7000 Facsimile: 1-770-251-2088

YOKOGAWA EUROPE B. V. (THE NETHERLANDS)
Phone: 31-334-64-1611 Facsimile: 31-334-64-1610

YOKOGAWA ENGINEERING ASIA PTE. LTD. (SINGAPORE)
Phone: 65-6241-9933 Facsimile: 65-6241-2606

YOKOGAWA AMERICA DO SUL S. A. (BRAZIL)
Phone: 55-11-5681-2400 Facsimile: 55-11-5681-1274

YOKOGAWA MEASURING INSTRUMENTS KOREA CORPORATION (KOREA)
Phone: 82-2-551-0660 to -0664 Facsimile: 82-2-551-0665

YOKOGAWA AUSTRALIA PTY. LTD. (AUSTRALIA)
Phone: 61-2-9805-0699 Facsimile: 61-2-9888-1844

YOKOGAWA INDIA LTD. (INDIA)
Phone: 91-80-4158-6000 Facsimile: 91-80-2852-1441

YOKOGAWA SHANGHAI TRADING CO., LTD. (CHINA)
Phone: 86-21-6880-8107 Facsimile: 86-21-6880-4987

YOKOGAWA MIDDLE EAST E. C. (BAHRAIN)
Phone: 973-358100 Facsimile: 973-336100

LTD. YOKOGAWA ELECTRIC (RUSSIAN FEDERATION)
Phone: 7-095-737-7868 Facsimile: 7-095-737-7869