**User's
Manual**

UTAdvanced™

**UT35A/UT32A
Digital Indicating Controllers
User's Manual**

IM 05P01D31-01EN

vigilantplant.®

Product Registration

Thank you for purchasing YOKOGAWA products.

YOKOGAWA provides registered users with a variety of information and services. Please allow us to serve you best by completing the product registration form accessible from our homepage.

<http://www.yokogawa.com/ns/reg/>

Introduction

Thank you for purchasing the UT35A/UT32A digital indicating controller (hereinafter referred to as UT35A/UT32A).

This manual describes how to use UT35A/UT32A functions other than UT35A/UT32A's communication function and ladder sequence function. Please read through this user's manual carefully before using the product.

Note that the manuals for the UT35A/UT32A comprise the following six documents:

- **Printed manual**

Manual Name	Manual Number	Description
UT35A/UT32A Operation Guide	IM 05P01D31-11EN	This manual describes the basic operation method.

- **Electronic manuals**

Manual Name	Manual Number	Description
UT35A/UT32A Operation Guide	IM 05P01D31-11EN	This is identical to the printed manual.
UT35A/UT32A User's Manual	IM 05P01D31-01EN	This manual. It describes the usage of all functions except the ladder sequence and communication functions.
UTAdvanced Series Communication Interface (RS-485, Ethernet) User's Manual	IM 05P07A01-01EN	This manual describes how to use UT35A/UT32A in Ethernet and serial communications. For communication wiring, see the Operation Guide or User's Manual.
UTAdvanced Series Communication Interface (PROFIBUS-DP) User's Manual	IM 05P07A01-02EN	This manual describes how to use UT35A/UT32A in PROFIBUS-DP communications. For communication wiring, see the Operation Guide or User's Manual.
LL50A Parameter Setting Software Installation Manual	IM 05P05A01-01EN	This manual describes how to install and uninstall the LL50A.
LL50A Parameter Setting Software User's Manual	IM 05P05A01-02EN	This manual describes how to use the LL50A, ladder sequence function, peer-to-peer communication, and network profile creating function.

* User's Manual can be downloaded from a website.

Target Readers

This guide is intended for the following personnel;

- Engineers responsible for installation, wiring, and maintenance of the equipment.
- Personnel responsible for normal daily operation of the equipment.

Notice

- The contents of this manual are subject to change without notice as a result of continuing improvements to the instrument's performance and functions.
- Every effort has been made to ensure accuracy in the preparation of this manual. Should any errors or omissions come to your attention, however, please inform Yokogawa Electric's sales office or sales representative.
- Under no circumstances may the contents of this manual, in part or in whole, be transcribed or copied without our permission.

Trademarks

- Our product names or brand names mentioned in this manual are the trademarks or registered trademarks of Yokogawa Electric Corporation (hereinafter referred to as YOKOGAWA).
- Microsoft, MS-DOS, Windows, Windows XP, and Windows Vista are either registered trademarks or trademarks of Microsoft Corporation in the United States and/or other countries.
- Adobe, Acrobat, and Postscript are either registered trademarks or trademarks of Adobe Systems Incorporated.
- Ethernet is a registered trademark of XEROX Corporation in the United States.
- Modbus is a registered trademark of Schneider Electric.
- PROFIBUS-DP is a registered trademark of PROFIBUS User Organization.
- We do not use the TM or ® mark to indicate these trademarks or registered trademarks in this user's manual.
- All other product names mentioned in this user's manual are trademarks or registered trademarks of their respective companies.

Safety Precautions

This instrument is a product of Installation Category II of IEC/EN/CSA/UL61010-1 Safety Standards and Class A of EN61326-1, EN55011 (EMC Standards).



CAUTION

This instrument is an EMC class A product. In a domestic environment, this product may cause radio interference in which case the user needs to take adequate measures.

The instrument is a product rated Measurement Category I (CAT.I).

* Measurement Category I (CAT.I)

This category applies to electric equipment that measures a circuit connected to a low-voltage facility and receives power from stationary equipment such as electric switchboards.

To use the instrument properly and safely, observe the safety precautions described in this user's manual when operating it. Use of the instrument in a manner not prescribed herein may compromise protection features inherent in the device. We assume no liability for or warranty on a fault caused by users' failure to observe these instructions.

This instrument is designed to be used within the scope of Measurement Category I (CAT. I) and is dedicated for indoor use.

Notes on the User's Manual

- This user's manual should be readily accessible to the end users so it can be referred to easily. It should be kept in a safe place.
- Read the information contained in this manual thoroughly before operating the product.
- The purpose of this user's manual is not to warrant that the product is well suited to any particular purpose, but rather to describe the functional details of the product.

Safety, Protection, and Modification of the Product

The following symbols are used in the product and user's manuals to indicate safety precautions:



"Handle with Care" (This symbol is attached to the part(s) of the product to indicate that the user's manual should be referred to in order to protect the operator and the instrument from harm.)



AC



AC/DC



The equipment wholly protected by double insulation or reinforced insulation.



Functional grounding terminal (Do not use this terminal as a protective grounding terminal.)

- In order to protect the system controlled by this product and the product itself, and to ensure safe operation, observe the safety precautions described in this user's manual. Use of the instrument in a manner not prescribed herein may compromise the product's functions and the protection features inherent in the device. We assume no liability for safety, or responsibility for the product's quality, performance or functionality should users fail to observe these instructions when operating the product.
- Installation of protection and/or safety circuits with respect to a lightning protector; protective equipment for the system controlled by the product and the product itself; foolproof or failsafe design of a process or line using the system controlled by the product or the product itself; and/or the design and installation of other protective and safety circuits are to be appropriately implemented as the customer deems necessary.
- Be sure to use the spare parts approved by YOKOGAWA when replacing parts or consumables.
- This product is not designed or manufactured to be used in critical applications that directly affect or threaten human lives. Such applications include nuclear power equipment, devices using radioactivity, railway facilities, aviation equipment, air navigation facilities, aviation facilities, and medical equipment. If so used, it is the user's responsibility to include in the system additional equipment and devices that ensure personnel safety.
- Modification of the product is strictly prohibited.



WARNING

- **Power Supply**
Ensure that the instrument's supply voltage matches the voltage of the power supply before turning ON the power.
 - **Do Not Use in an Explosive Atmosphere**
Do not operate the instrument in locations with combustible or explosive gases or steam. Operation in such environments constitutes an extreme safety hazard. Use of the instrument in environments with high concentrations of corrosive gas (H₂S, SO_x, etc.) for extended periods of time may cause a failure.
 - **Do Not Remove Internal Unit**
The internal unit should not be removed by anyone other than YOKOGAWA's service personnel. There are dangerous high voltage parts inside. Additionally, do not replace the fuse by yourself.
 - **Damage to the Protective Construction**
Operation of the instrument in a manner not specified in this user's manual may damage its protective construction.
-

Warning and Disclaimer

- YOKOGAWA makes no warranties regarding the product except those stated in the WARRANTY that is provided separately.
- The product is provided on an “as is” basis. YOKOGAWA assumes no liability to any person or entity for any loss or damage, direct or indirect, arising from the use of the product or from any unpredictable defect of the product.

Notes on Software

- YOKOGAWA makes no warranties, either expressed or implied, with respect to the software’s merchantability or suitability for any particular purpose, except as specified in the terms of the separately provided warranty.
- This software may be used on one specific machine only.
- To use the software on another machine, the software must be purchased again separately.
- It is strictly prohibited to reproduce the product except for backup purposes.
- Store the software CD-ROM (the original medium) in a safe place.
- All reverse-engineering operations, such as reverse compilation or the reverse assembly of the product are strictly prohibited.
- No part of the product’s software may be transferred, converted, or sublet for use by any third party, without prior written consent from YOKOGAWA.

Handling Precautions for the Main Unit

- The instrument comprises many plastic components. To clean it, wipe it with a soft, dry cloth. Do not use organic solvents such as benzene or thinner for cleaning, as discoloration or deformation may result.
- Keep electrically charged objects away from the signal terminals. Not doing so may cause the instrument to fail.
- Do not apply volatile chemicals to the display area, operation keys, etc. Do not leave the instrument in contact with rubber or PVC products for extended periods. Doing so may result in failure.
- If the equipment emits smoke or abnormal smells or makes unusual noises, turn OFF the instrument’s power immediately and unplug the device. In such an event, contact your sales representative.

Checking the Contents of the Package

Unpack the box and check the contents before using the product. If the product is different from that which you have ordered, if any parts or accessories are missing, or if the product appears to be damaged, contact your sales representative.

UT35A/UT32A Main Unit

The UT35A/UT32A main units have nameplates affixed to the side of the case. Check the model and suffix codes inscribed on the nameplate to confirm that the product received is that which was ordered.

No. (Instrument number)

When contacting your sales representative, inform them of this number, too.

Model and Suffix Codes of UT35A

[Style:S1]

Model	Suffix code	Optional suffix code	Description
UT35A			Digital Indicating Controller (provided with retransmission output or 15 V DC loop power supply, 2 DIs, and 3 DOs) (Power supply: 100-240 V AC)
Type 1: Basic control	-0		Standard type
	-1		Position proportional type
	-2		Heating/cooling type
Type 2: Functions	0		None
	1		2 additional DIs, 2 additional DOs
	2		5 additional DIs, 5 additional DOs
Type 3: Open networks	0		None
	1		RS-485 communication (Max.38.4 kbps, 2-wire/4-wire)
	2		Ethernet communication (with serial gateway function)
	4		PROFIBUS-DP communication
Display language (*1)	-10		English
	-20		German
	-30		French
	-40		Spanish
Fixed code		-00	Always "-00"
Optional suffix codes		/LP	24 V DC loop power supply (*2)
		/HA	Heater break alarm (*3)
		/DC	Power supply 24 V AC/DC
		/CT	Coating (*4)

- *1: English, German, French, and Spanish can be displayed as the guide display.
 *2: The /LP option can be specified in the combination of Type 2 code (any of "0" or "1") and Type 3 code (any of "0" or "1".)
 *3: The /HA option can be specified when the Type 1 code is "-0" or "-2."
 *4: When the /CT option is specified, the UT35A does not conform to the safety standards (UL and CSA) and CE marking.

Model and Suffix Codes of UT32A

[Style:S1]

Model	Suffix code	Optional suffix code	Description
UT32A			Digital Indicating Controller (provided with retransmission output or 15 V DC loop power supply, 2 DIs, and 3 DOs) (Power supply: 100-240 V AC)
Type 1: Basic control	-0		Standard type
	-1		Position proportional type
	-2		Heating/cooling type
Type 2: Functions	0		None
	1		RS-485 communication (Max. 38.4 kbps, 2-wire/4-wire)
	2		2 additional DIs and 2 additional DOs
Type 3: Open networks	0		None
Display language (*1)	-10		English
	-20		German
	-30		French
	-40		Spanish
Fixed code		-00	Always "-00"
Optional suffix codes		/LP	24 V DC loop power supply (*2)
		/HA	Heater break alarm (*3)
		/DC	Power supply 24 V AC/DC
		/CT	Coating (*4)

- *1: English, German, French, and Spanish can be displayed as the guide display.
 *2: The /LP option can be specified in the combination of Type 1 code (any of "-0" or "-1") and Type 2 code (any of "0" or "1".) Additionally, when the Type 2 code is "1", the RS-485 communication is 2-wire system.
 *3: The /HA option can be specified when the Type 1 code is "-0" or "-2."
 *4: When the /CT option is specified, the UT32A does not conform to the safety standards (UL and CSA) and CE marking.

Coating Treatment

(1)HumiSeal coating treatment

Apply HumiSeal coating to the printed circuit board assembly.

Do not apply HumiSeal coating to the following parts: connector, gold-plated contact area, relay part, RJC device, and in the vicinity of the push switch/LED lamp.

(2)Apply terminal coating to the gold-plated contact area on the printed circuit board.

Notes

- There are two treatments as described above, but we do not guarantee their effectiveness.

We do not supply any test data on these treatments.

- Do not apply any treatment to the screw terminal area on the back side of the instrument.

Accessories

The product is provided with the following accessories according to the model and suffix codes. Check that none of them are missing or damaged.

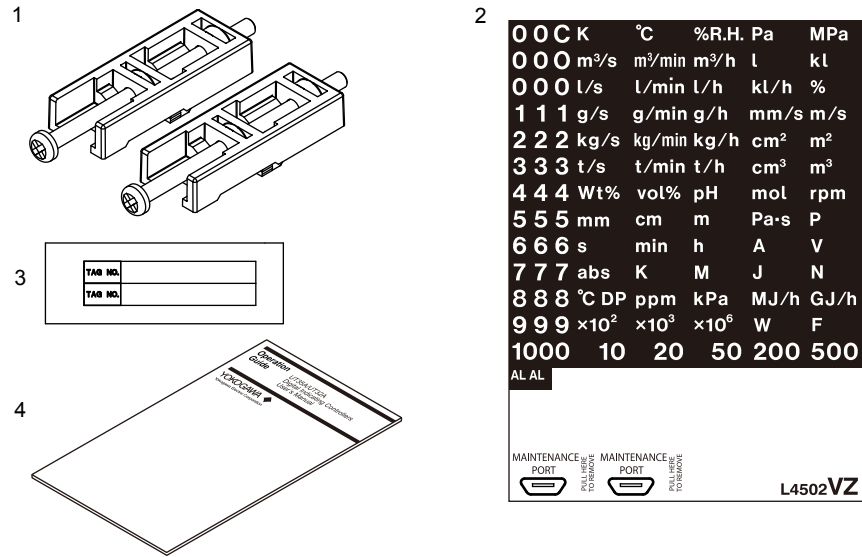

No.	Product Name	Quantity	Remark
1	Brackets	2	For fixing the upper and lower parts
2	Unit label	1	Part number: L4502VZ
3	Tag label	1	Part number: L4502VE
4	Operation Guide	1	A3 size, x 6

Accessory (sold separately)

The following lists an accessory sold separately.

- LL50A Parameter Setting Software

Model	Suffix code	Description
LL50A	-00	Parameter Setting Software

- Terminal cover

For UT35A, Model: UTAP001

For UT32A, Model: UTAP002

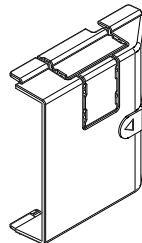

For UT35A



For UT32A

- User's Manual (A4 size)
 - * User's Manual can be downloaded from a website.
- User's Manual (CD-ROM), Model: UTAP003
 - * Contains all manuals.

Symbols Used in This Manual



This symbol is used on the instrument. It indicates the possibility of injury to the user or damage to the instrument, and signifies that the user must refer to the user's manual for special instructions. The same symbol is used in the user's manual on pages that the user needs to refer to, together with the term "WARNING" or "CAUTION."

WARNING

Calls attention to actions or conditions that could cause serious or fatal injury to the user, and indicates precautions that should be taken to prevent such occurrences.

CAUTION

Calls attention to actions or conditions that could cause injury to the user or damage to the instrument or property and indicates precautions that should be taken to prevent such occurrences.

Note

Identifies important information required to operate the instrument.



Indicates related operations or explanations for the user's reference.



Indicates a character string displayed on the display.

Setting Display

Indicates a setting display and describes the keystrokes required to display the relevant setting display.

Setting Details

Provides the descriptions of settings.

Description

Describes restrictions etc. regarding a relevant operation.

How to Use This Manual

For the ladder sequence and communication functions, see the respective manuals. This user's manual is organized into Chapters 1 to 19 as shown below. This manual mainly uses the illustrations of the UT35A for describing the operations and functions. The basic operations are the same for the UT32A, so please read them in the same way.

Chapter	Title and Description
1	Introduction to Functions Describes the main functions of the UT35A/UT32A.
2	UT35A/UT32A Operating Procedures Describes the flow from unpacking to regular operations.
3	Part Names Describes part names and functions on the front panel.
4	Basic Operation Describes basic operation of the UT35A/UT32A.
5	Quick Setting Function Describes the minimum necessary settings for operation.
6	Monitoring and Control of Regular Operations Describes monitoring displays of regular operations and operation.
7	Input (PV) Functions Describes PV input.
8	Control Functions Describes basic control and advanced control.
9	Auxiliary Control Functions Describes auxiliary control functions
10	Output (Control and Retransmission) Functions Describes output functions.
11	Alarm Functions Describes alarm output and status output.
12	Contact Input/Output Functions Describes contact input/output functions.
13	Display, Key, and Security Functions Describes display, user function key and security functions.
14	Parameter Initialization Describes the initialization to factory default values and to user default values.
15	Power Failure Recovery Processing/Power Frequency Setting/Other Settings Describes operations performed after momentary power interruption and power failures.
16	Troubleshooting, Maintenance, and Inspections Describes troubleshooting, maintenance, periodic inspections, and disposal.
17	Installation and Wiring Describes installation and wiring.
18	Parameters Provides parameter maps.
19	Specifications Provides the UT35A/UT32A specifications.

Contents

Introduction.....	i
Target Readers.....	i
Notice	i
Trademarks	ii
Safety Precautions	ii
Handling Precautions for the Main Unit.....	iv
Checking the Contents of the Package.....	iv
Model and Suffix Codes of UT35A.....	v
Model and Suffix Codes of UT32A.....	v
Symbols Used in This Manual.....	viii
How to Use This Manual	ix
Chapter 1 Introduction to Functions	
1.1 Quick Setting Function	1-1
1.2 Input/Output Function.....	1-2
1.3 Control Functions	1-4
1.4 Display and Key Functions.....	1-6
1.5 Ladder Sequence Function	1-7
1.6 Communication Functions.....	1-8
1.7 Definition of Main Symbols and Terms	1-11
Chapter 2 UT35A/UT32A Operating Procedures	
2.1 UT35A/UT32A Operating Procedures.....	2-1
Chapter 3 Part Names	
3.1 Names and Functions of Display Parts	3-1
3.2 Names and Functions of Keys	3-4
3.3 List of Display Symbols	3-7
3.4 Brief Description of Setting Details (Parameters)	3-9
Chapter 4 Basic Operation	
4.1 Overview of Display Switch and Operation Keys	4-1
4.2 How to Set Parameters	4-4
Chapter 5 Quick Setting Function	
5.1 Setting Using Quick Setting Function.....	5-1
Flowchart of Quick Setting Function.....	5-2
5.2 Restarting Quick Setting Function.....	5-6
Chapter 6 Monitoring and Control of Regular Operations	
6.1 Monitoring and Control of Operation Displays.....	6-1
6.1.1 Operation Display Transitions.....	6-1
Standard Type	6-1
Position Proportional Type.....	6-2
Heating/cooling Type	6-3
Two-position two-level control.....	6-4
6.2 Setting Target Setpoint.....	6-9
Operation in the Operation Display.....	6-9
Operation in Parameter Setting Display	6-10
6.3 Performing and Canceling Auto-tuning.....	6-11
6.4 Adjusting PID Manually	6-14

Contents

6.5	Setting Alarm Setpoint.....	6-20
6.6	Selecting Target Setpoint Number (SPNO).....	6-21
6.7	Switching Operation Modes	6-22
6.7.1	Switching between AUTO and MAN	6-22
6.7.2	Switching between STOP and RUN	6-24
6.7.3	Switching between REM (Remote) and LCL (Local)	6-26
6.8	Manipulating Control Output during Manual Operation.....	6-28
6.9	Releasing On-State (Latch) of Alarm Output.....	6-29

Chapter 7 Input (PV) Functions

7.1	Setting Functions of PV Input.....	7-1
7.1.1	Setting Input Type, Unit, Range, Scale, and Decimal Point Position.....	7-1
7.1.2	Setting Burnout Detection for Input.....	7-3
7.1.3	Setting Reference Junction Compensation (RJC) or External Reference Junction Compensation (ERJC)	7-4
7.1.4	Correcting Input Value	7-5
	(1) Setting Bias and Filter	7-5
7.1.5	Setting Ratio Bias	7-6

Chapter 8 Control Functions

8.1	Control Function Block Diagrams.....	8-1
8.1.1	Single-loop Control, Heating/cooling Control, Position Proportional Control, and Two-position Two-level Control	8-1
	■ Single-loop Control Function Block Diagram	8-2
	■ Heating/cooling Control Function Block Diagram	8-4
	■ Position Proportional Control Function Block Diagram	8-6
	■ Two-position Two-level Control Function Block Diagram	8-8
8.2	Setting Control Type (CNT).....	8-10
8.2.1	PID Control	8-11
8.2.2	ON/OFF Control (1 point of hysteresis / 2 points of hysteresis)	8-12
8.2.3	Heating/cooling Control	8-14
8.2.4	Two-position Two-level Control	8-20
8.2.5	PD Control (Stable Control in Which a Setpoint is not Exceeded)	8-22
8.3	Setting PID Control Mode (ALG).....	8-23
8.4	Switching PID	8-25
8.4.1	Switching PID According to Target Setpoint Number (SPNO).....	8-25
8.4.2	Switching PID According to PV.....	8-26
8.4.3	Switching PID According to SP.....	8-28
8.4.4	Switching PID According to Target SP.....	8-30
8.4.5	Switching PID According to Deviation (Reference Deviation).....	8-32
8.4.6	Setting Hysteresis at Time of PID Switch	8-33
8.5	Suppressing Overshoot (Super Function)	8-34
8.6	Suppressing Hunting (Super2 Function)	8-36
8.7	Suppressing Integral Action (Anti-reset Wind-up)	8-38
8.8	Adjusting Auto-tuning Operation	8-39

Chapter 9 Auxiliary Control Functions

9.1	Setting SP Limiter.....	9-1
9.2	Changing SP at a Fixed Rate (SP Ramp-Rate Setting Function)	9-2
9.3	Forcing SP to Track PV (PV Tracking)	9-4
9.4	Forcing SP to Track Remote Input (SP Tracking).....	9-5
9.5	Setting Controller Action at Power ON (Restart Mode)	9-6
9.6	Setting Time between Powering on Controller and Starting Control (Restart Timer)	9-7

Chapter 10 Output (Control and Retransmission) Functions

10.1	Setting Control Output Type	10-1
10.2	Setting Control Output Cycle Time	10-5
10.3	Setting Limiter to Control Output	10-6
10.4	Disabling Output Limiter in MAN mode	10-7
10.5	Setting Velocity Limiter to Control Output.....	10-8
10.6	Reducing 4-20 mA Current Output to 0 mA (Tight Shut Function)	10-9
10.7	Setting ON/OFF Control Hysteresis	10-10
10.8	Canceling Offset of PV and SP (Manual Reset).....	10-12
10.9	Setting Hysteresis and Dead Band for Heating/cooling Control Output.....	10-13
10.10	Setting Hysteresis and Dead Band for Position Proportional Control Output.....	10-15
10.11	Setting Retransmission Output Terminal, Type, and Scales.....	10-16
10.12	Setting Preset Output Value	10-18
	10.12.1 Setting Output Value in STOP Mode (Preset Output).....	10-18
	10.12.2 Setting Output Value When Switched to MAN Mode (Manual Preset Output)	10-20
	10.12.3 Setting Output Value When Error Occurs (Input Error Preset Output).....	10-21
10.13	Changing Current Output Range.....	10-22
10.14	Adjusting Motor-operated Valve Position (Position Proportional Output)	10-23
	10.14.1 Setting Valve Operation Mode	10-24
	10.14.2 Adjusting Valve Position Automatically	10-24
	10.14.3 Adjusting Valve Position Manually	10-25
	10.14.4 Setting Valve Traveling Time (Estimating Type).....	10-26
	10.14.5 Selecting Feedback Input (Resistor/Current).....	10-26
10.15	Using 15 V DC Loop Power Supply	10-27

Chapter 11 Alarm Functions

11.1	Setting Alarm Type	11-1
11.2	Setting Number of Alarm Groups to Use	11-13
11.3	Setting Hysteresis to Alarm Operation	11-14
11.4	Delaying Alarm Output (Alarm Delay Timer)	11-15
11.5	Setting Alarm Output to Control Relay Terminal.....	11-16
11.6	Setting Alarm Action According to Operation Mode.....	11-17
11.7	Setting Heater Break Alarm.....	11-18

Chapter 12 Contact Input/Output Functions

12.1	Setting Contact Input Function	12-1
	12.1.1 Setting Contact Input Function	12-1
	12.1.2 Changing Contact Type of Contact Input.....	12-9
12.2	Setting Contact Output Function	12-10
	12.2.1 Setting Function of Contact Output.....	12-10
	12.2.2 Changing Contact Type of Contact Output.....	12-14

Chapter 13 Display, Key, and Security Functions

13.1	Setting Display Functions.....	13-1
	13.1.1 Setting Active Color PV Display Function.....	13-1
	13.1.2 Masking Arbitrary Display Value in Operation Display.....	13-4
	13.1.3 Registering SELECT Display (Up to 5 Displays)	13-5
	13.1.4 Changing Event Display	13-6
	13.1.5 Registering SELECT Parameter Display (Up to 10 Displays).....	13-8
	13.1.6 Setting Bar-graph Display Function	13-10
	13.1.7 Masking Least Significant Digit of PV Display	13-12
	13.1.8 Setting Economy Mode.....	13-13



13.1.9	Selecting the Initial Operation Display that Appears at Power ON	13-14
13.1.10	Setting Message Function	13-15
13.1.11	Switching Guide Display Language	13-15
13.1.12	Changing Guide Scroll Speed	13-16
13.1.13	Turning Guide Display ON/OFF	13-16
13.1.14	Setting Automatic Return to Operation Display	13-16
13.1.15	Setting Brightness and Contrast Adjustment of LCD and Display Update Cycle..	13-17
13.2	Assigning Function to User Function Key and A/M Key	13-18
13.3	Setting Security Functions.....	13-21
13.3.1	Setting a Password.....	13-21
13.3.2	Setting Parameter Display Level	13-21
13.3.3	Locking (Hiding) Parameter Menu Display	13-22
13.3.4	Key Lock	13-23
13.3.5	Setting Display/Non-display of Operation Display	13-23
13.3.6	Prohibiting Writing via Communication	13-24
13.4	Confirmation of Key and I/O Condition and Version	13-25
13.4.1	Confirmation of Key and I/O Condition	13-25
13.4.2	Confirmation of Version	13-28

Chapter 14 Parameter Initialization

14.1	Initializing Parameter Settings to Factory Default Values.....	14-1
14.2	Registering and Initializing User Default Values.....	14-2
14.2.1	Registering as User Setting (Default) Values.....	14-2
14.2.2	Initializing to User Setting (Default) Values.....	14-2

Chapter 15 Power Failure Recovery Processing / Power Frequency Setting / Other Settings

15.1	Remedies if Power Failure Occurs during Operations	15-1
15.2	Power Frequency Setting	15-2

Chapter 16 Troubleshooting, Maintenance, and Inspections

16.1	Troubleshooting.....	16-1
16.1.1	Troubleshooting Flowchart.....	16-1
16.1.2	Errors at Power On	16-2
16.1.3	Errors during Operation	16-4
16.2	Maintenance.....	16-15
16.2.1	Cleaning.....	16-15
16.2.2	Packaging when Shipping the Product for Repair	16-15
16.2.3	Replacing Parts	16-15
16.3	Periodic Maintenance	16-16
16.4	Disposal.....	16-17

Chapter 17 Installation and Wiring

17.1	Installation Location.....	17-1
17.2	Mounting Method.....	17-3
17.3	External Dimensions and Panel Cutout Dimensions	17-4
17.4	Wiring	17-5
17.4.1	Important Information on Wiring	17-5
17.4.2	PV Input Wiring.....	17-7
17.4.3	Control Output (Relay, Current, and Voltage Pulse) Wiring.....	17-8
17.4.4	Valve Position Output and Feedback Input Wiring	17-10
17.4.5	Contact Input Wiring	17-11
17.4.6	Contact Output Wiring	17-13

17.4.7	Retransmission Output Wiring	17-14	1
17.4.8	15 V DC Loop Power Supply Wiring	17-15	2
17.4.9	24 V DC Loop Power Supply Wiring	17-15	3
17.4.10	Heater Break Alarm Wiring	17-16	4
17.4.11	RS-485 Communication Interface Wiring	17-17	5
17.4.12	Coordinated Operation Wiring	17-18	6
17.4.13	Peer-to peer Communication Wiring	17-19	7
17.4.14	Ethernet Communication Interface Wiring	17-20	8
17.4.15	PROFIBUS-DP Communication Interface Wiring	17-22	9
17.4.16	Power Supply Wiring	17-24	10
17.5	Attaching and Detaching Terminal Cover	17-25	11
Chapter 18 Parameters			
18.1	Parameter Map	18-1	12
18.2	List of Parameters	18-8	13
18.2.1	Operation Parameters	18-8	14
18.2.2	Setup Parameters	18-15	15
Chapter 19 Specifications			
19.1	Hardware Specifications	19-1	16
19.1.1	Input Specifications	19-2	17
19.1.2	Analog Output Specifications	19-3	18
19.1.3	Step Response Time Specifications	19-4	19
19.1.4	Relay Contact Output Specifications	19-4	20
19.1.5	Position Proportional Output Specifications	19-4	21
19.1.6	Retransmission Output Specifications	19-4	22
19.1.7	15 V DC Loop Power Supply Specifications	19-4	23
19.1.8	Contact Input Specifications	19-5	24
19.1.9	Transistor Contact Output Specifications	19-5	25
19.1.10	Heater Break Alarm Specifications	19-5	26
19.1.11	24 V DC Loop Power Supply Specifications	19-5	27
19.1.12	Safety and EMC Standards	19-6	28
19.1.13	Construction, Installation, and Wiring	19-6	29
19.1.14	Power Supply Specifications and Isolation	19-7	30
19.1.15	Environmental Conditions	19-8	31
Appendix Input and Output Table			
	Appendix 1 Input and Output Table	App-1	32
Revision Information			

1.1 Quick Setting Function

The Quick setting function is a function to easily set the basic function of the controller.

Buy and
Unpacking



Installation
and Wiring



Setup



Operation



Check the contents.

Installation and Wiring: Chapter 17

Install and wire a controller, and then turn on the pov



Q: What should I do to perform control immediately?
First, I want to set the input and output.

A: Use the Quick setting function to perform the
setup easily.

Quick setting function: Chapter 5

Q: How do I determine the PID?

A: Use Auto-tuning to perform the tuning easily.
Auto-tuning: Section 6.3

1.2 Input/Output Function

PV Input (equipped as standard)

PV input is a universal input to arbitrarily set the type and range for the thermocouple (TC), resistance-temperature detector (RTD), and DC voltage/current.

▶ [Chapter 7 Input \(PV\) Functions](#)

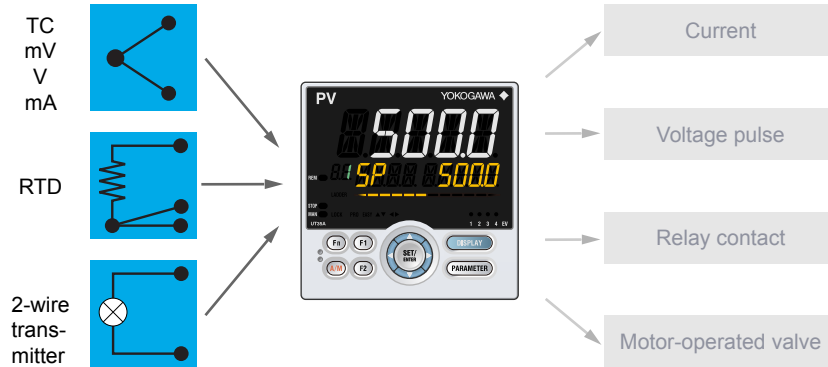

Control Output (equipped as standard)

Control output (OUT) is a universal output to arbitrarily set the type for the current, voltage pulse, and relay. Heating/cooling control and Position proportional control are possible by specifying the suffix code for the control.

Position proportional control is used exclusively for the motor-operated valve (suffix code: Type 1 = -1).

Heating/cooling control is for two output type of heat and cool (suffix code: Type 1 = -2).

▶ [Chapter 10 Output \(Control and Retransmission\) Functions](#)

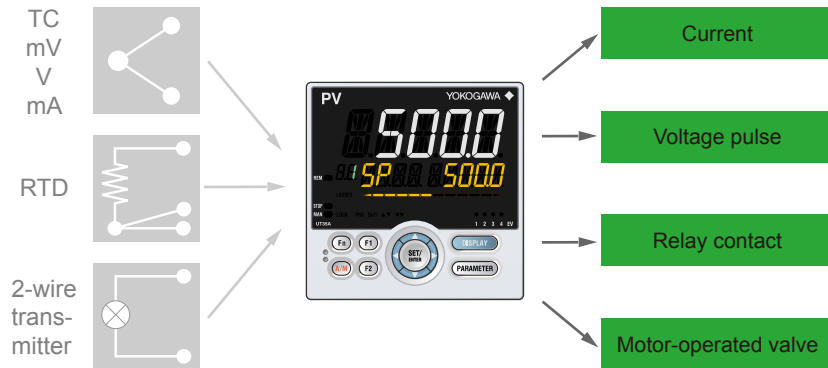

Retransmission Output (equipped as standard)

Retransmission output outputs a PV input value (PV), target setpoint (SP), control output value (OUT) and the like as an analog signal to, for example, the recorder.

▶ [Chapter 10 Output \(Control and Retransmission\) Functions](#)

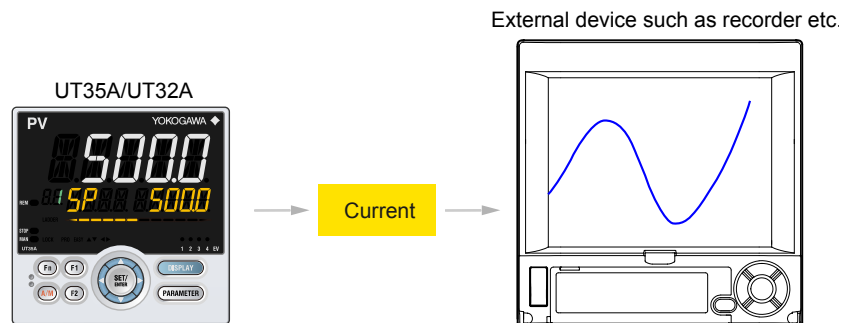

Contact Input

Up to 7 contact inputs can be incorporated. The operation modes can be switched. PID control and sequence control can be performed simultaneously using the ladder sequence function.

For details, see the table of Model and Suffix Codes.

▶ [Chapter 12 Contact Input/Output Functions](#)

Contact Output

Up to 8 contact outputs can be incorporated. Contact output can output events such as alarms.

PID control and sequence control can be performed simultaneously using the ladder sequence function.

For details, see the table of Model and Suffix Codes.

▶ [Chapter 11 Alarm Functions](#)

24 V DC Loop Power Supply (optional suffix code: /LP)

24 V DC loop power supply can be supplied to 2-wire transmitter.

▶ [17.4.10 24 V DC Loop Power Supply Wiring](#)

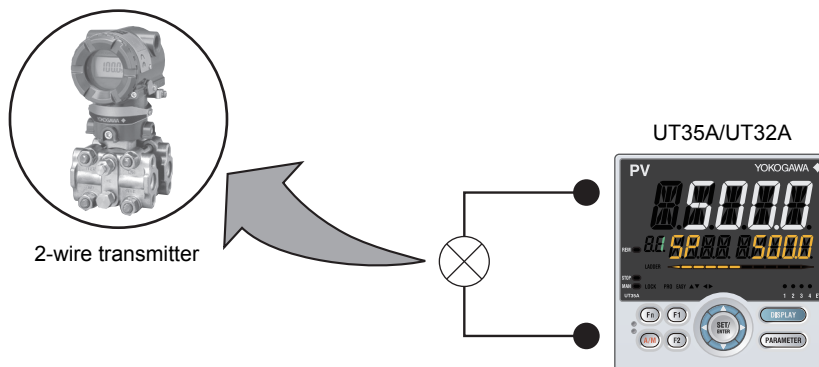

1.3 Control Functions

PID Control

PID control is a general control using the PID control-related parameters.

▶ 8.2.1 PID Control

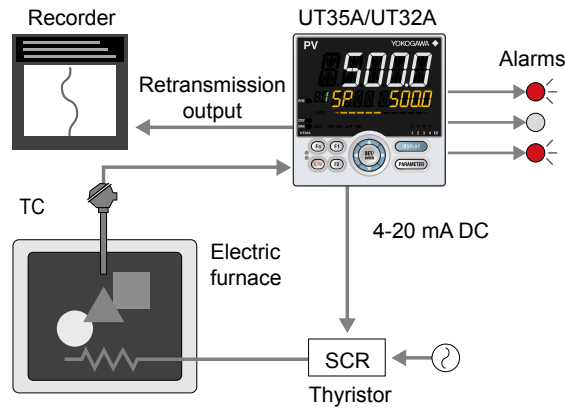

Heating/cooling Control (suffix code: Type 1 = -2)

Heating/cooling control is available only for Heating/cooling type.

In Heating/cooling control, the controller outputs the result of control computation after splitting it into heating-purpose and cooling-purpose signals.

▶ 8.2.3 Heating/cooling Control

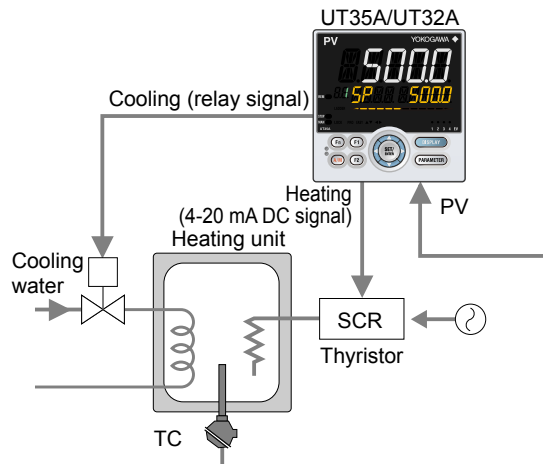

Position Proportional Control (suffix code: Type 1 = -1)

Position proportional control is available only for Position proportional type. It is used exclusively for the motor-operated valve.

- ▶ 10.14 Adjusting Motor-operated Valve Position (Position Proportional Output)

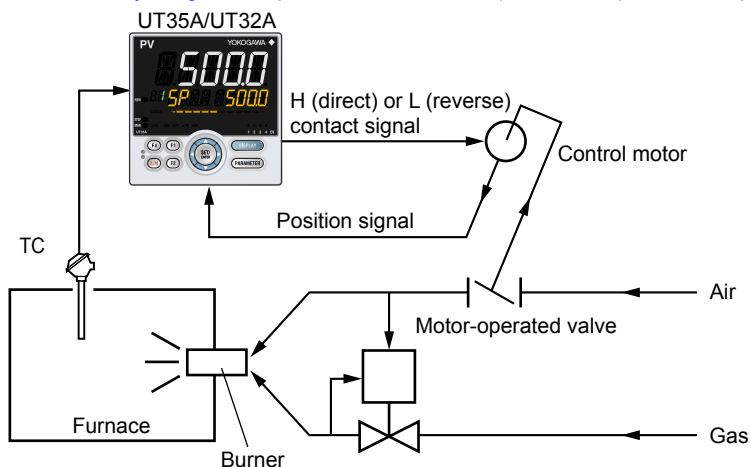

Two-position Two-level Control (suffix code: Type 1 = -2)

Two-position two-level control has two target setpoints to control ON and OFF respectively.

- ▶ 8.2.4 Two-position Two-level Control

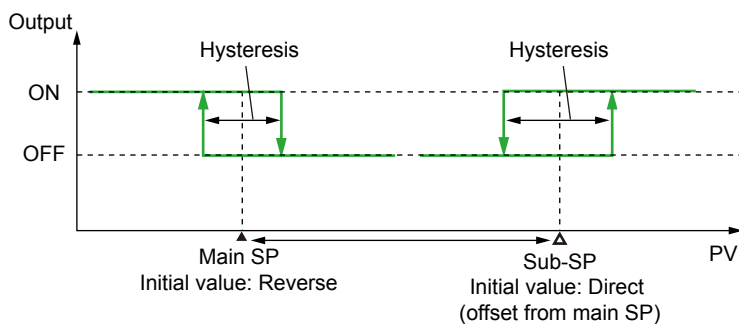

1.4 Display and Key Functions

Employing a 14-segment, active color LCD greatly increases the monitoring and operating capabilities.

Active Color PV Display (display color change)

The active color PV display function changes the PV display color (red or white) when abnormality occurs in PV etc.

▶ [13.1.1 Setting Active Color PV Display Function](#)

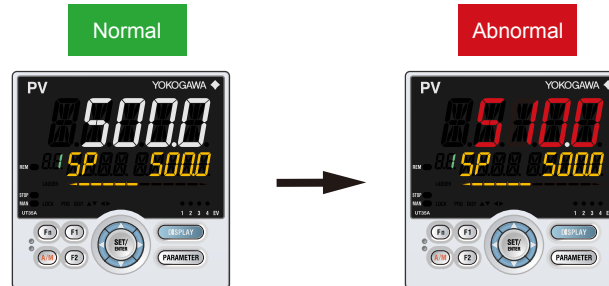

Guide Display

The guide is displayed on PV display when setting parameters. This guide can be turned on/off with the Fn key.

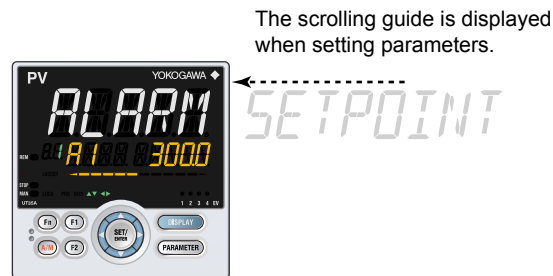

Multilingual Guide Display

English, German, French, or Spanish can be displayed in Guide display.

▶ [13.1.11 Switching Guide Display Language](#)

Parameter Display Level

To intended use of the operator, the display level of the parameter can be set.

▶ [Chapter 18 Parameters](#)

User Function Keys

The UT35A has user function keys (F1, F2, and Fn).

The UT32A has a user function key (Fn).

Assign a function to a user function key to use it as an exclusive key.

▶ [13.2 Assigning Function to User Function Key and A/M Key](#)

1.5 Ladder Sequence Function

To use the ladder sequence function, it is necessary to create a ladder program using LL50A Parameter Setting Software and download it to a controller.

- ▶ [Ladder sequence function: LL50A Parameter Setting Software User's Manual](#)

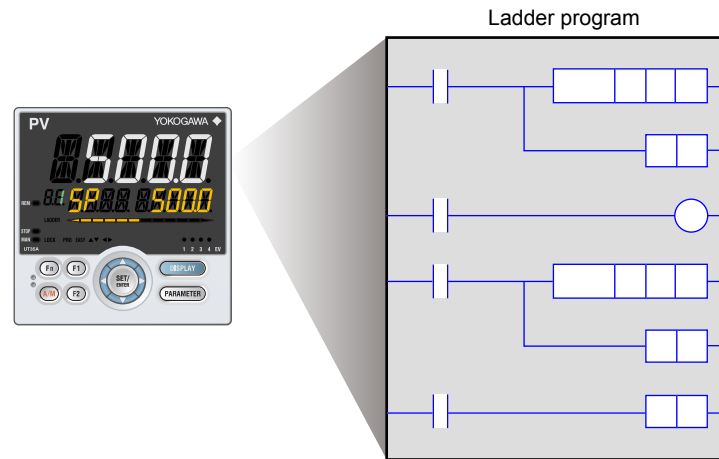

1.6 Communication Functions

The UT35A/UT32A can use RS-485 communication, Ethernet communication, and PROFIBUS-DP communication by specifying the suffix code and optional suffix code for each communication.

▶ [UTAdvanced Series Communication Interface \(RS-485, Ethernet\) User's Manual](#)

RS-485 Communication (Modbus communication, PC link communication, and Ladder communication)

The UT35A/UT32A can communicate with PCs, PLCs, touch panels, and other devices.

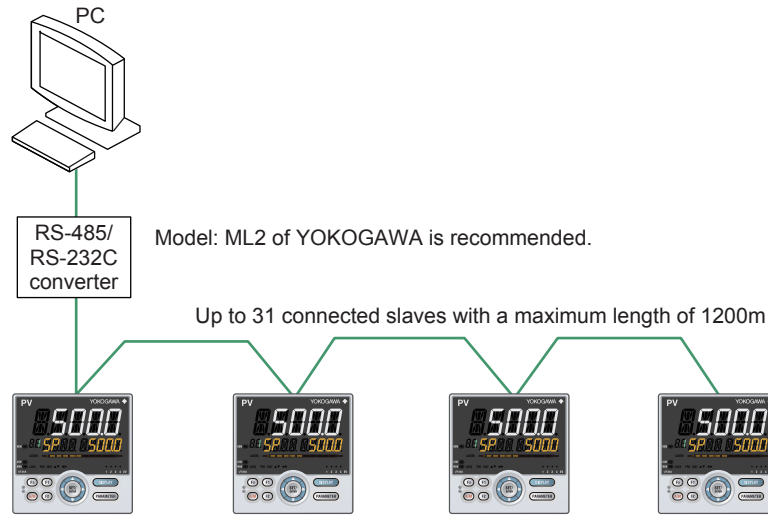

Ethernet Communication (Modbus/TCP)

The UT35A can be connected to IEEE802.3-compliant network (10BASE-T/100BASE-TX). A serial gateway function can increase the number of connected controllers.

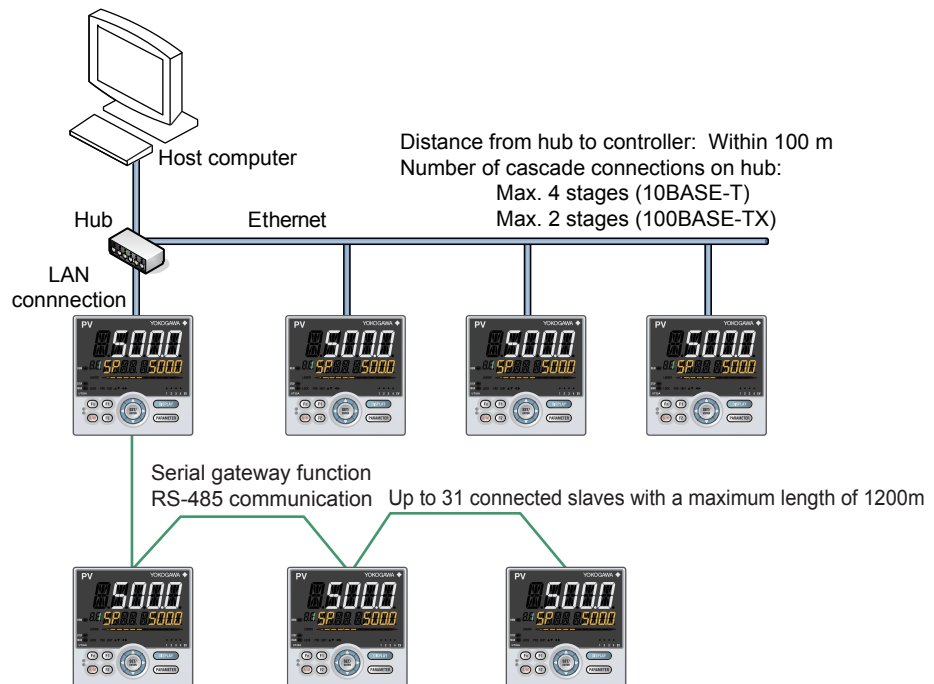

PROFIBUS-DP Communication

The UT35A can be used as the slave devices for PROFIBUS-DP communication. Read-out of PV, operation or alarm status, and SP setting can be done by accessing the remote I/O on the master unit of PROFIBUS-DP.

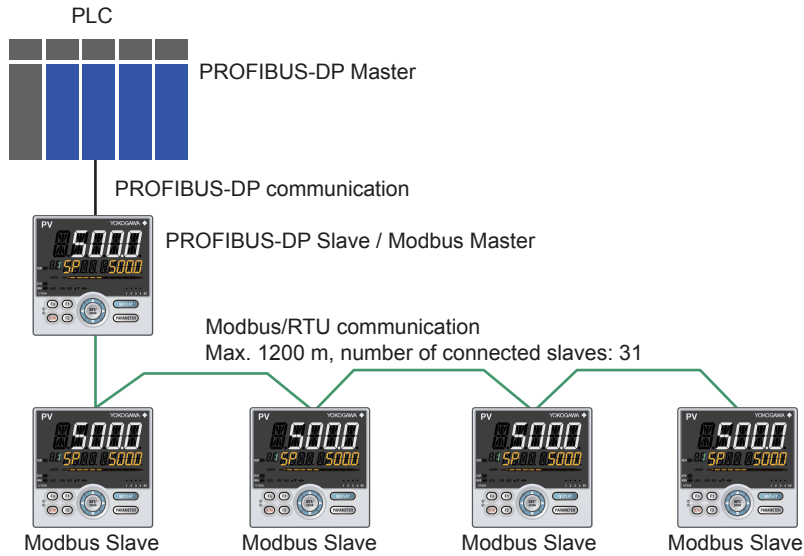

Peer-to-peer Communication

In Peer-to-peer communication, controllers send and receive process data each other and share data. However, ladder program creation using LL50A Parameter Setting Software is necessary.

▶ Ladder program: [LL50A Parameter Setting Software User's Manual](#)

Controller No. 1 to 4 can transmit and receive data. Controller No. 5 to 32 can only receive data.

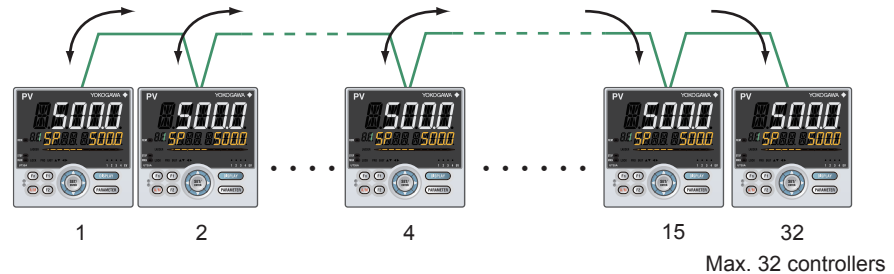

Coordinated Operation

A system of coordinated operation is configured with a master controller and a number of slave controllers. The slave controllers are set to operate in the same way as the master controller. Therefore you do not have to create a communication program.

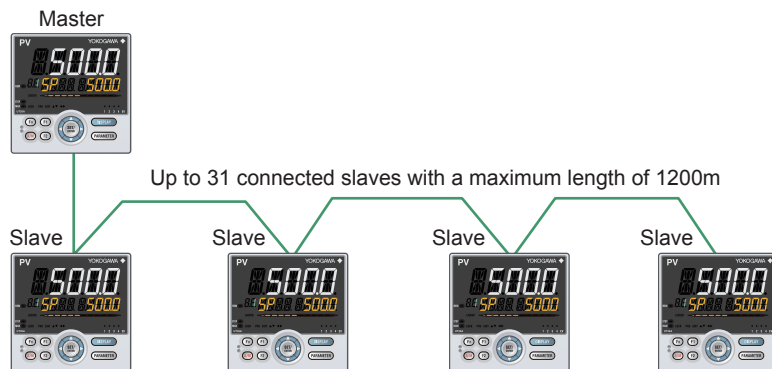

Light-loader Communication

Use the LL50A to set parameters and create ladder programs. Attach the adapter to the front of the controller to communicate.

- ▶ [Light-loader function: LL50A Parameter Setting Software User's Manual](#)

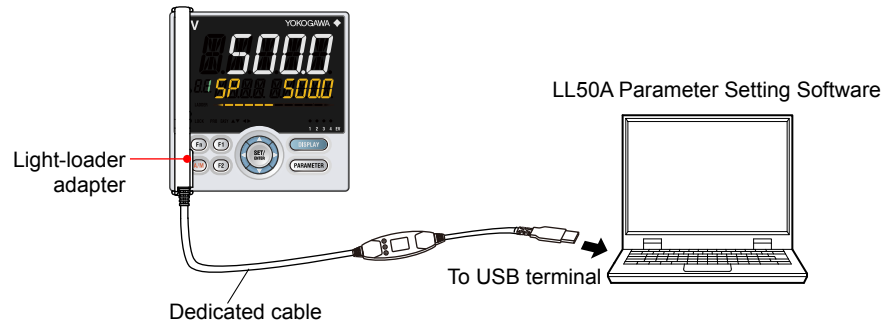

Maintenance Port Communication (Power supply is not required for the UT35A/UT32A)

Maintenance port is used to connect with the dedicated cable when using LL50A Parameter Setting Software (sold separately). The parameters can be set without supplying power to the UT35A/UT32A.

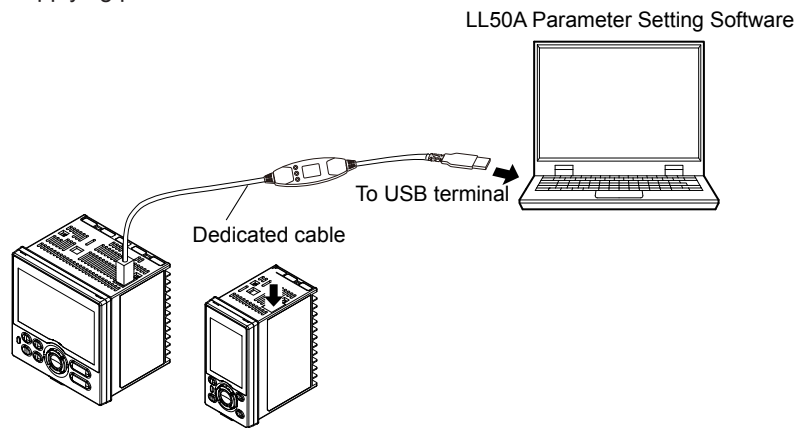

CAUTION

When using the maintenance port, do not supply power to the controller. Otherwise, the controller does not work normally.

If power is supplied to the controller while the cable is connected, or the cable is connected to the controller already turned on, unplug the cable and turn on the controller again. The controller returns to the normal condition.

1.7 Definition of Main Symbols and Terms

Main Symbol

PV: Measured input value
 SP: Target setpoint
 OUT: Control output value

A/M: AUTO/MAN
 AUTO: Automatic
 MAN: Manual
 REMOTE, REM: Remote
 LOCAL, LCL: Local

E1, E3, and E4: Terminal areas
 ► [17.4 Wiring](#)

Engineering Units

Input range (scale): the PV range low limit is set to 0%, and the high limit is set to 100% for conversion.

Input range (scale) span: the PV range span is set to 100% for conversion.

In this manual, the parameter setting range is described as the “input range” and “input range span.” This means that engineering units are required to be set. Set a temperature for temperature input.

The following describes a conversion example.

When the PV input range is 100 to 600°C, 0% of the PV range is equivalent to 100°C, 50% of the PV range is equivalent to 350°C, and 100% of the PV range is equivalent to 600°C.

100% of the PV range span is equivalent to 500°C.

20% of the PV range span is equivalent to 100°C.

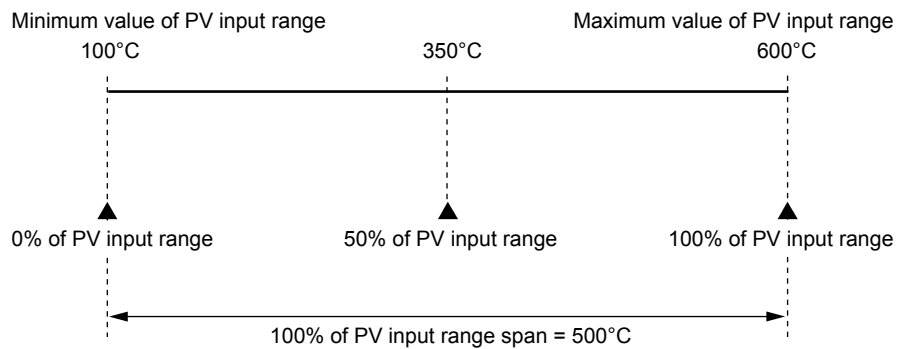

The above applies to the scale for voltage and current input.

2.1 UT35A/UT32A Operating Procedures

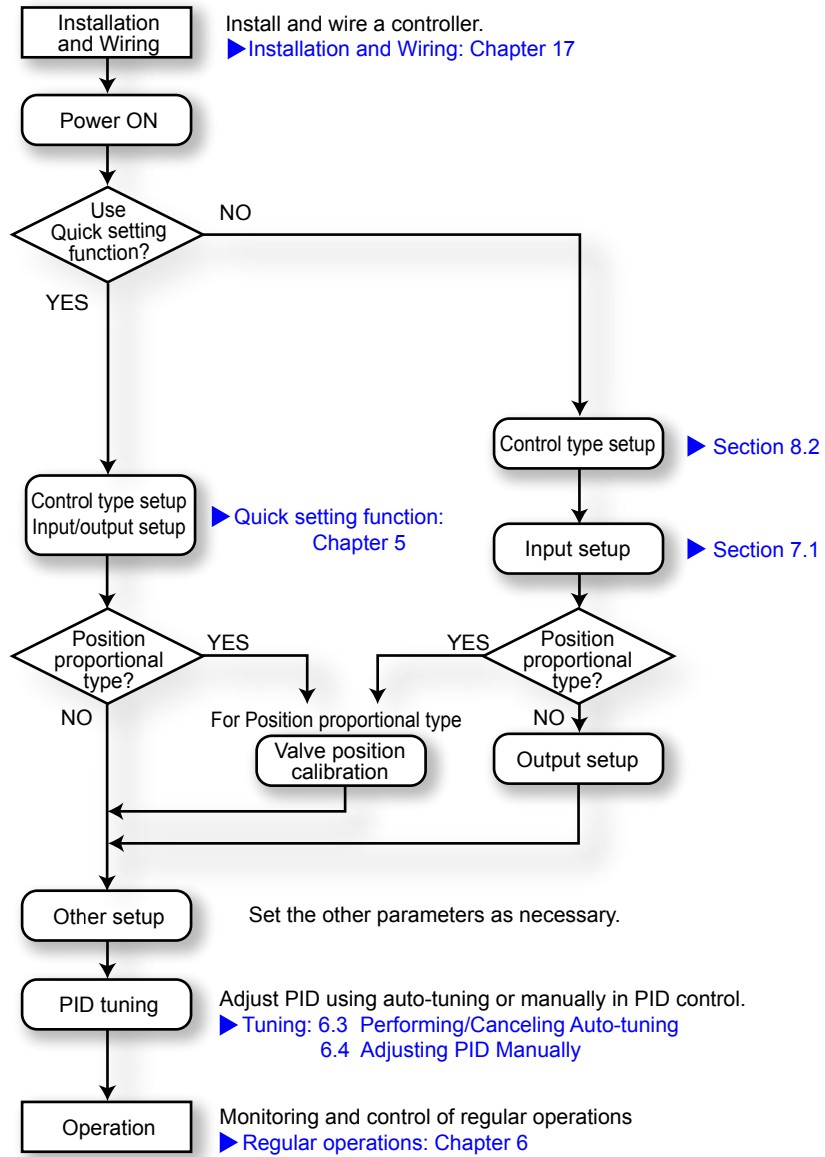

3.1 Names and Functions of Display Parts

See the next page.

3.1 Names and Functions of Display Parts

UT35A

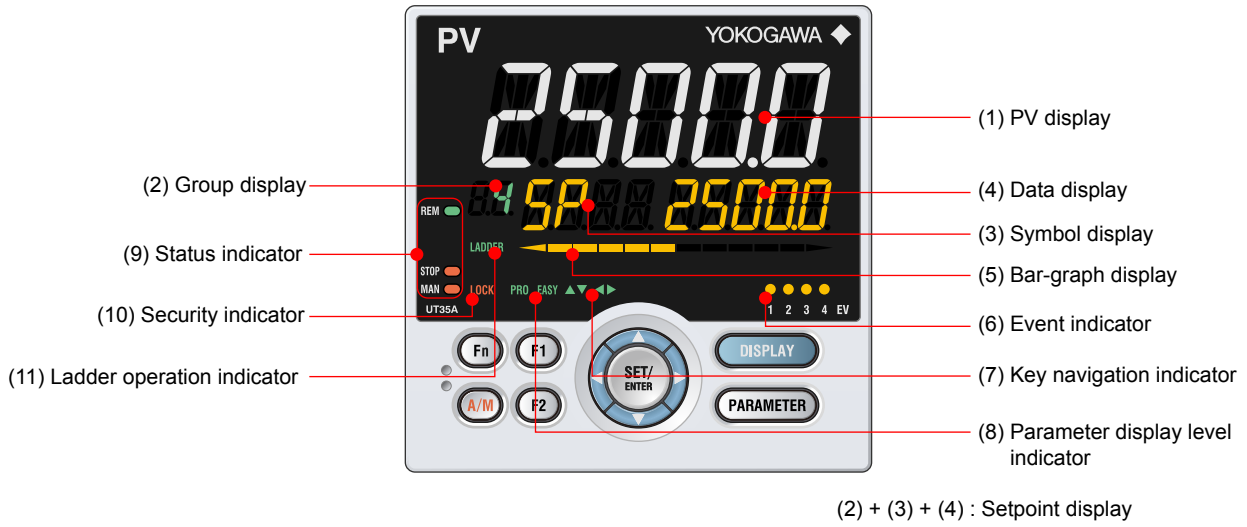

UT32A

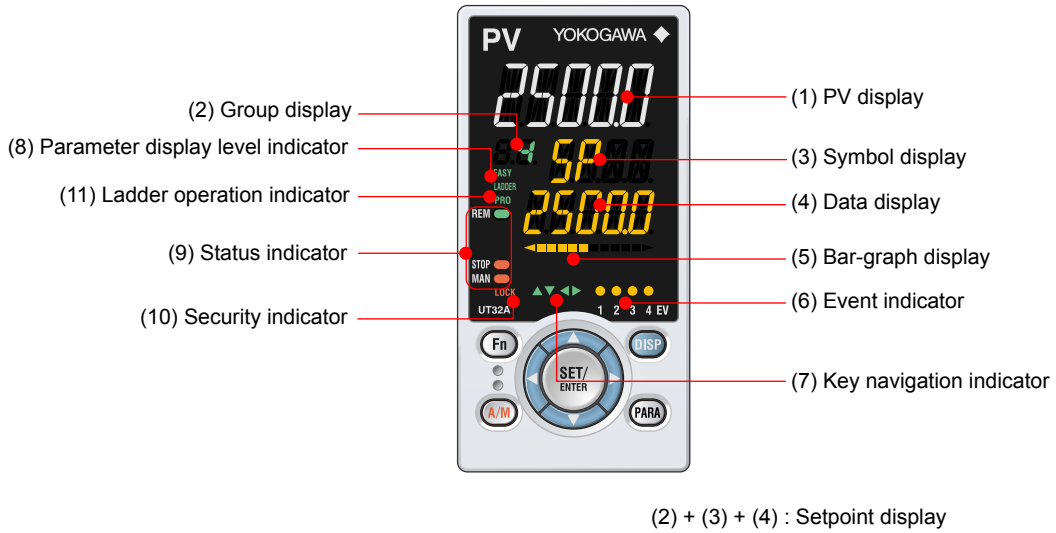

3.1 Names and Functions of Display Parts

No. in figure	Name	Description												
(1)	PV display (white or red)	Displays PV. Displays an error code if an error occurs. Displays the scrolling guide in the Menu Display and Parameter Setting Display when the guide display ON/OFF is set to ON.												
(2)	Group display (green)	Displays a group number (1 to 4, or R) and terminal area (E1 to E4). 1 to 4 represent SP numbers in the Operation Display. R and E1 to E4 are displayed in the Parameter Setting Display.												
(3)	Symbol display (orange)	Displays a parameter symbol.												
(4)	Data display (orange)	Displays a parameter setpoint and menu symbol.												
(5)	Bar-graph display (orange)	Displays control output value (OUT) and measured input value (PV). The data to be displayed can be set by the parameter. Initial value: deviation, in Heating/cooling control: heating-side control output												
(6)	Event indicator (orange)	Lit when the alarms 1 to 4 occur. Event displays other than alarms can be set by the parameter.												
(7)	Key navigation indicator (green)	Lit or blinks when the Up/Down or Left/Right arrow key operation is possible.												
(8)	Parameter display level indicator (green)	Displays the setting conditions of the parameter display level function. <table border="1"> <thead> <tr> <th>Parameter display level</th> <th>EASY</th> <th>PRO</th> </tr> </thead> <tbody> <tr> <td>Easy setting mode</td> <td>Lit</td> <td>Unlit</td> </tr> <tr> <td>Standard setting mode</td> <td>Unlit</td> <td>Unlit</td> </tr> <tr> <td>Professional setting mode</td> <td>Unlit</td> <td>Lit</td> </tr> </tbody> </table>	Parameter display level	EASY	PRO	Easy setting mode	Lit	Unlit	Standard setting mode	Unlit	Unlit	Professional setting mode	Unlit	Lit
Parameter display level	EASY	PRO												
Easy setting mode	Lit	Unlit												
Standard setting mode	Unlit	Unlit												
Professional setting mode	Unlit	Lit												
(10)	Status indicator (green and red)	Displays the operating conditions and control status. <table border="1"> <thead> <tr> <th>Display</th> <th>Description</th> </tr> </thead> <tbody> <tr> <td>REM</td> <td>Lit when in remote mode (REM).</td> </tr> <tr> <td>STOP</td> <td>Lit when in stop mode (STOP).</td> </tr> <tr> <td>MAN</td> <td>Lit when in manual mode (MAN). Blinks during auto-tuning.</td> </tr> </tbody> </table>	Display	Description	REM	Lit when in remote mode (REM).	STOP	Lit when in stop mode (STOP).	MAN	Lit when in manual mode (MAN). Blinks during auto-tuning.				
Display	Description													
REM	Lit when in remote mode (REM).													
STOP	Lit when in stop mode (STOP).													
MAN	Lit when in manual mode (MAN). Blinks during auto-tuning.													
(11)	Security indicator (red)	Lit if a password is set. The setup parameter settings are locked.												
(12)	Ladder operation indicator (green)	Lit while the ladder operation is executed.												

3.2 Names and Functions of Keys

UT35A

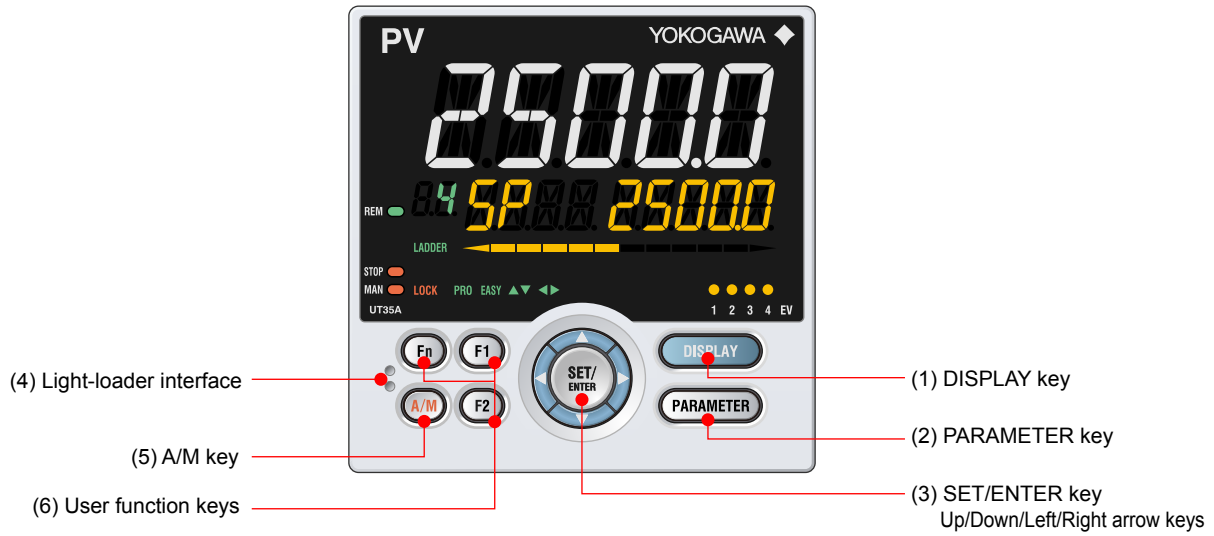

UT32A

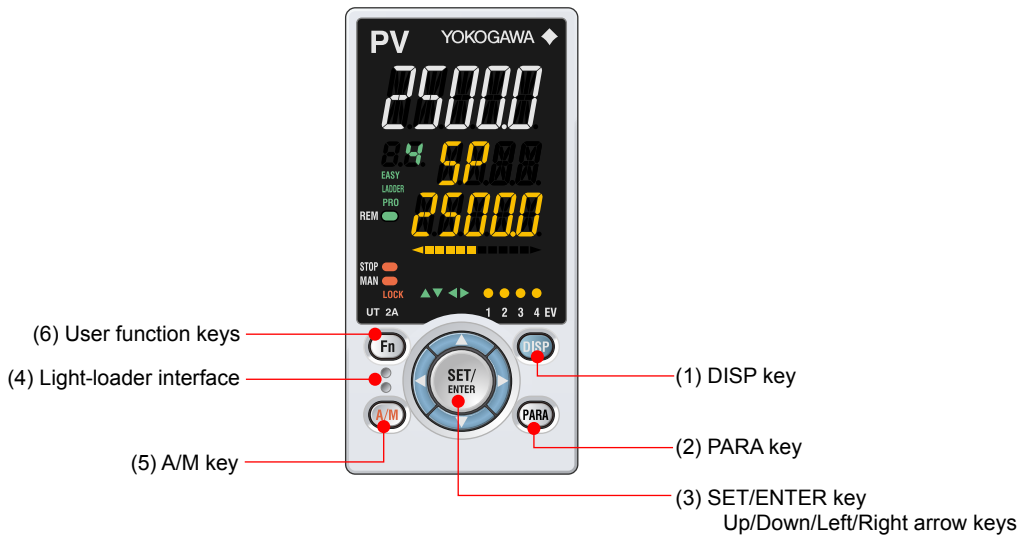

No. in figure	Name	Description
(1)	UT35A: DISPLAY key UT32A: DISP key	Used to switch the Operation Displays. Press the key in the Operation Display to switch the provided Operation Displays. Press the key in the Menu Display or Parameter Setting Display to return to the Operation Display.
(2)	UT35A: PARAMETER key UT32A: PARA key	Hold down the key for 3 seconds to move to the Operation Parameter Setting Display. Hold down the key and the Left arrow key simultaneously for 3 seconds to move to the Setup Parameter Setting Display. Press the key in the Parameter Setting Display to return to the Menu Display. Press the key once to cancel the parameter setting (setpoint is blinking).
(3)	SET/ENTER key Up/Down/ Left/Right arrow keys	SET/ENTER key Press the key in the Menu Display to move to the Parameter Setting Display of the Menu. Press the key in the Parameter Setting Display to transfer to the parameter setting mode (setpoint is blinking), and the parameter can be changed. Press the key during parameter setting mode to register the setpoint. Up/Down/Left/Right arrow keys Press the Left/Right arrow keys in the Menu Display to switch the Displays. Press the Up/Down/Left/Right arrow keys in the Parameter Setting Display to switch the Displays. Press the Up/Down arrow keys during parameter setting mode (setpoint is blinking) to change a setpoint. Press the Left/Right arrow keys during parameter setting mode (setpoint is blinking) to move between digits according to the parameter.
(4)	Light-loader interface	It is the communication interface to the adapter cable when setting and storing parameters via PC. The LL50A Parameter Setting Software (sold separately) is required.
(5)	A/M key	Used to switch between AUTO and MAN modes. The setting is switched between AUTO and MAN each time the key is pressed. The user can assign a function key.
(6)	User function keys	The UT35A has F1, F2, and Fn keys. The UT32A has only the Fn key. The user can assign a function to the key. The function is set by the parameter.

3.2 Names and Functions of Keys

Maintenance Port (Power supply is not required for the UT35A/UT32A).

The maintenance port is used to connect with the dedicated cable when using LL50A Parameter Setting Software (sold separately). The parameters can be set without supplying power to the UT35A/UT32A.

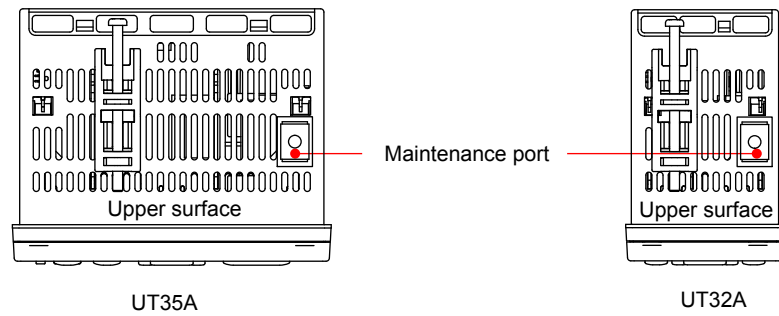

CAUTION

When using the maintenance port, do not supply power to the controller. Otherwise, the controller does not work normally.

If power is supplied to the controller while the cable is connected, or the cable is connected to the controller already turned on, unplug the cable and turn on the controller again. The controller returns to the normal condition.

3.3 List of Display Symbols

The following shows the parameter symbols, menu symbols, alphanumeric of guide, and symbols which are displayed on the UT35A/UT32A.

Figure (common to all display area)

0 1 2 3 4 5 6 7 8 9

PV display (14 segments): Alphabet

A B C D E F

 G H I J K L

 M N O P Q R

 S T U V W X

 Y Z

Symbol display and Data display (11 segments): Alphabet

A B C D E F

 C (lower-case)

 G H I J K L

 M N O P Q R

 S T U V W X

 Y Z

3.3 List of Display Symbols

Group display (7 segments): Alphabet

A	B	C	D	E	F
G	H	I	J	K	L
M	N	O	P	Q	R
S	T	U	V	W	X
					None
Y	Z				

PV display (14 segments): Symbol

Space	-	/	'	,

3.4 Brief Description of Setting Details (Parameters)

This manual describes the Setting Details as follows in addition to the functional Description.

Setting Details

(Display Example)

Parameter symbol	Name	Display level	Setting range	Menu symbol
A1 to A4	Alarm-1 to -4 setpoint	EASY	Set a display value of setpoint of PV alarm, SP alarm, deviation alarm, output alarm, or velocity alarm. -19999 to 30000 (Set a value within the input range.) Decimal point position depends on the input type	SP Ope

(1) Parameter symbol: Symbol displayed on Symbol display on the front panel.

(2) Name: Parameter name

(3) Display level: Indicates the parameter display level.

(4) Setting range: Parameter setting range

(5) Menu symbol: Indicates the menu to which the parameter belongs.

Ope: Operation parameter

Set: Setup parameter

Parameter Display Level

Display level	Description
EASY	Easy setting mode: The minimum necessary parameters are displayed. Corresponding parameters are displayed in all modes.
STD	Standard setting mode: The wider range of parameters than those shown in Easy setting mode are displayed. Corresponding parameters are displayed only in Standard setting mode and Professional setting mode. Parameter display level indicators "EASY" and "PRO" are unlit in Standard setting mode. *: "STD" is the symbol used in this manual only.
PRO	Professional setting mode: All parameters are displayed. Corresponding parameters are displayed only in Professional setting mode.

Note

For more intelligible display operation of parameters and the references, see Chapter 18, "Parameter Map."

4.1 Overview of Display Switch and Operation Keys

The following shows the transition of Operation Display, Operation Parameter Setting Display, and Setup Parameter Setting Display.

The "Operation Parameter Setting Display" has the parameters for setting the functions necessary for the operation.

The "Setup Parameter Setting Display" has the parameters for setting the basic functions of the controller.

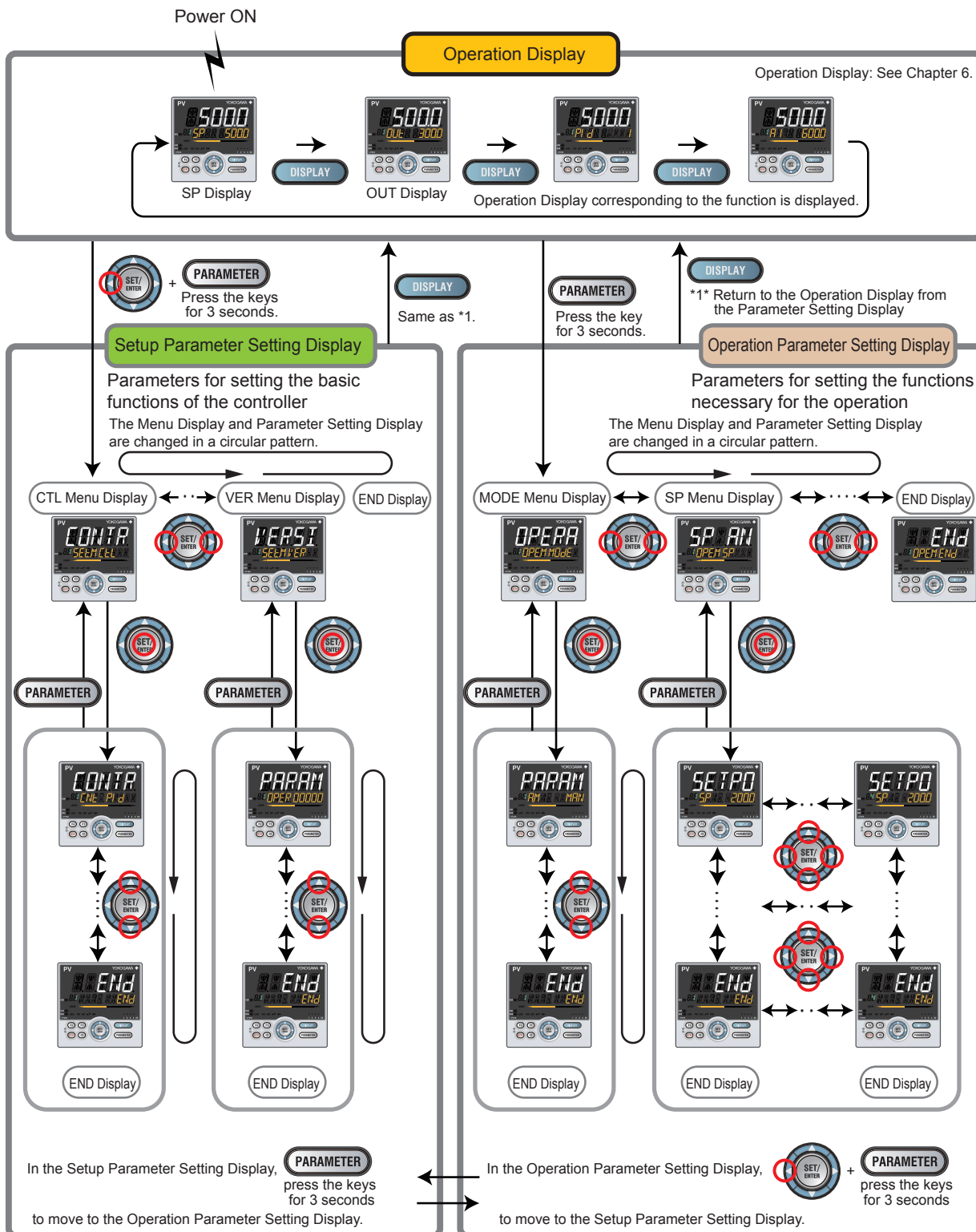

4.1 Overview of Display Switch and Operation Keys

The display pattern of the UT35A/UT32A is as follows; the Menu Display and Parameter Setting Display.

For the Operation Display, see Chapter 6, "Monitoring and Control of Regular Operations."

Display	Description
<p>Menu Display</p>	<p>The Menu Display is segmented by the function and optional terminal position. The scrolling guide for the menu is displayed on PV display. The guide display can be turned on/off with the Fn key.</p> <p>Menu Display of Operation Parameter</p> <p>The scrolling guide for the menu is displayed.</p> <p>OPE.M is displayed. Menu symbol is displayed. Group number or Terminal area is displayed.</p> <p>Menu Display of Setup Parameter</p> <p>The scrolling guide for the menu is displayed.</p> <p>SET.M is displayed. Menu symbol is displayed. Group number or Terminal area is displayed.</p>
<p>Parameter Setting Display</p>	<p>The following is the Display for displaying and setting a parameter. The parameters have three types of display levels; Easy setting mode, Standard setting mode, and Professional setting mode. The parameters to be displayed can be limited according to the setting of the parameter display level. The scrolling guide for the parameter is displayed on PV display. The guide display can be turned on/off with the Fn key.</p> <p>Parameter Setting Display (Example of Operation Parameter Setting Display)</p> <p>The scrolling guide for the parameter is displayed.</p> <p>Parameter symbol is displayed. Setpoint is displayed. Group number or Terminal area is displayed.</p>

Display Shown at the End (the Lowest Level) of the Parameter Setting Display

As shown in the figure below, the END Display is shown to indicate the end of the Menu Display and Parameter Setting Display. There are no setting items.

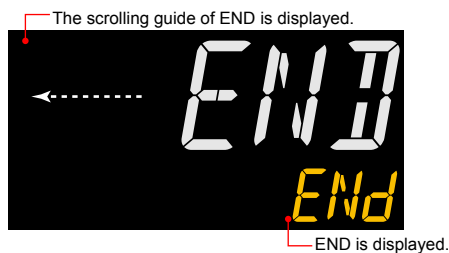
**Basic Key Operation Sequence**

- **To move to the Setup Parameter Setting Display**

Hold down the PARAMETER (or PARA) key and the Left arrow key simultaneously for 3 seconds.

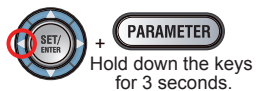

- **To move to the Operation Parameter Setting Display**

Hold down the PARAMETER (or PARA) key for 3 seconds.



Hold down the key for 3 seconds.

- **To move to the Operation Display**

Press the DISPLAY (or DISP) key once.



4.2 How to Set Parameters

The following operating procedure describes an example of setting alarm setpoint (A1).

Operation

1. Hold down the **PARAMETER** key for 3 seconds in the Operation Display to call up the **[MODE]** Menu Display.

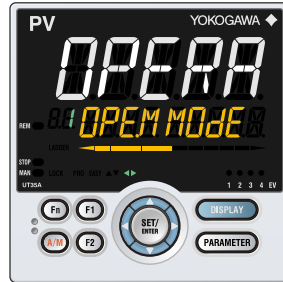

2. Press the **Right arrow** key to display the **[SP]** Menu Display.



3. Press the **SET/ENTER** key to display the **[SP]** Parameter Setting Display.

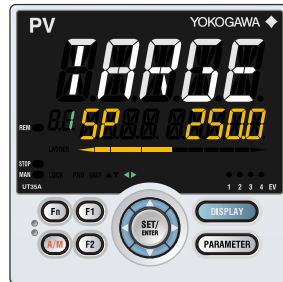

4. Press the **Down arrow** key to display the **[A1]** Parameter Setting Display.

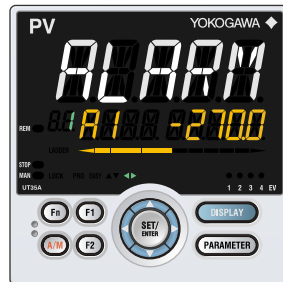

5. Press the **SET/ENTER** key to blink the setpoint.

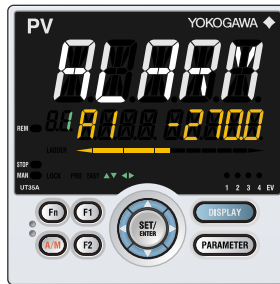

6. Press the **Up** or **Down arrow** key to change the setpoint.
(Change the setpoint using the Up/Down arrow keys to increase and decrease the value and the Left/Right arrow keys to move between digits.)

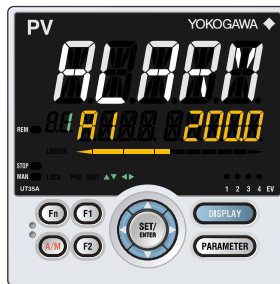

7. Press the **SET/ENTER** key to register the setpoint (the setpoint stops blinking).

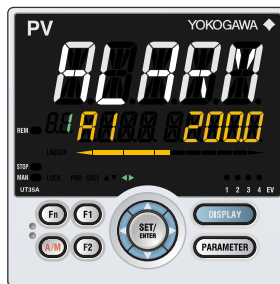

8. Press the **PARAMETER** key once to return to the Menu Display. Press the **DISPLAY** key once to return to the Operation Display.

This completes the setting procedure.

How to Cancel Parameter Setting

To cancel parameter setting when a parameter is being set (setpoint is blinking), press the **PARAMETER** key once.

How to Set Parameter Setpoint

Numeric Value Setting

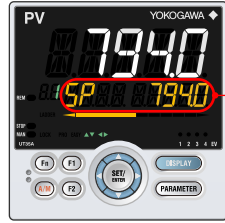

1. Display the Parameter Setting Display.



2. Press the SET/ENTER key to move to the setting mode (the setpoint blinks).



3. Press the Left arrow key to move one digit to the left. (Press the Right arrow key to move one digit to the right.)



4. Press the Up or Down arrow key to change the setpoint. Press the Up arrow key when 9 is displayed to move one digit to the left. Press the Down arrow key when 0 is displayed to move one digit to the right.



5. Press the SET/ENTER key to register the setpoint.

Selection Data Setting

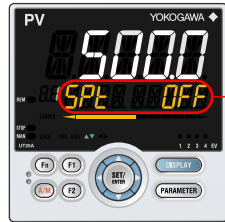

1. Display the Parameter Setting Display.



2. Press the SET/ENTER key to move to the setting mode (the setpoint blinks).



3. Press the Up arrow key to change the setpoint (press the Down arrow key to change the setpoint).



4. Press the SET/ENTER key to register the setpoint.

Time (minute.second) Setting

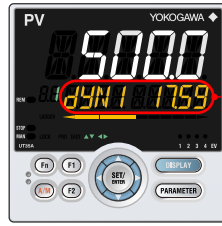

Example of 17 minutes 59 seconds

1. Display the Parameter Setting Display.

2. Press the SET/ENTER key to move to the setting mode (the setpoint blinks).

3. Press the Left arrow key to move one digit to the left. (press the Right arrow key to move one digit to the right.)

4. Press the Up or Down arrow key to change the setpoint. Press the Up arrow key when 5 is displayed to move one digit to the left. Press the Down arrow key when 0 is displayed to move one digit to the right.

5. Press the SET/ENTER key to register the setpoint.

5.1 Setting Using Quick Setting Function

Description

The Quick setting function is a function to easily set the basic function of the controller. The Quick setting function starts when the power is turned on after wiring.

The following lists the items to set using the Quick setting function.

- (1) Control type (PID control, Heating/cooling control, etc.)
- (2) Input function (PV input, range, scale (at voltage/current input), etc.)
- (3) Output function (control output type and cycle time)

5.1 Setting Using Quick Setting Function

Flowchart of Quick Setting Function

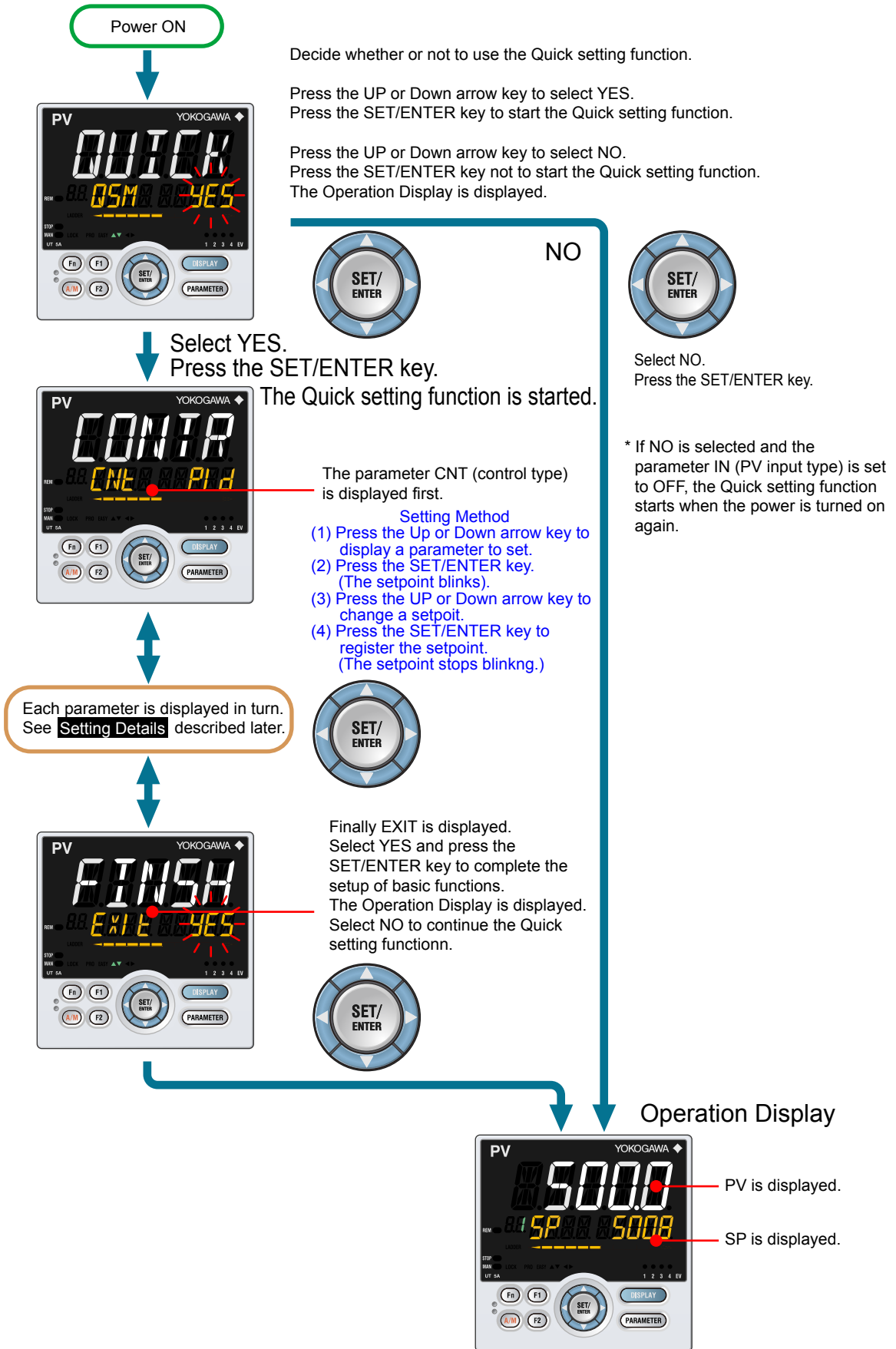

Setting Example

Set the following parameters to set to PID control, thermocouple Type K (range: 0.0 to 500.0°C), and current control output. No need to change the parameters other than the following parameters.

Set QSM = YES to enter the quick setting mode.

- (1) Set CNT = PID.
- (2) Set IN = K1.
- (3) Set UNIT = C (initial value).
- (4) Set RH = 500.0.
- (5) Set RL = 0.0.
- (6) Set OT = 00.02

Set EXIT = YES to quit the quick setting mode.
The Operation Display is shown.

Setting Details**Control Type**

Parameter symbol	Name	Display level	Setting range	Menu symbol
CNT	Control type	EASY	PID: PID control ONOF: ON/OFF control (1 point of hysteresis) ONOF2: ON/OFF control (2 points of hysteresis) 2P2L: Two-position two-level control H/C: Heating/cooling control	CTL Set

▶ Control type: [8.2 Setting Control Type \(CNT\)](#)

5.1 Setting Using Quick Setting Function

Input Function

Parameter symbol	Name	Display level	Setting range	Menu symbol
IN	PV input type	EASY	OFF: Disable K1: -270.0 to 1370.0 °C / -450.0 to 2500.0 °F K2: -270.0 to 1000.0 °C / -450.0 to 2300.0 °F K3: -200.0 to 500.0 °C / -200.0 to 1000.0 °F J: -200.0 to 1200.0 °C / -300.0 to 2300.0 °F T1: -270.0 to 400.0 °C / -450.0 to 750.0 °F T2: 0.0 to 400.0 °C / -200.0 to 750.0 °F B: 0.0 to 1800.0 °C / 32 to 3300 °F S: 0.0 to 1700.0 °C / 32 to 3100 °F R: 0.0 to 1700.0 °C / 32 to 3100 °F N: -200.0 to 1300.0 °C / -300.0 to 2400.0 °F E: -270.0 to 1000.0 °C / -450.0 to 1800.0 °F L: -200.0 to 900.0 °C / -300.0 to 1600.0 °F U1: -200.0 to 400.0 °C / -300.0 to 750.0 °F U2: 0.0 to 400.0 °C / -200.0 to 1000.0 °F W: 0.0 to 2300.0 °C / 32 to 4200 °F PL2: 0.0 to 1390.0 °C / 32.0 to 2500.0 °F P2040: 0.0 to 1900.0 °C / 32 to 3400 °F WRE: 0.0 to 2000.0 °C / 32 to 3600 °F JPT1: -200.0 to 500.0 °C / -300.0 to 1000.0 °F JPT2: -150.0 to 150.0 °C / -200.0 to 300.0 °F PT1: -200.0 to 850.0 °C / -300.0 to 1560.0 °F PT2: -200.0 to 500.0 °C / -300.0 to 1000.0 °F PT3: -150.0 to 150.0 °C / -200.0 to 300.0 °F 0.4-2V: 0.400 to 2.000 V 1-5V: 1.000 to 5.000 V 4-20: 4.00 to 20.00 mA 0-2V: 0.000 to 2.000 V 0-10V: 0.00 to 10.00 V 0-20 : 0.00 to 20.00 mA -1020: -10.00 to 20.00 mV 0-100: 0.0 to 100.0 mV	PV Set
UNIT	PV input unit	EASY	-: No unit C: Degree Celsius -: No unit - -: No unit - - -: No unit F: Degree Fahrenheit	
RH	Maximum value of PV input range	EASY	Depends on the input type. - For temperature input - Set the temperature range that is actually controlled. (RL<RH)	
RL	Minimum value of PV input range	EASY	- For voltage / current input - Set the range of a voltage / current signal that is applied. The scale across which the voltage / current signal is actually controlled should be set using the maximum value of input scale (SH) and minimum value of input scale (SL). (Input is always 0% when RL=RH.)	

Note1: W:W-5% Re/W-26% Re(Hoskins Mfg. Co.). ASTM E988
 WRE: W97Re3-W75Re25

Input Function (Continued)

Parameter symbol	Name	Display level	Setting range	Menu symbol
SDP	PV input scale decimal point position	EASY	0: No decimal place 1: One decimal place 2: Two decimal places 3: Three decimal places 4: Four decimal places	PV Set
SH	Maximum value of PV input scale	EASY	-19999 to 30000, (SL<SH), SH - SL ≤ 30000	
SL	Minimum value of PV input scale	EASY		

▶ Input setting: 7.1 Setting Functions of PV Input

Output Function

Parameter symbol	Name	Display level	Setting range	Menu symbol
OT	Output type selection	EASY	Control output or Heating-side control output (Lower two digits) 00: OFF 01: OUT terminals (voltage pulse) 02: OUT terminals (current) 03: OUT terminals (relay) 06: OUT2 terminals (relay) 07: RET/OUT2 terminals (voltage pulse) 08: RET/OUT2 terminals (current) Cooling-side control output (Upper two digits) 00: OFF 01: OUT terminals (voltage pulse) 02: OUT terminals (current) 03: OUT terminals (relay) 06: OUT2 terminals (relay) 07: RET/OUT2 terminals (voltage pulse) 08: RET/OUT2 terminals (current)	OUT Set
CT	Control output cycle time Heating-side control output cycle time (in Heating/cooling control)	EASY	0.5 to 1000.0 s	
CTc	Cooling-side control output cycle time	EASY		

▶ Output type: 10.1 Setting Control Output Type

▶ Cycle time: 10.2 Setting Control Output Cycle Time

5.2 Restarting Quick Setting Function

Once functions have been built using the Quick setting function, the Quick setting function does not start even when the power is turned on. The following methods can be used to restart the Quick setting function.

- Set the parameter QSM (Quick setting mode) to ON and turn on the power again.
- Set the parameter IN (PV input type) to OFF and turn on the power again.

CAUTION

The parameters related to the range or scale such as alarm setpoints are initialized if the control type is changed.

Setting Details

Parameter symbol	Name	Display level	Setting range	Menu symbol
IN	PV input type	EASY	OFF: Disable	PV Set
QSM	Quick setting mode	EASY	OFF: Disable ON: Enable	SYS Set

6.1 Monitoring and Control of Operation Displays

6.1.1 Operation Display Transitions.

- ▶ Display/Non-display of Operation Display: 13.3.5 Setting Display/Non-display of Operation Display
- ▶ Registration of SELECT Display: 13.1.3 Registering SELECT Display (Up to 5 displays)

Standard Type

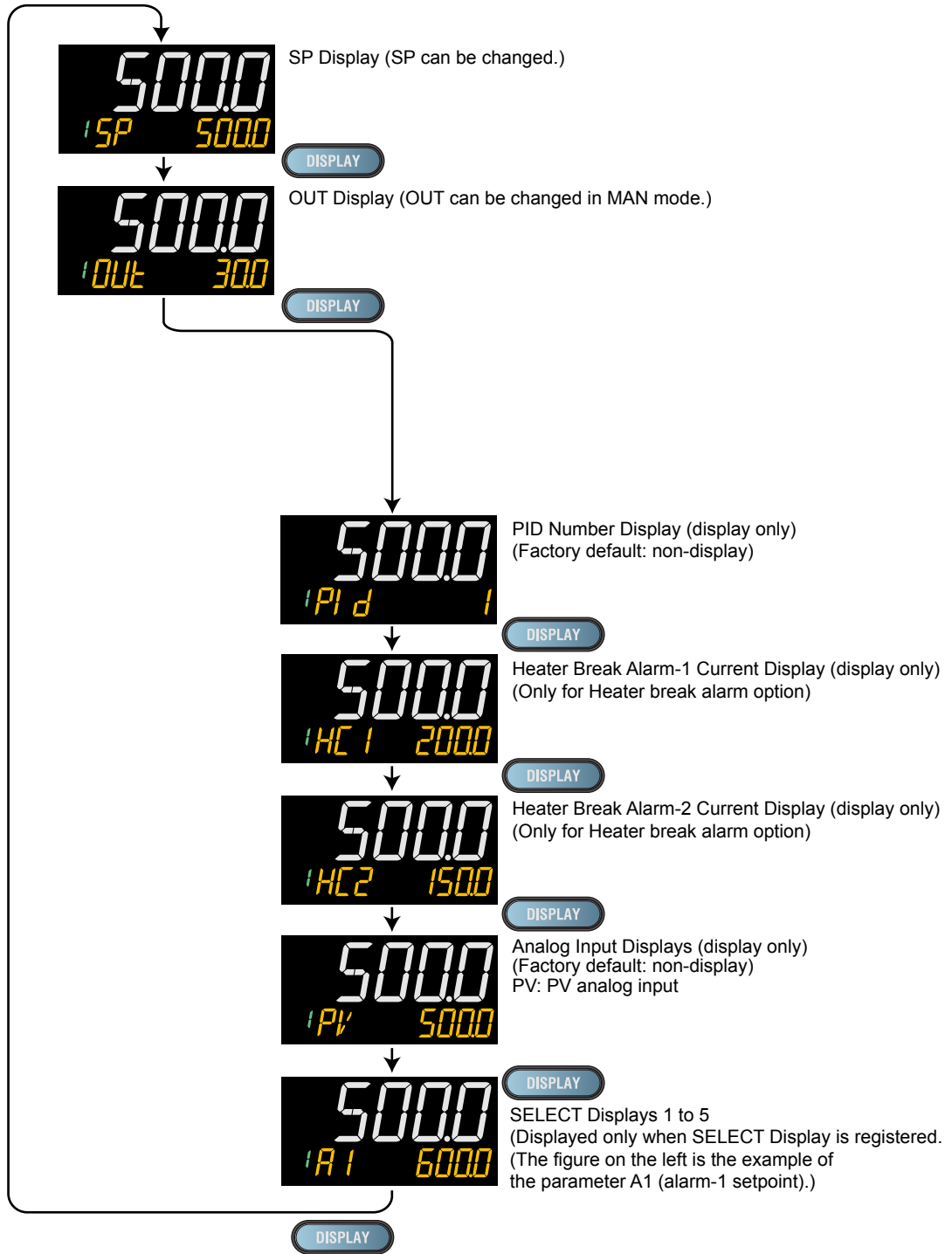

6.1 Monitoring and Control of Operation Displays

Position Proportional Type

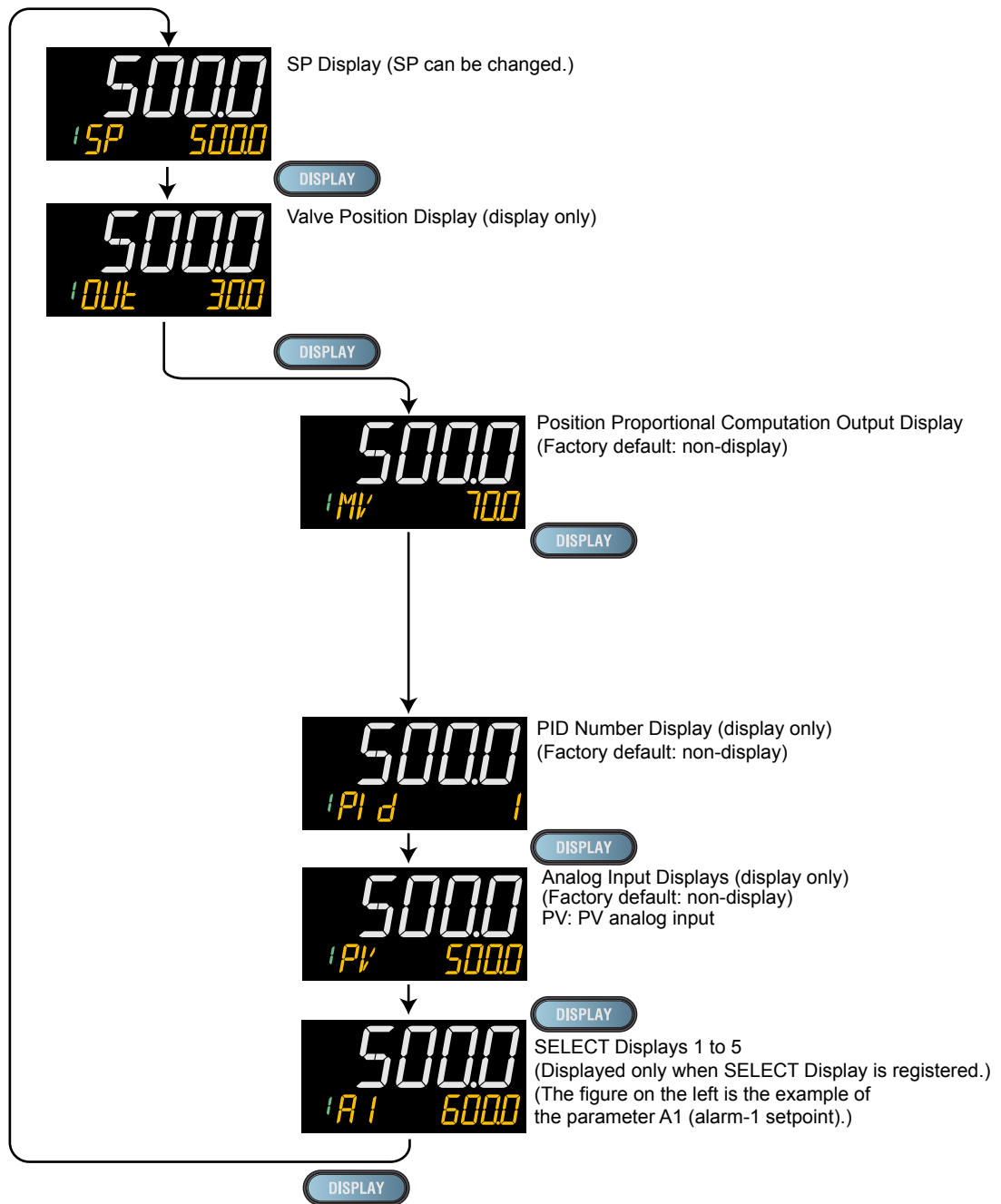

Heating/cooling Type

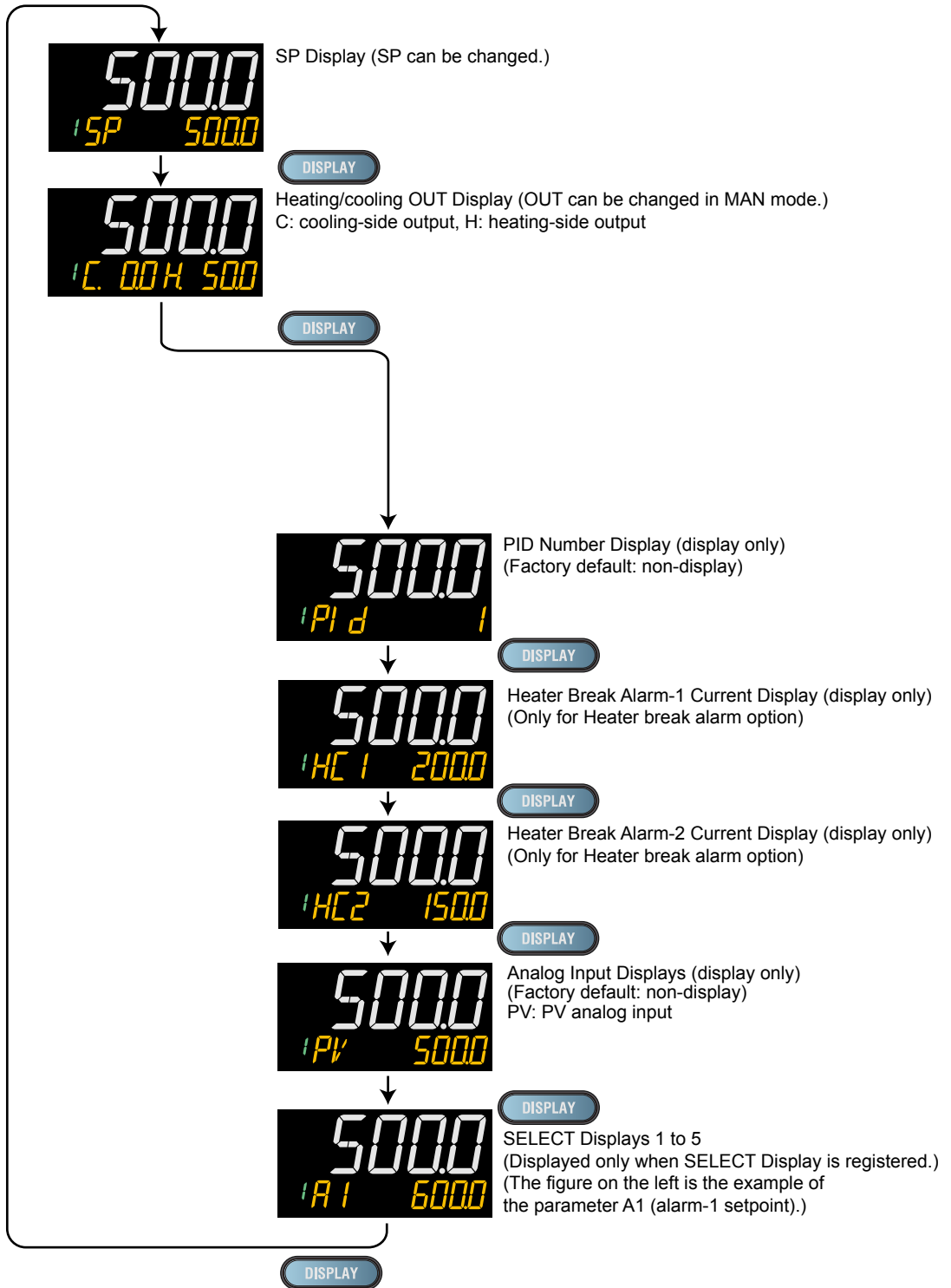

6.1 Monitoring and Control of Operation Displays

Two-position two-level control

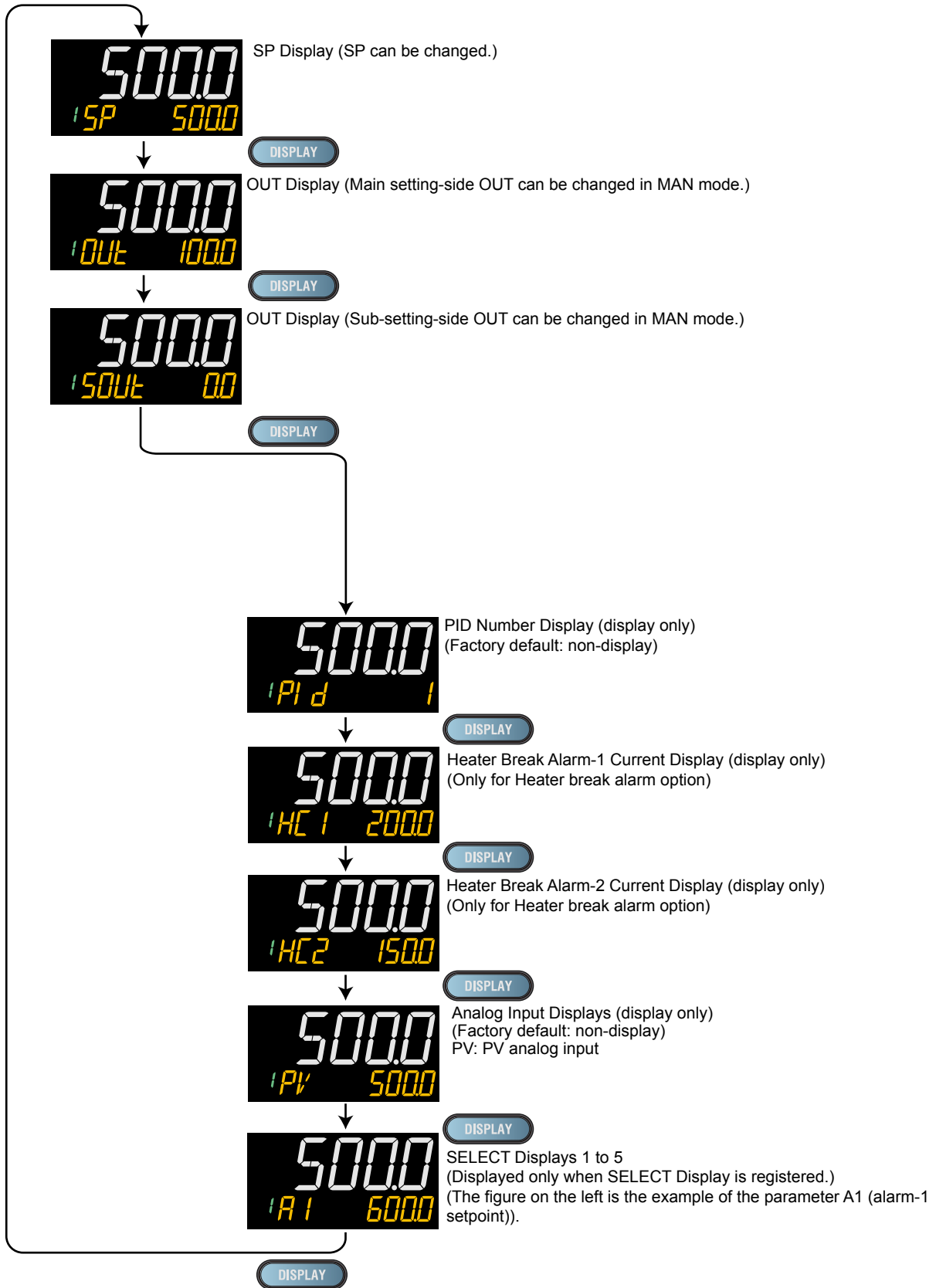

Details of the Operation Display

The following is the Operation Display types and each display and operation description.

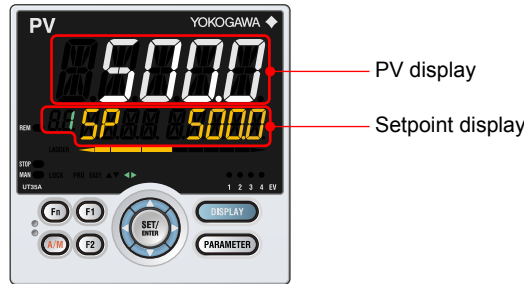



Operation Display	Display and operation description
<p>SP Display</p>	<p>PV display: Displays measured input value (PV). Setpoint display: Displays and changes target setpoint (SP).</p> <p>Symbol Target setpoint Target setpoint (SP) number</p> <p>The Display is switched to the SP Display if the operation mode is switched to AUTO, LCL, or REM when other Operation Display is shown.</p> <p>[SP Change Operation] (1) Press the SET/ENTER key to move to the setting mode (the setpoint blinks). (2) Use the Left or Right arrow key to move between digits (the setpoint blinks). (3) Use the UP or Down arrow key to change the value (the setpoint blinks). (4) Press the SET/ENTER key to register the setpoint. (the setpoint stops blinking). * Only Up or Down arrow key operation is also possible.</p> <p>When the operation mode is remote (REM lamp is lit):</p> <p>Symbol Remote setpoint Target setpoint (SP) number in LOCAL mode</p>

6.1 Monitoring and Control of Operation Displays

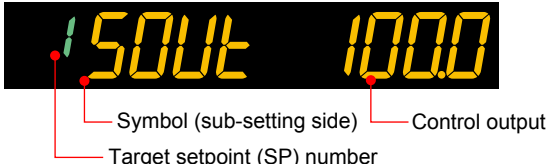
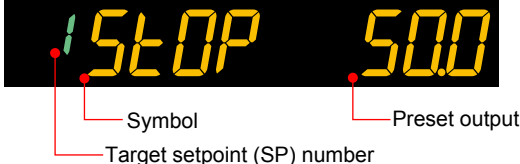
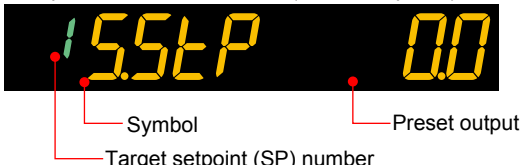
(Continued)





Operation Display	Display and operation description
<p>OUT Display (Valve Position Display)</p>	<p>PV display: Displays measured input value (PV). Setpoint display: Displays control output value and changes control output value in MAN mode.</p>
	 <p>Symbol Control output Target setpoint (SP) number</p>
	<p>Displays the valve's feedback input value (at 0 to 100% valve opening) in Position proportional control. The Display is switched to the OUT Display if the operation mode is switched to MAN when other Operation Display is shown. The Display is switched to the OUT Display while auto-tuning is performed.</p>
	<p>Sub-setting-side output in Two-position two-level control is displayed as below. Main setting-side output is displayed as above.</p>
 <p>Symbol (sub-setting side) Control output Target setpoint (SP) number</p>	
<p>[OUT Change Operation] The control output value can be changed with the Up or Down arrow key in MAN mode (MAN lamp is lit). The control output value is changed by direct operation (without pressing the SET/ENTER key), and cannot be changed by moving between digits using the Left and Right arrow keys. In Position proportional control and in MAN mode, the valve opens as long as the Up arrow key is being pressed, and closes as long as the Down arrow key is being pressed. In Two-position two-level control, main setting-side output and sub-setting-side output can be manipulated individually.</p>	
<p>When in STOP mode (STOP lamp is lit):</p>	
 <p>Symbol Preset output Target setpoint (SP) number</p>	
<p>In Two-position two-level control (STOP lamp is lit):</p>	
 <p>Symbol Preset output Target setpoint (SP) number</p>	
<p>Preset output value is displayed in STOP mode. Preset output values cannot be changed by OUT change operation.</p>	

(Continued)

Operation Display	Display and operation description
<p>Heating/cooling OUT Display</p>	<p>PV display: Displays measured input value (PV). Setpoint display: Displays heating-side and cooling-side control output value and changes control output value in MAN mode.</p>  <p>Heating-side control output Symbol of heating side Cooling-side control output Symbol of cooling side Target setpoint (SP) number</p> <p>When the control output value is less than 100%, one digit is displayed to the right of the decimal point. When the control output value is equal to or more than 100%, no digits are displayed to the right of the decimal point. The display is switched to the Heating/cooling OUT Display if the operation mode is switched to MAN when other Operation Display is shown. An interruption is displayed while auto-tuning is performed.</p> <p>[OUT Change Operation] In MAN mode (MAN lamp is lit) pressing the Up arrow key causes the cooling-side output to decrease, and the heating-side output to increase. Pressing the Down arrow key causes the cooling-side output to increase, and the heating-side output to decrease. The control output value is changed by direct operation (without pressing the SET/ENTER key), and cannot be changed by moving between digits using the Left and Right arrow keys.</p> <p>When in STOP mode (STOP lamp is lit):</p>  <p>Heating-side preset output Symbol of STOP Cooling-side preset output Cooling-side symbol Target setpoint (SP) number</p> <p>Heating-side or cooling-side preset output value is displayed in STOP mode. Preset output values cannot be changed by OUT change operation.</p>
<p>PID Number Display</p>	<p>PV display: Displays measured input value (PV). Setpoint display: Displays PID number currently being used.</p>  <p>Symbol PID number Target setpoint (SP) number</p>

6.1 Monitoring and Control of Operation Displays

(Continued)

Operation Display	Display and operation description
<p>Analog Input Display</p>	<p>PV display: Displays measured input value (PV). Setpoint display: Displays PV analog input value.</p> <p>PV analog input value</p>  <p>Labels: Target setpoint (SP) number, Symbol, PV input</p>
<p>Position Proportional Computation Output Display</p>	<p>PV display: Displays measured input value (PV). Setpoint display: Displays position proportional computation output value (internal computed value).</p>  <p>Labels: Target setpoint (SP) number, Symbol, Internal computed value</p> <p>Can be changed in MAN mode. The valve opens or closes so that the valve's feedback input value reaches the setpoint.</p>
<p>Heater Break Alarm Current Display</p>	<p>PV display: Displays measured input value (PV). Setpoint display: Displays measured heater current.</p>  <p>Labels: Target setpoint (SP) number, Symbol, Heater break current measured value</p>
<p>SELECT Display</p>	<p>SELECT Display is for registering frequently-used parameters from Parameter Setting Display, and for displaying them on Operation Display so that the parameter settings can be easily changed in normal operation.</p> <p>PV display: Displays measured input value (PV). Setpoint display: Displays and changes the registered parameter.</p> <p>The following is the display example when the parameter A1 (alarm-1 setpoint) is registered.</p>  <p>Labels: Target setpoint (SP) number, Symbol, Alarm setpoint</p>

6.2 Setting Target Setpoint

Operation in the Operation Display

Operation

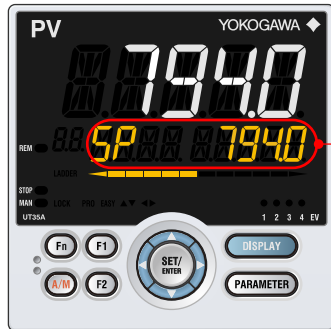

SP 7940

SP 7940

SP 7940

SP 8040

SP 8040

1. Bring the SP Display into view.
2. Press the SET/ENTER key to move to the setting mode (the setpoint blinks).
3. Press the Left arrow key to move one digit to the left. (Press the Right arrow key to move one digit to the right).
4. Press the Up or Down arrow key to change a setpoint. Press the Up arrow key when 9 is displayed to move one digit to the left. Press the Down arrow key when 0 is displayed to move one digit to the right.
5. Press the SET/ENTER key to register the setpoint. Control with the new setpoint.

6.2 Setting Target Setpoint

Operation in Parameter Setting Display

Setting Display

Parameter Setting Display Operation Display > **PARAMETER** or **PARA** key for **3 seconds** (to [MODE] Menu Display) > **Right arrow** key (to [SP] Menu Display) > **SET/ENTER** key (The setting parameter is displayed.)

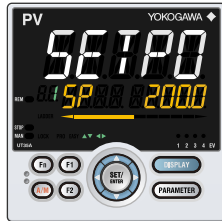

Press the Right arrow key until the [SP] Menu Display appears.

In the Setting Display for the target setpoint parameter, pressing the Left or Right arrow keys changes the group. (The group number is displayed on Group display.)

Setting Details

Parameter symbol	Name	Display level	Setting range	Menu symbol
SP	Target setpoint	EASY	0.0 to 100.0% of PV input range (EU) (Setting range: SPL to SPH)	SP Ope
SPGR.	Number of SP groups	STD	1 to 4	CTL Set

Note1: If the SP limiter is set, the setting can be made within the range of the SP limiter.

Description

The controller has four target setpoints (SP).

- ▶ [SP limiter: 9.1 Setting SP Limiter](#)
- ▶ [SELECT parameter: 13.1.5 Registering SELECT Parameter Display \(Up to 10 Displays\)](#)

6.3 Performing and Canceling Auto-tuning

Setting Display

Operation Mode Setting Display

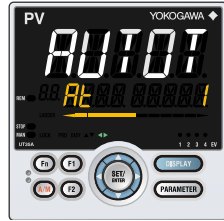

Operation Display > **PARAMETER** or **PARA** key for **3 seconds** (to [MODE] Menu Display) > **SET/ENTER** key (The operation mode is displayed.) > **Down arrow** key (The operation mode is displayed.)

The parameter AT is displayed when the operation mode is AUTO.

Setting Details

Parameter symbol	Name	Display level	Setting range	Menu symbol
AT	AUTO-tuning switch	EASY	OFF: Disable 1: Perform auto-tuning. Tuning result is stored in the PID of group 1. 2: Perform auto-tuning. Tuning result is stored in the PID of group 2. 3: Perform auto-tuning. Tuning result is stored in the PID of group 3. 4: Perform auto-tuning. Tuning result is stored in the PID of group 4. R: Tuning result is stored in the PID for reference deviation.	MODE Ope

CAUTION

Set the operation mode to AUTO and RUN to perform auto-tuning.

Lamp Status

Status	STOP lamp	MAN lamp
During auto-tuning	Unlit	Blinking

6.3 Performing and Canceling Auto-tuning

Description

Auto-tuning is a function with which the controller automatically measures the process characteristics and sets PID constants, which are control-related parameters, to optimum values for the setpoint. Auto-tuning temporarily executes ON/OFF control, calculates appropriate PID constants from response data obtained, and sets these constants.

CAUTION

Do not perform auto-tuning for the following processes.
Tune PID manually.

- Processes with fast response such as flow rate control and pressure control.
- Processes which do not allow the output to be turned on and off even temporarily.
- Processes which prohibit output changes at control valves (or other actuators).
- Processes in which product quality can be adversely affected if PV values fluctuate beyond their allowable ranges.

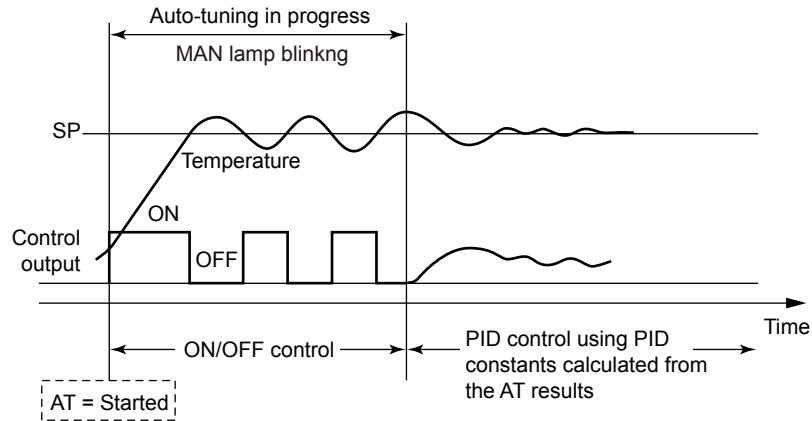

Tuning Point and Storage Location of Tuning Results

The tuning point when performing auto-tuning is the target setpoint that is currently used for control computation.

PID constants after the tuning are stored in the PID group that is specified when performing auto-tuning.

Operation mode	AT setpoint	Tuning point	Storage location
Local	1 to 4, R	Setpoint that is currently used	P, I, and D of the PID group specified in AT. In Heating/cooling control: P, I, D, Pc, Ic, and Dc
Remote	1 to 4, R	Remote setpoint	P, I, and D of the PID group specified in AT. In Heating/cooling control: P, I, D, Pc, Ic, and Dc

When the setpoint of AT is "R," the AT result is stored in the PID group for reference deviation.

When performing auto-tuning in AT setpoint "R", set the parameter ZON to other than 0 and 3, and set the parameter RDV to other than 0.

Auto-tuning cannot be performed when the control type (CNT) is as follows.

- ON/OFF control (1 point of hysteresis)
- ON/OFF control (2 points of hysteresis)
- Two-position two-level control
- Sample PI control

In addition, auto-tuning cannot be performed in the following cases (no error indication).

- Input error occurs. (Input burnout, ADC error, etc.)
- The operation mode is STOP.
- The operation mode is MAN.
- Output limiter setpoint at auto-tuning: $AT.OL \geq AT.OH$

Start and Stop of Auto-tuning

Start and stop of auto-tuning can be set by parameter setting, communication, or contact input.

Auto-tuning is stopped in the following cases.

- Switch to MAN
- Switch to STOP
- The parameter AT is set to OFF.
- Power failure
- Auto-tuning is not finished even after the time-out detection time is elapsed.

The time-out detection time is about 24 hours.

When the auto-tuning error occurs, the error code is shown in the Operation Display. Press any key to erase it.

- ▶ [Auto-tuning time output limiter: 8.8 Adjusting Auto-tuning Operation](#)

6.4 Adjusting PID Manually

Setting Display

Parameter Setting Display Operation Display > **PARAMETER** or **PARA** key for **3 seconds** (to [MODE] Menu Display) > **Right arrow** key (to [PID] Menu Display) > **SET/ENTER** key (The setting parameter is displayed.) > **Down arrow** key (The setting parameter is displayed.)

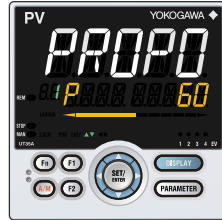

In the Setting Display for the PID parameters, Displays can be arbitrarily switched using the Up, Down, Left or Right arrow key. Pressing the Left or Right arrow key changes the group. (The group number is displayed on Group display.)

Setting Details

Parameter symbol	Name	Display level	Setting range	Menu symbol
P	Proportional band Heating-side proportional band (in Heating/cooling control)	EASY	0.0 to 999.9% When 0.0% is set, it operates as 0.1%. Heating-side ON/OFF control applies when 0.0% in Heating/ cooling control	PID Ope
I	Integral time Heating-side integral time (in Heating/cooling control)	EASY	OFF: Disable 1 to 6000 s	
D	Derivative time Heating-side derivative time (in Heating/cooling control)	EASY	OFF: Disable 1 to 6000 s	
Pc	Cooling-side proportional band	EASY	0.0 to 999.9% Cooling-side ON/OFF control applies when 0.0% in Heating/ cooling control	
Ic	Cooling-side integral time	EASY	OFF: Disable 1 to 6000 s	
Dc	Cooling-side derivative time	EASY	OFF: Disable 1 to 6000 s	
PIDN	PID number selection	EASY	1 to 4	
PIDG.	Number of PID groups	STD	1 to 4	CTL Set

Note

When changing the setpoint of the parameter PIDG., if the setpoint of the parameter PIDN which belongs to the SP menu is larger than that of the parameter PIDG., the PIDN setpoint is changed to the PIDG. setpoint.

There are four groups of PID parameters.

The PID parameters can be selected by using the following two methods:

(1) SP group number selection

The PID group which is set in the PID number selection (PIDN) of each SP group is used.

SP number (SPNO)	Target setpoint (SP)	Setting range of PID number selection (PIDN)
1	SP	1 to 4
2	SP	1 to 4
3	SP	1 to 4
4	SP	1 to 4

When the SP parameter is displayed, the SP number is shown on Group display.

When the PID parameters are displayed, the PID number is shown on Group display.

- ▶ Selection by keystroke: [6.6 Selecting Target Setpoint Number \(SPNO\)](#)
- ▶ Selection by contact input: [12.1 Setting Contact Input Function](#)

(2) Zone PID selection

- ▶ Selection by each Zone: [8.4 Switching PID](#)

Description

Description and Tuning of Proportional Band

The proportional band is defined as the amount of change in input (or deviation), as a percent of span, required to cause the control output to change from 0% to 100%. Because a narrower proportional band gives greater output change for any given deviation, it therefore also makes the control performance more susceptible to oscillation. At the same time, a narrower proportional band reduces the offset. Reducing the proportional band to its smallest limit (proportional band = 0%) results in ON/OFF control.

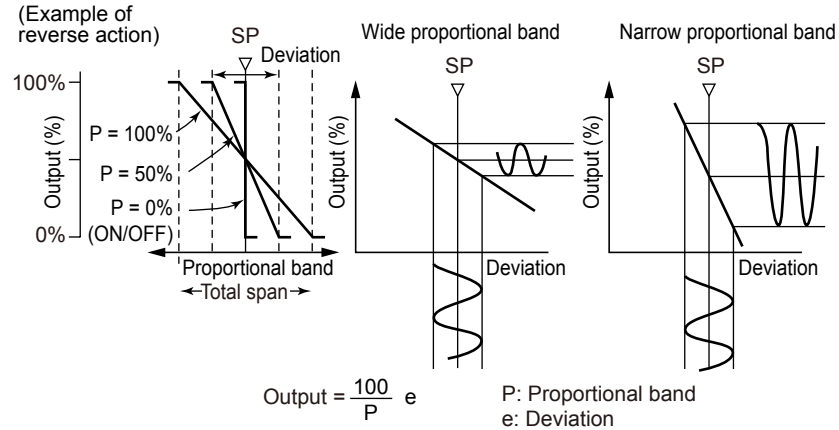

To fine-tune a proportional band obtained using auto-tuning, or to manually tune the proportional band:

- Work from larger to smaller numbers (wider to narrower).
- If cycling appears, that means that the proportional band is too narrow.
- Proportional band tuning cannot cancel an offset.

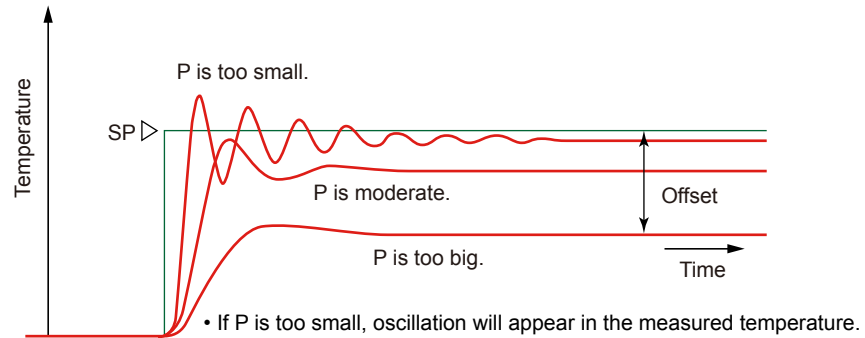

► [Offset: 10.8 Canceling Offset of PV and SP \(Manual Reset\)](#)

Description and Tuning of Integral Time

The integral action (I action) is a function that will automatically diminish the offset (steady-state deviation) that is inherently unavoidable with proportional action alone. The integral action continuously increases or decreases the output in proportion to the time integral of the deviation (the product of the deviation and the time that the deviation continues.)

The integral action is normally used together with proportional action as proportional-plus-integral action (PI action).

The integral time (I) is defined as the time required to develop, when a stepwise change in deviation is imposed, an output change due to integral action that is exactly equal to the change due to proportional action. The longer the integral time set, the slower the change in output; the smaller the time, the faster the output changes.

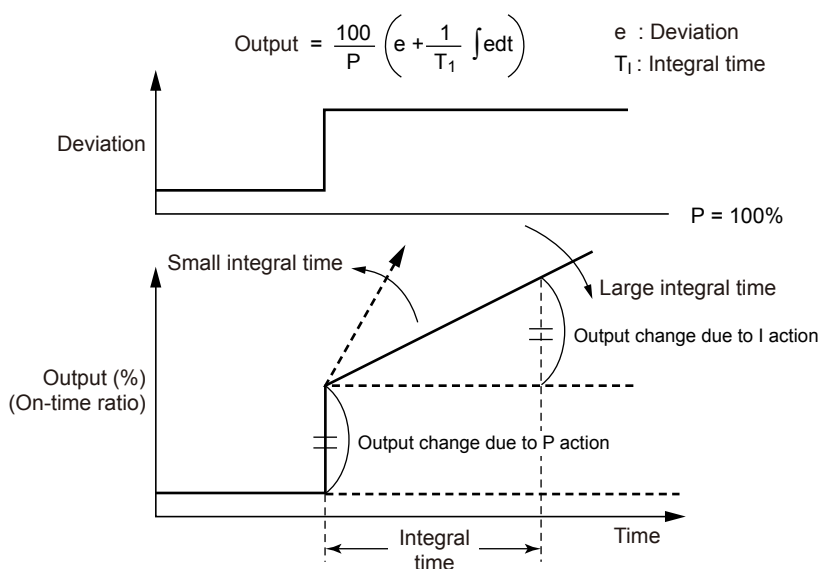

To manually tune the integral time

- The main goal is to reduce the offset.
- Adjust from longer time to shorter time.
- If you see an oscillation at a longer period than that seen when the proportional band is too narrow, then you have made the integral time too short.

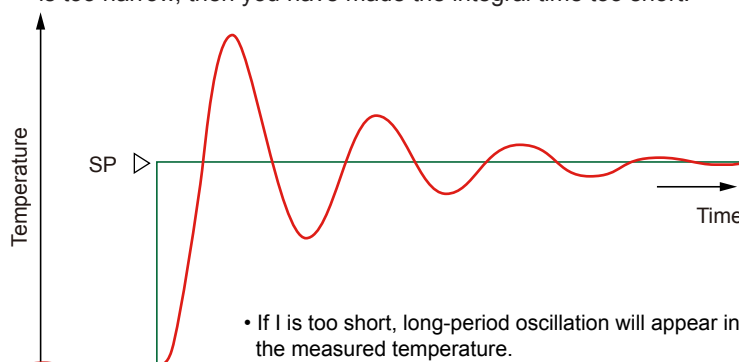

Use the manual reset (MR) to cancel an offset when the integral action is disabled.

- ▶ [Manual reset: 10.8 Canceling Offset of PV and SP \(Manual Reset\)](#)

Description and Tuning of Derivative Time

If the control object has a large time constant or dead time, the corrective action will be too slow with proportional action or proportional-plus-integral action alone, causing overshoot. However, even just sensing whether the deviation is on an increasing or a decreasing trend and adding some early corrective action can improve the controllability. Thus the derivative action (D action) is action that changes the output in proportion to the deviation derivative value (rate-of-change).

The derivative time is defined as the time required with PD action to develop, when a constant-slope change in deviation is imposed, an output change due to derivative action that is exactly equal to the change due to proportional action.

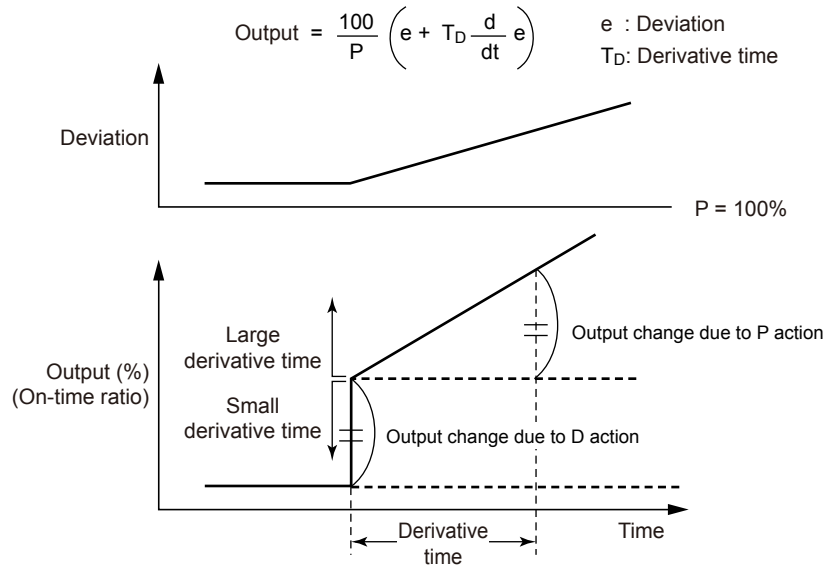

To manually tune the derivative time

- Adjust from shorter time to longer time.
- If you see a short-period oscillation, the time is too long.

The longer the derivative time set, the stronger the corrective action, and the more likely the output will become oscillatory. Oscillations due to derivative action are characterized by a short period.

D = OFF should always be used when controlling fast-responding inputs such as pressure and flow rate, or inputs characterized by rapid fluctuation, such as optical sensors.

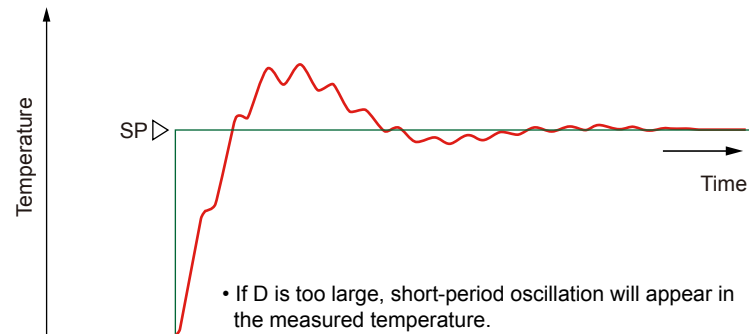

Manual PID Tuning Procedure

- (1) In principle, auto-tuning must be used.
- (2) Tune PID parameters in the order of P, I, and D. Adjust a numeric slowly by observing the result, and keep notes of what the progress is.
- (3) Gradually reduce P from a larger value. When the PV value begins to oscillate, stop tuning and increase the value somewhat.
- (4) Also gradually reduce I from a larger value. When the PV value begins to oscillate (with long period), stop tuning and increase the value somewhat.
- (5) Gradually increase D from a smaller value. When the PV value begins to oscillate (with short period), stop tuning and lower the value slightly.

Reference Values for Manual Tuning of Temperature, Pressure, and Flow Rate

		Setting range (reference)	Initial value for tuning (reference)
Pressure	P	100 to 300%	200%
	I	5 to 30 s	15 s
	D	OFF	OFF
Flow rate	P	100 to 240%	150%
	I	8 to 30 s	20 s
	D	OFF	OFF
Temperature (electric furnace)	P	1 to 20%	5%
	I	180 to 600 s	240 s
	D	1/4 to 1/6 of I	60 s

6.5 Setting Alarm Setpoint

Setting Display

Parameter Setting Display Operation Display > **PARAMETER** or **PARA** key for **3 seconds** (to [MODE] Menu Display) > **Right arrow** key (to [SP] Menu Display) > **SET/ENTER** key (The setting parameter is displayed.) > **Down arrow** key (The setting parameter is displayed.)

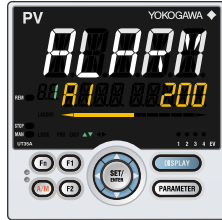

In the setting Display for the alarm parameters, Displays can be arbitrarily switched using the Up, Down, Left or Right arrow key. Pressing the Left or Right arrow key changes the group. (The group number is displayed on Group display.)

Setting Details

Parameter symbol	Name	Display level	Setting range	Menu symbol
A1 to A4	Alarm-1 to -4 setpoint	EASY	Set a display value of setpoint of PV alarm, SP alarm, deviation alarm, output alarm, or velocity alarm. -19999 to 30000 (Set a value within the input range.) Decimal point position depends on the input type	SP Ope
ALNO.	Number of alarms	PRO	1 to 4	CTL Set

Note:1 When the alarm setpoint parameter is displayed, the group number is shown on Group display.

Note2: The initial value of the parameter ALNO. is "4." Four alarm setpoint parameters are displayed for each SP group.

Description

Each alarm type has four alarm setpoints.

Specifying the SP number (SPNO) determines the alarm setpoint to be used.

Alarm-related parameter	Number of settings
Alarm type	4 (number of settings)
PV velocity alarm time setpoint	4 (number of settings)
Alarm hysteresis	4 (number of settings)
Alarm delay timer	4 (number of settings)
Alarm setpoint	4 (number of settings) x 4 (number of groups)

▶ Alarm type: Chapter 11 Alarm Functions

6.6 Selecting Target Setpoint Number (SPNO)

Setting Display

Parameter Setting Display Operation Display > **PARAMETER** or **PARA** key for **3 seconds** (to [MODE] Menu Display) > **SET/ENTER** key (The setting parameter is displayed.) > **Down arrow** key (The setting parameter is displayed.)

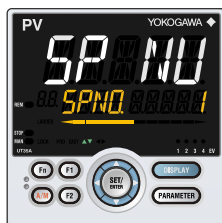

Setting Details

Parameter symbol	Name	Display level	Setting range	Menu symbol
SPNO.	SP number selection	EASY	1 to 4 (Depends on the setup parameter SPGR. setting.)	MODE Ope
SPGR.	Number of SP groups	STD	1 to 4	CTL Set

Description

The SP number (SPNO) selection can be used when the parameter ZON (zone PID selection) is set to “SP group number selection.”

SP Group Number Selection

The PID group which is set in the PID number selection (PIDN) of each SP group is used.

SP number (SPNO)	Target setpoint (SP)	Setting range of PID number selection (PIDN)
1	SP	1 to 4
2	SP	1 to 4
3	SP	1 to 4
4	SP	1 to 4

When the SP parameter is displayed, the SP number is shown on Group display.

▶ Selection by contact input: [12.1 Setting Contact Input Function](#)

6.7 Switching Operation Modes

6.7.1 Switching between AUTO and MAN

Direct Operation by A/M Key

Operation

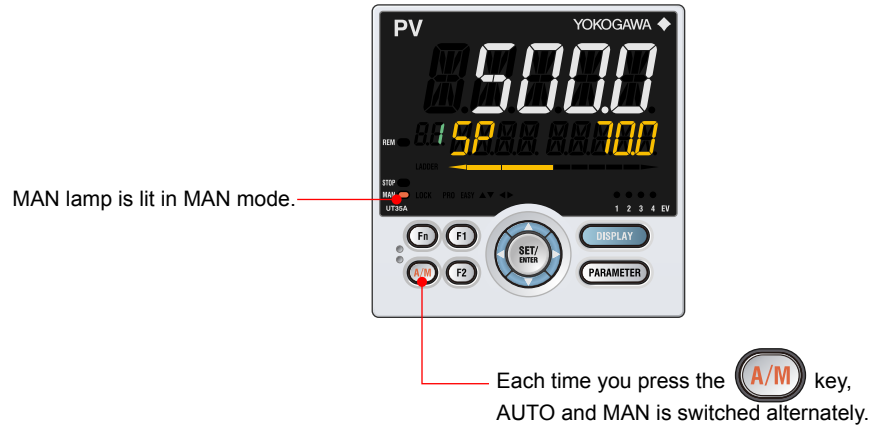

Description

AUTO/MAN switching can be performed by any of the following:

- (1) A/M key
- (2) Contact input (status or edge)
- (3) Communication
- (4) User function key

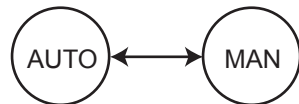

When the contact input (status) is ON, operation cannot be performed by keystroke or communication.

When the contact input is OFF, and the setting is switched by keystroke or communication, the last switching operation is performed.

- ▶ [Switch by contact input: 12.1 Setting Contact Input Function](#)
- ▶ [Switch by user function key: 13.2 Assigning Function to User Function Key and A/M key](#)

Switch	Output action
AUTO→MAN	Holds the control output value from AUTO mode. The control output value can be bump to the manual preset output value by the setting of parameter MPO. The output value can be changed in manual mode.
MAN→AUTO	The control output value does not bump (bumpless). Does not work when Integral time (I) = OFF.

- ▶ [Switch from AUTO to MAN, and MPON: 10.12.2 Setting Output Value When Switched to MAN Mode \(Manual Preset Output\)](#)

Operation Display in AUTO and MAN Modes

“OUT” is displayed on Symbol display and “Output value” is displayed on Data display in MAN mode. (The OUT Display is shown.)



Sub-setting-side OUT Display is shown in Two-position two-level control.



SP Display is shown in AUTO mode.

**Operation Display in AUTO and MAN Modes in Heating/cooling Control**

In MAN mode, the Display is as follows. Symbol “C” represents the cooling side and “H” represents the heating side. The value on the right of each symbol is the output value.

**Lamp Status**

Status	MAN lamp
Automatic operation (AUTO)	Unlit
Manual operation (MAN)	Lit

6.7.2 Switching between STOP and RUN

Setting Display

Operation Mode Setting Display Operation Display > **PARAMETER** or **PARA** key for **3 seconds** (to [MODE] Menu Display) > **SET/ENTER** key (The operation mode is displayed.) > **Down arrow** key (The operation mode is displayed.)



Factory default: The parameter S.R is not displayed because STOP/RUN switch is assigned to the contact input. To display the parameter, disable the STOP/RUN switch assigned to the contact input.

▶ Switch by contact input: 12.1 Setting Contact Input Function

Setting Details

Parameter symbol	Name	Display level	Setting range	Menu symbol
S.R	STOP/RUN switch	EASY	STOP: Stop mode RUN: Run mode	MODE Ope

Description

STOP/RUN switching can be performed by any of the following:

- (1) Contact input (status or edge)
- (2) Parameter
- (3) Communication
- (4) User function key

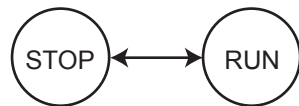

When the contact input (status) is ON, operation cannot be performed by parameter, communication, or keystroke.

When the contact input is OFF, and the setting is switched by parameter, communication, or keystroke, the last switching operation is performed.

▶ Switch by contact input: 12.1 Setting Contact Input Function

▶ Switch by user function key: 13.2 Assigning Function to User Function Key and A/M key

Switch	Output action
RUN→STOP	The control output bumps.
STOP→RUN	The control output does not bump (bumpless).

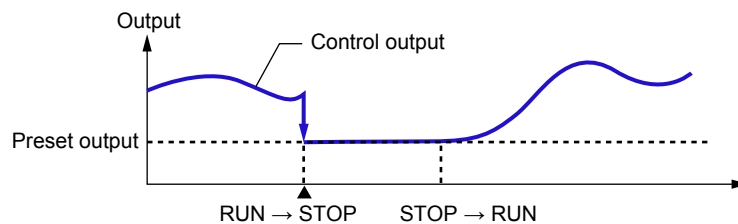

▶ Preset output value: 10.12.1 Setting Output Value in STOP Mode (Preset Output)

Operation Display in STOP and RUN Modes

“STOP” is displayed on Symbol display and “Output value” is displayed on Data display in STOP mode. Preset output value is displayed.



In Two-position two-level control



The display at operation start differs depending on AUTO or MAN mode. SP Display is shown in AUTO mode and OUT Display is shown in MAN mode.

SP Display



OUT Display



Sub-setting-side OUT Display in Two-position two-level control.

**Operation Display in STOP and RUN Modes in Heating/cooling Control**

In STOP mode in Heating/cooling control, the display is as follows. The cooling-side preset output is displayed on the left of the symbol “ST” and heating-side preset output is displayed on the right.



The display at operation start differs depending on AUTO or MAN mode. SP Display is shown in AUTO mode and Heat/cool OUT Display is shown in MAN mode.

SP Display



Heat/cool OUT Display

Symbol “C” represents the cooling side and “H” represents the heating side.

**Lamp Status**

Status	STOP lamp
Operation start (RUN)	Unlit
Operation Stop (STOP)	Lit

6.7 Switching Operation Modes

6.7.3 Switching between REM (Remote) and LCL (Local)

Setting Display

Operation Mode Setting Display Operation Display > **PARAMETER** or **PARA** key for **3 seconds** (to **[MODE]** Menu Display) > **SET/ENTER** key (The operation mode is displayed.) > **Down arrow** key (The operation mode is displayed.)

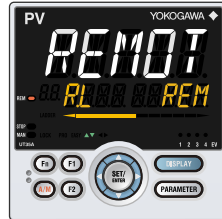

The parameter R.L is displayed when the the communication is specified.

Setting Details

Parameter symbol	Name	Display level	Setting range	Menu symbol
R.L	REMOTE/LOCAL switch	EASY	LCL: Local mode REM: Remote mode	MODE Ope

Description

REMOTE/LOCAL switching can be performed by any of the following:

- (1) Contact input (status or edge)
- (2) Parameter
- (3) Communication
- (4) User function key

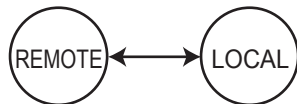

When the contact input (status) is ON, operation cannot be performed by parameter, communication, or keystroke.

When the contact input is OFF, and the setting is switched by parameter, communication, or keystroke, the last switching operation is performed.

The last switching operation is performed for all methods, when the action of contact input is detected as rising edge.

- ▶ Switch by contact input: [12.1 Setting Contact Input Function](#)
- ▶ Switch by user function key: [13.2 Assigning Function to User Function Key and A/M key](#)

The PID group corresponding to the local SP number is used as PID in REM mode.

SP Action in REM/LCL Switch

Switch	SP action
LCL→REM	The local target setpoint bumps to the remote target setpoint.
REM→LCL	The remote target setpoint bumps to the local target setpoint. Or forces the local target setpoint to track the remote target setpoint.

► [Tracking: 9.4 Forcing SP to Track Remote Input \(SP Tracking\)](#)

Lamp Status

Status	REM lamp
Local (LCL)	Unlit
Remote (REM)	Lit

6.8 Manipulating Control Output during Manual Operation

Operation

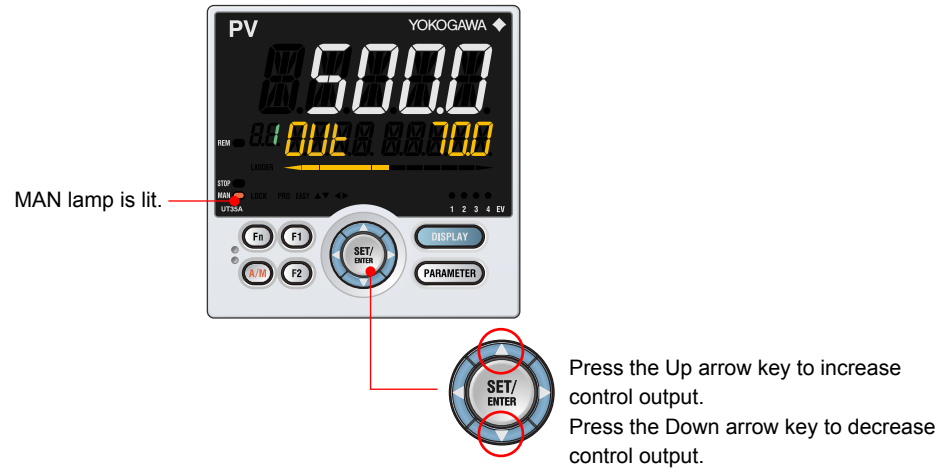

In Heating/cooling control,
press the Up arrow key to decrease cooling-side control output and to increase heating-side control output;
press the Down arrow key to increase cooling-side control output and to decrease heating-side control output.

Description

In MAN mode, the control output is manipulated by direct key operation. (The value changed using the Up or Down arrow key is output as is.)
Manipulation of the control output is not possible in STOP mode (the STOP lamp is lit).
Output manipulation differs depending on the ON or OFF setting of the control output limiter (OH, OL).

► [10.4 Disabling Output Limiter in MAN mode](#)

OUT Display



Valve position is displayed in Position proportional control.

Sub-setting-side OUT Display in Two-position two-level control.

In Two-position two-level control, main setting-side output can be manipulated individually. Control output limiter is disabled as well as a case of ON/OFF control.



Heating/cooling OUT Display

The heating/cooling control output is manipulated simultaneously on both the heating and cooling sides.

In MAN mode, the display is as follows. The symbol "C" represents the cooling side, and "H" the heating side. The value on the right of each symbol is the output value.



When the control output low limit is set to "SD" while the control output type is 4 to 20 mA, the control output value can be lowered down to 0 mA.

► [10.6 Reducing 4-20 mA Current Output to 0 mA \(Tight Shut Function\)](#)

6.9 Releasing On-State (Latch) of Alarm Output

Description

Alarm latch can be released by any of the following.

- (1) User function key
- (2) Communication
- (3) Contact input

For the switching operation by using the above, the last switching operation is performed.

Releasing the alarm latch function releases all of the latched alarm outputs.

By factory default, the function is not assigned to the user function key and contact input.

Assign and use the function in accordance with the reference sections below.

- ▶ [Release by user function key: 13.2 Assigning Function to User Function Key and A/M key](#)
- ▶ [Release by contact input: 12.1 Setting Contact Input Function](#)
- ▶ [Release via communication: UTAdvanced Series Communication Interface User's Manual](#)

7.1 Setting Functions of PV Input

7.1.1 Setting Input Type, Unit, Range, Scale, and Decimal Point Position

Description

The figure below describes the case of PV input.

Example of Temperature Input

The figure below is an example of setting Type K thermocouple and a measurement range of 0.0 to 800.0 °C.

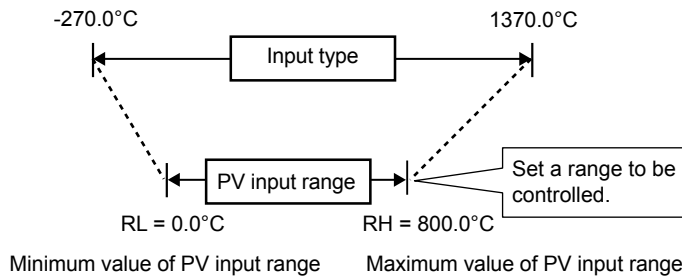

Example of Voltage and Current Inputs

The figure below is an example of setting 2-4 V DC and a scale of 0.0 to 50.0 m³/h.

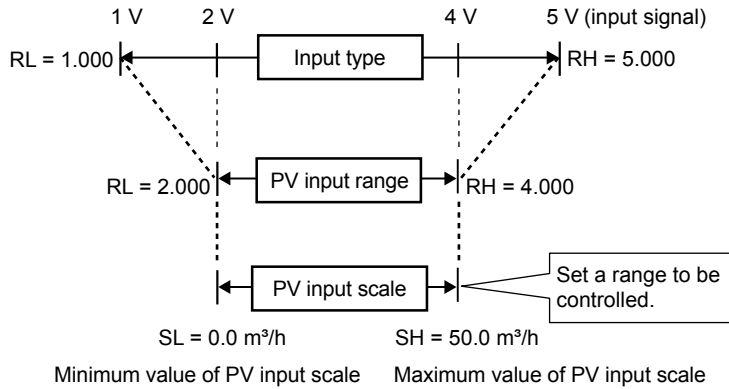

When using 1-5 V DC signal as is, set RH = 5.000 V, RL = 1.000 V, SDP=1, and SH = 50.0, and SL=0.0.

7.1 Setting Functions of PV Input

Setting Details

Parameter symbol	Name	Display level	Setting range	Menu symbol
IN	PV input type	EASY	OFF: Disable K1: -270.0 to 1370.0 °C / -450.0 to 2500.0 °F K2: -270.0 to 1000.0 °C / -450.0 to 2300.0 °F K3: -200.0 to 500.0 °C / -200.0 to 1000.0 °F J: -200.0 to 1200.0 °C / -300.0 to 2300.0 °F T1: -270.0 to 400.0 °C / -450.0 to 750.0 °F T2: 0.0 to 400.0 °C / -200.0 to 750.0 °F B: 0.0 to 1800.0 °C / 32 to 3300 °F S: 0.0 to 1700.0 °C / 32 to 3100 °F R: 0.0 to 1700.0 °C / 32 to 3100 °F N: -200.0 to 1300.0 °C / -300.0 to 2400.0 °F E: -270.0 to 1000.0 °C / -450.0 to 1800.0 °F L: -200.0 to 900.0 °C / -300.0 to 1600.0 °F U1: -200.0 to 400.0 °C / -300.0 to 750.0 °F U2: 0.0 to 400.0 °C / -200.0 to 1000.0 °F W: 0.0 to 2300.0 °C / 32 to 4200 °F (Note1) PL2: 0.0 to 1390.0 °C / 32.0 to 2500.0 °F P2040: 0.0 to 1900.0 °C / 32 to 3400 °F WRE: 0.0 to 2000.0 °C / 32 to 3600 °F JPT1: -200.0 to 500.0 °C / -300.0 to 1000.0 °F JPT2: -150.0 to 150.0 °C / -200.0 to 300.0 °F PT1: -200.0 to 850.0 °C / -300.0 to 1560.0 °F PT2: -200.0 to 500.0 °C / -300.0 to 1000.0 °F PT3: -150.0 to 150.0 °C / -200.0 to 300.0 °F 0.4-2V: 0.400 to 2.000 V 1-5V: 1.000 to 5.000 V 4-20: 4.00 to 20.00 mA 0-2V: 0.000 to 2.000 V 0-10V: 0.00 to 10.00 V 0-20 : 0.00 to 20.00 mA -1020: -10.00 to 20.00 mV 0-100: 0.0 to 100.0 mV	PV Set
UNIT	PV input unit	EASY	-: No unit C: Degree Celsius -: No unit --: No unit ---: No unit F: Degree Fahrenheit	PV Set
RH (Physical quantity)	Maximum value of PV input range	EASY	Depends on the input type. - For temperature input - Set the temperature range that is actually controlled. (RL<RH) - For voltage / current input - Set the range of a voltage / current signal that is applied. The scale across which the voltage / current signal is actually controlled should be set using the maximum value of input scale (SH) and minimum value of input scale (SL). (Input is always 0% when RL = RH.)	PV Set
RL (Physical quantity)	Minimum value of PV input range	EASY	Same as RH	PV Set

Note1: W: W-5% Re/W-26% Re(Hoskins Mfg. Co.). ASTM E988
 WRE: W97Re3-W75Re25

(Continued)

Parameter symbol	Name	Display level	Setting range	Menu symbol
SDP (Scaling)	PV input scale decimal point position	EASY	0: No decimal place 1: One decimal place 2: Two decimal places 3: Three decimal places 4: Four decimal places	PV Set
SH (Scaling)	Maximum value of PV input scale	EASY	-19999 to 30000, (SL<SH), SH - SL ≤ 30000	PV Set
SL (Scaling)	Minimum value of PV input scale	EASY	-19999 to 30000, (SL<SH), SH - SL ≤ 30000	PV Set

IN, UNIT, RH, and RL described above are the parameters to be used for processing before the input ladder calculation program.

The following parameters are used for processing after the input ladder calculation program.

Parameter symbol	Name	Display level	Setting range	Menu symbol
P.UNI	Control PV input unit	STD	-: No unit C: Degree Celsius - -: No unit - - -: No unit F: Degree Fahrenheit	MPV Set
P.DP	Control PV input decimal point position		0: No decimal place 1: One decimal place 2: Two decimal places 3: Three decimal places 4: Four decimal places	
P.RH	Maximum value of control PV input range		-19999 to 30000, (P.RL<P.RH), P.RH - P.RL ≤ 30000	
P.RL	Minimum value of control PV input range			

7.1.2 Setting Burnout Detection for Input

Description

The input value when input burnout occurs can be determined.

The input value is 105.0% of the input range when the upscale is set, and -5.0% of the input range when the downscale is set.

Burnout detection is activated for TC, RTD, and standard signal (0.4–2 V or 1–5 V).

For standard signal, burnout is determined to have occurred if it is 0.1 V or less for the range of 0.4–2 V and 1–5V, or if it is 0.4 mA or less for the range of 4–20 mA.

When input burnout occurs, the error preset output (EPO) is output as control output.

- ▶ [Input error preset output: 10.12.3 Setting Output Value When Error Occurs \(Input Error Preset Output\)](#)

Setting Details

Parameter symbol	Name	Display level	Setting range	Menu symbol
BSL	PV input burnout action	STD	OFF: Disable UP: Upscale DOWN: Downscale	PV Set

7.1.3 Setting Reference Junction Compensation (RJC) or External Reference Junction Compensation (ERJC)

Description

Reference Junction Compensation (RJC)

When TC input is selected, presence/absence of input reference junction compensation can be set.

Usually input values are compensated with the RJC function provided for the controller. However, if it is necessary to rigorously compensate the values with a device other than the function of the controller, for example with a zero-compensator, the RJC function of the controller can be turned off.

External Reference Junction Compensation (ERJC)

For TC input, a temperature compensation value for external device can be set. The external RJC can be used only when RJC = OFF.

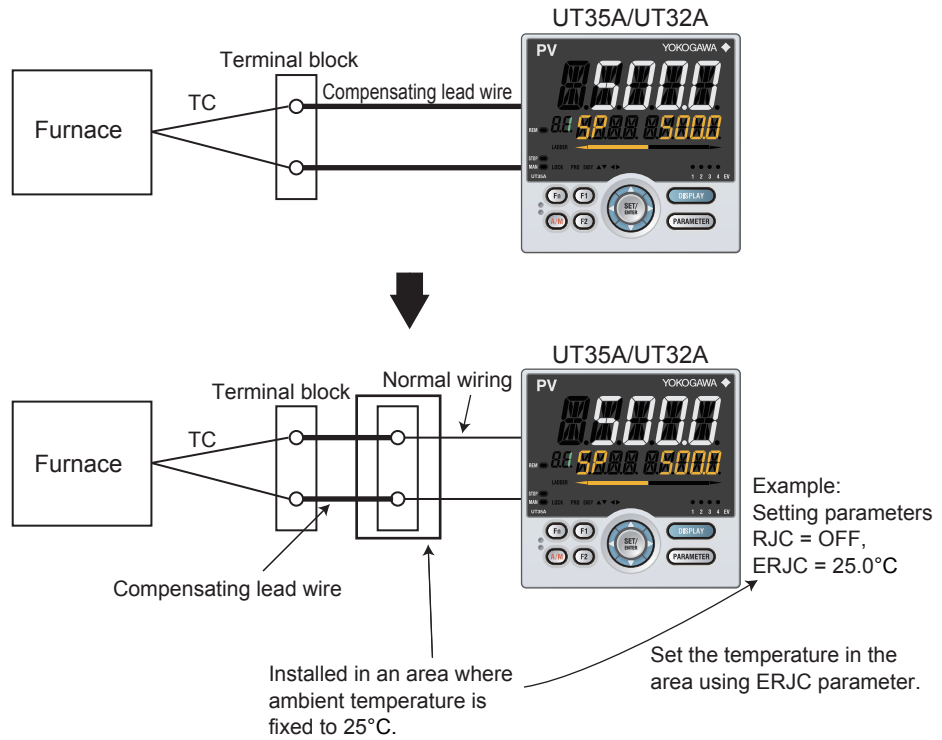

Setting Details

Parameter symbol	Name	Display level	Setting range	Menu symbol
RJC	PV input reference junction compensation	PRO	OFF: RJC OFF ON: RJC ON	PV Set
ERJC	PV input external RJC setpoint	PRO	-10.0 to 60.0°C	PV Set

7.1.4 Correcting Input Value

(1) Setting Bias and Filter

Description

PV Input Bias

The PV input bias allows bias to be summed with input to develop a measured value for display and control use inside the controller.

This function can also be used for fine adjustment to compensate for small inter-instrument differences in measurement reading that can occur even if all are within the specified instrument accuracies.

PV input bias is used for normal operation.

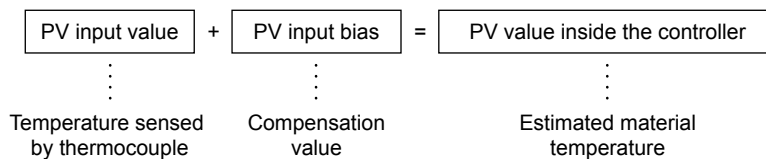

PV Input Filter

If input noise or variations cause the low-order display digits to fluctuate so that the displayed value is difficult to read, a digital filter can be inserted to smooth operation.

This filter provides a first-order lag calculation, which can remove more noise the larger the time constant becomes. However, an excessively large time constant will distort the waveform.

PV input filter is used for normal operation.

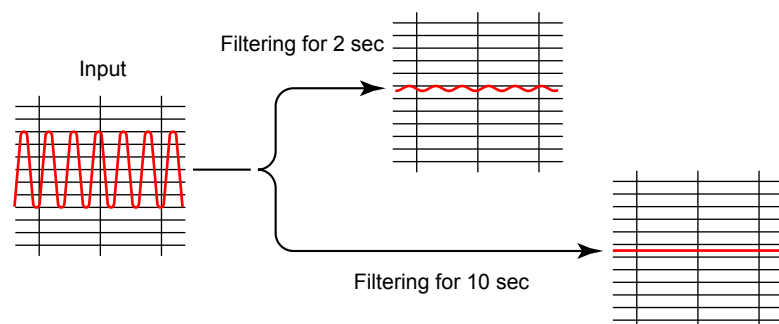
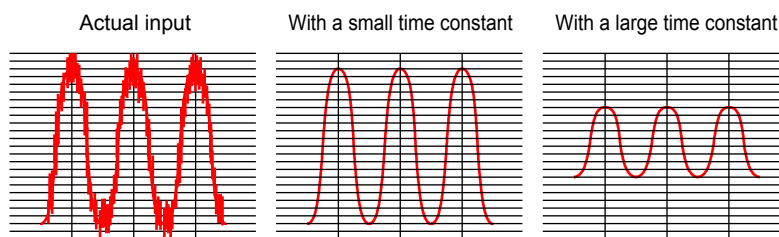

Setting Details

Parameter symbol	Name	Display level	Setting range	Menu symbol
BS	PV input bias	EASY	-100.0 to 100.0% of PV input range span (EUS)	PVS Ope
FL	PV input filter	EASY	OFF, 1 to 120 s	

7.1 Setting Functions of PV Input

7.1.5 Setting Ratio Bias

Description

Ratio bias computing performs ratio computation and bias addition for remote setpoints.

$$\text{SP} = \text{Remote input} \times \text{Remote input ratio (RT)} + \text{Remote input bias (RBS)}$$

Setting Details

Parameter symbol	Name	Display level	Setting range	Menu symbol
RT	Remote input ratio	STD	0.001 to 9.999	SPS 
RBS	Remote input bias	STD	100.0 to 100.0% of PV input range span (EUS)	

Displayed only in cases where the communication is specified.

8.1 Control Function Block Diagrams

8.1.1 Single-loop Control, Heating/cooling Control, Position Proportional Control, and Two-position Two-level Control

Description

These control functions provide the basic control function having one control computation unit.

Single-loop control can be used for Standard type or Heating/cooling type controller.

Heating/cooling control can be used for Heating/cooling type controller.

Position proportional control can be used for Position proportional type controller.

Two-position two-level control can be used for Heating/cooling type controller.

- ▶ [PID control, Heating/cooling control, and Two-position two-level control: 8.2 Setting Control Type \(CNT\)](#)

The Function block diagram describes only the basic functions.

Parameter symbols in the Function block diagram describe representative parameters.

For the functions and parameters which are not described in Function block diagram, see the following.

- ▶ [Contact input assignment: 12.1 Setting Contact Input Function](#)
- ▶ [Contact output assignment: 12.2 Setting Contact Output Function](#)
- ▶ [Contact output assignment to retransmission output terminal: 10.1 Setting Control Output Type](#)
- ▶ [Analog output range change: 10.14 Changing Current Output Range](#)

Single-loop Control Function Block Diagram

Equipped as standard

PV input

PV

Input type IN

Input unit UNIT

Input range/scale RH, RL SDP SH, SL

RS-485, Ethernet, PROFIBUS-DP

Com.

Equipped as standard.
Contact inputs

DI1 DI2

Input ladder calculation program (signal goes to the control computation as is when without ladder program). For ladder program, see the LL50A Parameters Setting Software User's Manual.

PV input bias BS

PV input filter FL

Ratio bias computation RT RBS

REMOTE LOCAL

R/L

SP limiter SPH, SPL

SP ramp rate UPR, DNR TMU

Target setpoints 1 to 4 SPNO SP

PV display SP display

Control computation

CNT ALG

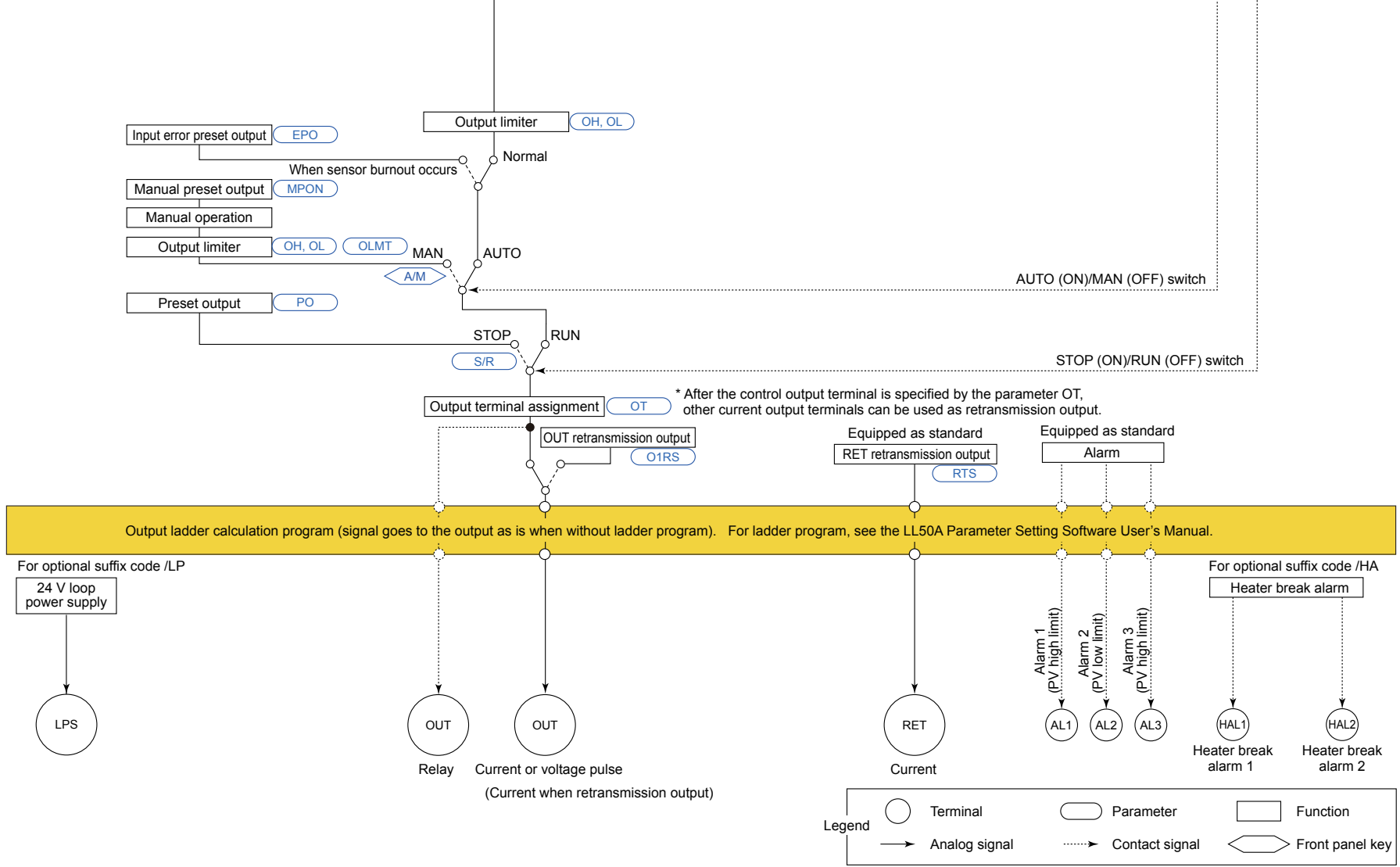

■ Heating/cooling Control Function Block Diagram

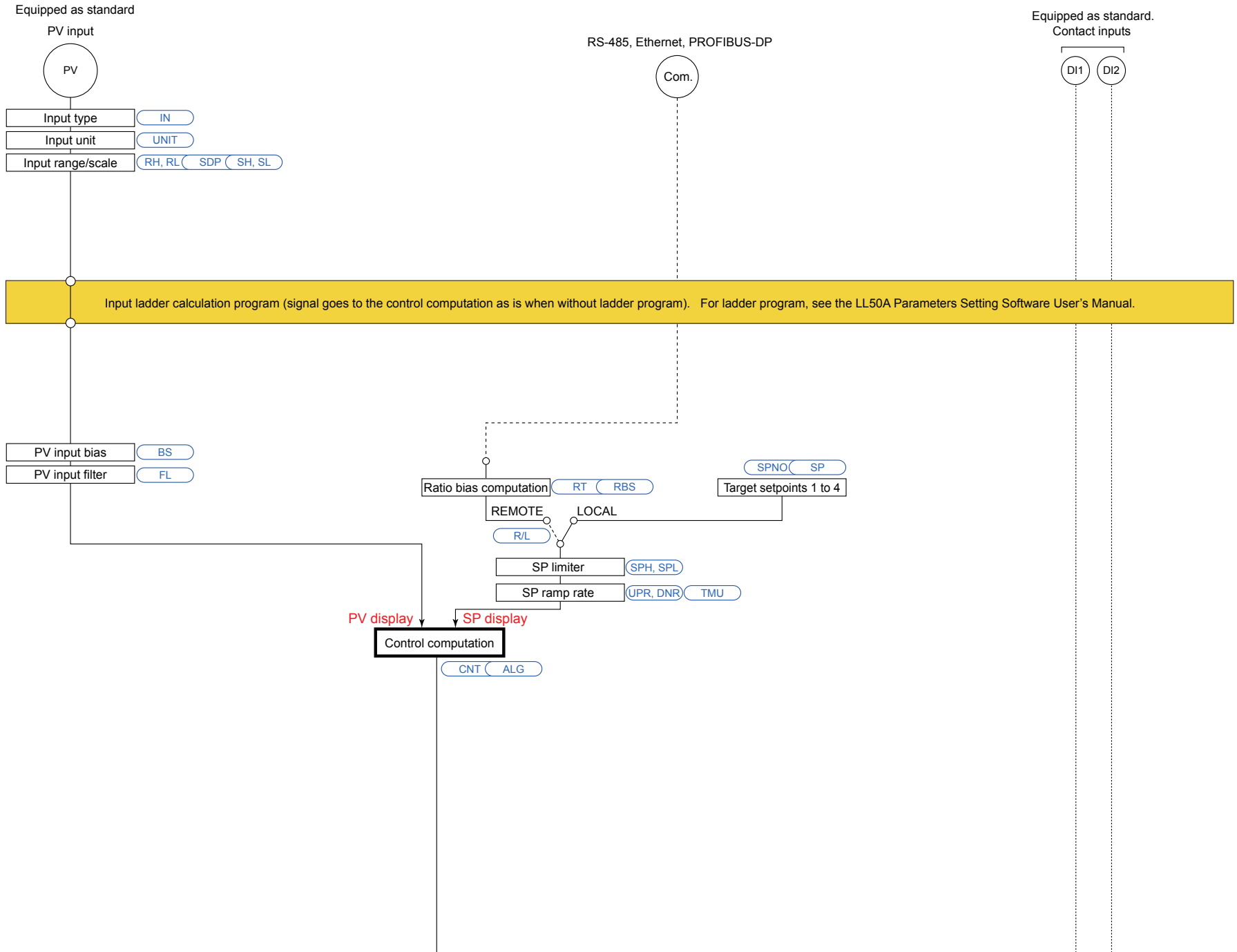

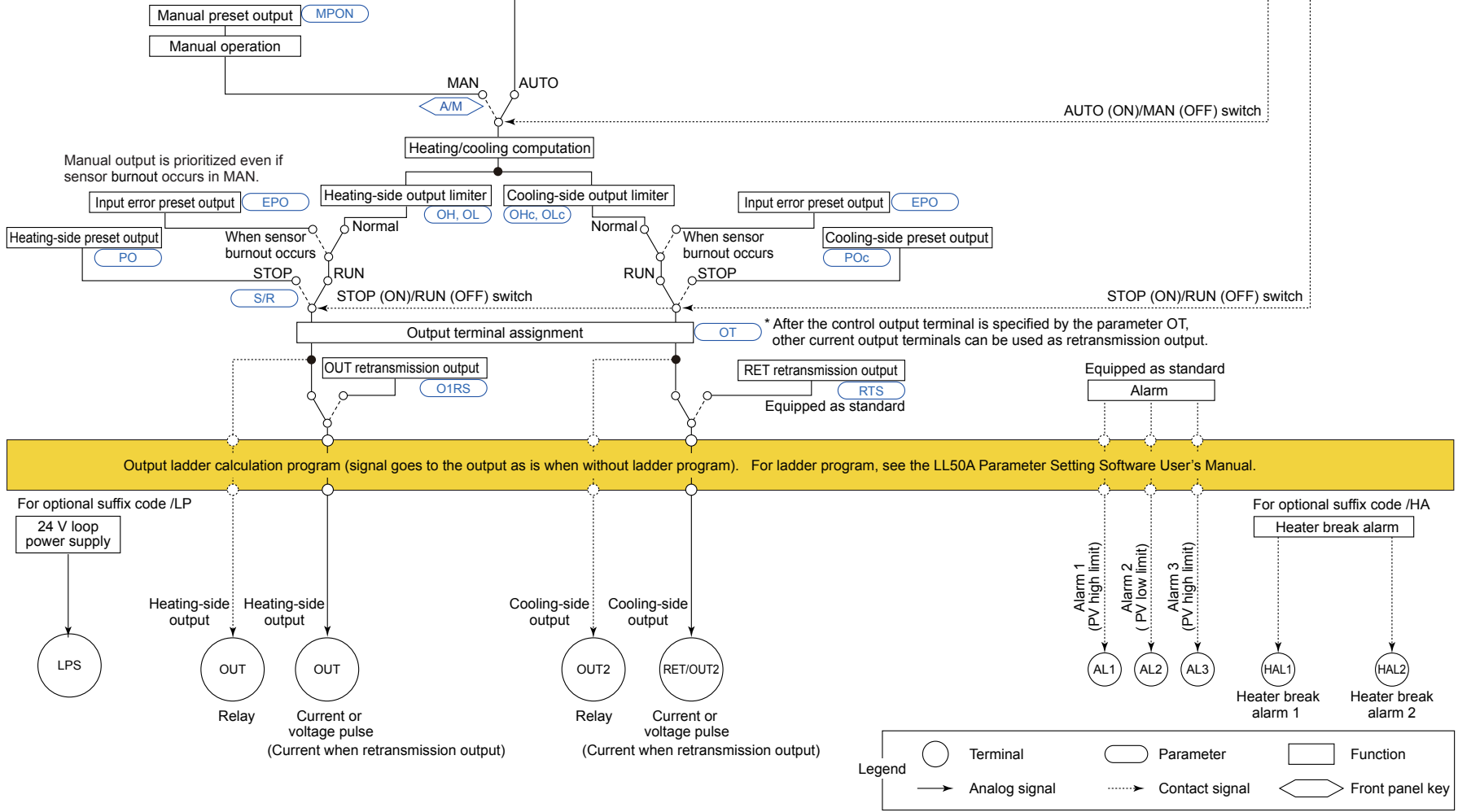

■ Position Proportional Control Function Block Diagram

Equipped as standard

PV input

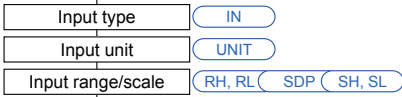

RS-485, Ethernet, PROFIBUS-DP



Equipped as standard.
Contact inputs

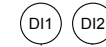

Input ladder calculation program (signal goes to the control computation as is when without ladder program). For ladder program, see the LL50A Parameter Setting Software User's Manual.

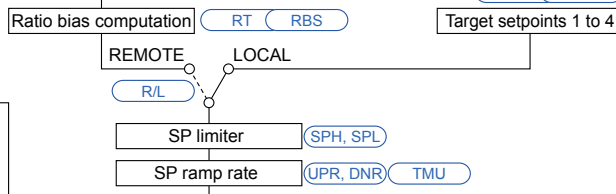
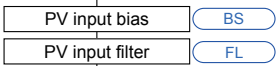

PV display

SP display



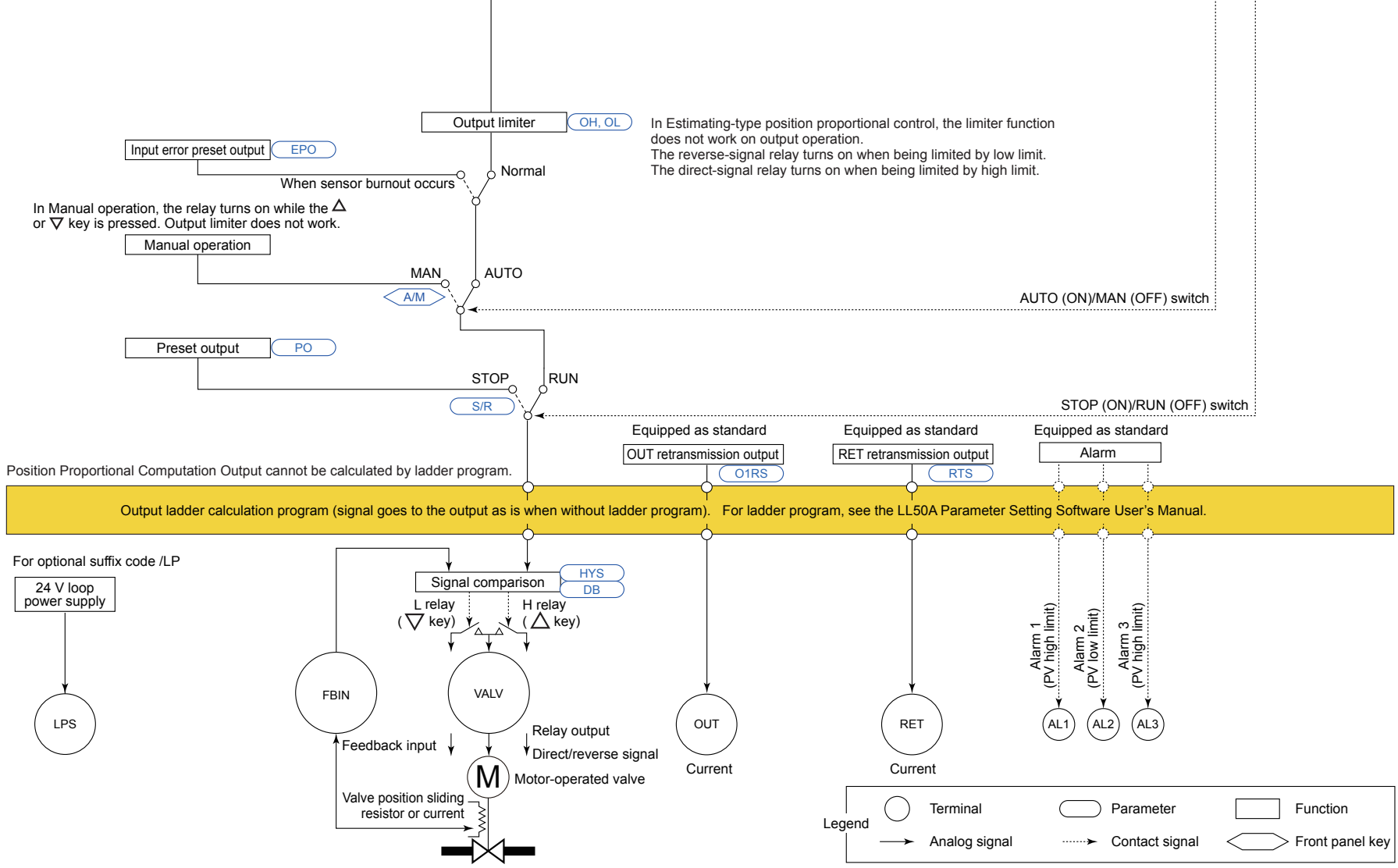

Two-position Two-level Control Function Block Diagram

Equipped as standard

PV input

PV

Input type

IN

Input unit

UNIT

Input range/scale

RH, RL SDP SH, SL

RS-485, Ethernet, PROFIBUS-DP

Com.

Equipped as standard.
Contact inputs

D11

D12

Input ladder calculation program (signal goes to the control computation as is when without ladder program). For ladder program, see the LL50A Parameter Setting Software User's Manual.

PV input bias

BS

PV input filter

FL

Ratio bias computation

REMOTE

LOCAL

R/L

Target setpoints 1 to 4

SPNO SP

SP limiter

SPH, SPL

SP ramp rate

UPR, DNR TMU

PV display

SP display

Main setting control computation

CNT ALG

OFF (0%) or ON (100%)

Sub-target setpoints

SUB

Sub-target setpoint = SP + SUB

PV display

SP display

Sub-setting control computation

OFF (0%) or ON (100%)

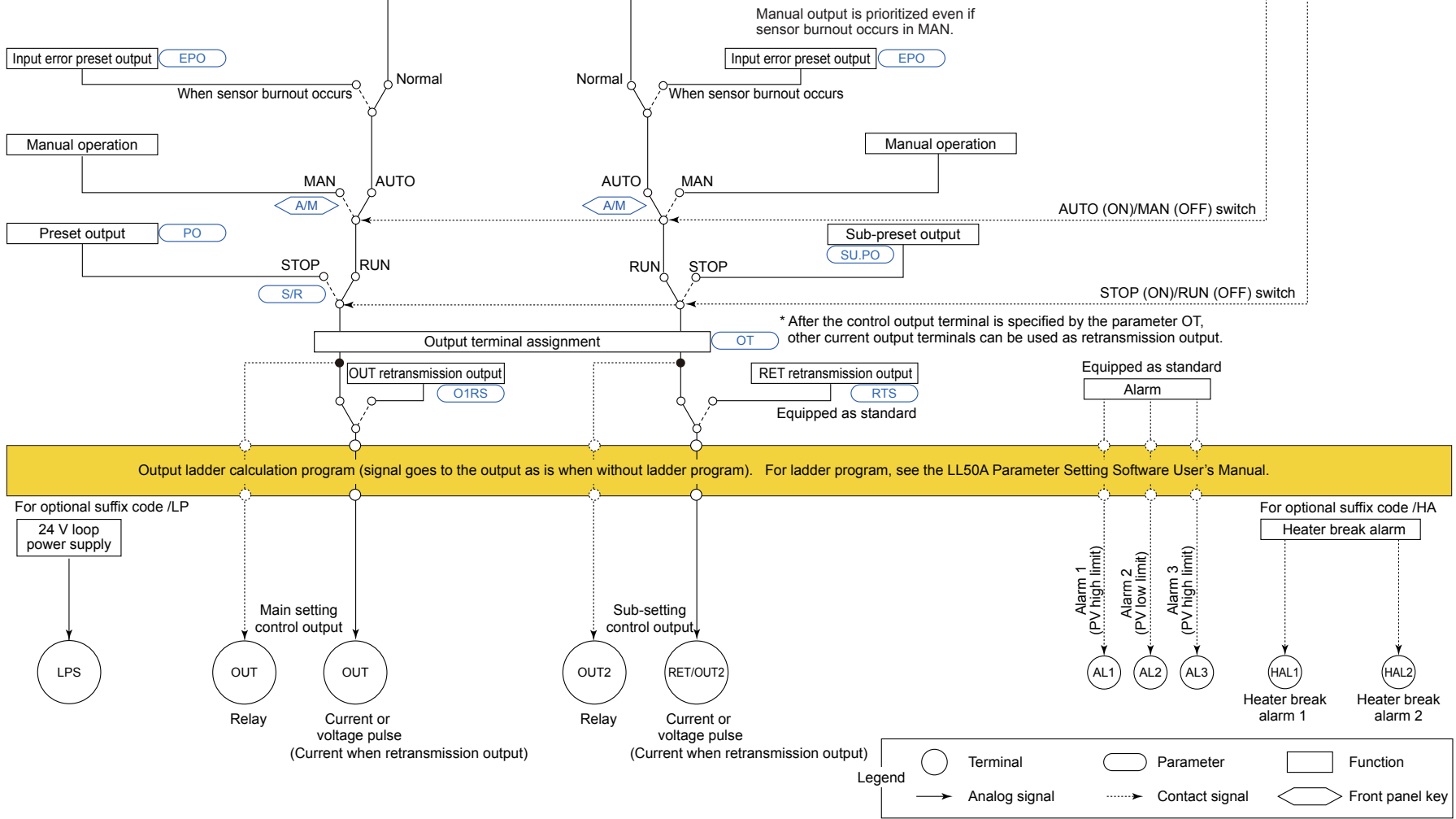

8.2 Setting Control Type (CNT)

The following table shows combination of Standard type, Heating/cooling type, Position proportional type and control type (CNT).

Control type	Suffix code: Type 1		
	Standard type	Heating/cooling type	Position proportional type
PID control	√	√	√
ON/OFF control (1 point of hysteresis)	√	√	N/A
ON/OFF control (2 points of hysteresis)	√	√	N/A
Two-position two-level control	N/A	√	N/A
Heating/cooling control	N/A	√	N/A

√: Available, N/A: Not available

The following table shows combination of control type (CNT) and output type.

Control type	Output type			
	Current output	Time proportional output	ON/OFF output	Position proportional output
PID control	√	√	N/A	√
ON/OFF control (1 point of hysteresis)	√	N/A	√	N/A
ON/OFF control (2 points of hysteresis)	√	N/A	√	N/A
Two-position two-level control	√	N/A	√	N/A
Heating/cooling control	√	√	√	N/A

√: Available, N/A: Not available

► [Output type: 10.1 Setting Control Output Type](#)

8.2.1 PID Control

Description

PID control is a general control using control-related parameters PID.
When PID control is selected, PID should be obtained by auto-tuning after setting SP or PID should be set manually.

Setting Details

Parameter symbol	Name	Display level	Setting range	Menu symbol
CNT	Control type	EASY	PID: PID control ONOF: ON/OFF control (1 point of hysteresis) ONOF2: ON/OFF control (2 points of hysteresis) 2P2L: Two-position two-level control H/C: Heating/cooling control	CTL Set
P	Proportional band Heating-side proportional band (in Heating/cooling control)	EASY	0.0 to 999.9% When 0.0% is set, it operates as 0.1%. Heating-side ON/OFF control applies when 0.0% in Heating/cooling control.	PID Ope
I	Integral time Heating-side integral time (in Heating/cooling control)	EASY	OFF: Disable 1 to 6000 s	
D	Derivative time Heating-side derivative time (in Heating/cooling control)	EASY	OFF: Disable 1 to 6000 s	
Pc	Cooling-side proportional band	EASY	0.0 to 999.9% Cooling-side ON/OFF control applies when 0.0% in Heating/cooling control.	
Ic	Cooling-side integral time	EASY	OFF: Disable 1 to 6000 s	
Dc	Cooling-side derivative time	EASY	OFF: Disable 1 to 6000 s	
MR	Manual reset	EASY	-5.0 to 105.0%	
PIDN	PID number selection	EASY	1 to 4	
PIDG.	Number of PID groups	STD	1 to 4	CTL Set

Note 1: The PID number (1 to 4, or R) is displayed on Group display while the parameter P, I, D, Pc, Ic, Dc, or MR is displayed.

Note

When changing the setpoint of the parameter PIDG., if the setpoint of the parameter PIDN which belongs to the SP menu is larger than that of the parameter PIDG., the PIDN setpoint is changed to the PIDG. setpoint.

8.2 Setting Control Type (CNT)

8.2.2 ON/OFF Control (1 point of hysteresis / 2 points of hysteresis)

Description

ON/OFF control compares the SP and PV and outputs an on or off signal according to the positive or negative deviation ($PV - SP$). Hysteresis can be set in the vicinity of the on/off output operating point.

If the SP and PV become close and the polarity of the deviation reverses frequently, the on/off output will cycle repeatedly. The life of the output relay will therefore be dramatically shortened.

In such a case, set a wider hysteresis so that the relay's frequent on/off output (chattering) will not occur.

When the control type (CNT) is set to "ONOF," one point of hysteresis can be set to the operating point.

When the control type (CNT) is set to "ONOF2," two points of hysteresis (deviation positive hysteresis and deviation negative hysteresis) can be set to the operating point.

1 point of hysteresis

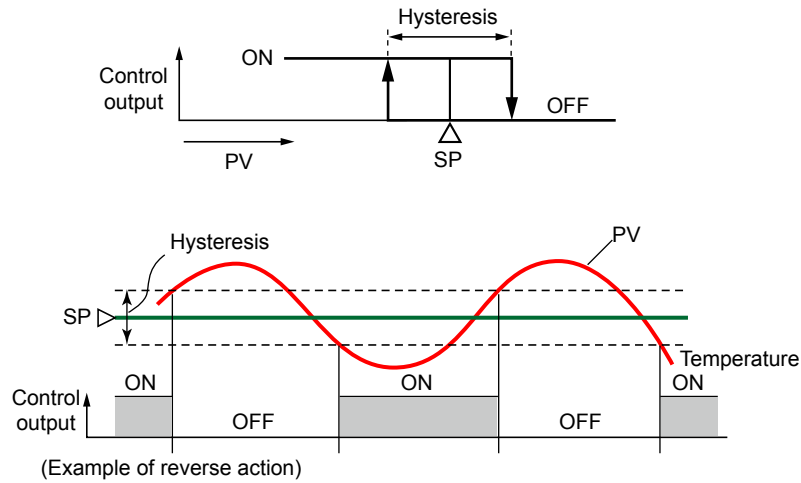

2 points of hysteresis

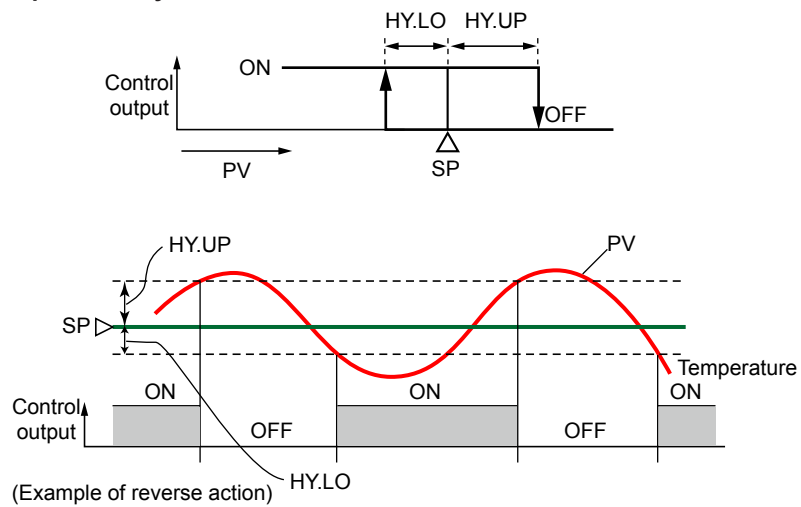

Setting Details

Parameter symbol	Name	Display level	Setting range	Menu symbol
CNT	Control type	EASY	PID: PID control ONOF: ON/OFF control (1 point of hysteresis) ONOF2: ON/OFF control (2 points of hysteresis) 2P2L: Two-position two-level control H/C: Heating/cooling control	CTL Set
HYS	Hysteresis (in ON/OFF control, Position proportional control, or Two-position two-level control) Heating-side ON/OFF control hysteresis (in Heating/cooling control)	EASY	In ON/OFF control or Two-position two-level control: 0.0 to 100.0% of PV input range span (EUS) In Heating/cooling control or Position proportional control: 0.0 to 100.0%	PID Ope
HY.UP	Upper-side hysteresis (in ON/OFF control)	EASY	0.0 to 100.0% of PV input range span (EUS)	
HY.LO	Lower-side hysteresis (in ON/OFF control)	EASY		
PIDN	PID number selection	EASY	1 to 4	SP Ope
PIDG.	Number of PID groups	STD	Set a number of PID groups to use. 1 to 4	CTL Set

Note1: The PID number (1 to 4, or R) is displayed on Group display while the parameter HYS, HY.UP or HY.LO is displayed.

Note

When changing the setpoint of the parameter PIDG., if the setpoint of the parameter PIDN which belongs to the SP menu is larger than that of the parameter PIDG., the PIDN setpoint is changed to the PIDG. setpoint.

8.2.3 Heating/cooling Control

Description

Heating/cooling control can be used only for Heating/cooling type. In Heating/cooling control, the controller outputs the result of computation after splitting it into heating-purpose and cooling-purpose signals. PID control or ON/OFF control can be selected for each of the heating side and the cooling side. Set the heating-side proportional band to "0" to perform ON/OFF control on the heating side. Set the cooling-side proportional band to "0" to perform ON/OFF control on the cooling side.

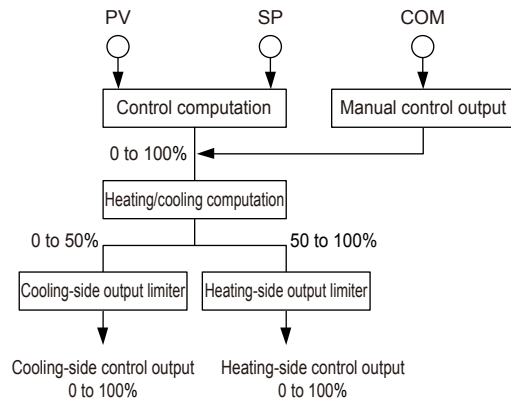

Details of Heating/cooling Control

In Heating/cooling control, PID control or ON/OFF control can be selected for each of the heating side and the cooling side. Set the proportional band to "0" to perform ON/OFF control. The following describes the combination of heating side and cooling side.

When Both the Heating Side and Cooling Side are in PID Control

The following shows the formula and operation example.

$$HOUT = (OUT - \frac{DB}{2} - 50\%) \times 2$$

$$COUT = (50\% - OUT - \frac{DB}{2}) \times 2 \times \frac{P}{Pc}$$

*: OUT: control output, HOUT: heating-side control output, COUT: cooling-side control output, P: heating-side proportional band, Pc: cooling-side proportional band, and DB: dead band

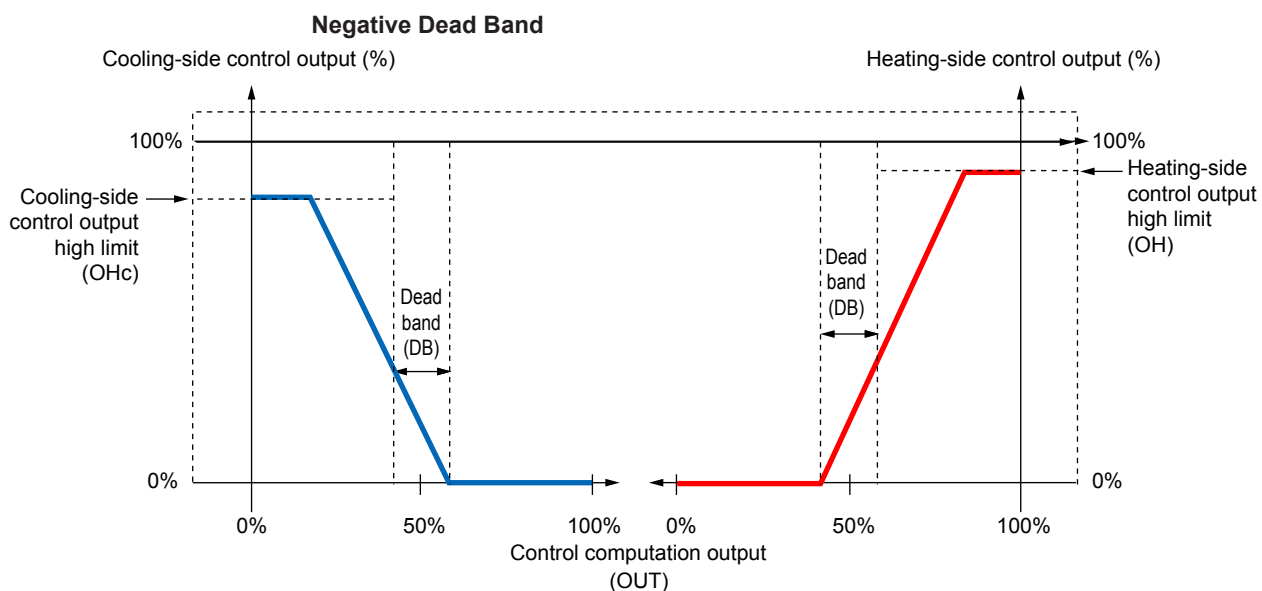
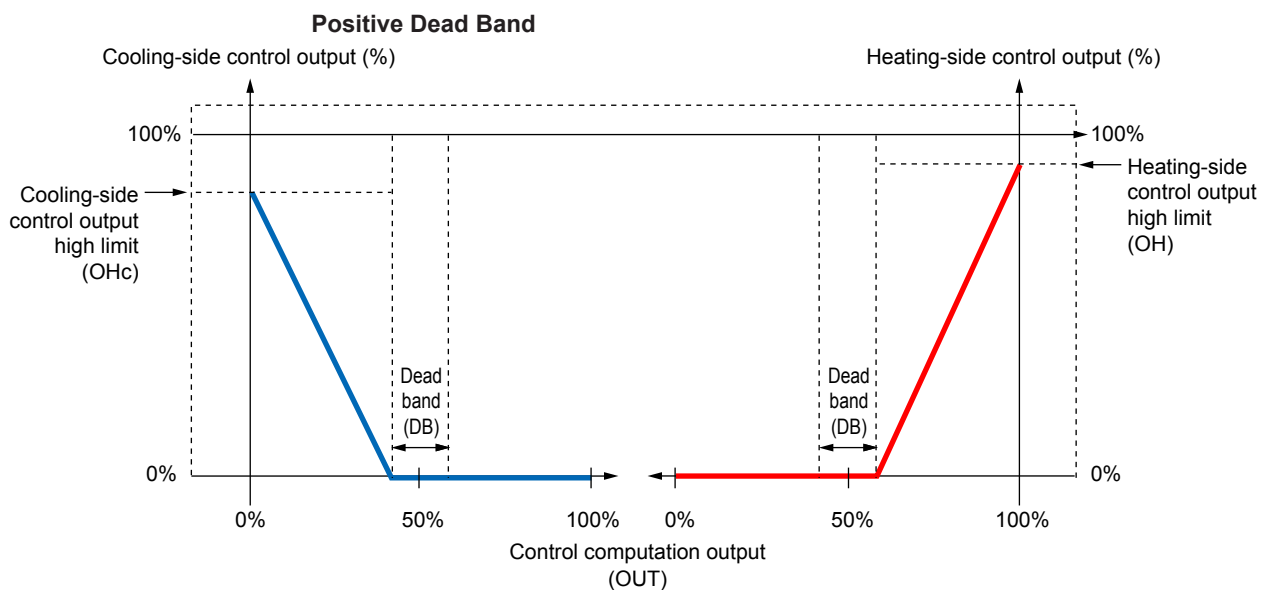

CAUTION

- Set the ratio of the heating-side proportional band (P) to the cooling-side proportional band (P_c) to within 1 to 5.
- Setting the heating-side or cooling-side integral time (I or I_c) to "OFF" results in the integral time of both sides being set to "OFF."

8.2 Setting Control Type (CNT)

When the Heating Side is in ON/OFF Control and the Cooling Side is in PID Control:

The following shows the formula and operation example.

Output turns on when

$$HOUT = OUT > \left(50\% + \frac{DB}{2} + \frac{HYS}{2} \right)$$

Other than this case, maintain current state.

$$COUT = \left(50\% - OUT - \frac{DB}{2} \right) \times 2$$

*: OUT: control output, HOUT: heating-side control output, COUT: cooling-side control output, DB: dead band, and HYS: heating-side hysteresis

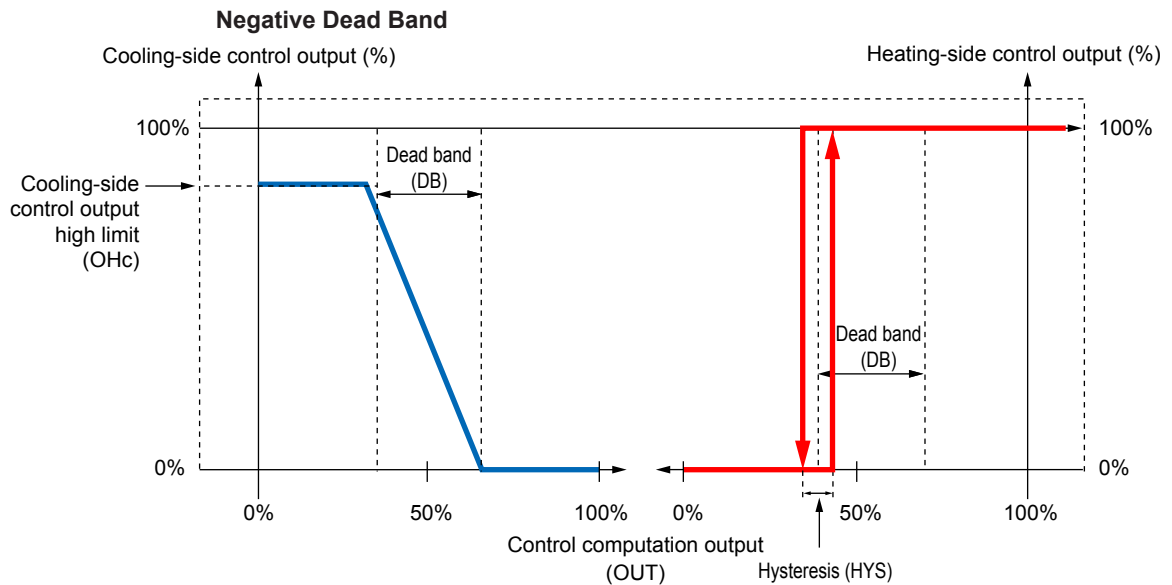
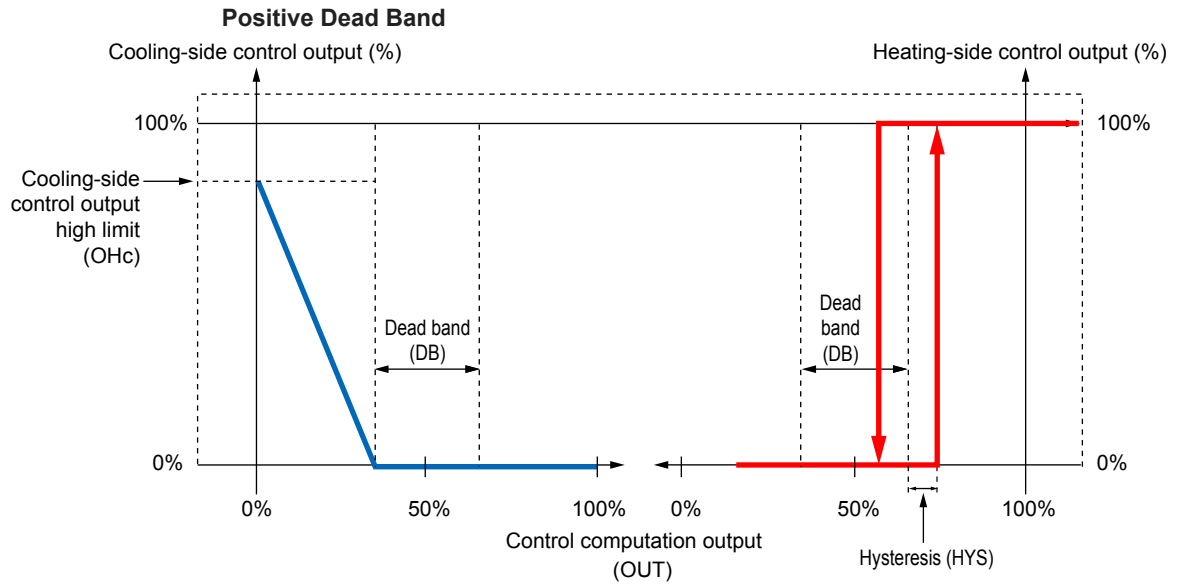

When the Heating Side is in PID Control and the Cooling Side is in ON/OFF Control:

The following shows the formula and operation example.

$$HOUT = (OUT - \frac{DB}{2} - 50\%) \times 2$$

Output turns on when

$$COU = OUT < (50\% - \frac{DB}{2} - \frac{HYSc}{2})$$

Output turns off when

$$OUT > (50\% + \frac{DB}{2} + \frac{HYSc}{2})$$

Other than these cases, maintain current state.

*: OUT: control output, HOUT: heating-side control output, COU: cooling-side control output, DB: dead band, and HYSc: cooling-side hysteresis

Positive Dead Band

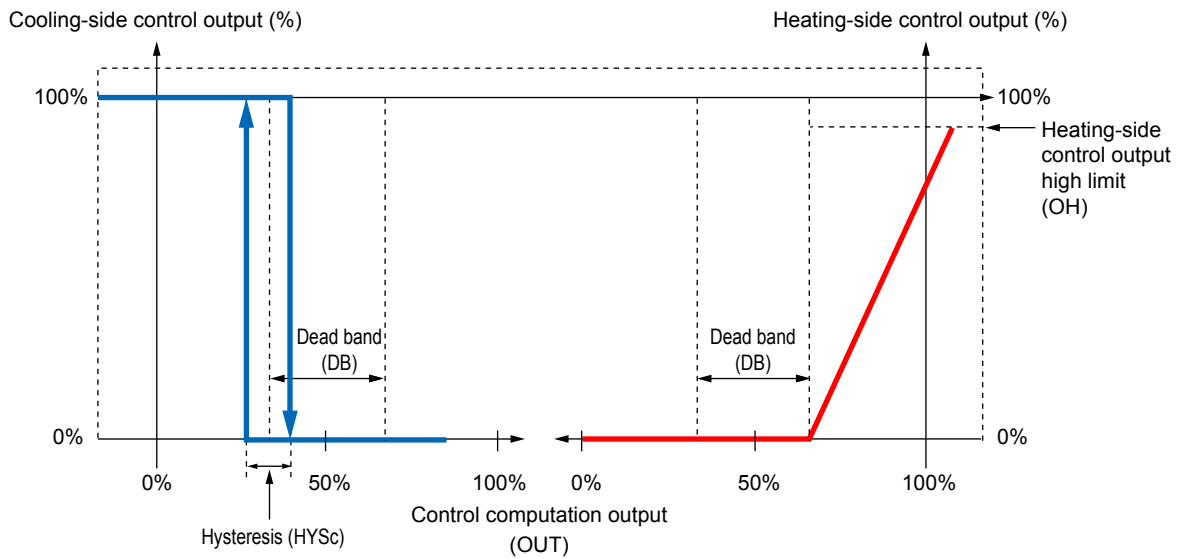

Negative Dead Band

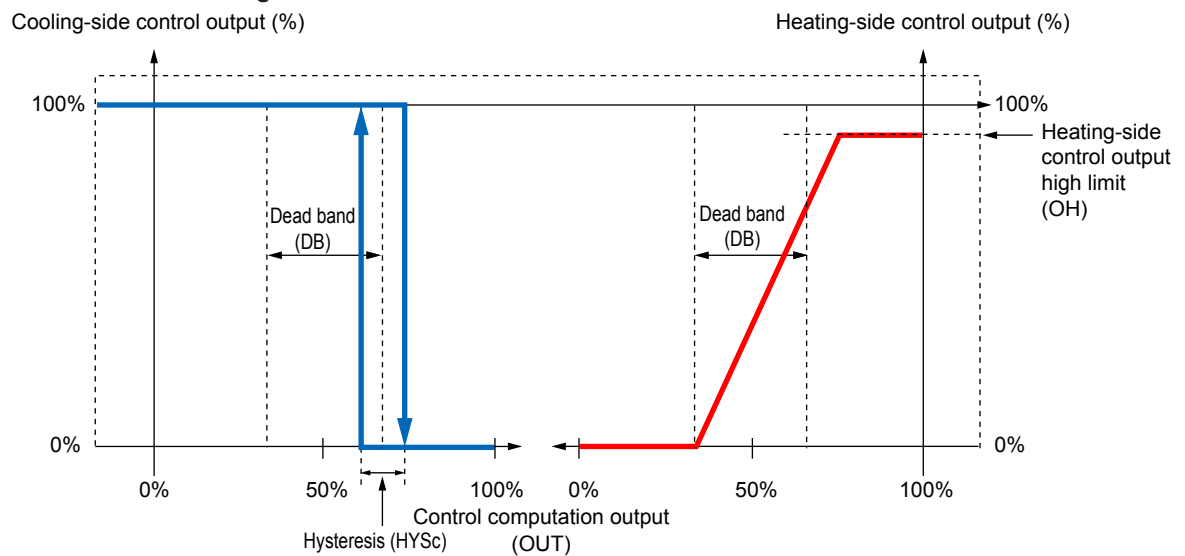

8.2 Setting Control Type (CNT)

When both the Heating Side and Cooling Side are in ON/OFF Control:

The following shows the operation example.

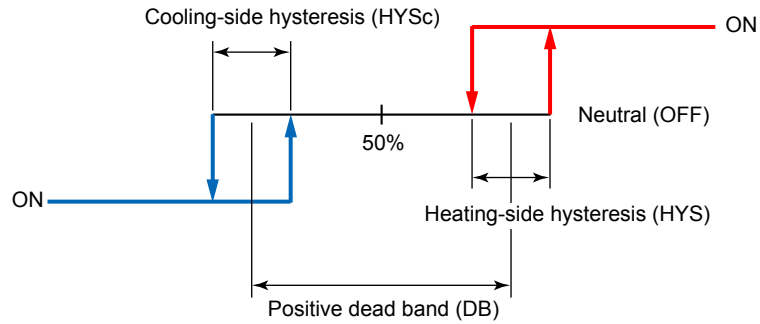

Dead Band (DB)

In Heating/cooling control, the positive dead band denotes the zone where none of the heating-side and cooling-side outputs are presented. The negative dead band denotes the zone where both of the heating-side and cooling-side outputs are presented.

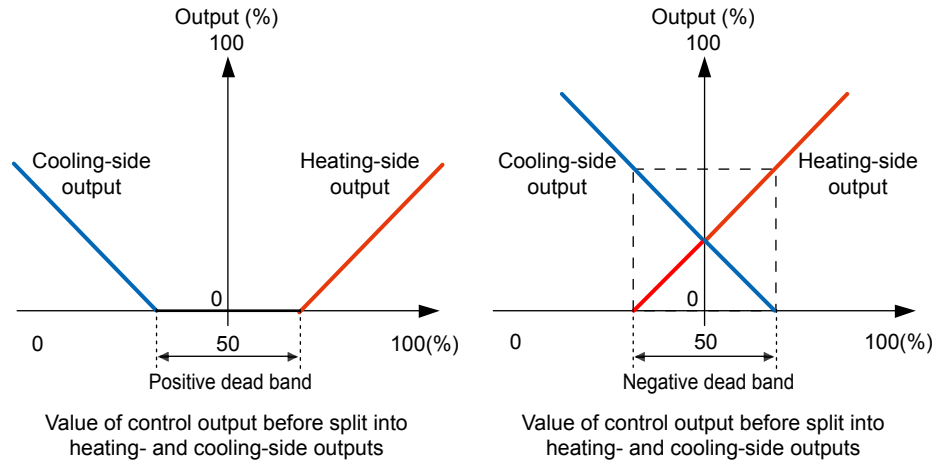

Setting Details

Parameter symbol	Name	Display level	Setting range	Menu symbol
CNT	Control type	EASY	PID: PID control ONOF: ON/OFF control (1 point of hysteresis) ONOF2: ON/OFF control (2 points of hysteresis) 2P2L: Two-position two-level control H/C: Heating/cooling control	CTL Set
HYS	Hysteresis (in ON/OFF control, Position proportional control, or Two-position two-level control) Heating-side ON/OFF control hysteresis (in Heating/cooling control)	EASY	In ON/OFF control or Two-position two-level control: 0.0 to 100.0% of PV input range span (EUS) In Heating/cooling control or Position proportional control: 0.0 to 100.0%	PID Ope
HYS_c	Cooling-side ON/OFF control hysteresis	EASY	0.0 to 100.0%	
DB	Output dead band (in Heating/cooling control or Position proportional control)	EASY	In Heating/cooling control: -100.0 to 50.0% In Position proportional control: 1.0 to 10.0%	
PIDN	PID number selection	EASY	1 to 4	SP Ope
PIDG.	Number of PID groups	STD	1 to 4	CTL Set

Note1: The PID number (1 to 4, or R) is displayed on Group display while the parameter HYS, HYS_c, or DB is displayed.

Note

When changing the setpoint of the parameter PIDG., if the setpoint of the parameter PIDN which belongs to the SP menu is larger than that of the parameter PIDG., the PIDN setpoint is changed to the PIDG. setpoint.

8.2.4 Two-position Two-level Control

Description

Two-position two-level control outputs the ON signal and OFF signal for the target setpoint (SP) of the main setting and the sub-target setpoint (SP + SUB) of the sub-setting.

The sub-setting is set as a deviation from the main setting.

Hysteresis can be set in the vicinity of the on/off output operating point

- ▶ [Two-position two-level control: 8.1.1 Single-loop Control, Heating/cooling Control, Position Proportional Control, and Two-position Two-level Control](#)

Main setting=Direct and Sub-setting=Direct

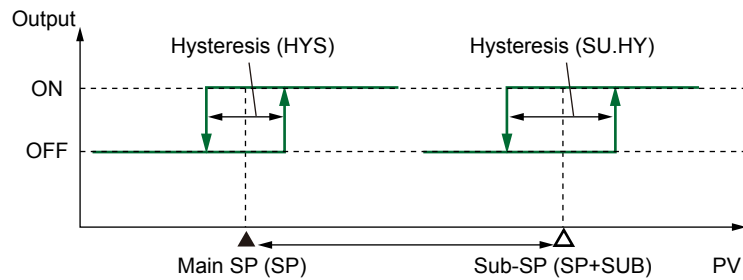

Main setting=Reverse and Sub-setting=Direct

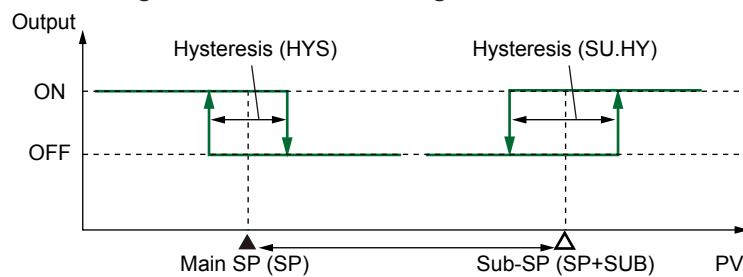

Main setting=Direct and Sub-setting=Reverse

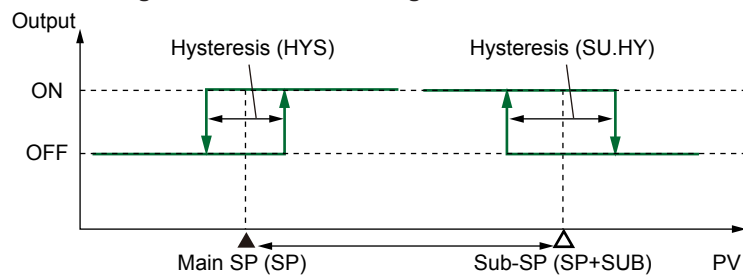

Main setting=Reverse and Sub-setting=Reverse

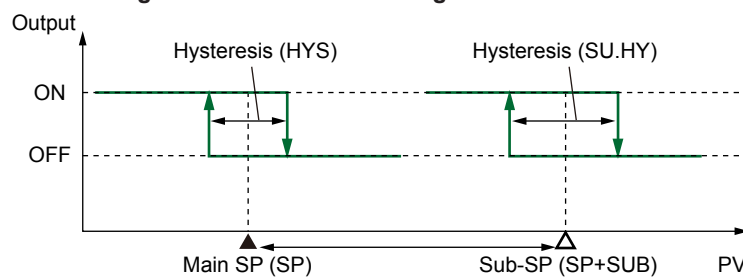

Setting Details

Parameter symbol	Name	Display level	Setting range	Menu symbol
CNT	Control type	EASY	PID: PID control ONOF: ON/OFF control (1 point of hysteresis) ONOF2: ON/OFF control (2 points of hysteresis) 2P2L: Two-position two-level control H/C: Heating/cooling control	CTL Set
SP	Target setpoint	EASY	0.0 to 100.0% of PV input range (EU) (Setting range: SPL to SPH)	SP Ope
SUB	Sub-target setpoint (in Two-position two-level control)	EASY	Set the offset from SP. -100.0 to 100.0% of PV input range span (EUS)	SP Ope
HYS	Hysteresis (in ON/OFF control, Position proportional control, or Two-position two-level control) Heating-side ON/OFF control hysteresis (in Heating/cooling control)	EASY	In ON/OFF control or Two-position two-level control: 0.0 to 100.0% of PV input range span (EUS) In Heating/cooling control or Position proportional control: 0.0 to 100.0%	PID Ope
SU.HY	Sub-hysteresis (in Two-position two-level control)	EASY	0.0 to 100.0% of PV input range span (EUS)	PID Ope
DR	Direct/reverse action switch	STD	RVS: Reverse action DIR: Direct action	
SU.DR	Sub-direct/reverse action switch (in Two-position two-level control)	STD		
PIDN	PID number selection	EASY	1 to 4	SP Ope
PIDG.	Number of PID groups	STD	1 to 4	CTL Set

Note1: The PID number (1 to 4, R) is displayed on Group display while the parameter SP, SUB, HYS, SU.HY, DR, or SU.DR is displayed.

Note

When changing the setpoint of the parameter PIDG., if the setpoint of the parameter PIDN which belongs to the SP menu is larger than that of the parameter PIDG., the PIDN setpoint is changed to the PIDG. setpoint.

8.2 Setting Control Type (CNT)

8.2.5 PD Control (Stable Control in Which a Setpoint is not Exceeded)

Description

This control type performs control in which integral action (I action) is excluded from PID action.

Set the integral time (I or I_c) to OFF.

It is useful when stable control in which a setpoint is not exceeded is desired for integral processes in which constant flows are delivered.

The following shows the PID control computation formula.

$$\text{OUT} = \frac{100}{P} \left(e + T_d \frac{d}{dt} \cdot \Delta \text{PV} \right) + \text{MR}$$

where OUT: control output, e: deviation (PV-SP), P: proportional band, T_d: derivative time, ΔPV: PV_n-PV_{n-1} (n-1: value before one control period), and MR: manual reset

The following table shows combination of PD control and output method.

	Output method			
	Current output	Time proportional output	ON/OFF output	Position proportional output
PD control	√	√	N/A	√

√: Available, N/A: Not available

Setting Details

Parameter symbol	Name	Display level	Setting range	Menu symbol
P	Proportional band	EASY	0.0 to 999.9% When 0.0% is set, it operates as 0.1%.	PID Ope
D	Derivative time	EASY	OFF: Disable 1 to 6000 s	
MR	Manual reset	EASY	-5.0 to 105.0%	
PIDG.	Number of PID groups	STD	1 to 4	CTL Set

Note1: The PID number (1 to 4, or R) is displayed on Group display while the parameter P, D, or MR is displayed.

Note

When changing the setpoint of the parameter PIDG., if the setpoint of the parameter PIDN which belongs to the SP menu is larger than that of the parameter PIDG., the PIDN setpoint is changed to the PIDG. setpoint.

8.3 Setting PID Control Mode (ALG)

Description

There are two PID control modes: standard PID control mode and fixed-point control mode.

Select a PID control computation formula shown in the following table according to the control mode or operation mode.

	Operation mode	
	AUTO+Local	AUTO+Remote
Standard PID control mode	PV derivative type (output bump at SP change)	Deviation derivative type
Fixed-point control mode	PV derivative type (output bumpless at SP change)	PV derivative type (output bump at SP change)

PV Derivative Type PID

This is a PID control method in which the derivative action works only on the PV. It can also eliminate output bump due to SP changing operation in Local mode. The following shows the PV derivative type PID control computation formula.

$$\text{OUT} = \frac{100}{P} \left(e + \frac{1}{T_i} \int e \cdot dt + T_d \frac{d}{dt} \cdot \Delta PV \right)$$

where OUT: control output, e: deviation (PV-SP), P: proportional band, Ti: integral time, Td: derivative time, and ΔPV : $PV_n - PV_{n-1}$ (n-1: value before one control period)

PV Derivative Type PID (output bump at SP change)

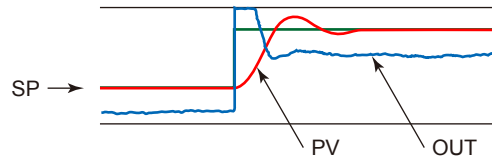

PV Derivative Type PID (output bumpless at SP change)

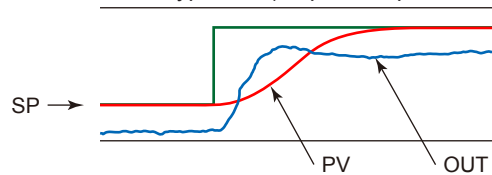

8.3 Setting PID Control Mode (ALG)

Deviation Derivative Type PID

The PID control method in which derivative action works for the deviation value = PV – SP.

The following shows the deviation derivative type PID control computation formula.

$$OUT = \frac{100}{P} \left(e + \frac{1}{Ti} \int e \cdot dt + Td \frac{d}{dt} \cdot e \right)$$

where OUT: control output, e: deviation (PV-SP), P: proportional band, Ti: integral time, and Td: derivative time

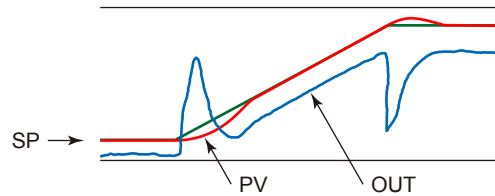

Setting Details

Parameter symbol	Name	Display level	Setting range	Menu symbol
ALG	PID control mode	PRO	0: Standard PID control mode 1: Fixed-point control mode.	CTL Set

8.4 Switching PID

8.4.1 Switching PID According to Target Setpoint Number (SPNO)

Description

The SP group number selection selects a group of target setpoint (SP) and PID parameters by switching the SP number (SPNO).

The PID number selection (PIDN) can be set for each SP group.

SP number (SPNO)	SP	PID parameter group
1	SP of group 1	Specify using the parameter PIDN of group 1
2	SP of group 2	Specify using the parameter PIDN of group 2
3	SP of group 3	Specify using the parameter PIDN of group 3
4	SP of group 4	Specify using the parameter PIDN of group 4

When ZON=0 (SP group number selection 1): In coordinated operation, slaves operate with the same PID number as that of the master.

The setpoint in the PID number selection (PIDN) within the SP group is ignored.

When ZON=3 (SP group number selection 2): In coordinated operation, slaves operate with the setpoint in the PID number selection (PIDN) within the SP group.

Setting Details

Parameter symbol	Name	Display level	Setting range	Menu symbol
ZON	Zone PID selection	STD	0: SP group number selection 1 1: Zone PID selection (selection by PV) 2: Zone PID selection (selection by target SP) 3: SP group number selection 2 4: Zone PID selection (selection by SP)	CTL Set
PIDN	PID number selection	EASY	1 to 4 (Depends on the setup parameter PIDG. setting.)	SP Ope
PID	PID number (display only)	EASY	1 to 4	MODE Ope
PIDG.	Number of PID groups	STD	1 to 4	CTL Set

Note1: The initial values for PIDN of the four groups are same as SP number selection (SPNO.). Set a PID number to use as necessary.

Note3: A currently-used PID number is displayed for the parameter PID.

Note

When changing the setpoint of the parameter PIDG., if the setpoint of the parameter PIDN which belongs to the SP menu is larger than that of the parameter PIDG., the PIDN setpoint is changed to the PIDG. setpoint.

8.4.2 Switching PID According to PV

Description

The PID switching according to PV is a function that switches between the groups of PID parameters according to the PV.

The maximum number of PID groups to be switched is 8. (Set RP1 to RP3.)

This function is useful for reactors in which the chemical reaction gain changes depending on the temperature.

The figure below shows an example of dividing the PV input range from the maximum value to the minimum value into four zones by reference points 1 to 3. (Set RP1 to RP3.)

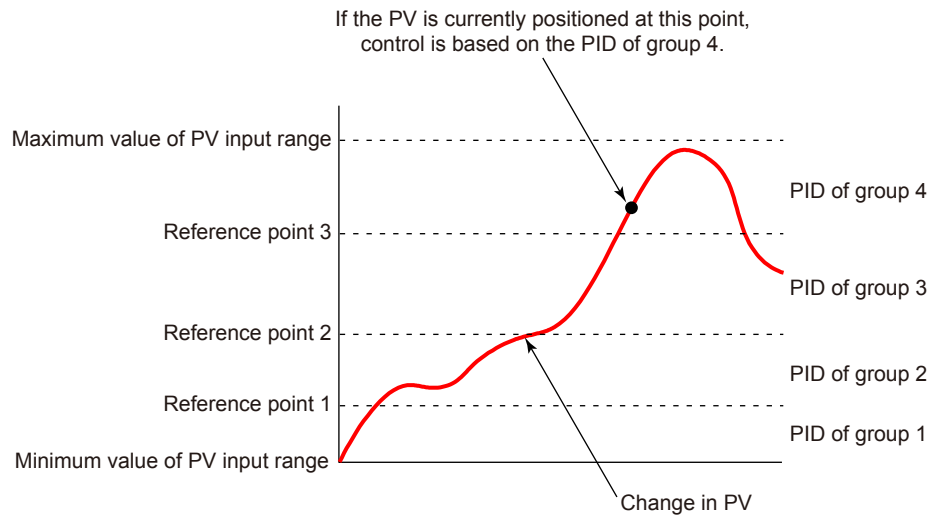

The PV input range can be divided into the number of zones that is set in the reference point.

Hysteresis at the time of zone switch can be set.

▶ [Setpoint PD: 8.4.6 Setting Hysteresis at Time of Zone Switch](#)

Reference deviation can be set at the same time.

▶ [Reference deviation: 8.4.5 Switching PID according to Deviation \(Reference Deviation\)](#)

Setting Details

Parameter symbol	Name	Display level	Setting range	Menu symbol
ZON	Zone PID selection	STD	0: SP group number selection 1 1: Zone PID selection (selection by PV) 2: Zone PID selection (selection by target SP) 3: SP group number selection 2 4: Zone PID selection (selection by SP)	CTL Set
RP1 to RP3	Reference point 1 to 3	STD	0.0 to 100.0% of PV input range (EU) ($RP1 \leq RP2 \leq RP3$)	ZONE Ope
PIDG.	Number of PID groups	STD	1 to 4	CTL Set
PID	PID number (display only)	EASY	1 to 4, R: PID group for reference deviation	MODE Ope

Note1: A currently-used PID number is displayed for the parameter PID.

Note

When changing the setpoint of the parameter PIDG., if the setpoint of the parameter PIDN which belongs to the SP menu is larger than that of the parameter PIDG., the PIDN setpoint is changed to the PIDG. setpoint.

8.4.3 Switching PID According to SP

Description

The zone PID selection by SP switches between the groups of PID parameters according to the SP.

The maximum number of PID groups to be switched is 4. (Set RP1 to RP3.)

The figure below shows the example of switching the group of PID parameters according to the SP. It shows an example of dividing the PV input range from the maximum value to the minimum value into four zones by reference points 1 to 3. (Set RP1 to RP3.)

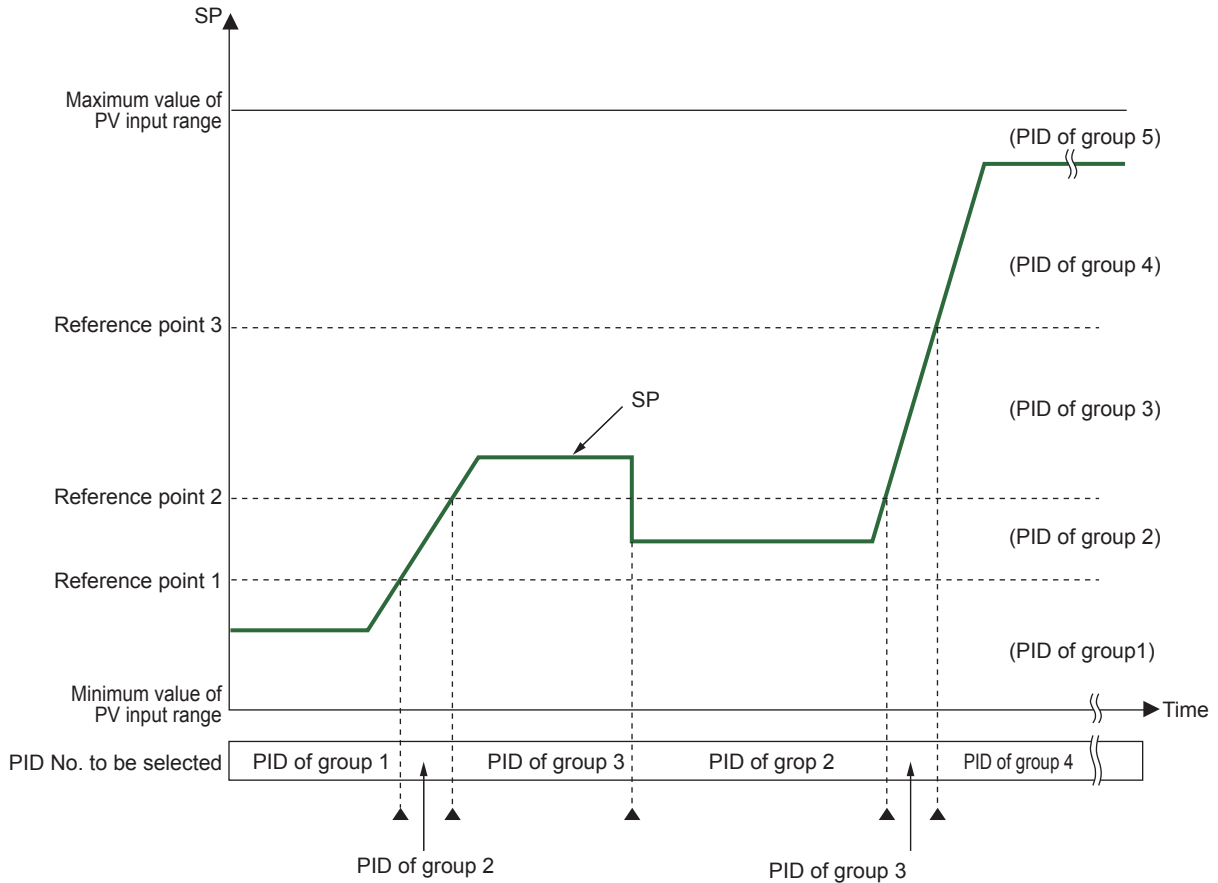

The PV input range can be divided into the number of zones that is set in the reference point.

Reference deviation can be set at the same time.

▶ [Reference deviation: 8.4.5 Switching PID according to Deviation \(Reference Deviation\)](#)

Setting Details

Parameter symbol	Name	Display level	Setting range	Menu symbol
ZON	Zone PID selection	STD	0: SP group number selection 1 1: Zone PID selection (selection by PV) 2: Zone PID selection (selection by target SP) 3: SP group number selection 2 4: Zone PID selection (selection by SP)	CTL Set
RP1 to RP3	Reference point 1 to 3	STD	0.0 to 100.0% of PV input range (EU) ($RP1 \leq RP2 \leq RP3$)	ZONE Ope
PIDG.	Number of PID groups	STD	1 to 4	CTL Set
PID	PID number (display only)	EASY	1 to 4, R: PID group for reference deviation	MODE Ope

Note1: A currently-used PID number is displayed for the parameter PID.

Note

When changing the setpoint of the parameter PIDG., if the setpoint of the parameter PIDN which belongs to the SP menu is larger than that of the parameter PIDG., the PIDN setpoint is changed to the PIDG. setpoint.

8.4 Switching PID

8.4.4 Switching PID According to Target SP

Description

The zone PID selection by target SP switches between the groups of PID parameters according to the target SP.

The figure below shows the example of switching the group of PID parameters according to the target SP. It shows an example of dividing the PV input range from the maximum value to the minimum value into four zones by reference points 1 to 3. (Set RP1 to RP3.)

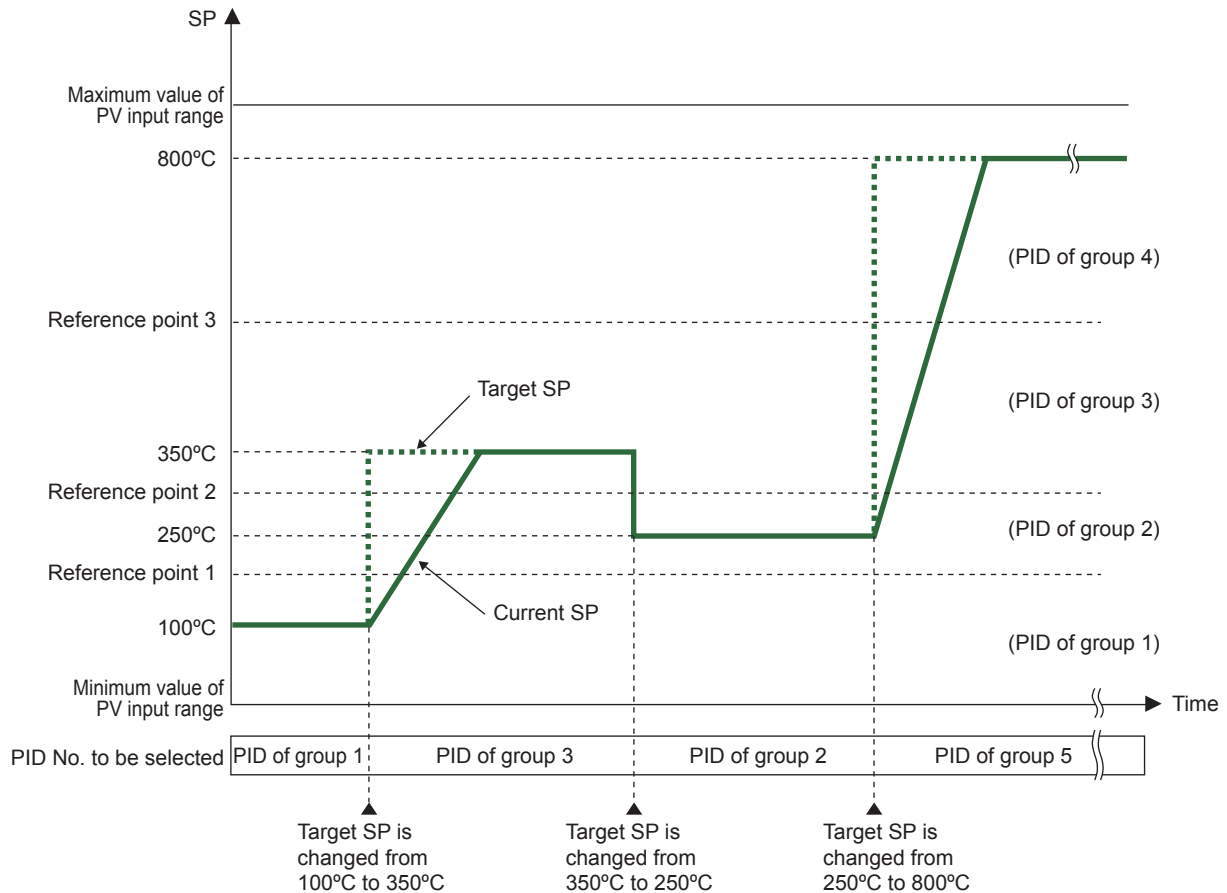

The PV input range can be divided into the number of zones that is set in the reference point.

Reference deviation can be set at the same time.

► [Reference deviation: 8.4.5 Switching PID according to Deviation \(Reference Deviation\)](#)

Setting Details

Parameter symbol	Name	Display level	Setting range	Menu symbol
ZON	Zone PID selection	STD	0: SP group number selection 1 1: Zone PID selection (selection by PV) 2: Zone PID selection (selection by target SP) 3: SP group number selection 2 4: Zone PID selection (selection by SP)	CTL Set
RP1 to RP3	Reference point 1 to 3	STD	0.0 to 100.0% of PV input range (EU) ($RP1 \leq RP2 \leq RP3$)	ZONE Ope
PIDG.	Number of PID groups	STD	1 to 4	CTL Set
PID	PID number (display number)	EASY	1 to 4, R: PID group for reference deviation	MODE Ope

Note1: A currently-used PID number is displayed for the parameter PID.

Note

When changing the setpoint of the parameter PIDG., if the setpoint of the parameter PIDN which belongs to the SP menu is larger than that of the parameter PIDG., the PIDN setpoint is changed to the PIDG. setpoint.

8.4.5 Switching PID According to Deviation (Reference Deviation)

Description

The zone PID selection by deviation switches between the groups of PID parameters according to the amount of deviation. This function is called “reference deviation.”

In the fixed point control, if the actual amount of deviation exceeds the setpoint of the reference deviation, the controller automatically changes to the PID parameter group (PID of group R) set for the zone. If the actual amount of deviation becomes smaller than the setpoint of reference deviation, the controller changes to the PID parameter group appropriate for the zone.

For example, if the deviation is large, PV can be reached more rapidly to SP by increasing the proportional gain (i.e., narrowing the proportional band). Switching PID according to deviation is effective when ZON is set to 1, 2, 4. The zone PID selection by reference deviation has priority over other zone PID selections.

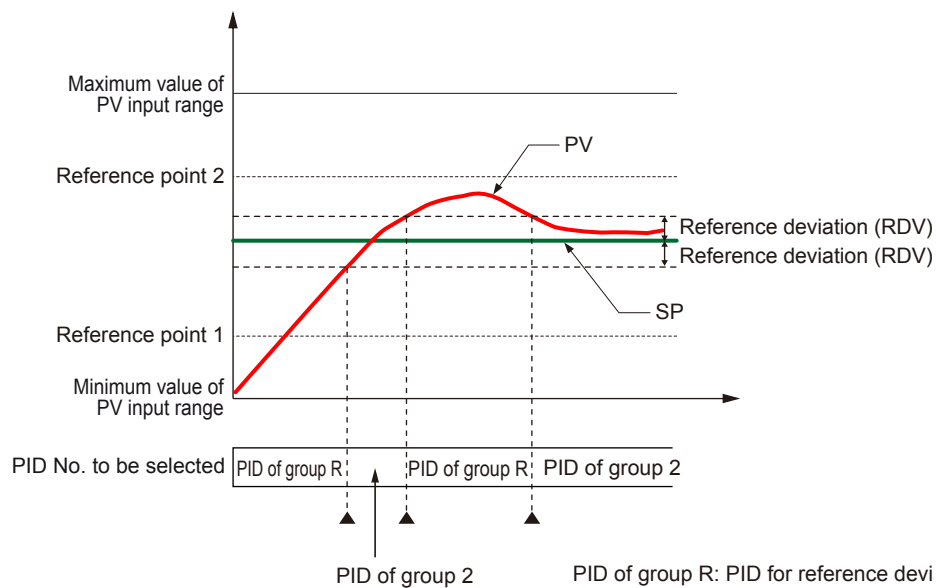

Setting Details

Parameter symbol	Name	Display level	Setting range	Menu symbol
ZON	Zone PID selection	STD	0: SP group number selection 1 1: Zone PID selection (selection by PV) 2: Zone PID selection (selection by target SP) 3: SP group number selection 2 4: Zone PID selection (selection by SP)	CTL Set
RDV	Reference deviation	STD	OFF: Disable 0.0 + 1 digit to 100.0% of PV input range span (EUS)	ZONE Ope
PID	PID number (display only)	EASY	1 to 4, R: PID group for reference deviation	MODE Ope

Note1: A currently-used PID number is displayed for the parameter PID.

8.4.6 Setting Hysteresis at Time of PID Switch

Description

When the zone PID selection is selected, hysteresis at time of each zone switch can be set.

The following shows the operation example of hysteresis at time of zone switch.

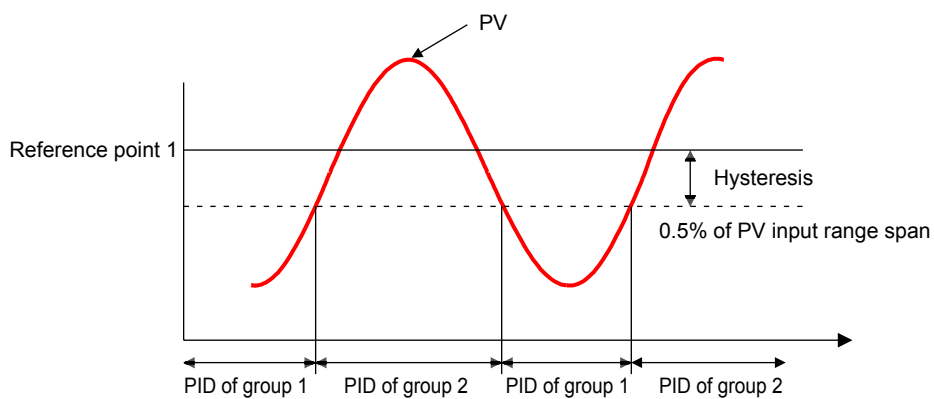

Setting Details

Parameter symbol	Name	Display level	Setting range	Menu symbol
RHY	Zone PID switching hysteresis	STD	0.0 to 10.0% of PV input range span (EUS)	ZONE Ope

8.5 Suppressing Overshoot (Super Function)

Description

The Super function monitors the deviation for evidence that there is a danger of overshoot, and on sensing such danger automatically changes the setpoint temporarily to a somewhat lower value (sub-SP).

Once the danger of overshoot appears diminished, the function returns the effective SP gradually to the true SP. "Fuzzy ratiocination" techniques are employed in the algorithms used to change the SP to the lower temporary value, and to return it gradually to the true SP.

Operation Diagram

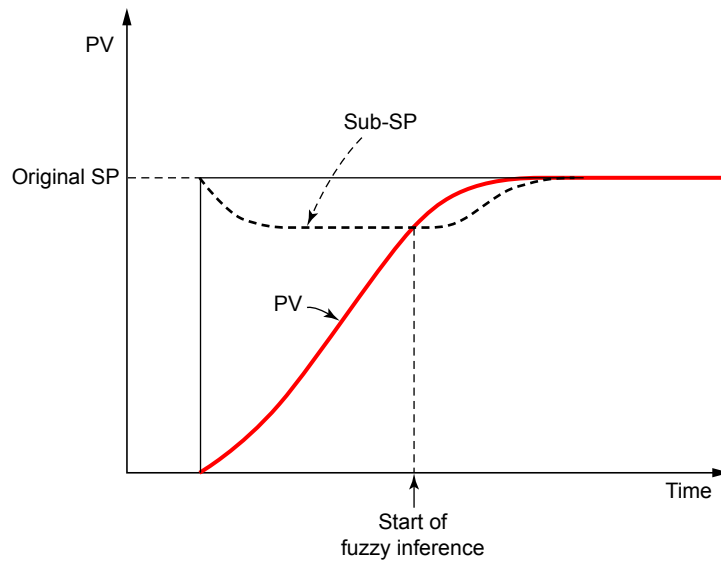

Control System Block Diagram

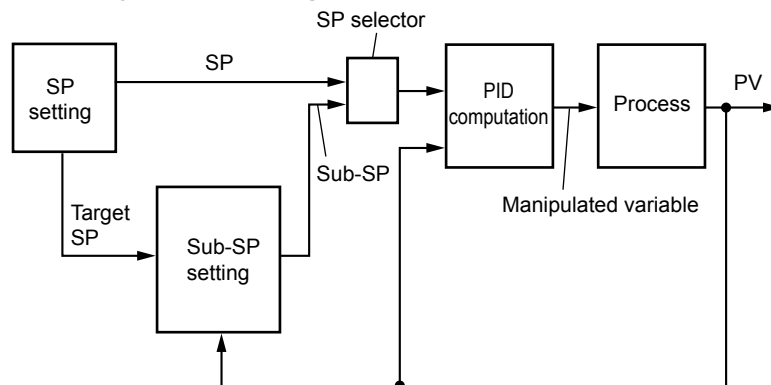

Example of Overshoot Suppression Control for Setpoint Changes

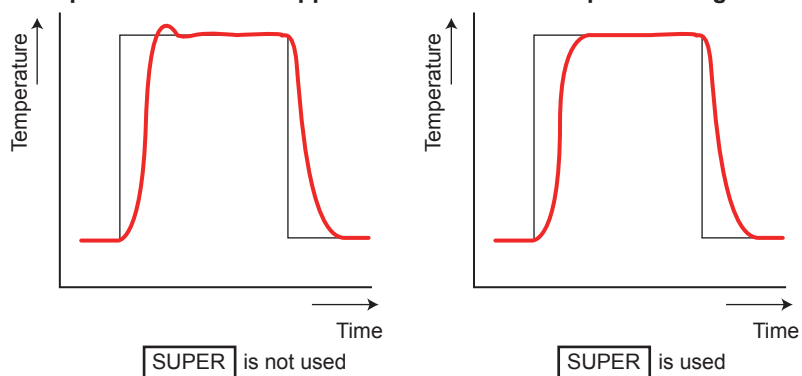

Example of Overshoot Suppression Control for Ramp-to-soak Transition

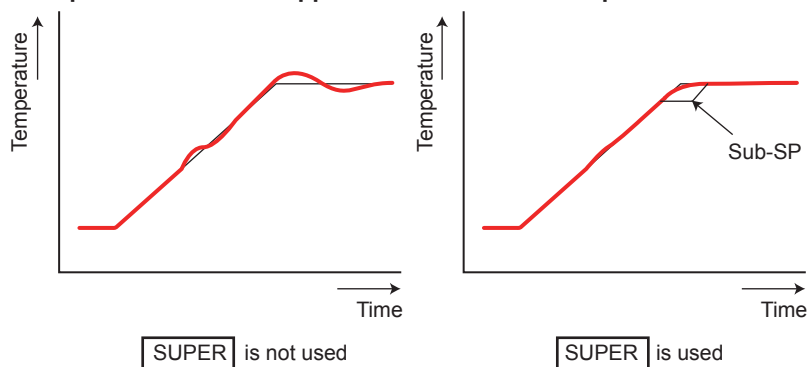

Setting Details

Parameter symbol	Name	Display level	Setting range	Menu symbol
SC	Super function	EASY	OFF: Disable 1: Overshoot suppressing function (normal mode) 2: Hunting suppressing function (stable mode) 3: Hunting suppressing function (response mode) 4: Overshoot suppressing function (strong suppressing mode)	TUNE Ope

The setting SC=4 is effective compared with SC=1. However, the hunting may occur until the PV reaches SP. Use it as usage.
 Do not use the Super function for the Sample PI control.

8.6 Suppressing Hunting (Super2 Function)

Description

The Super2 function suppresses the hunting effect of the controller without re-tuning the PID parameters.

Hunting means the PV becomes unstable and oscillates around SP.

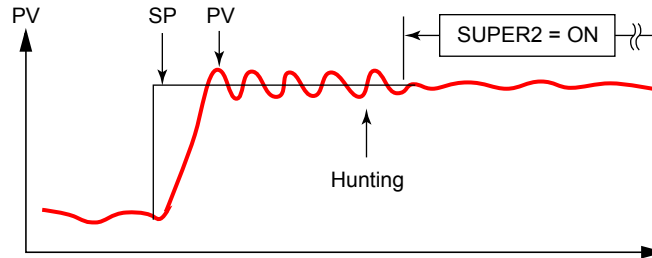

- In hunting condition, the Super2 function selects the output from process model as PV signal.
- The process model removes a factor of dead time from the actual process.
- The real process is under the open-loop condition.
- After hunting is suppressed, the Super2 function selects real PV signal, and carry out the standard feedback control.

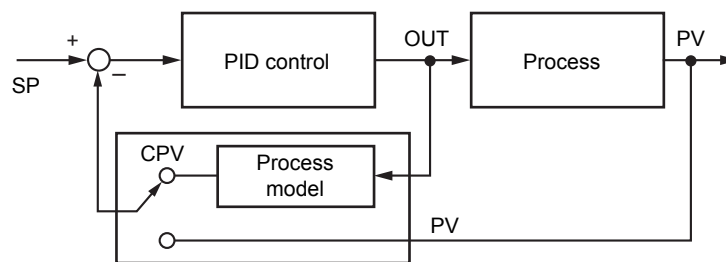

Effects of Super2

Load change

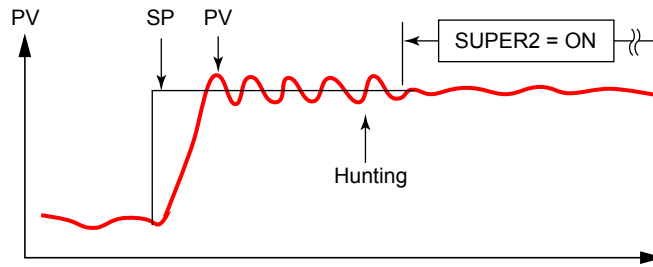

Temperature change

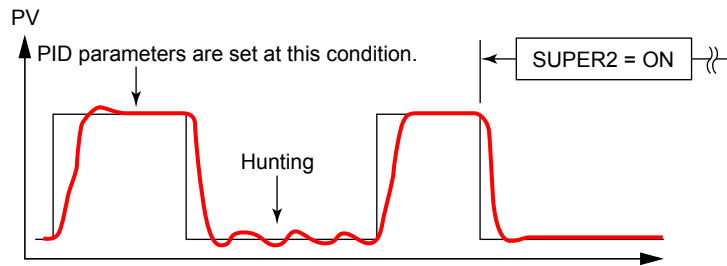

Setting Details

Parameter symbol	Name	Display level	Setting range	Menu symbol
SC	Super function	EASY	OFF: Disable 1: Overshoot suppressing function (normal mode) 2: Hunting suppressing function (stable mode) 3: Hunting suppressing function (response mode) 4: Overshoot suppressing function (strong suppressing mode).	TUNE Ope

Set SC=2 when there are a lot of disturbances, and much hunting occurs.
 Set SC=3 when SP is changed frequently. Hunting suppressing effect is smaller than that of SC=2, however, responsiveness is good.

The Super function does not work in direct action.

8.7 Suppressing Integral Action (Anti-reset Wind-up)

Description

Where there is a large deviation at the start of the control operation, for example, integral outputs are accumulated and the PV exceeds the SP, thereby causing the output to overshoot. To avoid this, the controller provides an anti-reset wind-up function for suppressing an extreme integral output by stopping PID computations. Same applies to the case of undershoot.

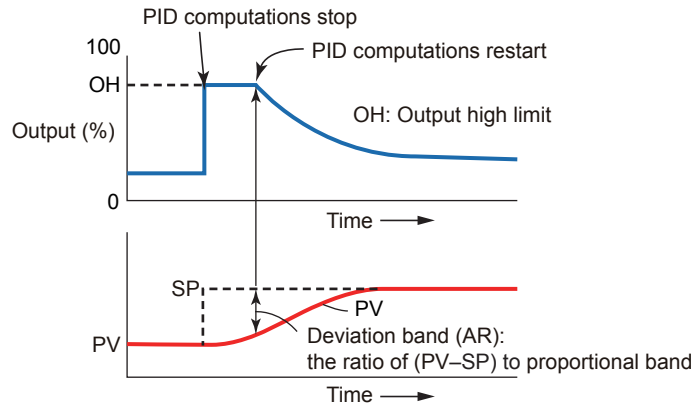

The parameter AR sets the point (by deviation band (%)) to restart the PID computation that is suspended by the controller's anti-reset windup function. PID computation restarts when the deviation band has decreased to the AR setpoint. When the parameter AR is set to AUTO, the controller automatically determines the point at which to restart the PID computation.

$$\text{Deviation band (= Setpoint of AR)} = \frac{|PV - SP|}{\text{Proportional band}} \times 100 (\%)$$

Setting Details

Parameter symbol	Name	Display level	Setting range	Menu symbol
AR	Anti-reset windup	STD	AUTO, 50.0 to 200.0%	TUNE Ope

8.8 Adjusting Auto-tuning Operation

Description

Auto-tuning Type

“Normal” of auto-tuning type requires a rapidly rising PID constant. This type is useful for processes that allow some overshooting.

On the other hand, “stable” of auto-tuning type requires a slowly rising PID constant.

Auto-tuning Output Limiter

When executing auto-tuning, the control output high and low limits can be set.

When the control output low limit > AT.OL, or AT.OH < control output high limit, auto-tuning is limited by the control output low or high limit.

In Heating/cooling control, AT.OH and AT.OL do not work.

Note

In time proportional output, the output is turned on and off irrespective of the upper/lower limit.

Setting Details

Parameter symbol	Name	Display level	Setting range	Menu symbol
AT.TY	Auto-tuning type	STD	0: Normal 1: Stability	TUNE 
AT.OH	Output high limit in auto-tuning	PRO	-5.0 to 105.0% (Disabled in Heating/cooling control)	
AT.OL	Output low limit in auto-tuning	PRO		

9.1 Setting SP Limiter

Description

The SP high and low limits can be set to restrict the SP to the range between those limits whether in REM (remote) or LCL (local) mode. They works to the SP of all SP groups.

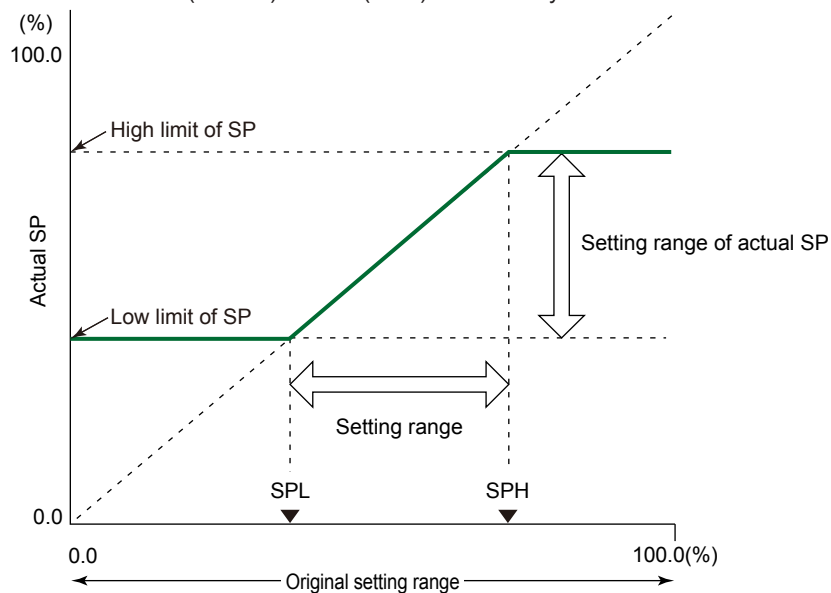

▶ SP group: 6.2 Setting Target Setpoint

Setting Details

Parameter symbol	Name	Display level	Setting range	Menu symbol
SPH	SP high limit	STD	0.0 to 100.0% of PV input range	MPV Set
SPL	SP low limit	STD	(EU), (SPL<SPH)	

9.2 Changing SP at a Fixed Rate (SP Ramp-Rate Setting Function)

Description

SP ramp-rate setting function forces SP to change at a fixed rate when SP is changed in order to prevent abrupt changes in SP.

Velocity (rate-of-change) can be set for both the SP ramp-up rate (UPR) and SP ramp-down rate (DNR). Set the ramp-rate time unit (TMU) per hour or minute.

The SP ramp-rate setting function works when:

- (1) SP is changed.
- (2) SP is changed by switching SP number (SPNO).
- (3) Power is turned on or has recovered from a failure (PV tracking=ON); or
- (4) Operation mode is switched from MAN to AUTO (PV tracking=ON).

SP ramp-rate setting action starts from PV when the PV tracking function is used.

(1) When SP is changed

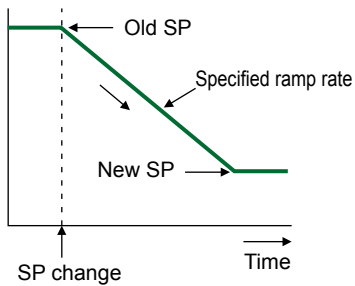

(2) When SP No. (SPNO) is switched

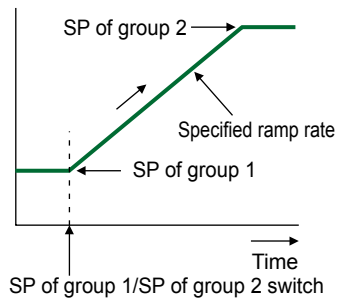

(3) When power is turned on (or power has recovered)
(4) When operation mode is switched from MAN to AUTO

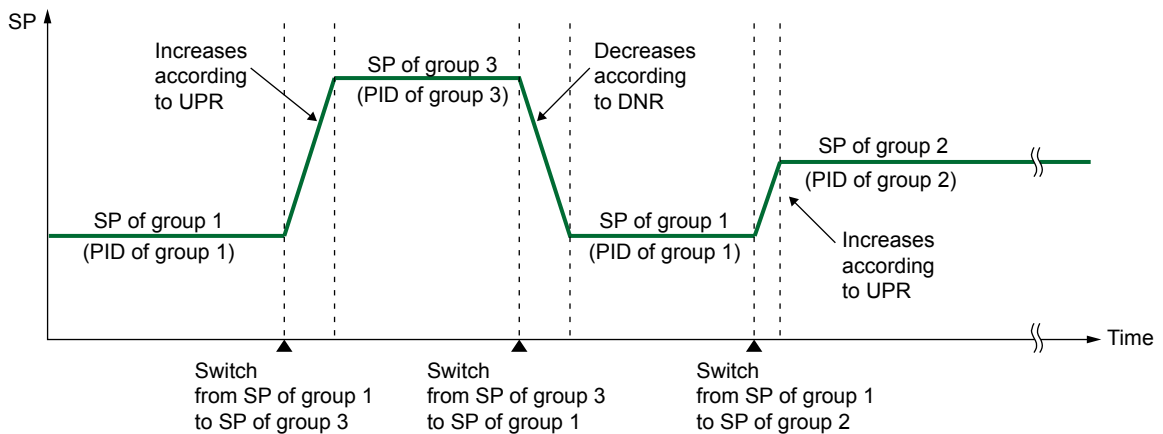
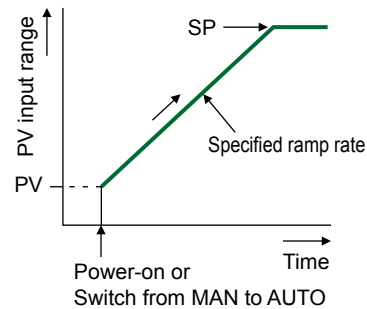

9.2 Changing SP at a Fixed Rate (SP Ramp-Rate Setting Function)

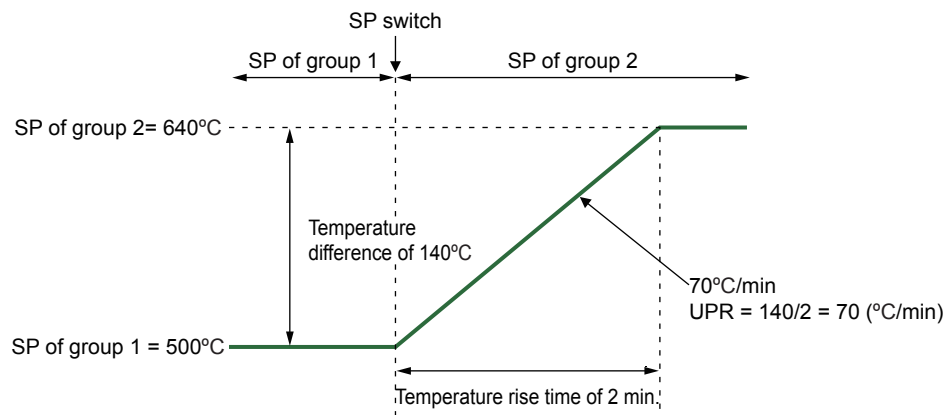

$$\text{UPR} = \frac{\text{Temperature difference (}^\circ\text{C)}}{\text{Time (min)}} = \frac{140^\circ\text{C}}{2 \text{ min}} = 70 \text{ (}^\circ\text{C/min)}$$

Setting Details

Parameter symbol	Name	Display level	Setting range	Menu symbol
UPR	SP ramp-up rate	EASY	OFF, 0.0 + 1 digit to 100.0% of PV input range span (EUS)	SPS Ope
DNR	SP ramp-down rate	EASY		
TMU	SP ramp-rate time unit	EASY	HOUR: Ramp-up rate or ramp-down rate per hour MIN: Ramp-up rate or ramp-down rate per minute	

9.3 Forcing SP to Track PV (PV Tracking)

Description

PV tracking function is used to prevent abrupt PV changes. With PV tracking, SP is first aligned with PV and then changed to its original SP at the SP ramp rate.

► [SP ramp-rate setting function: 9.2 Changing SP at a Fixed Rate \(SP Ramp-Rate Setting Function\)](#)

PV tracking function works when:

- (1) Power is turned on or has recovered from a failure,
- (2) SP number (SPNO) is changed,
- (3) Operation mode is switched from STOP to RUN,
- (4) Operation mode is switched from MAN to AUTO

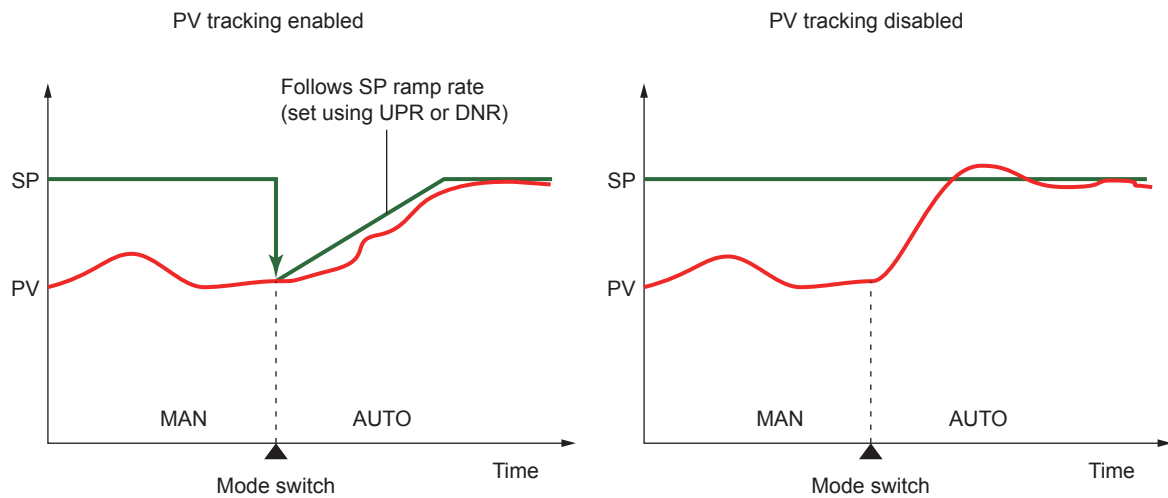

Setting Details

Parameter symbol	Name	Display level	Setting range	Menu symbol
PVT	PV tracking selection	STD	OFF, ON	SPS

9.4 Forcing SP to Track Remote Input (SP Tracking)

Description

SP tracking function is the function to force the local setpoint (SP) to track the remote setpoint (RSP) when the operation mode is switched from REM (remote) to LCL (local) mode.

The function is effective to prevent abrupt PV changes.

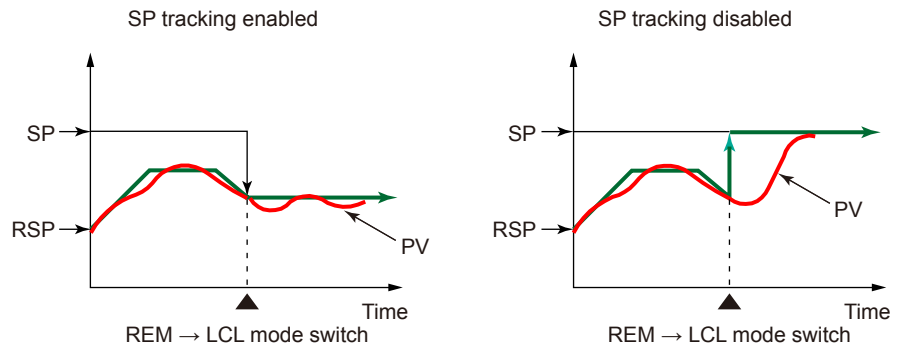

Setting Details

Parameter symbol	Name	Display level	Setting range	Menu symbol
SPT	SP tracking selection	STD	OFF, ON	SPS Ope

Displayed only in cases where the communication is specified.

9.5 Setting Controller Action at Power ON (Restart Mode)

Description

For details, see Chapter 15, “Power Failure Recovery Processing.”

Setting Details

Parameter symbol	Name	Display level	Setting range	Menu symbol
R.MD	Restart Mode	STD	Set how the controller should recover from a power failure of 5 seconds or more. CONT: Continue action set before power failure. MAN: Start from MAN. AUTO: Start from AUTO.	SYS Set

The preset output (PO) is output in MAN or AUTO mode.

9.6 Setting Time between Powering on Controller and Starting Control (Restart Timer)

Description

The time between power on and the instant where controller starts control computation can be set.

Operation start time = Operating time of controller initialization after power on.

Setting Details

Parameter symbol	Name	Display level	Setting range	Menu symbol
R.TM	Restart Timer	STD	0 to 10 s	SYS Set

10.1 Setting Control Output Type

Description

Time Proportional Relay Output/ Time Proportional Voltage Pulse Output

In time proportional output, the control computation result is output in the form of an on/off signal pulse width proportional to the time. The pulse width is calculated as follows with the cycle time (control output cycle) at 100%.

$$\text{Control output pulse width} = \text{Control output (\%)} \times \text{Cycle time}$$

The output type is selected as either the relay output or the voltage pulse output.

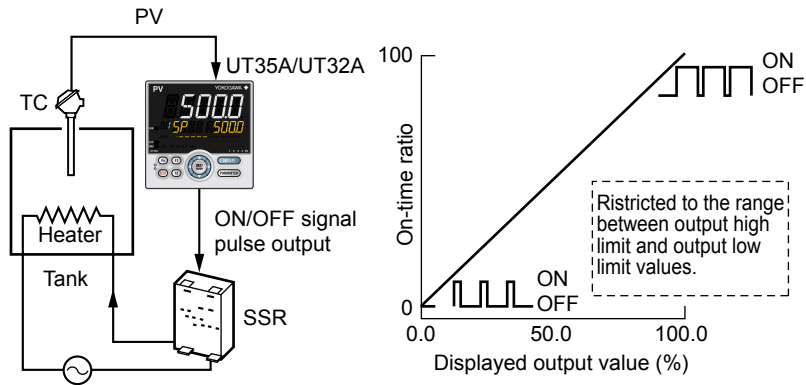

▶ Cycle time: 10.2 Setting Control Output Cycle Time

Current Output

In current output, the control computation result is output as a current signal. (Example of 4 to 20 mA)

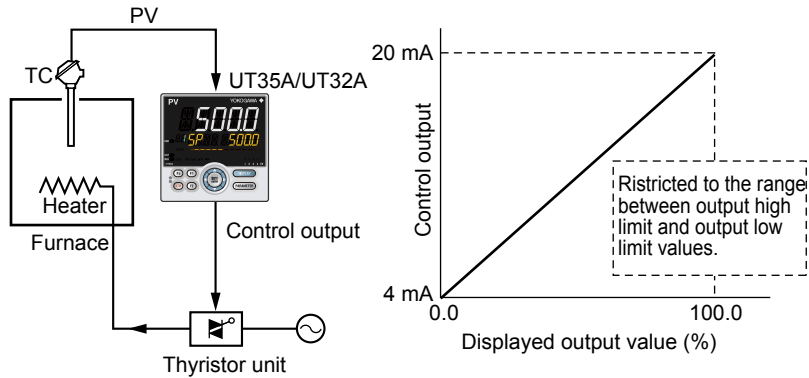

ON/OFF Output

ON/OFF control compares the SP and PV and outputs an on or off signal according to the positive or negative deviation (PV – SP).

Position Proportional Output

Position proportional output is equipped only with Position proportional type (Suffix code: Type 1 = -1).

In position proportional output, valve opening is made proportional to the control computation results. The controller outputs direct and reverse signals (relay) to control motor movement and valve opening.

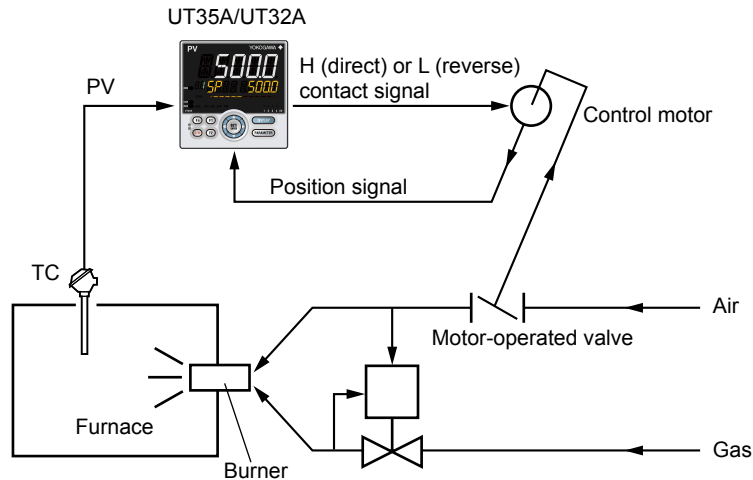

Feedback-type Position Proportional Output

In feedback-type position proportional output, the controller obtains a valve position signal from a feedback slide-wire resistor (overall resistance: 100 Ω to 2.5 kΩ) attached to a valve or feedback current input (4 to 20 mA).

The following shows an example using feedback slide-wire resistor.

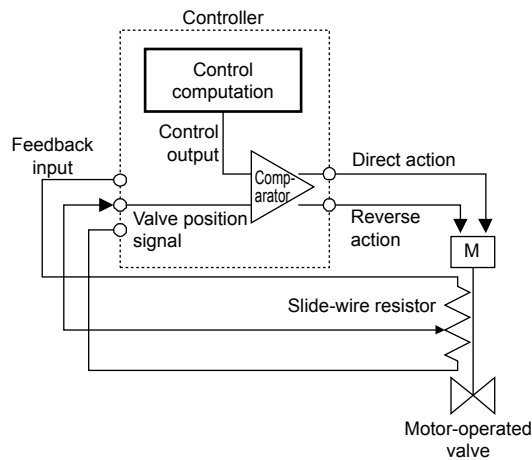

When current is used for feedback input, only wiring is different

- ▶ [Wiring for current: 17.4.4 Valve Position Output and Feedback Input Wiring](#)

Estimating-type Position Proportional Output

In estimating-type position proportional output, set the operating time required for a valve to change from the fully-closed position to the fully-open position beforehand. With the preset operating time, the controller controls the valve by estimating its position. Estimating-type position proportional output is used when feedback input signal cannot be obtained. (Feedback input wiring is not necessary.)

Note: When the control output is: upper limit=direct signal, lower limit=reverse signal.

Heating/cooling Output

Heating/cooling output is equipped only with Heating/cooling type (Suffix code: Type 1 = -2).

- ▶ [Heating/cooling output: 8.2.3 Heating/cooling Control](#)

Two-position Two-level Control Output

Two-position Two-level Control is equipped only with Heating/cooling type (Suffix code: Type 1 = -2).

- ▶ Two-position two-level control output: 8.1.1 Single-loop Control, Heating/cooling Control, Position Proportional Control, and Two-position Two-level Control
- ▶ Two-position two-level control: 8.2.4 Two-position Two-level Control

Setting Details

Parameter symbol	Name	Display level	Setting range	Menu symbol
OT	Output type selection	EASY	Control output or Heating-side control output (Lower two digits) 00: OFF 01: OUT terminals (voltage pulse) 02: OUT terminals (current) 03: OUT terminals (relay) 06: OUT2 terminals (relay) 07: RET/OUT2 terminals (voltage pulse) 08: RET/OUT2 terminals (current) Cooling-side control output (Upper two digits) 00: OFF 01: OUT terminals (voltage pulse) 02: OUT terminals (current) 03: OUT terminals (relay) 06: OUT2 terminals (relay) 07: RET/OUT2 terminals (voltage pulse) 08: RET/OUT2 terminals (current)	OUT Set

CAUTION

No output is generated even if the terminal which is not provided is selected. Confirm that the terminal to be selected is provided.

For each output terminal number, see 17.4, "Wiring."

Set a control type, and an input type before setting an output type.

- ▶ Control type: 8.2 Setting Control Type (CNT)
- ▶ Input type: 7.1.1 Setting Input Type, Unit, Range, Scale, and Decimal Point Position

Control Output (PID Control, ON/OFF Control) of Standard type

The figure below shows an example of setting the current output of the OUT terminal to the control output terminal and type. Set "02" to lower two digits and "00" to upper two digits.

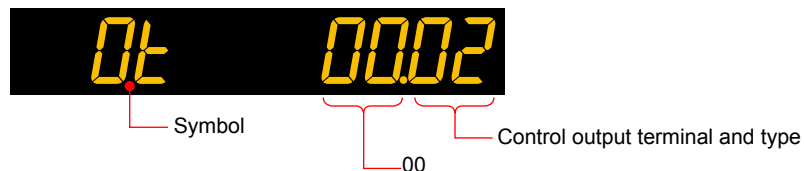

10.1 Setting Control Output Type

Heating/cooling Control Output of Heating/cooling Type

The figure below shows an example of setting the current output of the OUT terminal to the heating-side control output terminal and type, and setting the relay output of the OUT2 terminal to the cooling-side control output terminal and type.

Heating side: Set "02" to lower two digits. Cooling side: Set "06" to upper two digits.

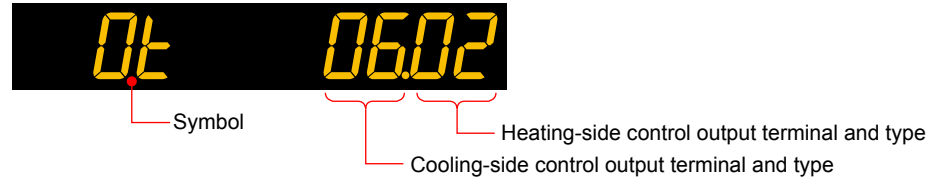

Two-position Two-level Control Output (for Heating/cooling Type Only)

The figure below shows an example of setting the relay output of the OUT terminal to the control output terminal and type of main setting, and setting the relay output of the OUT2 terminal to the control output terminal and type of sub-setting.

Main setting side: Set "03" to lower two digits. Sub-setting side: Set "06" to upper two digits.

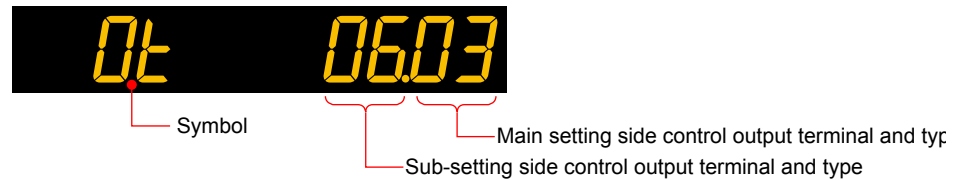

Position Proportional Output (for Position Proportional Type Only)

When Position proportional type is specified, the output form is fixed to the position proportional output and setting is not necessary. Adjustment of the valve position is necessary.

- ▶ Valve position adjustment: [10.14 Adjusting Motor-operated Valve Position \(Position Proportional Output\)](#)

10.2 Setting Control Output Cycle Time

Description

Cycle time is the basic cycle period for a signal full cycle of ON/OFF operation for a relay or voltage pulse output. Reducing cycle time results in faster cycling and finer control. In contrast, reducing the ON/OFF period also reduces relay life. For relay output, set the control output cycle time to 30 to 200 seconds according to the process speed.

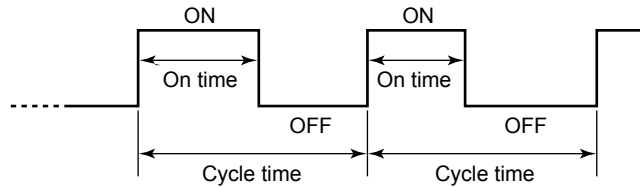

Comparison of operations for the same control output (50%)

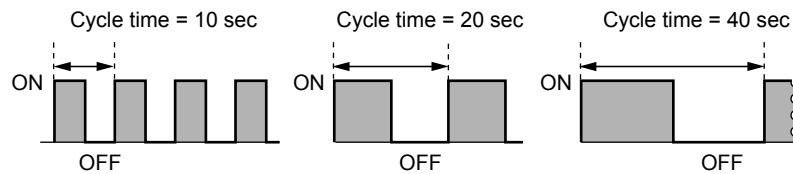

Setting Details

Parameter symbol	Name	Display level	Setting range	Menu symbol
CT	Control output cycle time Heating-side control output cycle time (in Heating/cooling control)	EASY	0.5 to 1000.0 s	OUT Set
CTc	Cooling-side control output cycle time	EASY		

10.3 Setting Limiter to Control Output

Description

Control output high and low limits can be set to restrict the control output to the operation range between those limits.

The output limiter is prepared for each PID group, and works according to the selected PID group.

This, however, excludes preset output in STOP mode.

► [PID group: 6.4 Adjusting PID Manually](#)

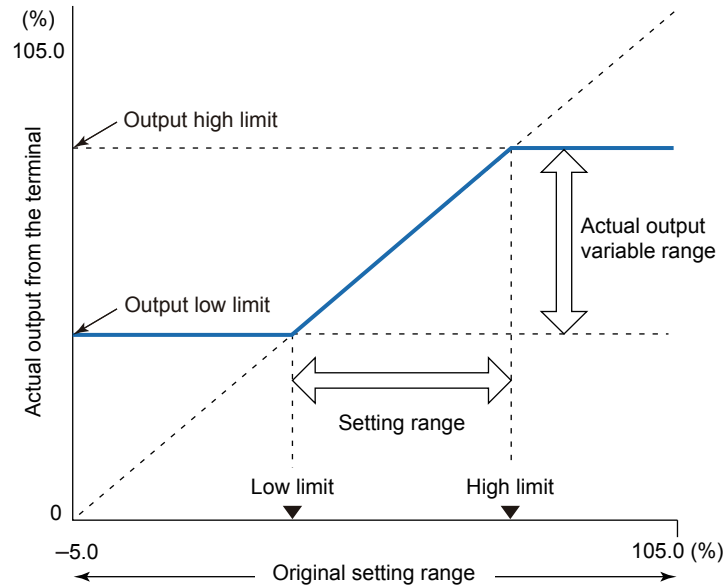

Setting Details

Parameter symbol	Name	Display level	Setting range	Menu symbol
OH	Control output high limit Heating-side control output high limit (in Heating/cooling control)	EASY	-4.9 to 105.0%, (OL<OH) In Heating/cooling control: 0.1 to 105.0% (OL<OH)	PID Ope
OL	Control output low limit Heating-side control output low limit (in Heating/cooling control)	EASY	-5.0 to 104.9%, (OL<OH), SD: Tight shut In Heating/cooling control: 0.0 to 104.9% (OL<OH)	
OHc	Cooling-side control output high limit	EASY	0.1 to 105.0%, (OLc<OHc)	
OLc	Cooling-side control output low limit	EASY	0.0 to 104.9%, (OLc<OHc)	
PIDN	PID number selection	EASY	1 to 4	SP Ope
PIDG.	Number of PID groups	STD	1 to 4	CTL Set

Note1: The PID number (1 to 4, R) is displayed on Group display while each parameter is displayed.

Note2: When the setting is low limit \geq high limit, the controller operates as low limit = high limit -1 digit.

Note

When changing the setpoint of the parameter PIDG., if the setpoint of the parameter PIDN which belongs to the SP menu is larger than that of the parameter PIDG., the PIDN setpoint is changed to the PIDG. setpoint.

10.4 Disabling Output Limiter in MAN mode

Description

Output limiter can be released when in MAN mode.

However, cannot be released when in Heating/cooling control.

Note that the output bump is caused if the operation mode is changed from AUTO to MAN or STOP to RUN while the control output is out of the range between the control output high limit (OH) and control output low limit (OL).

Control output bumps to OH in MAN mode when it is larger than OH.

Moreover, it bumps to OL when smaller than OL.

Setting Details

Parameter symbol	Name	Display level	Setting range	Menu symbol
OLMT	Output limiter switch	PRO	OFF: Disable output limiter in MAN mode ON: Enable output limiter in MAN mode	TUNE Ope

10.5 Setting Velocity Limiter to Control Output

Description

Output velocity limiter prevents the control output signal from changing suddenly in order to protect the control valves (or other actuators) and controlled process. The output velocity limiter does not work in MAN or STOP mode or when input burnout or A/D error occurs. Note that setting an output velocity limit may cancel the effects of derivative action. The following shows the operation example of output velocity limiter.

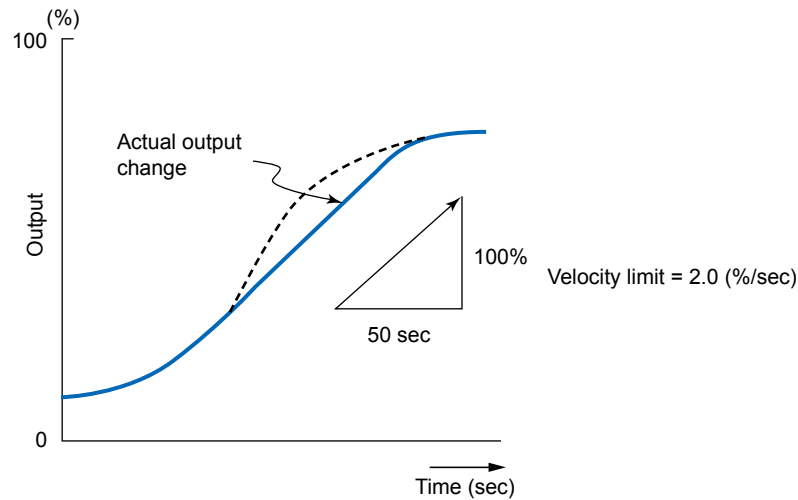

In Heating/cooling control, the output velocity limiter can be set to the control computation result before split into heating-and cooling-side outputs. In ON/OFF control or Two-position two-level control, the setting is invalid even if the output velocity limiter is set.

Setting Details

Parameter symbol	Name	Display level	Setting range	Menu symbol
OPR	Output velocity limiter	STD	OFF: Disable 0.1 to 100.0%/s	TUNE Ope

10.6 Reducing 4-20 mA Current Output to 0 mA (Tight Shut Function)

Description

Tight shut function fully closes the control valve (or other actuators) (i.e., so that output is zero) beyond its positioner dead band.

When the output low limit is set to "SD," the output is as follows in MAN or AUTO mode.

- **In MAN mode**

When the output is reduced with the Down arrow key and "SD" is displayed as the output value, the output level reaches tight shut level. The control output delivers a tight shut signal (about 0.0 mA).

- **In AUTO mode**

The output is limited by the output low limit (OL). It does not decrease to 0.0 mA.

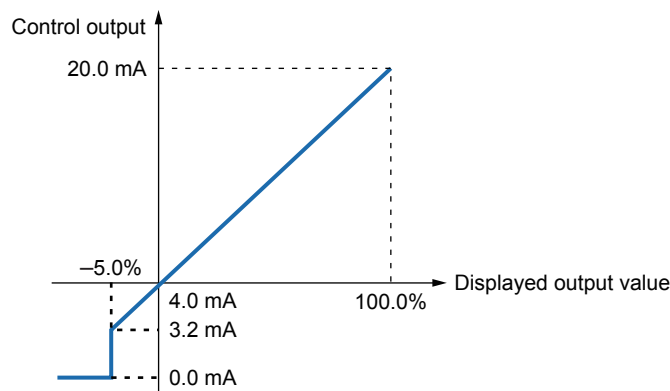

Setting Details

Parameter symbol	Name	Display level	Setting range	Menu symbol
OL	Control output low limit Heating-side control output low limit (in Heating/cooling control)	EASY	-5.0 to 104.9%, (OL<OH), SD: Tight shut (0 mA output in MAN mode) In Heating/cooling control: 0.0 to 104.9% (OL<OH)	PID Ope
PIDN	PID number selection	EASY	1 to 4	SP Ope
PIDG.	Number of PID groups	STD	1 to 4	CTL Set

Note1: The PID number (1 to 4, R) is displayed on Group display while each parameter is displayed.

Note

When changing the setpoint of the parameter PIDG., if the setpoint of the parameter PIDN which belongs to the SP menu is larger than that of the parameter PIDG., the PIDN setpoint is changed to the PIDG. setpoint.

10.7 Setting ON/OFF Control Hysteresis

Description

In ON/OFF control, since the only two possible output states are ON and OFF, the control output cycles are as shown in the figure below. ON/OFF becomes quite narrow, so that if relay output is used, chattering occurs. In this case, the hysteresis should be set wider to prevent relay chattering and for the service life of the relay.

One Point of Hysteresis

For one point of hysteresis, set one point of hysteresis. In Heating/cooling control, set heating-side ON/OFF control hysteresis and cooling-side ON/OFF control hysteresis.

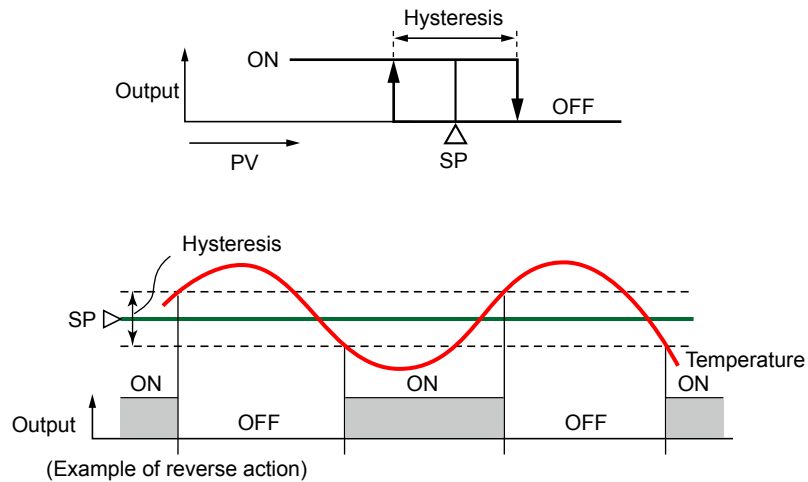

Two Points of Hysteresis

For two points of hysteresis, set two points of hysteresis (upper-side hysteresis and lower-side hysteresis).

Two points of hysteresis cannot be used for Heating/cooling control and Two-position two-level control.

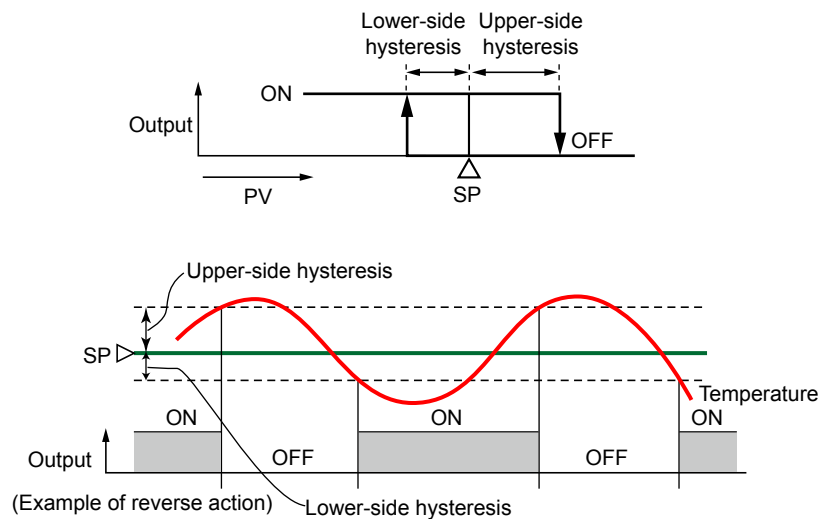

Setting Details

Parameter symbol	Name	Display level	Setting range	Menu symbol
HYS	Hysteresis (in ON/OFF control, Position proportional control, or Two-position two-level control) Heating-side ON/OFF control hysteresis (in Heating/cooling control)	EASY	In ON/OFF control or Two-position two-level control: 0.0 to 100.0% of PV input range span (EUS) In Heating/cooling control or Position proportional control: 0.0 to 100.0%	PID Ope
HY.UP	Upper-side hysteresis (in ON/OFF control)	EASY	0.0 to 100.0% of PV input range span (EUS)	
HY.LO	Lower-side hysteresis (in ON/OFF control)	EASY		
PIDN	PID number selection	EASY	1 to 4	SP Ope
PIDG.	Number of PID groups	STD	1 to 4	CTL Set

Note1: The PID number (1 to 4, R) is displayed on Group display while each parameter is displayed.

Note

When changing the setpoint of the parameter PIDG., if the setpoint of the parameter PIDN which belongs to the SP menu is larger than that of the parameter PIDG., the PIDN setpoint is changed to the PIDG. setpoint.

10.8 Canceling Offset of PV and SP (Manual Reset)

Description

Manual reset can be used when the integral action is disabled.
When the integral action is disabled, there will be an offset of PV and SP. Manual reset cancels this offset.
The manual reset value equals the output value when PV = SP is true.

Setting Details

Parameter symbol	Name	Display level	Setting range	Menu symbol
MR	Manual reset	EASY	-5.0 to 105.0%	PID Ope
PIDN	PID number selection	EASY	1 to 4	SP Ope
PIDG.	Number of PID groups	STD	1 to 4	CTL Set

Note1: The PID number (1 to 4, or R) is displayed on Group display while each parameter is displayed.

Note

When changing the setpoint of the parameter PIDG., if the setpoint of the parameter PIDN which belongs to the SP menu is larger than that of the parameter PIDG., the PIDN setpoint is changed to the PIDG. setpoint.

10.9 Setting Hysteresis and Dead Band for Heating/cooling Control Output

Description

In Heating/cooling control, the positive dead band denotes the zone where none of the heating-side and cooling-side outputs are presented. The negative dead band denotes the zone where both of the heating-side and cooling-side outputs are presented.

The following shows the case when both the heating side and cooling side are ON/OFF control.

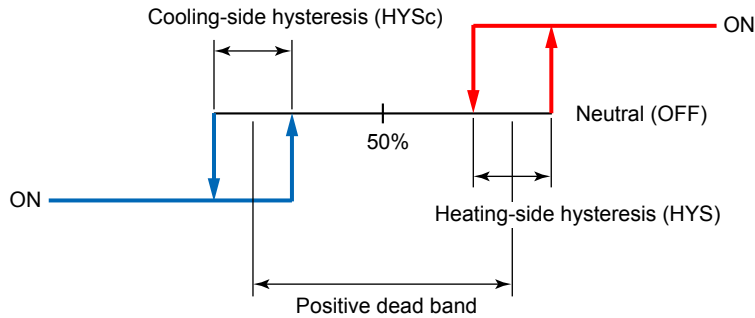

The following shows the case when both the heating side and cooling side are PID control.

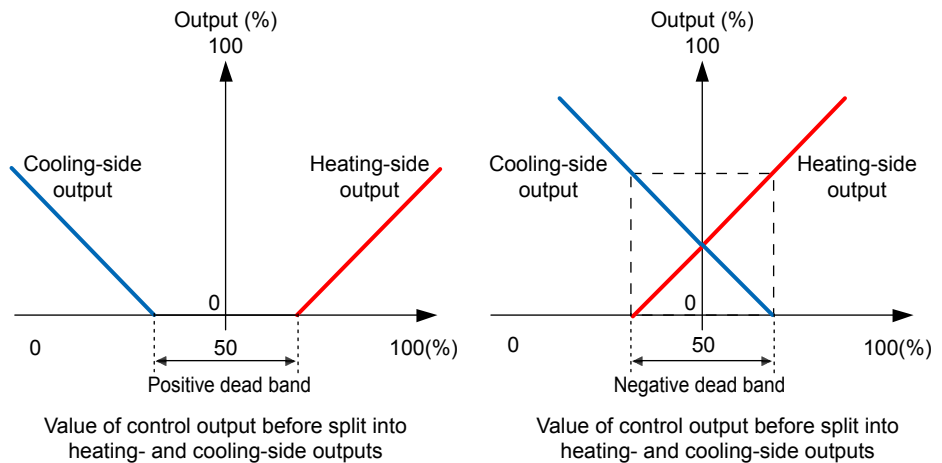

10.9 Setting Hysteresis and Dead Band for Heating/cooling Control Output

Setting Details

Parameter symbol	Name	Display level	Setting range	Menu symbol
HYS	Hysteresis (in ON/OFF control, Position proportional control, or Two-position two-level control) Heating-side ON/OFF control hysteresis (in Heating/cooling control)	EASY	In ON/OFF control or Two-position two-level control: 0.0 to 100.0% of PV input range span (EUS) In Heating/cooling control or Position proportional control: 0.0 to 100.0%	PID Ope
HYS_c	Cooling-side ON/OFF control hysteresis	EASY	0.0 to 100.0%	
DB	Output dead band (in Heating/cooling control or Position proportional control)	EASY	In Heating/cooling control: -100.0 to 50.0% In Position proportional control: 1.0 to 10.0%	
PIDN	PID number selection	EASY	1 to 4	SP Ope
PIDG.	Number of PID groups	STD	1 to 4	CTL Set

Note1: The PID number (1 to 4, or R) is displayed on Group display while each parameter is displayed.

Note

When changing the setpoint of the parameter PIDG., if the setpoint of the parameter PIDN which belongs to the SP menu is larger than that of the parameter PIDG., the PIDN setpoint is changed to the PIDG. setpoint.

10.10 Setting Hysteresis and Dead Band for Position Proportional Control Output

Description

To prevent excessively frequent operation of the motor and relays, a dead band is provided between two relay output operating points, and hysteresis is provided for each relay output.

If position signal differs from the control computation output by less than the dead band value, neither the “direct” nor “reverse” relay turns ON. If the difference is large enough on the plus side, the direct relay turns ON; if on the minus side, the reverse relay turns ON (in reverse action).

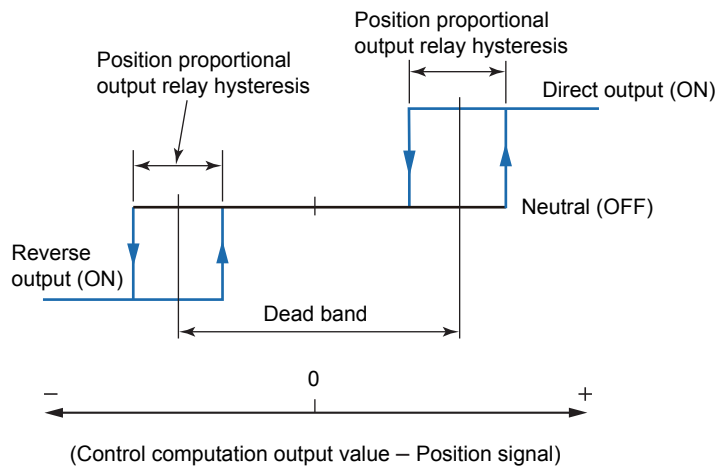

Setting Details

Parameter symbol	Name	Display level	Setting range	Menu symbol
HYS	Hysteresis (in ON/OFF control, Position proportional control, or Two-position two-level control) Heating-side ON/OFF control hysteresis (in Heating/cooling control)	EASY	In ON/OFF control or Two-position two-level control: 0.0 to 100.0% of PV input range span (EUS) In Heating/cooling control or Position proportional control: 0.0 to 100.0%	PID Ope
DB	Output dead band (in Heating/cooling control or Position proportional control)	EASY	In Heating/cooling control: -100.0 to 50.0% In Position proportional control: 1.0 to 10.0%	
PIDN	PID number selection	EASY	1 to 4	SP Ope
PIDG.	Number of PID groups	STD	1 to 4	CTL Set

Note1: The PID number (1 to 4, R) is displayed on Group display while each parameter is displayed.

Note

When changing the setpoint of the parameter PIDG., if the setpoint of the parameter PIDN which belongs to the SP menu is larger than that of the parameter PIDG., the PIDN setpoint is changed to the PIDG. setpoint.

10.11 Setting Retransmission Output Terminal, Type, and Scales

Description

The retransmission output can be used when the control output is not assigned to the analog output terminal. Confirm the output type selection (OT) before setting the retransmission output. The range can be changed.

- ▶ Control output terminal: 10.1 Setting Control Output Type
- ▶ Current output range: 10.14 Changing Current Output Range

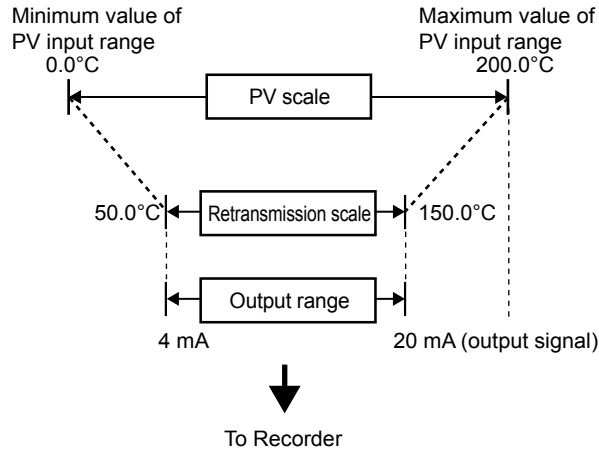

Setting Details

Parameter symbol	Name	Display level	Setting range	Menu symbol
RTS	Retransmission out type of RET	EASY	OFF: Disable PV1: PV SP1: SP OUT1: OUT (Valve opening: 0 to 100 % in Position proportional control) LPS: 15 V DC loop power supply TSP1: Target SP HOUT1: Heating-side OUT COUT1: Cooling-side OUT MV1: Position proportional output (internal computed value) PV: PV terminals analog input	OUT Set

10.11 Setting Retransmission Output Terminal, Type, and Scales

(Continued)

Parameter symbol	Name	Display level	Setting range	Menu symbol
RTH	Maximum value of retransmission output scale of RET	STD	When RTS = PV1, SP1, TSP1, PV RTL + 1 digit to 30000 -19999 to RTH - 1 digit	OUT Set
RTL	Minimum value of retransmission output scale of RET	STD	Decimal point position: When RTS=PV1, SP1, or TSP1, decimal point position is same as that of PV input. When RTS=PV, decimal point position is same as that of PV input scale.	
O1RS	Retransmission output type of OUT current output	STD	Same as RTS	
O1RH	Maximum value of retransmission output scale of OUT current output	STD	When O1RS = PV1, SP1, TSP1, PV O1RL + 1 digit to 30000 -19999 to O1RH - 1 digit	
O1RL	Minimum value of retransmission output scale of OUT current output	STD	Decimal point position: When O1RS=PV1, SP1, or TSP1, decimal point position is same as that of PV input. When O1RS =PV, decimal point position is same as that of PV input scale.	

Setpoints HOUT1 and COUT1: Can be used in Heating/cooling control.

Setpoint MV1: Can be used in Position proportional control.

(When opening or closing a valve by key operation in manual mode operation, the transmission output becomes -5.0 %.)

Parameters and Corresponding Terminals

RTS, RTH, RTL	RET/OUT2 terminal
O1RS, O1RH, O1RL	OUT terminal

10.12 Setting Preset Output Value

10.12.1 Setting Output Value in STOP Mode (Preset Output)

Description

Preset output becomes the output when the operation mode is switched from RUN to STOP.

The preset output is not limited by the output high and low limits.

The preset output is prepared for each PID parameter group, and works according to the selected PID parameter group.

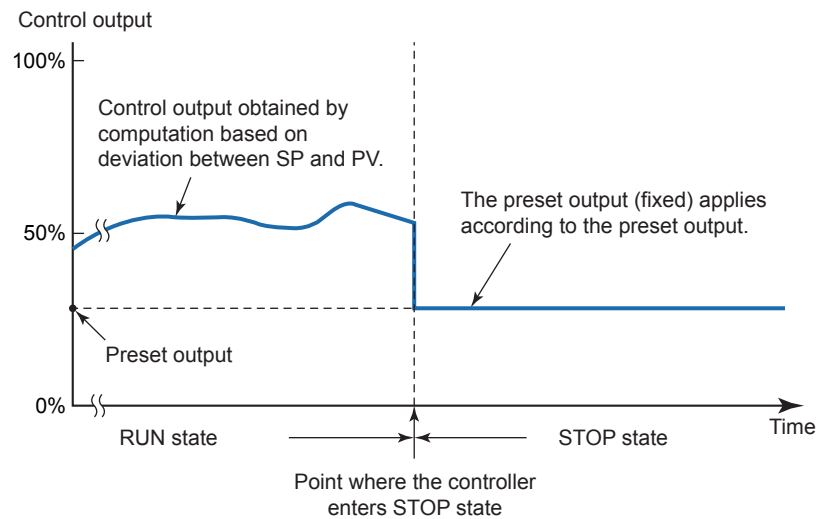

► [Output limiter: 10.3 Setting Limiter to Control Output](#)

Preset Output in Heating/cooling Control

The preset output can be set for both of the heating and cooling sides.

The computation starts from the value of 50% of internal computed value (value before split into heating- and cooling-side outputs) when the operation mode is switched from STOP to RUN.

Setting Details

Parameter symbol	Name	Display level	Setting range	Menu symbol
PO	Preset output Heating-side preset output (in Heating/cooling control)	EASY	In STOP mode, fixed control output can be generated. In Position proportional control, Valve opening can be set; -5.0 to 105.0%	PID Ope
POc	Cooling-side preset output	EASY		
SU.PO	Sub-preset output (in Two-position two-level control)	EASY	In STOP mode, fixed sub-control output can be generated. 0%, 100%	
PIDN	PID number selection	EASY	1 to 4	SP Ope
PIDG.	Number of PID groups	STD	1 to 4	CTL Set

Note1: The PID number (1 to 4, R) is displayed on Group display while each parameter is displayed.

Note

When changing the setpoint of the parameter PIDG., if the setpoint of the parameter PIDN which belongs to the SP menu is larger than that of the parameter PIDG., the PIDN setpoint is changed to the PIDG. setpoint.

For ON/OFF output (ON/OFF output or ON/OFF output in Two-position two-level control or Heating/cooling control), 0.0% is output when the setting value is 0.0% or less and 100.0% is output when 0.1% or more.

10.12.2 Setting Output Value When Switched to MAN Mode (Manual Preset Output)

Description

When the operation mode is switched from AUTO to MAN, each of the following can be selected.

- The control output takes over the control output as is.
- The control output bumps to the manual preset output.

When the manual preset output is output, the manual operation is possible after the bump.

Manual preset output is limited by the output high and low limits. (when Output limiter switch (OLMT) = ON)

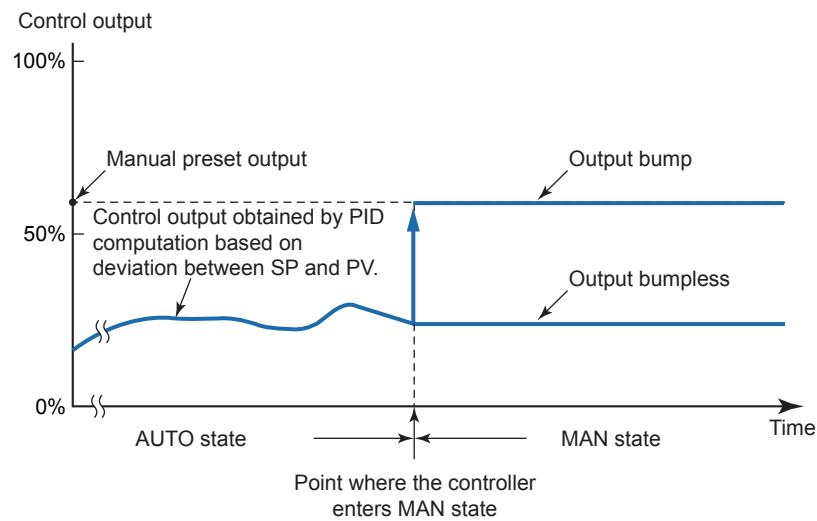

When the operation mode is switched from MAN to AUTO, transferred without bump from the manual output to the control output.

- ▶ [Output limiter: 10.3 Setting Limiter to Control Output](#)
- ▶ [Output limiter switch: 10.4 Disabling Output Limiter in MAN mode](#)

Setting Details

Parameter symbol	Name	Display level	Setting range	Menu symbol
MPON	Manual preset output number selection	STD	OFF: Hold the control output in AUTO mode (bumpless) 1: Use manual preset output 1 (output bump) 2: Use manual preset output 2 (output bump) 3: Use manual preset output 3 (output bump) 4: Use manual preset output 4 (output bump) 5: Use manual preset output 5 (output bump)	TUNE Ope
MPO1 to MPO5	Manual preset output 1 to 5	STD	-5.0 to 105.0%	

10.12.3 Setting Output Value When Error Occurs (Input Error Preset Output)

Description

The 0% control output, 100% control output, or input preset output can be selected and output as input error preset output in the following conditions.

- The input burnout occurs during operation in AUTO mode and RUN mode.
- The ADC error occurs during operation in AUTO mode and RUN mode.

However, the manual output becomes the output when the input burnout occurs in MAN mode and RUN mode.

Setting Details

Parameter symbol	Name	Display level	Setting range	Menu symbol
EPO	Input error preset output	STD	0: Preset output 1: 0% output 2: 100% output	SYS Set

10.13 Changing Current Output Range

Description

The analog output type can be selected from among 4 to 20, 0 to 20, 20 to 4, or 20 to 0 mA.

Setting Details

Parameter symbol	Name	Display level	Setting range	Menu symbol
OU.A	OUT current output range	STD	4-20: 4 to 20 mA, 0-20: 0 to 20 mA,	OUT Set
RET.A	RET current output range	STD	20-4: 20 to 4 mA, 20-0: 20 to 0 mA	

Parameters and Corresponding Terminals

OU.A	OUT terminal
RET.A	RET/OUT2 terminal

10.14 Adjusting Motor-operated Valve Position (Position Proportional Output)

When performing control using the motor-operated valve position, adjustment of the valve position is necessary.

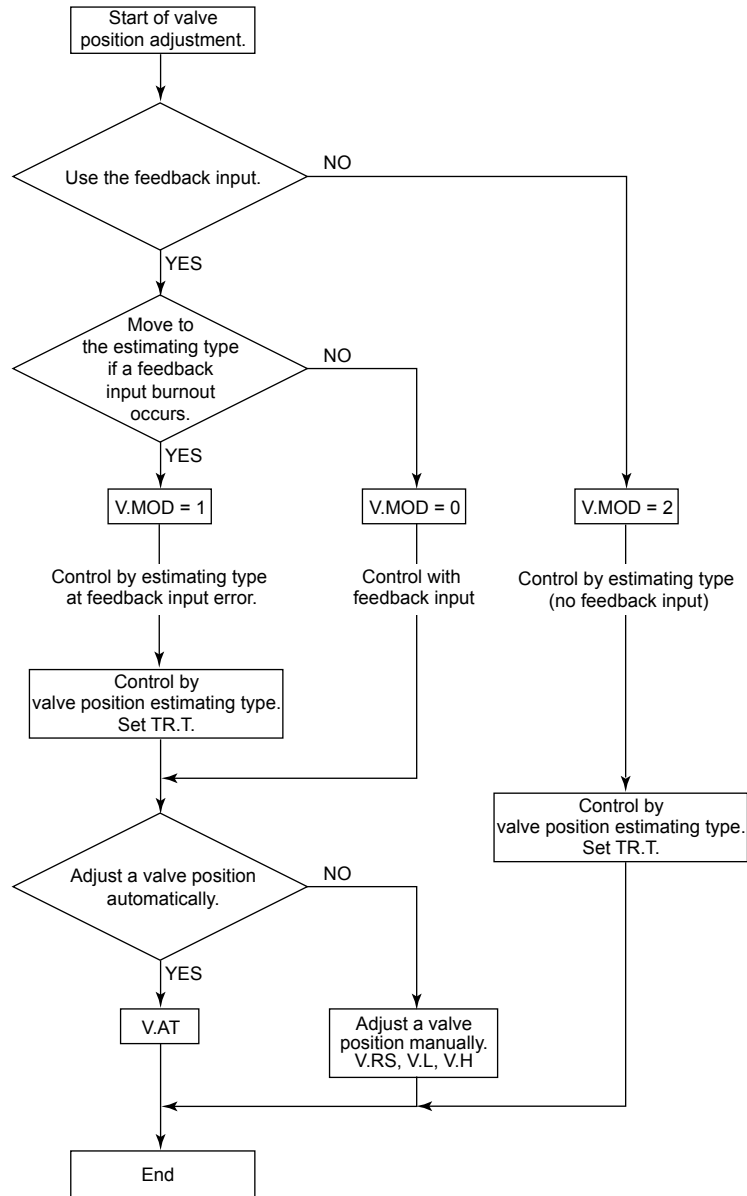

When controlling by estimating type, set TR.T corresponding to the valve characteristic.

10.14.1 Setting Valve Operation Mode

Description

Position proportional control monitors the control output signals and the feedback signals from the control valve and regulates to keep the valve opening and the control output signal in agreement.
 Position proportional control (output) operation mode has feedback type and estimating type.

Setting Details

Parameter symbol	Name	Display level	Setting range	Menu symbol
V.MOD	Valve adjusting mode	STD	0: Valve position feedback type 1: Valve position feedback type (moves to the estimating type if a feedback input error or break occurs.) 2: Valve position estimating type	OUT Set

10.14.2 Adjusting Valve Position Automatically

Description

The fully-closed and fully-opened positions of a valve can be set automatically by the feedback input signal from a valve.
 The following describes the procedure of adjusting the valve position automatically.

- (1) Verify that the wirings are correct.
- (2) Set the operation mode to MAN.
- (3) Set the automatic valve position adjustment (V.AT) to ON. (V.AT blinks during the automatic adjustment.)
- (4) When the adjustment is completed, V.AT returns to OFF.
 When the adjustment fails, VAT.E appears on PV display.

Setting Details

Parameter symbol	Name	Display level	Setting range	Menu symbol
V.AT	Automatic valve position adjustment	EASY	OFF: Stop automatic adjustment ON: Start automatic adjustment	OUT Set

10.14.3 Adjusting Valve Position Manually

Description

The following procedure describes how to adjust valve position manually.

- (1) Verify that the wirings are correct.
- (2) Set the operation mode to MAN.
- (3) Reset the valve position (Set V.RS=ON).
- (4) Display the fully-closed valve position setting (V.L), determine the fully-closed position while holding down the Down arrow (▾) key, and press the SET/ENTER key.
- (5) Display the fully-opened valve position setting (V.H), determine the fully-opened position while holding down the Up arrow (△) key, and press the SET/ENTER key.

Setting Details

Parameter symbol	Name	Display level	Setting range	Menu symbol
V.RS	Valve position setting reset	EASY	Setting V.RS to ON resets the valve adjustment settings and causes the indication "V.RS" to blink.	OUT Set
V.L	Fully-closed valve position setting	EASY	Pressing the SET/ENTER key with valve position set to the fully-closed position by Down arrow key causes the adjusted value to be stored. When V.L adjustment is complete, V.L stops blinking.	
V.H	Fully-opened valve position setting	EASY	Pressing the SET/ENTER key with valve position set to the fully-opened position by Up arrow key causes the adjusted value to be stored. When V.H adjustment is complete, V.H stops blinking.	

10.14 Adjusting Motor-operated Valve Position (Position Proportional Output)

10.14.4 Setting Valve Traveling Time (Estimating Type)

Description

In the estimating type, a traveling time required to fully open the valve from its fully-closed position is set and valve positions are estimated according to the time consumed for valve operation.

The valve position estimating type is used when the feedback input of valve positions cannot be obtained.

(Wiring for feedback input is not necessary.)

The fully-opened side relay keeps ON-state when the output is 100%, and the fully-closed side relay keeps ON-state when the output is 0%.

Operating Principles

In the estimating type, the valve position is obtained by calculating the virtual feedback input based on the valve traveling time.

However, the virtual feedback input starts calculation from 50% at power-on.

Setting Details

Parameter symbol	Name	Display level	Setting range	Menu symbol
TR.T	Valve traveling time	STD	5 to 300 s	OUT Set

10.14.5 Selecting Feedback Input (Resistor/Current)

Description

Only the wiring for resistor or current is necessary for feedback input. There is no setting.

▶ [Wiring: 17.4.5 Valve Position Output and Feedback Input Wiring](#)

10.15 Using 15 V DC Loop Power Supply

Description

The 15 V DC loop power supply is a function to supply DC power (14.5 to 18.0 V DC (21 mA DC)) to a 2-wire transmitter.

The loop power supply block is isolated from the controller's internal circuitry. In addition, the block is equipped with a current limiting circuit. Therefore, accidental short-circuits that may occur in the field do not adversely affect the rest of the controller's internal circuitry.

Note that the loop power supply function cannot be used for digital communication where the supply voltage is superposed on the signal line.

The following shows the examples of loop power supply connection to a 2-wire transmitter.

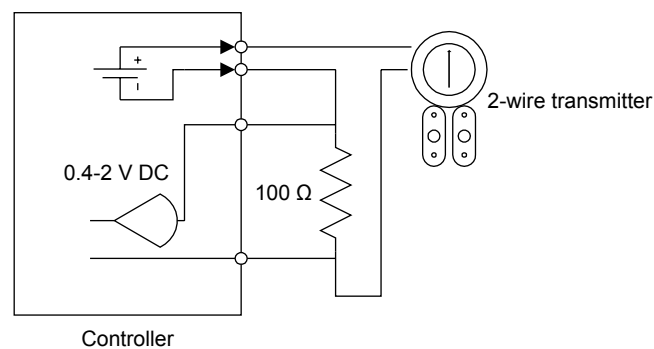

10.15 Using 15 V DC Loop Power Supply

Setting Details

Parameter symbol	Name	Display level	Setting range	Menu symbol
RTS	Retransmission output type of RET	EASY	OFF: Disable PV1: PV SP1: SP	OUT Set
O1RS	Retransmission output type of OUT current output	EASY	OUT1: OUT (Valve opening: 0 to 100 % in Position proportional control) LPS: 15 V DC loop power supply TSP1: Target SP HOUT1: Heating-side OUT COUT1: Cooling-side OUT MV1: Position proportional output (internal computed value) PV: PV terminals analog input	

Parameters and Corresponding Terminals

RTS	RET/OUT2 terminal
O1RS	OUT terminal

11.1 Setting Alarm Type

Description

The alarm-related parameters consist of the alarm type (type, stand-by action, energized/de-energized, and latch function), PV velocity alarm time setpoint, alarm hysteresis, alarm (On-/Off-) delay timer, and alarm setpoint.

Alarm-related parameter	Number of settings
Alarm type	4 (number of settings)
PV velocity alarm time setpoint	4 (number of settings)
Alarm hysteresis	4 (number of settings)
Alarm (on-/off-) delay timer	4 (number of settings)
Alarm setpoint	4 (number of settings) x 4 (number of groups)

- ▶ Alarm hysteresis: [11.3 Setting Hysteresis to Alarm Operation](#)
- ▶ Alarm delay timer: [11.4 Delaying Alarm Output \(Alarm Delay Timer\)](#)
- ▶ Alarm setpoint: [6.5 Setting Alarm Setpoint](#)

Factory default: Only four groups of alarm-related parameters are displayed.

- ▶ Terminal function: [17.4.7 Contact Output Wiring](#)

Alarm output can be assigned to the unused control relay output or contact output.

- ▶ Control relay output: [11.5 Setting Alarm Output to Control Relay Terminal](#)
- ▶ Contact output: [12.2.1 Setting Function of Contact Output](#)

Energized/de-energized of alarm output can be changed.

- ▶ Energized/de-energized: [12.2.2 Changing Contact Type of Contact Output](#)

To read the conditions of alarms, outputs, or latches via communication, see Communication Interface User's Manual.

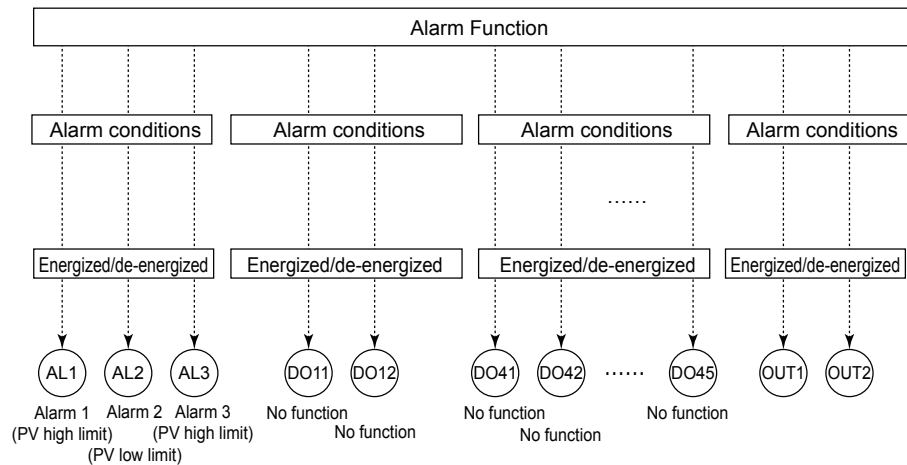

* See "Appendix 1 Input and Output Table of Standard Model and Suffix Codes" for presence/absence of the terminals DO11 to DO12, and DO41 to DO45.
 * OUT1 and OUT2 can be used for alarm output when the relay outputs are not used for control output.

PV High Limit Alarm and PV Low Limit Alarm

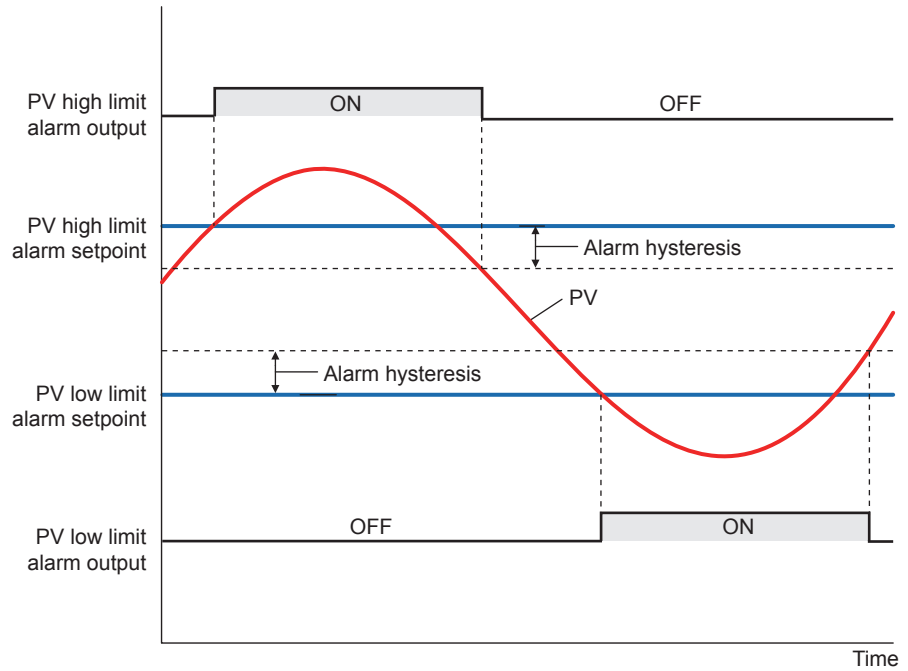

Contact type in the figure above: Energized when an event occurs (factory default).

SP High Limit Alarm and SP Low Limit Alarm

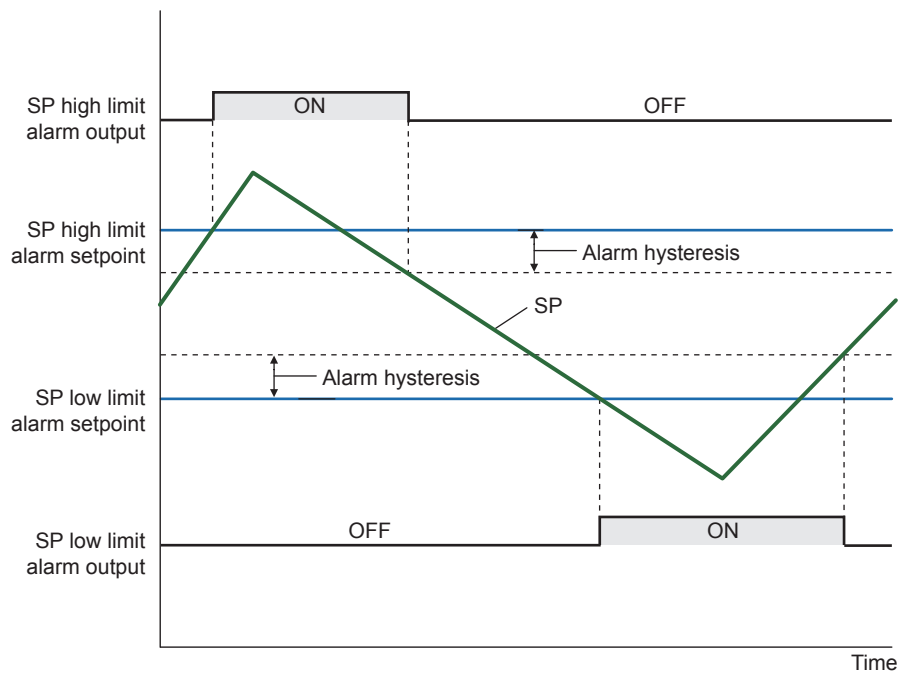

Contact type in the figure above: Energized when an event occurs (factory default).

Deviation High Limit Alarm and Deviation Low Limit Alarm

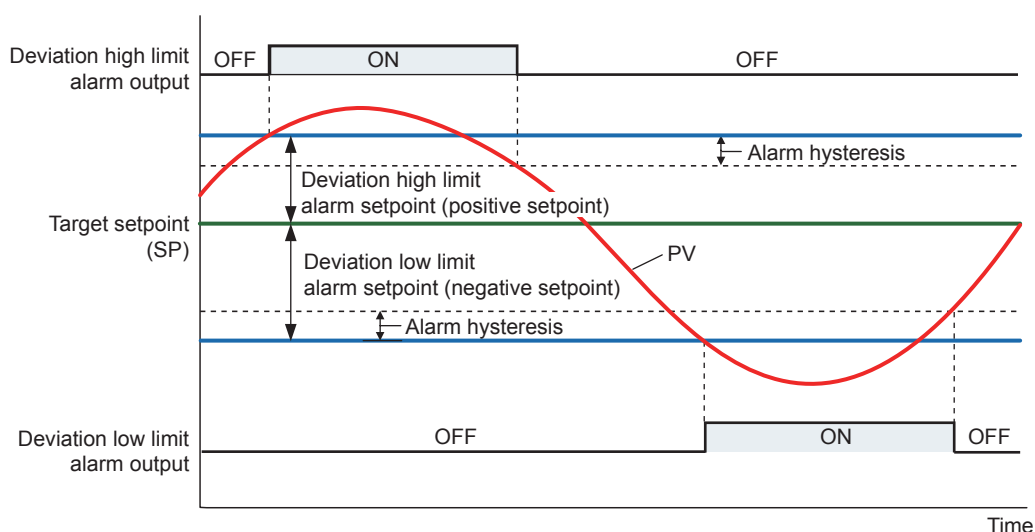

Contact type in the figure above: Energized when an event occurs (factory default).

When a negative setpoint is set for the deviation high limit alarm setpoint, the deviation setpoint will be lower than the SP. Moreover, when a positive setpoint is set for the deviation low limit alarm setpoint, the deviation setpoint will be higher than the SP.

Deviation High and Low Limits Alarm

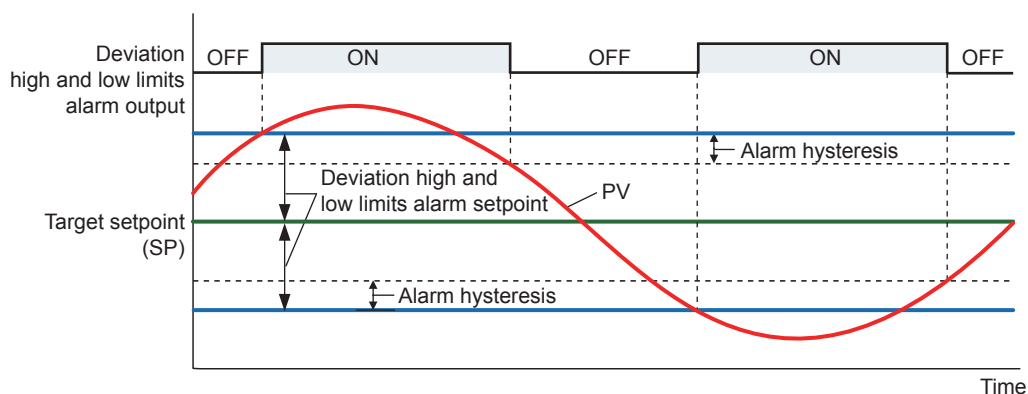

Contact type in the figure above: Energized when an event occurs (factory default).

Deviation within High and Low Limits Alarm

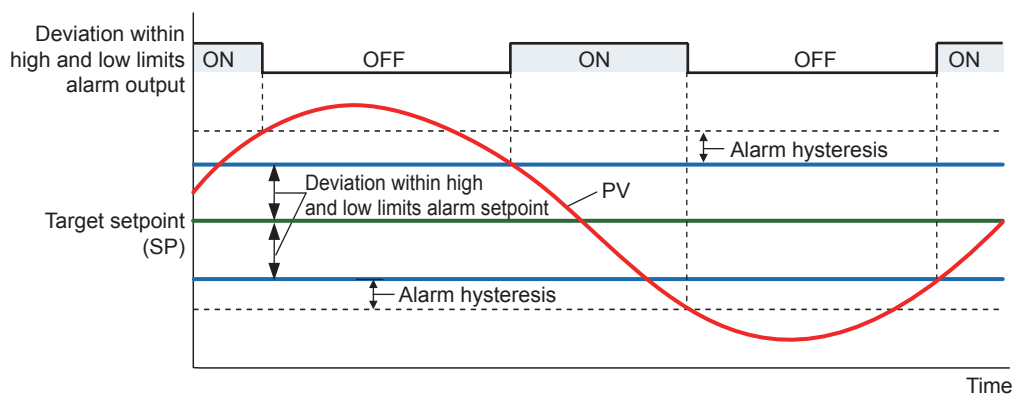

Contact type in the figure above: Energized when an event occurs (factory default).

Target SP High Limit Alarm and Target SP Low Limit Alarm

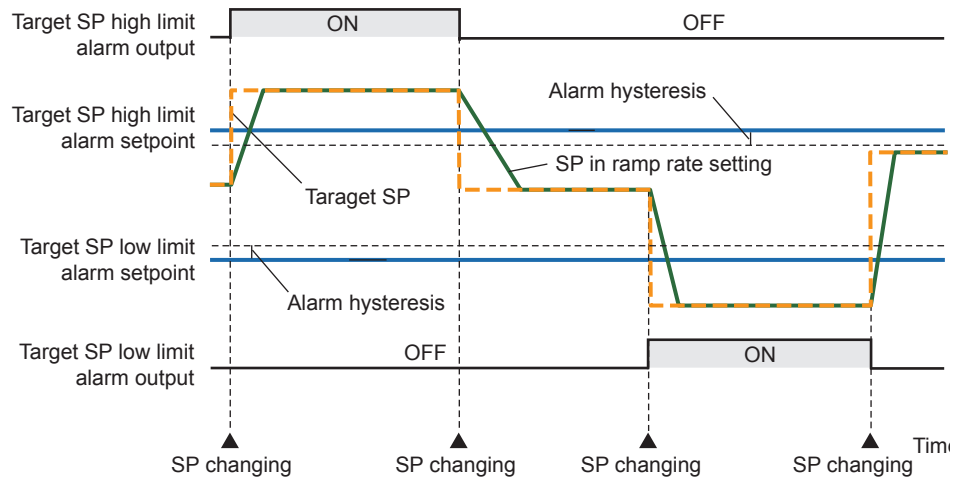

Contact type in the figure above: Energized when an event occurs (factory default).

Target SP Deviation High Limit Alarm and Target SP Deviation Low Limit Alarm

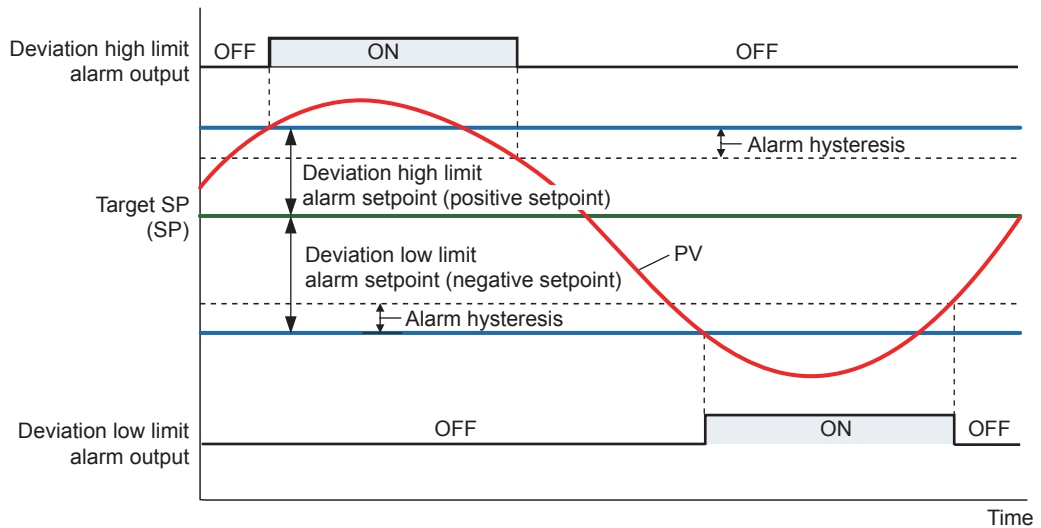

Contact type in the figure above: Energized when an event occurs (factory default).

* Target SP: a set target setpoint. When the ramp-rate is set, it becomes a final target setpoint.

When a negative setpoint is set for the deviation high limit alarm setpoint, the deviation setpoint will be lower than the target SP.
 Moreover, when a positive setpoint is set for the deviation low limit alarm setpoint, the deviation setpoint will be higher than the target SP.

Target SP Deviation High and Low Limits Alarm

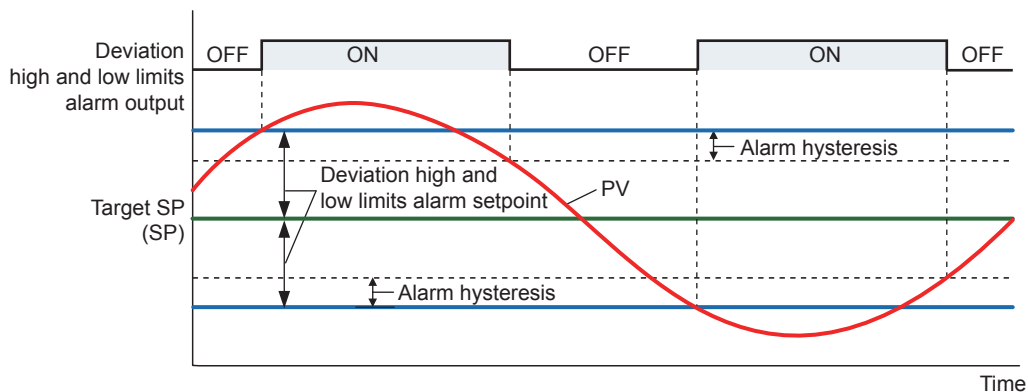

Contact type in the figure above: Energized when an event occurs (factory default).

Target SP Deviation within High and Low Limits Alarm

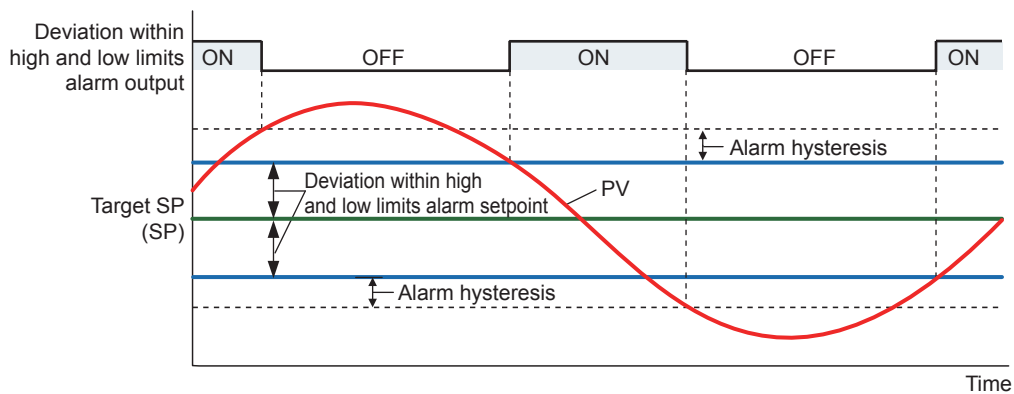

Contact type in the figure above: Energized when an event occurs (factory default).

11.1 Setting Alarm Type

Control Output High Limit Alarm and Control Output Low Limit Alarm

In Heating/cooling control, alarms are heating-side control output high limit alarm and heating-side control output low limit alarm.

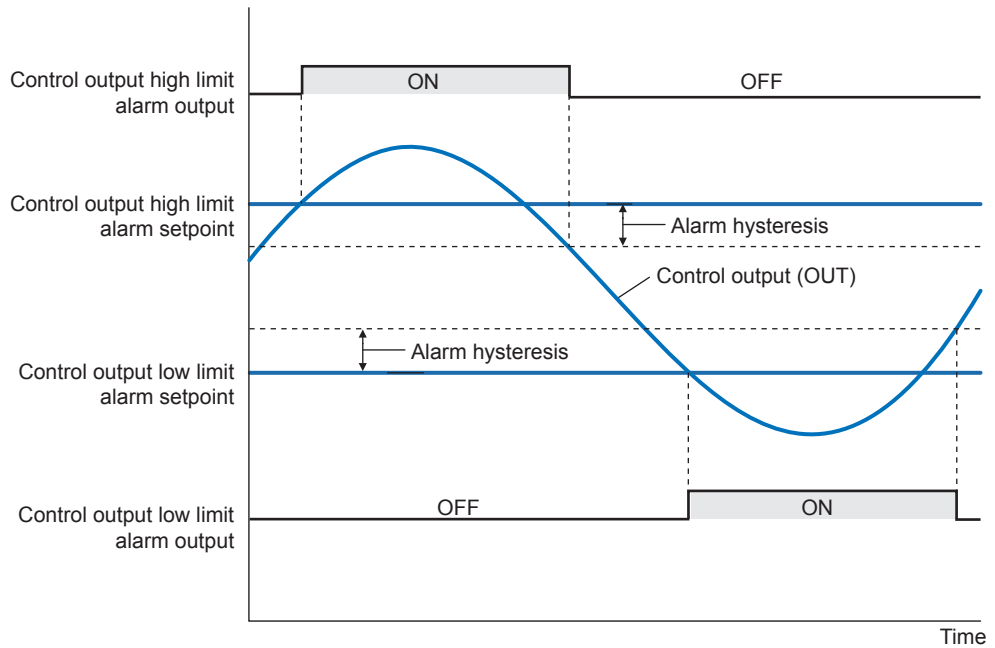

Contact type in the figure above: Energized when an event occurs (factory default).

Cooling-side Control Output High Limit Alarm and Cooling-side Control Output Low Limit Alarm

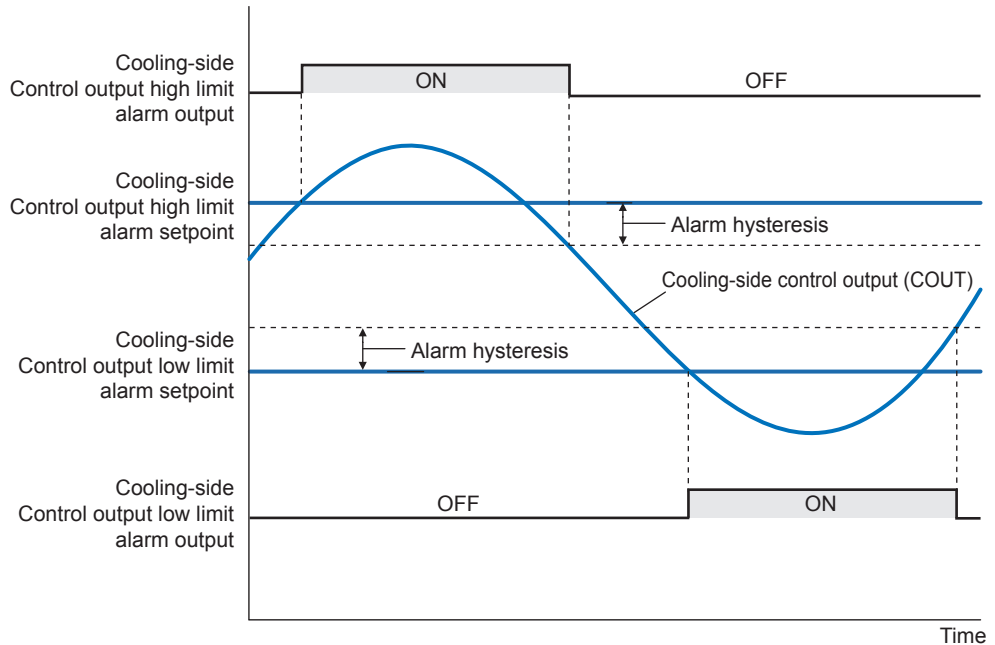

Contact type in the figure above: Energized when an event occurs (factory default).

Analog Input PV High Limit Alarm and Analog Input PV Low Limit Alarm

These alarms monitor the input value after the analog input computation process (entrance to the input ladder calculation) is completed.

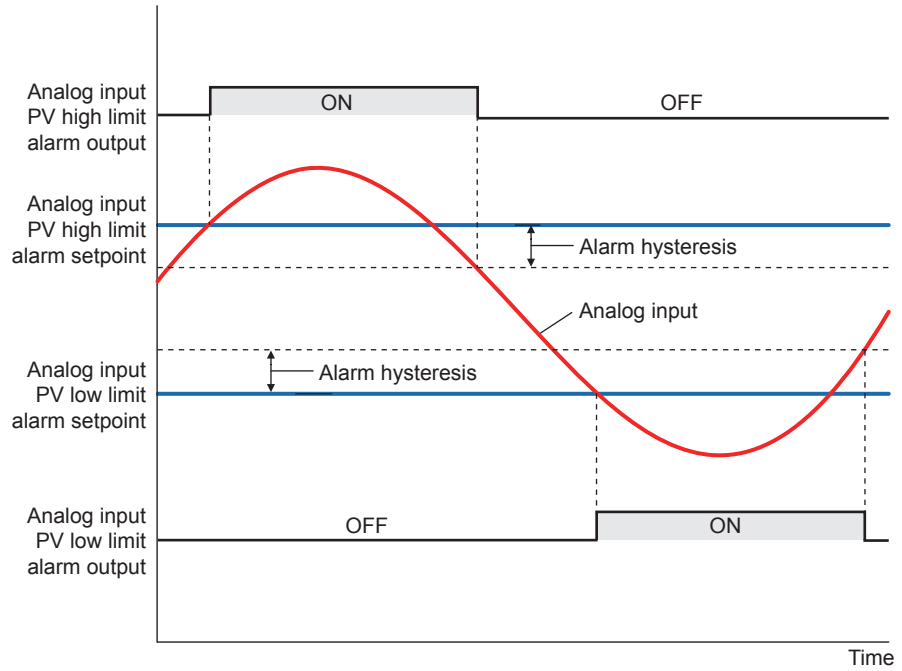

Contact type in the figure above: Energized when an event occurs (factory default).

Feedback Input High Limit Alarm and Feedback Input Low Limit Alarm

These alarms can be used only for Position proportional type..

These alarms monitor the feedback input (resistance or current) value.

The setting range for these alarms is 0.0 to 100.0%.

However, the setting range varies depending on whether the feedback input is a current value (4 to 20 mA) or resistance value (100 Ω to 2.5 kΩ).

Current value: 4 mA corresponds to 0.0%, and 20 mA to 100.0%.

Resistance value (e.g., 1 kΩ): The resistance value when the valve is fully closed after the valve position adjustment corresponds to 0.0%, and the resistance value when the valve is fully opened corresponds to 100.0%. 0 Ω does not correspond to 0.0%, and 1 kΩ does not correspond to 100.0%.

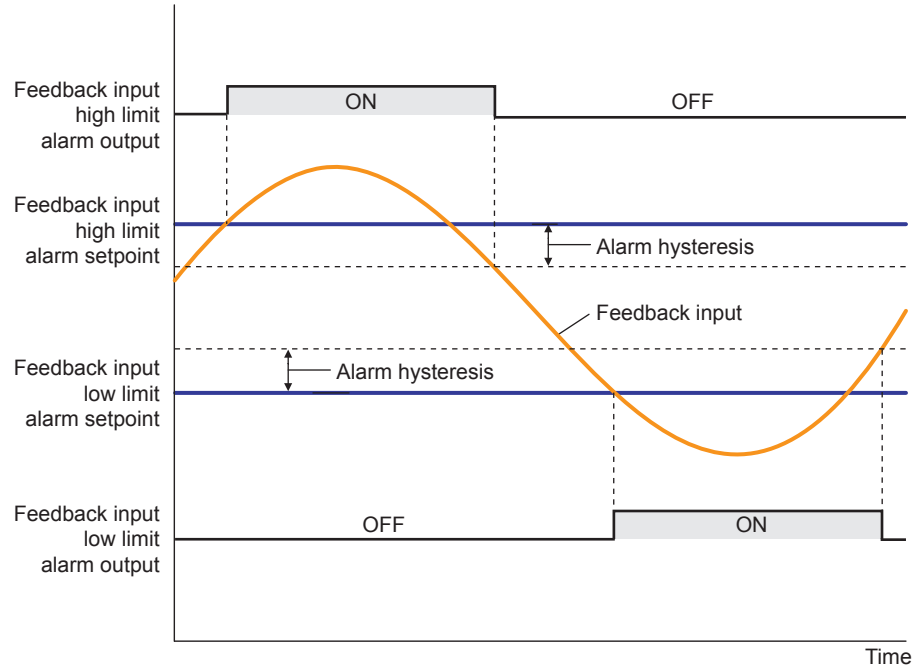

Contact type in the figure above: Energized when an event occurs (factory default).

PV Velocity Alarm

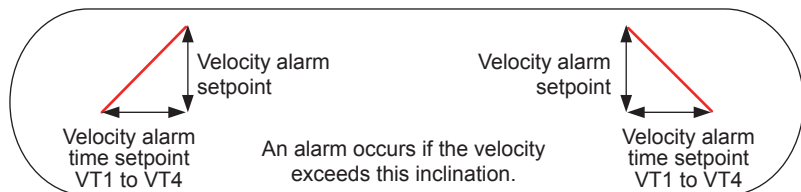
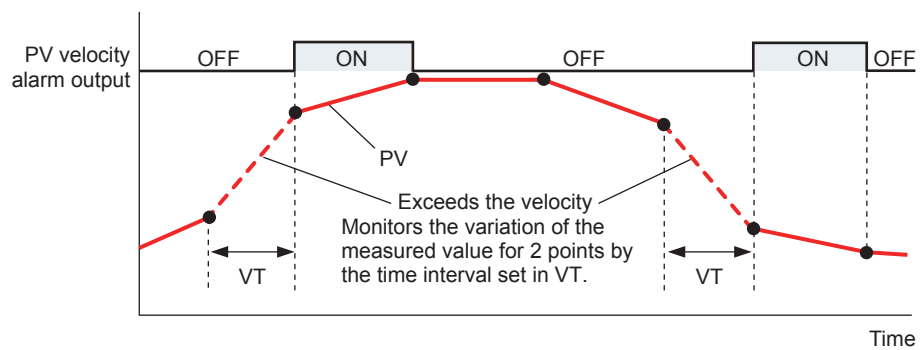

Contact type in the figure above: Energized when an event occurs (factory default).

The PV velocity alarm function does not work the alarm hysteresis, the stand-by action and the alarm delay timer functions.

Fault diagnosis Alarm

The function outputs an alarm signal in the following cases.

The corresponding event (EV) lamp is lit and the contact output turns on (when the contact type is energized).

- Burnout of PV input
- ADC failure of PV input
- Reference junction compensation (RJC) error of PV input

The fault diagnosis alarm does not work the stand-by action functions.

FAIL output

When the FAIL condition is caused (faulty MCU or system data error), DO (alarm output) turned off regardless of contact type.

The FAIL output does not work the alarm latch, the energized/de-energized and the stand-by action functions.

Stand-by Action

The stand-by action is a function for ignoring the alarm condition and keeps the alarm off until the alarm condition is removed. Once the alarm condition is removed, the stand-by action is cancelled.

It is effective in the following cases where;

- The power is turned on
- SP is changed
- SP number is switched (however, except for remote setpoint) (The SP must be changed.)
- The alarm type is changed
- Forced stand-by via communication

The following shows the behavior of an alarm with the stand-by action at power ON.

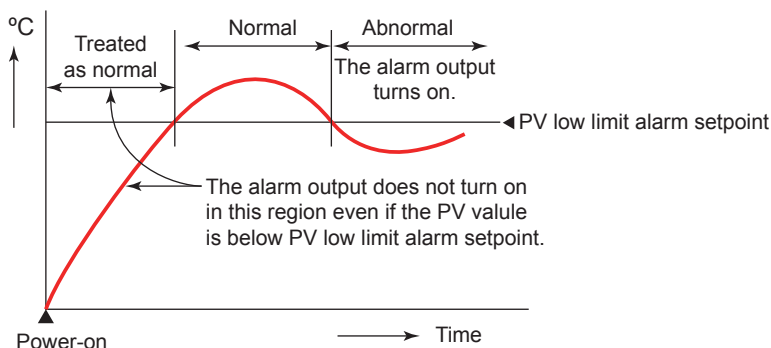

Alarm Latch Function

The alarm latch function is a function for keeping the alarm output (keeping the alarm output on) after entering the alarm condition (alarm output is turned on) until an order to release the alarm latch is received.

The alarm latch function has the following four types of action.

Latch 1

Cancels the alarm output when an order to release the alarm latch is received. (Alarm output OFF.)
 However, an order to release the alarm latch is ignored if the order is received during alarm condition.

Latch 2

Always forces cancelling of the alarm output when an order to release the alarm latch is received. (Alarm output OFF)

Latch 3

Cancels the alarm output when an order to release the alarm latch is received or when the alarm condition is removed. (Alarm output OFF.)

Latch 4

Cancels the alarm output when an order to release the alarm latch is received. (Alarm output OFF.)
 However, cancels the alarm output for the duration of the sampling period (control period) if an order to release the alarm latch is received during alarm condition. (Alarm output OFF)

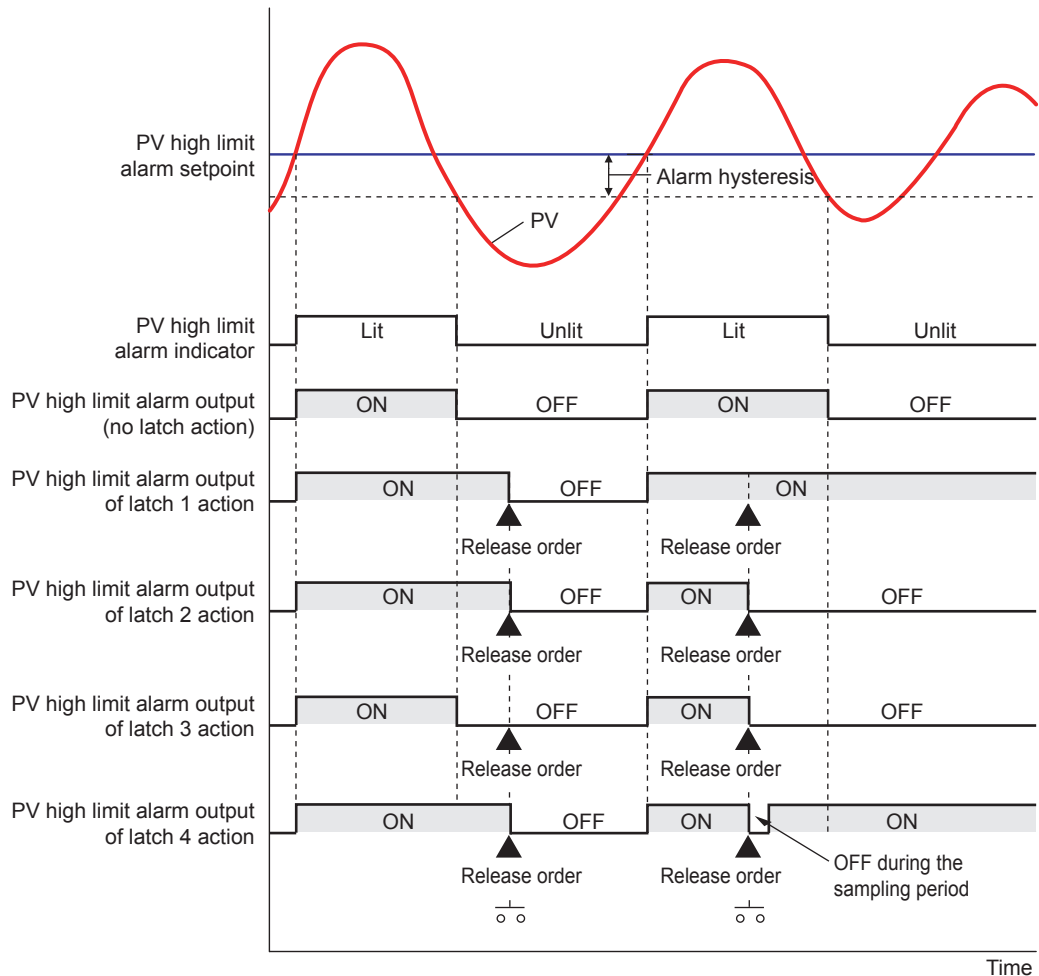

Contact type in the figure above: Energized when an event occurs (factory default).

Release of Alarm Latch

The alarm latch function can be cancelled by the user function key, via communication/ladder program, or by contact input.

Cancelling the alarm latch function cancels all latched alarm outputs.

- ▶ Release by user function key: [13.2 Assigning Function to User Function Key and A/M key](#)
- ▶ Release by contact input: [12.1.1 Setting Contact Input Function](#)
- ▶ Release via communication: [UTAdvanced Series Communication Interface User's Manual](#)

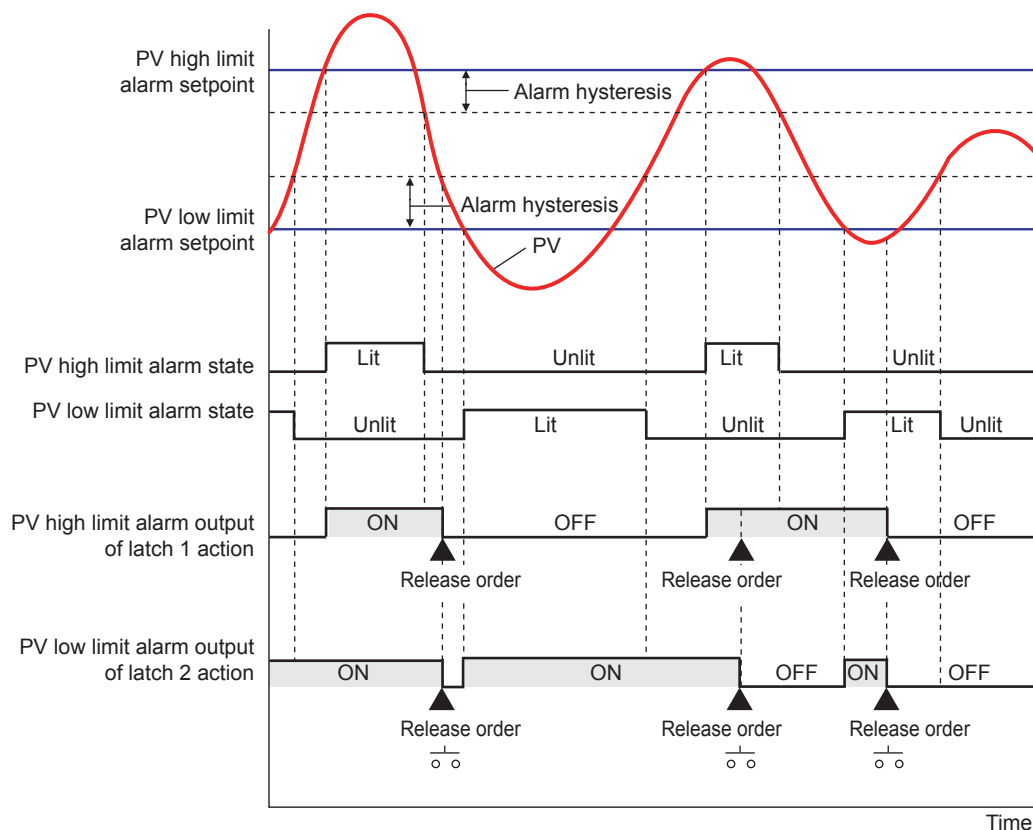

Contact type in the figure above: Energized when an event occurs (factory default).

Operation of Alarm Output and Display Lamp (EV)

The contact output and display lamp (EV) are usually output and displayed according to the setpoint of the alarm type. However, the alarm conditions (operations) of the normal action, and latch action can be assigned to the contact output and display lamp (EV), regardless of the setpoint of the alarm type. (Two operations can be assigned simultaneously.)

- ▶ Display lamp action: [13.1 Setting Display Functions](#)
- ▶ Contact output action: [12.2.1 Setting Function of Contact Output](#)

11.1 Setting Alarm Type

Setting Details

Parameter symbol	Name	Display level	Setting range	Menu symbol
AL1 to AL4	Alarm-1 to -4 type	EASY	See the table below.	ALRM Ope
VT1 to VT4	PV velocity alarm time setpoint 1 to 4	EASY	00.01 to 99.59 (minute.second)	

Note1: The initial values of the parameters AL1 to AL4 and VT1 to VT4 are "4". The number of alarms can be changed using the parameter ALNO.

The following shows the example of setting PV high limit (01), With stand-by action (1), De-energized (1), and Latch 1 action (1).

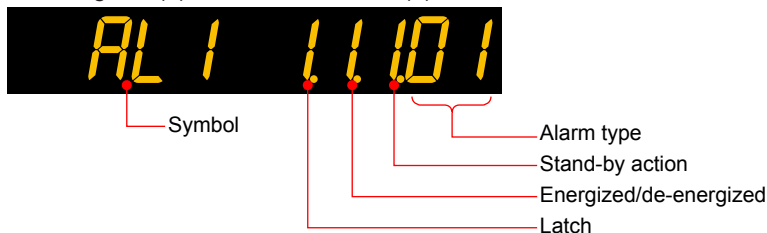

Name	Latch action (Note 1)	Energized (0) / de-energized (1)	Stand-by action Without (0) / with (1)	Alarm type
Disable	0 / 1 / 2 / 3 / 4	0 / 1	0 / 1	00
PV high limit	0 / 1 / 2 / 3 / 4	0 / 1	0 / 1	01
PV low limit	0 / 1 / 2 / 3 / 4	0 / 1	0 / 1	02
SP high limit	0 / 1 / 2 / 3 / 4	0 / 1	0 / 1	03
SP low limit	0 / 1 / 2 / 3 / 4	0 / 1	0 / 1	04
Deviation high limit	0 / 1 / 2 / 3 / 4	0 / 1	0 / 1	05
Deviation low limit	0 / 1 / 2 / 3 / 4	0 / 1	0 / 1	06
Deviation high and low limits	0 / 1 / 2 / 3 / 4	0 / 1	0 / 1	07
Deviation within high and low limits	0 / 1 / 2 / 3 / 4	0 / 1	0 / 1	08
Target SP high limit	0 / 1 / 2 / 3 / 4	0 / 1	0 / 1	09
Target SP low limit	0 / 1 / 2 / 3 / 4	0 / 1	0 / 1	10
Target SP deviation high limit	0 / 1 / 2 / 3 / 4	0 / 1	0 / 1	11
Target SP deviation low limit	0 / 1 / 2 / 3 / 4	0 / 1	0 / 1	12
Target SP deviation high and low limits	0 / 1 / 2 / 3 / 4	0 / 1	0 / 1	13
Target SP deviation within high and low limits	0 / 1 / 2 / 3 / 4	0 / 1	0 / 1	14
Control output high limit	0 / 1 / 2 / 3 / 4	0 / 1	0 / 1	15
Control output low limit	0 / 1 / 2 / 3 / 4	0 / 1	0 / 1	16
Cooling-side Control output high limit	0 / 1 / 2 / 3 / 4	0 / 1	0 / 1	17
Cooling-side Control output low limit	0 / 1 / 2 / 3 / 4	0 / 1	0 / 1	18
Analog input PV high limit	0 / 1 / 2 / 3 / 4	0 / 1	0 / 1	19
Analog input PV low limit	0 / 1 / 2 / 3 / 4	0 / 1	0 / 1	20
Feedback input high limit	0 / 1 / 2 / 3 / 4	0 / 1	0 / 1	27
Feedback input low limit	0 / 1 / 2 / 3 / 4	0 / 1	0 / 1	28
PV velocity	0 / 1 / 2 / 3 / 4	0 / 1	- (Note 2)	29
Fault diagnosis	0 / 1 / 2 / 3 / 4	0 / 1	- (Note 2)	30
FAIL	- (Note 2)	- (Note 2)	- (Note 2)	31

Note 1: 0: No latch function, 1: Latch 1, 2: Latch 2, 3: Latch 3, 4: Latch 4

Note 2: -: Alarm function doesn't work even if any value is set.

11.2 Setting Number of Alarm Groups to Use

Description

Up to four alarm groups of alarm type, alarm hysteresis, alarm (On-/Off-) delay timer, and alarm setpoint are available.
Unused alarm parameters can be hidden and their functions can be turned off.
The initial value of parameter ALNO. is "4."
When ALNO. = 4, for example, only the four groups of alarm type, PV velocity alarm time setpoint, alarm hysteresis, alarm delay timer, and alarm setpoint are displayed.

Setting Details

Parameter symbol	Name	Display level	Setting range	Menu symbol
ALNO.	Number of alarm groups	PRO	1 to 4	CTL Set

11.3 Setting Hysteresis to Alarm Operation

Description

If the On/Off switch of the alarm output is too busy, you can alleviate the busyness by increasing the alarm hysteresis.

Hysteresis for PV High Limit Alarm

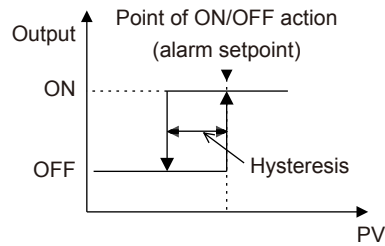

When Setting Hysteresis of 5°C and 15°C for PV High Limit Alarm

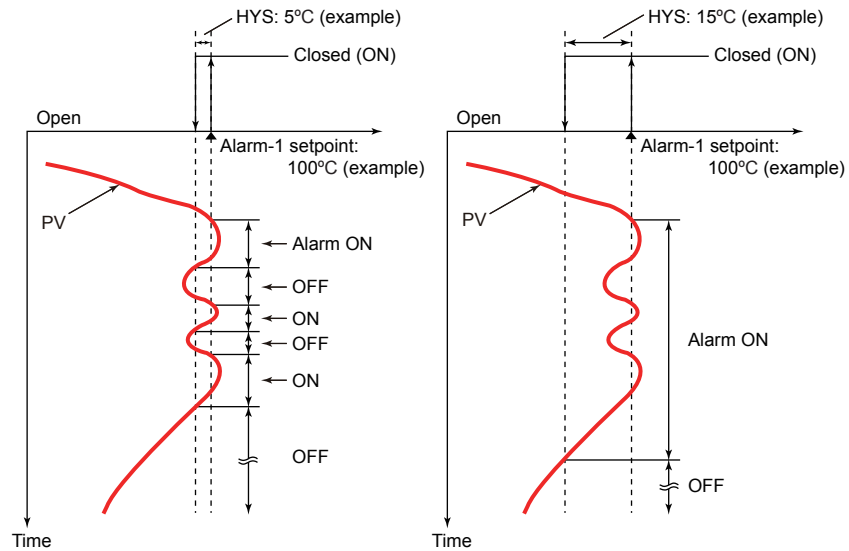

Setting Details

Parameter symbol	Name	Display level	Setting range	Menu symbol
HY1 to HY4	Alarm-1 to -4 hysteresis	EASY	Sets the hysteresis setpoint as a display value. -19999 to 30000 (set it within the input range) The decimal point position depends on the input type.	ALRM Ope

11.4 Delaying Alarm Output (Alarm Delay Timer)

Description

The alarm on-delay timer is a function for turning on the alarm when the alarm condition occurs, and the timer starts and the set time elapses. The timer is reset if the alarm condition is removed while the timer is running. No alarm is generated. The figure below shows the example of the On-delay timer

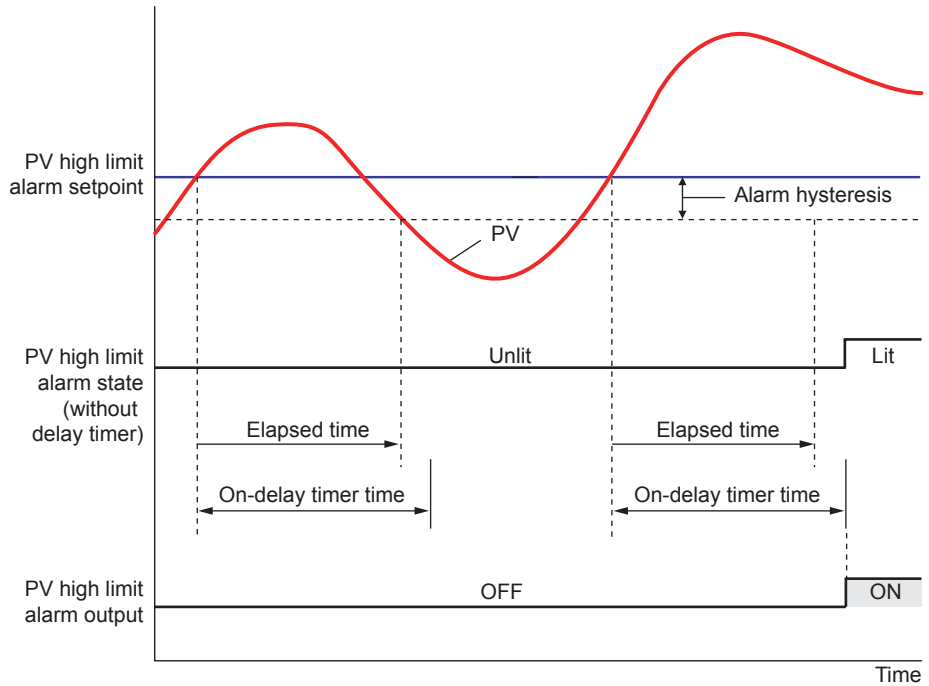

Contact type in the figure above: Energized when an event occurs (factory default).

The alarm Off-delay timer is a function for turning off the alarm when the alarm condition is removed (normal condition), and the timer starts and the set time elapses. The timer is reset if the alarm condition occurs again while the timer is running. The alarm is not cancelled.

Setting Details

Parameter symbol	Name	Display level	Setting range	Menu symbol
DYN1 to DYN4	Alarm-1 to -4 On-delay timer	STD	0.00 to 99.59 (minute.second)	ALRM Ope
DYF1 to DYF4	Alarm-1 to -4 Off-delay timer	PRO		

11.5 Setting Alarm Output to Control Relay Terminal

Description

The control relay terminal can be used for alarm output when it is not used for control output.

Setting Details

Parameter symbol	Name	Display level	Setting range	Menu symbol
OR.S	OUT relay function selection	STD	Same as the setpoint for the contact output function. See 12.2.1, "Setting Function of Contact Output."	ALM 
OR.D	OUT relay contact type	PRO	0: Closes the contact when an event occurs 1: Opens the contact when an event occurs.	
OR2.S	OUT2 relay function selection	STD	Same as OR.S.	
OR2.D	OUT2 relay contact type	PRO	Same as OR.D	

Parameters and Corresponding Terminals

OR.S, OR.D	OUT terminal
OR2.S, OR2.D	OUT2 terminal

11.6 Setting Alarm Action According to Operation Mode

Description

The alarm action usually functions regardless of operation modes. Setting the alarm mode allows the alarm action to be disabled in STOP or in STOP or MAN mode.

Setting Details

Parameter symbol	Name	Display level	Setting range	Menu symbol
AMD	Alarm mode	STD	0: Always active 1: Not active in STOP mode 2: Not active in STOP or MAN mode	ALRM 

11.7 Setting Heater Break Alarm

Description

Either of heater break alarm function or heater current measurement function can be selected.

Heater Break Alarm Function

The heater break alarm function measures the heater current, and outputs the heater break alarm if the current is less than the heater break detecting point. The heater break alarm function can be used only for ON/OFF output (relay output) or for time proportional output (relay output, voltage pulse output). It cannot be used for current output.

In Heating/cooling control,

Heater break alarm for the heating-side or cooling-side can be selected in heating/cooling control.

Timing which detects the heater break alarm is as follows.

- For ON/OFF output:
Heater break is detected when control output is in On-state. (Heater break is not detected when control output is in Off-state.)
- For time proportional output:
When On-state time of control output is 130 ms or longer, heater break is detected. Heater break is detected between 20 ms and 120 ms after control output turns on. Heater current value is detected every 200 ms while control output turns on.

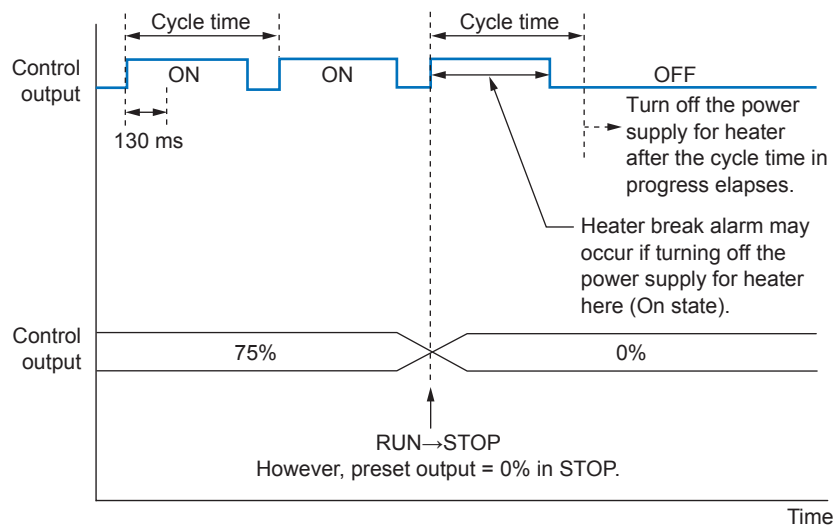

Heater break detecting point

Set a detecting point (setpoint) of heater break alarm.

The heater break alarm is output if the measured current is less than the detecting point (setpoint).

Current Transformer Winding Number Ratio

The coil winding number ratio of current transformer (CT ratio) can be set.

Example: Set the CT ratio "800" for the CTL-6-S-H manufactured by U.R.D. Co., Ltd.

Heater Current Measured Value

A measured heater current value can be confirmed by a displayed value on operation display.

▶ [Heater current measured value: 6.1 Monitoring and Control of Operation Displays](#)

Heater Break Alarm Delay Timer

The delay timer (On-delay timer, Off-delay timer) can be set for the heater break alarm function.

▶ [Delay timer: 11.4 Delaying Alarm Output \(Alarm Delay Timer\)](#)

Heater Break Alarm Output Contact Type

The heater break alarm output contact type sets an action direction of contact output (ON/OFF) when an event occurs.

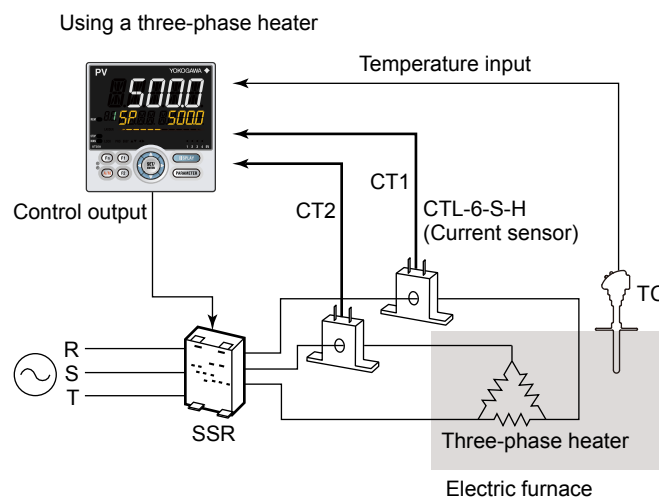
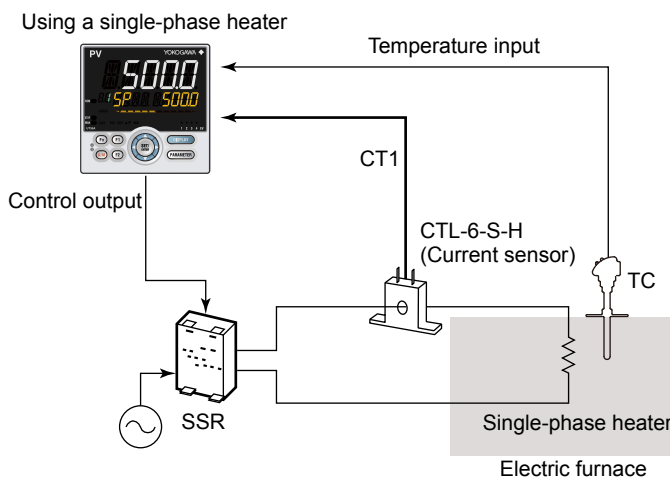

11.7 Setting Heater Break Alarm

Heater Current Measurement Function

The heater current value can be confirmed by a displayed value on operation display.

▶ [Heater current measured value: 6.1 Monitoring and Control of Operation Displays](#)

The heater break alarm function can be used only for ON/OFF output (relay output), for time proportional output (relay output, voltage pulse output) or for current output.

Heater current value is detected every 200 ms.

Setting Details

Parameter symbol	Name	Display level	Setting range	Menu symbol
HB1.S, HB2.S	Heater break alarm function selection	EASY	0: Heater current measurement 1: Heater break alarm (Heating-side) 2: Cooling-side heater break alarm	HBA Set
HB1, HB2	Heater break alarm current setpoint	EASY	OFF, 0.1 to 300.0 Arms	
CT1.T, CT2.T	CT coil winding number ratio	EASY	1 to 3300	
HDN1, HDN2	Heater break alarm On-delay timer	STD	0.00 to 99.59 (minute.second)	
HDF1, HDF2	Heater break alarm Off-delay timer	PRO		
HB1.D, HB2.D	Heater break alarm contact type	PRO	CLS: When the event occurs, the contact is closed. OPN: When the event occurs, the contact is opened.	

Note1: In cases where the current transformer manufactured by U.R.D Co., Ltd. are used, set the following value for the CT coil winding number ratio.

CTL-6-S-H: 800

CTL-12L-30: 3000

12.1 Setting Contact Input Function

12.1.1 Setting Contact Input Function

Description

The contact input function works by setting the contact input number (I relay) to functions such as the operation mode.

This explanation assumes that the contact type is energized. (The function is executed when the contact is turned on)

AUTO/MAN Switch (A/M)

AUTO/MAN mode can be switched using contact input. (Status switch)

Contact status	Operation	Remark
ON	AUTO	Switch by keystroke or via communication is disabled.
OFF	MAN	Switch by keystroke or via communication is enabled.

REMOTE/LOCAL Switch (R/L)

Displayed only in cases where the communication is specified.

REMOTE/LOCAL mode can be switched using contact input. (Status switch)

Contact status	Operation	Remark
ON	REMOTE	Switch by keystroke or via communication is disabled.
OFF	LOCAL	Switch by keystroke or via communication is enabled.

STOP/RUN Switch (S/R)

STOP/RUN mode can be switched using contact input. (Status switch)

Contact status	Operation	Remark
ON	STOP	When the STOP/RUN switch is assigned (S/R ≠ 0), switch by keystroke or via communication is disabled.
OFF	RUN	–

Switch to AUTO (AUTO)

The mode can be switched to AUTO using contact input. (Switch by the rising edge)

Contact status	Operation	Remark
OFF→ON	Switch to AUTO	–
ON→OFF	Maintains the current operation status	–

Switch to MAN (MAN)

The mode can be switched to MAN using contact input. (Switch by the rising edge)

Contact status	Operation	Remark
OFF→ON	Switch to MAN	–
ON→OFF	Maintains the current operation status	–

12.1 Setting Contact Input Function

Switch to REMOTE (REM)

Displayed only in cases where the communication is specified.

The mode can be switched to REMOTE using contact input. (Switch by the rising edge)

Contact status	Operation	Remark
OFF→ON	Switch to REMOTE	–
ON→OFF	Maintains the current operation status	–

Switch to LOCAL (LCL)

Displayed only in cases where the communication is specified.

The mode can be switched to LOCAL using contact input. (Switch by the rising edge)

Contact status	Operation	Remark
OFF→ON	Switch to LOCAL	–
ON→OFF	Maintains the current operation status	–

Auto-tuning START/STOP Switch (AT)

Auto-tuning START/STOP can be switched using contact input.

Auto-tuning is executed to the PID group currently specified. (Switch by the rising edge and the falling edge)

Contact status	Operation	Remark
OFF→ON	Starts auto-tuning	–
ON→OFF	Stops auto-tuning	–

Latch Release (LAT)

Latch can be released using contact input. (Switch by the rising edge)

Contact status	Operation	Remark
OFF→ON	Releases the latch	The latch release by keystroke or via communication is disabled.
ON→OFF	Maintains the current operation status	The latch release by keystroke or via communication is enabled.

Releasing the latch function releases all latched contact (alarm) outputs.

LCD Backlight ON/OFF Switch (LCD)

LCD backlight ON/OFF can be switched using contact input. (Switch by the rising edge and the falling edge)

Contact status	Operation	Remark
OFF→ON	Turns off the LCD backlight	–
ON→OFF	Turns on the LCD backlight	–

Message Display Interruption 1 to 4 (MG 1 to 4)

The message set using LL50A Parameter Setting Software can be interrupt-displayed on PV display using contact input. The messages are limited to 20 alphanumeric characters. A maximum of four displays can be registered. (Switch by the rising edge)

▶ [Message: LL50A Parameter Setting Software User's Manual](#)

Contact status	Operation	Remark
OFF→ON	Interrupt-displays the message	Pressing the DISPLAY key erases the message.
ON→OFF	Displays the current PV	–

Bit-0 to Bit-2 of SP Number (SP.B0 to SP.B2)

The SP number can be switched using contact input. There are two methods to specify SP number.

- Status switch 1 (Operation by keystroke or via communication is enabled depending on the conditions.)

SP number	Contact status		
	SP.B2	SP.B1	SP.B0
1	OFF	OFF	ON
2	OFF	ON	OFF
3	OFF	ON	ON
4	ON	OFF	OFF

*1: "1" when the contact input is turned on and "0" when turned off.

*2: SP number can be switched by keystroke or via communication when all contact inputs of SP.B0 to SP.B2 are turned off.

*3: SP number cannot be switched by keystroke or via communication when any contact input of SP.B0 to SP.B2 is turned on.

*4: The contact input is turned off when the bit of SP number is not assigned to the contact input.

*5: The immediately preceding SP number is held when all contact inputs are turned off.

- Status switch 2 (Operation by keystroke or via communication is disabled.)

SP number	Contact status		
	SP.B2	SP.B1	SP.B0
1	OFF	OFF	OFF
2	OFF	OFF	ON
3	OFF	ON	OFF
4	OFF	ON	ON

*1: "1" when the contact input is turned on and "0" when turned off.

*2: Contact input is turned off when the bit of SP number is not assigned to the contact input.

Setting Details

Parameter symbol	Name	Display level	Setting range	Menu symbol
SP.BC	Bit changing method of SP number	PRO	0: Status switch 1 1: Status switch 2	DI.NU 

12.1 Setting Contact Input Function

Bit-0 to Bit-2 of PID Number (PN.B0 to PN.B2)

The PID number can be switched using contact input. There are two methods to specify a PID number.

- Status switch 1 (Operation by keystroke or via communication is enabled depending on the conditions.)

PID number	Contact status		
	PN.B2	PN.B1	PN.B0
1	OFF	OFF	ON
2	OFF	ON	OFF
3	OFF	ON	ON
4	ON	OFF	OFF

- *1: "1" when the contact input is turned on and "0" when turned off.
- *2: PID number can be switched by keystroke or via communication when all contact inputs of PN.B0 to PN.B3 are turned off.
- *3: PID number cannot be switched by keystroke or via communication when any contact input of PN.B0 to PN.B3 is turned on.
- *4: The contact input is turned off when the bit of PID number is not assigned to the contact input.

- Status switch 2 (Operation by keystroke or via communication is disabled.)

PID number	Contact status		
	PN.B2	PN.B1	PN.B0
1	OFF	OFF	OFF
2	OFF	OFF	ON
3	OFF	ON	OFF
4	OFF	ON	ON

- *1: "1" when the contact input is turned on and "0" when turned off.
- *2: Contact input is turned off when the bit of PID number is not assigned to the contact input.

Setting Details

Parameter symbol	Name	Display level	Setting range	Menu symbol
PN.BC	Bit changing method of PID number	PRO	0: Status switch 1 1: Status switch 2	DI.NU Set

Bit-0 to Bit-2 of Manual Preset Output Number (MP.B0 to MP.B2)

The manual preset output number can be switched using contact input. There are two methods to specify a manual preset output number.

- Status switch 1 (Operation by keystroke or via communication is enabled depending on the conditions.)

Manual preset output number	Contact status		
	MP.B2	MP.B1	MP.B0
1	OFF	OFF	ON
2	OFF	ON	OFF
3	OFF	ON	ON
4	ON	OFF	OFF
5	ON	OFF	ON

*1: "1" when the contact input is turned on and "0" when turned off.

*2: Manual preset output number can be switched by keystroke via communication when all contact inputs of MP.B0 to MP.B2 are turned off.

*3: Manual preset output number cannot be switched by keystroke or via communication when any contact input of MP.B0 to MP.B2 is turned on.

*4: The contact input is turned off when the bit of manual preset output number is not assigned to the contact input.

- Status Switch 2 (Operation by keystroke or via communication is disabled.)

Manual preset output number	Contact status		
	MP.B2	MP.B1	MP.B0
1	OFF	OFF	OFF
2	OFF	OFF	ON
3	OFF	ON	OFF
4	OFF	ON	ON
5	ON	OFF	OFF

*1: "1" when contact input is turned on and "0" when turned off.

*2: The contact input is turned off when the bit of manual preset output number is not assigned to the contact input.

Setting Details

Parameter symbol	Name	Display level	Setting range	Menu symbol
MP.BC	Bit changing method of manual preset output number	PRO	0: Status switch 1 1: Status switch 2	DI.NU Set

12.1 Setting Contact Input Function

Contact Action

Type	Operation	Description
Status	<p>The diagram shows a horizontal line representing a signal. It starts at a low level labeled 'OFF'. An upward arrow indicates a transition to a high level labeled 'ON'. A downward arrow indicates a transition back to the low level labeled 'OFF'.</p>	Receiving a contact input signal changes the status to the specified operation, and a release changes the status back to the original action.
Rising edge	<p>Rising edge</p> <p>The diagram shows a pulse that rises from 'OFF' to 'ON' and then falls back to 'OFF'. Below the pulse, two vertical lines mark the start and end of the pulse. Horizontal arrows between these lines indicate the detection time. Below the diagram, the text reads: 'Detection time: Control period + 50 ms'.</p>	<p>Receiving an OFF-to-ON contact input signal changes the status to the specified operation. The minimum detection time is the control period + 50 ms.</p> <p>Pulse width is 50 ms or more.</p>
Falling edge	<p>Falling edge</p> <p>The diagram shows a pulse that falls from 'ON' to 'OFF'. Below the pulse, two vertical lines mark the start and end of the pulse. Horizontal arrows between these lines indicate the detection time. Below the diagram, the text reads: 'Detection time: Control period + 50 ms'.</p>	<p>Receiving an ON-to-OFF contact input signal changes the status to the specified operation. The minimum detection time is the control period + 50 ms.</p> <p>Pulse width is 50 ms or more.</p>

Setting Details

Parameter symbol	Name	Display level	Setting range	Menu symbol
A/M	AUTO/MAN switch	STD	See the following section, "UT35A DI and Setpoint" or "UT32A DI and Setpoint".	DI.SL Set
R/L	REMOTE/LOCAL switch	STD		
S/R	STOP/RUN switch	STD		
AUTO	Switch to AUTO	STD		
MAN	Switch to MAN	STD		
REM	Switch to REMOTE	STD		
LCL	Switch to LOCAL	STD		
AT	Auto-tuning START/STOP switch	STD		
LAT	Latch release	STD		
LCD	LCD backlight ON/OFF switch	STD		
MG1	Message display interruption 1	PRO		
MG2	Message display interruption 2	PRO		
MG3	Message display interruption 3	PRO		
MG4	Message display interruption 4	PRO		
SP.B0	Bit-0 of SP number	EASY		DI.NU Set
SP.B1	Bit-1 of SP number	EASY		
SP.B2	Bit-2 of SP number	EASY		
PN.B0	Bit-0 of PID number	STD		
PN.B1	Bit-1 of PID number	STD		
PN.B2	Bit-2 of PID number	STD		
MP.B0	Bit-0 of manual preset output number	STD		
MP.B1	Bit-1 of manual preset output number	STD		
MP.B2	Bit-2 of manual preset output number	STD		

12.1 Setting Contact Input Function

UT35A DI and Setpoint (1 relay number)

DI equipped as standard

DI symbol	Setpoint
DI1	5025
DI2	5026

Additional DI

When Type 2 code is "1"		When Type 2 code is "2"	
DI symbol	Setpoint	DI symbol	Setpoint
DI11	5041	DI11	5041
DI12	5042	DI12	5042
–	–	DI13	5043
–	–	DI14	5044
–	–	DI15	5045

UT32A DI and Setpoint (1 relay number)

DI equipped as standard

DI symbol	Setpoint
DI1	5025
DI2	5026

Additional DI

When Type 2 code is "2"	
DI symbol	Setpoint
DI11	5041
DI12	5042

12.1.2 Changing Contact Type of Contact Input

Description

The contact type can set the action direction of contact input assigned to the function.

Setting Details

Contact Input Equipped as Standard

Parameter symbol	Name	Display level	Setting range	Menu symbol
DI1.D	DI1 contact type	PRO	0: The assigned function is enabled when the contact input is closed. 1: The assigned function is enabled when the contact input is opened.	DI.D Set
DI2.D	DI2 contact type	PRO		

Note1: Nothing is displayed on Group display when each parameter is displayed.

Additional Contact Input

Parameter symbol	Name	Display level	Setting range	Menu symbol
DI1.D	DIn1 contact type	PRO	0: The assigned function is enabled when the contact input is closed. 1: The assigned function is enabled when the contact input is opened.	DI.D Set
DI2.D	DIn2 contact type	PRO		
DI3.D	DIn3 contact type	PRO		
DI4.D	DIn4 contact type	PRO		
DI5.D	DIn5 contact type	PRO		

Note1: When each parameter is displayed, the terminal area (E1 to E4) is displayed on Group display according to the suffix code and optional suffix code. "n" denotes the position of the terminal area. (n = 1 to 4)

Refer to the table below for presence/absence of UT35A contact input.

Terminal area	Suffix code: Type 2		
	0	1	2
E1-terminal area	–	DI11 to DI12	DI11 to DI15

Refer to the table below for presence/absence of UT32A contact input.

Terminal area	Suffix code: Type 2		
	0	1	2
E1-terminal area	–	–	DI11 to DI12

► Terminal arrangement: 17.4 Wiring

12.2 Setting Contact Output Function

12.2.1 Setting Function of Contact Output

Description

The contact output function works by setting a status such as an alarm to the contact output.

This explanation assumes that the contact type is energized. (The contact is turned on when an event occurs.)

Setting Details

Contact Output Equipped as Standard

Parameter symbol	Name	Display level	Setting range	Menu symbol
AL1.S	AL1 function selection	STD	See the following section.	ALM Set
AL2.S	AL2 function selection	STD		
AL3.S	AL3 function selection	STD		

Note1: Nothing is displayed on Group display when each parameter is displayed.

Additional Contact Output

Parameter symbol	Name	Display level	Setting range	Menu symbol
DO1.S	DOn1 function selection	STD	See the following section.	DO Set
DO2.S	DOn2 function selection	STD		
DO3.S	DOn3 function selection	STD		
DO4.S	DOn4 function selection	STD		
DO5.S	DOn5 function selection	STD		

Note1: When each parameter is displayed, the terminal area (E1 to E4) is displayed on Group display according to the suffix code and optional suffix code. "n" denotes the position of the terminal area. (n = 1 to 4)

Contact Output for Control

Parameter symbol	Name	Display level	Setting range	Menu symbol
OR.S	OUT relay function selection	STD	See the following section.	ALM Set
OR2.S	OUT2 relay function selection	STD		

Note1: Nothing is displayed on Group display when each parameter is displayed.

Note2: OR.S and OR2.S can be used as status output when they are not used as control output.
OR2.S can be used for Heating/cooling type.

Alarm Status

The alarm status can be output to the contact output. (The setpoints below are I relay numbers.)

▶ [I relay: UTAdvanced Series Communication Interface \(RS-485, Ethernet\) User's Manual](#)

Setpoint		Function
Alarm status	Alarm output status	
4321	4353	Alarm 1
4322	4354	Alarm 2
4323	4355	Alarm 3
4325	4357	Alarm 4

- Alarm status: The internal alarm status is turned on when an alarm occurs and turned off in normal condition
- Alarm output status: Contact output status when an alarm occurs (ON in alarm condition and OFF in normal condition)

However, the output status depends on the settings of energized/de-energized of alarm, latch action, and contact type.

The above assumes that the contact type is energized. (Then contact is turned on when an event occurs.)

To output the normal alarm to the contact output, assign the alarm output status.

▶ [Alarm action: 11.1 Setting Alarm Type](#)

Alarm Latch Status

The alarm latch status can be output to another contact output irrespective of the setting of alarm-1 to -4 type (AL1 to AL4). (The setpoints below are I relay numbers.)

▶ [I relay: UTAdvanced Series Communication Interface \(RS-485, Ethernet\) User's Manual](#)

Setpoint				Function
Alarm output latch 1 status	Alarm output latch 2 status	Alarm output latch 3 status	Alarm output latch 4 status	
4385	4417	4449	4481	Alarm 1
4386	4418	4450	4482	Alarm 2
4387	4419	4451	4483	Alarm 3
4389	4421	4453	4485	Alarm 4

- Alarm output latch 1, 2, 3, and 4 status: ON in the latch status of the contact output when an alarm occurs and OFF in the latch release status of the contact output in normal condition

However, the output status depends on the settings of contact type.

▶ [Alarm latch action: 11.1 Setting Alarm Type](#)

12.2 Setting Contact Output Function

Key and Display Status

The key and display status can be output to the contact output. (The setpoints below are I relay numbers.)

Setpoint	Function	Contact status	
		ON	OFF
4705	PARAMETER key	Key is pressed	Key is not pressed
4706	DISPLAY key		
4707	Right arrow key		
4708	Down arrow key		
4709	SET/ENTER key		
4710	Up arrow key		
4711	Left key		
4712	F2 key		
4713	F1 key		
4714	A/M key		
4715	Fn key		

Operation Mode and Status

Setpoint	Function	Contact status	
		ON	OFF
4193	AUTO/MAN	MAN	AUTO
4194	Remote/Local	Remote	Local
4195	STOP/RUN	STOP	RUN
4201	Output tracking status	Tracking ON	Tracking OFF
4207	During auto-tuning	During AT	–
4209	During automatic valve adjustment	During adjustment	–
4210	During operation by the valve position estimating type	During operation by estimating type	During operation by feedback input
4213	Valve is open	Open	–
4214	Valve is closed	Closed	–
4256	FAIL output	Normal status	FAIL status

System Error Status

Setpoint	Function	Contact status	
		ON	OFF
4529	Heater break alarm 1 status	Alarm occurs	Normal
4530	Heater break alarm 2 status	Alarm occurs	Normal
4769	Message display interruption 1 status	With interruption	Without interruption
4770	Message display interruption 2 status	With interruption	Without interruption
4771	Message display interruption 3 status	With interruption	Without interruption
4773	Message display interruption 4 status	With interruption	Without interruption
5457	Power ON → Initialization status	During operation	Initializing the system

Error Status

Setpoint	Function	Contact status	
		ON	OFF
4065	PV input ADC error	Error occurs	Normal
4073	PV input burnout error		
4070	PV input RJC error		
4081	Feedback resistance/current burnout		
4082	Automatic valve position adjustment error		
4097	PV input burnout error		
4101	PV input over-scale		
4102	PV input under-scale		
4111	Auto-tuning time out		

System Error Status

Setpoint	Function	Contact status	
		ON	OFF
4001	System data error	Error occurs	Normal
4002	Calibration value error		
4003	User (parameter) default value error		
4005	Setup parameter error		
4006	Operation parameter error		
4017	Corrupted ladder program		
4018	Ladder calculation overflow		
4019	Ladder program error		
4021	Load factor over 100%		
4022	Load factor over 200%		
4009	Faulty FRAM		

12.2.2 Changing Contact Type of Contact Output

Description

The contact type can set the action direction of contact output assigned to the function.

Setting Details

Contact Output Equipped as Standard

Parameter symbol	Name	Display level	Setting range	Menu symbol
AL1.D	AL1 contact type	PRO	0: When the event of assigned function occurs, the contact output is closed. 1: When the event of assigned function occurs, the contact output is opened.	ALM 
AL2.D	AL2 contact type	PRO		
AL3.D	AL3 contact type	PRO		

Note1: Nothing is displayed on Group display when each parameter is displayed.

Additional Contact Output

Parameter symbol	Name	Display level	Setting range	Menu symbol
DO1.D	DOn1 contact type	PRO	0: When the event of assigned function occurs, the contact output is closed. 1: When the event of assigned function occurs, the contact output is opened.	DO 
DO2.D	DOn2 contact type	PRO		
DO3.D	DOn3 contact type	PRO		
DO4.D	DOn4 contact type	PRO		
DO5.D	DOn5 contact type	PRO		

Note1: When each parameter is displayed, the terminal area (E1 to E4) is displayed on Group display according to the suffix code and optional suffix code. "n" denotes the position of the terminal area. (n = 1 to 4)

Refer to the table below for presence/absence of UT35A contact output.

Terminal area	Suffix code: Type 2		
	0	1	2
E1-terminal area	–	DO11 to DO12	–
E4-terminal area	–	–	DO41 to DO45

Refer to the table below for presence/absence of UT32A contact output.

Terminal area	Suffix code: Type 2		
	0	1	2
E1-terminal area	–	–	DO11 to DO12

Contact Output for Control

Parameter symbol	Name	Display level	Setting range	Menu symbol
OR.D	OUT relay contact type	PRO	0: When the event of assigned function occurs, the contact output is closed. 1: When the event of assigned function occurs, the contact output is opened.	ALM 
OR2.D	OUT2 relay contact type	PRO		

Note1: Nothing is displayed on Group display when each parameter is displayed.

Note2: OR.D and OR2.D can be used as status output when they are not used as control output.
OR2.D can be used for Heating/cooling type.

- ▶ Terminal arrangement: [17.4 Wiring](#)
- ▶ Contact type of Heater break alarm output: [11.7 Setting Heater Break Alarm](#)

13.1 Setting Display Functions

13.1.1 Setting Active Color PV Display Function

The active color PV display function changes the PV display color when an event occurs.

Description

Link to Alarm

The PV display color changes by linking to the alarm 1 or alarm 2.

The following is an example of operation linking to alarm 1.

Set the alarm-1 type to "PV high limit alarm" and alarm-1 setpoint to "80°C."

When the active color PV display switch is set to "2," PV display color changes from white to red if PV exceeds the alarm-1 setpoint.

The red-to-white switching action can be set.

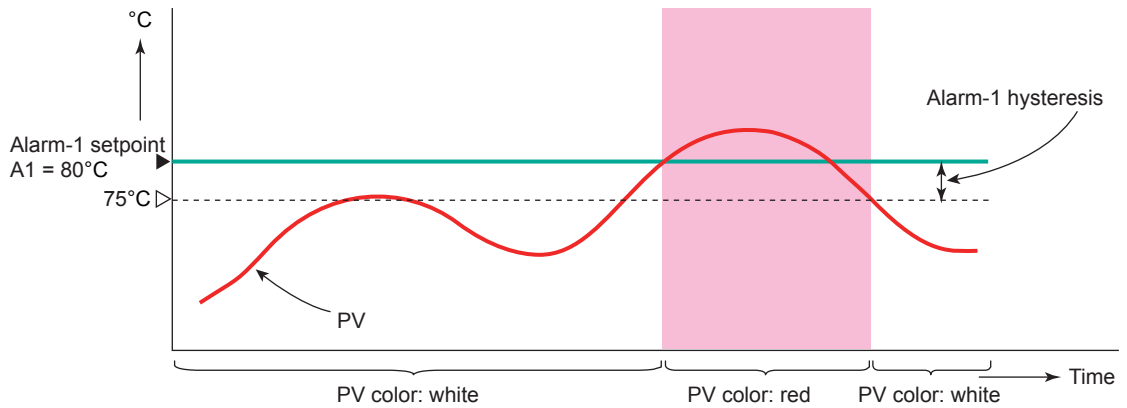

Change by Deviation

The PV display color changes by deviation (PV – SP).

Set the PV color change high limit to "10°C" and the PV color change low limit to "5°C" as deviation band for the current target setpoint "50°C." PV display color changes from white to red if PV is out of the deviation.

The red-to-white switching action can be set. There is no hysteresis.

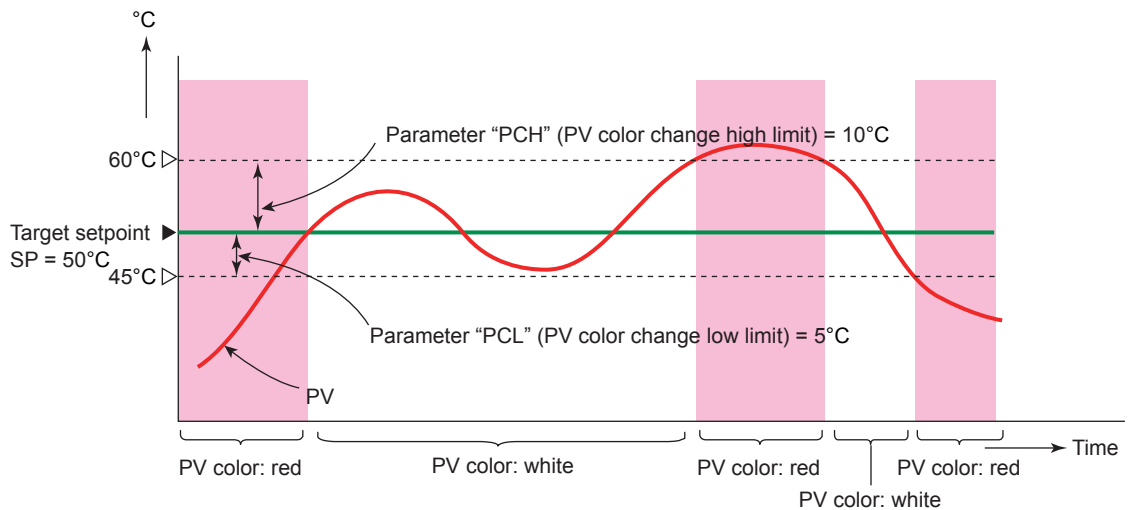

13.1 Setting Display Functions

Link to PV

The PV display color changes by linking to PV.

Set the PV color change high limit to "70°C" and the PV color change low limit to "20°C."
PV display color changes from white to red if PV is out of the range.
The red-to-white switching action can be set. There is no hysteresis.

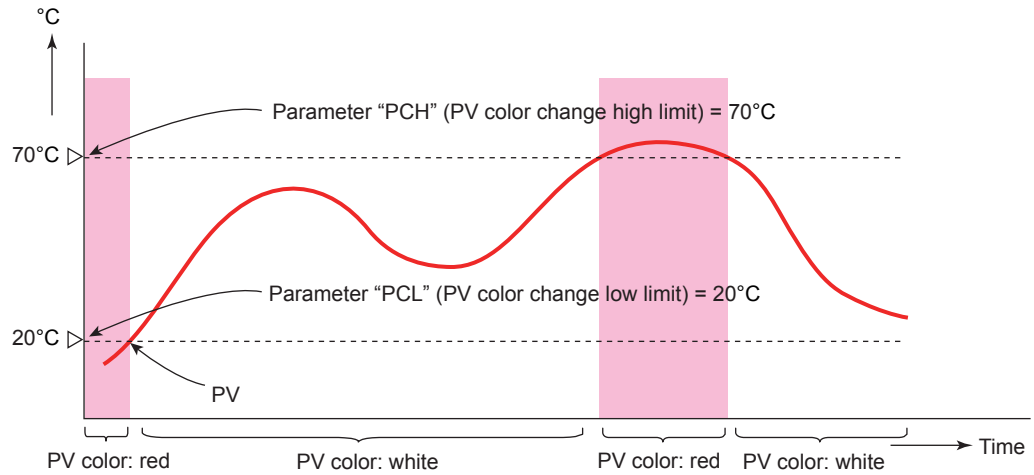

Use in Fixed Color

PV display color can be fixed in red. It can also be fixed in white.

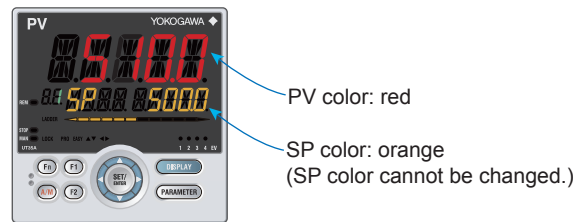

Setting Details

Parameter symbol	Name	Display level	Setting range	Menu symbol
PCMD	Active color PV display switch	EASY	0: Fixed in white 1: Fixed in red 2: Link to alarm 1 (Alarm OFF: white, Alarm ON: red) 3: Link to alarm 1 (Alarm OFF: red, Alarm ON: white) 4: Link to alarm 1 or 2 (Alarm OFF: white, Alarm ON: red) 5: Link to alarm 1 or 2 (Alarm OFF: red, Alarm ON: white) 6: PV limit (Within range: white, Out of range: red) 7: PV limit (Within range: red, Out of range: white) 8: SP deviation (Within deviation: white, Out of deviation: red) 9: SP deviation (Within deviation: red, Out of deviation: white)	DISP Set
PCH	PV color change high limit	EASY	Set a display value when in PV limit or SP deviation.	
PCL	PV color change low limit	EASY	-19999 to 30000 (Set a value within the input range.) Decimal point position depends on the input type.	

13.1 Setting Display Functions

13.1.2 Masking Arbitrary Display Value in Operation Display

Description

Display/non-display of the PV display, Setpoint display, and Status display in the Operation Display can be set.

Items that you do not want to display can be set to non-display. For example, when the Setpoint display is set to non-display, SP of the SP Display and OUT of the OUT Display are not displayed.

When an error at power-on or hardware malfunction error occurs, Operation display cannot be set to non-display.

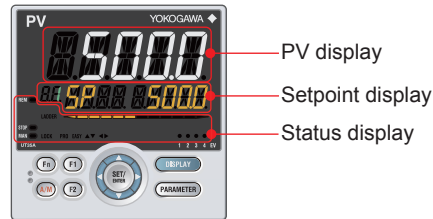

Setting Details

Parameter symbol	Name	Display level	Setting range	Menu symbol
PV.D	PV display area ON/OFF	PRO	OFF: Nondisplay ON: Display	DISP Set
SP.D	Setpoint display area ON/OFF	PRO		
STS.D	Status display area ON/OFF	PRO		

13.1.3 Registering SELECT Display (Up to 5 Displays)

Description

Registering frequently changed-operation parameters (except for the operation mode) in the SELECT Display of the Operation Displays will allow you to change parameter settings easily. A maximum of five Displays can be registered.

Set the D register number of the parameter you wish to register for the registration to the SELECT Display.

However, the parameters in the following menu cannot be set:
 CTL, PV, MPV, OUT, HBA, R485, ETHR, PROF, KEY, DISP, CSEL, KLOC, MLOC, DI.SL, DI.NU, DI.D, ALM, DO, I/O, SYS, INIT, VER, and LVL.

When each parameter is displayed, the terminal area (E1 to E4) is displayed on Group display according to the suffix code and optional suffix code.

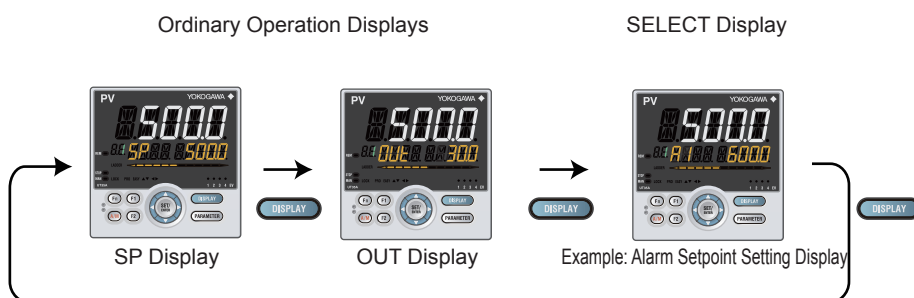

Setting Details

Parameter symbol	Name	Display level	Setting range	Menu symbol
CS1 to CS5	SELECT Display-1 to -5 registration	STD	OFF: No registration D register number (2301 to 5000)	CSEL Set

For D register numbers, see sections 8.4.2 and 8.4.5 in the UTAdvanced Series Communication Interface User's Manual.

D Resistor Number	Category	Description	Reference in Communication Interface User's Manual
2301 to 2500	Operation Mode Parameters	Operation Mode	Section 8.4.2
2501 to 2700	Operation Parameters	SP and alarm setpoint setting	Section 8.4.3
2701 to 2800		SP-related settings	
2801 to 2900		Alarm function settings	
2901 to 3000		PV-related settings	
3001 to 3500		PID settings	
3501 to 3600	P Parameters	Control action-related settings	Section 8.4.5
4701 to 4800		P parameters	

13.1 Setting Display Functions

13.1.4 Changing Event Display

Description

The UT35A/UT32A has four event (EV) lamps.
The alarms 1 to 4 are assigned to EV1 to EV4.

Setting Details

Parameter symbol	Name	Display level	Setting range	Menu symbol
EV1 to EV4	EV1 to EV4 display condition registration	PRO	Setting range: 4001 to 6304 OFF: Disable 4321: Link to alarm 1 (Lit when the alarm occurs) 4322: Link to alarm 2 (Lit when the alarm occurs) 4323: Link to alarm 3 (Lit when the alarm occurs) 4325: Link to alarm 4 (Lit when the alarm occurs) 4529: Heater break alarm 1 (Lit when the alarm occurs) 4530: Heater break alarm 2 (Lit when the alarm occurs) 5025 to 5026: Link to DI1-DI2 (Lit when the contact is closed) 5041 to 5045: Link to DI11-DI15 (E1-terminal area) (Lit when the contact is closed) 5153 to 5155: Link to AL1-AL3 (Lit when the contact is closed) 5169 to 5173: Link to DO11-DO12 (E1-terminal area) (Lit when the contact is closed) 5217 to 5221: Link to DO41-DO45 (E4-terminal area) (Lit when the contact is closed) For other functions, see the UTAdvanced Series Communication Interface User's Manual.	DISP Set

Relay Number	Description	Reference in Communication Interface User's Manual
4001 to 4064	System error	Section 9.3.1
4065 to 4128	Input error	
4129 to 4192	Free area	
4193 to 4256	Operation mode	
4257 to 4320	Free area	
4321 to 4384	Alarm	
4385 to 4528	Alarm latch	
4529 to 4576	Heater break alarm	
4577 to 4640	SP number and PID number	
4641 to 4704	Free area	
4705 to 4768	Key	
4769 to 4832	Display	
4833 to 5024	Free area	
5025 to 5152	Input relay	
5153 to 5280	Output relay	
5281 to 5408	Control computation output	
5409 to 5472	Special relay	
5473 to 5536	Free area	
5537 to 5792	Internal relay	
5793 to 6048	Free area	Section 9.3.3
6305 to 6432	DI terminals	
6433 to 6560	DO terminals	

13.1.5 Registering SELECT Parameter Display (Up to 10 Displays)

Description

Registering frequently changed operation parameters (change frequency is lower than SELECT Display) in the SELECT Parameter Display will allow you to change parameter settings easily. A maximum of ten Displays can be registered.

Set the D register number of the parameter you wish to register for the registration to the SELECT Parameter Display.

However, the parameters in the following menus cannot be set:

CTL, PV, MPV, OUT, HBA, R485, ETHR, PROF, KEY, DISP, CSEL, KLOC, MLOC, DI.SL, DI.NU, DI.D, ALM, DO, I/O, SYS, INIT, VER, and LVL.

When each parameter is displayed, the terminal area (E1 to E4) is displayed on Group display according to the suffix code and optional suffix code.

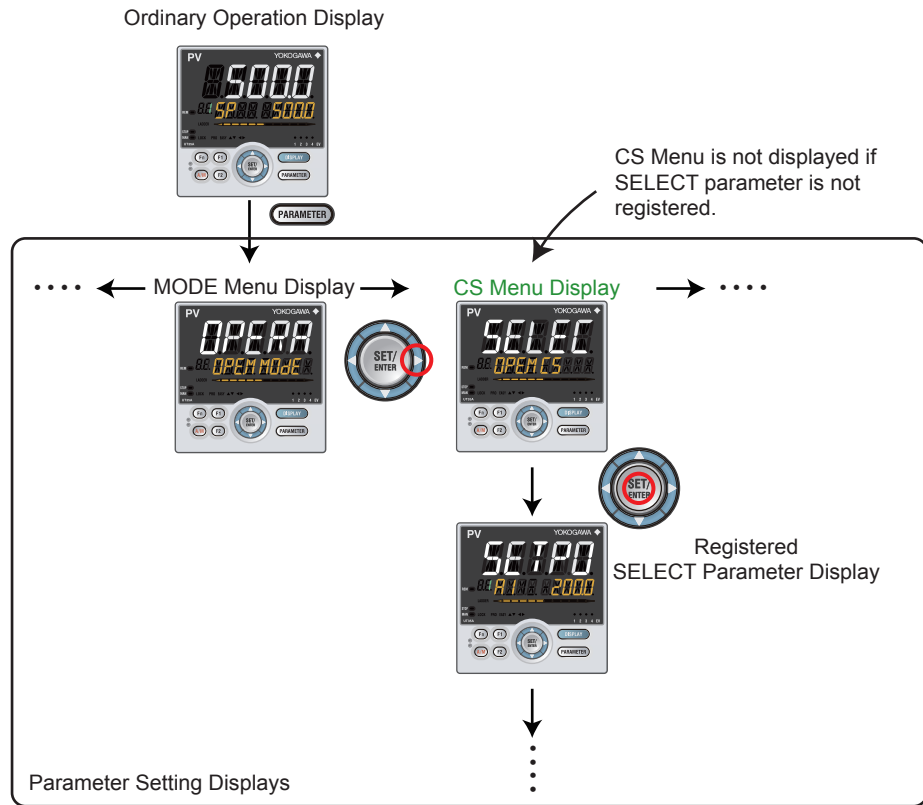

Setting Details

Parameter symbol	Name	Display level	Setting range	Menu symbol
CS10 to CS19	SELECT parameter-10 to -19 registration	PRO	OFF: No registration D register number (2301 to 5000)	CSEL Set

For D register numbers, see sections 8.4.2 and 8.4.5 of UTAdvanced Series Communication Interface User's Manual.

D Resistor Number	Category	Description	Reference in Communication Interface User's Manual
2301 to 2500	Operation Mode Parameters	Operation Mode	Section 8.4.2
2501 to 2700	Operation Parameters	SPs and alarm setpoints setting	Section 8.4.3
2701 to 2800		SP-related settings	
2801 to 2900		Alarm function settings	
2901 to 3000		PV-related settings	
3001 to 3500		PID settings	
3501 to 3600		Control action-related settings	
4701 to 4800	P Parameters	P parameters	Section 8.4.5

13.1.6 Setting Bar-graph Display Function

Description

The bar-graph display is provided on the front of the controller. PV or OUT can be displayed. Data which can be displayed on Bar-graph display are as follows.

OUT, Output

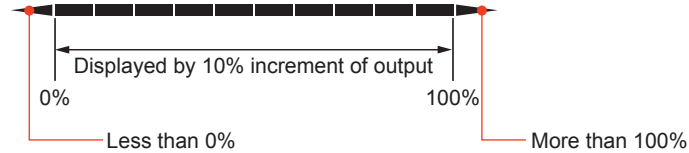

For relay, OFF is equivalent to 0% and ON is equivalent to 100%.

PV, SP

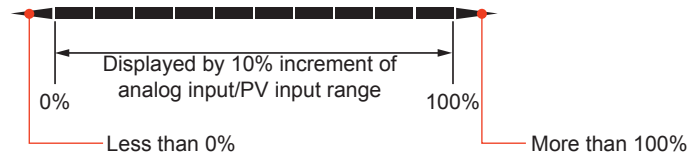

Deviation

When the deviation display band (BDV) is 10%:

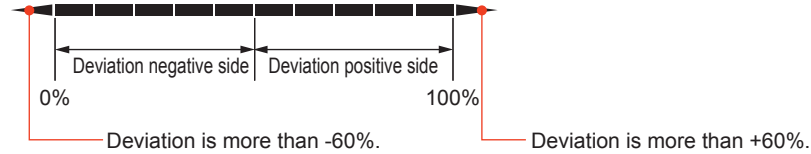

Deviation negative side and deviation positive side are displayed by 10% increment of deviation. Indication is unlit when $SP - (\text{deviation display band (BDV)}) \leq PV \leq SP + (\text{deviation display band (BDV)})$.

IN = TC Type K -270.0 to 1370.0°C
 BDV = 82°C (5%), SP = 500.0°C, PV = 800.0°C

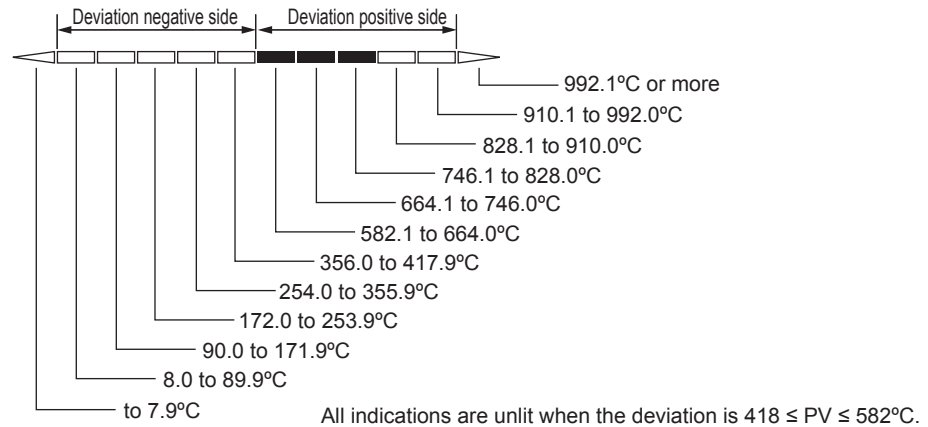

Valve Opening

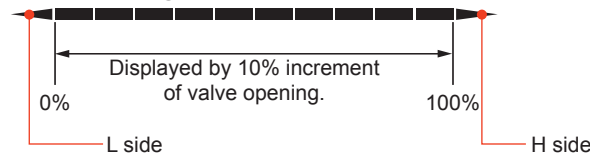

Setting Details

Parameter symbol	Name	Display level	Setting range	Menu symbol
BAR1	Bar-graph display registration	STD	0: Disable 1:OUT, Heating-side OUT, Internal value in Position proportional control 2: Cooling-side OUT 3: PV 4: SP 5: Deviation 6 to 16: Disable 17: Feedback input (valve opening) 18: PV terminals analog input	DISP Set
BDV	Bar-graph deviation display band	STD	0.0 to 100.0% of PV input range span (EUS)	

Note1: The bar-graph deviation display band (BDV) is enabled when the deviation is set to the BAR1.

13.1 Setting Display Functions

13.1.7 Masking Least Significant Digit of PV Display

Description

With and without least significant digit of the PV in the Operation Display can be set. When without least significant digit is set, the value of the least significant digit is truncated and not displayed.

The internal value is not changed depending on whether with or without least significant digit (the value is for display only). This parameter does not function for the PV without decimal point.

Least significant digit is displayed.

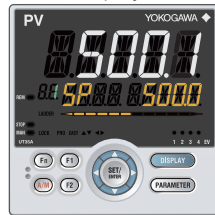

Least significant digit is not displayed.



The following shows the example of with and without least significant digit

PV display	
With least significant digit	Without least significant digit
1.4999	1.499
1.5000	1.500
1.9999	1.999
2.0000	2.000
3000.0	3000
3000.9	3000
3001.0	3001

Setting Details

Parameter symbol	Name	Display level	Setting range	Menu symbol
MLSD	Least significant digital mask of PV display	STD	OFF: With least significant digit ON: Without least significant digit	DISP Set

13.1.8 Setting Economy Mode

Description

The LCD backlight ON/OFF can be set in the following methods.
Setting the LCD backlight to OFF saves energy.

User Function Keys

The LCD backlight ON/OFF switch can be assigned to the user function key.

- ▶ [User function key: 13.2 Assigning Function to User Function Key and A/M Key](#)

Backlight OFF timer

The backlight OFF timer sets the economy mode parameter to ON.

If no keys are pressed for 30 minutes, the LCD backlight goes off automatically.

The backlight OFF can be set to turn off the backlight for the whole display or a display other than the PV display.

To turn on the LCD backlight, press any key.

Contact Input

The LCD backlight ON/OFF switch can be assigned to the contact input

- ▶ [Contact input: 12.1 Setting Contact Input Function](#)

In the following cases, the LCD backlight does not go off.

- when an alarm occurs
- When an error at power-on or a hardware malfunction error occurs

Setting Details

Parameter symbol	Name	Display level	Setting range	Menu symbol
ECO	Economy mode	STD	OFF: Disable 1: Economy mode ON (All indications except PV display OFF) 2: Economy mode ON (All indications OFF) 3: Brightness 10 % (all indications)	DISP 

13.1 Setting Display Functions

13.1.9 Selecting the Initial Operation Display that Appears at Power ON

Description

The initial Operation Display that appears when the power is turned on can be set.

Setting Details

Parameter symbol	Name	Display level	Setting range	Menu symbol
HOME	Home Operation Display setting	PRO	SP1: SP Display OUT1: OUT Display HCO: Heating/cooling OUT Display VP: Valve Position Display MV: Position Proportional Computation Output Display PID1: PID Number Display HC1: Heater Break Alarm-1 Current Display HC2: Heater Break Alarm-2 Current Display PV: PV Analog Input Display CS1 to CS5: SELECT Display 1 to 5	DISP Set

13.1.10 Setting Message Function

Description

Using the message function and turning the contact input on/off, the message registered beforehand can be displayed on PV display by interrupt.

The message is registered using LL50A Parameter Setting Software.

The messages are limited to 20 alphanumeric characters. A maximum of four messages can be registered.

If a number of messages occur simultaneously, the priority is as follows:

(high) MG1>MG2>MG3>MG4 (low)

▶ Message registration: [LL50A Parameter Setting Software User's Manual](#)

▶ Registration of contact input: [12.1.1 Setting Contact Input Function](#)

▶ Registration symbols: [3.3 List of Display Symbols](#)

Operation Display

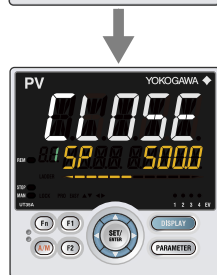

When the contact input is turned on, the scrolling message registered beforehand is displayed on PV Display.

13.1.11 Switching Guide Display Language

Description

The guide display language that appears when the parameter or the menu is displayed can be switched.

Setting Details

Parameter symbol	Name	Display level	Setting range	Menu symbol
LANG	Guide display language	EASY	ENG: English FRA: French GER: German SPA: Spanish	SYS Set

13.1 Setting Display Functions

13.1.12 Changing Guide Scroll Speed

Description

The scroll speed can be changed when the guide for the parameter or menu is displayed.

Setting Details

Parameter symbol	Name	Display level	Setting range	Menu symbol
SPD	Scroll speed	PRO	(Slow) 1 to 8 (Quick)	DISP Set

13.1.13 Turning Guide Display ON/OFF

Description

The guide display that appears when the parameter or the menu is displayed can be switched.

The guide display can be turned on and off by the Fn key in the Menu Display and Parameter Setting Display.

Setting Details

Parameter symbol	Name	Display level	Setting range	Menu symbol
GUID	Guide display ON/OFF	STD	OFF: Nondisplay ON: Display	DISP Set

13.1.14 Setting Automatic Return to Operation Display

Description

The Display will automatically revert to the Operation Display if no keys are pressed for 5 minutes in Menu Display or Parameter Setting Display.

Setting Details

Parameter symbol	Name	Display level	Setting range	Menu symbol
OP.JP	Automatic return to Operation Display	PRO	ON: Automatically returned to the Operation Display. OFF: Not automatically returned to the Operation Display.	DISP Set

13.1.15 Setting Brightness and Contrast Adjustment of LCD and Display Update Cycle

Description

The brightness and contrast for PV, Setpoint, Bar-graph, and Status indicator can be adjusted.

Brightness ranges for each display can be set.

The LCD has a characteristic that the display action becomes late at the low temperature.

This can be solved by adjusting the display update cycle (D.CYC).

Setting Details

Parameter symbol	Name	Display level	Setting range	Menu symbol
BRI	Brightness	EASY	(Dark) 1 to 5 (Bright)	DISP 
B.PVW	White brightness adjustment of PV display	PRO	Adjusts the white brightness of PV display. (Dark) -4 to 4 (Bright)	
B.PVR	Red brightness adjustment of PV display	PRO	Adjusts the red brightness of PV display. (Dark) -4 to 4 (Bright)	
B.SP	Brightness adjustment of Setpoint display	PRO	Adjusts the brightness of SP display. (Dark) -4 to 4 (Bright)	
B.BAR	Brightness adjustment of Bar-graph display	PRO	Adjusts the brightness of SP display. (Dark) -4 to 4 (Bright)	
B.STS	Brightness adjustment of Status indicator	PRO	Adjusts the brightness of Status indicator. (Dark) -4 to 4 (Bright)	
CTRS	Contrast	PRO	(Low) 1 to 6 (High)	
D.CYC	Display update cycle	PRO	1: 100 ms 2: 200 ms 3: 500 ms 4: 1 s 5: 2 s	

13.2 Assigning Function to User Function Key and A/M Key

Description

The UT35A has three user function keys on the front panel. The UT32A has one user function key.

Various functions (operation mode switch etc.) can be assigned to the user function key. Press the user function key to perform the assigned function.

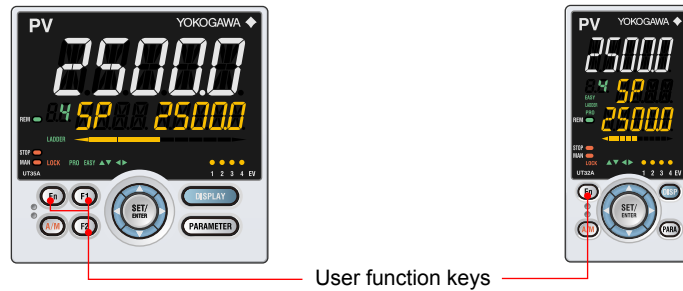

13.2 Assigning Function to User Function Key and A/M Key

Setting Details

Parameter symbol	Name	Display level	Setting range	Menu symbol
F1 to Fn	User function key action setting	EASY	See the table below	KEY 
A/M	A/M key action setting	PRO		

Setpoint	Function	Action	Availability (Note 1)			
			F1	F2	Fn	A/M
OFF	Unassigned	–	√	√	√	√
A/M	AUTO/MAN switch	AUTO and MAN switches every time the user function key is pressed.	√	√	√	√√
R/L1	REM/LCL switch	Remote and Local switches every time the user function key is pressed. (Displayed only in cases where the communication is specified.)	√	√	√	√
S/R	STOP/RUN switch	STOP and START switches every time the user function key is pressed. (Note 2)	√	√	√	√
AUTO	Switch to AUTO	Pressing the user function key switches to AUTO.	√	√	√	√
MAN	Switch to MAN	Pressing the user function key switches to MAN.	√	√	√	√
REM1	Switch to REM	Pressing the user function key switches to Remote. (Displayed only in cases where the communication is specified.)	√	√	√	–
LCL1	Switch to LCL	Pressing the user function key switches to Local. (Displayed only in cases where the communication is specified.)	√	√	√	–
STOP	Switch to STOP	Pressing the user function key stops the operation.	√	√	√	–
RUN	Switch to RUN	Pressing the user function key starts the operation.	√	√	√	–
AT	Auto-tuning	Pressing the user function key executes auto-tuning	√	√	√	–
LTUP	LCD brightness UP	The current brightness gradually increases every time the function key is pressed.	√	√	√	–
LTDN	LCD brightness DOWN	The current brightness gradually decreases every time the function key is pressed.	√	√	√	–
BRI	Adjust LCD brightness	The current brightness gradually increases every time the function key is pressed. Pressing the function key after reaching the maximum brightness changes to the minimum brightness. Thereafter, minimum brightness→maximum brightness→maximum brightness is repeated.	√	√	√	–
LCD	LCD Backlight ON/OFF switch	The LCD backlight turns on and off every time the user function key is pressed.	√	√	√	–
LAT	Latch release	Latch 1 to latch 4 are released every time the user function key is pressed.	√	√	√	–
PID	PID Tuning switch	Pressing the function key during operation displays the first parameter (proportional band) of the currently selected PID parameter group and enables the setting to be changed. As with the operation to change the parameter setpoint, the sequence is P→I→D→...→P→... Pressing the function key again, or pressing the DISPLAY key or DISP key returns to the initial Operation Display. The PARAMETER key or PARA key does not switch to the Menu Display.	√	√	√√	–

Note 1: √ indicates available, – indicates unavailable, and √√ indicates initial value.

Note 2: When the STOP/RUN switch is set to the contact input, the setpoint S/R does not work for the user function key. Disable the setting if the STOP/RUN switch parameter (S/R) is assigned to the contact input.

13.2 Assigning Function to User Function Key and A/M Key

Status of user function key

The status of the user function key can be identified by communication.

“1” can be read while the user function key is held down, and “0” can be read when the user function key is released. (Initial value: 0)

▶ [Reading via communication: UTAdvanced Series Communication Interface User's Manual](#)

Fn key operation in the Parameter Setting Display

In the Menu Display and Parameter Setting Display, the guide is displayed on PV display. At this time, use the Fn key to turn on and off the guide display on PV display. A measured input value (PV) is displayed in the ON state.

13.3 Setting Security Functions

13.3.1 Setting a Password

Description

The password function can prevent inadvertent changes to the parameter settings. If a password is set, the checking is required when moving to the Setup Parameter Setting Display. When the password is verified, can be changed to the Setup Parameter Setting Display. The parameters in the following menu can be set only when the password is verified.

CTL, PV, MPV, OUT, HBA, R485, ETHR, PROF, KEY, DISP, CSEL, KLOC, MLOC, DI.SL, DI.NU, DI.D, ALM, DO, I/O, SYS, INIT, VER, and LVL.

When each parameter is displayed, the terminal area (E1 to E4) is displayed on Group display according to the suffix code and optional suffix code.

Always remember your password when using the password function.

Setting Details

Parameter symbol	Name	Display level	Setting range	Menu symbol
PASS	Password setting	EASY	0 (No password) to 65535	SYS Set

13.3.2 Setting Parameter Display Level

Description

Parameter display level can be set according to the setting level.

▶ [Parameter display level: Chapter 18 Parameters](#)

Setting Details

Parameter symbol	Name	Display level	Setting range	Menu symbol
LEVL	Parameter display level	EASY	EASY: Easy setting mode STD: Standard setting mode PRO: Professional setting mode	LVL Set

13.3.3 Locking (Hiding) Parameter Menu Display

Description

The parameter menu display lock function hides the following Parameter Menu Displays.

Setting Details

Parameter symbol	Name	Display level	Setting range	Menu symbol
CTL	[CTL] menu lock	PRO	OFF: Display ON: Nondisplay	MLOC Set
PV	[PV] menu lock	PRO		
MPV	[MPV] menu lock	PRO		
OUT	[OUT] menu lock	PRO		
HBA	[HBA] menu lock	PRO		
R485	[R485] menu lock	PRO		
ETHR	[ETHR] menu lock	PRO		
PROF	[PROF] menu lock	PRO		
KEY	[KEY] menu lock	PRO		
DISP	[DISP] menu lock	PRO		
CSEL	[CSEL] menu lock	PRO		
KLOC	[KLOC] menu lock	PRO		
DI.SL	[DI.SL] menu lock	PRO		
DI.NU	[DI.NU] menu lock	PRO		
DI.D	[DI.D] menu lock	PRO		
ALM	[ALM] menu lock	PRO		
DO	[DO] menu lock	PRO		
I/O	[I/O] menu lock	PRO		
SYS	[SYS] menu lock	PRO		
INIT	[INIT] menu lock	PRO		
VER	[VER] menu lock	PRO		
LVL	[LVL] menu lock	PRO		
MODE	[MODE] menu lock	PRO	OFF: Display ON: Nondisplay	MLOC Set
CS	[CS] menu lock	PRO		
SP	[SP] menu lock	PRO		
SPS	[SPS] menu lock	PRO		
ALRM	[ALRM] menu lock	PRO		
PVS	[PVS] menu lock	PRO		
PID	[PID] menu lock	PRO		
TUNE	[TUNE] menu lock	PRO		
ZONE	[ZONE] menu lock	PRO		
PPAR	[PPAR] menu lock	PRO		

Note1: When each parameter is displayed, the terminal area (E1 to E4) is displayed on Group display according to the suffix code and optional suffix code.

13.3.4 Key Lock

Description

The key lock function locks the key on the front panel to prohibit key operation. It can prohibit the operation mode switch or parameter setting change.

Setting Details

Parameter symbol	Name	Display level	Setting range	Menu symbol
DATA	Front panel parameter data key lock	STD	OFF: Unlock ON: Lock	KLOCK 
A/M	Front panel A/M key lock	STD		

13.3.5 Setting Display/Non-display of Operation Display

Description

Display/non-display of the Operation Display can be set.

▶ [Operation Display: Chapter 6 Monitoring and Control of Regular Operations](#)

Setting Details

Parameter symbol	Name	Display level	Setting range	Menu symbol
U.SP	SP Display lock	PRO	OFF: Display ON: Nondisplay	KLOC 
U.OUT	OUT Display lock	PRO		
U.HCO	Heating/cooling OUT Display lock	PRO		
U.VP	Valve Position Display lock	PRO		
U.MV	Position Proportional Computation Output Display lock	PRO		
U.PID	PID Number Display lock	PRO		
U.HC	Heater Break Alarm Current Value Display lock	PRO		
U.PV	PV Analog Input Display lock	PRO		

13.3.6 Prohibiting Writing via Communication

Description

Writing data to each register via all communication methods can be permitted or prohibited. However, writing data via light-loader (front) or maintenance port (upper) is possible using LL50A Parameter Setting Software.

Setting Details

Parameter symbol	Name	Display level	Setting range	Menu symbol
COM.W	Communication write enable/disable	STD	OFF: Enable ON: Disable	KLOC 

Displayed only in cases where the communication is specified.

13.4 Confirmation of Key and I/O Condition and Version

13.4.1 Confirmation of Key and I/O Condition

Description

Can be confirm the Key and I/O condition.

Setting Details

Parameter symbol	Name	Display level	Setting range	Menu symbol
KEY	Key status	PRO	Read only.	I/O Set
X000	DI1-DI2 status (equipped as standard)	PRO		
X100	DI11-DI15 status (E1-terminal area)	PRO		
Y000	AL1-AL3 status (equipped as standard)	PRO		
Y100	DO11-DO12 status (E1-terminal area)	PRO		
Y400	DO41-DO45 status (E4-terminal area)	PRO		

Note: When each parameter is displayed, the terminal area (E1 to E4) is displayed on Group display according to the suffix code and optional suffix code.

Key confirmation parameters are displayed in hexadecimal.

When the error occurs, "1" is set on the bit of corresponding error, and the bit data is displayed in hexadecimal.

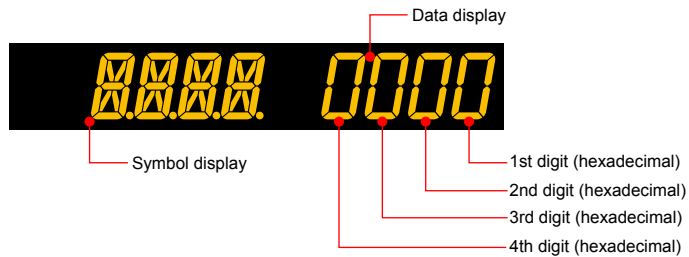

13.4 Confirmation of Key and I/O Condition and Version

Parameter KEY

Displayed digit	bit	Description
1st digit	0	PARAMETER (or PARA) key (0: OFF, 1: ON)
	1	DISPLAY (or DISP) key (0: OFF, 1: ON)
	2	RIGHT arrow key (0: OFF, 1: ON)
	3	DOWN arrow key (0: OFF, 1: ON)
2nd digit	4	SET/ENTER key (0: OFF, 1: ON)
	5	UP arrow key (0: OFF, 1: ON)
	6	LEFT arrow key (0: OFF, 1: ON)
	7	F2 key (0: OFF, 1: ON)
3rd digit	8	F1 key (0: OFF, 1: ON)
	9	A/M key (0: OFF, 1: ON)
	10	Fn key (0: OFF, 1: ON)
	11	–
4th digit	12	–
	13	–
	14	–
	15	–

Parameter X000

Displayed digit	bit	Description
1st digit	0	DI1 status (0: OFF, 1: ON)
	1	DI2 status (0: OFF, 1: ON)
	2	–
	3	–
2nd digit	4	–
	5	–
	6	–
	7	–
3rd digit	8	–
	9	–
	10	–
	11	–
4th digit	12	–
	13	–
	14	–
	15	–

Parameter X100

Displayed digit	bit	Description
1st digit	0	DI11 status (0: OFF, 1: ON)
	1	DI12 status (0: OFF, 1: ON)
	2	DI13 status (0: OFF, 1: ON)
	3	DI14 status (0: OFF, 1: ON)
2nd digit	4	DI15 status (0: OFF, 1: ON)
	5	–
	6	–
	7	–
3rd digit	8	–
	9	–
	10	–
	11	–
4th digit	12	–
	13	–
	14	–
	15	–

Parameter Y000

Displayed digit	bit	Description
1st digit	0	AL1 status (0: OFF, 1: ON)
	1	AL2 status (0: OFF, 1: ON)
	2	AL3 status (0: OFF, 1: ON)
	3	–
2nd digit	4	–
	5	–
	6	–
	7	–
3rd digit	8	–
	9	–
	10	–
4th digit	11	–
	12	–
	13	–
	14	–
	15	–

Parameter Y100

Displayed digit	bit	Description
1st digit	0	DO11 status (0: OFF, 1: ON)
	1	DO12 status (0: OFF, 1: ON)
	2	–
	3	–
2nd digit	4	–
	5	–
	6	–
	7	–
3rd digit	8	–
	9	–
	10	–
4th digit	11	–
	12	–
	13	–
	14	–
	15	–

Parameter Y400

Displayed digit	bit	Description
1st digit	0	DO41 status (0: OFF, 1: ON)
	1	DO42 status (0: OFF, 1: ON)
	2	DO43 status (0: OFF, 1: ON)
	3	DO44 status (0: OFF, 1: ON)
2nd digit	4	DO45 status (0: OFF, 1: ON)
	5	–
	6	–
	7	–
3rd digit	8	–
	9	–
	10	–
4th digit	11	–
	12	–
	13	–
	14	–
	15	–

13.4 Confirmation of Key and I/O Condition and Version

13.4.2 Confirmation of Version

Description

Can be confirm the version of the controller.

Setting Details

Parameter symbol	Name	Display level	Setting range	Menu symbol
MCU	MCU version	EASY	Read only.	VER Set
DCU	DCU version	EASY		
ECU1	ECU-1 version	EASY		
ECU3	ECU-3 version	EASY		
ECU4	ECU-4 version	EASY		
PARA	Parameter version	EASY		
H.VER	Product version	EASY		
SER1	Serial number 1	EASY		
SER2	Serial number 2	EASY		
MAC1	MAC address 1	EASY		
MAC2	MAC address 2	EASY		
MAC3	MAC address 3	EASY		

14.1 Initializing Parameter Settings to Factory Default Values

Description

Parameter settings can be initialized to the factory default values. The ladder program is also initialized to the factory default. Use the key or LL50A Parameter Setting Software to execute it.

Note

The user setting values (defaults) are not initialized even if the parameter setting values are initialized to the factory default values.

Setting Details

Parameter symbol	Name	Display level	Setting range	Menu symbol
F.DEF	Initialization to factory default value	PRO	-12345: Initialization, automatically returned to "0" after initialization.	INIT Set

14.2 Registering and Initializing User Default Values

14.2.1 Registering as User Setting (Default) Values

Description

The user default values can be registered as parameter default values.
The ladder program can not be registered as user default values.
Use the LL50A Parameter Setting Software to register user setting (default) values.

CAUTION

Before registering the user default value, make sure that the user setting value is set to the parameter.

14.2.2 Initializing to User Setting (Default) Values

Description

Parameter settings can be initialized to the user setting (default) values.
The ladder program is not initialized to the factory default.
Use the LL50A Parameter Setting Software to execute it.

Setting Details

Parameter symbol	Name	Display level	Setting range	Menu symbol
U.DEF	Initialization to user default value	PRO	12345: Initialization, automatically returned to "0" after initialization.	INIT Set

15.1 Remedies if Power Failure Occurs during Operations

Description

The operation status and remedies after a power failure differ with the length of power failure time:

Regardless of the length of power failure time, all functions of the controller cannot be operated for about 10 seconds after recovery. However, the case of instantaneous power failure is excepted.

- 100–240 V AC: Instantaneous power failure of 20 ms or less
- 24 V AC/DC: Instantaneous power failure of 1 ms

A power failure is not detected. Normal operation continues.

- Power failure of about less than 5 seconds

The following shows effects caused in “settings” and “operation status.”

Alarm action	Does not continue. Alarm with stand-by function will enter stand-by status. Alarm latch will be initialized.
Setting parameter	Set contents of each parameter are retained.
Auto-tuning	Cancelled.
Control action	Action before power failure continues.
Timer, counter (ladder program)	Initialized.

- Power failure of about 5 seconds or more

The following shows effects caused in “settings” and “operation status.”

Alarm action	Does not continue. Alarm with stand-by function will enter stand-by status. Alarm latch will be initialized.								
Setting parameter	Set contents of each parameter are retained.								
Auto-tuning	Cancelled.								
Control action	Differs with setting of the parameter “R.MD” (restart mode).								
	<table border="1"> <thead> <tr> <th>R.MD setting</th> <th>Control action after recovery from power failure</th> </tr> </thead> <tbody> <tr> <td>CONT</td> <td>Continues action before power failure. (Factory default)</td> </tr> <tr> <td>MAN (*)</td> <td>Outputs the preset output value (PO) of the PID group used as control output and continues action in MAN mode.</td> </tr> <tr> <td>AUTO (*)</td> <td>The control computation is executed in AUTO mode based on the preset output value (PO) of the PID group used as control output.</td> </tr> </tbody> </table>	R.MD setting	Control action after recovery from power failure	CONT	Continues action before power failure. (Factory default)	MAN (*)	Outputs the preset output value (PO) of the PID group used as control output and continues action in MAN mode.	AUTO (*)	The control computation is executed in AUTO mode based on the preset output value (PO) of the PID group used as control output.
	R.MD setting	Control action after recovery from power failure							
CONT	Continues action before power failure. (Factory default)								
MAN (*)	Outputs the preset output value (PO) of the PID group used as control output and continues action in MAN mode.								
AUTO (*)	The control computation is executed in AUTO mode based on the preset output value (PO) of the PID group used as control output.								
* In Heating/cooling control, starts action from 50% of control computation output.									
Timer, counter (ladder program)	Initialized.								

When the controller recovers from power failure except instantaneous power failure, the status of the contact input does not work, whether it is the rising edge (OFF → ON) or the falling edge (ON → OFF.)

Setting Details

Parameter symbol	Name	Display level	Setting range	Menu symbol
R.MD	Restart mode	STD	CONT: Continue action set before power failure. MAN: Start from MAN. AUTO: Start from AUTO.	SYS Set

15.2 Power Frequency Setting

Description

The power frequency can be set by automatic detection or manually. However, when the /DC option is specified, only manual setting is available.

Setting Details

Parameter symbol	Name	Display level	Setting range	Menu symbol
FREQ	Power frequency	EASY	AUTO 60: 60 Hz 50: 50 Hz	SYS Set

16.1 Troubleshooting

16.1.1 Troubleshooting Flowchart

If the Operation Display does not appear after turning on the controller's power, follow the measures in the procedure below.

If a problem appears complicated, contact our sales representative.

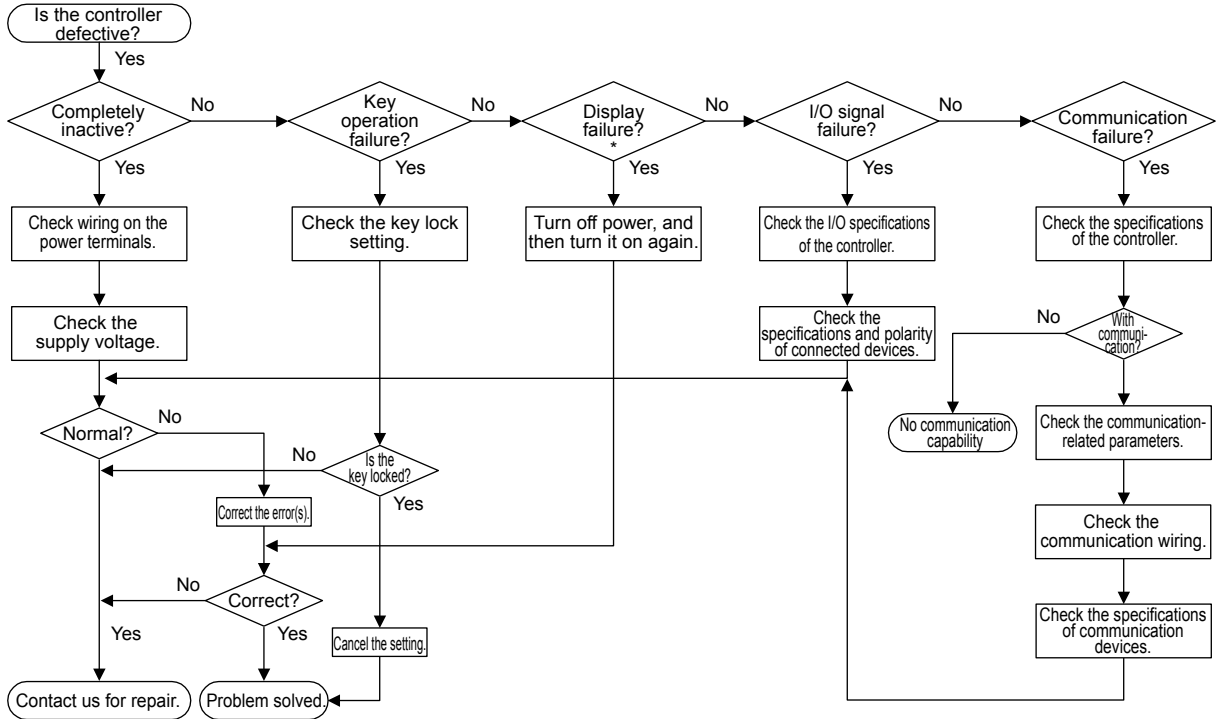

*: The LCD (a liquid crystal display) is used for a display portion of this product. The LCD has a characteristic that the display action becomes late at the low temperature. Additionally, the luminance and contrast degradation are caused due to aged deterioration. However, the control function is not affected.

16.1.2 Errors at Power On

The errors shown below may occur in the fault diagnosis when the power is turned on.

PV display (Operation Display)	Setpoint display (Operation Display)	Status indicator (Operation Display)	Parameter that displays error details	Error description	Cause and diagnosis	Remedy	
Indication off	Indication off	–	–	Faulty MCU RAM / MCU ROM	MCU RAM / MCU ROM are failed.	Faulty. Contact us for repair.	
ERR	SYS -----	–	–	System data error	System data is corrupted.	Faulty. Contact us for repair.	
	PAR 0004 (for user default value error only)			Setup parameter (PA.ER)	User (parameter) default value error	User parameter is corrupted. Initialized to factory default value.	Check and reconfigure the initialized parameters. Error indication is erased when the power is turned on again.
	PAR 0010 (for setup parameter error only)				Setup parameter error	Setup parameter data is corrupted. Initialized to factory default value.	
	PAR 0020 (for operation parameter error only)				Operation parameter error	Operation parameter data is corrupted. Initialized to user default value.	
	PAR 0400			Control parameter (operation mode, output) error	Control parameter data is corrupted. Initialized to user default value.		
SLOT 0015 (0017: Error occurs to all hardware of E1 to E4-terminal areas.)	Setup parameter (OP.ER)	Non responding hardware of extended function (E1 to E4-terminal areas)	Inconsistence of system data and hardware of extended function. Non responding communication between hardware of extended function (E1 to E4-terminal areas).	Faulty. Contact us for repair.			
Normal indication	Normal indication	Rightmost decimal point on PV display blinks.	Setup parameter (PA.ER)	Calibration value error	Initialized to calibrated default value because of corrupted factory default value.	Faulty. Contact us for repair.	
		Right most decimal point on Symbol display blinks.		Faulty FRAM	Writing (storing) data to FRAM is impossible.		
Normal indication	Normal indication	LADDER lamp blinks.	Setup parameter (LA.ER)	Corrupted ladder program	Ladder program is corrupted. Operates without ladder program.	Download the ladder program again.	
Normal indication	0.000 00000 (Decimal point on the left of the Symbol display blinks)	–	Setup parameter (OP.ER)	User profile error (PROFIBUS-DP communication)	User profile is corrupted.	Download the user profile again.	

Errors at Power On (Input/output Action)

Error description	PV input	Ladder calculation	Control computation	Control output	Retransmission output	Alarm action	Analog output (control output, retransmission output)	Voltage pulse output (control output)	Relay output (control output, position proportional output)	Feedback input (for Position proportional type)	Contact input	Contact (alarm) output	Communication
Faulty MCU RAM Faulty MCU ROM	Undefined	Stopped	Stopped	Undefined	Undefined	Stopped	0% or less	OFF	OFF	Undefined	OFF	OFF	Stopped
System data error	Undefined	Stopped	Stopped	Undefined	Undefined	Stopped	0% or less	OFF	OFF	Undefined	OFF	OFF	Normal action
User (parameter) default value error	Normal action	Normal action	Normal action	Normal action	Normal action	Normal action	Normal action	Normal action	Normal action	Normal action	Normal action	Normal action	Normal action
Setup parameter error													
Operation parameter error													
Control parameter error													
Non responding hardware of extended function (E1 to E4-terminal areas)	Undefined	Normal action	Normal action	Normal action	Normal action	Normal action	Normal action	Normal action	Normal action	Normal action	Normal action	Normal action	Normal action
Calibration value error	Normal action (out of accuracy)	Normal action	Normal action	Normal action	Normal action	Normal action	Normal action (out of accuracy)	Normal action	Normal action	Normal action	Normal action	Normal action	Normal action
Faulty FRAM	Normal action						Normal action						
Corrupted ladder program	Normal action	Normal action (without ladder program)	Normal action	Normal action	Normal action	Normal action	Normal action	Normal action	Normal action	Normal action	Normal action	Normal action	Normal action
User profile error (PROFIBUS-DP communication)	Normal action	Normal action (without ladder program)	Normal action	Normal action	Normal action	Normal action	Normal action	Normal action	Normal action	Normal action	Normal action	Normal action	PROFIBUS-DP communication disabled

16.1.3 Errors during Operation

Errors during Operation (1)

The errors shown below may occur during operation.

PV display (Operation Display)	Setpoint display (Operation Display)	Status indicator (Operation Display)	Parameter that displays error details	Error description	Cause and diagnosis	Remedy
AD.ERR	Normal indication (Note)	–	Setup parameter (AD1.E)	Analog input terminal ADC error • PV input	Analog input terminal AD value error	Faulty Contact us for repair.
RJC.E (Displays RJC.E and PV alternately.)	Normal indication (Note)	–	Setup parameter (AD1.E)	Universal input terminal RJC error • PV input	Universal input terminal RJC error	Faulty Contact us for repair. Set the parameter RJC to OFF to erase error indication.
B.OUT	Normal indication (Note)	–	Setup parameter (AD1.E)	Analog input terminal burnout error • PV input	Analog input terminal sensor burnout	Check wiring and sensor. Error indication is erased in normal operation.
			Setup parameter (PV1.E)	PV input burnout error)	Burnout of analog input connected to PV	Check wiring and sensor of connected analog input terminal. Error indication is erased in normal operation.
OVER -OVER	Normal indication	–	Setup parameter (PV1.E)	PV input over-scale PV input under-scale (PV values out of -5 to 105%)	PV input is out of -5 to 105%. Also occurs when the data out of range which is the ladder computation result is input.	Check analog input value or ladder program.

Note: When an error occurs in input shown in Analog input display (Operation display).
Setpoint display shows the same symbol as the PV display.

Errors during Operation (Input/output Action)

Error description	PV input	Ladder calculation	Control computation	Control output	Retransmission output	Alarm action	Analog output (control output, retransmission output)	Voltage pulse output (control output)	Relay output (control output, position proportional output)	Feedback input (for Position proportional type)	Contact input	Contact (alarm) output	Communication
Analog input terminal ADC error • PV input	105%	Normal action	Normal action	When in AUTO and RUN modes: Error preset output	Normal action	Normal action	Normal action	Normal action	Normal action	Normal action	Normal action	Normal action	Normal action
Universal input terminal RJC error • PV input	Normal action (without reference junction compensation)	Normal action	Normal action	Normal action	Normal action	Normal action	Normal action	Normal action	Normal action	Normal action	Normal action	Normal action	Normal action
Analog input terminal burnout error • PV input	Depends on the parameter BSL. Upscale: 105% Downscale: -5%	Normal action	Normal action	When in AUTO and RUN modes: Error preset output	Normal action	Normal action	Normal action	Normal action	Normal action	Normal action	Normal action	Normal action	Normal action
PV input burnout error	Depends on the setting of the parameter BSL. Upscale: 105% Downscale: -5%												
PV input over-scale PV input under-scale (PV values out of -5 to 105%)	Normal action	Normal action	Normal action	Normal action	Normal action	Normal action	Normal action	Normal action	Normal action	Normal action	Normal action	Normal action	Normal action

Errors during Operation (2)

The errors shown below may occur during operation.

PV display (Operation Display)	Setpoint display (Operation Display)	Status indicator (Operation Display)	Parameter that displays error details	Error description	Cause and diagnosis	Remedy
Normal indication	OUT -----	—	Setup parameter (AD2.E)	Feedback input resistor/ current burnout	Feedback input burnout	Check wiring of feedback input resistor/current. Error indication is erased in normal operation.
Normal indication	Normal indication	LADDER lamp blinks	Setup parameter (LA.ER)	Ladder calculation overflow	Floating point computation in ladder calculation is infinite.	Check the ladder program.
				Load factor over 100%	Computation does not end within the control period (load factor is 100% or more).	Change the control period or reduce the number of steps for the ladder program.
				Load factor over 200%. (Forced end)	Computation does not end within the control period (load factor is 200% or more).	Change the control period or reduce the number of steps for the ladder program.
				Ladder program error	Ladder program is corrupted.	Download the ladder program again. If the error indication is still not erased, there is a fault. Contact us for repair.

Errors during operation (Input/output Action)

Error description	PV input	Ladder calculation	Control computation	Control output	Retransmission output	Alarm action	Analog output (control output, retransmission output)	Voltage pulse output (control output)	Relay output (control output, position proportional output)	Feedback input (for Position proportional type)	Contact input	Contact (alarm) output	Communication
Feedback input resistor/current burnout	Normal action	Normal action	Normal action	Normal action	Normal action	Normal action	Normal action	-	Position proportional output: OFF	105%	Normal action	Normal action	Normal action
Ladder calculation overflow	Normal action	Undefined (calculation with max. value)	Normal action	Normal action	Normal action	Normal action	Normal action	Normal action	Normal action	Normal action	Normal action	Normal action	Normal action
Load factor is over 100%	Normal action	Does not work according to the control period.	Does not work according to the control period.	Does not work according to the control period.	Does not work according to the control period.	Does not work according to the control period.	Normal action	Normal action	Normal action	Normal action	Normal action	Normal action	The response from the main unit slows.
Load factor is over 200%. (Forced termination)	Normal action	Forced end at 200%	Does not work according to the control period.	Does not work according to the control period.	Does not work according to the control period.	Does not work according to the control period.	Normal action	Normal action	Normal action	Normal action	Normal action	Normal action	
Ladder program error	Normal action	Undefined (Stopped at the error detection)	Normal action	Normal action	Normal action	Normal action	Normal action	Normal action	Normal action	Normal action	Normal action	Normal action	Normal action

Errors during Operation (3)

The errors shown below may occur during operation.

PV display (Operation Display)	Setpoint display (Operation Display)	Status indicator (Operation Display)	Parameter that displays error details	Error description	Cause and diagnosis	Remedy
Normal indication	0.000 00000 (Decimal point on the left of the Symbol display blinks)	–	Setup parameter (OP.ER)	Peer-to-peer communication error	Peer-to-peer communication error	Check that the target devices are connected correctly. Recovery at normal receipt.
AT,E	Normal indication	–	Setup parameter (PV1.E)	Auto-tuning time-out	Auto-tuning does not end even when 24 hours have elapsed after the start of tuning.	Check the process. Hold down any key to erase the error indication
VAT,E	Normal indication	–	Setup parameter (AD2.E)	Automatic valve position adjustment error	Fully-closed valve position is equal to or larger than the fully-open valve position after automatic valve position adjustment is performed.	Check wiring and valve. Hold down any key to erase the error indication.
Normal indication	0.000 00000 (Decimal point on the left of the Symbol display blinks)	–	Setup parameter (OP.ER)	Communication error (RS-485 communication)	Framing parity error Buffer overflow Inter-character time-out Checksum error (PC link communication with checksum) CRC check error (Modbus/RTU) LRC check error (Modbus/ASCII)	Check the communication parameters. Recovery at normal receipt. Hold down any key to stop blinking.
Normal indication	0.000 00000 (Decimal point on the left of the Symbol display blinks)	–	Setup parameter (OP.ER)	Communication error (coordinated operation)	Inconsistence of loop between coordinated master and slaves Communication from coordinated master is interrupted for 2 seconds.	Check the communication parameters. Recovery at normal receipt. Change from remote to local mode to stop blinking. When the mode is changed from remote to local, SP tracking does not work even if it is set to ON.
Normal indication	0.000 00000 (Decimal point on the left of the Symbol display blinks)	–	Setup parameter (OP.ER)	User profile error (PROFIBUS-DP communication)	User profile is corrupted.	Download the user profile again.
Normal indication	Normal indication	Rightmost decimal point on Symbol display blinks.	Setup parameter (PA.ER)	Faulty FRAM	Writing (storing) data to FRAM is impossible.	Faulty. Contact us for repair.

Errors during Operation (Input/output Action)

Error description	PV input	Ladder calculation	Control computation	Control output	Retransmission output	Alarm action	Analog output (control output, retransmission output)	Voltage pulse output (control output)	Relay output (control output, position proportional output)	Feedback input (for Position proportional type)	Contact input	Contact (alarm) output	Communication
Peer-to-peer communication error	Normal action	Normal action (However, the peer-to-peer communication register is not updated.)	Normal action	Normal action	Normal action	Normal action	Normal action	Normal action	Normal action	Normal action	Normal action	Normal action	Normal action
Auto-tuning time-out	Normal action	Normal action	Auto-tuning stopped, normal action	Auto-tuning stopped, Normal action	Normal action	Normal action	Normal action	Normal action	Normal action	Normal action	Normal action	Normal action	Normal action
Automatic valve position adjustment error	Normal action	Normal action	Normal action	Normal action	Normal action	Normal action	Normal action	Normal action	Normal action	105%	Normal action	Normal action	Normal action
Communication error (RS485 communication)	Normal action	Normal action	Normal action	Normal action	Normal action	Normal action	Normal action	Normal action	Normal action	Normal action	Normal action	Normal action	Normal action
Communication error (coordinated operation) Inconsistence of loop between coordinated master and slaves	Normal action	Normal action	Normal action	Normal action	Normal action	Normal action	Normal action	Normal action	Normal action	Normal action	Normal action	Normal action	Normal action
Communication error (coordinated operation) Communication from coordinated master is interrupted for 2 seconds.	Normal action	Normal action	Normal action	Normal action	Normal action	Normal action	Normal action	Normal action	Normal action	Normal action	Normal action	Normal action	Normal action
User profile error (PROFIBUS-DP communication)	Normal action	Normal action	Normal action	Normal action	Normal action	Normal action	Normal action	Normal action	Normal action	Normal action	Normal action	Normal action	PROFIBUS-DP communication disabled
Faulty FRAM	Normal action	Normal action	Normal action	Normal action	Normal action	Normal action	Normal action	Normal action	Normal action	Normal action	Normal action	Normal action	Normal action

Errors during Operation (4)

The errors shown below may occur during operation.

PV display (Operation Display)	Data display (Operation Display)	Status indicator (Operation Display)	Parameter that displays error details	Error description	Cause and diagnosis	Remedy
Undefined	Undefined	–	–	Faulty MCU	MCU is corrupted.	Faulty Contact us for repair.
Undefined	Undefined	–	–	Faulty DCU (ROM/RAM error, corrupted)	DCU is corrupted.	Faulty Contact us for repair.

Errors during Operaiton On (Input/output Action)

Error description	PV input	Ladder calculation	Control computation	Control output	Retransmission output	Alarm action	Analog output (control output, retransmission output)	Voltage pulse output (control output)	Relay output (control output, position proportional output)	Feedback input (for Position proportional type)	Contact input	Contact (alarm) output	Communication
Faulty MCU	Undefined	Stopped	Stopped	Undefined	Undefined	Stopped	0% or less	OFF	OFF	Undefined	OFF	OFF	Stopped
Faulty DCU (ROM/RAM error, corrupted)	Undefined	Stopped	Stopped	Undefined	Undefined	Stopped	0% or less	OFF	OFF	Undefined	OFF	OFF	Stopped

Hexadecimal Display on Setpoint Display (Operation Display)

Some error codes are displayed in hexadecimal.

When the error occurs, "1" is set on the bit of corresponding error, and the bit data is displayed in hexadecimal.

If the setup parameter error or the operation parameter errors occur, it is displayed as follows:

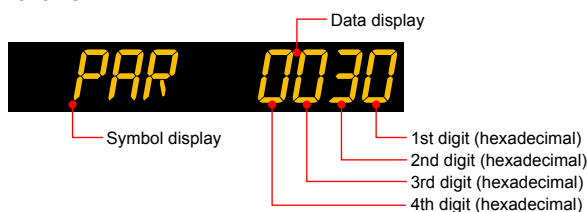

Displayed digit	bit	Description
1st digit	0	System data error
	1	Calibration value error
	2	User (parameter) default value error
	3	–
2nd digit	4	Setup parameter error
	5	Operation parameter error
	6	–
	7	–
3rd digit	8	Faulty FRAM
	9	–
	10	Control parameter error
	11	–
4th digit	12	–
	13	–
	14	–
	15	–

If the hardware in E1-terminal area does not respond, it is displayed as follows:

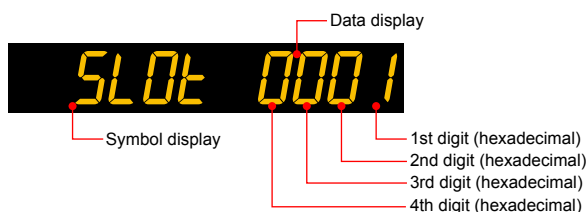

Displayed digit	bit	Description
1st digit	0	Non responding hardware in E1-terminal area
	1	–
	2	Non responding hardware in E3-terminal area
	3	–
2nd digit	4	Non responding hardware in E4-terminal area
	5	–
	6	–
	7	–
3rd digit	8	Communication error in E1-terminal area
	9	–
	10	Communication error in E3-terminal area
	11	–
4th digit	12	–
	13	–
	14	–
	15	–

Hexadecimal Display of the Parameter which Shows the Error Details

Error confirmation parameters are displayed in hexadecimal.
 When the error occurs, "1" is set on the bit of corresponding error.

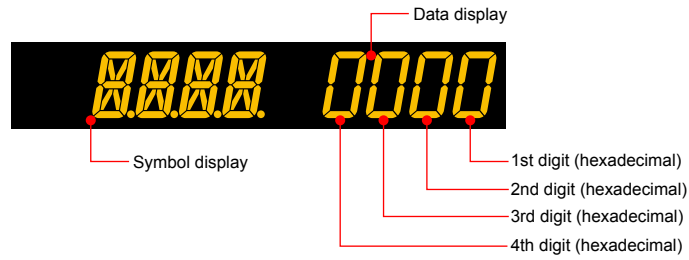

Parameter PA.ER

Displayed digit	bit	Description
1st digit	0	System data error
	1	Calibration value error
	2	User (parameter) default value error
	3	–
2nd digit	4	Setup parameter error
	5	Operation parameter error
	6	–
	7	–
3rd digit	8	Faulty FRAM
	9	–
	10	Control parameter error
	11	–
4th digit	12	–
	13	–
	14	–
	15	–

Parameter LA.ER

Displayed digit	bit	Description
1st digit	0	Ladder program corruption
	1	Ladder calculation overflow
	2	Ladder program error
	3	–
2nd digit	4	Load factor over 100%
	5	Load factor over 200%
	6	–
	7	–
3rd digit	8	–
	9	–
	10	–
	11	–
4th digit	12	–
	13	–
	14	–
	15	–

Parameter OP.ER

Displayed digit	bit	Description
1st digit	0	Non responding hardware in E1-terminal area
	1	–
	2	Non responding hardware in E3-terminal area
	3	–
2nd digit	4	Non responding hardware in E4-terminal area
	5	–
	6	–
	7	–
3rd digit	8	Communication error in E1-terminal area
	9	–
	10	Communication error in E3-terminal area
	11	–
4th digit	12	–
	13	–
	14	–
	15	–

Parameter AD1.E

Displayed digit	bit	Description
1st digit	0	ADC error of PV input
	1	–
	2	–
	3	–
2nd digit	4	–
	5	RJC error of PV input
	6	–
	7	–
3rd digit	8	PV input burnout error
	9	–
	10	–
	11	–
4th digit	12	–
	13	–
	14	–
	15	–

Parameter AD2.E

Displayed digit	bit	Description
1st digit	0	Feedback input resistor/current burnout
	1	Automatic valve position adjustment error
	2	–
	3	–
2nd digit	4	–
	5	–
	6	–
	7	–
3rd digit	8	–
	9	–
	10	–
	11	–
4th digit	12	–
	13	–
	14	–
	15	–

16.1 Troubleshooting

Parameter PV1.E

Displayed digit	bit	Description
1st digit	0	PV input burnout error
	1	–
	2	–
	3	–
2nd digit	4	PV input over-scale
	5	PV input under-scale
	6	–
	7	–
3rd digit	8	–
	9	–
	10	–
	11	–
4th digit	12	–
	13	–
	14	Auto-tuning time-out
	15	–

16.2 Maintenance

16.2.1 Cleaning

The front panel and operation keys should be gently wiped with a cloth soaked with water and squeezed firmly.

CAUTION

In order to prevent LCD from static electricity damage, do not wipe with dry cloth. (When LCD is electrified, it returns to normal in several minutes.)
Do not use alcohol, benzene, or any other solvents.

16.2.2 Packaging when Shipping the Product for Repair

Should the instrument break down and need to be shipped to our sales representative for repair, handle it as noted below:

CAUTION

Write down the settings of parameters for a repair request.

WARNING

Prior to shipping the instrument, put it into an antistatic bag and repackage it using the original internal packaging materials and packaging container.

16.2.3 Replacing Parts

Do not replace any parts inside the unit.

16.3 Periodic Maintenance

Check the operating condition periodically to use this instrument with good condition.

16.4 Disposal

When disposing of this instrument, arrange for appropriate disposal as industrial waste according to the rules of a country, the area, or a local government.

17.1 Installation Location

The instrument should be installed in indoor locations meeting the following conditions:

- Instrumented panel
This instrument is designed to be mounted in an instrumented panel. Mount the instrument in a location where its terminals will not inadvertently be touched.
- Well ventilated locations
Mount the instrument in well ventilated locations to prevent the instrument's internal temperature from rising. However, make sure that the terminal portions are not exposed to wind. Exposure to wind may cause the temperature sensor accuracy to deteriorate. To mount multiple indicating controllers, see the external dimensions/ panel cutout dimensions which follow. If mounting other instruments adjacent to the instrument, comply with these panel cutout dimensions to provide sufficient clearance between the instruments.
- Locations with little mechanical vibration
Install the instrument in a location subject to little mechanical vibration.
- Horizontal location
Mount the instrument horizontally and ensure that it is level, with no inclination to the right or left.

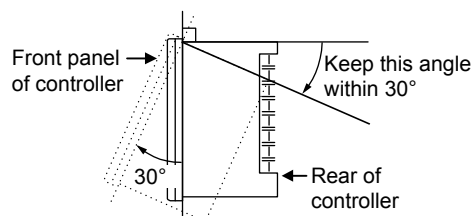

Note

If the instrument is moved from a location with low temperature and low humidity to a place with high temperature and high humidity, or if the temperature changes rapidly, condensation will result. Moreover, in the case of thermocouple inputs, measurement errors will result. To avoid such a situation, leave the instrument in the new environment under ambient conditions for more than 1 hour prior to using it.

17.1 Installation Location

Do not mount the instrument in the following locations:

- Outdoors
- Locations subject to direct sunlight, ultrared rays, ultraviolet rays, or close to a heater
Install the instrument in a location with stable temperatures that remain close to an average temperature of 23°C. Do not mount it in locations subject to direct sunlight or close to a heater. Doing so adversely affects the instrument and LCD.
- Locations with substantial amounts of oily fumes, steam, moisture, dust, or corrosive gases
The presence of oily fumes, steam, moisture, dust, or corrosive gases adversely affects the instrument. Do not mount the instrument in locations subject to any of these substances.
- Areas near electromagnetic field generating sources
Do not place magnets or tools that generate magnetism near the instrument. If the instrument is used in locations close to a strong electromagnetic field generating source, the magnetic field may cause measurement errors.
- Locations where the display is difficult to see
The instrument uses an LCD for the display unit, and this can be difficult to see from extremely oblique angles. Mount the instrument in a location where it can be seen as much as possible from the front.
- Areas close to flammable articles
Absolutely do not place the instrument directly on flammable surfaces. If such a circumstance is unavoidable and the instrument must be placed close to a flammable item, provide a shield for it made of 1.43 mm thick plated steel or 1.6 mm thick unplated steel with a space of at least 150 mm between it and the instrument on the top, bottom and sides.

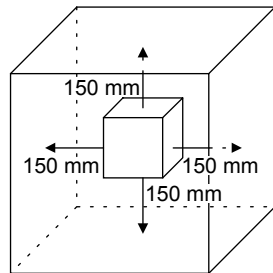

- Areas subject to being splashed with water

17.2 Mounting Method



WARNING

Be sure to turn OFF the power supply to the controller before installing it on the panel to avoid an electric shock.

Mounting the Instrument Main Unit

Provide an instrumented panel steel sheet of 1 to 10 mm thickness.

After opening the mounting hole on the panel, follow the procedures below to install the controller:

1. Insert the controller into the opening from the front of the panel so that the terminal board on the rear is at the far side.
2. Set the brackets in place on the top and bottom of the controller as shown in the figure below, then tighten the screws of the brackets. Take care not to overtighten them.

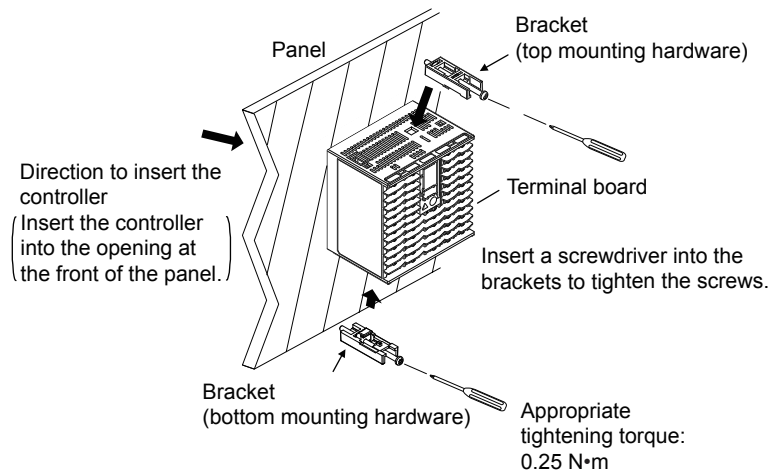

To uninstall the controller, perform the procedure in the reverse order.

CAUTION

- 1) Tighten the screws with appropriate tightening torque within 0.25 N·m. Otherwise it may cause the case deformation or the bracket damage.
- 2) Make sure that foreign materials do not enter the inside of the instrument through the case's slit holes.

17.3 External Dimensions and Panel Cutout Dimensions

UT35A

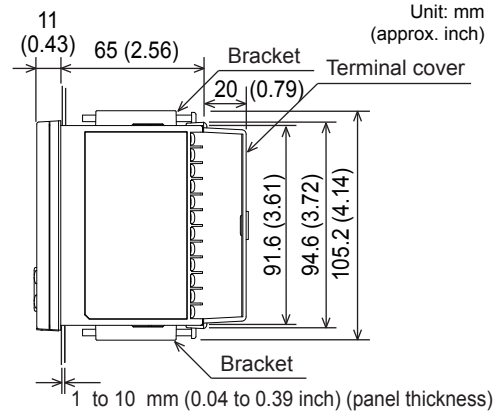
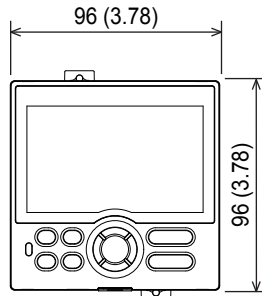

General mounting

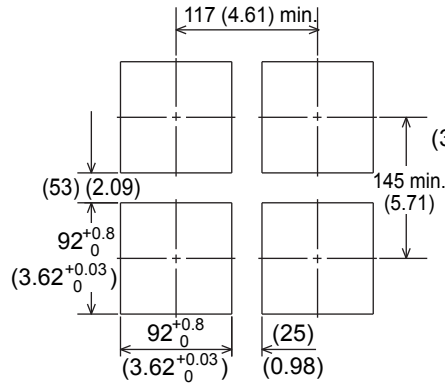

Side-by-side close mounting

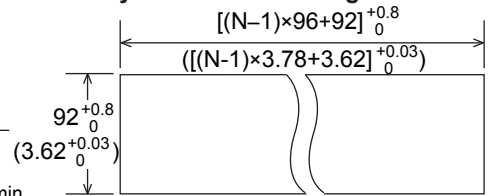

"N" stands for the number of controllers to be installed. However, the measured value applies if N ≥ 5.

Normal tolerance: ±(value of JIS B 0401-1998 tolerance class IT18)/2

UT32A

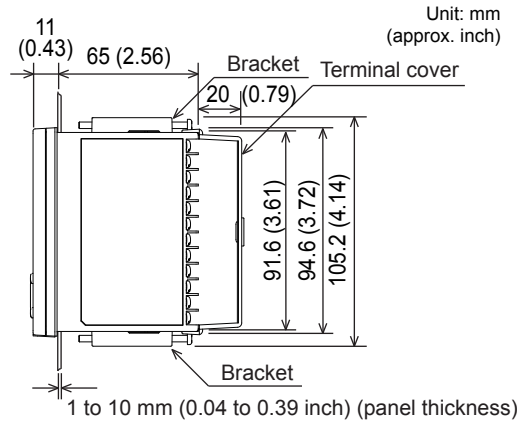
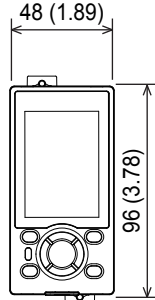

General mounting

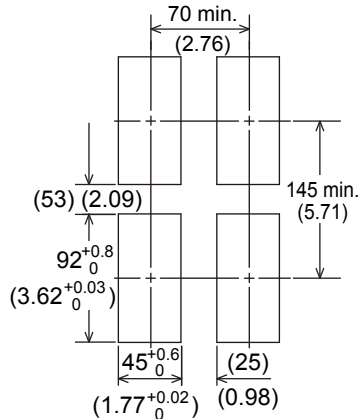

Side-by-side close mounting

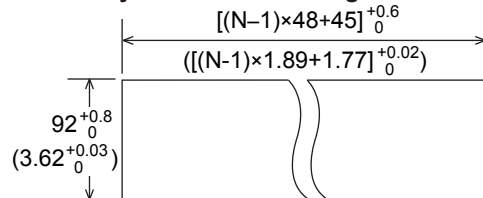

"N" stands for the number of controllers to be installed. However, the measured value applies if N ≥ 5.

Normal tolerance: ±(value of JIS B 0401-1998 tolerance class IT18)/2

17.4 Wiring

17.4.1 Important Information on Wiring



WARNING

- 1) Be sure to turn OFF the power supply to the controller before wiring to avoid an electric shock. Use a tester or similar device to ensure that no power is being supplied to a cable to be connected.
- 2) Wiring work must be carried out by a person with basic electrical knowledge and practical experience.

UT35A Terminal Block Diagram

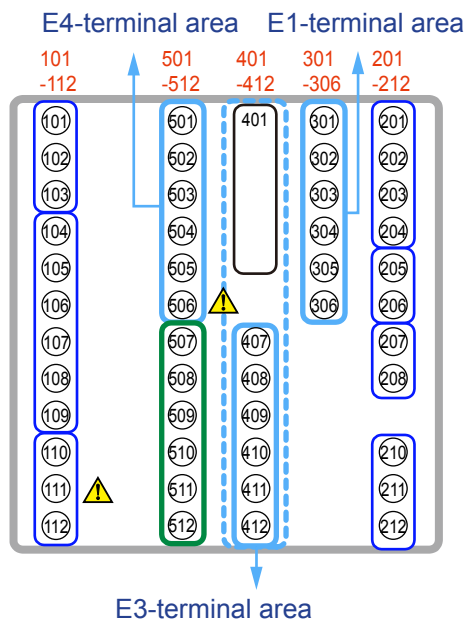

UT32A Terminal Block Diagram

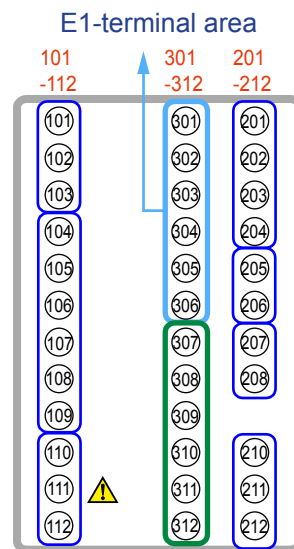

CAUTION

Do not use an unassigned terminal as the relay terminal.

Recommended Crimp-on Terminal Lugs

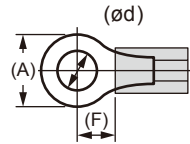

Recommended tightening torque: 0.6 N·m

Applicable wire size: Power supply wiring 1.25 mm² or more

Applicable terminal lug	Applicable wire size mm ² (AWG#)	(ød)	(A)	(F)
M3	0.25 to 1.65 (22 to 16)	3.3	5.5	4.2

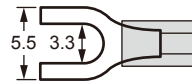

Cable Specifications

Purpose	Name and Manufacturer
Power supply, relay contact output	600 V Grade heat-resistant PVC insulated wires, JIS C 3317(HIV), 0.9 to 2.0 mm ²
Thermocouple	Shielded compensating lead wire JISC1610
RTD	Shielded wire (three/four conductors) UL2482 (Hitachi Cable)
Other signals (other than contact input/output)	Shielded wires
Other signals (contact input/output)	Non shielded wires
RS485 communication	Shielded wires
Ethernet communication	100 BASE-TX (CAT-5) / 10 BASE-T
PROFIBUS-DP communication	Dedicated cable for PROFIBUS-DP (Shielded two-wires)

PROFIBUS-DP Connector (wiring side) (Part number: A1987JT)

Recommended tightening torque: 0.5 to 0.6 N·m

Note

Communication wires of cross-sectional area less than or equal to 0.34 mm² may not be secured firmly to the terminals.

Check that the wire is firmly connected to the terminal by folding the conductor of the wire connected to the crimp-on lug.

Recommended length of the stripped wire: 7 mm

Note

If the UT is located at the end of a segment for the PROFIBUS communication wiring, terminating resistors are separately needed. These are to be prepared by users. (390 Ω: 2 pcs. 220 Ω: 1 pc., or an active terminator.)

17.4.2 PV Input Wiring

CAUTION

- 1) Be careful of polarity when wiring inputs. Reversed polarity can damage the UT.
- 2) Keep the PV input signal line as far away as possible from the power supply circuit and ground circuit.
- 3) For TC input, use shielded compensating lead wires for wiring. For RTD input, use shielded wires that have low conductor resistance and cause no significant differences in resistance between the three wires.
- 4) If there is a risk of external lightning surges, use a lightning arrester etc.

UT35A/UT32A

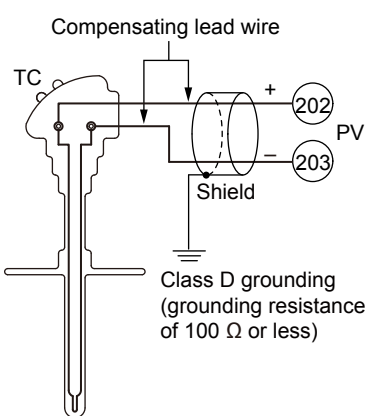
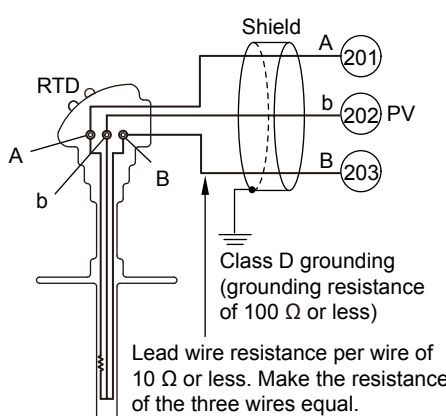
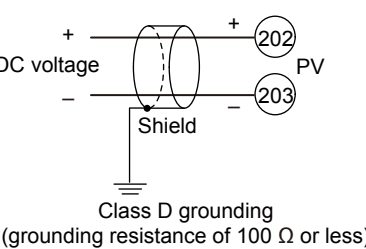
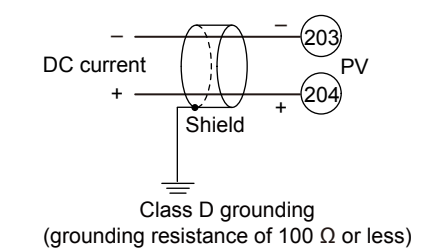
TC Input	RTD Input (3-wire system)
 <p>Compensating lead wire</p> <p>TC</p> <p>Shield</p> <p>Class D grounding (grounding resistance of 100 Ω or less)</p> <p>202 PV</p> <p>203</p>	 <p>Shield</p> <p>RTD</p> <p>Class D grounding (grounding resistance of 100 Ω or less)</p> <p>Lead wire resistance per wire of 10 Ω or less. Make the resistance of the three wires equal.</p> <p>A 201</p> <p>b 202 PV</p> <p>B 203</p>
DC Voltage (mV, V) Input	DC Current (mA) Input
 <p>DC voltage</p> <p>Shield</p> <p>Class D grounding (grounding resistance of 100 Ω or less)</p> <p>202 PV</p> <p>203</p>	 <p>DC current</p> <p>Shield</p> <p>Class D grounding (grounding resistance of 100 Ω or less)</p> <p>203 PV</p> <p>204</p>

Use

PV input is used for PV input.

17.4.3 Control Output (Relay, Current, and Voltage Pulse) Wiring

CAUTION

- 1) The use of inductance (L) loads such as auxiliary relays, motors and solenoid valves causes malfunction or relay failure; always insert a CR filter for use with alternating current or a diode for use with direct current, as a spark-removal surge suppression circuit, into the line in parallel with the load.
- 2) If there is a risk of external lightning surges, use a lightning arrester etc.
- 3) Relays cannot be used for a small load of 10 mA or less.

DC Relay Wiring

UT35A/UT32A

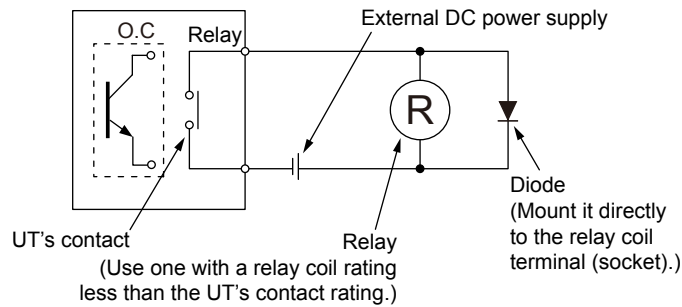

AC Relay Wiring

UT35A/UT32A

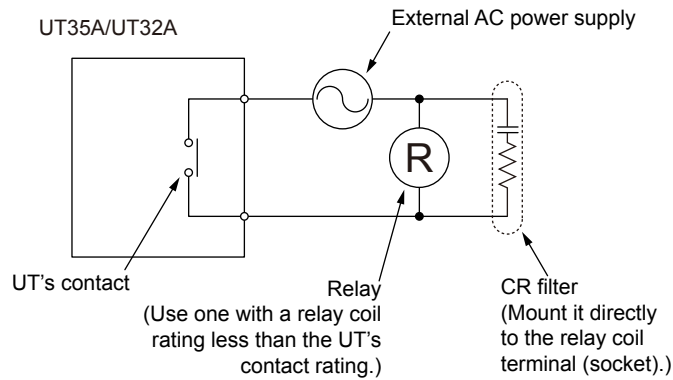

UT35A/UT32A

Relay Output

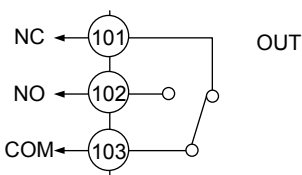
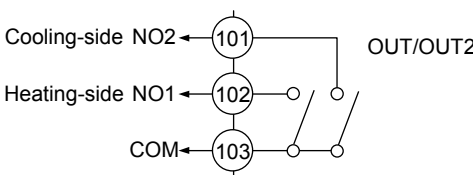
Standard type output	Heating/cooling type heating/cooling output
 <p>Contact rating: 250 V AC, 3 A 30 V DC, 3 A (resistance load)</p>	 <p>Contact rating: 250 V AC, 3 A 30 V DC, 3 A (resistance load)</p>

Note: Cannot be used for a small load of 10 mA or less.

UT35A/UT32A

Current and Voltage Pulse Output

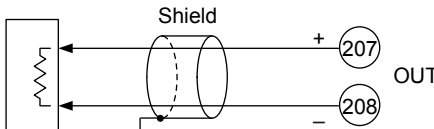
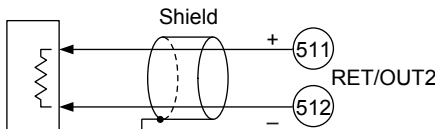
Standard type or Heating/cooling type heating-side output	Heating/cooling type cooling-side output
 <p>Control valves (or other actuators) Class D grounding (grounding resistance of 100 Ω or less)</p> <p>Current: 4 to 20 mA DC or 0 to 20 mA DC (resistance load: 600 Ω or less)</p> <p>Voltage pulse: On-voltage: 12 V DC or more (load resistance: 600 Ω or more) Off-voltage: 0.1 V DC or less</p>	 <p>Control valves (or other actuators) Class D grounding (grounding resistance of 100 Ω or less)</p> <p>Current: 4 to 20 mA DC or 0 to 20 mA DC (resistance load: 600 Ω or less)</p> <p>Voltage pulse: On-voltage: 12 V DC or more (load resistance: 600 Ω or more) Off-voltage: 0.1 V DC or less</p>

Use

When current/voltage pulse output is not used for control output, it can be used for retransmission output.

When retransmission output terminal is not used for retransmission output, it can be used for optional control output. The current output range can be changed.

For control output setting, set the control type (CNT), then set the output terminal and output type in the output type selection (OT).

- ▶ [Control output type: 10.1 Setting Control Output Type](#)

17.4.4 Valve Position Output and Feedback Input Wiring

CAUTION

- 1) Use an auxiliary relay for load-switching if the contact rating is exceeded.
- 2) Keep the relay output wires and the feedback input wires at least 30 cm apart.
- 3) The output relay has a limited service life. Be sure to connect a CR filter (for AC) or diode (for DC) to the load.
- 4) If there is a risk of external lightning surges, use a lightning arrester etc.
- 5) Relays cannot be used for a small load of 10 mA or less.

► When using auxiliary relay: 17.4.3 Control Output (Relay, Current, and Voltage Pulse) Wiring

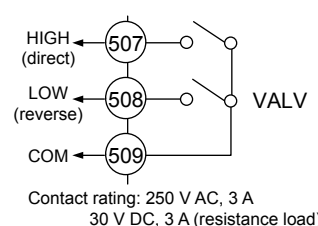
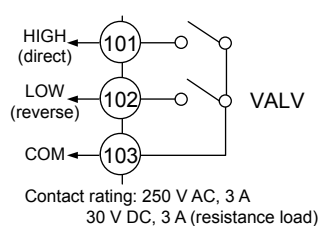
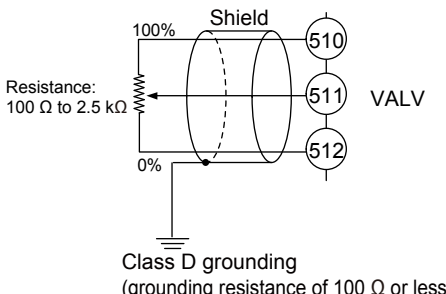
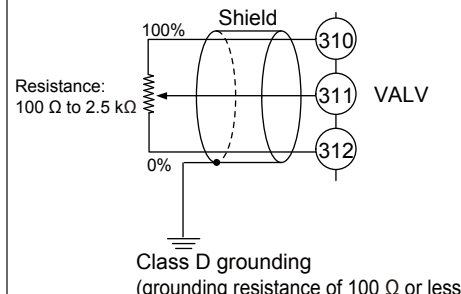
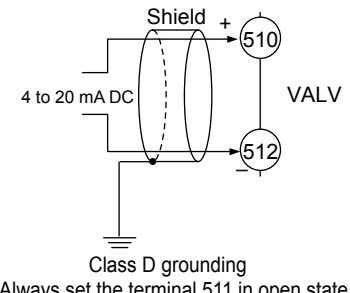
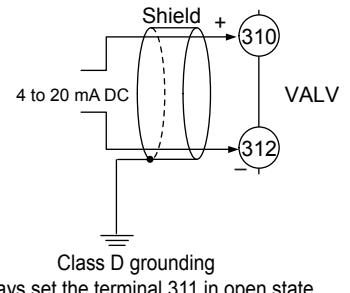
Relay contact output (UT35A)	Relay contact output (UT32A)
 <p style="font-size: small;">Contact rating: 250 V AC, 3 A 30 V DC, 3 A (resistance load)</p> <p style="font-size: x-small;">Note: Cannot be used for a small load of 10 mA or less.</p>	 <p style="font-size: small;">Contact rating: 250 V AC, 3 A 30 V DC, 3 A (resistance load)</p> <p style="font-size: x-small;">Note: Cannot be used for a small load of 10 mA or less.</p>
Feedback input (resistor) (UT35A)	Feedback input (resistor) (UT32A)
 <p style="font-size: x-small;">Resistance: 100 Ω to 2.5 kΩ</p> <p style="font-size: x-small;">Class D grounding (grounding resistance of 100 Ω or less)</p>	 <p style="font-size: x-small;">Resistance: 100 Ω to 2.5 kΩ</p> <p style="font-size: x-small;">Class D grounding (grounding resistance of 100 Ω or less)</p>
Feedback input (current) (UT35A)	Feedback input (current) (UT32A)
 <p style="font-size: x-small;">4 to 20 mA DC</p> <p style="font-size: x-small;">Class D grounding * Always set the terminal 511 in open state.</p>	 <p style="font-size: x-small;">4 to 20 mA DC</p> <p style="font-size: x-small;">Class D grounding * Always set the terminal 311 in open state.</p>

17.4.5 Contact Input Wiring

CAUTION

- 1) Use a no-voltage contact (relay contact etc.) for external contacts.
- 2) Use a no-voltage contact which has ample switching capacity for the terminal's OFF voltage (approx. 5V) and ON current (approx 1mA).
- 3) When using a transistor contact, the voltage at both terminals must be 2 V or less when the contact is ON and the leakage current must be 100 μ A or less when it is OFF.
- 4) If there is a risk of external lightning surges, use a lightning arrester etc.

UT35A/UT32A

Contact Input Equipped as Standard

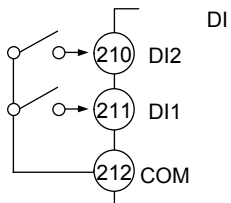
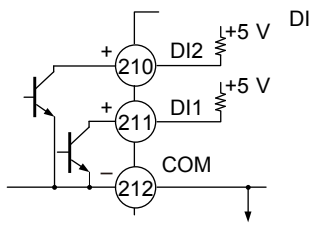
No-voltage contact	Transistor contact
 <p>Contact rating: 12 V DC, 10 mA or more</p>	 <p>Contact rating: 12 V DC, 10 mA or more</p>

Additional Contact Input According to the UT35A Suffix Codes

UT35A suffix code: Type 2=2	
Non-voltage contact	Transistor contact
<p>Contact rating: 12 V DC, 10 mA or more</p>	<p>Contact rating: 12 V DC, 10 mA or more</p>
UT35A suffix code: Type 2=1	
Non-voltage contact	Transistor contact
<p>Contact rating: 12 V DC, 10 mA or more</p>	<p>Contact rating: 12 V DC, 10 mA or more</p>

Additional Contact Input According to the UT32A Suffix Codes

UT32A suffix code: Type 2=2	
No-voltage contact	Transistor contact
<p>Contact rating: 12 V DC, 10 mA or more</p>	<p>Contact rating: 12 V DC, 10 mA or more</p>

The following table shows the initial status.

► [Contact input function registration: 12.1 Setting Contact Input Function](#)

Control type	DI1	DI2
Single-loop Control Heating/cooling Control Position Proportional Control Two-position Two-level Control	AUTO (ON)/MAN (OFF) switch	STOP (ON)/RUN (OFF) switch

17.4.6 Contact Output Wiring

CAUTION

- 1) Use an auxiliary relay for load-switching if the contact rating is exceeded.
- 2) Connect a bleeder resistor when a small current is used, so that a current exceeding 10 mA can be supplied.
- 3) The output relay has a limited service life. Be sure to connect a CR filter (for AC) or diode (for DC) to the load.
- 4) If there is a risk of external lightning surges, use a lightning arrester etc.

► When using auxiliary relay: 17.4.3 Control Output (Relay, Current, and Voltage Pulse) Wiring

UT35A/UT32A

Contact Output Equipped as Standard

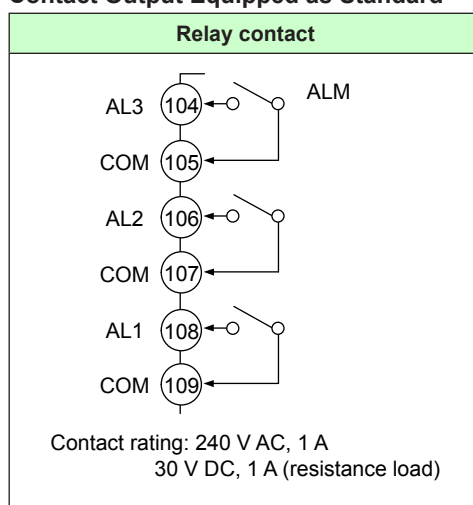

Additional Contact Output According to the UT35A Suffix Codes

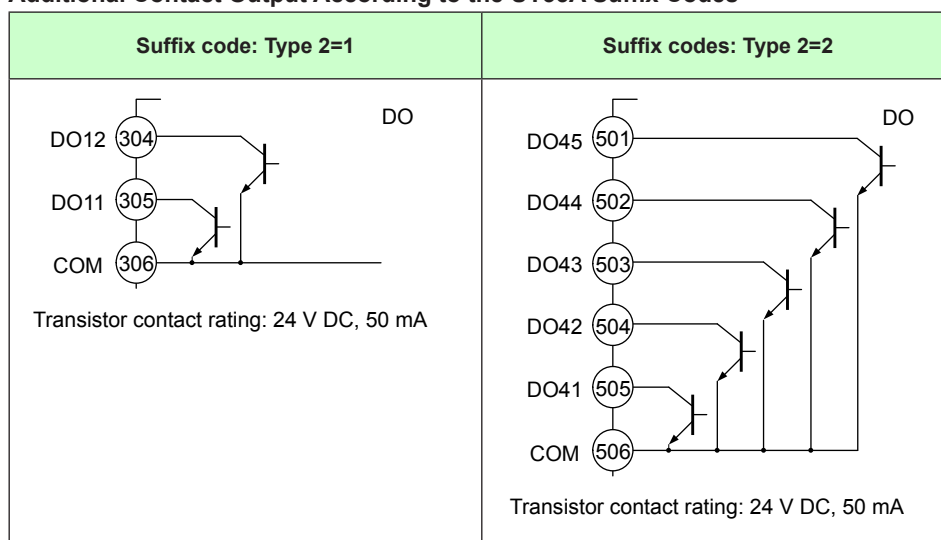

Factory default: Function is not assigned to the additional contact outputs.

► Contact output function registration: 12.2 Setting Contact Output Function

Additional Contact Output According to the UT32A suffix codes

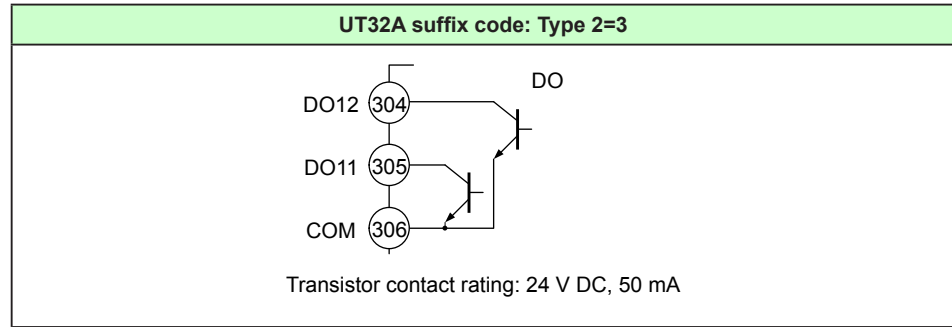

Factory default: Function is not assigned to the additional contact outputs.

► [Contact output function registration: 12.2 Setting Contact Output Function](#)

The following table shows the initial status for control type.

Control type	AL1 terminal	AL2 terminal	AL3 terminal
Single-loop Control			
Heating/cooling Control	Alarm 1 (PV high limit)	Alarm 2 (PV low limit)	Alarm 3 (PV high limit)
Position Proportional Control			
Two-position Two-level Control			

When UT35A suffix code: Type 2 = 1 or UT32A suffix code: Type 2 = 2, the following function is assigned to DO11.

DO11: Alarm 4 (PV low limit)

When UT35A suffix code: Type 2 = 2, the following function is assigned to DO41.

DO41: Alarm 4 (PV low limit)

17.4.7 Retransmission Output Wiring

When retransmission output is not used for retransmission output, it can be used for control output or 15 V DC loop power supply.

The current output range can be changed.

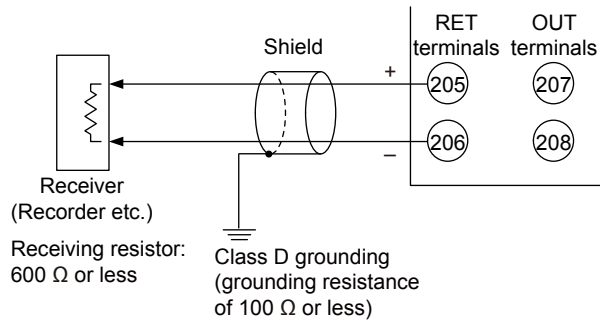

17.4.8 15 V DC Loop Power Supply Wiring

This can be used when it is not used for retransmission output.

The controller is equipped with a non-isolated loop power supply (14.5 to 18.0 V DC) for connecting a 2-wire transmitter.

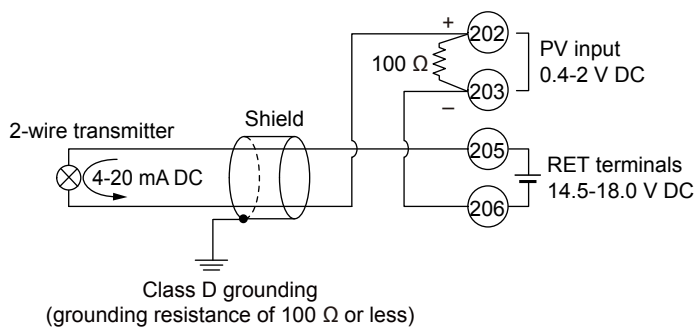

OUT terminal and OUT2 terminal also can be used.

17.4.9 24 V DC Loop Power Supply Wiring

This can be used when the optional suffix code /LP is specified.

The controller with the optional suffix code /LP is equipped with an isolated loop power supply (21.6 to 28.0 V DC) for connecting a 2-wire transmitter.

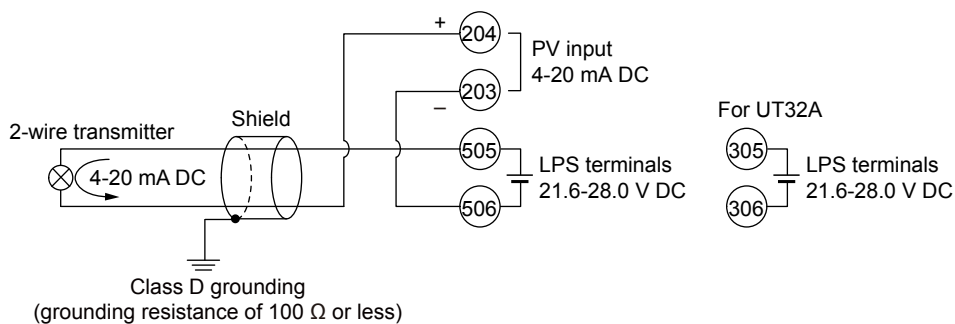

17.4.10 Heater Break Alarm Wiring

Heater break alarm can be used for the UT35A with the optional suffix code /HA.

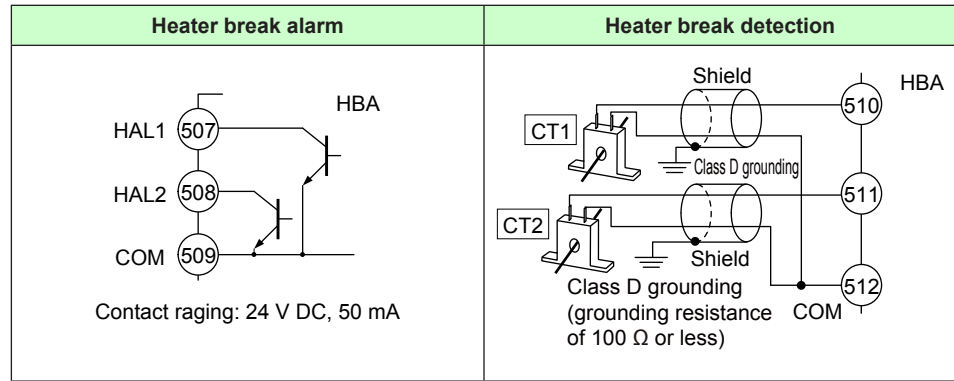

Heater break alarm can be used for the UT32A with the optional suffix code /HA.

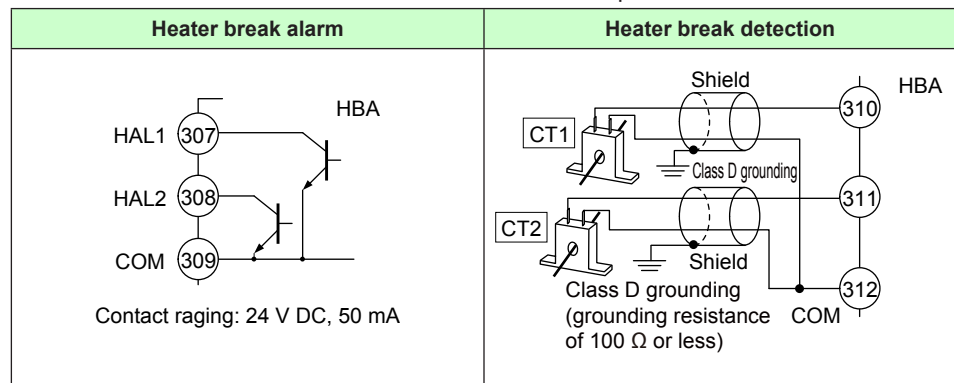

17.4.11 RS-485 Communication Interface Wiring

Wire as follows for Modbus communication, PC link communication, or ladder communication.

Always connect a terminating resistor to the station at the end of the communication line.

▶ [Details of communication parameter settings and communication functions: UTAdvanced Series Communication Interface \(RS-485, Ethernet\) User's Manual](#)

4-wire Wiring

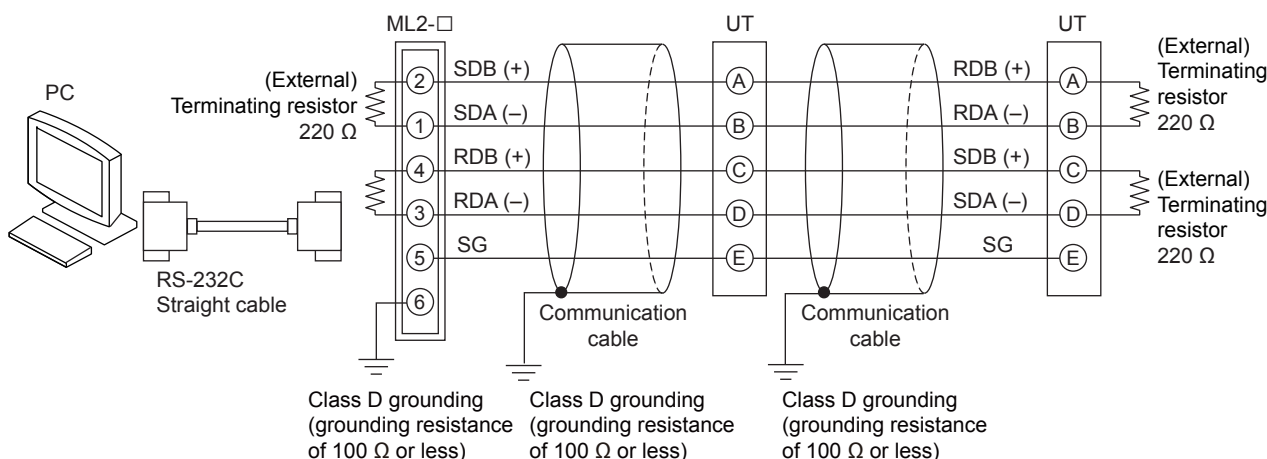

2-wire Wiring of 4-wire Terminal

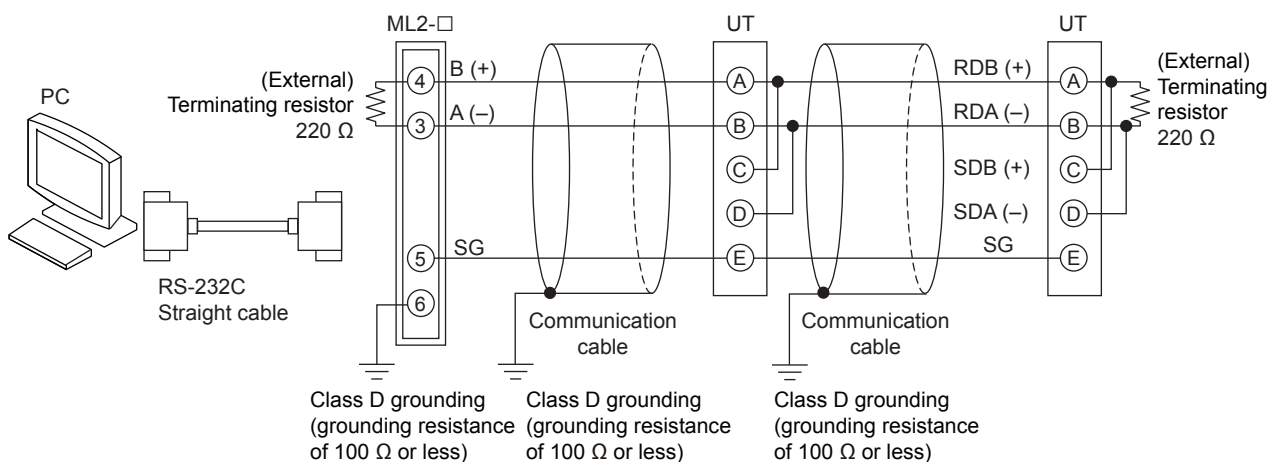

UT35A/UT32A

Terminal symbol above.	UT35A Applicable to suffix code: Type 3 = 1	UT32A Applicable to suffix code: Type 2 = 1
A	410	304
B	411	305
C	407	301
D	408	302
E	409	303

Note

ML2-x indicates a converter of YOKOGAWA. Other than this, RS232C/RS485 converters can also be used. If another converter is to be used, check the electrical specifications of the converter before using it.

17.4.12 Coordinated Operation Wiring

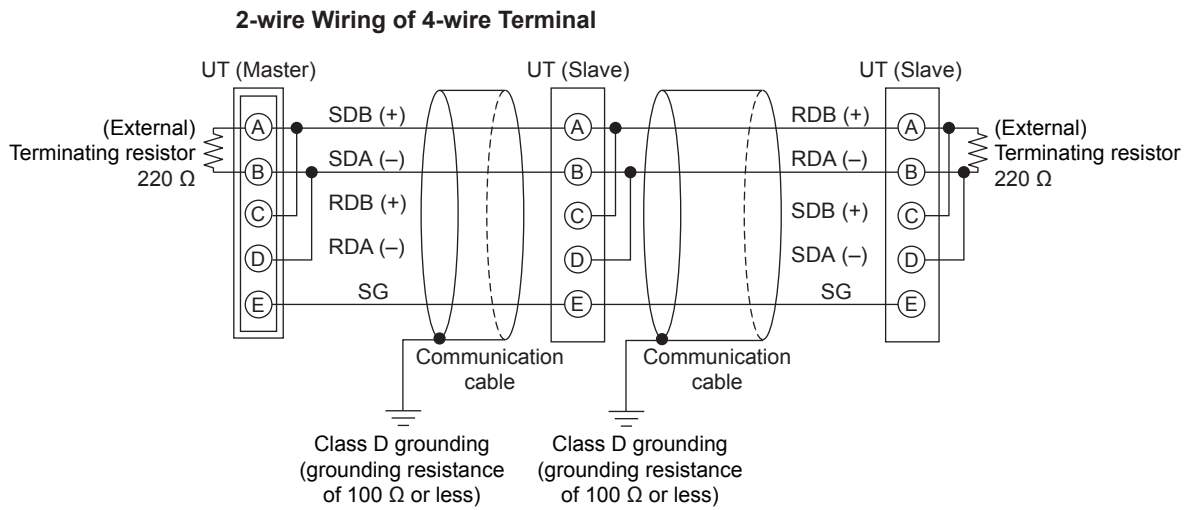
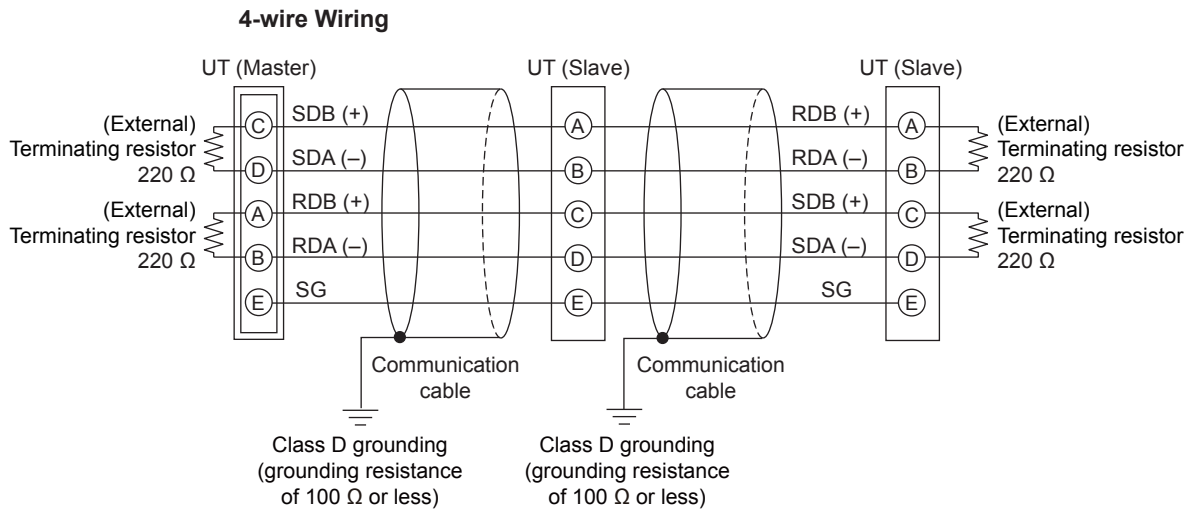

UT35A/UT32A

Terminal symbol above.	UT35A Applicable to suffix code: Type 3 = 1	UT32A Applicable to suffix code: Type 2 = 1
A	410	304
B	411	305
C	407	301
D	408	302
E	409	303

17.4.13 Peer-to peer Communication Wiring

Peer-to-peer communication can be used on ladder program of UT35A/UT32A.

2-wire Wiring of 4-wire Terminal

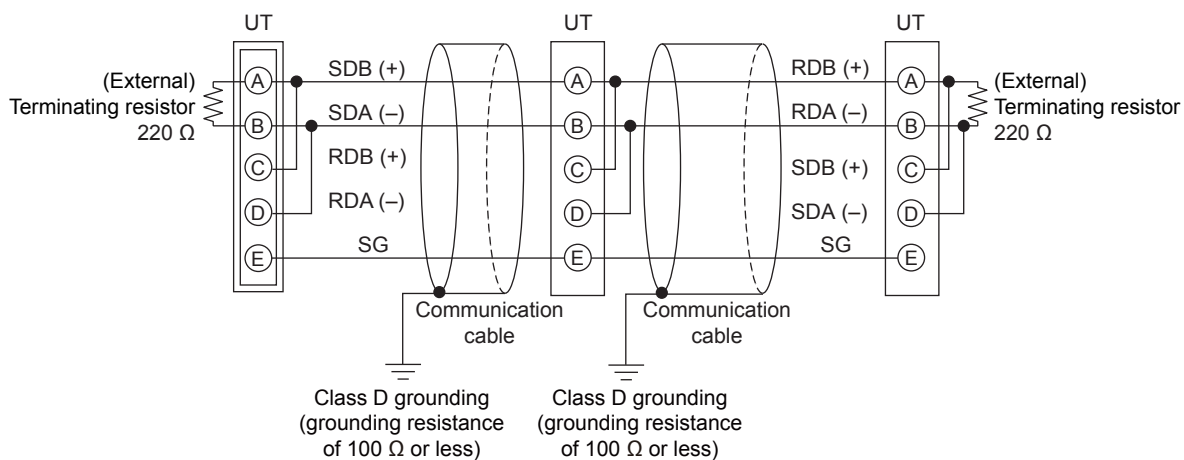

UT35A/UT32A

Terminal symbol above.	UT35A Applicable to suffix code: Type 3=1	UT32A Applicable to suffix code: Type 2 = 1
A	410	304
B	411	305
C	407	301
D	408	302
E	409	303

- ▶ Details of communication parameter settings and communication functions: [UTAdvanced Series Communication Interface \(RS-485, Ethernet\) User's Manual](#)
- ▶ Details of Peer-to-peer communication: [LL50A Parameter Setting Software User's Manual](#)

17.4.14 Ethernet Communication Interface Wiring

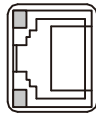
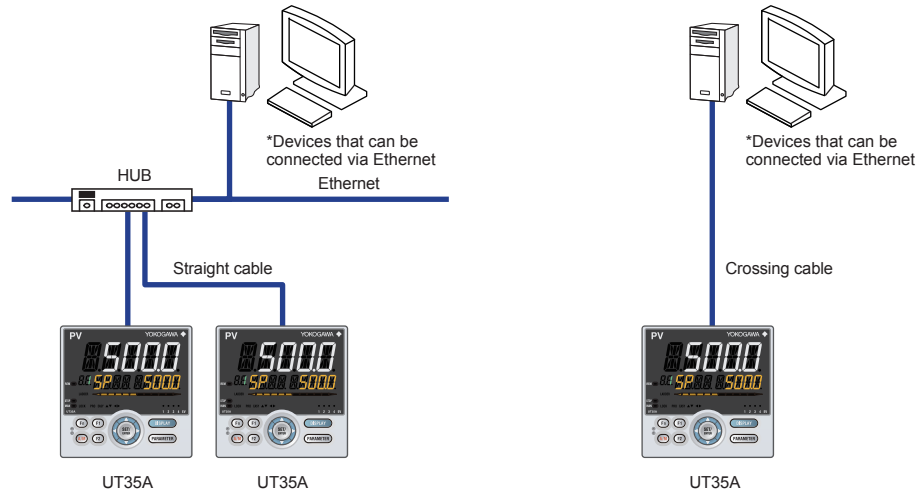

Upper side LED (baud rate)		Lower side LED (link activity)	
Color	Amber	Color	Green
Lit	100M bps	Lit	Linked
Unlit	10M bps	Blink	Active
		Unlit	Link failure

CAUTION

Be sure to connect a lightning arrester for Ethernet (100BASE-TX/10BASE-T) in an environment where a surge voltage may be induced by a lightning discharge.

RS-485 communication wiring for the serial gateway function is as follows.

2-wire Wiring of 4-wire Terminal

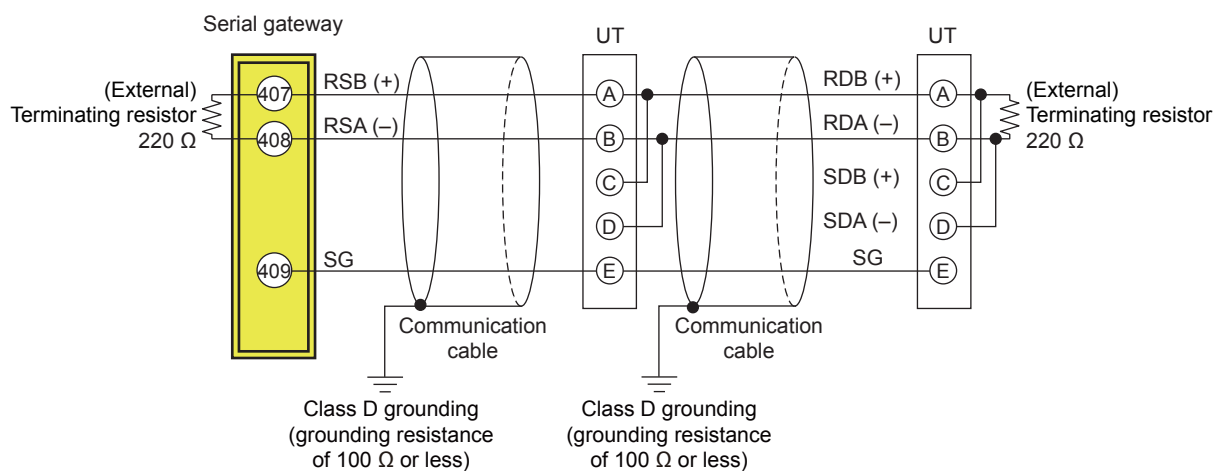

Slave terminals

Terminal symbol above.	UT35A Applicable to suffix code: Type 3=1	UT32A Applicable to suffix code: Type 2 = 1
A	410	304
B	411	305
C	407	301
D	408	302
E	409	303

17.4.15 PROFIBUS-DP Communication Interface Wiring

- (1) Remove the terminal block
Hold both ends of the terminal block and pull straight.

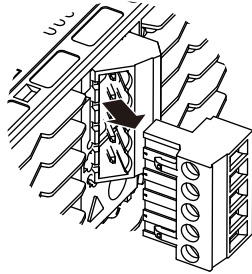

- (2) Connect the wires

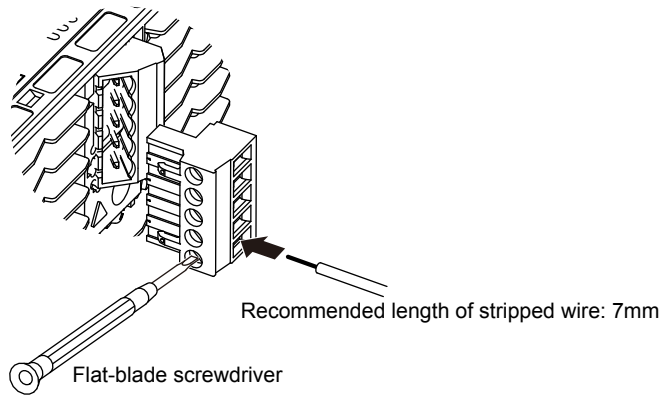

- (3) Connect the terminal block
Hold both ends of the terminal block, align with the connector on the UT side, and push the terminal block into the connector.

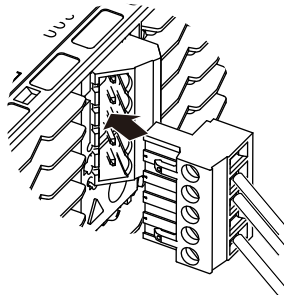

Number of Pin	Singnal name	Description
1	VP	+5V bus power
2	RxD/TxD-P	Data signal (positive data receive/transmit)
3	RxD/TxD-N	Data signal (negative data recive/transmit)
4	DGND	Signal ground
5	SHIELD	Shield ground

Terminating Resister of Bus

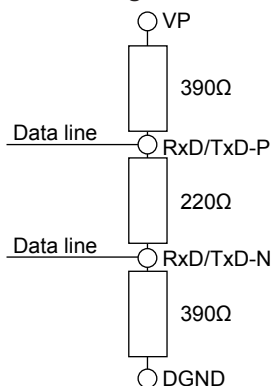

PROFIBUS-DP communication connector and LED

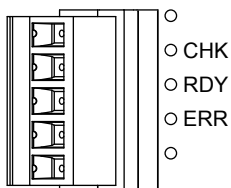

LED	Lit	Unlit
CHK (red)	User profile error	Normal
RDY (green)	Normal. Communicating successfully.	No electricity, or Communication failure
ERR (red)	Not connected, or communication failure (flashing)	Normal

Modbus master wiring

Modbus master wiring is same as RS-485 communication wiring for Ethernet-serial gateway function.

17.4.16 Power Supply Wiring



WARNING

- 1) Wiring work must be carried out by a person with basic electrical knowledge and practical experience.
- 2) Be sure to turn OFF the power supply to the controller before wiring to avoid an electric shock. Use a tester or similar device to ensure that no power is being supplied to a cable to be connected.
- 3) As a safety measure, always install a circuit breaker (an IEC 60947-compatible product, 5 A, 100 V or 220 V AC) in an easily accessible location near the instrument. Moreover, provide indication that the switch is a device for turning off the power to the instrument.
- 4) Install the power cable keeping a distance of more than 1 cm from other signal wires.
- 5) The power cable is required to meet the IEC standards concerned or the requirements of the area in which the instrument is being installed.
- 6) Wiring should be installed to conform to NEC (National Electrical Code: ANSI/NFPA-70) or the wiring construction standards in countries or regions where wiring will be installed.
- 7) Be sure to use a heat-resistant cable for control output, alarm output, and power wiring.

CAUTION

- 1) Provide electricity from a single-phase power supply. If the power is noisy, install an isolation transformer on the primary side, and use a line filter on the secondary side. When measures against noise are taken, do not install the primary and secondary power cables close to each other.
- 2) If there is a risk of external lightning surges, use a lightning arrester etc.

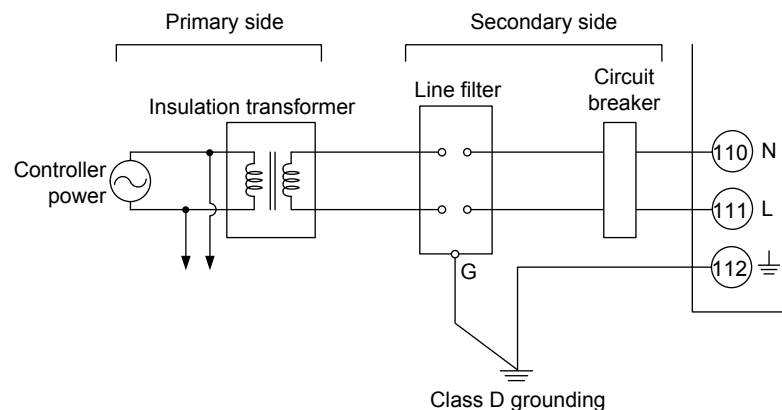

17.5 Attaching and Detaching Terminal Cover

After completing the wiring, the terminal cover is recommended to use for the instrument.

Attaching Method

(1) Attach the terminal cover to the rear panel of the main unit horizontally.

(2) The following figure is a mounting image.

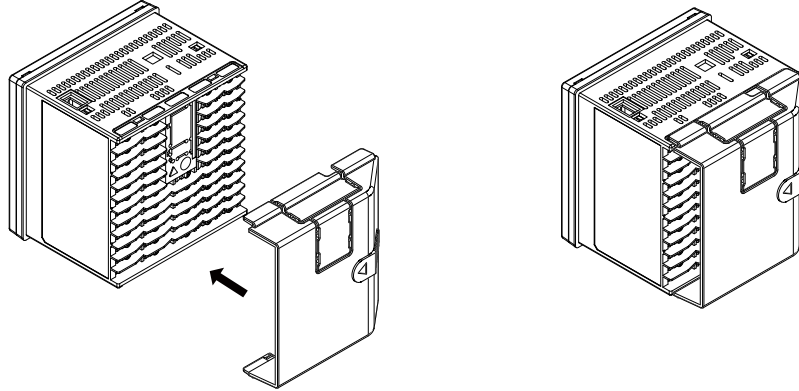

When Ethernet communication and PROFIBUS-DP communication is specified, cut and use a terminal cover as follows.

Cut the cover carefully using nippers etc. so that sharp edge does not remain.

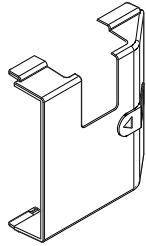

Detaching Method

(1) Slide the terminal cover to the direction of the printed arrow.

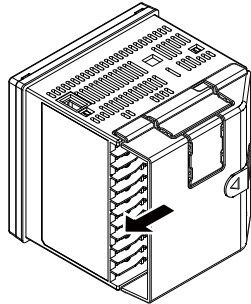

18.1 Parameter Map

Brief Description of Parameter Map

Group Display

"E1 to E4" and "1 to 4, R" appearing in the parameter map are displayed on Group display (7 segments, 2 digits) while the menu or parameter is displayed.

E1: indicates the parameter in E1-terminal area

E3: indicates the parameter in E3-terminal area

E4: indicates the parameter in E4-terminal area

1 to 4, R: indicate the group numbers

► [E1 to E4: Terminal assignments in 17.4 Wiring](#)

Parameter Display Level

The marks below appearing next to the menu symbol and parameter symbol in the parameter map indicate the display/non-display level.

Mark	Display	Display level	Description
None	EASY	Easy setting mode: Displays the minimum parameters.	Corresponding parameters are displayed in all modes.
Ⓢ	STD	Standard setting mode: Displays a wider range of parameters than displayed in the Easy setting mode.	Corresponding parameters are displayed only in Standard setting mode and Professional setting mode. Parameter display level indicators "EASY" and "PRO" are unlit in Standard setting mode. *: "STD" is the symbol used in this manual only.
Ⓟ	PRO	Professional setting mode: Displays all parameters.	Corresponding parameters are displayed only in Professional setting mode.

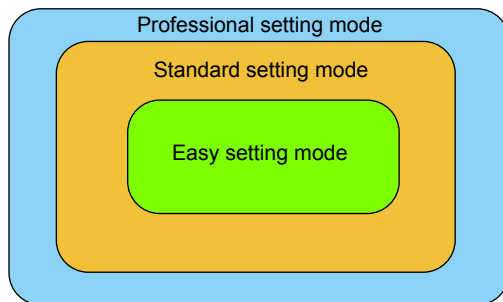

► [Display level: 13.3.2 Setting Parameter Display Level](#)

Function of Each Menu

Menu symbol	Function
MODE	Operation mode (STOP/RUN switch, REMOTE/LOCAL switch, Auto-tuning switch, SP number selection, etc.)

The parameters in the menu of the following table indicate the parameters to set the functions necessary for operation. The symbol in parentheses are shown on Group display.

Menu symbol	Function
CS	SELECT parameter
SP	SP and alarm setpoint
SPS	SP-related function
ALRM	Alarm function
PVS	PV-related function
PID	PID setting
TUNE	Super, Super 2, anti-reset windup, output velocity limiter, and manual preset output
ZONE	Zone control
PPAR	P parameter (for ladder program)

The parameters in the menu of the following table indicate the parameters to set the basic functions of the controller. The symbol in parentheses are shown on Group display.

Menu symbol	Functions
PASS	Password setting (Displayed only when the password has been sent.)

Menu symbol	Functions
CTL	Control type, number of SP groups, number of PID groups, etc
PV	PV input type, range, scale, etc
MPV	Input range, SP limiters
OUT	Control output type, valve position adjustment, retransmission output, etc.
HBA	Heater break alarm
R485 (E1)	RS-485 communication (E1-terminal area)
R485 (E3)	RS-485 communication (E3-terminal area)
ETHR (E3)	Ethernet communication, gateway setting, IP access restriction, etc. (E3-terminal area)
PROF (E3)	PROFIBUS-DP communication (E3-terminal area)
KEY	Function of User function key
DISP	Display functions
CSEL	SELECT Display, SELECT parameter registration
KLOC	Key lock
MLOC	Parameter menu lock
DI.SL	Contact input function
DI.NU	Contact input function (bit selection)
DI.D	Contact input type (equipped as standard)
DI.D (E1)	Contact input type (E1-terminal area)
ALM	Alarm output function, contact output type (equipped as standard)
DO (E1)	Contact output function, contact output type (E1-terminal area)
DO (E3)	Contact output function, contact output type (E3-terminal area)
I/O	Input / output data display
SYS	Action setting when recovering from a power failure, guide display language, password setting, etc
INIT	Initialization of parameter
VER	Error status, version, MAC address, etc
LVL	Parameter display level

Note

Some parameters are not displayed according to the setting such as control type, or input and output.

18.1 Parameter Map

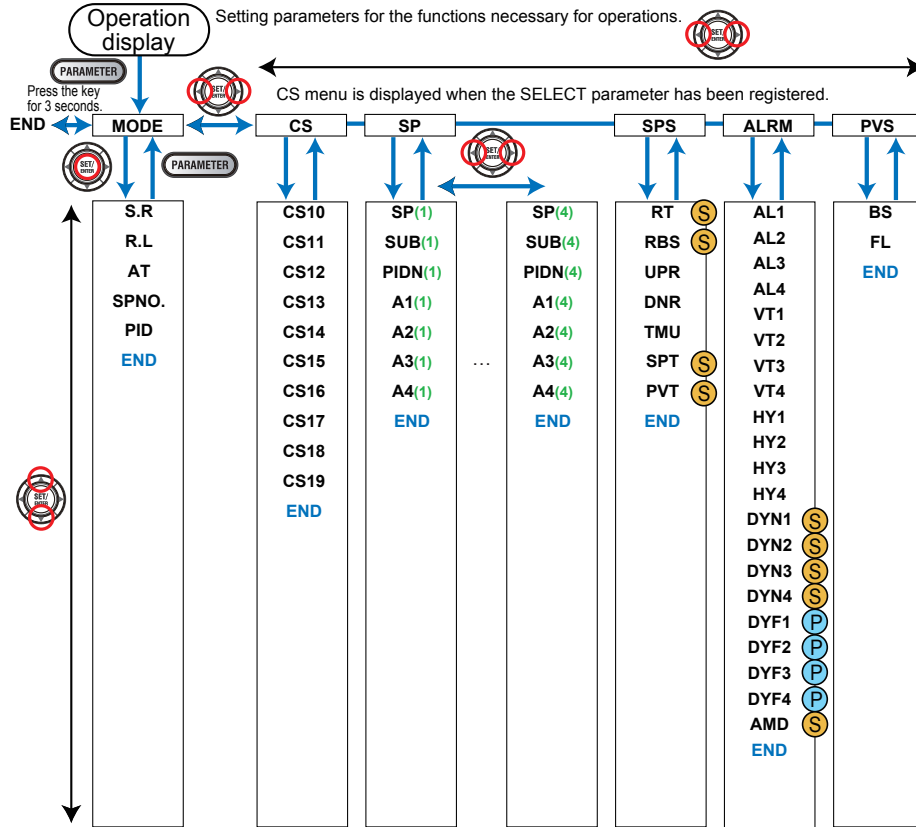

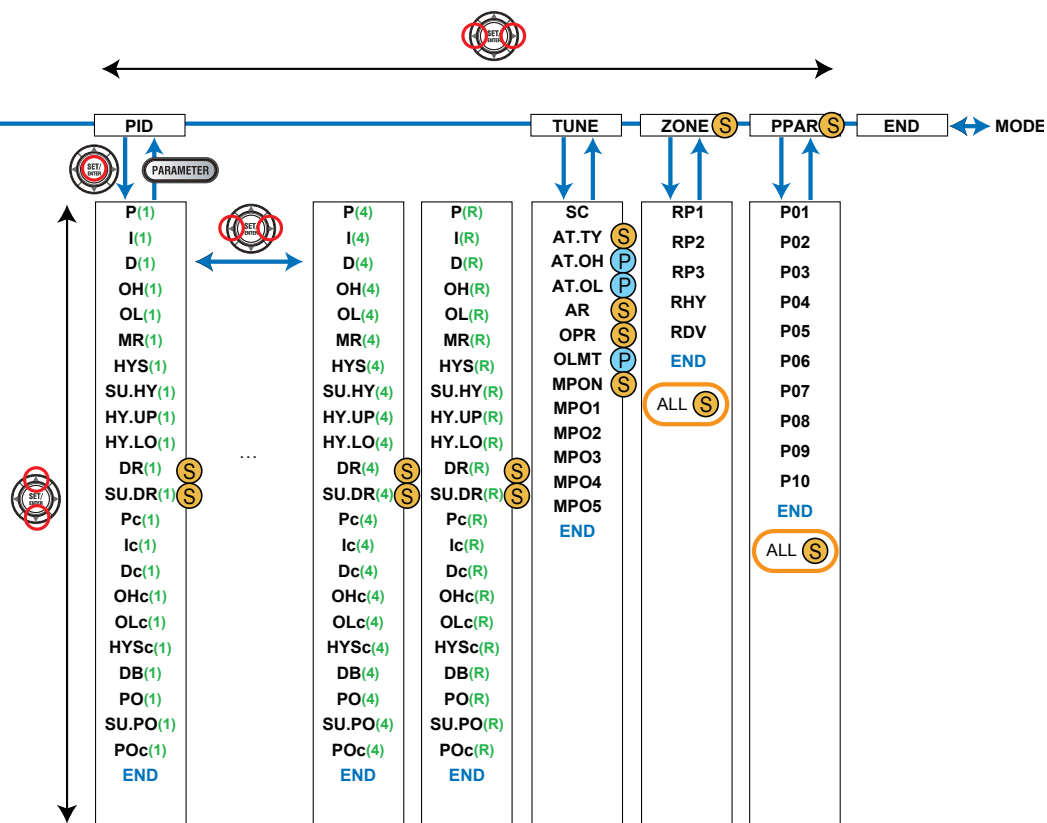

18.1 Parameter Map

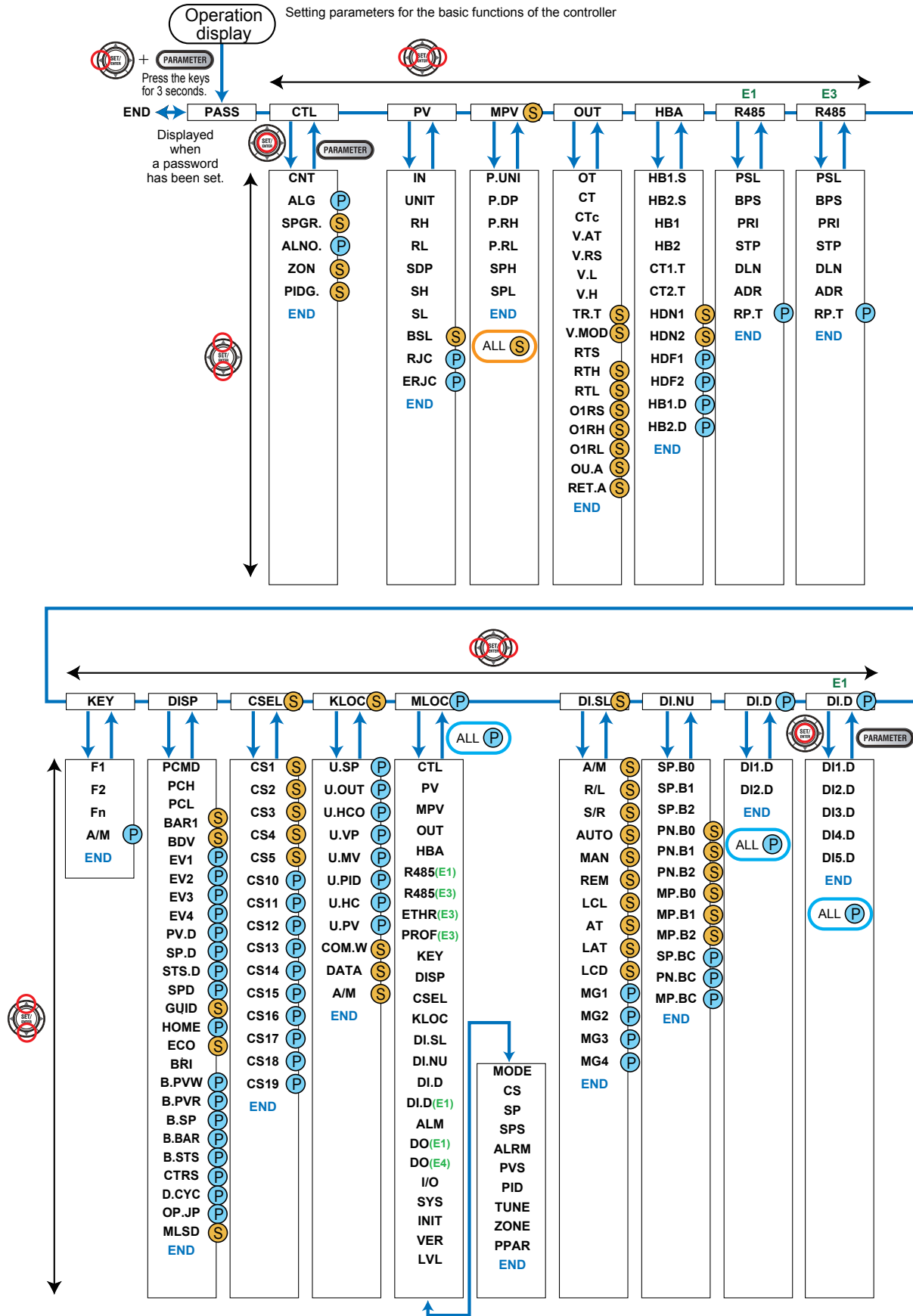

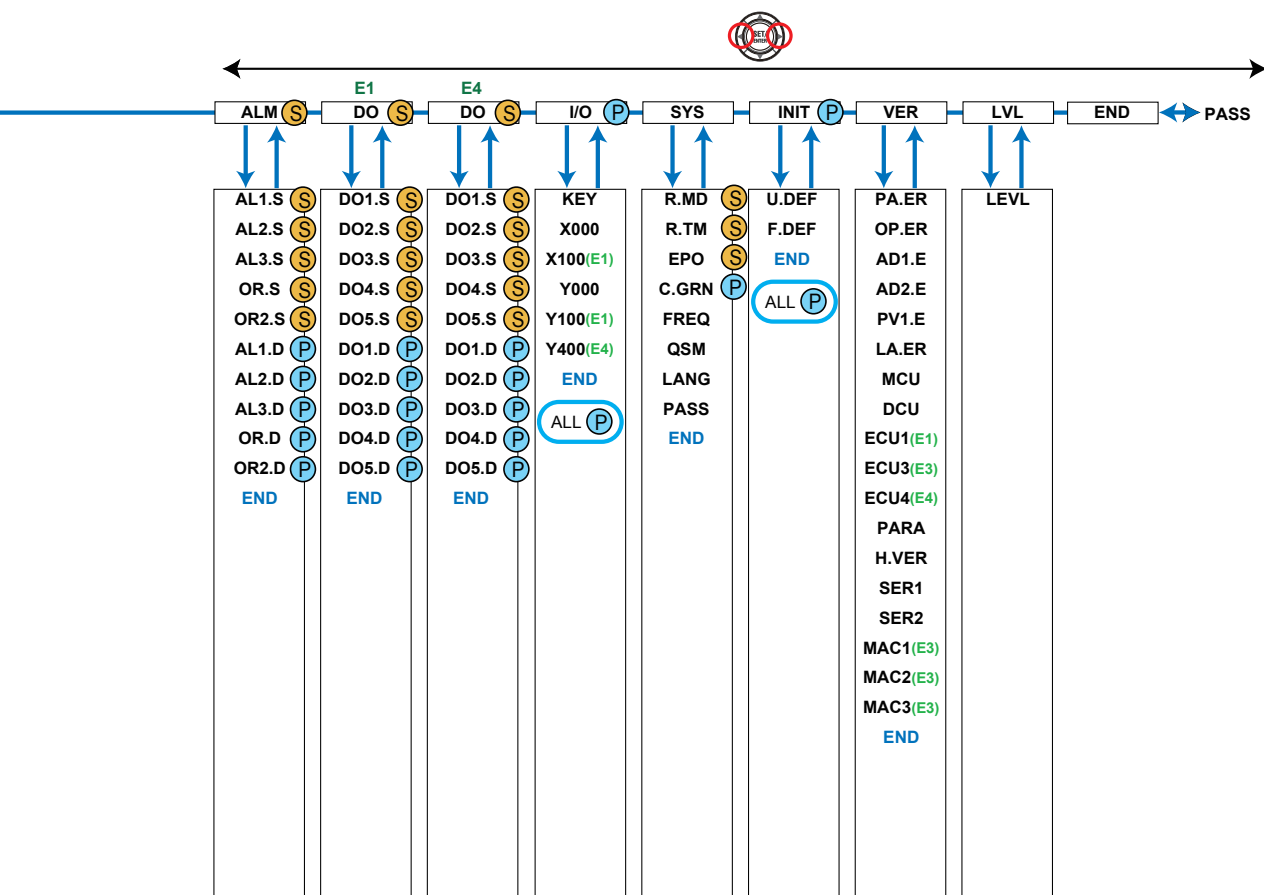
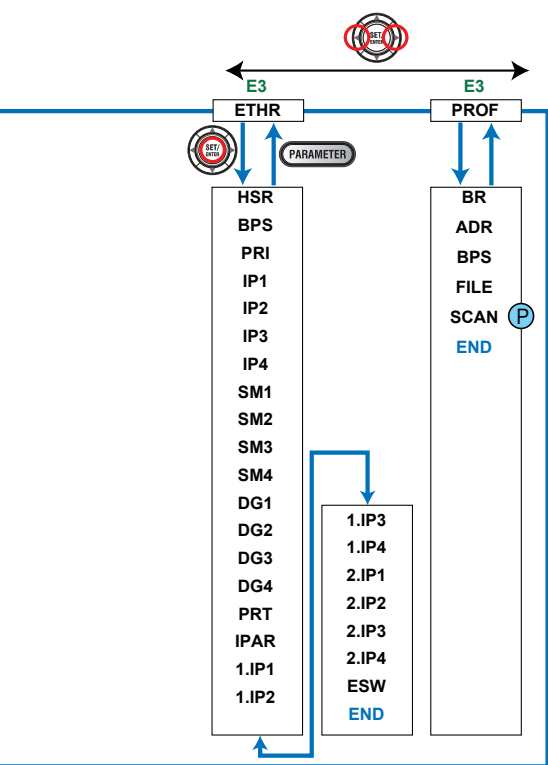

18.2 List of Parameters

18.2.1 Operation Parameters

Operaiton Mode Menu (Menu: MODE)

Parameter symbol	Name	Display level	Setting range	Initial value
S.R	STOP/RUN switch	EASY	STOP: Stop mode RUN: Run mode Preset output (PO) is generated in STOP mode. Default: Not displayed. STOP/RUN switch is assigned to contact input.	RUN
R.L	REMOTE/LOCAL switch	EASY	LCL: Local mode REM: Remote mode (Displayed only in cases where the communication is specified.)	LCL
AT	Auto-tuning switch	EASY	OFF: Disable 1 to 4: Perform auto-tuning. Tuning result is stored in the specified numbered PID. R: Tuning result is stored in the PID for reference deviation.	OFF
SPNO.	SP number selection	EASY	1 to 4 (Depends on the setup parameter SPGR. setting.)	1
PID	PID number	EASY	The PID group number being selected is displayed. 1 to 4, R: PID group for reference deviation	1

SELECT Parameter Menu (Menu: CS)

Parameter symbol	Name	Display level	Setting range	Initial value
CS10 to CS19	SELECT parameter 10 to 19	EASY	Setting range of a registered parameter.	0

SP and Alarm Setpoint Setting Menu (Menu: SP)

Parameter symbol	Name	Display level	Setting range	Initial value
SP	Target setpoint	EASY	0.0 to 100.0% of PV input range (EU) (Setting range: SPL to SPH)	SPL
SUB	Sub-target setpoint (in Two-position two-level control)	EASY	Set the offset from SP. -100.0 to 100.0% of PV input range span (EUS)	0.0 % of PV input range span
PIDN	PID number selection	EASY	1 to 4 (Depends on the PIDG. setting.)	Same as SP number.
A1 to A4	Alarm-1 to -4 setpoint	EASY	Set a display value of setpoint of PV alarm, SP alarm, deviation alarm, output alarm, or velocity alarm. -19999 to 30000 (Set a value within the input range.) Decimal point position depends on the input type.	0

SP-related Setting Menu (Menu: SPS)

Parameter symbol	Name	Display level	Setting range	Initial value
RT	Remote input ratio	STD	0.001 to 9.999 (Displayed only in cases where the communication is specified.)	1.000
RBS	Remote input bias	STD	-100.0 to 100.0% of PV input range span (EUS) (Displayed only in cases where the communication is specified.)	0.0 % of PV input range span
UPR	SP ramp-up rate	EASY	OFF, 0.0 + 1 digit to 100.0% of PV input range span (EUS)	OFF
DNR	SP ramp-down rate	EASY		OFF
TMU	SP ramp-rate time unit	EASY	HOUR: Ramp-up rate or ramp-down rate per hour MIN: Ramp-up rate or ramp-down rate per minute	HOUR
SPT	SP tracking selection	STD	OFF, ON	ON
PVT	PV tracking selection	STD	OFF, ON	OFF

18.2 List of Parameters

Alarm Function Setting Menu (Menu: ALRM)

Parameter symbol	Name	Display level	Setting range	Initial value
AL1 to AL4	Alarm-1 to -4 type	EASY	<p>Set a 5-digit value in the following order. [Alarm type: 2 digits (see below)] + [Without (0) or With (1) Stand-by action] + [Energized (0) or De-energized (1)] + [Latch action (0/1/2/3/4)] For latch action, see chapter 11.</p> <p>Alarm type: 2 digits 00: Disable 01: PV high limit 02: PV low limit 03: SP high limit 04: SP low limit 05: Deviation high limit 06: Deviation low limit 07: Deviation high and low limits 08: Deviation within high and low limits 09: Target SP high limit 10: Target SP low limit 11: Target SP deviation high limit 12: Target SP deviation low limit 13: Target SP deviation high and low limits 14: Target SP deviation within high and low limits 15: OUT high limit 16: OUT low limit 17: Cooling-side OUT high limit 18: Cooling-side OUT low limit 19: Analog input PV high limit 20: Analog input PV low limit 27: Feedback input high limit 28: Feedback input low limit 29: PV velocity 30: Fault diagnosis 31: FAIL</p>	AL1, AL3: PV high limit (01) Without Stand-by action (0) Energized (0) Latch action (0) AL2, AL4: PV low limit (02) Without Stand-by action (0) Energized (0) Latch action (0)
VT1 to VT4	PV velocity alarm time setpoint 1 to 4	EASY	0.01 to 99.59 (minute.second)	1.00
HY1 to HY4	Alarm-1 to -4 hysteresis	EASY	Set a display value of setpoint of hysteresis. -19999 to 30000 (Set a value within the input range.) Decimal point position depends on the input type.	10
DYN1 to DYN4	Alarm-1 to -4 On-delay timer	STD	0.00 to 99.59 (minute.second)	0.00
DYF1 to DYF4	Alarm-1 to -4 Off-delay timer	PRO		0.00
AMD	Alarm mode	STD	0: Always active 1: Not active in STOP mode 2: Not active in STOP or MAN mode	0

PV-related Setting Menu (Menu: PVS)

Parameter symbol	Name	Display level	Setting range	Initial value
BS	PV input bias	EASY	-100.0 to 100.0% of PV input range span (EUS)	0.0 % of PV input range span
FL	PV input filter	EASY	OFF, 1 to 120 s	OFF

PID Setting Menu (Menu: PID)

Parameter symbol	Name	Display level	Setting range	Initial value
P	Proportional band Heating-side proportional band (in Heating/cooling control)	EASY	0.0 to 999.9% When 0.0% is set, it operates as 0.1%. Heating-side ON/OFF control applies when 0.0% in Heating/ cooling control	5.0%
I	Integral time Heating-side integral time (in Heating/cooling control)	EASY	OFF: Disable 1 to 6000 s	240 s
D	Derivative time Heating-side derivative time (in Heating/cooling control)	EASY	OFF: Disable 1 to 6000 s	60 s
OH	Control output high limit Heating-side control output high limit (in Heating/cooling control)	EASY	-4.9 to 105.0%, (OL<OH) In Heating/cooling control: 0.1 to 105.0% (OL<OH)	100.0%
OL	Control output low limit Heating-side control output low limit (in Heating/cooling control)	EASY	-5.0 to 104.9%, (OL<OH), SD: Tight shut In Heating/cooling control: 0.0 to 104.9% (OL<OH)	0.0%
MR	Manual reset	EASY	Enabled when integral time is OFF. The manual reset value equals the output value when PV = SP. -5.0 to 105.0%	50.0%
HYS	Hysteresis (in ON/OFF control, Position proportional control, or Two-position two- level control) Heating-side ON/OFF control hysteresis (in Heating/cooling control)	EASY	In ON/OFF control or Two-position two-level control: 0.0 to 100.0% of PV input range span (EUS) In Heating/cooling control or Position proportional control: 0.0 to 100.0%	In ON/OFF control or Two- position two- level control: 0.5 % of PV input range span In Heating/ cooling control or Position proportional control: 0.5 %
SU.HY	Sub-hysteresis (in Two-position two- level control)	EASY	0.0 to 100.0% of PV input range span (EUS)	0.5 % of PV input range span
HY.UP	Upper-side hysteresis (in ON/ OFF control)	EASY	0.0 to 100.0% of PV input range span (EUS)	0.5 % of PV input range span
HY.LO	Lower-side hysteresis (in ON/ OFF control)	EASY		0.5 % of PV input range span
DR	Direct/reverse action switch	STD	RVS: Reverse action, DIR: Direct action	RVS
SU.DR	Sub-direct/reverse action switch (in Two-position two- level control)	STD		DIR

18.2 List of Parameters

PID Setting Menu (Menu: PID) (Continued from previous page)

Parameter symbol	Name	Display level	Setting range	Initial value
Pc	Cooling-side proportional band	EASY	0.0 to 999.9% (Cooling-side ON/OFF control applies when 0.0% in Heating/cooling control)	5.0%
Ic	Cooling-side integral time	EASY	OFF: Disable 1 to 6000 s	240 s
Dc	Cooling-side derivative time	EASY	OFF: Disable 1 to 6000 s	60 s
OHc	Cooling-side control output high limit	EASY	0.1 to 105.0%, (OLc<OHc)	100.0%
OLc	Cooling-side control output low limit	EASY	0.0 to 104.9%, (OLc<OHc)	0.0%
HYSc	Cooling-side ON/OFF control hysteresis	EASY	0.0 to 100.0%	0.5%
DB	Output dead band (in Heating/cooling control or Position proportional control)	EASY	In Heating/cooling control: -100.0 to 50.0% In Position proportional control: 1.0 to 10.0%	3.0%
PO	Preset output Heating-side preset output (in Heating/cooling control)	EASY	-5.0 to 105.0%	0.0%
SU.PO	Sub-preset output (in Two-position two-level control)	EASY	0%, 100%	0%
POc	Cooling-side preset output	EASY	-5.0 to 105.0%	0.0%

Tuning Menu (Menu: TUNE)

Parameter symbol	Name	Display level	Setting range	Initial value
SC	Super function	EASY	OFF: Disable 1: Overshoot suppressing function (normal mode) 2: Hunting suppressing function (stable mode) Enables to answer the wider characteristic changes compared with response mode. 3: Hunting suppressing function (response mode) Enables quick follow-up and short converging time of PV for the changed SP. 4: Overshoot suppressing function (strong suppressing mode)	OFF
AT.TY	Auto-tuning type	STD	0: Normal 1: Stability	0
AT.OH	Output high limit in auto-tuning	PRO	-5.0 to 105.0% (Disabled in Heating/cooling control)	100.0%
AT.OL	Output low limit in auto-tuning	PRO		0.0%
AR	Anti-reset windup (excess integration prevention)	STD	AUTO, 50.0 to 200.0%	AUTO
OPR	Output velocity limiter	STD	OFF: Disable 0.1 to 100.0%/s	OFF
OLMT	Output limiter switch	PRO	OFF: Disable output limiter in MAN mode ON: Enable output limiter in MAN mode	ON
MPON	Manual preset output number selection	STD	OFF: Hold the control output in AUTO mode (bumpless) 1: Use manual preset output 1 (output bump) 2: Use manual preset output 2 (output bump) 3: Use manual preset output 3 (output bump) 4: Use manual preset output 4 (output bump) 5: Use manual preset output 5 (output bump)	OFF
MPO1 to MPO5	Manual preset output 1 to 5	STD	-5.0 to 105.0%	0.0%

18.2 List of Parameters

Zone Control Menu (Menu: ZONE)

Parameter symbol	Name	Display level	Setting range	Initial value
RP1 to RP3	Reference point 1 to 3	STD	0.0 to 100.0% of PV input range (EU) ($RP1 \leq RP2 \leq RP3$)	100.0 % of PV input range
RHY	Zone PID switching hysteresis	STD	0.0 to 10.0% of PV input range span (EUS)	0.5 % of PV input range span
RDV	Reference deviation	STD	OFF: Disable 0.0 + 1 digit to 100.0% of PV input range span (EUS)	OFF

P Parameter Menu (Menu: PPAR)

Parameter symbol	Name	Display level	Setting range	Initial value
P01 to P10	P01 to P10 parameter	STD	-19999 to 30000 (Set a decimal point position using LL50A Parameter Setting Software.)	0

18.2.2 Setup Parameters

Control Function Setting Menu (Menu: CTL)

Parameter symbol	Name	Display level	Setting range	Initial value
CNT	Control type	EASY	PID: PID control ONOF: ON/OFF control (1 point of hysteresis) ONOF2: ON/OFF control (2 points of hysteresis) 2P2L: Two-position two-level control H/C: Heating/cooling control	PID
ALG	PID control mode	PRO	0: Standard PID control mode 1: Fixed-point control mode	0
SPGR.	Number of SP groups	STD	1 to 4	4
ALNO.	Number of alarms	PRO	1 to 4	4
ZON	Zone PID selection	STD	0: SP group number selection 1 1: Zone PID selection (selection by PV) 2: Zone PID selection (selection by target SP) 3: SP group number selection 2 4: Zone PID selection (selection by SP)	0
PIDG.	Number of PID groups	STD	1 to 4	4

18.2 List of Parameters

PV Input Setting Menu (Menu: PV)

Parameter symbol	Name	Display level	Setting range	Initial value
IN	PV input type	EASY	OFF: Disable K1: -270.0 to 1370.0 (°C) / -450.0 to 2500.0 (°F) K2: -270.0 to 1000.0 (°C) / -450.0 to 2300.0 (°F) K3: -200.0 to 500.0 (°C) / -200.0 to 1000.0 (°F) J: -200.0 to 1200.0 (°C) / -300.0 to 2300.0 (°F) T1: -270.0 to 400.0 (°C) / -450.0 to 750.0 (°F) T2: 0.0 to 400.0 (°C) / -200.0 to 750.0 (°F) B: 0.0 to 1800.0 (°C) / 32 to 3300 (°F) S: 0.0 to 1700.0 (°C) / 32 to 3100 (°F) R: 0.0 to 1700.0 (°C) / 32 to 3100 (°F) N: -200.0 to 1300.0 (°C) / -300.0 to 2400.0 (°F) E: -270.0 to 1000.0 (°C) / -450.0 to 1800.0 (°F) L: -200.0 to 900.0 (°C) / -300.0 to 1600.0 (°F) U1: -200.0 to 400.0 (°C) / -300.0 to 750.0 (°F) U2: 0.0 to 400.0 (°C) / -200.0 to 1000.0 (°F) W: 0.0 to 2300.0 (°C) / 32 to 4200 (°F) PL2: 0.0 to 1390.0 (°C) / 32.0 to 2500.0 (°F) P2040: 0.0 to 1900.0 (°C) / 32 to 3400 (°F) WRE: 0.0 to 2000.0 (°C) / 32 to 3600 (°F) JPT1: -200.0 to 500.0 (°C) / -300.0 to 1000.0 (°F) JPT2: -150.00 to 150.00 (°C) / -200.0 to 300.0 (°F) PT1: -200.0 to 850.0 (°C) / -300.0 to 1560.0 (°F) PT2: -200.0 to 500.0 (°C) / -300.0 to 1000.0 (°F) PT3: -150.00 to 150.00 (°C) / -200.0 to 300.0 (°F) 0.4-2V: 0.400 to 2.000 V 1-5V: 1.000 to 5.000 V 4-20: 4.00 to 20.00 mA 0-2V: 0.000 to 2.000 V 0-10V: 0.00 to 10.00 V 0-20: 0.00 to 20.00 mA -1020: -10.00 to 20.00 mV 0-100: 0.0 to 100.0 mV Note: W: W-5% Re/W-26% Re (Hoskins Mfg. Co.), ASTM E988 WRE: W97Re3-W75Re25	OFF
UNIT	PV input unit	EASY	-: No unit C: Degree Celsius -: No unit --: No unit ---: No unit F: Degree Fahrenheit	C
RH	Maximum value of PV input range	EASY	Depends on the input type. - For temperature input - Set the temperature range that is actually controlled. (RL<RH)	Depends on the input type
RL	Minimum value of PV input range	EASY	- For voltage / current input - Set the range of a voltage / current signal that is applied. The scale across which the voltage / current signal is actually controlled should be set using the maximum value of input scale (SH) and minimum value of input scale (SL). (Input is always 0% when RL = RH.)	Depends on the input type

PV Input Setting Menu (Menu: PV) (Continued from previous page)

Parameter symbol	Name	Display level	Setting range	Initial value
SDP	PV input scale decimal point position	EASY	0: No decimal place 1: One decimal place 2: Two decimal places 3: Three decimal places 4: Four decimal places	Depends on the input type
SH	Maximum value of PV input scale	EASY	-19999 to 30000, (SL<SH), SH - SL ≤ 30000	Depends on the input type
SL	Minimum value of PV input scale	EASY		Depends on the input type
BSL	PV input burnout action	STD	OFF: Disable UP: Upscale DOWN: Downscale	Depends on the input type
RJC	PV input reference junction compensation	PRO	OFF: RJC OFF ON: RJC ON	ON
ERJC	PV input external RJC setpoint	PRO	-10.0 to 60.0 (°C)	0.0

Input Range / SP Limiter Setting Menu (Menu: MPV)

Parameter symbol	Name	Display level	Setting range	Initial value
P.UNI	Control PV input unit	STD	-: No unit C: Degree Celsius --: No unit ---: No unit F: Degree Fahrenheit	Same as PV input unit
P.DP	Control PV input decimal point position	STD	0: No decimal place 1: One decimal place 2: Two decimal places 3: Three decimal places 4: Four decimal places	1
P.RH	Maximum value of control PV input range	STD	-19999 to 30000, (P.RL<P.RH), P.RH - P.RL ≤ 30000	Depends on the input type
P.RL	Minimum value of control PV input range	STD		Depends on the input type
SPH	SP high limit	STD	0.0 to 100.0% of PV input range (EU), (SPL<SPH)	100.0 % of PV input range
SPL	SP low limit	STD		0.0 % of PV input range

18.2 List of Parameters

Output Setting Menu (Menu: OUT)

Parameter symbol	Name	Display level	Setting range	Initial value
OT	Output type selection	EASY	Control output or Heating-side control output (Lower two digits) 00: OFF 01: OUT terminals (voltage pulse) 02: OUT terminals (current) 03: OUT terminals (relay) 06: OUT2 terminals (relay) 07: RET/OUT2 terminals (voltage pulse) 08: RET/OUT2 terminals (current) Cooling-side control output (Upper two digits) 00: OFF 01: OUT terminals (voltage pulse) 02: OUT terminals (current) 03: OUT terminals (relay) 06: OUT2 terminals (relay) 07: RET/OUT2 terminals (voltage pulse) 08: RET/OUT2 terminals (current)	Standard type: 00.03 Heating/ cooling type: 06.03
CT	Control output cycle time Heating-side control output cycle time (in Heating/cooling control)	EASY	0.5 to 1000.0 s	30.0 s
CTc	Cooling-side control output cycle time	EASY		30.0 s
V.AT	Automatic valve position adjustment	EASY	OFF: Stop automatic adjustment ON: Start automatic adjustment	OFF
V.RS	Valve position setting reset	EASY	Setting V.RS to ON resets the valve adjustment settings and causes the indication "V.RS" to blink.	OFF
V.L	Fully-closed valve position setting	EASY	Pressing the SET/ENTER key with valve position set to the fully-closed position by Down arrow key causes the adjusted value to be stored. When V.L adjustment is complete, V.L stops blinking.	-
V.H	Fully-open valve position setting	EASY	Pressing the SET/ENTER key with valve position set to the fully-opened position by Up arrow key causes the adjusted value to be stored. When V.H adjustment is complete, V.H stops blinking.	-
TR.T	Valve traveling time	STD	5 to 300 s	60 s
V.MOD	Valve adjusting mode	STD	0: Valve position feedback type 1: Valve position feedback type (moves to the estimating type if a feedback input error or break occurs.) 2: Valve position estimating type	0

Output Setting Menu (Menu: OUT) (Continued from previous page)

Parameter symbol	Name	Display level	Setting range	Initial value
RTS	Retransmission output type of RET	EASY	OFF: Disable PV1: PV SP1: SP OUT1: OUT (Valve opening: 0 to 100 % in Position proportional control) LPS: 15 V DC loop power supply TSP1: Target SP HOUT1: Heating-side OUT COUT1: Cooling-side OUT MV1: Position proportional output internal computed value) PV: PV terminals analog input	PV1
RTH	Maximum value of retransmission output scale of RET	STD	When RTS = PV1, SP1, TSP1, PV RTL + 1 digit to 30000 -19999 to RTH - 1 digit	100 % of PV input range
RTL	Minimum value of retransmission output scale of RET	STD	Decimal point position: When RTS=PV1, SP1, or TSP1, decimal point position is same as that of PV input. When RTS=PV, decimal point position is same as that of PV input scale.	0 % of PV input range
O1RS	Retransmission output type of OUT current output	STD	Same as RTS	OFF
O1RH	Maximum value of retransmission output scale of OUT current output	STD	When O1RS = PV1, SP1, TSP1, PV O1RL + 1 digit to 30000 -19999 to O1RH - 1 digit	-
O1RL	Minimum value of retransmission output scale of OUT current output	STD	Decimal point position: When O1RS=PV1, SP1, or TSP1, decimal point position is same as that of PV input. When O1RS =PV, decimal point position is same as that of PV input scale.	-
OU.A	OUT current output range	STD	4-20: 4 to 20 mA 0-20: 0 to 20 mA	4-20
RET.A	RET current output range	STD	20-4: 20 to 4 mA 20-0: 20 to 0 mA	4-20

18.2 List of Parameters

Heater Break Alarm Setting Menu (Menu: HBA)

Parameter symbol	Name	Display level	Setting range	Initial value
HB1.S, HB2.S	Heater break alarm-1, -2 function selection	EASY	0: Heater current measurement 1: Heater break alarm (Heating-side) 2: Cooling-side heater break alarm	1
HB1, HB2	Heater break alarm-1, -2 current setpoint	EASY	OFF, 0.1 to 300.0 Arms	OFF
CT1.T, CT2.T	CT1, CT2 coil winding number ratio	EASY	1 to 3300	800
HDN1, HDN2	Heater break alarm-1, -2 On-delay timer	STD	0.00 to 99.59 (minute.second)	0.00
HDF1, HDF2	Heater break alarm-1, -2 Off-delay timer	PRO		0.00
HB1.D, HB2.D	Heater break alarm-1, -2 contact type	PRO	CLS: When the event occurs, the contact is closed. OPN: When the event occurs, the contact is opened.	CLS

RS-485 Communication Setting Menu (Menu: R485) (E1 and E3 terminal area)

Parameter symbol	Name	Display level	Setting range	Initial value
PSL	Protocol selection	EASY	PCL: PC link communication PCLSM: PC link communication (with checksum) LADR: Ladder communication CO-M: Coordinated master station CO-S: Coordinated slave station MBASC: Modbus (ASCII) MBRTU: Modbus (RTU) CO-S1: Coordinated slave station (Loop-1 mode) CO-S2: Coordinated slave station (Loop-2 mode) P-P: Peer-to-peer communication	MBRTU
BPS	Baud rate	EASY	600: 600 bps 1200: 1200 bps 2400: 2400 bps 4800: 4800 bps 9600: 9600 bps 19200: 19.2k bps 38400: 38.4k bps	19200
PRI	Parity	EASY	NONE: None EVEN: Even ODD: Odd	EVEN
STP	Stop bit	EASY	1: 1 bit, 2: 2 bits	1
DLN	Data length	EASY	7: 7 bits, 8: 8 bits	8
ADR	Address	EASY	1 to 99	1
RP.T	Minimum response time	PRO	0 to 10 (x10ms)	0

When each parameter is displayed, the terminal area (E1 or E3) is displayed on Group display.

• Parameter: PSL, BPS, STP, DLN, ADR, RP.T

18.2 List of Parameters

Ethernet Communication Setting Menu (Menu: ETHR) (E3 terminal area)

Parameter symbol	Name	Display level	Setting range	Initial value
HSR	High-speed response mode	EASY	OFF, 1 to 8	1
BPS	Baud rate	EASY	9600: 9600 bps 19200: 19.2k bps 38400: 38.4k bps	38400
PRI	Parity	EASY	NONE: None EVEN: Even ODD: Odd	EVEN
IP1 to IP4	IP address 1 to 4	EASY	0 to 255 Initial value: 192.168.1.1	See left
SM1 to SM4	Subnet mask 1 to 4	EASY	0 to 255 Initial value: 255.255.255.0	See left
DG1 to DG4	Default gateway 1 to 4	EASY	0 to 255 Initial value: 0.0.0.0	See left
PRT	Port number	EASY	502, 1024 to 65535	502
IPAR	IP access restriction	EASY	OFF: Disable, ON: Enable	OFF
1.IP1 to 1.IP4	Permitted IP address 1-1 to 1-4	EASY	0 to 255 Initial value: 255.255.255.255	See left
2.IP1 to 2.IP4	Permitted IP address 2-1 to 2-4	EASY	0 to 255 Initial value: 255.255.255.255	See left
ESW	Ethernet setting switch	EASY	OFF, ON	OFF

When each parameter is displayed, the terminal area (E3) is displayed on Group display.

PROFIBUS-DP Communication Setting Menu (Menu: PROF) (E3 terminal area)

Parameter symbol	Name	Display level	Setting range	Initial value
BR	Baud rate	EASY	9.6K: 9.6k bps 19.2K: 19.2k bps 93.75K: 93.75k bps 187.5K: 187.5k bps 0.5M: 0.5M bps 1.5M: 1.5M bps 3M: 3M bps 6M: 6M bps 12M: 12M bps AUTO 45.45K: 45.45k bps	AUTO
ADR	Address	EASY	0 to 125	3
BPS	Baud rate	EASY	9600: 9600 bps 19200: 19.2k bps 38400: 38.4k bps	38400
FILE	Profile number	EASY	0 to 3	0
SCAN	Automatic rescan time	PRO	OFF 1M: 1 minute 10M: 10 minutes 30M: 30 minutes 60M: 60 minutes	OFF

When each parameter is displayed, the terminal area (E3) is displayed on Group display.

Key Action Setting Menu (Menu: KEY)

Parameter symbol	Name	Display level	Setting range	Initial value
F1 to F2	User function key-1, -2 action setting	EASY	OFF: Disable A/M: AUTO/MAN switch	OFF
Fn	User function key-n action setting	EASY	R/L1: REM/LCL switch S/R: STOP/RUN switch AUTO: Switch to AUTO MAN: Switch to MAN REM1: Switch to REM LCL1: Switch to LCL STOP: Switch to STOP RUN: Switch to RUN AT: Auto-tuning LTUP: LCD brightness UP LTDN: LCD brightness DOWN BRI: Adjust LCD brightness LCD: LCD backlight ON/OFF switch LAT: Latch release PID: PID tuning switch	PID
A/M	A/M key action setting	PRO	OFF: Disable A/M: AUTO/MAN switch R/L1: REM/LCL switch S/R: STOP/RUN switch AUTO: Switch to AUTO MAN: Switch to MAN	A/M

18.2 List of Parameters

Display Function Setting Menu (Menu: DISP)

Parameter symbol	Name	Display level	Setting range	Initial value
PCMD	Active color PV display switch	EASY	0: Fixed in white 1: Fixed in red 2: Link to alarm 1 (Alarm OFF: white, Alarm ON: red) 3: Link to alarm 1 (Alarm OFF: red, Alarm ON: white) 4: Link to alarm 1 or 2 (Alarm OFF: white, Alarm ON: red) 5: Link to alarm 1 or 2 (Alarm OFF: red, Alarm ON: white) 6: PV limit (Within range: white, Out of range: red) 7: PV limit (Within range: red, Out of range: white) 8: SP deviation (Within deviation: white, Out of deviation: red) 9: SP deviation (Within deviation: red, Out of deviation: white)	0
PCH	PV color change high limit	EASY	Set a display value when in PV limit or SP deviation.	0
PCL	PV color change low limit	EASY	-19999 to 30000 (Set a value within the input range.) Decimal point position depends on the input type.	0
BAR1	Bar-graph display registration	STD	0: Disable 1:OUT, Heating-side OUT, Internal value in Position proportional control 2: Cooling-side OUT 3: PV 4: SP 5: Deviation 6 to 16: Disable 17: Feedback input (valve opening) 18: PV terminals analog input	5 (Heating/cooling type: 1)
BDV	Bar-graph deviation display band	STD	0.0 to 100.0% of PV input range span (EUS)	10.0 % of PV input range span

Display Function Setting Menu (Menu: DISP) (Continued from previous page)

Parameter symbol	Name	Display level	Setting range	Initial value
EV1 to EV4	EV1 to EV4 display condition registration	PRO	Setting range: 4001 to 6304 OFF: Disable 4321: Link to alarm 1 (Lit when the alarm occurs) 4322: Link to alarm 2 (Lit when the alarm occurs) 4323: Link to alarm 3 (Lit when the alarm occurs) 4325: Link to alarm 4 (Lit when the alarm occurs) 4529: Heater break alarm 1 (Lit when the alarm occurs) 4530: Heater break alarm 2 (Lit when the alarm occurs) 5025 to 5026: Link to DI1-DI2 (Lit when the contact is closed) 5041 to 5045: Link to DI11-DI15 (E1-terminal area) (Lit when the contact is closed) 5153 to 5155: Link to AL1-AL3 (Lit when the contact is closed) 5169 to 5170: Link to DO11-DO12 (E1-terminal area) (Lit when the contact is closed) 5217 to 5221: Link to DO41-DO45 (E4-terminal area) (Lit when the contact is closed) For other functions, see the UTAdvanced Series Communication Interface User's Manual.	EV1: 4321 EV2: 4322 EV3: 4323 EV4: 4325
PV.D	PV display area ON/OFF	PRO	OFF: Nondisplay, ON: Display	ON
SP.D	Setpoint display area ON/OFF	PRO		ON
STS.D	Status display area ON/OFF	PRO		ON
SPD	Scroll speed	PRO	(Slow) 1 to 8 (Quick)	4
GUID	Guide display ON/OFF	STD	OFF: Nondisplay ON: Display	ON
HOME	Home Operation Display setting	PRO	SP1: SP Display OUT1: OUT Display HCO: Heating/cooling OUT Display VP: Valve Position Display MV: Position Proportional Computation Output Display PID1: PID Number Display HC1: Heater Break Alarm-1 Current Display HC2: Heater Break Alarm-2 Current Display PV: PV Analog Input Display CS1 to CS5: SELECT Display 1 to 5	SP1
ECO	Economy mode	STD	OFF: Disable 1: Economy mode ON (All indications except PV display OFF) 2: Economy mode ON (All indications OFF) 3: Brightness 10 % (All indications)	OFF
BRI	Brightness	EASY	(Dark) 1 to 5 (Bright)	3

18.2 List of Parameters

Display Function Setting Menu (Menu: DISP) (Continued from previous page)

Parameter symbol	Name	Display level	Setting range	Initial value
B.PVW	White brightness adjustment of PV display	PRO	Adjusts the white brightness of PV display. (Dark) -4 to 4 (Bright)	0
B.PVR	Red brightness adjustment of PV display	PRO	Adjusts the red brightness of PV display. (Dark) -4 to 4 (Bright)	0
B.SP	Brightness adjustment of SP display	PRO	Adjusts the brightness of SP display. (Dark) -4 to 4 (Bright)	0
B.BAR	Brightness adjustment of Bar-graph display	PRO	Adjusts the brightness of SP display. (Dark) -4 to 4 (Bright)	0
B.STS	Brightness adjustment of Status indicator	PRO	Adjusts the brightness of Status indicator. (Dark) -4 to 4 (Bright)	0
CTRS	Contrast	PRO	(Low) 1 to 6 (High)	6
D.CYC	Display update cycle	PRO	1: 100 ms 2: 200 ms 3: 500 ms 4: 1 s 5: 2 s	2
OP.JP	Autoreturn to operation display	PRO	Automatically returned to the Operation Display when there has been no keystroke operation for 5 minutes. OFF, ON	ON
MLSD	Least significant digital mask of PV display	STD	OFF: With least significant digit ON: Without least significant digit	OFF

SELECT Display Setting Menu (Menu: CSEL)

Parameter symbol	Name	Display level	Setting range	Initial value
CS1 to CS5	SELECT Display-1 to -5 registration	STD	OFF, 2301 to 5000	OFF
CS10 to CS19	SELECT parameter-10 to -19 registration	PRO		OFF

Key Lock Setting Menu (Menu: KLOC)

Parameter symbol	Name	Display level	Setting range	Initial value
U.SP	SP Display lock	PRO	OFF: Display ON: Nondisplay	OFF
U.OUT	OUT Display lock	PRO		OFF
U.HCO	Heating/cooling OUT Display lock	PRO		OFF
U.VP	Valve Position Display lock	PRO		OFF
U.MV	Position Proportional Computation Output Display lock	PRO		ON
U.PID	PID Number Display lock	PRO		ON
U.HC	Heater Break Alarm Current Value Display lock	PRO		OFF
U.PV	PV Analog Input Display lock	PRO		ON
COM.W	Communication write enable/disable	STD	OFF: Enable, ON: Disable	OFF
DATA	Front panel parameter data key lock	STD	OFF: Unlock ON: Lock	OFF
A/M	Front panel A/M key lock	STD		OFF

18.2 List of Parameters

Menu Lock Setting Menu (Menu: MLOC)

Parameter symbol	Name	Display level	Setting range	Initial value
CTL	[CTL] menu lock	PRO	OFF: Display ON: Nondisplay	OFF
PV	[PV] menu lock	PRO		
MPV	[MPV] menu lock	PRO		
OUT	[OUT] menu lock	PRO		
HBA	[HBA] menu lock	PRO		
R485	[R485] menu lock	PRO		
ETHR	[ETHR] menu lock	PRO		
PROF	[PROF] menu lock	PRO		
KEY	[KEY] menu lock	PRO		
DISP	[DISP] menu lock	PRO		
CSEL	[CSEL] menu lock	PRO		
KLOC	[KLOC] menu lock	PRO		
DI.SL	[DI.SL] menu lock	PRO		
DI.NU	[DI.NU] menu lock	PRO		
DI.D	[DI.D] menu lock	PRO		
ALM	[ALM] menu lock	PRO		
DO	[DO] menu lock	PRO		
I/O	[I/O] menu lock	PRO		
SYS	[SYS] menu lock	PRO		
INIT	[INIT] menu lock	PRO		
VER	[VER] menu lock	PRO		
LVL	[LVL] menu lock	PRO		
MODE	[MODE] menu lock	PRO	OFF: Display ON: Nondisplay	OFF
CS	[CS] menu lock	PRO		
SP	[SP] menu lock	PRO		
SPS	[SPS] menu lock	PRO		
ALRM	[ALRM] menu lock	PRO		
PVS	[PVS] menu lock	PRO		
PID	[PID] menu lock	PRO		
TUNE	[TUNE] menu lock	PRO		
ZONE	[ZONE] menu lock	PRO		
PPAR	[PPAR] menu lock	PRO		

When each parameter is displayed, the terminal area (E1 to E4) is displayed on Group display.

- Parameter: R485, ETHR, DI.D, DO

DI Function Registration Menu (Menu: DI.SL)

Parameter symbol	Name	Display level	Setting range	Initial value
A/M	AUTO/MAN switch	STD	Set an I relay number of contact input. Set "OFF" to disable the function. Standard terminals DI1: 5025, DI2: 5026 E1-terminal area DI11: 5041, DI12: 5042, DI13: 5043, DI14: 5044, DI15: 5045	5025
R/L	REMOTE/LOCAL switch	STD		OFF
S/R	STOP/RUN switch	STD		5026
AUTO	Switch to AUTO	STD		OFF
MAN	Switch to MAN	STD		OFF
REM	Switch to REMOTE	STD		OFF
LCL	Switch to LOCAL	STD		OFF
AT	Auto-tuning START/STOP switch	STD		OFF
LAT	Latch release	STD		OFF
LCD	LCD backlight ON/OFF switch	STD		OFF
MG1	Message display interruption 1	PRO		OFF
MG2	Message display interruption 2	PRO		OFF
MG3	Message display interruption 3	PRO		OFF
MG4	Message display interruption 4	PRO		OFF

18.2 List of Parameters

DI Function Numbering Menu (Menu: DI.NU)

Parameter symbol	Name	Display level	Setting range	Initial value
SP.B0	Bit-0 of SP number	EASY	Set an I relay number of contact input. Set "OFF" to disable the function. Standard terminals DI1: 5025, DI2: 5026 E1-terminal area DI11: 5041, DI12: 5042, DI13: 5043, DI14: 5044, DI15: 5045	OFF
SP.B1	Bit-1 of SP number	EASY		OFF
SP.B2	Bit-2 of SP number	EASY		OFF
PN.B0	Bit-0 of PID number	STD		OFF
PN.B1	Bit-1 of PID number	STD		OFF
PN.B2	Bit-2 of PID number	STD		OFF
MP.B0	Bit-0 of manual preset output number	STD		OFF
MP.B1	Bit-1 of manual preset output number	STD		OFF
MP.B2	Bit-2 of manual preset output number	STD		OFF
SP.BC	Bit changing method of SP number	PRO	0: Status switch 1 1: Status switch 2	0
PN.BC	Bit changing method of PID number	PRO	0: Status switch 1 1: Status switch 2	0
MP.BC	Bit changing method of manual preset output number	PRO	0: Status switch 1 1: Status switch 2	0

DI1-DI2 Contact Type Setting Menu (Menu: DI.D)

Parameter symbol	Name	Display level	Setting range	Initial value
DI1.D	DI1 contact type	PRO	0: The assigned function is enabled when the contact input is closed. 1: The assigned function is enabled when the contact input is opened.	0
DI2.D	DI2 contact type	PRO		0

DI Setting Menu (Menu: DI.D) (E1 terminal area)

Parameter symbol	Name	Display level	Setting range	Initial value
DI1.D	DIn1 contact type	PRO	0: The assigned function is enabled when the contact input is closed. 1: The assigned function is enabled when the contact input is opened.	0
DI2.D	DIn2 contact type	PRO		0
DI3.D	DIn3 contact type	PRO		0
DI4.D	DIn4 contact type	PRO		0
DI5.D	DIn5 contact type	PRO		0

n: Terminal area number

AL1-AL3 Function Registration Menu (Menu: ALM)

Parameter symbol	Name	Display level	Setting range	Initial value
AL1.S	AL1 function selection	STD	Set an I relay number. Setting range: 4001 to 6000	4353
AL2.S	AL2 function selection	STD	No function: OFF	4354
AL3.S	AL3 function selection	STD	Alarm 1: 4353 Alarm 2: 4354	4355
OR.S	OUT relay function selection	STD	Alarm 3: 4355 Alarm 4: 4357	OFF
OR2.S	OUT2 relay function selection	STD	AUTO (ON) / MAN (OFF) status: 4193 REM (ON) / LCL (OFF) status: 4194 STOP (ON) / RUN (OFF) status: 4195 FAIL (Normally ON) output: 4256	OFF
AL1.D	AL1 contact type	PRO	0: When the event of assigned function occurs, the contact output is closed. 1: When the event of assigned function occurs, the contact output is opened.	0
AL2.D	AL2 contact type	PRO		0
AL3.D	AL3 contact type	PRO		0
OR.D	OUT relay contact type	PRO		0
OR2.D	OUT2 relay contact type	PRO		0

DO Setting Menu (Menu: DO) (E1 and E4 terminal area)

Parameter symbol	Name	Display level	Setting range	Initial value
DO1.S	DOn1 function selection	STD	Same as AL1.S. Initial value of E1 and E3 terminal area All DO settings are OFF.	OFF
DO2.S	DOn2 function selection	STD		OFF
DO3.S	DOn3 function selection	STD		OFF
DO4.S	DOn4 function selection	STD		OFF
DO5.S	DOn5 function selection	STD		OFF
DO1.D	DOn1 contact type	PRO	0: When the event of assigned function occurs, the contact output is closed. 1: When the event of assigned function occurs, the contact output is opened.	0
DO2.D	DOn2 contact type	PRO		0
DO3.D	DOn3 contact type	PRO		0
DO4.D	DOn4 contact type	PRO		0
DO5.D	DOn5 contact type	PRO		0

n: Terminal area number (1 or 4)

18.2 List of Parameters

I/O Display Menu (Menu: I/O)

Parameter symbol	Name	Display level	Read only
KEY	Key status	PRO	See Chapter 13.
X000	DI1-DI2 status (equipped as standard)	PRO	
X100	DI11-DI15 status (E1-terminal area)	PRO	
Y000	AL1-AL3 status (equipped as standard)	PRO	
Y100	DO11-DO12 status (E1-terminal area)	PRO	
Y400	DO41-DO45 status (E4-terminal area)	PRO	

System Setting Menu (Menu: SYS)

Parameter symbol	Name	Display level	Setting range	Initial value
R.MD	Restart mode	STD	CONT: Continue action set before power failure. MAN: Start from MAN. AUTO: Start from AUTO.	CONT
R.TM	Restart timer	STD	0 to 10 s	0
EPO	Input error preset output	STD	0: Preset output 1: 0% output 2: 100% output	0
C.GRN	Response as GREEN Series	PRO	OFF: Works as UT35A/UT32A in communication of device information response or broadcasting. ON: Works as GREEN Series in communication of device information response or broadcasting.	OFF
FREQ	Power frequency	EASY	AUTO, 60: 60 Hz, 50: 50 Hz	AUTO
QSM	Quick setting mode	EASY	OFF: Disable ON: Enable	ON
LANG	Guide display language	EASY	ENG: English FRA: French GER: German SPA: Spanish	Depends on the Model and Suffix Codes
PASS	Password setting	EASY	0 (No password) to 65535 Once a password is set, you can no longer choose not to set a password.	0

Initialization Menu (Menu: INIT)

Parameter symbol	Name	Display level	Setting range	Initial value
U.DEF	Initialization to user default value	PRO	12345: Initialization, automatically returned to "0" after initialization.	0
F.DEF	Initialization to factory default value	PRO	-12345: Initialization, automatically returned to "0" after initialization.	0

Error and Version Confirmation Menu (Menu: VER)

Parameter symbol	Name	Display level	Read only
PA.ER	Parameter error status	EASY	See Chapter 16.
OP.ER	Option error status	EASY	
AD1.E	A/D converter error status 1	EASY	
AD2.E	A/D converter error status 2	EASY	
PV1.E	PV input error status	EASY	
LA.ER	Ladder error status	EASY	
MCU	MCU version	EASY	See Chapter 13.
DCU	DCU version	EASY	
ECU1	ECU-1 version	EASY	
ECU3	ECU-3 version	EASY	
ECU4	ECU-4 version	EASY	
PARA	Parameter version	EASY	
H.VER	Product version	EASY	
SER1	Serial number 1	EASY	
SER2	Serial number 2	EASY	
MAC1	MAC address 1	EASY	
MAC2	MAC address 2	EASY	
MAC3	MAC address 3	EASY	

When the following parameters are displayed, the terminal area (E1 to E4) is displayed on Group display.

- Parameter: ECU1, ECU3, ECU4, MAC1, MAC2 and MAC3

Parameter Display Level Menu (Menu: LVL)

Parameter symbol	Name	Display level	Setting range	Initial value
LEVL	Parameter display level	EASY	EASY: Easy setting mode STD: Standard setting mode PRO: Professional setting mode	STD

19.1 Hardware Specifications



WARNING

This instrument is for Measurement Category I (CAT.I). Do not use it for measurements in locations falling under Measurement Categories II, III, and IV.

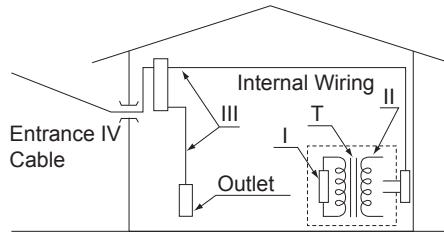

Category	Measurement category	Description	Remarks
I	CAT.I	For measurements performed on circuits not directly connected to MAINS.	-
II	CAT.II	For measurements performed on circuits directly connected to the low-voltage installation.	Appliances, portable equipments, etc.
III	CAT.III	For measurements performed in the building installation.	Distribution board, circuit breaker, etc.
IV	CAT.IV	For measurements performed at the source of the low-voltage installation.	Overhead wire, cable systems, etc.

19.1 Hardware Specifications

19.1.1 Input Specifications

Universal Input

- Number of inputs: 1
- Input type, instrument range, and measurement accuracy: See the table below.

Input Type		Instrument Range (°C)	Instrument Range (°F)	Accuracy
Thermo-couple	K	-270.0 to 1370.0°C	-450.0 to 2500.0°F	±0.1% of instrument range ±1 digit for 0°C or more ±0.2% of instrument range ±1 digit for less than 0°C ±2% of instrument range ±1 digit for less than -200.0°C of thermocouple K ±1% of instrument range ±1 digit for less than -200.0°C of thermocouple T ±0.15% of instrument range ±1 digit for 400°C or more ±5% of instrument range ±1 digit for less than 400°C ±0.15% of instrument range ±1 digit ±0.1% of instrument range ±1 digit ±0.25% of instrument range ±1 digit for less than 0°C ±0.1% of instrument range ±1 digit for 0°C or more ±0.2% of instrument range ±1 digit for less than 0°C ±1.5% of instrument range ±1 digit for less than -200.0°C of thermocouple E. ±0.2% of instrument range ±1 digit (Note 2) ±0.1% of instrument range ±1 digit ±0.5% of instrument range ±1 digit for 800°C or more Accuracy is not guaranteed for less than 800°C. ±0.2% of instrument range ±1 digit
		-270.0 to 1000.0°C	-450.0 to 2300.0°F	
		-270.0 to 500.0°C	-200.0 to 1000.0°F	
	J	-200.0 to 1200.0°C	-300.0 to 2300.0°F	
	T	-270.0 to 400.0°C	-450.0 to 750.0°F	
		0.0 to 400.0°C	-200.0 to 750.0°F	
	B	0.0 to 1800.0°C	32 to 3300°F	
	S	0.0 to 1700.0°C	32 to 3100°F	
	R	0.0 to 1700.0°C	32 to 3100°F	
	N	-200.0 to 1300.0°C	-300.0 to 2400.0°F	
	E	-270.0 to 1000.0°C	-450.0 to 1800.0°F	
	L	-200.0 to 900.0°C	-300.0 to 1600.0°F	
		-200.0 to 400.0°C	-300.0 to 750.0°F	
	U	0.0 to 400.0°C	-200.0 to 1000.0°F	
0.0 to 400.0°C		-200.0 to 1000.0°F		
W	0.0 to 2300.0°C	32 to 4200°F		
Platinel 2	0.0 to 1390.0°C	32.0 to 2500.0°F		
PR20-40	0.0 to 1900.0°C	32 to 3400°F		
W97Re3-W75Re25	0.0 to 2000.0°C	32 to 3600°F		
RTD	JPt100	-200.0 to 500.0°C	-300.0 to 1000.0°F	
		-150.00 to 150.00°C	-200.0 to 300.0°F	
	Pt100	-200.0 to 850.0°C	-300.0 to 1560.0°F	
		-200.0 to 500.0°C	-300.0 to 1000.0°F	
		-150.00 to 150.00°C	-200.0 to 300.0°F	
Standard signal	0.400 to 2.000 V		±0.1% of instrument range ±1 digit	
	1.000 to 5.000 V			
	4.00 to 20.00 mA			
DC voltage/current	0.000 to 2.000 V			
	0.00 to 10.00 V			
	0.00 to 20.00 mA			
	-10.00 to 20.00 mV			
	0.0 to 100.0 mV			

The accuracy is that in the standard operating conditions: 23±2°C, 55±10%RH, and power frequency at 50/60 Hz.

Note 1: ±0.3°C ±1 digit in the range between 0 and 100°C, ±0.5°C ±1 digit in the range between -100 and 200°C.

Note 2: W: W-5% Re/W-26% Re(Hoskins Mfg.Co.). ASTM E988

- Input sampling (control) period: Select from among 50, 100, and 200 ms
- Burnout detection:
 - Functions at TC, RTD, and standard signal
 - Upscale, downscale, and off can be specified.
 - For standard signal, burnout is determined to have occurred if it is 0.1 V or 0.4 mA or less.
- Input bias current: 0.05 μ A (for TC or RTD)
- Measurement current (RTD): About 0.16 mA
- Input resistance:
 - TC or mV input: 1 M Ω or more
 - V input: About 1 M Ω
 - mA input: About 250 Ω
- Allowable signal source resistance:
 - TC or mV input: 250 Ω or less
 - Effects of signal source resistance: 0.1 μ V/ Ω or less
 - DC voltage input: 2 k Ω or less
 - Effects of signal source resistance: About 0.01%/100 Ω
- Allowable wiring resistance:
 - RTD input: Max. 150 Ω /wire (The conductor resistance between the three wires shall be equal.)
 - Wiring resistance effect: $\pm 0.1^{\circ}\text{C}/10 \Omega$
- Allowable input voltage/current:
 - TC, mV, mA or RTD input: ± 10 V DC
 - V input: ± 20 V DC
 - mA input: ± 40 mA
- Noise rejection ratio:
 - Normal mode: 40 dB or more (50/60 Hz)
 - Common mode: 120 dB or more (50/60 Hz)
 - For 100-240 V AC, the power frequency can be set manually. Automatic detection is also available.
 - For 24 V AC/DC, the power frequency can be set manually.
- Reference junction compensation error:
 - $\pm 1.0^{\circ}\text{C}$ (15 to 35 $^{\circ}\text{C}$)
 - $\pm 1.5^{\circ}\text{C}$ (-10 to 15 $^{\circ}\text{C}$, 35 to 50 $^{\circ}\text{C}$)
- Applicable standards: JIS/IEC/DIN (ITS-90) for TC and RTD

19.1.2 Analog Output Specifications

- Number of outputs:
 - Control output: 1
 - Cooling-side control output of Heating/cooling type (Retransmission output terminal): 1
- Output type: Current output or voltage pulse output
- Current output: 4 to 20 mA DC or 0 to 20 mA DC/load resistance of 600 Ω or less
- Current output accuracy: $\pm 0.1\%$ of span ($\pm 5\%$ of span for 1 mA or less.)
 - The accuracy is that in the standard operating conditions: 23 $\pm 2^{\circ}\text{C}$, 55 $\pm 10\%$ RH, and power frequency at 50/60 Hz.
- Voltage pulse output:
 - Use: Time proportional output
 - On-voltage: 12 V or more/load resistance of 600 Ω or more
 - Off-voltage: 0.1 V DC or less
 - Time resolution: 10 ms or 0.1% of output, whichever is larger

19.1.3 Step Response Time Specifications

Within 1 s

(63% of analog output response time when a step change of 10 to 90% of input span is applied)

19.1.4 Relay Contact Output Specifications

- Contact type and number of outputs:
Control output: contact point 1c; 1 point
Heating/cooling type: contact point 1a; 2 points for both heating and cooling sides
Alarm output: contact point 1a; 3 points (common is independent)
 - Contact rating:
Contact point 1c (control output): 250 V AC, 3 A or 30 V DC, 3A (resistance load)
Contact point 1a (control output): 240 V AC, 3A or 30 V DC, 3A (resistance load)
Contact point 1a (alarm output): 240 V AC, 1A or 30 V DC, 1 A (resistance load)
 - Use: Time proportional output, alarm output, FAIL output, etc.
 - Time resolution of control output: 10 ms or 0.1% of output, whichever is larger
- Note: Cannot be used for a small load of 10 mA or less.

19.1.5 Position Proportional Output Specifications

- Position signal input:
Slide resistance: 100 Ω to 2.5 k Ω of total resistance
100% side and slide line: with disconnection detection
0% side: without disconnection detection
Current input: 4 to 20 mA (with disconnection detection)
 - Sampling period: 50 ms
 - Measurement resolution: 0.1% of input span
 - Position proportional relay output:
UT35A: contact point 1a; 2 points, 250 V AC, 3 A or 30 V DC, 3 A (resistance load)
UT32A: contact point 1a; 2 points, 240 V AC, 3 A or 30 V DC, 3 A (resistance load)
- Note: Cannot be used for a small load of 10 mA or less.

19.1.6 Retransmission Output Specifications

- Number of outputs: Retransmission output; 1, shared with 15 V DC loop power supply or Cooling-side control output
- Current output: 4 to 20 mA DC or 0 to 20 mA DC/ load resistance of 600 Ω or less
- Current output accuracy: $\pm 0.1\%$ of span ($\pm 5\%$ of span for 1 mA or less.)
The accuracy is that in the standard operating conditions: $23 \pm 2^\circ\text{C}$, $55 \pm 10\% \text{RH}$, and power frequency at 50/60 Hz.

19.1.7 15 V DC Loop Power Supply Specifications

(Shared with retransmission output or Cooling-side control output)

- Power supply: 14.5 to 18.0 V DC
- Maximum power supply: About 21 mA (with short-circuit current limiting circuit)

19.1.8 Contact Input Specifications

- Number of inputs: See the table of Model and Suffix Codes.
- Input type: No-voltage contact input or transistor contact input
- Input contact rating: 12 V DC, 10 mA or more
Use a contact of a minimum on-current of 1 mA or more
- ON/OFF detection:
 - No-voltage contact input:
Contact resistance of 1 k Ω or less is determined as “ON” and contact resistance of 50 k Ω or more as “OFF.”
 - Transistor contact input:
Input voltage of 2 V or less is determined as “ON” and leakage current must not exceed 100 μ A when “OFF.”
- Minimum status detection hold time: Control period +50 ms
- Use: SP switch, operation mode switch, and event input

19.1.9 Transistor Contact Output Specifications

- Number of outputs: See the table of Model and Suffix Codes.
- Output type: Open collector (SINK current)
- Output contact rating: Max. 24 V DC, 50 mA
- Output time resolution: 200 ms

19.1.10 Heater Break Alarm Specifications

- Number of inputs: 2
- Number of outputs: 2 (transistor contact output)
- Use: Measures the heater current using an external current transformer (CT) and generates a heater break alarm when the measured value is less than the break detection value.
- Current transformer input resistance: About 9.4 Ω
- Current transformer input range: 0.0 to 0.1 Arms (0.12 Arms or more cannot be applied.)
- Heater current setting range: OFF, 0.1 to 300.0 Arms
Heater current measured value display range: 0.0 to 360.0 Arms
Note: The CT ratio can be set. CT ratio setting range: 1 to 3300
- Recommended CT: CT from U.R.D., Ltd.
CTL-6-S-H: CT ratio 800, measurable current range: 0.1 to 80.0 Arms
CTL-12L-30: CT ratio 3000, measurable current range: 0.1 to 180.0 Arms
- Heater current measurement period: 200 ms
- Heater current measurement accuracy: $\pm 5\%$ of current transformer input range span ± 1 digit (CT error is not included.)
Ex.: CTL-12L-30
 0.1 (Max. of current transformer input range) $\times 3000$ (CT ratio) $\times \pm 0.05$ ($\pm 5\%$) ± 1 digit = ± 15 Arms ± 1 digit
- Heater current detection resolution: Within 1/250 of current transformer input range span
Ex.: CTL-12L-30
 0.1 (Max. of current transformer input range) $\times 3000$ (CT ratio) / 250 = 1.2 Arms
- Break detection On-time: Min. 0.2 second. (for time proportional output)

19.1.11 24 V DC Loop Power Supply Specifications

- Use: Power is supplied to a 2-wire transmitter.
- Power supply: 21.6 to 28.0 V DC
- Rated current: 4 to 20 mA DC
- Maximum power supply: About 30 mA (with short circuit current limiting circuit)

19.1.12 Safety and EMC Standards

- Safety: Compliant with IEC/EN61010-1 (CE), approved by CAN/CSA C22.2 No.61010-1 (CSA), approved by UL61010-1.
 - Installation category: CAT. II Pollution degree: 2
 - Measurement category: I (CAT. I)
 - Rated measurement input voltage: Max. 10 V DC
 - Rated transient overvoltage: 1500 V (Note)
- Note: This is a reference safety standard value for Measurement Category I of IEC/EN/CSA/UL61010-1. This value is not necessarily a guarantee of instrument performance.

- EMC Conformity standards:
 - CE marking
 - EN61326-1 Class A, Table 2 (For use in industrial locations)
 - EN61326-2-3
 - EN 55011 Class A, Group1
 - EN 61000-3-2 Class A
 - EN 61000-3-3
 - C-tick mark
 - EN 55011 Class A, Group1

The instrument continues to operate at a measurement accuracy of within $\pm 20\%$ of the range during testing

19.1.13 Construction, Installation, and Wiring

- Dust-proof and drip-proof: IP56 (for front panel) (Not available for side-by-side close mounting.)
- Material: Polycarbonate (Flame retardancy: UL94V-0)
- Case color: Light gray
- Weight: 0.5 kg or less
- External dimensions (mm):
 - UT35A: 96 (W) \times 96 (H) \times 65 (depth from the panel face)
 - UT32A: 48 (W) \times 96 (H) \times 65 (depth from the panel face)
 - (Depth except the projection on the rear panel)
- Installation: Direct panel mounting; mounting bracket, one each for upper and lower mounting
- Panel cutout dimensions (mm):
 - UT35A: $92^{+0.8/0}$ (W) \times $92^{+0.8/0}$ (H)
 - UT32A: $45^{+0.6/0}$ (W) \times $92^{+0.8/0}$ (H)
- Mounting attitude: Up to 30 degrees above the horizontal. No downward titling allowed.
- Wiring: M3 screw terminal with square washer (for signal wiring and power wiring)

19.1.14 Power Supply Specifications and Isolation

- Power supply:
 - Rated voltage: 100 – 240 V AC (+10%/-15%), 50/60 Hz
 - 24 V AC/DC (+10%/-15%) (for /DC option)
- Power consumption:
 - UT35A: 18 VA (DC:9 VA, AC: 14 VA if /DC option is specified)
 - UT32A: 15 VA (DC:7 VA, AC: 11 VA if /DC option is specified)
- Data backup: Nonvolatile memory
- Power holdup time: 20 ms (for 100 V AC drive)
- Withstanding voltage
 - Between primary terminals and secondary terminals: 2300 V AC for 1 minute
 - Between primary terminals: 1500 V AC for 1 minute
 - Between secondary terminals: 500 V AC for 1 minute
 - (Primary terminals: Power (*) and relay output terminals; Secondary terminals: Analog I/O signal terminals, contact input terminals, communication terminals, and functional grounding terminals.)
 - (*): Power terminals for 24V AC/DC models are the secondary terminals.
- Insulation resistance
 - Between power supply terminals and a grounding terminal: 20 MΩ or more at 500 V DC

• Isolation specifications

PV (universal) input terminals	Internal circuits	Power supply
Control, retransmission (analog) output terminals (not isolated between the analog output terminals) Valve position (feedback) input terminals		
Control relay (contact point c/contact point a x 2) output terminals		
Alarm-1 relay (contact point a) output terminals		
Alarm-2 relay (contact point a) output terminals		
Alarm-3 relay (contact point a) output terminals		
Position proportional relay output terminals		
Contact input terminals (All) RS-485 communication terminals (2 ports)		
24 V DC loop power supply terminals		
Contact output (transistor) terminals		
Ethernet communication terminal		
PROFIBUS-DP communication terminals		
Current transformer input terminals		

The circuits divided by lines are insulated mutually.

19.1.15 Environmental Conditions

Normal Operating Conditions

- Ambient temperature: -10 to 50°C (-10 to 40°C for side-by-side close mounting)
- Ambient humidity: 20 to 90% RH (no condensation allowed)
- Magnetic field: 400 A/m or less
- Continuous vibration at 5 to 9 Hz: Half amplitude of 1.5 mm or less, 1oct/min for 90 minutes each in the three axis directions
Continuous vibration at 9 to 150 Hz: 4.9 m/s² or less, 1oct/min for 90 minutes each in the three axis directions
- Short-period vibration: 14.7 m/s², 15 seconds or less
- Shock: 98 m/s² or less, 11 ms
- Altitude: 2000 m or less above sea level
- Warm-up time: 30 minutes or more after the power is turned on
- Startup time: Within 10 seconds

*: The LCD (a liquid crystal display) is used for a display portion of this product.
The LCD has a characteristic that the display action becomes late at the low temperature.
However, the control function is not affected.

Transportation and Storage Conditions

- Temperature: -25 to 70°C
- Temperature change rate: 20°C/h or less
- Humidity: 5 to 95% RH (no condensation allowed)

Effects of Operating Conditions

- Effect of ambient temperature:
 - Voltage or TC input: $\pm 1 \mu\text{V}/^\circ\text{C}$ or $\pm 0.01\%$ of F.S./ $^\circ\text{C}$, whichever is larger
 - Current input: $\pm 0.01\%$ of F.S./ $^\circ\text{C}$
 - RTD input: $\pm 0.05^\circ\text{C}/^\circ\text{C}$ (ambient temperature) or less
 - Analog output: $\pm 0.02\%$ of F.S./ $^\circ\text{C}$ or less
- Effect of power supply voltage fluctuation
 - Analog input: $\pm 0.05\%$ of F.S. or less
 - Analog output: $\pm 0.05\%$ of F.S. or less
 - (Each within rated voltage range)

Appendix 1 Input and Output Table

See the next page.

UT35A Model and Suffix Codes

Model	Suffix code					Optional suffix code	INPUT				
							PV	OUT	OUT2	VALV	RET
UT35A	-x	x	x	-x0	-00	/x	●				●
Type 1: Basic control	-0							●			
	-1									●	
	-2							●	◆		
Type 2: Functions	0										
	1										
	2										
Type 3: Open networks	x										
Display language						-x0					
Fixed code						-00					
Optional suffix codes						/HA					

- : Equipped
- ◆: Relay output only

UT32A Model and Suffix Codes

Model	Suffix code					Optional suffix code	INPUT				
							PV	OUT	OUT2	VALV	RET
UT32A	-x	x	x	-x0	-00	/x	●				●
Type 1: Basic control	-0							●			
	-1									●	
	-2							●	◆		
Type 2: Functions	0										
	1										
	2										
Type 3: Open networks	x										
Display language						-x0					
Fixed code						-00					
Optional suffix codes						/HA					

- : Equipped
- ◆: Relay output only

Description of symbol

- PV: Measured input
- OUT, OUT2: Control output
- VALV: Position proportional output
- RET: Retransmission output
- DI1 to DI2: Contact input
- DI11 to DI15: Contact input
- AL1 to AL3: Alarm output
- DO11 to DO45: Contact output
- HAL1 to HAL2: Heater break alarm output

UT35A (Continued)

DI						DO												
DI1	DI2	DI11	DI12	DI13	DI14	DI15	AL1	AL2	AL3	DO11	DO12	DO41	DO42	DO43	DO44	DO45	HAL1	HAL2
•	•						•	•	•									
		•	•							•	•							
		•	•	•	•	•						•	•	•	•	•		
																	•	•

•: Equipped

UT32A (Continued)

DI				DO						
DI1	DI2	DI11	DI12	AL1	AL2	AL3	DO11	DO12	HAL1	HAL2
•	•			•	•	•				
		•	•				•	•		
									•	•

Revision Information

- Title : UT35A/UT32A Digital Indicating Controller User's Manual
- Manual No. : IM 05P01D31-01EN

Jan 2010/1st Edition
Newly published

- Written by Yokogawa Electric Corporation
 - Published by Yokogawa Electric Corporation
2-9-32 Nakacho, Musashino-shi, Tokyo 180-8750, JAPAN
-



YOKOGAWA ELECTRIC CORPORATION**Headquarters**

2-9-32, Nakacho, Musashino-shi, Tokyo, 180-8750 JAPAN

Branch Sales Offices

Nagoya, Osaka, Hiroshima, Fukuoka, Sendai, Ichihara, Toyota, Kanazawa, and Kitakyusyu.

YOKOGAWA CORPORATION OF AMERICA

2 Dart Road, Newnan, Georgia 30265-1094, U.S.A.

Phone : 1-800-888-6400

Fax : 1-770-254-0928

YOKOGAWA EUROPE B. V.

Euroweg 2, 3825 HD Amersfoort, THE NETHERLANDS

Phone : 31-88-464-1000 Fax : 31-88-464-1111

Branch Sales Offices / Wien (Austria), Zaventem (Belgium), Ratingen (Germany), Madrid (Spain), Runcorn (United Kingdom), Milano (Italy), Cinisello Balsamo (Italy), Velizy-Villacoublay (France), Budapest (Hungary), Stockholm (Sweden), Sola (Norway), Warszawa (Poland), Vila Nova de Gaia (Portugal), Bucharest (Romania), Dublin (Ireland)

YOKOGAWA AMERICA DO SUL LTDA.

Praca Acapulco, 31 - Santo Amaro. Sao Paulo/SP - BRAZIL

Phone : 55-11-5681-2400 Fax : 55-11-5681-4434

YOKOGAWA ENGINEERING ASIA PTE. LTD.

5 Bedok South Road, 469270 SINGAPORE

Phone : 65-6241-9933 Fax : 65-6241-2606

YOKOGAWA ELECTRIC KOREA CO., LTD.

14-1, Yangpyongdong-4Ga, Youngdeungpo-Gu, Seoul, 150-866 KOREA

Phone : 82-2-2628-6000 Fax : 82-2-2628-6400

YOKOGAWA AUSTRALIA PTY. LTD.

Tower A, 112-118 Talavera Road, Macquarie Park, N.S.W.2113, AUSTRALIA

Phone : 61-2-8870-1100 Fax : 61-2-8870-1111

YOKOGAWA INDIA LTD.

Plot No.96 Electronic City Complex, Hosur Road, Bangalore 560100, INDIA

Phone : 91-80-4158-6000 Fax : 91-80-2852-0625

YOKOGAWA CHINA CO., LTD.

3F TowerD Cartelo Crocodile Building

No.568 West Tianshan Road, Shanghai 200335, CHINA

Phone : 86-21-62396262 Fax : 86-21-62387866