

AEROTRAK™ Handheld Airborne Particle Counter Model 9306

Operation Manual

P/N 6004215, Revision B
September 2010



TRUST. SCIENCE. INNOVATION.



TSI INCORPORATED

Product Registration

Start Seeing the *Benefits* of Registering Today!

Thank you for your TSI instrument purchase. Occasionally, TSI releases information on software updates, product enhancements and new products. By registering your instrument, TSI will be able to send this important information to you.

<http://register.tsi.com>

As part of the registration process, you will be asked for your comments on TSI products and services. TSI's customer feedback program gives customers like you a way to tell us how we are doing.

TSI Incorporated

USA Website: www.tsi.com

Germany Website: www.tsiinc.de

Singapore E-mail: tsi-singapore@tsi.com

UK Website: www.tsiinc.co.uk

France Website: www.tsiinc.fr

Manufacturer of TSI®, AIRFLOW™ Instruments, and Alnor® products.

P/N 2980174 Rev F

Copyright © 2010 by TSI Incorporated



AEROTRAK™ Handheld Airborne Particle Counter

Model 9306

Operation Manual

P/N 6004215, Revision B
September 2010

SHIP TO/MAIL TO:
TSI Incorporated
500 Cardigan Road
Shoreview, MN 55126-3996
USA

**U.S.
Technical Support:**
(800) 874-2811/(651) 490-2811
Fax:
(651) 490-3824

E-mail address:
aerotrak@tsi.com

Website:
<http://www.tsi.com>

**INTERNATIONAL
Technical Support:**
(001 651) 490-2811
Fax:
(001 651) 490-3824



TRUST. SCIENCE. INNOVATION.

Manual History

The following is a manual history of the AEROTRAK™ Handheld Airborne Particle Counter, Model 9306 Operation Manual (P/N 6004215).

Revision	Date
A	July 2010
B	September 2010

Warranty

Part Number

6004215 / Revision A / September 2010

Copyright

©TSI Incorporated / 2010 / All rights reserved.

Address

TSI Incorporated / 500 Cardigan Road / Shoreview, MN 55126 / USA

E-mail Address

aerotrak@tsi.com

Limitation of Warranty and Liability

(effective July 2000)

Seller warrants the goods sold hereunder, under normal use and service as described in the operator's manual, shall be free from defects in workmanship and material for (24) months, or the length of time specified in the operator's manual, from the date of shipment to the customer. This warranty period is inclusive of any statutory warranty. This limited warranty is subject to the following exclusions:

- a. Hot-wire or hot-film sensors used with research anemometers, and certain other components when indicated in specifications, are warranted for 90 days from the date of shipment.
- b. Parts repaired or replaced as a result of repair services are warranted to be free from defects in workmanship and material, under normal use, for 90 days from the date of shipment.
- c. Seller does not provide any warranty on finished goods manufactured by others or on any fuses, batteries or other consumable materials. Only the original manufacturer's warranty applies.
- d. Unless specifically authorized in a separate writing by Seller, Seller makes no warranty with respect to, and shall have no liability in connection with, goods which are incorporated into other products or equipment, or which are modified by any person other than Seller.

The foregoing is IN LIEU OF all other warranties and is subject to the LIMITATIONS stated herein. **NO OTHER EXPRESS OR IMPLIED WARRANTY OF FITNESS FOR PARTICULAR PURPOSE OR MERCHANTABILITY IS MADE.**

TO THE EXTENT PERMITTED BY LAW, THE EXCLUSIVE REMEDY OF THE USER OR BUYER, AND THE LIMIT OF SELLER'S LIABILITY FOR ANY AND ALL LOSSES, INJURIES, OR DAMAGES CONCERNING THE GOODS (INCLUDING CLAIMS BASED ON CONTRACT, NEGLIGENCE, TORT, STRICT LIABILITY OR OTHERWISE) SHALL BE THE RETURN OF GOODS TO SELLER AND THE REFUND OF THE PURCHASE PRICE, OR, AT THE OPTION OF SELLER, THE REPAIR OR REPLACEMENT OF THE GOODS. IN NO EVENT SHALL SELLER BE LIABLE FOR ANY SPECIAL, CONSEQUENTIAL OR INCIDENTAL DAMAGES. SELLER SHALL NOT BE RESPONSIBLE FOR INSTALLATION, DISMANTLING OR REINSTALLATION COSTS OR CHARGES. No Action, regardless of form, may be brought against Seller more than 12 months after a cause of action has accrued. The goods returned under warranty to Seller's factory shall be at Buyer's risk of loss, and will be returned, if at all, at Seller's risk of loss.

Buyer and all users are deemed to have accepted this LIMITATION OF WARRANTY AND LIABILITY, which contains the complete and exclusive limited warranty of Seller. This LIMITATION OF WARRANTY AND LIABILITY may not be amended, modified or its terms waived, except by writing signed by an Officer of Seller.

Service Policy

Knowing that inoperative or defective instruments are as detrimental to TSI as they are to our customers, our service policy is designed to give prompt attention to any problems. If any malfunction is discovered, please contact your nearest sales office or representative, or call TSI's Customer Service department at 1-800-874-2811 (USA) or +001 (651) 490-2811 (International).

Trademarks

AEROTrak and TRAKPRO are trademarks of TSI Incorporated. TSI and the TSI logo are registered trademarks of TSI Incorporated. Microsoft and Excel are registered trademarks of Microsoft Corporation. OpenOffice is a trademark of Sun Microsystems. Modbus® is a registered trademark of Modicon, Inc.

Contents

Manual History	ii
Warranty	iii
Safety Information	vii
Laser Safety	vii
Labels	viii
Description of Caution/Warning Symbols	ix
Caution	ix
Warning	ix
Caution or Warning Symbols	ix
Getting Help	x
CHAPTER 1 Introduction and Unpacking	1-1
Unpacking the AEROTRAK™ Handheld Airborne Particle Counter	1-2
Optional Accessories	1-3
CHAPTER 2 Getting Started	2-1
Instrument Description	2-1
Using the Instrument Stand and Stylus	2-2
Providing Power	2-3
To Install the Lithium-Ion Battery	2-3
To Use AC Power	2-4
Using with a Printer	2-4
Performing a Zero Check	2-5
To Perform a Zero Check	2-5
Installing an Isokinetic Inlet	2-6
Installing a Temperature/Relative Humidity Probe	2-7
CHAPTER 3 Operation	3-1
Screen Layout and Functionality	3-1
Software Input Panel (Keyboard)	3-2
Main Tab	3-2
Setup Tab	3-6
Data Tab	3-26
Reports Tab	3-29
CHAPTER 4 Data Handling	4-1
USB Data Download	4-1
USB Computer Communication	4-2
Installing Software	4-2
Ethernet Communications	4-3

CHAPTER 5 Maintenance	5-1
Maintenance Schedule.....	5-1
Zero Check.....	5-1
Cleaning the Instrument Enclosure.....	5-1
CHAPTER 6 Troubleshooting.....	6-1
CHAPTER 7 Contacting Customer Service.....	7-1
Technical Contacts.....	7-1
International Contacts.....	7-1
Returning the AEROTRAK™ Handheld Airborne Particle Counter for Service.....	7-3
APPENDIX A Specifications	A-1
Temperature/RH Probe (700084) Specifications (optional accessory).....	A-2
Compliance	A-3
Dimensional Diagram.....	A-3
Index	

Safety Information

This section gives instructions to promote safe and proper handling of the AERO^{TRAK}™ Handheld Airborne Particle Counters.

IMPORTANT

There are no user-serviceable parts inside the instrument. Refer all repair and maintenance to a qualified factory-authorized technician. All maintenance and repair information in this manual is included for use by a qualified factory-authorized technician.

Laser Safety

- The Model 9306 Handheld Airborne Particle Counter is a Class I laser-based instrument.
- During normal operation, you will **not** be exposed to laser radiation.
- Precaution should be taken to avoid exposure to hazardous radiation in the form of intense, focused, visible light.
- Exposure to this light may cause blindness.

Take these precautions:

- **DO NOT** remove any parts from the particle counter unless you are specifically told to do so in this manual.
- **DO NOT** remove the housing or covers. There are no user-serviceable components inside the housing.





WARNING

The use of controls, adjustments, or procedures other than those specified in this manual may result in exposure to hazardous optical radiation.

Labels

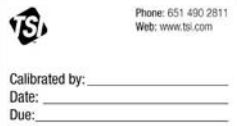
Advisory labels and identification labels are attached to the outside of the particle counter housing and to the optics housing on the inside of the instrument.

<p>1. Serial number label (back panel)</p>	
<p>2. Laser radiation label (internal)</p>	<div style="border: 1px solid black; padding: 5px; text-align: center;"> <p>DANGER!</p> <p>VISIBLE LASER RADIATION WHEN OPEN. AVOID DIRECT EXPOSURE TO BEAM</p> <p>WARNING: NO USER SERVICABLE PARTS INSIDE. REFER SERVICING TO QUALIFIED PERSONNEL</p> </div>
<p>3. Calibration Label (side panel)</p>	
<p>4. Laser radiation symbol label (internal)</p>	
<p>5. European symbol for non-disposable item. Item must be recycled.</p>	

Description of Caution/Warning Symbols

Appropriate caution/warning statements are used throughout the manual and on the instrument that require you to take cautionary measures when working with the instrument.

Caution



C a u t i o n
Failure to follow the procedures prescribed in this manual might result in irreparable equipment damage. Important information about the operation and maintenance of this instrument is included in this manual.

Warning



W A R N I N G
Warning means that unsafe use of the instrument could result in serious injury to you or cause damage to the instrument. Follow the procedures prescribed.

Caution or Warning Symbols

The following symbols may accompany cautions and warnings to indicate the nature and consequences of hazards:

	Warns that uninsulated voltage within the instrument may have sufficient magnitude to cause electric shock. Therefore, it is dangerous to make contact with any part inside the instrument.
	Warns that the instrument contains a laser and that important information about its safe operation and maintenance is included in the manual.
	Warns that the instrument is susceptible to electro-static dissipation (ESD) and ESD protection procedures should be followed to avoid damage.
	Indicates the connector is connected to earth ground and cabinet ground.

Getting Help

To obtain assistance with this product or to submit suggestions, please contact Customer Service:

TSI Incorporated
500 Cardigan Road
Shoreview, MN 55126 U.S.A.
Fax: (651) 490-3824 (USA)
Fax: 001 651 490 3824 (International)
Telephone: 1-800-874-2811 (USA) or (651) 490-2811
International: 001 651 490 2811
E-mail Address: aerotrak@tsi.com
Web site: www.tsi.com

CHAPTER 1

Introduction and Unpacking

The AEROTRAK™ Model 9306 Airborne Particle Counter (particle counter) is a lightweight, handheld particle counter with a touch-screen interface. It operates on the included lithium-ion battery or AC power.

This device has a 0.1 CFM (2.83 L/min) flow rate and counts bin sizes from 0.3 to 25 µm that depend on the model ordered (see table below). Up to 10,000 data sets can be downloaded for analysis and reporting using the TRAKPRO™ Lite Data Download Software included with the device.

Model	Size Range
9306-03	0.3, 0.5, 0.7, 1.0, 2.0, 5.0 µm
9306-04	0.3, 0.5, 1.0, 3.0, 5.0, 10.0 µm
9306-V2	0.3 to 10 µm, user-selectable; factory-calibrated at 0.3, 0.5, 1.0, 3.0, 5.0, 10.0 µm



Typical applications for this particle counter include clean room monitoring, research, exposure assessment, indoor air quality, filter testing, clearance testing, quality assurance, and contaminant migration studies. All AEROTRAK™ particle counters meet JIS standards.

Unpacking the AEROTRAK™ Handheld Airborne Particle Counter

Carefully unpack the AEROTRAK™ Airborne Particle Counter from the shipping container and verify that all the items shown in the photos below and listed in the following tables are present. Contact TSI immediately if items are missing or broken.

Model 9306 AEROTRAK™ Airborne Particle Counter Parts List



Qty.	Item Description	Part/Model	Reference Picture
1	AEROTRAK™ Airborne Particle Counter	9306-03 9306-04 9306-V2	
1	Power Supply with universal plugs	801694	
1	Isokinetic inlet	700003 AL	
1	Battery pack	700032	
1	Computer cable (2 m), USB A to B	700033	
1	Stylus	N/A	
1	HEPA zero filter assembly	700005	







Qty.	Item Description	Part/Model	Reference Picture
1	TRAKPRO™ Lite (version 2.2 or later) data download utility CD (includes manual)	7001384	
1	Operation Manual	6004215	(installed on TRAKPRO™ Lite CD)
1	Calibration certificate	N/A	
1	Quick Start Guide	6004216	

Optional Accessories

The following photos and table list optional accessories. If you ordered optional accessories, make certain they have been received and are in working order.

Model 9306 AEROtrak™ Airborne Particle Counter Optional Accessories

Item Description	Part/Model	Reference Picture
External battery charger with AC adapter and power cord	700025	
External Printer	700085	
Carry case	700083	

Item Description	Part/Model	Reference Picture
Temperature/humidity probe	700084	
Stainless Steel Isokinetic inlet	700004	
Isokinetic probe (used with tubing)	700001 AL 700002 SS	
0.1 cfm Barb Inlet Fitting	700020	
Tubing, Superthane 1/8-inch ID x 1/4-inch OD, Clear 100 ft	700009	
TRAKPRO™ Lite Secure CD for 21 CFR Part 11 compliant data downloading	7001888 (optional accessory)	

CHAPTER 2

Getting Started

This chapter provides information to help you use the Model 9306 AEROTRAK™ Handheld Airborne Particle Counter including:

- [Instrument Description](#)
- [Using the Instrument Stand and Stylus](#)
- [Providing Power](#)
- [Performing a Zero Check](#)
- [Installing an Isokinetic Inlet](#)
- [Installing a Temperature/Relative Humidity Probe](#)

Instrument Description

The Model 9306 has many features to make measurements convenient. They are described in detail below.

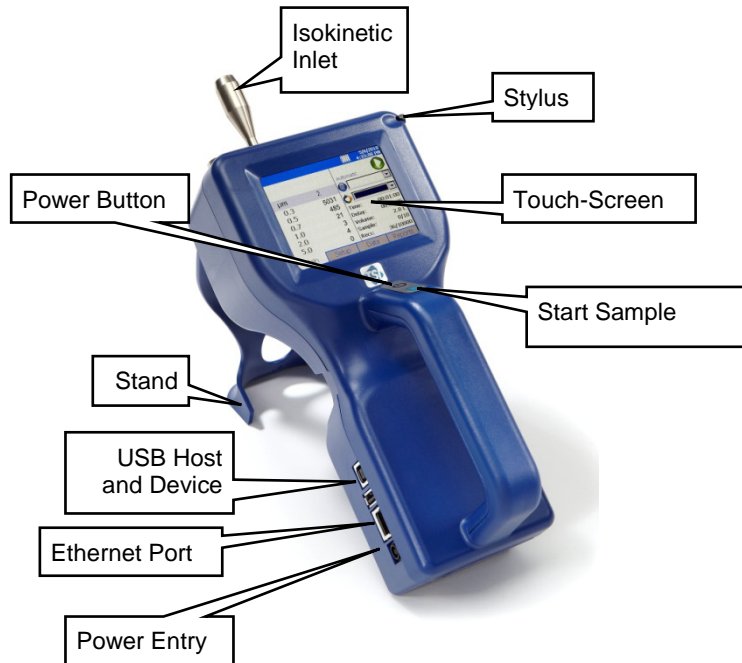

Using the Instrument Stand and Stylus

The Model 9306 is equipped with an integral instrument support stand. To open the stand, grasp it by the large finger hole and pull it out until it locks into place. Be careful not to overextend the stand. To store the stand out of the way when not in use, simply push the stand back until it snaps into place.



The Model 9306 is also equipped with a plastic stylus for use with the touch screen interface. The stylus locks into place in the case near the top of the unit when not in use.



Providing Power

The Model 9306 may be powered using a rechargeable lithium-ion battery, or through an AC power cord.

Notes:

- When using AC power, the battery (if installed) charges when the instrument is on, but not while actively sampling.
- Removing/changing the lithium-ion battery or disconnecting AC power does not cause loss of data.

To Install the Lithium-Ion Battery

1. Remove the battery cover from the back of the instrument by lightly depressing the textured tab on the cover located on the lower left.

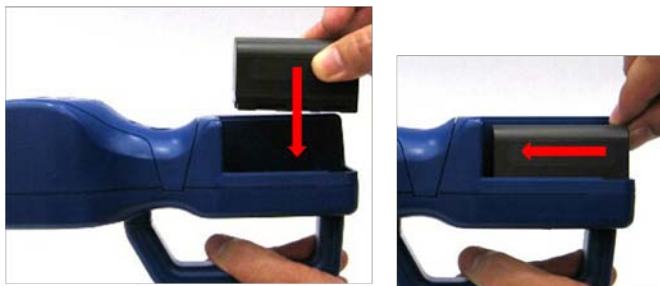

2. Place the lithium-ion battery into the battery compartment and slide it forward (toward the top of the unit) until it locks into place.
3. Replace the battery cover and slide it in place until you hear a click.



W A R N I N G

The battery supplied by TSI (PN 700032) has built in protection against explosion and fire hazard. Do **not** use a substitute.



W A R N I N G

Do **not** use non-rechargeable batteries in this instrument. Fire, explosions, injury or other hazards may result.

To Use AC Power

1. Connect the AC power adapter to the power cord.
2. Insert the AC power adapter into the side of the Model 9306.
3. Connect the power cord to an outlet.
4. Press the on/off button  (located on the front of the instrument handle).
5. After a splash screen displays the TSI logo, a brief start-up sequence begins as the Windows® CE operating system boots up.

Using with a Printer

A hard copy of a sample set can be printed from the instrument using the optional TSI Model 700085 thermal printer (see Chapter 3, "[Operation](#)"). Only the TSI Model 700085 printer is compatible with the Model 9306. The printer may be used on its internal battery or an AC adapter. A custom communications cable is included with the printer. The cable goes between the USB A port and the 9 pin DSUB on the printer.



Performing a Zero Check

A zero check should be performed at least once a day. It should also be performed before conducting any important testing or certification.

To Perform a Zero Check

1. Turn on the instrument and wait until the main menu appears.
2. Remove the Isokinetic inlet if attached. The zero check cannot be performed when the isokinetic inlet is attached to the instrument.
3. Attach the zero filter to the inlet nozzle located on the top of the instrument.



4. Press the **Start** button and allow the instrument to purge for 2 minutes.
5. After the 2-minute purge, continue to sample. In accordance with JIS standards, there should be no more than 1 particle counted at any size in 5 minutes.

Note: *If the instrument does not go to zero (1 particle in 5 minutes is considered zero), refer to Chapter 6, [Troubleshooting](#), for additional information.*

6. Remove the zero filter and put the isokinetic inlet back on—the instrument is now ready for operation.

Installing an Isokinetic Inlet

The Isokinetic inlet smoothly accelerates air into the inlet of the instrument. To install, simply thread the inlet directly onto the inlet nozzle until finger tight. The inlet seals over an O-ring so it doesn't have to be very tight to seal.



Installing a Temperature/Relative Humidity Probe

To install the optional temperature/relative humidity probe:

- 1.** Align the probe so the pins slide into the sockets of the base connector.
- 2.** Align the locking collar on the probe so it will slide over the alignment pins on the base connector
- 3.** Press down and turn the locking collar to lock in the probe.
- 4.** Temperature and relative humidity are automatically displayed in the upper-left corner.
- 5.** Remove the probe turned the locking collar and then pulling straight up on the probe.



(This page intentionally left blank)

CHAPTER 3

Operation

The Model 9306 AEROTRAK™ Handheld Airborne Particle Counter is controlled using a touch screen display. Use the plastic stylus or your finger tip. **DO NOT** use sharp objects (such as a pen point) that may damage the screen overlay.

To turn on the instrument, press the **on/off** button (located in the center of the front of the instrument). After a splash screen displays the TSI logo, a brief start-up sequence begins as the Windows® CE operating system boots up.

The instrument is ready for operation when the main tab (shown below) appears. If an optional temperature/humidity probe is attached, those values will be shown in the upper-left corner also.

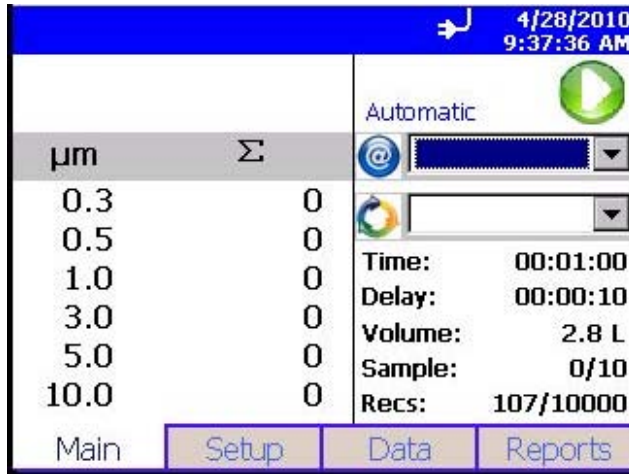

Screen Layout and Functionality

There are four main screens (tabs): Main, Setup, Data, and Reports. The operation of each of these screens, the information displayed on them, and the operations you can perform from each are described in the remainder of this chapter.

Some screens require or allow you to enter information. To enter information, tap on the screen and an on-screen keyboard appears.

Software Input Panel (Keyboard)

Throughout the setup screens, a keyboard will appear on the screen when text may be entered. Data may be entered using this keyboard. When the entry is complete, press either the ↵ (**Enter**) or **Esc** keys. The keyboard will then be hidden until another text entry box is selected.



Main Tab









The Main Tab is the default screen. The left side of the screen summarizes the concentrations for the currently selected location. Tap on the size and count portion of the screen to enable Zoomed Data Screen (see [Setup Tab](#)).

The display shows:

- Temperature*
- Relative humidity*
- Bin sizes
- Particle count/concentration





The status bar at the top of the screen shows the current time and date settings (see the [Setup Tab](#)) and indicates:

*Temperature and Humidity are displayed only if the optional T/H probe is installed.

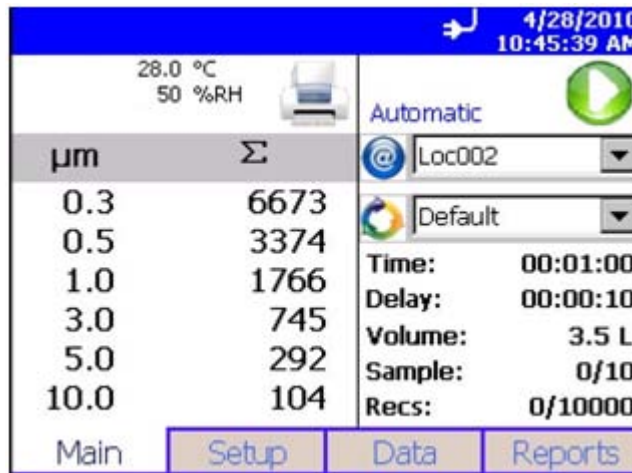
Icon	Description
	Laser requires service
	Sufficient flow through the Model 9306
	Insufficient flow through the Model 9306
	Operating on AC power, no battery installed
	Operating on AC power, battery is installed and charging. (The battery charges when the instrument is on but not actively taking a particle sample.)
	Battery charged
	Low battery
	Battery must be charged

The right side of the Main Tab shows locations and other information (delay, cycles, and so on). These can be configured using the Setup Tab.



Field	Description
 (Location)	This dropdown box displays information about any of the available locations that are associated with the samples.
	The group of settings (recipe) that you are using for this sample.
Delay	The Delay displays one of two times; 1. Before the Start button is pressed the Start Delay time is displayed and then immediately after the Start button is press the delay time begins a countdown. 2. During sampling and between cycles (after the Start Delay has been displayed), the Hold Delay is displayed and then begins a countdown.
Time	The time for each sample.
Recs	The total number of records in the database/10000 (maximum number of records).
Manual/Automatic/Beep	Mode Indicator; refers to the “Data Count Mode” (see section below).
	Start/Stop button to begin and end sampling in the configured mode. Start/Stop may also be entered using the triangle-shaped button above the power button on the front of the instrument.
	Press to print the current sample to the optional printer.

Zoomed Data Screen



The Zoomed Data screen is entered by touching in the size and count part of the main tab display. The bottom portion of the screen summarizes the concentrations for the currently selected location. Tap the size and count portion of the display to switch back to the Main Tab display.

The display shows:

- Temperature*
- Relative humidity*
- Air Velocity
- Bin sizes
- Particle count/concentration

The screenshot shows a mobile application interface for 'Sampling'. At the top, it displays the date and time as '5/3/2010 1:20:43 PM'. Below this, environmental data is shown: '28.0' (likely temperature) and '50 %RH' (relative humidity). The location is identified as 'Loc001' and the mode is 'Automatic'. A green play button icon is visible on the right. The main data area is a table with particle size bins in micrometers (µm) and their corresponding counts (Σ).

µm	Σ
0.3	362
0.5	177
1.0	73
3.0	24
5.0	7
10.0	4

Field	Description
Location	Label that displays information about the currently selected location.
Manual/Automatic/Beep	Mode Indicator; refers to the "Data Count Mode" (see section below).
 	Press the Start/Stop button the begin sampling in the configured mode.

*Temperature and Humidity are displayed only if the optional T/H probe is installed.

Setup Tab



The setup tab provides access to the following:

Sampling Setup	Set up Particle Channels, Sample Timing, Particle Channel Alarms, Sample Count Mode, Count Units, and Environment display settings.
Locations Setup	Identify and save the location information associated with collected samples.
Recipe Setup	Save a group of settings (a recipe) that you use over and over so you don't have to reset individual settings.
System Setup	Change Power On Password, Setup Password, System Configuration, Print Settings, Print Schedule and Clear Samples
Device Setup	Set Date and Time, Screen Alignment, Communications, Regional Settings, and get device information.

System Setup Screen

From the System Setup screen you can select (or change) the power on password, set up a password, select system configuration parameters, select print settings, schedule printing and clear samples.



Change Power On Password Screen

If a Power On password has been previously set, you must enter that password before being allowed to change the Power On password. If a Power On password is set, then on instrument startup a password screen will ask for the password before the instrument can be used. A blank password is regarded as no password and if set as the new password, will not prompt you for a password on system startup.

Note

Keep the password in a safe place. It is difficult to reset the password and requires contacting the factory. If you have misplaced the password, please contact TSI technical support.

Tap on the screen to display the on-screen keyboard and enter the required information.

Change Power On  4/28/2010
11:23:05 AM

Old Password

New Password

Confirm New Password



Field	Description
Old Password	Enter your existing password (if one has already been set) or leave blank.
New Password	Enter a new password. The password can be any length and use any characters.
Confirm New Password	Retype the new password then press OK. A confirmation message appears if the password is changed.

Note	
Leave both New Password and Confirm New Password fields blank to turn off password protection.	
Call TSI if you have forgotten your password.	

Change Setup Password Screen

If a Setup password has been previously set, you must enter that password before being allowed to change the Setup password. If a Setup password is set, clicking on the setup tab at the bottom of the main screen brings up a password screen. That password must be entered in order to change instrument settings.

Tap on the screen to display the on-screen keyboard and enter the required information.

The screenshot shows a mobile application interface for changing a setup password. The title bar is blue with the text 'Change Setup' and a back arrow. The date and time '4/28/2010 11:25:33 AM' are displayed in the top right corner. The main content area contains three text input fields labeled 'Old Password', 'New Password', and 'Confirm New Password'. To the right of these fields is a yellow padlock icon with two grey gears. At the bottom right, there are two buttons: 'OK' and 'Cancel'.

Field	Description
Old Password	Enter your existing password (if one has already been set) or leave blank.
New Password	Enter a new password. The password can be any length and use any characters.
Confirm New Password	Retype the new password then press OK. A confirmation message appears if the password is changed.

Note

Leave both New Password and Confirm New Password fields blank to turn off password protection.

Call TSI if you have forgotten your password.

Configuration Screen

Use this screen to set configuration parameters. Press **OK** when finished.

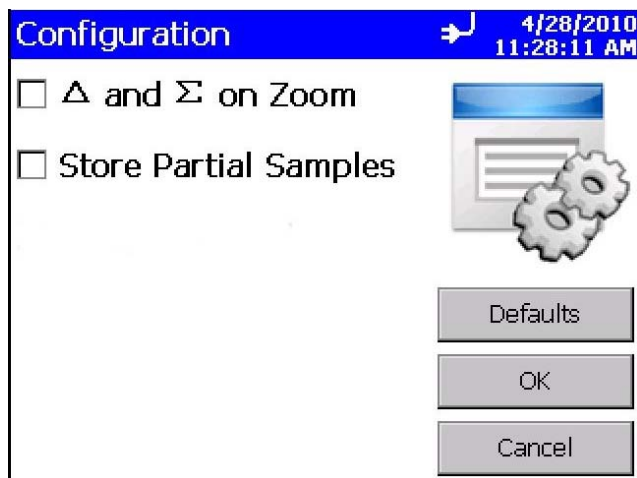

Field	Description
Δ and Σ on Zoom	Select to zoom in on both cumulative (Σ) and differential (Δ) counts on the Main Tab. To zoom the Main Tab, select on the left side of the Main Tab. (It takes a moment for the screen to update.) Click on the screen again to return to normal view.
Store Partial Samples	When selected, stores the partial record in the current database if the instrument is stopped during a sampling period.

Print Setup Screen

A hard copy of a sample set or statistics can be printed from the instrument using an optional thermal printer. Use this screen to set print parameters. Press **OK** when finished.

Field	Description
Serial Number	Indicates that the serial number of the particle counter used to collect the data will be printed.
Model Name	Indicates that the model number of the particle counter used to collect the data will be printed.
Separator	Indicates a line separator will be printed after the Model Name and Serial Number in the header of all printouts
Differential	Indicates that the differential value of the data will be printed.
Cumulative	Indicates that the cumulative value of the data will be printed.
Last Calibration	The date and time the instrument was last calibrated by TSI.

Note: Printer paper has a colored strip printed on the last few feet of each roll to indicate when it is time to change the paper roll.

Print Schedule Screen

Use this screen to schedule automatic printing. You can choose to either print when an alarm occurs or print whenever a sample is complete.



Field	Description
Automatic Printing	Enables automatic printing when checked.
On Sample	Print data whenever a sample completes.
On Alarm	Print data when an alarm condition occurs.

Clear Samples Screen

The Clear Samples screen lets you clear all samples from the internal database. Select **Yes** to clear all samples. Select **No** to return to the System Setup screen.

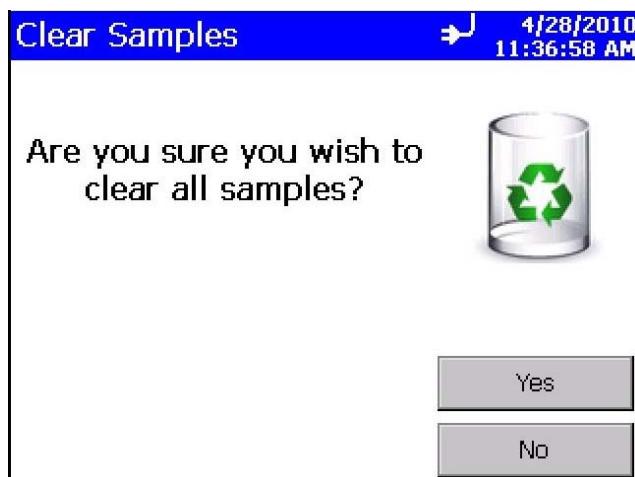

Device Setup Screen

Use this screen to access screens that let you set or change the date and time, set visual parameters of the display, set up communications, set regional features, and get system information such as software version, etc.



Date and Time Screen

This screen lets you set the current date and time and set the date format. Press **OK** when finished. You can select options using the arrows or tapping on the screen which brings up the keyboard.

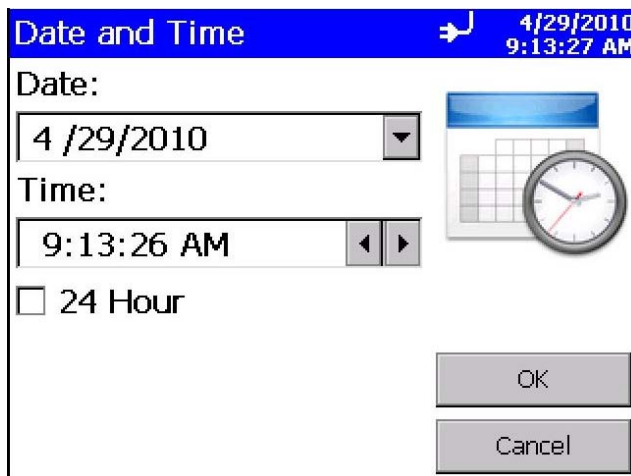

Field	Description
Date	Press the down arrow to display a calendar then select the date from the calendar.
Time	Select the time component you want to change (hours; minutes; seconds) and then use the left and right arrows to adjust to the current time.
24 Hour	Time display is in 24 hour format when checked.

Display Screen

This screen lets you set or change visual parameters

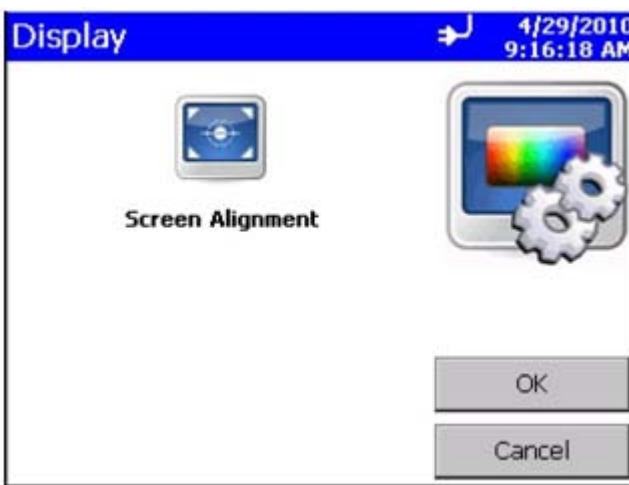

Field	Description
Screen Alignment	Press this item to reset the screen alignment, and follow the directions on the alignment screen.

Information Screen

This screen lets you view the system's model, serial number, copyright, manufacture date, calibration date, next calibration date, firmware version, USB IP address and date and time format. Press **Close** when finished.

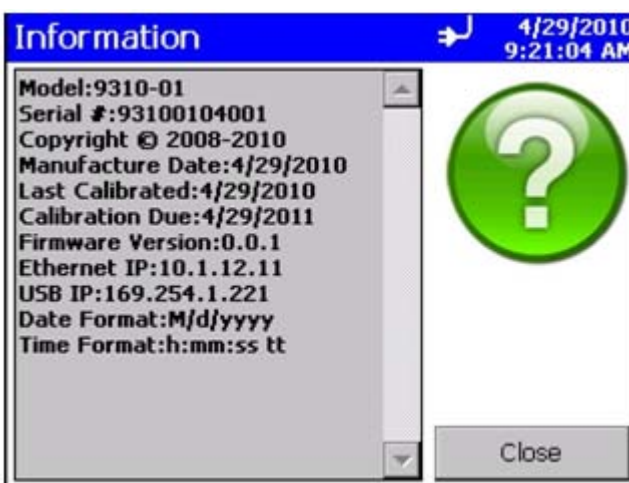

Communications Screen

This screen lets you configure the IP address, subnet, and default gateway to which the instrument belongs.

Field	Description
IP Address	The numerical identification (logical address) that is assigned to this device when participating in a computer network utilizing the Internet Protocol for communication between its nodes.
Subnet Mask	A network of computers and devices that have a common, designated IP address routing prefix. All hosts within a subnet can be reached in one "hop" (time to live = 1), implying that all hosts in a subnet are connected to the same link.
Default Gateway	A node on the computer network that serves as an access point to another network and is chosen when the IP address does not belong to any other entities in the Routing Table.
Use DHCP (Dynamic Host Configuration Protocol)	When checked, this protocol is used to automatically obtain the information necessary for operation from a DHCP server running on your local network.

Note

TCP/IP is an industry standard networking protocol that allows computers and devices to communicate over Ethernet and other media access channels. Providing full details on how to configure an IP network is beyond the scope of this manual. Please contact your company IT department or a qualified networking professional if you are not qualified to configure such a network.

Regional Screen

This screen lets you set the language in which the on-screen dialog is displayed and your regional format for numbers.



Field	Description
Language	Select the language in which you want on-screen dialog displayed; options are German, English, Spanish, French, Italian, Chinese, and Japanese.
Formats	Select the format that is commonly used to display real numbers and the date and time in your region.

Sampling Screen

Use this screen to access screens that let you set up how sampling is displayed and handled. You can select which channels to use, the sample timing, the count mode, count units, environment, and alarm thresholds.



Channels Screen

This screen lets you choose the channels that are enabled and set their particle size. Press **OK** when finished.

Enable	Size	Unit
<input checked="" type="checkbox"/>	0.3	μm
<input checked="" type="checkbox"/>	0.5	μm
<input checked="" type="checkbox"/>	1.0	μm
<input checked="" type="checkbox"/>	3.0	μm
<input checked="" type="checkbox"/>	5.0	μm
<input checked="" type="checkbox"/>	10.0	μm

Buttons: Defaults, OK, Cancel

Field	Description
Enable	Select the channels you want to view on the main display.
Size	If the instrument model allows variable bin sizes (-V2 model), this box allows for changing the default size for any channel. Highlight the size information and use the on-screen keyboard to change its value. Channels cannot be set below 0.3 or above 10.0 μm and they may not overlap one another.

Sample Timing Screen

This screen lets you select parameters for sampling. Use the up and down arrows or the on-screen keyboard to change or enter information. These parameters are only valid when the Model 9306 is running in Automatic mode. Press **OK** when finished.

Sample:	10
Delay:	00:00:10
Hold:	00:00:10
<input checked="" type="radio"/> Time:	00:01:00
<input type="radio"/> Volume:	0.1000
	Cubic Feet
	Cubic Meter

Buttons: Defaults, OK, Cancel

Field	Description
Sample	<p>Sample is the total number of samples you want collected. In Automatic mode, a Count value of 0 causes the instrument to count continuously using the settings for Delay, Time, and Hold until the Start/Stop button is pressed again. Use the up and down arrows or the on-screen keyboard to set the count.</p> <p>See Count Mode Screen for information on the different count modes.</p>
Delay	<p>Delay indicates how long it will be before the first sample is taken. Remember, it takes approximately 6 seconds for the pump to reach the flow set point; taking a measurement before the pump is functioning properly may result in a data error.</p> <p>Highlight the time component you want to change (hours, minutes, seconds) and use the up and down arrows or the on-screen keyboard to change the value.</p>
Hold	<p>Hold indicates how long the instrument pauses between samples. Highlight the time component you want to change (hours, minutes, seconds) and use the up and down arrows or the on-screen keyboard to change the value.</p>
Time	<p>Time indicates the duration of each sample run (count particles). Highlight the time component you want to change (hours, minutes, seconds) and use the up and down arrows or the on-screen keyboard to change the value.</p>
Volume	<p>Volume sets the volume of air that will pass through the instrument for each sample. If you select volume, you must select Cubic Feet, Cubic Meters or Cubic Liters for measurement using the arrows.</p>

Alarms Screen

Use this screen to set the alarm threshold for each channel. Press **OK** when finished.

The screenshot shows the 'Alarms' screen with a blue header bar containing a back arrow, the title 'Alarms', and the date/time '4/26/2010 4:17:36 AM'. Below the header is a table with two columns: 'Enable' and 'Threshold'. The 'Enable' column contains checkboxes for channel values 0.3, 0.5, 1.0, 3.0, 5.0, and 10.0. The 'Threshold' column contains input fields, all of which are currently set to '1000'. To the right of the table is a large red bell icon. At the bottom right of the screen are three buttons: 'Defaults', 'OK', and 'Cancel'.

Enable	Threshold
<input type="checkbox"/> 0.3	1000
<input type="checkbox"/> 0.5	1000
<input type="checkbox"/> 1.0	1000
<input type="checkbox"/> 3.0	1000
<input type="checkbox"/> 5.0	1000
<input type="checkbox"/> 10.0	1000

Field	Description
Enable	Select the channels on which you want to enable alarms.
Threshold	To change the threshold for any channel, click the up and down arrows for that channel or use the on-screen keyboard to change its value. The threshold value units use the current display Count Units (see Count Units Screen).

When a channel value exceeds the threshold value you set, the channel data is highlighted in red on the Main tab, an audible alarm sounds, and the alarm icon appears on the Main tab.

To clear the alarm, click the alarm icon . In addition, the record is printed if you have selected that option on the [Print Schedule Screen](#).

Count Mode Screen

Use this screen to set the sample count mode. Press **OK** when finished.

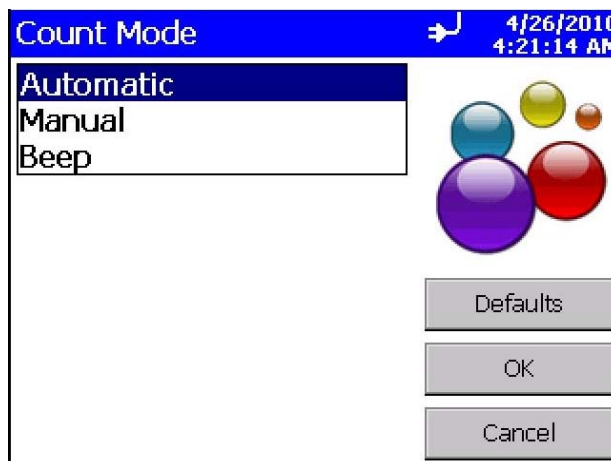

Field	Description
Automatic	If you select this mode, the Model 9306 starts counting in automatic mode when you press the start button according to the settings on the Sample Timing Screen .
Manual	If you select this mode, the Model 9306 starts sampling immediately when you press the start button and stops at the end of the sample time, which is configured on the Sample Timing Screen.
Beep	If you select this mode, the Model 9306 starts sampling data immediately and beeps whenever the threshold for the smallest bin is reached, as specified in Alarms Screen. This can be very useful when searching for leaks, especially around filters. If this mode is selected, Display mode is set to Particle Counts while in Beep mode. Settings on the sample timing screen are not used in beep mode.

Count Units Screen

This screen lets you set the way in which particle concentration information is displayed.

Field	Description
Differential	Select to display particle concentration as a differential Δ (the total number of counts is the number of particles <i>between</i> bin sizes).
Cumulative	Select to display particle concentration as cumulative Σ (the total number of counts includes all particles larger than the bin size).
Concentration	Display concentration in ft^3 or m^3 . If Beep mode is selected, display of concentration values is not allowed.

Environment Screen

Use this screen to set the units for temperature, which is displayed on the Main and Data Tabs, and the printouts when a humidity and temperature probe is hooked up to the instrument.

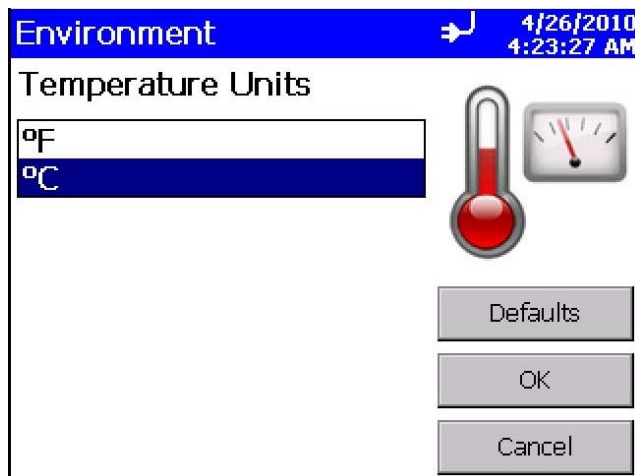

Field	Description
°F	Display temperature in degrees Fahrenheit.
°C	Display temperature in degrees Celsius.

Locations Screen

Associating collected samples with labeled locations can help keep your data organized. The Model 9306 allows you to create up to 250 labeled locations (up to 10 characters in length). Use this screen to add, remove, or modify a location names to the list of locations.

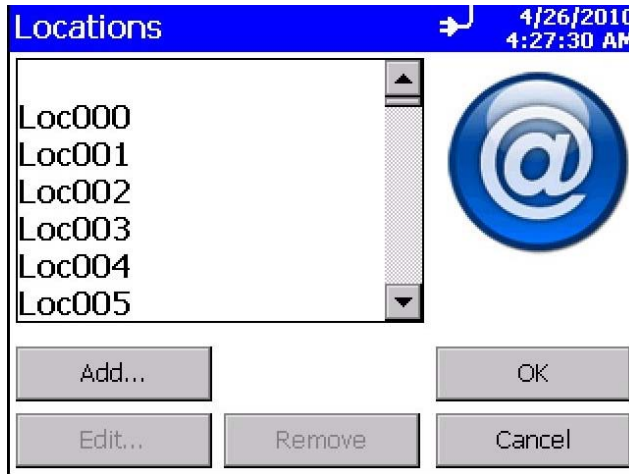

To modify a location name, highlight the name in the list, then click the **Edit..** button. In the "Enter Location" screen click the edit box in the middle and use the on-screen keyboard to modify a location name. (You cannot edit the empty location). Click **OK** when finished.



To add a location, click on the **Add..** button. In the "Add Location" screen click in the edit box in the middle and use the on-screen keyboard to add a location name. Click **OK** when finished.



To remove a location, click on location to be removed and click the **Remove** button.

Back in the main Locations screen, after all editing has been completed, press **OK** when finished.

Recipe Screen

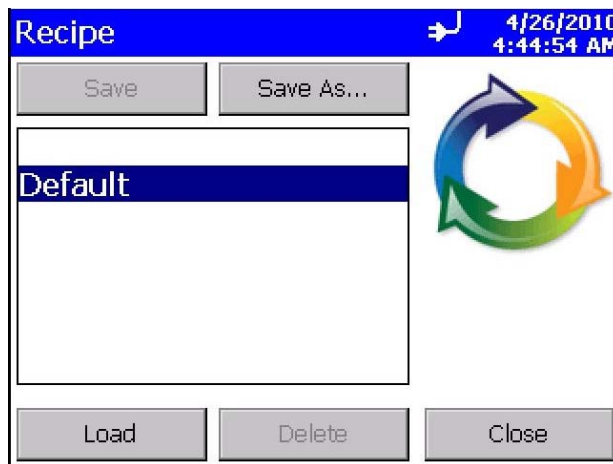

Use this screen to load and save recipes. Recipes let you save a group of settings (recipe) that you use over and over so you don't have to reset individual settings. There may be up to 100 recipes stored in the unit.





Field	Description
Save	<p>If you select a name in the box (highlighted) when you select Save, the recipe is saved over the selected file name (no dialog pops up asking for a file name). If no name is selected (highlighted), then you are asked for a file name and no Recipe name is currently selected.</p> <p>The settings/parameters that are saved include:</p> <p>For each channel (1-6):</p> <ul style="list-style-type: none"> • Alarm setting (on/off) • Alarm threshold (value) • Channel setting (enabled/disabled) • Channel threshold (value) <p>Sample Timing settings</p> <ul style="list-style-type: none"> • Count mode • Count total • Start delay (in secs) • Hold delay (in secs) • Sample time (in secs) <p>Count Mode/Units Settings</p> <ul style="list-style-type: none"> • Display normalized • Units (count, ft³ or m³) • Cumulative/Differential • Volume units <p>Printing settings</p> <ul style="list-style-type: none"> • Auto print and mode • Print cumulative/differential • Print reverse setting (if supported) • Print model, separator, serial number
Save As	<p>When you select Save As, a new window opens that lets you enter a name for the recipe you want to save.</p>
Load	<p>Highlight the recipe you want to load and press Load. The settings/parameters are reset to the values of that recipe.</p>
Delete	<p>Highlight the recipe you want to delete and press Delete. The recipe is deleted.</p>

Data Tab

The Data tab lets you preview data that has been collected. Use the elevator (slide) on the right to scroll through the records. The record number is displayed at the bottom of the tab. As each record displays, its data and relevant parameters are displayed.

#	Size	Δ	Σ	
	0.3	88051	89387	
	0.5	984	1336	
	1.0	211	352	
	3.0	123	141	
	5.0	7	18	
	10.0	11	11	
Location: LOC000 Laser: OK Alarm: NONE Sample: 00:00:30 Vol: 102.0 L Flow: ALRM Date: 6/24/2010 Temp: 25.0 °C RH: 50 % Time: 4:54:30 PM Vel: 3.28 ft/s				
Record: 60 Records: 100 / 10000				
Main		Setup		Data
				Reports

Field	Description
#, ft ³ , m ³	Button used to change between counts and concentration displays.
Size	Channel size.
Δ	Differential concentration.
Σ	Cumulative concentration.
	Export the data to a flash drive. See Export Data Screen below.
	Print data to the optional printer. See Print Data below
Location	Location where the data was collected.
Sample	Duration of the sampling period.
Date	Date on which the data was collected.
Time	Time at which data was collected.
Temperature	Temperature at the end of the time the data was collected (if probe connected during sampling).
Humidity	Humidity level at the end of the time the data was collected (if probe connected during sampling).
Flow	Status of the flow. Options are: OK or ALRM. OK indicates the flow rate is good; ALRM indicates flow rate is below the defined setting.
Alarm	Alarm threshold was triggered (YES) or not (NONE).
Laser	Status of the laser. OK if no issues; SRVC if laser has a possible issue.
Vol	Volume of air that was sampled.

Export Data Screen

The export button lets you export sample data to a flash drive. The data will be exported in .XML format that can be opened in Microsoft Excel® spreadsheet (version 2003 or later) or other XML readers applications.



Field	Description
Export	If you select a name in the box (highlighted), the data is exported to the selected file name (no dialog pops up asking for a file name). If no name is selected (highlighted), then you are asked for a file name.
Export As	Always asks for a file name to which the data will be saved.

Print Data

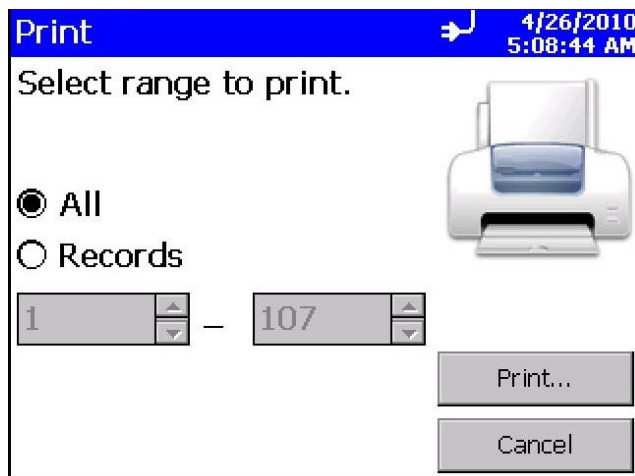

The print button allows a range of sample data to be printed using the optional 8930 external printer.

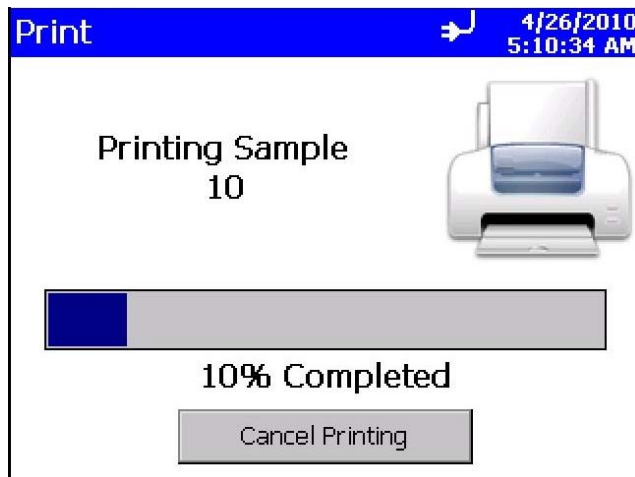

The print data screen will show progress on the current selected range of sample data to be printed. Press the **Cancel Printing** button to cancel the rest of the print job.



Reports Tab

Use this screen to select various standard reports for viewing and printing. Use the Room Definition icon  to view or change specific values for the room and class, and the Generate icon  to generate reports for viewing or printing.

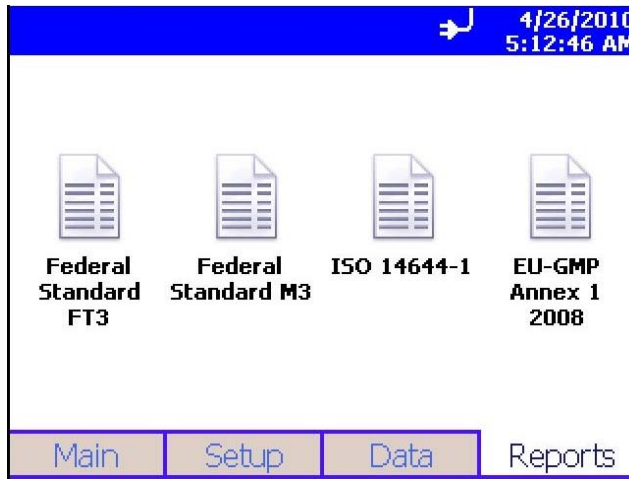

The standard reports are shown below:

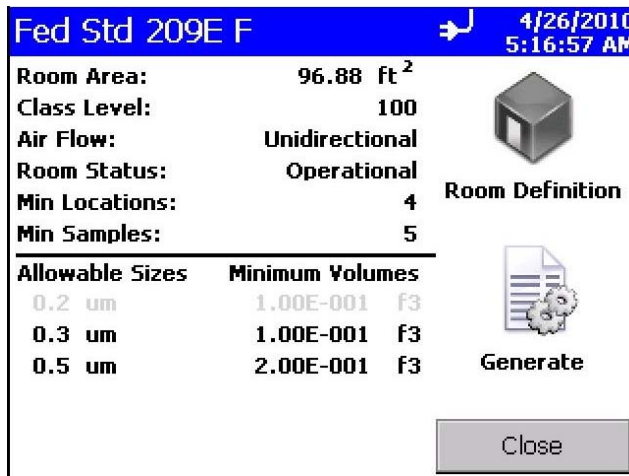

Fed Std 209E M 4/26/2010
5:19:09 AM

Room Area: 9.00 m²
 Class Level: M2
 Air Flow: Unidirectional
 Room Status: Operational
 Min Locations: 4
 Min Samples: 5



Room Definition

Allowable Sizes	Minimum Volumes
0.1 um	5.71E+000 m3
0.2 um	2.64E+001 m3
0.3 um	6.47E+001 m3
0.5 um	2.00E+002 m3



Generate

ISO 14644-1 4/26/2010
5:20:21 AM

Room Area: 9.00 m²
 Class Level: 3
 Air Flow: Unidirectional
 Room Status: At Rest
 Min Locations: 3
 Min Samples: 3



Room Definition

Allowable Sizes	Minimum Volumes
0.1 um	2.00E+001 L
0.2 um	8.44E+001 L
0.3 um	1.96E+002 L
0.5 um	5.71E+002 L
1.0 um	2.50E+003 L



Generate

EU-GMP Annex 1 4/26/2010
5:28:08 AM

Room Area: 9.00 m²
 Class Level: C
 Air Flow: Unidirectional
 Room Status: At Rest
 Min Locations: 3
 Min Samples: 3

Room Definition

Allowable Sizes	Minimum Volumes
0.5 um	2.00E+000 L
5.0 um	6.90E+000 L

Generate

Field	Description
Room Area	Displays the area of the room in ft ² or m ² .
Class Level	Depends on the report definition, see below.
Air Flow	Displays the airflow characteristics of the room.
Room Status	Displays the status of the room. See Room Definition Screen below.
Min Locations	Displays the minimum number of locations that must be sampled in the room.
Min Samples	Displays the minimum number of samples that must be taken at each location.
Min Vol. per channel	Allowable channel sizes for the selected Class Level for that Standard.
Room Definition	Press to set definitions for the room. (See Room Definition Screen below.)
Generate	Press to begin generating a report that you can view on-screen or print. (See Generate Screens below.)

Room Definition Screen

Use this screen to define specific values for the room. Press **OK** when finished.

Field	Description
Room Status	Select the room status: As Built, At Rest, or Operational.
Air Flow	Select the air flow: Unidirectional or Non-unidirectional.
Class	Select the class of the room: The class is dependent on the standard: FED FT3: 1, 20, 100,1000,10000, 100000 FED M3: M1.0, M1.5, M2.0, M2.5, M3.0, M3.5, M4.0, M4.5, M5.0, M5.5, M6.0, M6.5, M7.0 ISO14644-1: 1, 2, 3, 4, 5, 6, 7, 8, 9 EC GMP: A, B, C, D
Area	Use the on-screen keyboard to enter the area of the room in ft ² or m ² .

Generate Screens

When you press the Generate icon from any of the report screen, the following screen is displayed to let you select either all records or a range of records to generate the report. After selecting the desired records, press the **Channels..** button.

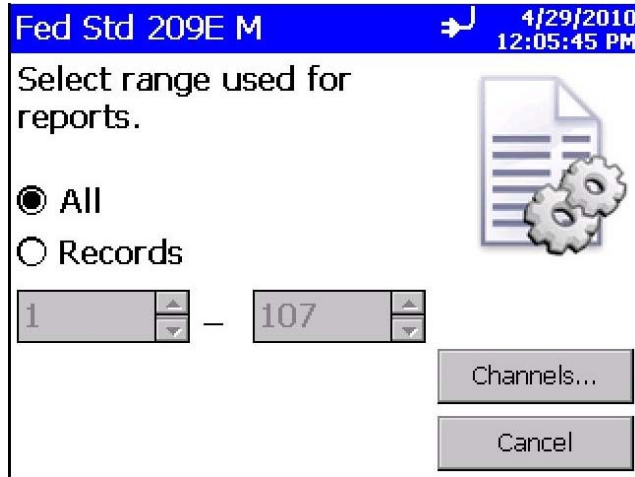

After you select **Channels..** the following screen is displayed. Select the channels (particle sizes) to include in the report and then press **Generate...**

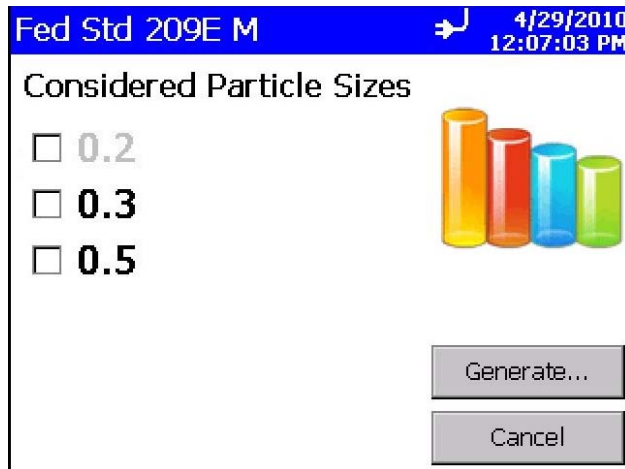

The generated report is displayed on the screen and may be viewed there. It can also be printed using the optional 8930 printer (must be attached) by pressing the **Print** button.

Fed Std 209E F 4/30/2010
9:13:46 AM

Fed Std 209E Ft Report

Inst Model : 9310-01
Serial # :93100104001
Target Class: 100
Room Area : 96.9 ft^2
Room Status :Operational
Air Flow: Unidirectional

4/30/2010, 9:13:22 AM

Print Close

(This page intentionally left blank)

CHAPTER 4

Data Handling

USB Data Download

The Model 9306 AEROTRAK™ Handheld Airborne Particle Counter is equipped with a USB A host drive that will allow for the downloading of stored data to a USB Thumb drive. To download data, attach a thumb drive to the USB A host port and follow the instructions in the [operation section](#) of this manual. The data is downloaded in XML format that can be opened in Microsoft Excel® version 2003 or greater. The data files can also be opened in the latest versions of OpenOffice™ application.



USB Computer Communication

The Model 9306 AEROTRAK™ Handheld Airborne Particle Counter is equipped with a USB compatible cable for uploading and downloading information to a PC. The cable plugs into the right side of the instrument.



Installing Software

See the *TRAKPRO™ Lite Software (version 2.2 or later) User's Guide* (P/N 6002796) on CD (P/N 7001384) for installation instructions.

Ethernet Communications

An Ethernet port is provided for use with TSI Facility Monitoring Software (FMS). Refer to the FMS Software documentation and the TSI service and installation manual for detailed configuration and operation information on Modbus[®] TCP over Ethernet.



(This page intentionally left blank)

CHAPTER 5

Maintenance

Note
There are no user-serviceable parts inside this instrument. Opening the instrument case may void the warranty. TSI recommends that you return the AEROTRAK™ Airborne Particle Counter to the factory for any required maintenance or service not described in this manual.

Maintenance Schedule

TSI recommends annual factory cleaning and calibration for the AEROTRAK™ Airborne Particle Counter. See [Chapter 7, "Contacting Customer Service"](#) for service/calibration.

Recommended Field Maintenance Schedule

Item	Frequency
Zero check	Daily or according to application.
Factory cleaning and calibration	Annually.
Cleaning the instrument enclosure	As needed.

Zero Check

The zero check ensures that the instrument is properly assembled and free from leaks, residual particles and electronic noise. Please see Chapter 2, "[Getting Started](#)" for detailed instructions on performing the zero check.

Cleaning the Instrument Enclosure

To clean the enclosure, dampen a lint-free cloth and gently wipe the surface until surface contamination is removed.

(This page intentionally left blank)



CHAPTER 6

Troubleshooting

Symptom	Possible Cause	Corrective Action
Counts are too low.	<p>Instrument is being operated outside temperature or relative humidity specifications.</p> <p>Internal parts have been damaged because instrument was stored at a temperature greater than 122°F (50°C).</p> <p>Instrument has contamination on the optics due to condensation or excessive loading.</p> <p>Laser or pump control is damaged.</p> <p>Unit is due for calibration.</p>	<p>Operate instrument within specifications.</p> <p>Return to factory or factory authorized service centers for service.</p> <p>Return to factory or factory authorized service centers for service.</p> <p>Return to factory or factory authorized service centers for service.</p> <p>Return to factory or factory authorized service centers for service.</p>
Instrument does not turn on.	<p>Battery is not charged.</p> <p>AC cord is not plugged into unit.</p>	<p>Recharge battery or connect to AC power.</p> <p>Connect AC cord.</p>

continued on next page

Symptom	Possible Cause	Corrective Action
Instrument does not meet zero count specification (<1 particle/5 mins).	<p>Particles are in the instrument chamber.</p> <p>HEPA filter is not connected properly and room air is leaking into the HEPA filter assembly.</p> <p>Residual particles from previous samples are shedding off internal parts and into the optics.</p> <p>An internal component has been damaged due to operation outside of temperature specifications or one or more excessive bumps or jolts, and electronic noise is inducing false counts.</p> <p>A leak has developed in the aerosol flow path.</p> <p>Internal optics have become dirty.</p>	<p>Run the instrument for one-half hour with a filter and then recheck the zero count.</p> <p>Check that the HEPA filter has been tightly connected to the inlet. Check that rubber O-ring (black) on the inlet is in place.</p> <p>Purge instrument by running the instrument for 10 to 15 minutes before attempting zero count test. If instrument has heavier contamination, purge of 1 hour or longer may be needed.</p> <p>Return to factory or factory authorized service centers for service.</p> <p>Return to factory or factory authorized service centers for service.</p> <p>Return to factory or factory authorized service centers for service.</p>
Battery does not charge.	<p>The unit must be turned on but not in sampling mode for the battery to charge.</p> <p>Unit not put in standby mode.</p>	<p>Turn on unit.</p> <p>The battery will only charge if the unit is turned on but is not actively taking a sample.</p> <p>Select Standby/Charge when shutting off the instrument if you want the battery to be charged.</p>
<p>LOW BATTERY ERROR</p> 	Low battery.	Recharge battery or connect AC cord.
SYSTEM ERROR	Information is not being read properly by microprocessor.	Restart instrument. If problem persists, contact TSI technical support.

Symptom	Possible Cause	Corrective Action
TEMPERATURE HUMIDITY PROBE ERROR	Temperature/RH probe was not recognized.	Detach and reconnect probe. If problem persists, contact TSI technical support.
FLOW ERROR 	Instrument was unable to control flow rate (if any tubing is connected to particle counter). Pressure drop across inlet may be too large. Inlet not at ambient pressure.	Restart measurement. Lessen pressure drop across inlet by using larger diameter tubing, less tubing, and/or adding a bleed valve. Do not subject the unit to other than ambient pressure conditions.
LASER POWER / DETECTOR WARNING 	Excessive direct light is entering the aerosol inlet. Optical path blocked. Nozzle is misaligned. Fiber attached on the nozzle tip. Detector board damaged. Laser power is normal.	Remove instrument from direct light. Return to factory for service. Contact TSI and return to factory. Return to factory or factory authorized service centers for service.

(This page intentionally left blank)

CHAPTER 7

Contacting Customer Service

This chapter gives directions for contacting people at TSI Incorporated for technical information and directions for returning the Model 9306 AEROTRAK™ Handheld Particle Counter for service.

Technical Contacts

- If you have any difficulty setting up or operating the AEROTRAK™ Model 9306, or if you have technical or application questions about this system, contact an applications engineer at TSI Incorporated, 1-800-874-2811 (USA) or (651) 490-2811 or e-mail technical.service@tsi.com.
- If the AEROTRAK™ Model 9306, does not operate properly, or if you are returning the instrument for service, visit our website at <http://rma.tsi.com>, or contact TSI Customer Service at 1-800-874-2811 (USA) or (651) 490-2811.

International Contacts

Service

TSI Instruments Singapore Pte Ltd
150 Kampong Ampat
#05-05 KA Centre
Singapore 368324

Telephone: +65 6595-6388
Fax: +65 6595-6399
E-mail: tsi-singapore@tsi.com

TSI Instruments Ltd.

Stirling Road
Cressex Business Park
High Wycombe, Bucks
HP12 3RT
UNITED KINGDOM

Telephone: +44 (0) 149 4 459200

Fax: +44 (0) 149 4 459700

E-mail: tsiuk@tsi.com

Web: www.tsiinc.co.uk

Technical Support**TSI Instruments Singapore Pte Ltd**

150 Kampong Ampat
#05-05 KA Centre
Singapore 368324

Telephone: +65 6595-6388

Fax: +65 6595-6399

E-mail: tsi-singapore@tsi.com

TSI GmbH

Neuköllner Strasse 4
52068 Aachen
GERMANY

Telephone: +49 241-52303-0

Fax: +49 241-52303-49

E-mail: tsigmbh@tsi.com

Web: www.tsiinc.de

TSI Instruments Ltd.

Stirling Road
Cressex Business Park
High Wycombe, Bucks
HP12 3RT
UNITED KINGDOM

Telephone: +44 (0) 149 4 459200

Fax: +44 (0) 149 4 459700

E-mail: tsiuk@tsi.com

Web: www.tsiinc.co.uk

TSI France Inc.

Hotel technologique
BP 100
Technopôle de Château-Gombert
13382 Marseille cedex 13
FRANCE

Telephone: + 33 (0) 491 11 87 64

Fax: + 33 (0) 491 11 87 65

E-mail: tsifrance@tsi.com

Web: www.tsiinc.fr

Returning the AEROTRAK™ Handheld Airborne Particle Counter for Service

Visit our website at <http://rma.tsi.com> or call TSI at 1-800-874-2811 (USA) or (651) 490-2811 for specific return instructions. Customer Service will need this information when you call:

- The instrument model number
- The instrument serial number
- A purchase order number (unless under warranty)
- A billing address
- A shipping address

Use the original packing material to return the instrument to TSI. If you no longer have the original packing material, seal off any ports to prevent debris from entering the instrument and ensure that the display and the connectors on the instrument front and back panels are protected.

(This page intentionally left blank)

APPENDIX A

Specifications

All specifications meet or exceed ISO 21501-4 and JIS B9921. They are subject to change without notice.

Size Range	0.3 to 25 µm
Channel Sizes	Standard: 0.3, 0.5, 0.7, 1.0, 2.0, 5.0 µm Standard: 0.3, 0.5, 1.0, 3.0, 5.0, 10.0 µm Standard: 0.3 to 10 µm, user-selectable; factory-calibrated at 0.3, 0.5, 1.0, 3.0, 5.0, 10.0 µm. Additional channel sizes available
Size Resolution	<15% at 0.5 µm (per ISO 21501-4 requirements)
Counting Efficiency	50% at 0.3 µm; 100% for particles > 0.45 µm (per JIS and ISO 21501-4)
Concentration Limits	3,000,000 particles/ft ³ at 5% coincidence loss
Light Source	Long life laser diode
Zero Count Level	<1 count/5 minutes (per JIS B9921 and ISO 21501-4)
Flow Rate	0.1 CFM (2.83 L/min) with ±5% accuracy (meets JIS and ISO 21501-4 requirements)
Calibration	NIST traceable with TSI calibration system
Calibration Frequency	Recommended minimum once per year
Sample Probe/Tubing	Isokinetic sampling probe
Sampling Modes	Manual, automatic, beep, cumulative/differential count or concentration
Sampling Time	1 second to 99 hours
Sampling Frequency	1 to 9999 cycles or continuous
Exhaust	Internally filtered
Vacuum Source	Internal pump
Communication Mode	Modbus [®] TCP over Ethernet or USB
Data Storage	10,000 sample records: includes date, time, six particle channels, flow, ID, and sample volume; transferable via USB data download or TRAKPRO™ Lite software
Data Security	Password protected
Alarm/Status	Audible alarm on counts, low battery, and sensor status indicators
Environmental Sensors	Optional temperature/RH probe supported
Display	QVGA 3.5-inch (8.9-cm) touch screen with Windows [®] CE operating system

Languages	English, Spanish, German, French, Italian, Japanese, and Chinese (simplified)
Reports	Provides Pass/Fail on FS-209E, ISO 14644-1 and EU GMP
Printer	Optional external printer supported
External Surface	High impact injection molded plastic
Power	110 to 240 VAC 50 to 60 Hz Universal in-line power supply
Battery	Removable/rechargeable Li-Ion
Battery Life	>Up to 7 hours of continuous use
Recharge Time	4 hours
Dimensions (L x W x H)	9.4 x 4.9 x 3.2 in.(23.9 x 12.4 x 8.1 cm)
Weight	1.0 kg (2.2 lbs) with battery
Standards	CE, JIS B9921, ISO 21501-4 as listed above
Warranty	2 years. Extended warranties available
Operating Conditions	41 to 95°F (5°C to 35°C); 20% to 95% non-condensing relative humidity
Storage Conditions	32 to 122°F (0°C to 50°C); Up to 98% non-condensing relative humidity
Included Accessories	Power supply, power cord, battery, isokinetic inlet, stylus, purge filter, TRAKPRO™ Lite data download software, operational manual on CD, computer cable, calibration certificate, and Quick Start Guide.
Optional Accessories	Temp R/H probe, stainless steel isokinetic inlet and probe, tubing, barbed inlet fitting, printer, printer paper, carrying case and external battery charger

Temperature/RH Probe (700084) Specifications (optional accessory)

Temperature	
Range	32 to 115°F (0 to 45°C)
Accuracy	±4°F (±2°C)
Relative Humidity	
Range	10 to 90% RH
Accuracy	±5% RH

Compliance

CE Marking	EN61326 / EN 55011, Class BA: Radiated Emissions EN61326 / EN 55011, Class BA: Conducted Emissions EN61000-3-2: Harmonics EN61000-3-3: Voltage Fluctuations EN61000-4-2: Electrostatic Discharge Immunity EN61000-4-3: Electromagnetic Field Immunity EN61000-4-4: Burst Immunity EN61000-4-6: Conducted PS Immunity EN61000-4-5: Surge Immunity EN61000-4-8: Rated Power-Frequency Field Immunity EN61000-4-11: Voltage Dips\Short Interruptions Immunity
RoHS Marking	Yes

Dimensional Diagram

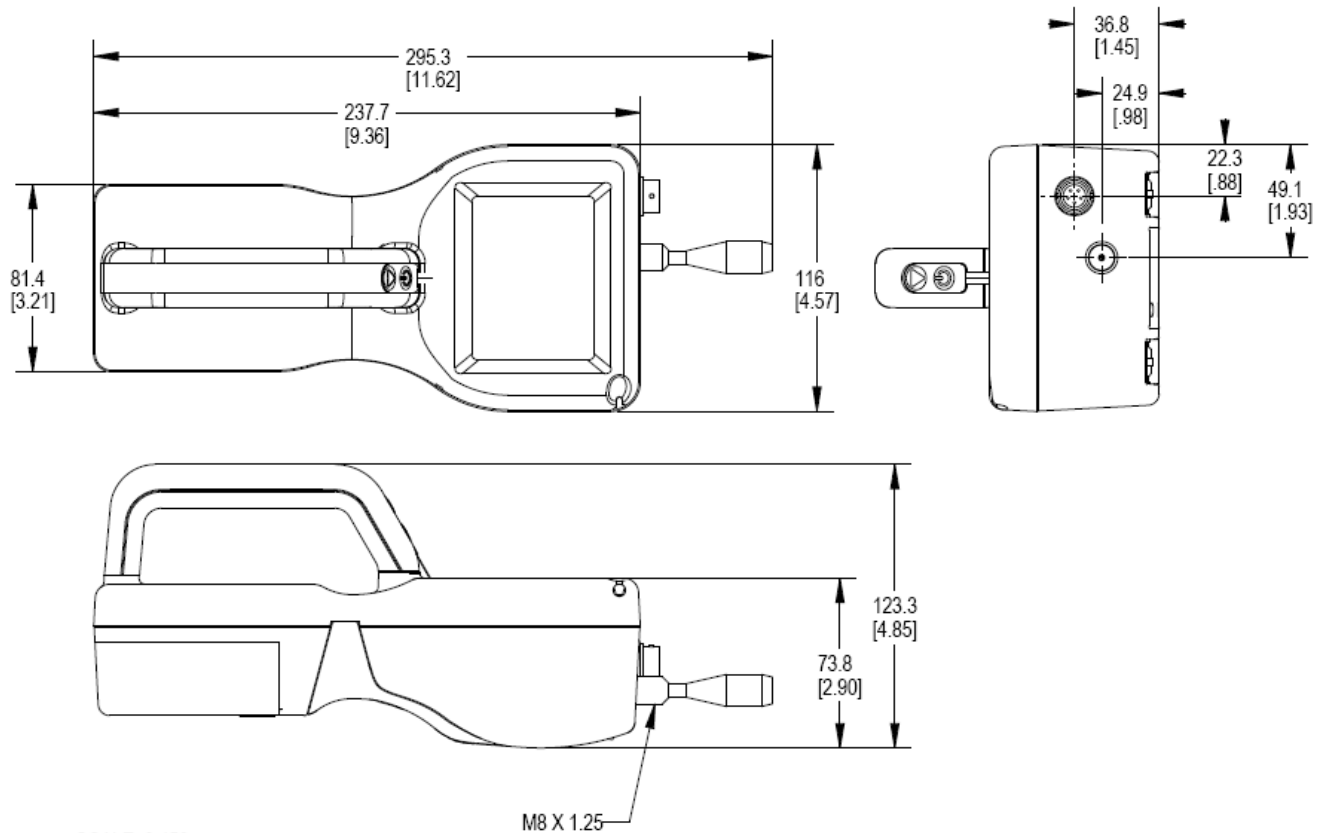

(This page intentionally left blank)

Index

2

24 hour, 3-13

A

accessories, A-2
optional, 1-3, A-2

air flow, 3-31

alarm, 3-26

alarm/status, A-1

alarms screen, 3-19

enable, 3-19

threshold, 3-19

area, 3-31

automatic, 3-20

automatic printing, 3-12

B

barb inlet fitting, 1-4

battery, A-2

external charger, 1-3

installation, 2-3

life, A-2

low battery error, 6-2

not charging, 6-2

pack, 1-2

recharge time, A-2

beep, 3-20

bin size, 3-5

C

calibration, A-1

maintenance, 5-1

calibration certificate, 1-3

Calibration label, viii

carry case, 1-3

caution

description, ix

symbol, ix

CE marking, A-3

change setup, 3-9

change setup password

confirm new password, 3-9

new password, 3-9

old password, 3-9

channel sizes, A-1

channels

enable, 3-17

size, 3-17

channels screen, 3-17

class, 3-31

class level, 3-31

clear samples screen, 3-12

communication mode, A-1

communications

default gateway, 3-15

IP address, 3-15

subnet mask, 3-15

use dhcp, 3-15

communications screen, 3-15

compliance, A-3

computer cable, 1-2

concentration, 3-21

concentration limits, A-1

configuration screen, 3-10

confirm new password, 3-8, 3-9

contacting TSI, 7-1

email address, iii

count mode screen, 3-20

automatic, 3-20

beep, 3-20

manual, 3-20

count units

concentration, 3-21

cumulative, 3-21

differential, 3-21

count units screen, 3-21

counting efficiency, A-1

counts too low, 6-1

cumulative, 3-11, 3-21

customer service, 7-1

D

data handling, 4-2

data security, A-1

data storage, A-1

data tab, 3-26

alarm, 3-26

date, 3-26

export data, 3-26

flow, 3-26

humidity, 3-26

laser, 3-26

location, 3-26

print data, 3-26

sample, 3-26

size, 3-26

temperature, 3-26

time, 3-26

vol, 3-26

date, 3-13, 3-26

date and time

24 hour, 3-13

date, 3-13

time, 3-13

- date and time screen, 3-13
- default gateway, 3-15
- delay, 3-4, 3-18
- delete, 3-25
- detector warning, 6-3
- device setup, 3-6
- device setup screen, 3-13
- differential, 3-11, 3-21
- dimensions, A-2, A-3
- display, A-1
 - screen alignment, 3-14
- display screen, 3-14

E

- enable, 3-17, 3-19
- environment screen, 3-22
- environmental sensors, A-1
- ESD protection, ix
- Ethernet, 4-3
- European symbol for non-disposable item, viii
- export, 3-27
 - export as, 3-27
 - export data, 3-26
 - export, 3-27
 - export as, 3-27
- export data screen, 3-27
- external printer, 1-3
- external surface, A-2

F

- flow, 3-26
 - error, 6-3
- flow rate, A-1
- formats, 3-16
- functionality, 3-1

G

- generate, 3-31
- generate screens, 3-32
- getting help, x
- getting started, 2-1

H

- help, x, 7-1
- HEPA zero filter assembly, 1-2
- hold, 3-18
- humidity, 3-26

I

- isokinetic inlet, 1-2, 2-1
- information screen, 3-14
- instrument description, 2-1
- instrument enclosure
 - cleaning, 5-1
 - maintenance, 5-1
- instrument not meeting zero count specification, 6-2
- instrument not turning on, 6-1
- introduction, 1-1
- IP address, 3-15
- ISO 21501-4, A-2

- isokinetic inlet
 - installation, 2-6
- isokinetic probe, 1-4

J

- JIS B9921, A-2

K

- keyboard, 3-2

L

- language, 3-16
- languages, A-2
- laser, 3-26
- laser power warning, 6-3
- laser radiation label, viii
- laser radiation symbol label, viii
- laser safety, vii
- last calibration, 3-11
- light source, A-1
- load, 3-25
- location, 3-4, 3-5, 3-26
- locations, 3-6
- locations screen, 3-23

M

- main tab, 3-2
- maintenance
 - schedule, 5-1
- manual, 3-20
- manual history, ii
- manual/automatic/beep, 3-4
- min location, 3-31
- min samples, 3-31
- min vol per channel, 3-31
- model name, 3-11

N

- new password, 3-8, 3-9

O

- old password, 3-8, 3-9
- on alarm, 3-12
- on sample, 3-12
- operating conditions, A-2
- operation, 3-1

P-Q

- packing instructions, 7-3
- particle count/concentration, 3-5
- password
 - changing, 3-9
- power, A-2
 - providing, 2-3
 - using, 2-4
- power button, 2-1
- power entry button, 2-1

- power on password
 - confirm new password, 3-8
 - new password, 3-8
 - old password, 3-8
- power on password screen, 3-7
- power supply, 1-2
- print
 - button, 3-27, 3-28
 - icon, 3-4
 - schedule screen, 3-12
 - settings screen, 3-11
- print data, 3-26
- print schedule
 - automatic printing, 3-12
 - on alarm, 3-12
 - on sample, 3-12
- print screen
 - cumulative, 3-11
 - differential, 3-11
 - last calibration, 3-11
 - model name, 3-11
 - separator, 3-11
- print settings
 - serial number, 3-11
- printer, A-2
 - using, 2-4
- printer paper
 - colored strip, 3-11
- printer port, 2-1

R

- recipe, 3-4
- recipe screen, 3-24
 - delete, 3-25
 - load, 3-25
 - save, 3-25
 - save as, 3-25
- recipes, 3-6
- recs, 3-4
- regional
 - formats, 3-16
 - language, 3-16
- regional screen, 3-16
- relative humidity, 3-5
 - probe, A-2
- reports, A-2
- reports tab, 3-29
 - air flow, 3-31
 - class level, 3-31
 - generate, 3-31
 - min locations, 3-31
 - min samples, 3-31
 - min vol per channel, 3-31
 - room area, 3-31
 - room definition, 3-31
 - room status, 3-31
- returning for service, 7-3
- RoHS marking, A-3
- room area, 3-31

- room definition, 3-31
 - air flow, 3-31
 - area, 3-31
 - class, 3-31
 - room status, 3-31
- room status, 3-31

S

- safety, vii
- sample, 3-18, 3-26
- sample output, A-1
- sample probe/tubing, A-1
- sample timing sample, 3-18
- sample timing screen, 3-17
 - delay, 3-18
 - hold, 3-18
 - time, 3-18
 - volume, 3-18
- sampling
 - frequency, A-1
 - modes, A-1
 - time, A-1
- sampling screen, 3-16
- sampling setup, 3-6
- save, 3-25
- save as, 3-25
- screen alignment, 3-14
- screen layout, 3-1
- separator, 3-11
- serial number, 3-11
- serial number label, viii
- service
 - returning, 7-3
- setup tab, 3-6
 - device setup, 3-6
 - locations, 3-6
 - recipes, 3-6
 - sampling setup, 3-6
 - system setup, 3-6
- size, 3-17, 3-26
- size range, 1-1, A-1
- software
 - installation, 4-2
 - specifications, A-1
- stainless steel isokinetic inlet, 1-4
- stand, 2-1
 - using, 2-2
- standards, A-2
- start sample, 2-1
- start/stop buttons, 3-4, 3-5
- storage conditions, A-2
- store partial samples, 3-10
- stylus, 1-2, 2-1
 - using, 2-2
- subnet mask, 3-15
- superthane tubing, 1-4
- system configuration
 - store partial samples, 3-10
 - zoom, 3-10
- system error, 6-2
- system setup, 3-6
- system setup screen, 3-7

T

- TCP/IP, 3-15
- technical contacts, 7-1
- temperature, 3-5, 3-26
 - probe, A-2
- temperature/humidity probe, 1-4
 - error, 6-3
 - installation, 2-7
- threshold, 3-19
- time, 3-4, 3-13, 3-18, 3-26
- touch screen, 2-1
- troubleshooting, 6-1

U

- unpacking, 1-2
- USB computer communication, 4-2
- USB port, 2-1
- use dhcp, 3-15

V

- vacuum source, A-1
- vol, 3-26
- volume, 3-18

W–X–Y

- warning
 - description, ix, 2-3
 - symbol, ix
- warranty, iii, A-2
- weight, A-2

Z

- zero check
 - maintenance, 5-1
 - performing, 2-5
- zero count level, A-1
- zoom, 3-10
- zoomed data screen, 3-5

TSI Incorporated – 500 Cardigan Road, Shoreview, MN 55126 U.S.A

USA	Tel: +1 800 874 2811	E-mail: aerotrak@tsi.com	Website: www.tsi.com
UK	Tel: +44 149 4 459200	E-mail: tsiuk@tsi.com	Website: www.tsiinc.co.uk
France	Tel: +33 491 11 87 64	E-mail: tsifrance@tsi.com	Website: www.tsiinc.fr
Germany	Tel: +49 241 523030	E-mail: tsigmbh@tsi.com	Website: www.tsiinc.de
India	Tel: +91 80 41132470	E-mail: tsi-india@tsi.com	
China	Tel: +86 10 8251 6588	E-mail: tsibeijing@tsi.com	
Singapore	Tel: +65 6595 6388	E-mail: tsi-singapore@tsi.com	



TRUST. SCIENCE. INNOVATION.

Contact your local TSI Distributor or visit our website www.tsi.com for more detailed specifications.