

# AEROTRAK® HANDHELD AIRBORNE PARTICLE COUNTER MODEL 9303

---

OPERATION MANUAL

P/N 6002277, REVISION J  
DECEMBER 2017



# START SEEING THE BENEFITS OF REGISTERING TODAY!

---

Thank you for your TSI instrument purchase. Occasionally, TSI releases information on software updates, product enhancements and new products. By registering your instrument, TSI will be able to send this important information to you.

**<http://register.tsi.com>**

As part of the registration process, you will be asked for your comments on TSI products and services. TSI's customer feedback program gives customers like you a way to tell us how we are doing.



UNDERSTANDING, ACCELERATED

**TSI Incorporated** - Visit our website [www.tsi.com](http://www.tsi.com) for more information.

<b>USA</b>	<b>Tel:</b> +1 800 874 2811	<b>India</b>	<b>Tel:</b> +91 80 67877200
<b>UK</b>	<b>Tel:</b> +44 149 4 459200	<b>China</b>	<b>Tel:</b> +86 10 8219 7688
<b>France</b>	<b>Tel:</b> +33 1 41 19 21 99	<b>Singapore</b>	<b>Tel:</b> +65 6595 6388
<b>Germany</b>	<b>Tel:</b> +49 241 523030		

©2015 TSI Incorporated

Printed in U.S.A.

# AEROTRAK®

## HANDHELD AIRBORNE PARTICLE COUNTER

### MODEL 9303

---

OPERATION MANUAL

P/N 6002277, REVISION J  
DECEMBER 2017

**SHIP TO/MAIL TO:**

TSI Incorporated  
500 Cardigan Road  
Shoreview, MN 55126-3996  
USA

**U.S.**

**Technical Support:**

(800) 874-2811/(651) 490-2811

**Fax:**

(651) 490-3824

**E-mail address:**

[answers@tsi.com](mailto:answers@tsi.com)

**Website:**

<http://www.tsi.com>

**INTERNATIONAL**

**Technical Support:**

(001 651) 490-2811

**Fax:**

(001 651) 490-3824



# Manual History

The following is a manual history of the AeroTrak® Handheld Airborne Particle Counter, Model 9303 Operation Manual (P/N 6002277).

<b>Revision</b>	<b>Date</b>
A	November 2008
B	January 2009
C	June 2009
D	July 2010
E	September 2010
F	February 2011
G	November 2012
H	February 2016
J	December 2017

# Warranty

<b>Part Number</b>	6002277 / Revision J / December 2017
<b>Copyright</b>	©TSI Incorporated / 2010-2017 / All rights reserved.
<b>Address</b>	TSI Incorporated / 500 Cardigan Road / Shoreview, MN 55126 / USA
<b>E-mail Address</b>	<a href="mailto:answers@tsi.com">answers@tsi.com</a>
<b>Limitation of Warranty and Liability</b> (effective April 2014)	<p>(For country-specific terms and conditions outside of the USA, please visit <a href="http://www.tsi.com">www.tsi.com</a>.)</p> <p>Seller warrants the goods, excluding software, sold hereunder, under normal use and service as described in the operator's manual, to be free from defects in workmanship and material for 12 months, or if less, the length of time specified in the operator's manual, from the date of shipment to the customer. This warranty period is inclusive of any statutory warranty. This limited warranty is subject to the following exclusions and exceptions:</p> <ol style="list-style-type: none"><li>Hot-wire or hot-film sensors used with research anemometers, and certain other components when indicated in specifications, are warranted for 90 days from the date of shipment;</li><li>Pumps are warranted for hours of operation as set forth in product or operator's manuals;</li><li>Parts repaired or replaced as a result of repair services are warranted to be free from defects in workmanship and material, under normal use, for 90 days from the date of shipment;</li><li>Seller does not provide any warranty on finished goods manufactured by others or on any fuses, batteries or other consumable materials. Only the original manufacturer's warranty applies;</li><li>This warranty does not cover calibration requirements, and seller warrants only that the instrument or product is properly calibrated at the time of its manufacture. Instruments returned for calibration are not covered by this warranty;</li><li>This warranty is <b>VOID</b> if the instrument is opened by anyone other than a factory authorized service center with the one exception where requirements set forth in the manual allow an operator to replace consumables or perform recommended cleaning;</li><li>This warranty is <b>VOID</b> if the product has been misused, neglected, subjected to accidental or intentional damage, or is not properly installed, maintained, or cleaned according to the requirements of the manual. Unless specifically authorized in a separate writing by Seller, Seller makes no warranty with respect to, and shall have no liability in connection with, goods which are incorporated into other products or equipment, or which are modified by any person other than Seller.</li></ol> <p>The foregoing is <b>IN LIEU OF</b> all other warranties and is subject to the <b>LIMITATIONS</b> stated herein. <b>NO OTHER EXPRESS OR IMPLIED WARRANTY OF FITNESS FOR PARTICULAR PURPOSE OR MERCHANTABILITY IS MADE. WITH RESPECT TO SELLER'S BREACH OF THE IMPLIED WARRANTY AGAINST INFRINGEMENT, SAID WARRANTY IS LIMITED TO CLAIMS OF DIRECT INFRINGEMENT AND EXCLUDES CLAIMS OF CONTRIBUTORY OR INDUCED INFRINGEMENTS. BUYER'S EXCLUSIVE REMEDY SHALL BE THE RETURN OF THE PURCHASE PRICE DISCOUNTED FOR REASONABLE WEAR AND TEAR OR AT SELLER'S OPTION REPLACEMENT OF THE GOODS WITH NON-INFRINGING GOODS.</b></p> <p>TO THE EXTENT PERMITTED BY LAW, THE EXCLUSIVE REMEDY OF THE USER OR BUYER, AND THE LIMIT OF SELLER'S LIABILITY FOR ANY AND ALL LOSSES, INJURIES, OR DAMAGES CONCERNING THE GOODS (INCLUDING CLAIMS BASED ON CONTRACT, NEGLIGENCE, TORT, STRICT LIABILITY OR OTHERWISE) SHALL BE THE RETURN OF GOODS TO SELLER AND THE REFUND OF THE PURCHASE PRICE, OR, AT THE OPTION OF SELLER, THE REPAIR OR REPLACEMENT OF THE GOODS. IN THE CASE OF SOFTWARE, SELLER WILL REPAIR OR REPLACE DEFECTIVE SOFTWARE OR IF UNABLE TO DO SO, WILL REFUND THE PURCHASE PRICE OF THE SOFTWARE. IN NO EVENT SHALL SELLER BE LIABLE FOR LOST PROFITS, BUSINESS INTERRUPTION, OR ANY SPECIAL, INDIRECT, CONSEQUENTIAL OR INCIDENTAL DAMAGES. SELLER SHALL NOT BE RESPONSIBLE FOR INSTALLATION, DISMANTLING OR REINSTALLATION COSTS OR CHARGES. No Action, regardless of form, may be brought against Seller more than 12 months after a cause of action has accrued. The goods returned under warranty to Seller's factory shall be at Buyer's risk of loss, and will be returned, if at all, at Seller's risk of loss.</p>

Buyer and all users are deemed to have accepted this LIMITATION OF WARRANTY AND LIABILITY, which contains the complete and exclusive limited warranty of Seller. This LIMITATION OF WARRANTY AND LIABILITY may not be amended, modified or its terms waived, except by writing signed by an Officer of Seller.

**Service Policy**

Knowing that inoperative or defective instruments are as detrimental to TSI as they are to our customers, our service policy is designed to give prompt attention to any problems. If any malfunction is discovered, please contact your nearest sales office or representative, or call TSI's Customer Service department at 1-800-874-2811 (USA) or +001 (651) 490-2811 (International).

**Trademarks**

AeroTrak and TrakPro are trademarks of TSI Incorporated. TSI and the TSI logo are registered trademarks of TSI Incorporated. Microsoft and Excel are registered trademarks of Microsoft Corporation.

# Contents

<b>Manual History</b> .....	<b>ii</b>
<b>Warranty</b> .....	<b>iii</b>
<b>Contents</b> .....	<b>v</b>
<b>Safety Information</b> .....	<b>vii</b>
Laser Safety .....	vii
Labels .....	viii
Description of Caution/Warning Symbols .....	ix
Caution .....	ix
Warning .....	ix
Caution or Warning Symbols .....	ix
Getting Help .....	x
<b>CHAPTER 1 Introduction and Unpacking</b> .....	<b>1-1</b>
Unpacking the AeroTrak Handheld Airborne Particle Counter .....	1-1
Optional Accessories .....	1-3
<b>CHAPTER 2 Getting Started</b> .....	<b>2-1</b>
Installing the Isokinetic Inlet .....	2-1
Providing Power .....	2-2
Installing the Battery .....	2-2
To Use AC Power .....	2-3
Quick Start .....	2-4
<b>CHAPTER 3 Operation</b> .....	<b>3-1</b>
Warm-up Time .....	3-2
Main Menu and Basic Operation .....	3-3
Main Menu .....	3-3
Basic Operation .....	3-4
Settings Menu .....	3-6
Sample Menu .....	3-7
Buffer Menu .....	3-8
Utility Menu .....	3-9
<b>CHAPTER 4 Data Handling</b> .....	<b>4-1</b>
USB Computer Communication .....	4-1
Installing Software .....	4-1
<b>CHAPTER 5 Maintenance</b> .....	<b>5-1</b>
Maintenance Schedule .....	5-1
Zero Check .....	5-1
Cleaning the Instrument Enclosure .....	5-1
<b>CHAPTER 6 Troubleshooting</b> .....	<b>6-1</b>

<b>CHAPTER 7 Contacting Customer Service.....</b>	<b>7-1</b>
Technical Contacts.....	7-1
International Contacts.....	7-1
Returning the AeroTrak Handheld Airborne Particle Counter for Service.....	7-3
<b>APPENDIX A Specifications .....</b>	<b>A-1</b>
Compliance .....	A-2
Dimensional Diagram.....	A-3
<b>Index</b>	



# Safety Information

This section gives instructions to promote safe and proper handling of the AeroTrak® Handheld Airborne Particle Counters.

## IMPORTANT

There are no user-serviceable parts inside the instrument. Refer all repair and maintenance to a qualified factory-authorized technician. All maintenance and repair information in this manual is included for use by a qualified factory-authorized technician.

---

## Laser Safety

- The Model 9303 Handheld Airborne Particle Counter is a Class I laser-based instrument.
- During normal operation, you will **not** be exposed to laser radiation.
- Precaution should be taken to avoid exposure to hazardous radiation in the form of intense, focused, invisible light.
- Exposure to this light may cause blindness.

Take these precautions:

- **DO NOT** remove any parts from the particle counter unless you are specifically told to do so in this manual.
- **DO NOT** remove the housing or covers. There are no user-serviceable components inside the housing.





## WARNING

The use of controls, adjustments, or procedures other than those specified in this manual may result in exposure to hazardous optical radiation.

# Labels

Advisory labels and identification labels are attached to the outside of the particle counter housing and to the optics housing on the inside of the instrument.

<p>1. Serial number label (back panel)</p>	 <p><b>AeroTrak APC 9303 – 01</b> Channels: 0.3/0.5/5um, 0.1CFM COMPLIES WITH 21 CFR 1040.10 AND 1040.11</p> <p>Manufactured : February 2011</p> <p>93031107005</p> <p>9V 2A TSI Incorporated www.tsi.com 500 Cardigan Road Shoreview, MN 55126, USA Made in USA</p>
<p>2. Laser radiation label (internal)</p>	<p><b>DANGER!</b> INVISIBLE LASER RADIATION WHEN OPEN. AVOID DIRECT EXPOSURE TO BEAM WARNING: NO USER SERVICABLE PARTS INSIDE. REFER SERVICING TO QUALIFIED PERSONNEL</p>
<p>3. Laser radiation symbol label (internal)</p>	
<p>4. European symbol for non- disposable item. Item must be recycled.</p>	

# Description of Caution/Warning Symbols

Appropriate caution/warning statements are used throughout the manual and on the instrument that require you to take cautionary measures when working with the instrument.

## Caution



C a u t i o n
Failure to follow the procedures prescribed in this manual might result in irreparable equipment damage. Important information about the operation and maintenance of this instrument is included in this manual.





## Warning



W A R N I N G
Warning means that unsafe use of the instrument could result in serious injury to you or cause damage to the instrument. Follow the procedures prescribed.

## Caution or Warning Symbols

The following symbols may accompany cautions and warnings to indicate the nature and consequences of hazards:

	Warns that uninsulated voltage within the instrument may have sufficient magnitude to cause electric shock. Therefore, it is dangerous to make contact with any part inside the instrument.
	Warns that the instrument contains a laser and that important information about its safe operation and maintenance is included in the manual.
	Warns that the instrument is susceptible to electro-static dissipation (ESD) and ESD protection procedures should be followed to avoid damage.
	Indicates the connector is connected to earth ground and cabinet ground.

---

# Getting Help

To obtain assistance with this product or to submit suggestions, please contact Customer Service:

TSI Incorporated  
500 Cardigan Road  
Shoreview, MN 55126 U.S.A.  
Fax: (651) 490-3824 (USA)  
Fax: 001 651 490 3824 (International)  
Telephone: 1-800-874-2811 (USA) or (651) 490-2811  
International: 001 651 490-2811

E-mail Address: [answers@tsi.com](mailto:answers@tsi.com)

Web site: [www.tsi.com](http://www.tsi.com)

## CHAPTER 1

# Introduction and Unpacking

The AeroTrak® Model 9303 Handheld Airborne Particle Counter (particle counter) is a lightweight, handheld particle counter with a backlit LCD display. It operates on the included lithium-ion battery or AC power.

This model has a 0.1 CFM (2.83 L/min) flow rate and counts in user-adjustable bin sizes of 0.3, 0.5/1.0/2.0/2.5, and 5 microns (center channel is selectable). Up to 1500 data sets can be stored and downloaded for analysis and reporting using the TrakPro™ Lite utility included with the device.







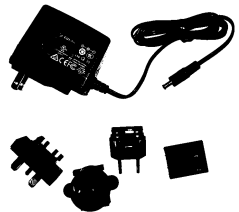

---

## Unpacking the AeroTrak Handheld Airborne Particle Counter

Carefully unpack the AeroTrak Airborne Particle Counter from the shipping container and verify that all the items shown in the photos below and listed in the following tables are present. Contact TSI immediately if items are missing or broken.

### Model 9303 AeroTrak Airborne Particle Counter Parts List

Qty.	Item Description	Part/Model	Reference Picture
1	AeroTrak Airborne Particle Counter	9303-01	

Qty.	Item Description	Part/Model	Reference Picture
1	AC power adapter and country-specific plugs	700021	
1	Isokinetic inlet	700003	
1	Battery Pack	700019	
1	Computer cable, USB A to mini-B	700036	
1	HEPA zero filter	700005	
1	TrakPro™ Lite Secure Software CD for 21 CFR Part 11 compliant data downloading (includes manuals)	7001901	
1	Operation and Service Manual	6002277	<i>Included on TrakPro Lite Secure Software CD</i>
1	Quick Start Guide	6002238	
1	Calibration Certificate	N/A	

## Optional Accessories

The following photo and table list optional accessories. If you ordered optional accessories, make certain they have been received and are in working order.

Item Description	Part/Model	Ref.
Stainless Steel Isokinetic inlet	700004	
Isokinetic probe (used with tubing)	700001 AL 700002 SS	
0.1 cfm Barb Inlet Fitting	700020	
Tubing, Superthane 1/8-inch ID x 1/4-inch OD, Clear 100 Ft Box	700009	
Light Duty Carry Case	700115	

*(This page intentionally left blank)*



## CHAPTER 2

# Getting Started

This chapter provides information to help you use the Model 9303 including:

- [Installing the Isokinetic Inlet](#)
- [Providing Power](#)
- [Quick Start](#)

---

## Installing the Isokinetic Inlet

The Isokinetic Inlet smoothly accelerates air into the inlet of the instrument. To install, simply screw the probe directly onto the threaded inlet nozzle.



**Installing an Isokinetic Inlet**

---

# Providing Power

The Model 9303 may be powered using its internal rechargeable lithium-ion battery or through an AC power cord.

### Notes:

- When using AC power, the battery is charging when the red LED next to the power connector is on.
- Removing/changing the lithium-ion battery or disconnecting AC power does not cause the loss of data.
- You should fully charge the battery before use.



### WARNING

The battery supplied by TSI (700019) has built in protection against explosion and fire hazard. Do **not** use a substitute.



### WARNING

Do **not** use non-rechargeable batteries in this instrument. Fire, explosions, or other hazards may result.

## Installing the Battery

1. The battery is shipped separately and has to be installed before use.
2. Remove the battery cover on the back side of the handle with a small, flat-blade screwdriver.
3. Connect the battery to the socket as shown below.
4. Insert the battery with the connector at the top and replace the battery cover. Make sure all wires are inside and not pinched in the cover. Do **not** over-tighten the screw.
5. Fully charge the battery before use.



## To Use AC Power

1. Remove the AC transformer parts from their package and identify the appropriate plug for your needs. Plugs are available for all common countries.

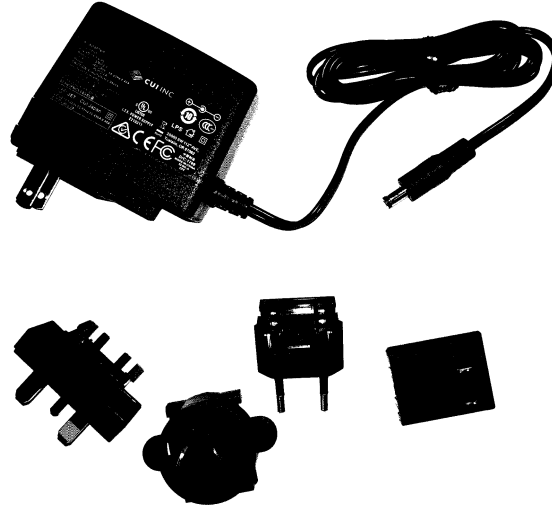

2. Remove the insert from transformer using the slide lock and tilt the insert out.



3. Tilt the appropriate plug into the transformer receptacle.



4. Make sure it locks into place.

5. Plug the DC end of the transformer cord into the counter.
6. Plug the AC end of the transformer cord into an AC outlet.
7. The Power LED lights when the battery is charging. When the Power LED is off, the battery is fully charged.
8. When the battery is charged, unplug the power supply.

---

## Quick Start

The best way to quickly get started is to refer to the printed “Quick Start Guide” included with your instrument. It will help you to quickly set up the instrument and begin sampling. Refer to the sections below for more detailed information on configuring and running the instrument.

# CHAPTER 3

## Operation

The Model 9303 is controlled using the integral keys and the backlit display.



To turn on the instrument, press the **On/Off** key. A splash screen will appear for three seconds, displaying the TSI logo, model number, serial number, and firmware version number (see below).

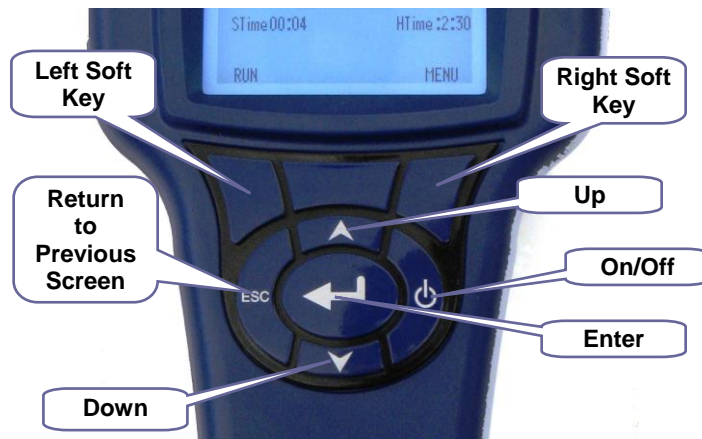

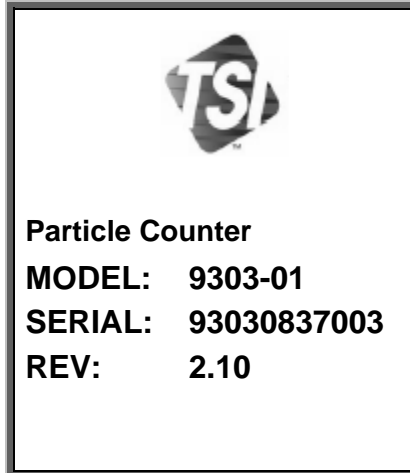

Splash Screen

The instrument is ready for operation when the default screen (shown below) appears.

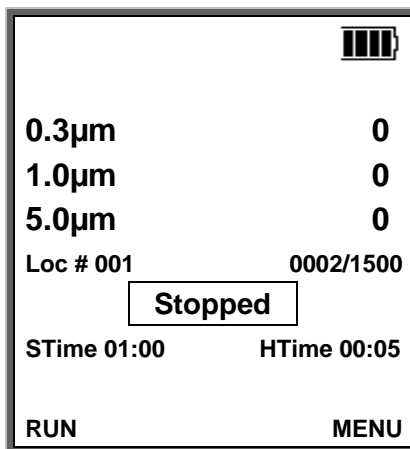

Default Screen

**Note:** To turn off the instrument, press and hold the **On/Off** key for 5 seconds. The instrument turns off.

---

## Warm-up Time

An initial warm-up period of 15 minutes is recommended before sampling with the Model 9303. The warm-up period allows time for the optics to reach a steady-state temperature. This will result in more repeatable results. Neglecting the warm-up time may result in an overestimation of particle size (approximately 10 percent). Neglecting the warm-up time will not have a significant effect on particle concentration; therefore, a zero count can still be performed without waiting for the warm-up period.

---

# Main Menu and Basic Operation

Press **Menu** on the Default Screen to display the Main Menu.

## Main Menu

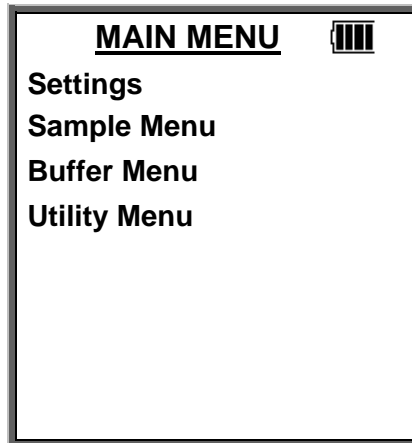

### Main Menu

From the Main Menu you can select other menus:

Menu	Description
Settings	Set language, time and date, time and day format, and screen settings.
Sample	Set sample mode, cycle mode, sample time, hold time, cycle count, sample units, and channel 2 size.
Buffer	View the number of records stored in the Model 9303, display buffer records, and clear the buffer.
Utility	Adjust the pump speed, turn data logging on and off, and select the sampling location.

Each of these menus is described in the remainder of this chapter.

## Basic Operation

This section explains the basic operation for using the keypad and starting sampling.

### Using the Keypad



Use the up and down keys to highlight a menu or a menu option then:

- If left and right arrows (< >) appear at the bottom of the screen, use the left and right soft keys to select the option you want. Generally, there will be only 2 or 3 options. Soft keys change function depending on the display above them. For instance, in the picture above, the left soft key is labeled **RUN** and the right soft key is labeled **MENU**. The center soft key is not currently used.
- If no arrows appear at the bottom, press the **Enter** key to bring up a secondary window from which you can make a selection or modify a setting.

Use the up and down keys to perform operations such as increasing a value. Use the right soft key and left soft keys to move right and left.

The **ESC** key always brings you back to the previous screen.



## Start Sampling

To start sampling, press the **left** soft key (below "RUN"). The Model 9303 begins collecting samples immediately if set to manual mode or according to the parameters you have set for automatic mode.

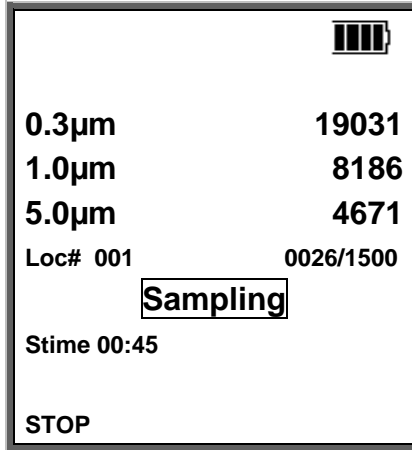

To stop sampling at any time, press the **STOP** soft key.

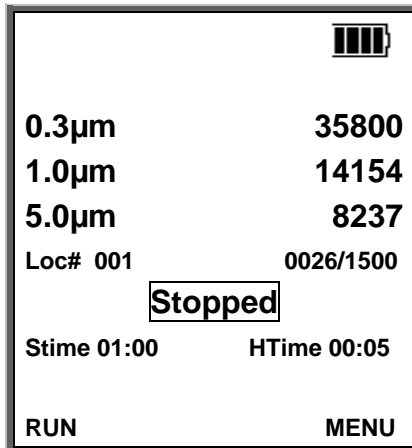

# Settings Menu

The Settings Menu lets you set language (supported in future), current time and date, select the time and day format, and set certain screen settings.

<b>SETTINGS MENU</b>	
<b>Language</b>	<b>English</b>
<b>Set Time</b>	<b>2:41:55 PM</b>
<b>Set Date</b>	<b>09/12/08</b>
<b>Time Format</b>	<b>12 hr</b>
<b>Date Format</b>	<b>MMDDYY</b>
<b>Backlight</b>	<b>On</b>
<	>

**Settings Menu**

The following table describes the options of this menu and the parameters you can set.

<b>Option</b>	<b>Description</b>	<b>Parameters</b>
Language	Use < and > to set the language in which information is displayed.	English (other languages may be offered)
Set Time	Press the <b>Enter</b> key to go to a secondary screen where you can set the current time.	Hours, minutes, seconds
Set Date	Press the <b>Enter</b> key to go to a secondary screen where you can set the current date.	Day, month, year
Time Format	Use < and > to set the time format in which time is displayed (and saved in the sample records).	12 hr; 24 hr
Date Formats	Use < and > to set the date format in which the date is displayed (and saved in the sample records).	DD/MM/YY; MM/DD/YY
Backlight	Use < and > to set whether the backlight on the display is on or off.  Note that battery life is approximately 15% less with the backlight enabled.	On – backlight is always on Off – backlight is always off

# Sample Menu

The Sample Menu sets sample mode, cycle mode, sample time, hold time, cycle count, sample units, and channel 2 size.

<b>SAMPLE MENU</b>	
<b>Sample Mode</b>	<b>COUNTS</b>
<b>Cycle Mode</b>	<b>AUTO</b>
<b>Sample Time</b>	<b>01:00</b>
<b>Hold Time</b>	<b>00:30</b>
<b>Cycle Count</b>	<b>010</b>
<b>Sample Units</b>	<b>LITER</b>
<b>Chan 2 Size</b>	<b>0.5µm</b>
<	>

**Sample Menu**

The following table describes the options of this menu and the parameters you can set.

<b>Option</b>	<b>Description</b>	<b>Parameters</b>
Sample Mode	Use < and > to set the sampling mode.	Concentration (see note below); counts
Cycle Mode	Use < and > to set the sampling mode.	<b>Manual</b> – the counter will start when the RUN soft key is pressed and stop only when the STOP soft key is pressed. <b>Auto</b> – the counter will start when the RUN soft key is pressed and turn on and off automatically to follow the sample time, hold time and cycle count parameters below.
Sample Time	Press the <b>Enter</b> key to go to a secondary screen where you can set the sample time.	Minutes and seconds up to 99:59 (see note below)
Hold Time	Press the <b>Enter</b> key to go to a secondary screen where you can set the time between samples.	Minutes and seconds up to 99:59
Cycle Count	Press the <b>Enter</b> key to go to a secondary screen where you can set the number of samples to take.	1 to 999

Option	Description	Parameters
Sample Units	Use < and > to set the sampling units.	Liter; cubic feet
Channel 2 Size	Use < and > to set the bin size for channel 2. (This is the only channel that can be set to more than one value.)	0.5, 1.0, 2.0, 2.5 $\mu$ m

**Note**

When concentration sample mode is used with short sample times (less than 30 seconds), the concentration may not be accurate due to the poor counting and timing statistics associated with a short sample.

## Buffer Menu

The Buffer Menu lets you view the number of records stored in the Model 9303, display buffer records, and clear the buffer.

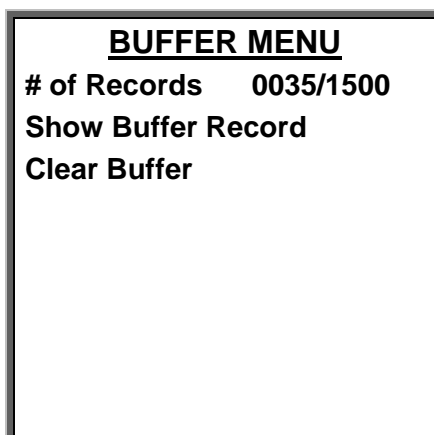

### Buffer Menu

The following table describes the options of this menu and the parameters you can set.

Option	Description	Parameters
# of Records	Shows the number or sample records stored in the Model 9303.	None
Show Buffer Record	Press the <b>Enter</b> key to go to a secondary screen where you can select the record (by sample number) of the record you want to view.	Any record number (up to 1500)
Clear Buffer	Press the <b>Enter</b> key to clear all samples in the buffer. You will be asked to confirm your request.	None

<b>BUFFER RECORD</b>	
<b>Record#:</b>	<b>0313</b>
<b>Date:</b>	<b>12/27/08</b>
<b>Time:</b>	<b>05:50:45</b>
<b>0.3µm</b>	<b>000566473</b>
<b>0.5µm</b>	<b>000534571</b>
<b>5.0µm</b>	<b>000072056</b>
<b>Location:</b>	<b>111</b>
<b>Sample Time:</b>	<b>01:00</b>
<b>Hold Time:</b>	<b>00:00</b>
<b>&lt;</b>	<b>&gt;</b>

**Example of a Buffer Record**

Use the < and > softkeys to scroll through the records, Enter to go back one screen and **ESC** to go back to the Buffer Menu.

**Note**

If the buffer is filled to its capacity of 1500 records, the instrument will continue to count and save records but the next record after 1500 will be saved in record number 1, then 2, etc. This way the most recent 1500 records are always preserved.

---

## Utility Menu

The Utility Menu lets you adjust the pump speed, turn data logging on and off, and select the sampling location.

<b>UTILITY MENU</b>	
<b>Pump Speed</b>	<b>099</b>
<b>Data Logging</b>	<b>ON</b>
<b>Location</b>	<b>120</b>

**Utility Menu**

The following table describes the options of this menu and the parameters you can set.



<b>C a u t i o n</b>	
If you turn Data Logging off, no data will be saved to the buffer.	

Option	Description	Parameters
Pump Speed	Press the <b>Enter</b> key to go to a secondary screen where you can increase or decrease the pump speed. (The pump may slow down with age, or it may be necessary to increase the speed if there are flow restrictions – such as long tubing). Use a flowmeter to check the flow when taking critical measurements, and adjust the pump speed as necessary.	0 to 255
Data Logging	Use < and > to turn data logging on and off.	ON; OFF
Locations	Press the <b>Enter</b> key to go to a secondary screen where you can select a location number.	0 to 250

## CHAPTER 4

# Data Handling

---

## USB Computer Communication



### Mini USB Port

The Model 9303 is equipped with a USB-compatible cable for uploading and downloading information to a PC. The cable plugs into the left side of the instrument as shown above.

---

## Installing Software

Refer to the *TrakPro™ Lite Secure Software User's Guide* (P/N 6004404) on CD (P/N 7001901) for installation instructions.

*(This page intentionally left blank)*



# CHAPTER 5

## Maintenance

### Note

There are no user-serviceable parts inside this instrument. Opening the instrument case may void the warranty. TSI recommends that you return the AeroTrak Airborne Particle Counter to the factory for any required maintenance or service not described in this manual.

---

## Maintenance Schedule

TSI recommends annual factory cleaning and calibration for the AeroTrak Airborne Particle Counter. See [Chapter 7, "Contacting Customer Service"](#) for service/calibration.

### Recommended Field Maintenance Schedule

Item	Frequency
Zero check	Daily (or as defined by application).
Factory cleaning and calibration	Annually.
Cleaning the instrument enclosure	As needed.

---

## Zero Check

The zero check ensures that the instrument is properly assembled and free from leaks, residual particles and electronic noise.

---

## Cleaning the Instrument Enclosure

To clean the enclosure, dampen a lint-free cloth and gently wipe the surface until surface contamination is removed.

*(This page intentionally left blank)*

## CHAPTER 6

# Troubleshooting

Symptom	Possible Cause	Corrective Action
Counts are too low.	<p>Instrument is being operated outside temperature or relative humidity specifications.</p> <p>Internal parts have been damaged because instrument was stored at a temperature greater than 122 °F (50 °C) or shipped with battery installed and turned on causing excessive heat.</p> <p>Instrument has contamination on the optics due to condensation or excessive loading.</p> <p>Laser or pump is damaged.</p> <p>Unit is due for calibration.</p>	<p>Operate instrument within specifications.</p> <p>Return to factory or factory authorized service centers for service.</p> <p>Return to factory or factory authorized service centers for service.</p> <p>Return to factory or factory authorized service centers for service.</p> <p>Return to factory or factory authorized service centers for service.</p>
Instrument does not turn on.	<p>On/off switch is not being pressed properly.</p> <p>Battery is dead.</p> <p>AC cord is not plugged into unit.</p>	<p>Press and hold on/off switch for one second.</p> <p>Recharge battery or connect to AC power.</p> <p>Connect AC cord.</p>

Symptom	Possible Cause	Corrective Action
Instrument does not meet zero count specification (<1 particle/5 min).	<p>HEPA filter is not connected properly and room air is leaking into the HEPA filter assembly.</p> <p>Residual particles from previous samples are shedding off internal parts and into the optics.</p> <p>The filter assembly or inlet are dirty or contaminated with particles.</p> <p>An internal component has been damaged due to operation outside of temperature specifications or one or more excessive bumps or jolts, and electronic noise is inducing false counts.</p> <p>A leak has developed in the aerosol flow path.</p> <p>Internal optics have become dirty.</p>	<p>Check that the HEPA filter has been tightly connected to the inlet. Check that rubber O-ring (black) on the inlet is in place.</p> <p>Purge instrument by running the instrument for 10 to 15 minutes or longer before attempting zero count test.</p> <p>Clean the HEPA filter fitting or run an extended test to clean out particles.</p> <p>Return to factory or factory authorized service centers for service.</p> <p>Return to factory or factory authorized service centers for service.</p> <p>Return to factory or factory authorized service centers for service.</p>
Battery does not charge	The battery may not be installed or is disconnected.	Check battery.
Low Battery Indicator	Low battery.	Recharge battery or connect AC cord
Software doesn't connect to unit	<p>No connection or power.</p> <p>Unit is running a sample or in a sub menu.</p>	<p>Check that USB is connected to instrument and instrument is turned on.</p> <p>Stop sample and make sure screen shows main view.</p>

## CHAPTER 7

# Contacting Customer Service

This chapter gives directions for contacting people at TSI Incorporated for technical information and directions for returning the AeroTrak® Handheld Airborne Particle Counter for service.

---

## Technical Contacts

- If you have any difficulty setting up or operating the AeroTrak Model 9303, or if you have technical or application questions about this system, contact an applications engineer at TSI Incorporated, 1-800-874-2811 (USA) or (651) 490-2811 or e-mail [technical.service@tsi.com](mailto:technical.service@tsi.com).
- If the AeroTrak Model 9303 does not operate properly, or if you are returning the instrument for service, visit our website at <http://rma.tsi.com>, or contact TSI Customer Service at 1-800-874-2811 (USA) or (651) 490-2811.

## International Contacts

### Service

#### **TSI Instruments Singapore Pte Ltd**

150 Kampong Ampat  
#05-05 KA Centre  
Singapore 368324

**Telephone:** +65 6595-6388  
**Fax:** +65 6595-6399  
**E-mail:** [tsi-singapore@tsi.com](mailto:tsi-singapore@tsi.com)

#### **TSI Instrument (Beijing) Co., Ltd.**

Unit 1201, Pan-Pacific Plaza  
No. 12 A, Zhongguancun South Avenue  
Haidian District, Beijing, 100181  
CHINA

**Telephone:** +86-10-8219 7688  
**Fax:** +86-10-8219 7699  
**E-mail:** [tsibeijing@tsi.com](mailto:tsibeijing@tsi.com)

**TSI Instruments Ltd.**

Stirling Road  
Cressex Business Park  
High Wycombe, Bucks  
HP12 3ST  
UNITED KINGDOM

**Telephone:** +44 (0) 149 4 459200

**Fax:** +44 (0) 149 4 459700

**E-mail:** [tsiuk@tsi.com](mailto:tsiuk@tsi.com)

**Technical Support****TSI Instruments Singapore Pte Ltd**

150 Kampong Ampat  
#05-05 KA Centre  
Singapore 368324

**Telephone:** +65 6595-6388

**Fax:** +65 6595-6399

**E-mail:** [tsi-singapore@tsi.com](mailto:tsi-singapore@tsi.com)

**TSI Instrument (Beijing) Co., Ltd.**

Unit 1201, Pan-Pacific Plaza  
No. 12 A, Zhongguancun South Avenue  
Haidian District, Beijing, 100181  
CHINA

**Telephone:** +86-10-8219 7688

**Fax:** +86-10-8219 7699

**E-mail:** [tsibeijing@tsi.com](mailto:tsibeijing@tsi.com)

**TSI GmbH**

Neuköllner Strasse 4  
52068 Aachen  
GERMANY

**Telephone:** +49 241-52303-0

**Fax:** +49 241-52303-49

**E-mail:** [tsigmbh@tsi.com](mailto:tsigmbh@tsi.com)

**TSI Instruments Ltd.**

Stirling Road  
Cressex Business Park  
High Wycombe, Bucks  
HP12 3ST  
UNITED KINGDOM

**Telephone:** +44 (0) 149 4 459200

**Fax:** +44 (0) 149 4 459700

**E-mail:** [tsiuk@tsi.com](mailto:tsiuk@tsi.com)

**Web:** [www.tsiinc.co.uk](http://www.tsiinc.co.uk)

**TSI France Inc.**  
Hotel technologique  
BP 100  
Technopôle de Château-Gombert  
13382 Marseille cedex 13  
FRANCE

**Telephone:** + 33 (0)1 41 19 21 99  
**Fax:** + 33 (0)1 41 19 21 96  
**E-mail:** [tsifrance@tsi.com](mailto:tsifrance@tsi.com)  
**Web:** [www.tsiinc.fr](http://www.tsiinc.fr)

---

## Returning the AeroTrak Handheld Airborne Particle Counter for Service

Visit our website at <http://rma.tsi.com> or call TSI at 1-800-874-2811 (USA) or (651) 490-2811 for specific return instructions. Customer Service will need this information when you call:

- The instrument model number
- The instrument serial number
- A purchase order number (unless under warranty)
- A billing address
- A shipping address

Use the original packing material to return the instrument to TSI. If you no longer have the original packing material, seal off any ports to prevent debris from entering the instrument and ensure that the display and the connectors on the instrument front and back panels are protected.

*(This page intentionally left blank)*



# APPENDIX A

## Specifications

All specifications meet or exceed JIS B9921. They are subject to change without notice.

Size Range	0.3 to 25 µm
Channel Sizes	0.3 µm and 5.0 µm fixed; 0.5, 1.0, 2.0, or 2.5 µm selectable middle channel.
Counting Efficiency	50% at 0.3 µm; 100% for particles > 0.45 µm (per ISO 21501-4 and JIS)
Concentration Limits	2,000,000 particles/ft <sup>3</sup> at 5% coincidence loss
Light Source	Long life laser diode
Zero Count Level	<1 count / 5 minutes (per ISO 21501-4 and JIS B9921)
Flow Rate	0.1 CFM (2.83 L/min)
Calibration	NIST traceable with TSI calibration system
Sample Probe/Tubing	Isokinetic sampling probe
Sampling Modes	Manual and automatic
Sampling Time	1 second to 99 minutes 59 seconds
Sampling Frequency	1 to 999 cycles or continuous
Exhaust	Internal HEPA filter
Vacuum Source	Internal pump
Communication Mode	USB serial output
Data Storage	1,500 sample records
Status Indicators	Low battery and service
Display	3.2-in. (8.1 cm) 160 x 160 monochrome LCD
External Surface	High impact injection molded plastic
AC Power (power to AC adapter)	110 to 240 VAC 50-60 Hz Universal in-line power supply with country specific plugs
DC Power (power to instrument)	9 VDC @ 1.5 A
Battery	Rechargeable Li-Ion
Battery Life	Up to 4.5 hours of continuous use
Recharge Time	< 3 hours
Dimensions (L x W x H)	9.1 x 6.3 x 2.4 in. (23 x 11 x 6.2 cm) (without isokinetic inlet)

Weight	1.3 lbs (0.58 kg) with battery
Standards	CE, JIS B9921, ISO 21501-4
Warranty	1 year (extended warranties available)
Operating Conditions	41° to 95°F (5° to 35°C) temperature and 20% to 95% non-condensing relative humidity
Storage Conditions	32° to 122°F (0° to 50°C) temperature and up to 98% non-condensing relative humidity
Included Accessories	Operating manual on CD, power supply, battery, isokinetic inlet, purge filter, USB cable and TrakPro™ Lite data download software
Optional Accessories	Spare battery, isokinetic probe, sample tubing and carrying case

---

## Compliance

CE Marking	EN61326 / EN 55011, Class BA: Radiated Emissions EN61326 / EN 55011, Class BA: Conducted Emissions EN61000-3-2: Harmonics EN61000-3-3: Voltage Fluctuations EN61000-4-2: Electrostatic Discharge Immunity EN61000-4-3: Electromagnetic Field Immunity EN61000-4-4: Burst Immunity EN61000-4-6: Conducted PS Immunity EN61000-4-5: Surge Immunity EN61000-4-8: Rated Power-Frequency Field Immunity EN61000-4-11: Voltage Dips\Short Interruptions Immunity
RoHS Marking	Yes
Laser Safety	Complies with 21 CFR 1040.10 and 1040.11

# Dimensional Diagram

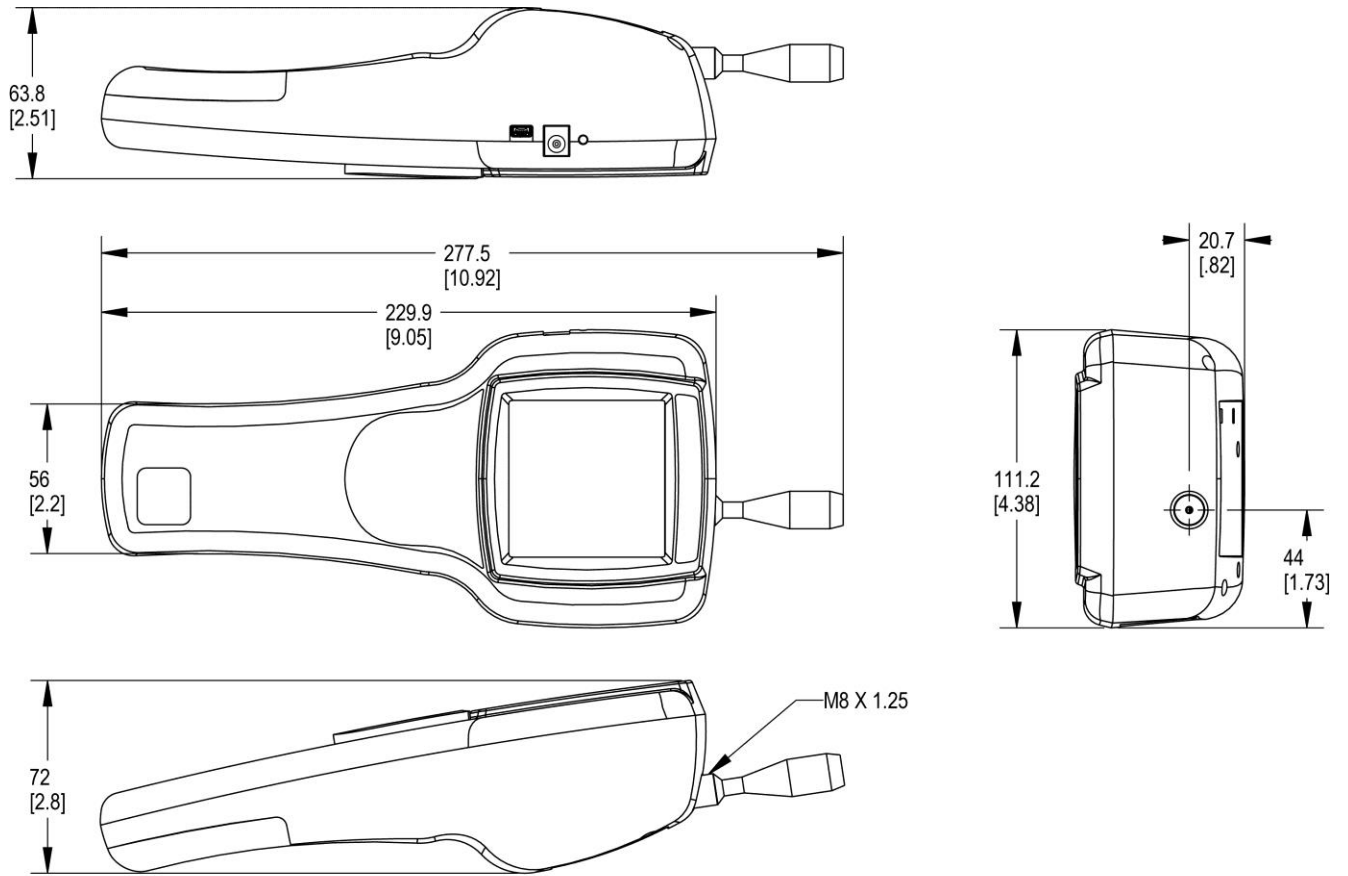

*(This page intentionally left blank)*

# Index

## #

# of records, 3-9

## A

AC power, A-1  
using, 2-3  
AC power adapter, 1-2  
accessories, A-2  
optional, 1-3, A-2

## B

backlight, 3-6  
backlit display, 3-1  
barb inlet fitting, 1-3  
battery, A-1  
indicator low, 6-2  
installation, 2-2  
life, A-1  
not charging, 6-2  
recharge time, A-1  
battery pack, 1-2  
buffer, 3-3  
buffer menu, 3-8  
# of records, 3-9  
clear buffer, 3-9  
show buffer record, 3-9  
buffer record, 3-9

## C

calibration, A-1  
calibration certificate, 1-2  
caution  
description, ix  
symbol, ix  
turning data logging off, 3-10  
CE marking, A-2  
channel 2 size, 3-8  
channel size, A-1  
cleaning instrument enclosure, 5-1  
clear buffer, 3-9  
communication mode, A-1  
compliance, A-2  
computer cable, 1-2  
concentration limits, A-1  
contacting TSI, 7-1  
email address, iii  
counting efficiency, A-1  
counts too low, 6-1  
customer service, 7-1  
cycle count, 3-8  
cycle mode, 3-7

## D

daily zero check, 5-1  
data handling, 4-1  
data logging, 3-10  
data storage, A-1  
date formats, 3-6  
DC adapter socket, 3-1  
DC power, A-1  
default screen, 3-2  
dimensions, A-1, A-3  
display, A-1

## E

ESD protection symbol, ix  
external surface, A-1

## F

factory cleaning, 5-1  
flow rate, A-1

## G

getting help, x  
getting started, 2-1

## H

help, x, 7-1  
HEPA zero filter, 1-2  
hold time, 3-7

## I–J

installation  
battery, 2-2  
isokinetic inlet, 2-1  
software, 4-1  
instrument does not meet zero count  
specification, 6-2  
instrument does not turn on, 6-1  
introduction, 1-1  
isokinetic inlet, 1-2, 3-1  
installation, 2-1  
isokinetic probe, 1-3

## K

key pad, 3-1  
keypad  
using, 3-4

## L

label  
laser radiation, viii  
laser safety, viii  
serial number, viii  
language, 3-6  
laser radiation label, viii  
laser safety, vii, A-2  
laser symbol label, viii  
light duty carry case, 1-3  
light source, A-1  
locations, 3-10

## M–N

main menu, 3-3  
maintenance, 5-1  
cleaning instrument enclosure, 5-1  
daily zero check, 5-1  
factory cleaning, 5-1  
schedule, 5-1  
manual history, ii  
mini USB port, 4-1

## O

operating conditions, A-2  
operation, 3-1  
basic, 3-3, 3-4  
optional accessories, 1-3

## P–Q

packing instructions, 7-3  
parts list, 1-1  
power, 2-2, A-1  
using, 2-3  
power LED, 3-1  
pump speed, 3-10

## R

returning for service, 7-3  
RoHS marking, A-2

## S

safety, vii  
sample, 3-3  
sample menu, 3-7  
channel 2 size, 3-8  
cycle count, 3-8  
cycle mode, 3-7  
hold time, 3-7  
sample mode, 3-7  
sample time, 3-7  
sample units, 3-8

- sample mode, 3-7
- sample output, A-1
- sample probe/tubing, A-1
- sample time, 3-7
- sample units, 3-8
- sampling
  - start, 3-5
  - stop, 3-5
- sampling frequency, A-1
- sampling mode, A-1
- sampling time, A-1
- serial number label, viii
- service
  - returning, 7-3
- set date, 3-6
- set time, 3-6
- settings, 3-3
- settings menu, 3-6
- show buffer record, 3-9
- size range, A-1
- software
  - installation, 4-1
  - troubleshooting, 6-2
- specifications, A-1
- splash screen, 3-2
- stainless steel isokinetic inlet, 1-3
- standards, A-2
- start menu
  - backlight, 3-6
  - date formats, 3-6
  - language, 3-6
  - set date, 3-6
  - set time, 3-6
  - time format, 3-6
- start sampling, 3-5
- status indicators, A-1
- stop sampling, 3-5
- storage conditions, A-2
- superthane tubing, 1-3

## **T**

- technical contacts, 7-1
- time format, 3-6
- troubleshooting, 6-1

## **U**

- unpacking, 1-1
- USB computer communication, 4-1
- USB port, 3-1
- using keypad, 3-4
- utility, 3-3
- utility menu, 3-10
  - data logging, 3-10
  - locations, 3-10
  - pump speed, 3-10

## **V**

- vacuum source, A-1

## **W-X-Y**

- warm-up time, 3-2
- warning
  - description, ix, 2-2
  - symbol, ix
- warranty, iii, A-2
- weight, A-1

## **Z**

- zero check, 5-1
- zero count level, A-1



UNDERSTANDING, ACCELERATED

**TSI Incorporated** – Visit our website [www.tsi.com](http://www.tsi.com) for more information.

<b>USA</b>	<b>Tel:</b> +1 800 874 2811	<b>India</b>	<b>Tel:</b> +91 80 67877200
<b>UK</b>	<b>Tel:</b> +44 149 4 459200	<b>China</b>	<b>Tel:</b> +86 10 8219 7688
<b>France</b>	<b>Tel:</b> +33 1 41 19 21 99	<b>Singapore</b>	<b>Tel:</b> +65 6595 6388
<b>Germany</b>	<b>Tel:</b> +49 241 523030		

P/N 6002277 Rev J

©2017 TSI Incorporated

Printed in U.S.A.

