

Model - TM300-F



"Look for the blue label!"

TM Series Meters are designed for use in water applications. The 3" and 4" models are shown here. Choose Spigot (pipe end), NPT, 150# ANSI Flange Fittings, and DIN Flange Fittings.



For complete part number, see "Meter Number Reference" for this section.

ACCURACY: ±3.0% READING

Features and Benefits:

- ✓ Available in Spigot, NPT, BSPP and Flange fittings.
- ✓ Displays in gallons, litres and cubic feet.
- ✓ Indicates Batch, Cumulative Totals and Rate of Flow.
- ✓ One-piece field replaceable turbine assembly.
- ✓ Spigot models may be cut to length.
- ✓ Meets Schedule 80 specifications.
- ✓ Lithium battery life: 5 years.
- ✓ Non-volatile totals means amounts are retained when batteries are replaced or power is lost.

Applications:

- OEM water treatment equipment / skids
- Cooling towers
- Sub-metering of facility water usage
- Irrigation
- Waste water treatment equipment
- Chemical feed systems

TM SERIES – SPECIFICATIONS

Design Type:	Turbine		
Fitting Size:	3" 4"		
Fitting Type:	Schedule 80 Spigot (Pipe) End, NPT (Female), 150# ANSI Flange or DIN 100 Flange		
Flow Range:			
3" - TM 300:	40 - 400 GPM (151 - 1514 LPM)		
Extended Range:	30 - 600 GPM (131 - 2271 LPM)		
4" - TM400:	60 - 600 GPM (227 - 2271 LPM)		
Extended Range:	40 - 800 GPM (151 - 3028 LPM)		
Accuracy:	± 3.0% of reading		
Pressure Rating:	225 PSI / 15.3 BAR at 73° F (23° C)		
DIN:	135 PSI / 9.1 BAR at 73° F (23° C)		
For CE Applications:	135 PSI / 9.1 BAR at 73° F (23° C)		
Operating Temperature:	+32° F to +140° F (0° to +60° C)		
Typical K-Factor:			
3" - TM 300:	43 PPG / 11 PPL		
4" - TM400:	17 PPG / 4.5 PPL		
Battery Life:	5 Years		
Wetted Materials:			
Housing:	PVC		
Bearings:	PEEK		
Shaft & Thrust Washers:	Stainless Steel		
Rotor & Nose Cone:	Acetal		
Signal Generator:	Ferrite		
Shipping Weight (approx.):	Spigot	NPT	Flange
3" - TM300:	2.4 lbs. (1.09 kg)	3.9 lbs. (1.77 kg)	5.8 lbs. (2.63 kg)
4" - TM400:	3.7 lbs. (1.68 kg)	6.1 lbs. (2.77 kg)	9.2 lbs. (4.17 kg)
Display Features:	Rate of Flow, Batch and Cumulative Totals, Field Calibration available.		
Pulse Output (-P Elec. Choice):	Open Collector (NPN)		
Calibration Report	Comes standard with -P (Pulse out) TM Models. N.I.S.T. – Certification available.		

ELECTRONIC CHOICES

GG, GX, GA or SC: See Electronics Section.

APPROVALS



NPT Model - TM400-N-GX

"Look for the blue label!"

Spigot Model - TM400



NPT Model - TM300-N



TM Meters

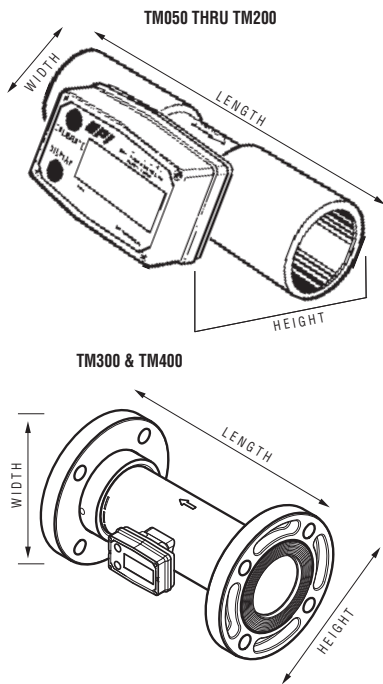

Model	Length* inches (mm)	Height** inches (mm)	Width inches (mm)
TM050	3.8 (96)	2.6 (66)	2.0 (51)
TM050-N	5.8 (147)	2.6 (66)	2.0 (51)
TM075	3.8 (96)	2.7 (68)	2.0 (51)
TM075-N	5.8 (147)	2.7 (68)	2.0 (51)
TM100	4.1 (104)	3.1 (79)	2.0 (51)
TM100-N	6.1 (155)	3.1 (79)	2.0 (51)
TM150	5.4 (137)	3.7 (94)	2.1 (53)
TM150-N	7.4 (188)	3.7 (94)	2.1 (53)
TM200	5.5 (140)	4.2 (107)	2.4 (61)
TM200-N	7.5 (190)	4.2 (107)	2.4 (61)
TM300 (Spigot)	11.5 (292)	5.34 (136)	3.5 (89)
TM400 (Spigot)	13.5 (343)	6.34 (161)	4.5 (114)
TM300 (NPT)	14.7 (373)	5.78 (147)	4.37 (111)
TM400 (NPT)	17.0 (432)	6.76 (172)	5.34 (136)
TM300 (Flange)	12.0 (305)	7.5 (190)	7.5 (190)
TM400 (Flange)	14.0 (356)	9.0 (229)	9.0 (229)

* Length guidelines are estimates; actual length can vary up to $\pm 1/2"$.



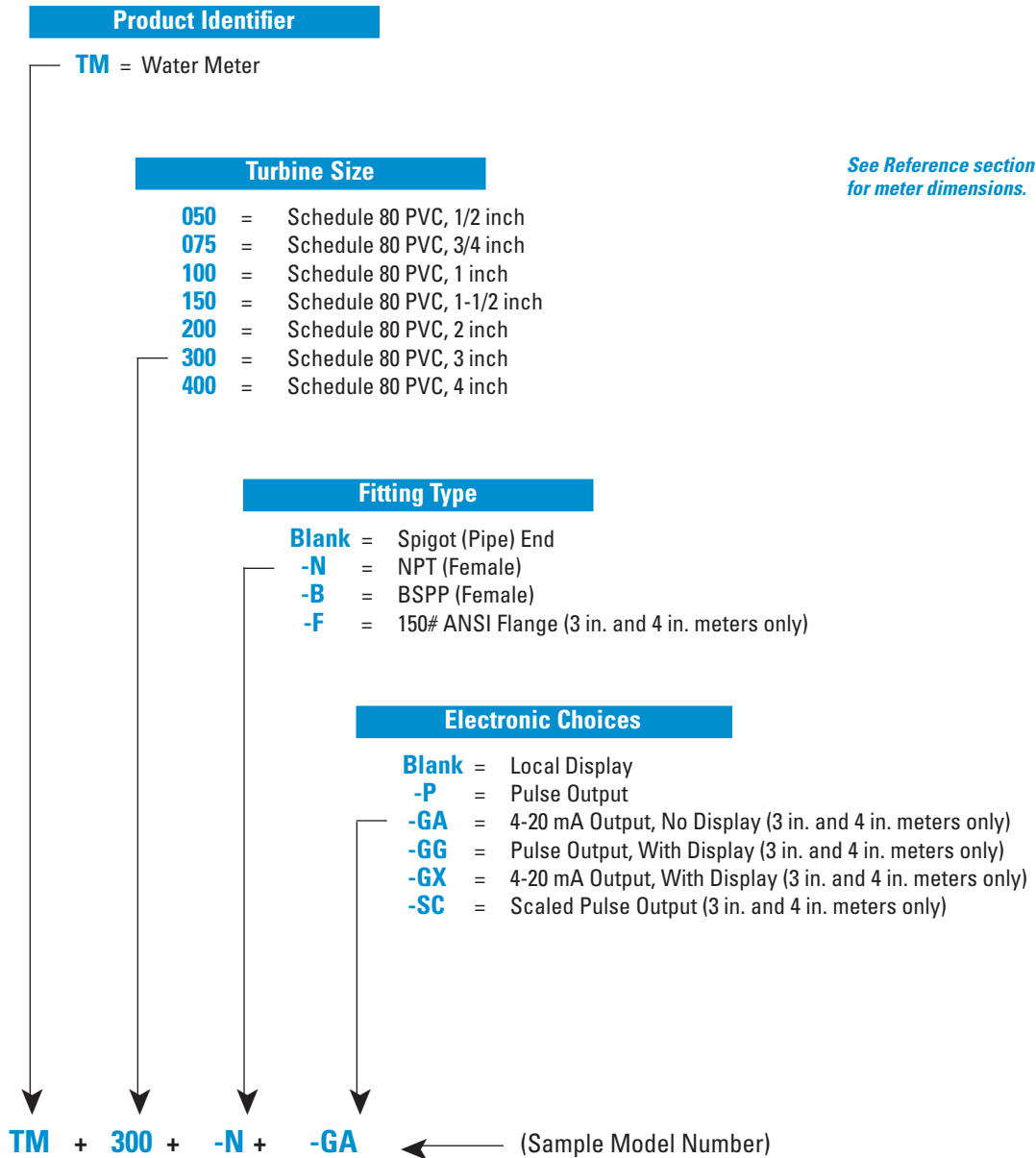





** Computer display adds 1.1 in. (28 mm) to height.



At Great Plains Industries, we've been building rugged, reliable, liquid flowmeters for over 35 years. The GPI Industrial Meter family includes a full line of Precision and Industrial Turbine meters plus Oval Gear meters in various materials, sizes and fitting options.

We design products to meet the needs of our customers. This includes maintaining appropriate, industry standard approvals. Approvals vary by product line and may be dependent on meter application.

The Approval symbol is listed under product specifications on individual product pages. If no approval mark is found, check the chart to the right. For details about specific "Approvals" refer to the chart.

<p>3-A</p>	<p>3-A Sanitary Standards, Inc. "Flowmeters for Milk and Milk Products, Number 28-03" for GSCPS Models and L Option Meters.</p>
<p>ATEX </p>	<p>Ex II 1 G Per 94/9/EC.</p>
<p></p>	<p>Product reviewed for EMC Directive 2004/108/EC. Includes: Euro Norms 61000-6-2 (2005) and 61000-6-3 (2007) on A1 and G2 Series Meters. Note: For Oval Gear Meters, the CE Approval is applied when meter is part of a system.</p>
<p></p>	<p>Factory Mutual Approved Intrinsically Safe for Class I, II, III, Division 1, All Groups. Nonincendive for Class I, II, III, Division 2 Groups A, B, C, D, F, G.</p>
<p></p>	<p>Factory Mutual Approved Class 1, Div. 1, Group D (01A31GM Only)</p>
<p></p>	<p>Factory Mutual Approved Intrinsically safe for Class I & II, Div. 1, Groups A, B, C, D, E, F & G, T6 Ta=-40° C to 60° C hazardous locations, and for use in Class I, Zone 0 as Ex is IIC T6 Ta=-40° C to 60° C.</p>
<p></p>	<p>Federal Communication Commission Industry Canada Approval Class B; digital service, part 15 of FCC Rules.</p>
<p></p>	<p>Ex ia IIC T6 Ta=60° C</p>
<p>IP44/IP54/IP66</p>	<p>Ingress Protection Code IP44 (Greater than 1 mm and splashed water); IP54 (Dust protected and splashed water); IP66 (Dust-tight and heavy seas).</p>
<p>IP/NEMA</p>	<p>Pulse versions of Oval Gear Meters have enclosure ratings that vary from IP54 / NEMA 13 to IP66 / NEMA 16 depending on the application.</p>
<p>NEMA 4</p>	<p>NEMA Requirements: Enclosure constructed for indoor or outdoor use to provide a degree of protection to personnel against incidental contact with the enclosed equipment. Protection against falling dirt, rain, sleet, snow, windblown dust, splashing or hose directed water that will be undamaged by the external formation of ice on the enclosure. <i>GPI products are tested to NEMA requirements.</i></p>
<p></p>	<p>Restriction of Hazardous Substances Directive 2002/95/EC and 2011/65/EU</p>
<p></p>	<p>Indicates that the product was tested and has met the certification requirements for electrical, plumbing and/or mechanical products.</p>