

Operating Instructions

WirelessHART Fieldgate SWG70

Intelligent WirelessHART gateway
with Ethernet and RS-485 interface

WirelessHART

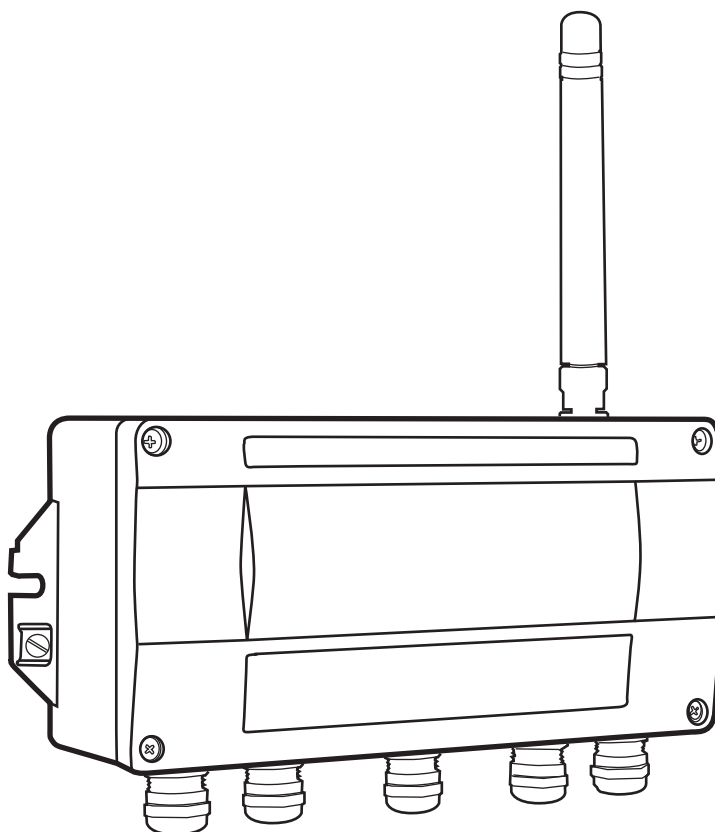

Table of Contents

Table of Contents	3	6	Operation	26
Revision history	5	6.1	Operating and display elements	26
Registered Trademarks	5	6.1.1	LEDs	27
1 Safety	6	6.1.2	Buttons	28
1.1 Designated use	6	6.1.3	DIP switches	29
1.2 Installation, commissioning and operation	6	7	Commissioning	31
1.3 Operational safety	6	7.1	Ethernet connection	31
1.4 IT security	7	7.1.1	Establishing the connection between the host computer and the Fieldgate SWG70 Web server ..	33
1.5 Declaration of Conformity	7	7.2	RS-485 connection	34
1.6 Technical improvement	7	7.3	Creating a FieldCare project	34
1.7 Conventions and icons	8	7.3.1	Adding the HART IP CommDTM	34
2 Identification	9	7.3.2	Adding the Fieldgate SWG70	36
2.1 Unpacking	9	7.3.3	Parameterizing Fieldgate SWG70	37
2.1.1 Visual inspection	9	7.3.4	Scanning for wireless devices in the network	38
2.1.2 Scope of delivery	9	7.3.5	Scanning for devices connected to adapters	39
2.1.3 Storage and transport	9	7.4	User interface	40
2.2 Nameplate	9	8	Fieldgate configuration	42
2.3 Ordering information	10	8.1	Identification	42
3 Function and system design	11	8.2	Wireless Communication	43
3.1 WirelessHART protocol	11	8.2.1	Basic Setup	43
3.2 WirelessHART network	12	8.2.2	Advanced Setup	45
3.2.1 Network management	12	8.2.3	Operating Modes	47
3.2.2 WirelessHART security management ..	12	8.3	Interfaces (wired communication)	48
3.3 Connecting to HART-compatible host systems .	13	8.3.1	Ethernet	48
3.3.1 Instrument list	13	8.3.2	Serial (RS-485)	49
3.3.2 Cache	14	8.4	Protocols (wired communication)	50
4 Installation	15	8.4.1	Modbus via Ethernet or RS-485	50
4.1 Mounting considerations	15	8.4.2	EtherNet/IP via Ethernet	51
4.1.1 Positioning the Fieldgate	15	8.4.3	HART via Ethernet or RS-485	51
4.1.2 Antenna range	16	8.4.4	AMS via Ethernet	52
4.1.3 Examples of good and poor positioning	17	9	Diagnostics	53
4.2 Mounting the antenna	17	9.1	Identification	53
4.2.1 Mounting the antenna supplied	18	9.2	Wireless Communication	54
4.2.2 Connecting a remote antenna	18	9.2.1	Overview	54
4.3 Mounting the Fieldgate	19	9.2.2	Details	55
5 Electrical Installation	20	9.2.3	Burst Lists	56
5.1 Connections and interfaces	20	9.2.4	Topology View (Diagnostics)	57
5.2 Connecting to power supply and grounding ...	21	9.3	Wired Communication	58
5.3 Connecting to Ethernet	22	9.3.1	Overview	58
5.3.1 Connecting the "Modbus" or "Modbus + OPC" versions to Ethernet	22	9.3.2	HART	60
5.3.2 Connecting the "EtherNet/IP" version to Ethernet	23	10	Engineering	62
5.4 Connecting to RS-485	24	10.1	Instrument List	62
5.5 Cable glands and housing cover	25	10.1.1	General	62
		10.1.2	Creating and editing an Instrument List .	63
		10.2	Topology View (Engineering)	65

10.3	Configuring Modbus	68	14	Troubleshooting	114
10.3.1	Modbus Settings	68	14.1	Faults indicated by Fieldgate LEDs	114
10.3.2	Input Status	69	14.2	Wired Communication Faults	114
10.3.3	Input Register	73	14.3	Wireless Communication Faults	115
10.4	Configuring a WirelessHART OPC server	76	14.4	Error messages of the WirelessHART OPC server in the "Event Viewer" window	116
10.4.1	System architecture of an OPC WirelessHART network	77	15	Technical data	117
10.4.2	Configuring the WirelessHART OPC server with "WirelessHART Fieldgate OPC Configurator"	78	16	Modbus Interface	118
10.4.3	Description of the WirelessHART Fieldgate OPC Configurator	81	16.1	Introduction	118
10.4.4	Configuring bursts using the WirelessHART OPC server	84	16.1.1	Modbus protocol	118
10.5	EtherNet/IP configuration	88	16.1.2	Modbus in Fieldgate	119
10.5.1	Setting up an EtherNet/IP connection ..	88	16.1.3	Data types	122
10.5.2	Assigning data exchange connections via HART descriptors	88	16.2	Rules for mapping	123
10.5.3	Burst commands for cyclic data exchange	89	16.2.1	Automatic mapping of analog devices (HART CMD 3)	123
10.5.4	Integrating SWG70 into a PLC via EtherNet/IP	90	16.2.2	Digital input/output devices	124
10.5.5	Cyclic data exchange via the ControlLogix® controller system	90	16.3	Mapping formats	125
10.5.6	Connection parameters for cyclic data exchange	95	16.3.1	Dynamic process variables	125
10.5.7	Diagnostic bits in cyclic data exchange .	98	16.3.2	Status mapping	125
10.6	Downstream Communication (for discreet field devices)	99	16.3.3	HART CMD48 Read Additional Status Information ..	126
10.7	Substitution value (substitution value to DCS)	100	16.3.4	Read Digital Inputs	127
10.7.1	Burst message monitoring	101	17	CSV file formats	128
10.7.2	Factory Acceptance Test (FAT)	103	17.1	Structure of the CSV files	128
10.8	Security – Whitelist, Temporary Join Key	103	17.2	Modbus Mapping CSV files	128
11	Additional Functions	106	17.3	Instrument List CSV files	129
11.1	Reset	106	17.4	Topology View CSV file	129
11.2	Self Test	107	17.5	Details	130
11.3	Firmware Upgrade (Web Server)	107	18	Table Device Variable Classification and Unit Code	131
11.4	Change Password (Web Server)	108	Index	139	
11.5	Set DTM Addresses (DTM)	108			
11.6	Set Device Addresses (DTM)	109			
11.7	Upload Certificate (Web server)	110			
11.7.1	Self-signed security certificate	110			
11.7.2	Trusted security certificate	110			
11.8	Auto Refresh	111			
12	Measurement	112			
13	Maintenance and repair	113			
13.1	Maintenance	113			
13.2	Return to Endress+Hauser.	113			
13.3	Disposal	113			
13.4	Contact addresses	113			
13.5	Accessories and spare parts	113			

Revision history

Order code	Product version	Manual	Changes	Remarks
SWG70-xx-1	1.00.xx	BA064S/04/en/06.10	-	First version of Operating Instructions
SWG70-xx-1	1.01.xx	BA00064S/04/en/13.13	New Functions	<ul style="list-style-type: none"> ■ Navigation changed, Chapter 7.6 ■ Channel Blacklisting possible, Chapter 8.2.2 ■ Topology with signal strength, Chapter 9.2.4 and 10.3 ■ Network tables revised, e.g. Chapter 8.2.3
			Manual Restructuring	<ul style="list-style-type: none"> ■ Chapter 8 Fieldgate configuration => Chapters 8 to 12 ■ Chapter 10 Modbus => Appendix A ■ Chapter 9 HART OPC Server => Appendix B
SWG70-xx-1	2.00.xx	BA00064S/04/en/14.14	Description of the WirelessHART Fieldgate OPC Configurator and burst configuration	<ul style="list-style-type: none"> ■ New Chapter 1.4 "IT security" ■ New Chapter 11 "WirelessHART Fieldgate OPC Configurator" ■ Deleted Appendix C "HART OPC Connection"
SWG70-xx-2	2.00.xx			
SWG70-xx-1	2.03.xx	BA00064S/04/en/15.15	New Functions Manual Restructuring	<ul style="list-style-type: none"> ■ EtherNet/IP amended ■ Technical data moved to Technical Information for "WirelessHART-Fieldgate SWG70" (TI00027S)
SWG70-xx-2	2.03.xx			
SWG70-xx-3	1.01.xx			
SWG70-xx-3	1.00.xx	BA00064S/04/en/16.16	Correction of product version with order code SWG70-xx-3 from 1.01.xx to 1.00.xx	<ul style="list-style-type: none"> ■ Editorial changes, removal of all references to "CD-Rom"
SWG70-xx-1	3.00.xx	BA00064S/04/en/17.18	New functions The new functions are not included in version SWG70-xx-3.	<ul style="list-style-type: none"> ■ Notice in Chapter 1.1 added ■ Chapter 7.1.1 edited ■ Chapter 8.2.1 edited ■ New chapters 10.6, 10.7, 10.8 ■ Chapter 11.4 edited ■ New Chapter 11.9
SWG70-xx-2	3.00.xx			

Registered Trademarks

HART[®] and WirelessHART[®]

Registered trademarks of the HART Communication Foundation, Austin/Texas, USA

Microsoft[®] and Windows[®]

Registered trademarks of the Microsoft Corporation.

PC Easy Connect Suite[®]

Registered trademark of Softing AG

ControlLogix[®]

Registered trademark of Rockwell Automation

MatrikonOPC Tunneller[™]

Registered trademark of MatrikonOPC

All other brand and product names are trademarks or registered trademarks of the companies and organizations in question.

1 Safety

1.1 Designated use

Fieldgate SWG70 serves as a gateway for WirelessHART networks. It enables WirelessHART devices to communicate with each other and manages security and connectivity. The Fieldgate converts wireless device data to a format that is compatible with host systems.

NOTICE**NOTICE!**

- The WirelessHART protocol may not be used to replace the wiring in the case of safety applications with a control function.

1.2 Installation, commissioning and operation

The WirelessHART Fieldgate can be operated safely in compliance with the current guidelines for technical safety and the latest EU directives. Wireless field devices and adapters connected to the WirelessHART Fieldgate must also be operated in accordance with the current guidelines for technical safety and the latest EU directives.

If the WirelessHART Fieldgate is installed incorrectly or used in applications for which it is not intended, it is possible that dangers may arise.

Installation, connection to the electricity supply, commissioning, operation and maintenance of the WirelessHART Fieldgate may only be carried out by trained, qualified technical specialists authorized to perform such work by the facility's owner-operator. The specialist staff must have read and understood these Operating Instructions and must follow the instructions they contain. It is not permitted to modify or repair the devices in any way.

NOTICE**NOTICE!**

- Changes or modifications to the Fieldgate not expressly approved by Endress+Hauser will void the user's authority to operate the equipment.

1.3 Operational safety

Location

Fieldgate SWG70 fulfills the requirements of EU Guidelines for a number of applications. The associated environmental conditions must be upheld. See the Technical Information document for "WirelessHART Fieldgate SWG70" (TI00027S).

The device must not be installed at locations where corrosive vapors may be present.

Hazardous areas

Fieldgate SWG70 is available in a version that can be mounted in an explosion hazardous area. In order to ensure the necessary degree of protection:

- All seals must be undamaged and have been correctly fitted.
- All screws of the housing/housing cover must have been tightened with the appropriate torque.
- Only cable of the appropriate size must be used in the cable glands.
- All cable glands must have been tightened with the appropriate torque, see (Chapter 5.5).
- All empty cable glands must have been sealed with sealing plugs.

When installing components in explosion hazardous areas:

- Ensure that all installation and maintenance personnel are suitably qualified.
- Check that all equipment has the appropriate safety certificates.
- Observe the specifications in the device certificates as well as national and local regulations.

Coexistence of wireless technologies

WirelessHART networks use the frequency spectrum between 2400 ... 2483.5 MHz according to IEEE 802.15.4. Various other wireless technologies also use this frequency spectrum, for example WLAN and Bluetooth. Depending upon the situation, it is possible that these different wireless technologies will affect each other.

When wireless technologies are used in an industrial environment, they must coexist without interfering with each other. If you find that systems are interfering with each other, take appropriate measures to ensure the operation of all wireless systems, e.g. by reconfiguring, enforcing a wireless compatibility policy, etc.

Operation



CAUTION!

Maintain a minimum distance of 20 cm between the device antenna and the body of the user and all persons in the vicinity at all times and for all applications and uses.

1.4 IT security

The Fieldgate SWG70 is equipped with security mechanisms to protect it against any inadvertent changes to the device settings. Additional IT security measures in line with operators' security standards and designed to provide additional protection for the device and device data transfer must be implemented by the operators themselves.

The Fieldgate offers the following functions that increase IT security:

- WirelessHART security management (See Chapter 3.2.2 "WirelessHART security management" on page 12 and see Chapter 8.2.1 "Basic Setup" on page 43.)
- Password for Web server (See Chapter 11.4 "Change Password (Web Server)" on page 108.)
- Security certificate for Web server (See Chapter 11.7 "Upload Certificate (Web server)" on page 110.)

See the Technical Information document "WirelessHART Fieldgate SWG70" (TI00027S) for system-specific firewall configurations such as TCP/IP ports and services.

1.5 Declaration of Conformity

All Declarations of Conformity can be found on www.endress.com.

CE Mark

The WirelessHART Fieldgate SWG70 meets the legal requirements of the relevant EC directives. Endress+Hauser confirms successful testing of the WirelessHART Fieldgate SWG70 by affixing to it the CE mark. An EC Declaration of Conformity has been issued for the Ex-versions and non-Ex versions of the device.





1.6 Technical improvement

Endress+Hauser reserves the right to make technical improvements to its software and equipment at any time and without prior notification. Where such improvements have no effect on the operation of the equipment, they are not documented. If the improvements effect operation, a new version of the operating instructions is normally issued.



1.7 Conventions and icons

In order to highlight safety relevant or alternative operating procedures in the manual, the following conventions have been used, each indicated by a corresponding icon in the margin.





Safety conventions

Icon	Meaning
	DANGER! This symbol alerts you to a dangerous situation. Failure to avoid this situation will result in serious or fatal injury.
	WARNING! This symbol alerts you to a dangerous situation. Failure to avoid this situation can result in serious or fatal injury.
	CAUTION! This symbol alerts you to a dangerous situation. Failure to avoid this situation can result in minor or medium injury.
	NOTICE! This symbol contains information on procedures and other facts which do not result in personal injury.

Type of protection

Icon	Meaning
	Device certified for use in explosion hazardous area If the device has this symbol embossed on its name plate it can be installed in an explosion hazardous area in accordance with the specifications in the certificate or in a safe area.
	Explosion hazardous area Symbol used in drawings to indicate explosion hazardous areas. Devices located in and wiring entering areas with the designation "explosion hazardous areas" must conform with the stated type of protection.
	Safe area (non-explosion hazardous area) Symbol used in drawings to indicate, if necessary, non-explosion hazardous areas. Devices located in safe areas still require a certificate if their outputs run into explosion hazardous areas.

Electrical symbols

Icon	Meaning
	Direct voltage A terminal to which or from which a direct current or voltage may be applied or supplied.
	Alternating voltage A terminal to which or from which an alternating (sine-wave) current or voltage may be applied or supplied.
	Grounded terminal A grounded terminal, which as far as the operator is concerned, is already grounded by means of an earth grounding system.
	Protective grounding (earth) terminal A terminal which must be connected to earth ground prior to making any other connection to the equipment.
	Equipotential connection (earth bonding) A connection made to the plant grounding system which may be of type e.g. neutral star or equipotential line according to national or company practice.

2 Identification

2.1 Unpacking

2.1.1 Visual inspection

During unpacking:

- Check the packing materials for signs of transportation damage.
- Remove the packaging material with care, so as not to damage the Fieldgate.
- Store the original packing material, in case the Fieldgate must be shipped again.
- Keep the documentation supplied with the Fieldgate in a safe place.
- Keep the accompanying documents.

2.1.2 Scope of delivery

Please check that the delivery is complete and free of defects before starting installation.

The scope of delivery comprises the following parts:

- WirelessHART Fieldgate SWG70
- Antenna
- Short instructions
- Depending upon order, FieldCare Device Setup DVD

2.1.3 Storage and transport

Always store and transport the device in the original packaging.

Always store the device in a clean, dry environment.

Keep within the permitted storage temperature range. See the Technical Information document for "WirelessHART Fieldgate SWG70" (TI00027S).

2.2 Nameplate

The device designation together with other information can be found on the nameplate affixed to the front of the Fieldgate.

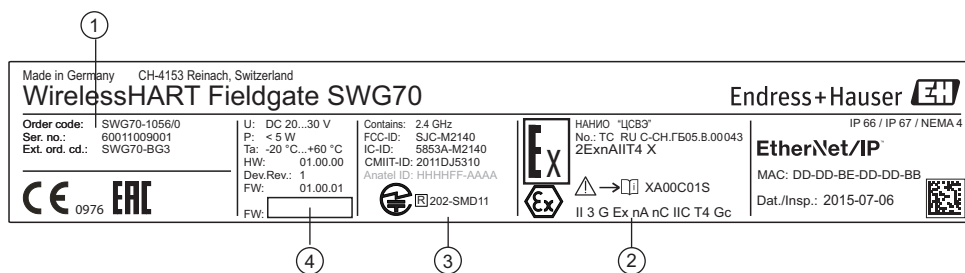

Fig. 2-1: Nameplate (example)

- | | | | |
|---|--------------------------------|---|------------------------------|
| 1 | Order number and serial number | 3 | Telecommunication compliance |
| 2 | Type of protection, if any | 4 | Version information |

2.3 Ordering information

Detailed information about the product structure is available:

- On the Endress+Hauser website: www.endress.com/SWG70
- From your Endress+Hauser Sales Center: www.addresses.endress.com

3 Function and system design

3.1 WirelessHART protocol

The HART protocol has until now used the wired 4–20 mA loop with a superimposed digital signal as physical layer.

WirelessHART enables the wireless transmission of HART data. To be employable world-wide, WirelessHART utilizes the 2.4 GHz Band (IEEE 802.15.4 wireless network) as physical layer. The WirelessHART devices form a mesh network in which every device is not just a measurement point, but also a repeater. This results in a wider range for the whole network as well as increased reliability through redundant communication paths.

The network may comprise three types of device:

- WirelessHART gateway (Fieldgate SWG70)
- WirelessHART field devices
- WirelessHART Adapters (SWA70): either connected to 4–20 mA/HART devices or acting as repeaters.

The WirelessHART network is built up, organized and maintained by the Fieldgate, which also takes care for connection to different HOST systems through different bus interfaces.

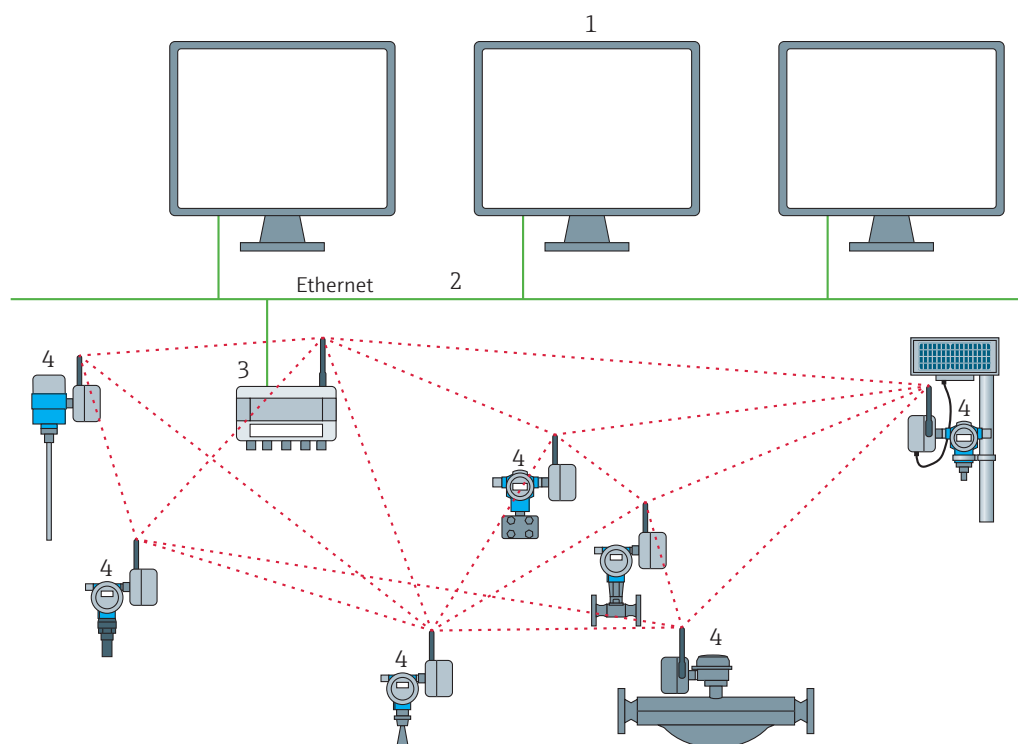

Fig. 3-1: WirelessHART network

- | | | | |
|---|-------------------|---|-----------------------------|
| 1 | Host applications | 3 | WirelessHART Fieldgate |
| 2 | Ethernet | 4 | Field devices with wireless |

3.2 WirelessHART network

Fieldgate SWG70 is the master device in the WirelessHART network. Acting as network manager, it recognizes other devices wanting to join the network. It makes contact with each in turn and initiates the procedures required for them to join. The network organizes itself without any intervention on the part of the user. Fieldgate SWG70 also acts as security manager and collects the data sent by the network participants, converting it into a form which can be used by other systems connected to it.

3.2.1 Network management

In its role as network manager, Fieldgate SWG70 organizes the wireless communication between the WirelessHART field devices.

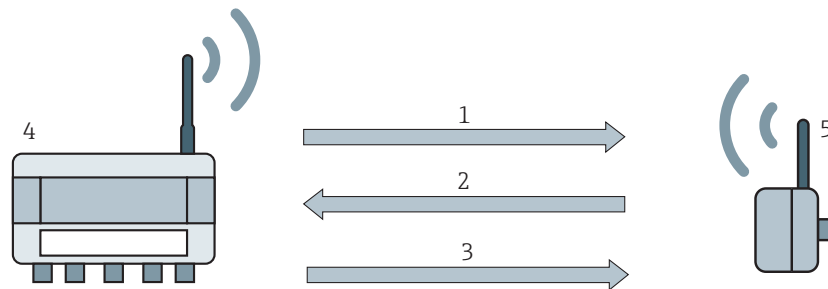

Fig. 3-2: Network management

- | | |
|---|--|
| 1 Step 1: Advertising | 4 WirelessHART gateway (Fieldgate SWG70) |
| 2 Step 2: Join Request | 5 WirelessHART device or adapter |
| 3 Step 3: Authorization, Session & Network Keys, Scheduling and Routing | |

After the Fieldgate has started up the network, devices can join. To this end, it first sends out a call for devices to join the network. Then, the device sends a join request to announce its wish to join the network. If the WirelessHART field device can identify itself with the same network ID and join key as stored in the WirelessHART Fieldgate, the field device is authorized to join the network. Otherwise, the field device will be rejected.

In the next step, the WirelessHART Fieldgate sends session and network keys as well as scheduling and routing information to the field device. The field device is told how to participate in the network and receives various information from the WirelessHART Fieldgate:

- Number and identity of neighboring WirelessHART field devices,
- When to send messages and which channels to use,
- When to repeat messages for other WirelessHART field devices,
- The optimal communication path for messages as well as alternative communication paths in case of failure.

During this process, the WirelessHART device or adapter may also apply to send messages in certain intervals and ask the network manager for the appropriate resources. The network manager then takes care that these resources are available. For example, the network manager informs other WirelessHART field devices when to repeat messages.

3.2.2 WirelessHART security management

Fieldgate SWG70 also acts as security manager. To make communication safe, all messages are encrypted with industry-standard AES-128 block ciphers with symmetric keys. Therefore, messages are unreadable for external listeners. The encryption keys are distributed by the security manager.

The Join Key is used to join the network. Subsequently, the Join Key is automatically exchanged against the Session Key and the Network Key, i.e. two new additional keys.

3.3 Connecting to HART-compatible host systems

Fieldgate SWG70 also makes wireless communication accessible to HART-capable host systems via its Ethernet interface or serial interfaces (RS-485) and the following functions.

Depending on the version ordered, Fieldgate SWG70 can also be integrated into Modbus, OPC or Ethernet/IP host systems.

3.3.1 Instrument list

The WirelessHART devices in the network are made available to the host systems via an instrument list. This list contains one or more I/O cards. Every I/O card has one or more channels. Up to 6 field devices can be connected in multidrop mode to each channel. See Figure 3-3 on page 13. The list itself can be up and downloaded. See Chapter 10.1 "Instrument List" on page 62.

Fieldgate SWG70 assigns a virtual I/O card to each WirelessHART device. The I/O cards are assigned to the WirelessHART devices in the order in which they join the network. New WirelessHART devices in the network are assigned to the next available I/O card, which is added to the end of the instrument list (First-in-First-Out principle).

Within an I/O card, the WirelessHART device itself as well as status information is assigned to Channel 0. If the WirelessHART device is an adapter, all field devices connected to it are assigned to channel 1 (multi-drop mode). The list of the connected field devices is also called sub-device list.

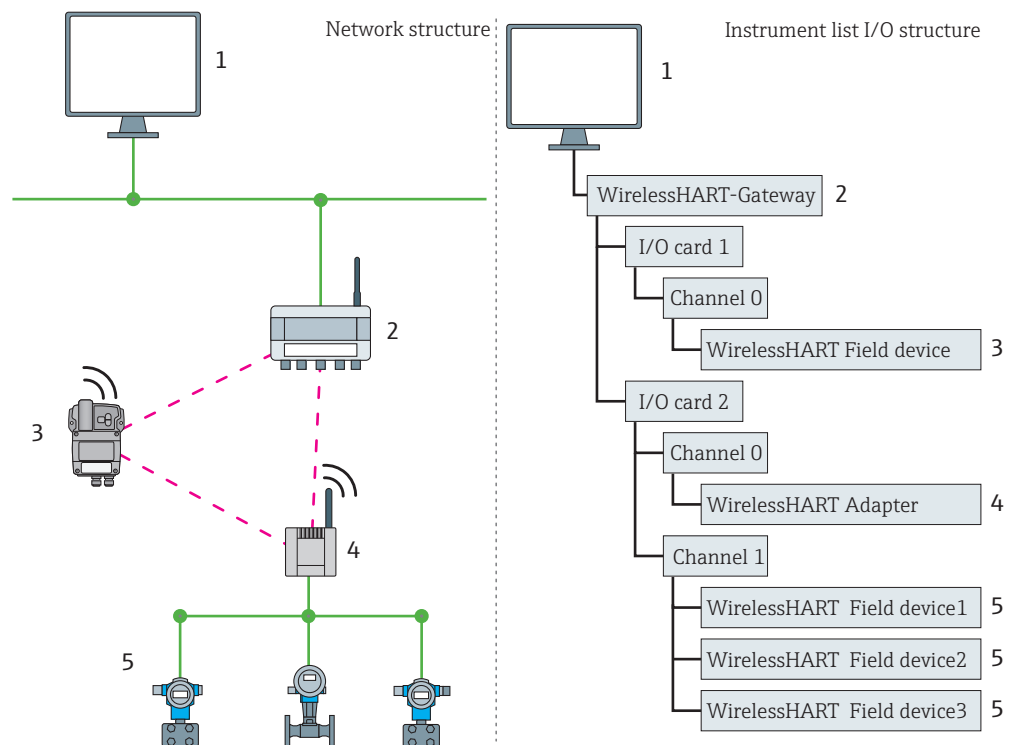

Fig. 3-3: Instrument list

If a WirelessHART device loses communication to the Fieldgate, it stays assigned to the I/O card initially allocated to it. When communication is established again, the device thus has the same position in the instrument list that it had before.

The same principle applies to the field devices connected to the WirelessHART Adapter (SWA70). When communication to the Fieldgate is lost, the long tags of the field devices are stored. After communication has been established again, the field devices regain their previous position in the instrument list.

3.3.2 Cache

The WirelessHART Fieldgate stores information received over the WirelessHART network and makes it available to the host for further processing. This ensures that information is available immediately for the host system without having to send a request to the device and wait for the response. The following commands and answers to requests are cached in the Fieldgate.

Information cached in the WirelessHART Fieldgate

Cache	HART Command	Description
Static: cached upon read	0, 11, 21	Read unique identifier (associated with tag or long tag)
Static: cached upon read & write confirmation	12, (17)	Read (Write) Message
	13, (18)	Read (Write) Short Tag, Descriptor, Date
	20, (22)	Read (Write) Long Tag
	50 (51)	Read (Write) Dynamic Variable Assignments
Dynamic: cached on publication only	1	Read Primary Variable
	2	Read Current and Percentage
	3	Read All Variables
	9	Read Device Variables and Status
	33	Read Device Variables
	38	Read Additional Device Status
	48	Reset Configuration Change Counter
	93	Read Trend

Each listed command has its own cache memory. Static commands are stored in the cache upon the first request. Dynamic variables are stored each time a field device sends a burst message so that up-to-date values are available at all times.

With the exception of write commands 17, 18, 22 and 51, when the WirelessHART Fieldgate receives a request from a host system which is embedded in Command 77, the response is sent immediately (provided that the response is available in the cache).

Long Tag Emulation

WirelessHART uses the long tag for addressing devices. Not every HART device supports long tags, for example, older HART devices with HART Protocol Version 5 or less, do not support long tag addressing.

If a HART 5.0 device is connected to a WirelessHART Adapter (SWA70), the WirelessHART Fieldgate emulates the long tag using the "Message" field. When a host system addresses a HART 5 device, the emulation translates Command 20(22) directly into Command 12 (17) which the HART 5 understands. The response is stored in the Fieldgate cache for CMD 12(17) and for CMD 20(22).

4 Installation

NOTICE**NOTICE!**

- It is recommended that Fieldgate SWG70, adapters and devices be setup on the test bench and the network be tested before the components are installed in the field.

4.1 Mounting considerations

4.1.1 Positioning the Fieldgate

Install the Fieldgate before installing other WirelessHART devices. This way you can check for proper operation of new devices as they are installed. Nevertheless, consider the location of future WirelessHART devices that will be routed through the Fieldgate to ensure good connectivity.

Guidelines for Planning a WirelessHART Network

- Mark the positions of the various measuring points on a scale overview of the plant. It is important that the overview shows likely obstacles to the propagation of the radio waves.
- Make sure that a minimum of 2 other WirelessHART devices are well within the antenna range of the device. If necessary, consider using an adapter as an additional stand-alone repeater. Please refer to the following section for more information about the antenna properties.
- Where a lot of metal, grids or walls prevent a device from being in line-of-sight of its nearest neighbor, the maximum distance between two devices is 30 m. Install wireless devices at least 1m above the ground or the floor.
- Where there are fewer structural elements and one or more neighbors are in direct line-of-sight, the maximum distance between two devices for planning purposes is 200 m. In this case, install wireless devices at least 3m above the ground or the floor.
- Consider moving objects that could affect the device's antenna range.
- Make sure that the device's antenna is aligned vertically.
- If possible, position the Fieldgate at or near the center of the network - it should be in contact with at least 20% of the devices in the network.
- Do not position WirelessHART devices directly below or above each other as they will be outside each other's antenna range. See Chapter 4.1.3 "Examples of good and poor positioning" on page 17.
- If possible, do not position the device next to metal surfaces, pipes or walls containing metal (minimum distance: 6 centimeters). There should be as little metal around the device as possible.
- Do not position other 2.4 GHz devices like cordless phone bases or WLAN routers near WirelessHART devices. Wireless technologies used in an industrial environment must be able to coexist without disrupting each other. If multiple networks operate in one facility, wireless frequency management may be required.

4.1.2 Antenna range

The antenna supplied is an omni-directional dipole antenna.

A schematic representation of the wave propagation is provided in the following graphic. If the antenna is pointed upwards, the signal is emitted horizontally. The transmission and reception quality decreases by up to 50% as of an angle of approx. 39°. Almost no signal will be radiated directly above and below the antenna.

We therefore recommend that you mount the wireless devices on one plane where possible.

If you must mount the wireless devices on very different planes, we recommend you use a remote antenna. See Chapter 4.2 "Mounting the antenna" on page 17. Different coverage is achieved with a remote antenna. For the associated requirements, please see the Technical Information document for "WirelessHART Fieldgate SWG70" (TI00027S).

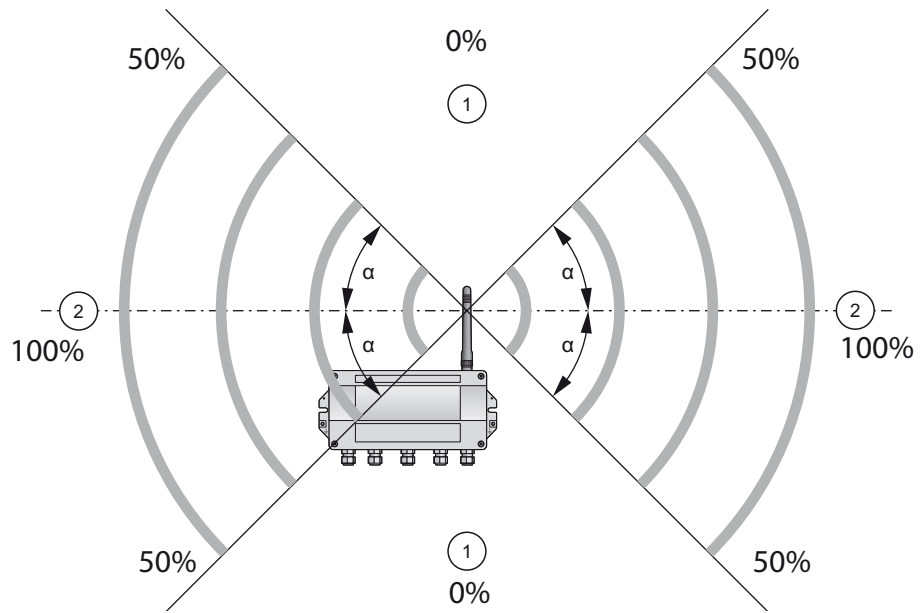

Fig. 4-1: Wave propagation, schematic representation (alpha = approx. 39°)

- 1 No signal above and below
- 2 Stronger signal sideways

4.1.3 Examples of good and poor positioning

The positioning is good when the network participants are within the antenna range:

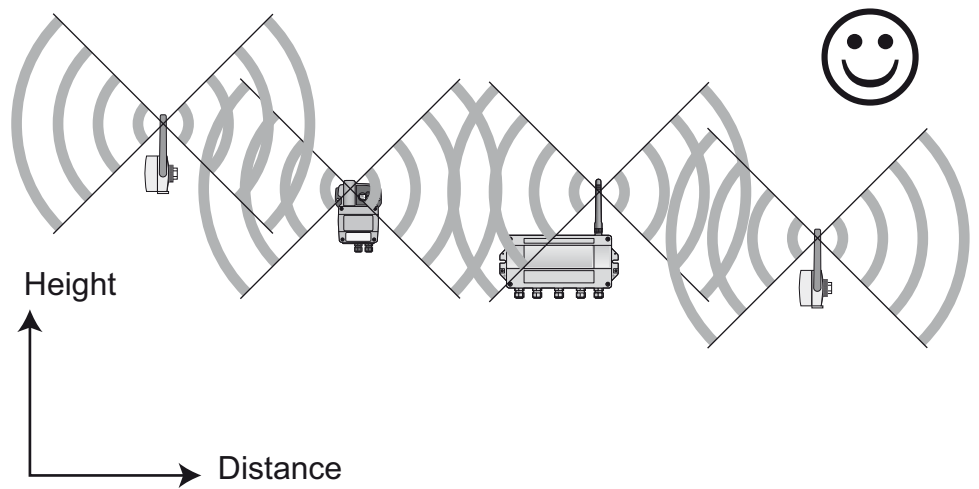

Fig. 4-2: Example of good positioning

The positioning is poor when neighbors are not in the antenna range or within the weaker signal zone of the antenna:

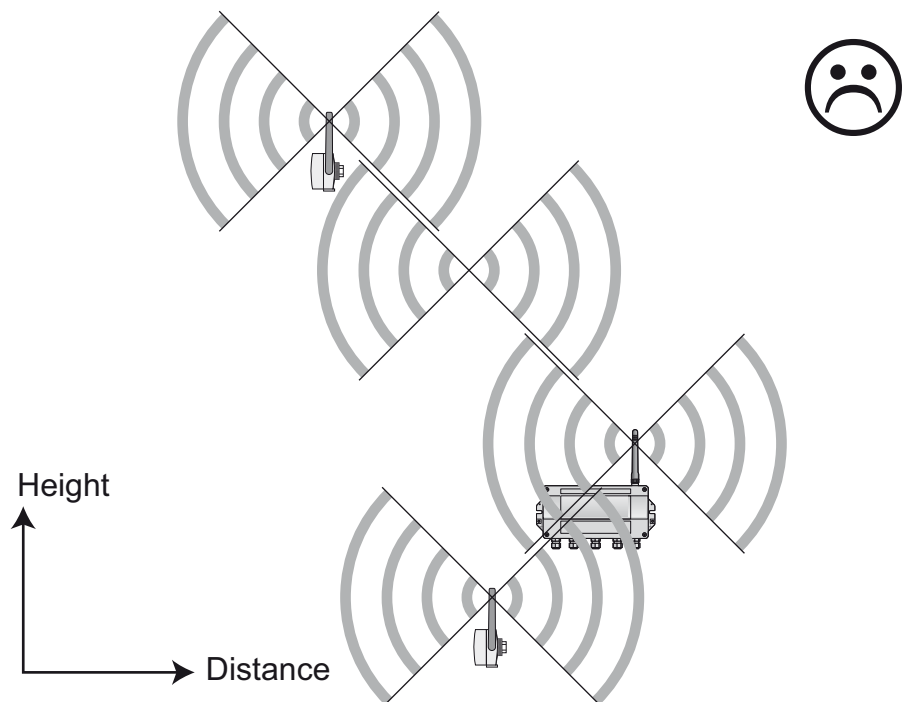

Fig. 4-3: Example of poor positioning

4.2 Mounting the antenna

WARNING

WARNING!

- If Fieldgate SWG70 is installed in a hazardous area Zone 2, you may only connect or disconnect the antenna and cables in the absence of any potentially explosive atmosphere or if the Fieldgate is not connected to the power supply.

NOTICE**NOTICE!**

- Use only the antenna supplied or a remote antenna that meets the requirements. For the associated requirements, please see the Technical Information document for "WirelessHART Fieldgate SWG70" (TI00027S).

4.2.1 Mounting the antenna supplied

1. Switch off the power supply to the Fieldgate.
2. Firmly screw the antenna to the device's antenna terminal.
See Figure 5-1 on page 20, Item 6.

4.2.2 Connecting a remote antenna**WARNING****WARNING!**

- Outdoor installations can be subject to lightning strikes. Install a surge arrester to protect the installation against transients or damage caused by lightning strikes.

NOTICE**NOTICE!**

- Only use antennas, cables and surge arresters that are listed in the Technical Information document "WirelessHART-Fieldgate SWG70" (TI00027S).
- Ensure adequate strain relief for the cables.
- Pay attention to the bending radii of the cables. Do not drop below the permitted bending radii.

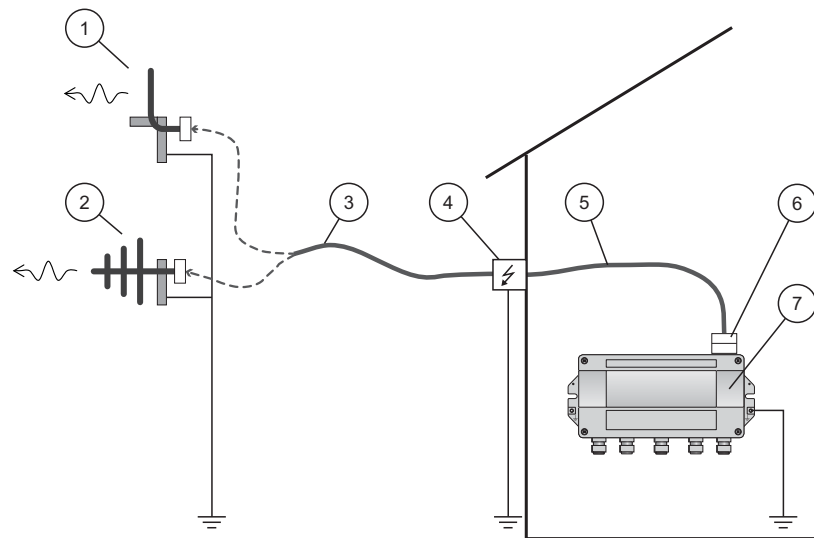

Fig. 4-4: Installation of an remote antenna

- | | |
|--------------------------------|--------------------------------|
| 1 Omnidirectional antenna | 5 Coaxial cable with connector |
| 2 Directional antenna | 6 Coaxial adapter |
| 3 Coaxial cable with connector | 7 Fieldgate SWG70 |
| 4 Surge arrester | |

1. Switch off the supply voltage to the Fieldgate.
2. Install the antenna where it is within the antenna range of other WirelessHART devices. See Chapter 4.1.3 "Examples of good and poor positioning" on page 17.

3. Mount the surge arrester indoors. The coaxial cable between the surge arrester and Fieldgate may only be routed indoors.
4. Connect the antenna to the surge arrester using a coaxial cable.
5. Connect the antenna, the surge arrester and the Fieldgate to the protective grounding as illustrated in Figure Fig. 4-4.

4.3 Mounting the Fieldgate

In addition to fulfilling the conditions for good wireless communication, the mounting location should be well accessible for mounting and electrical installation. Make sure that there is enough space to open the housing cover and to access the terminals, switches, and cable glands. Choose a mounting location that meets the climatic limits specified and radio requirements in the technical data.

Required tools:

- 2 screws (M6)
- Drill
- Screwdriver

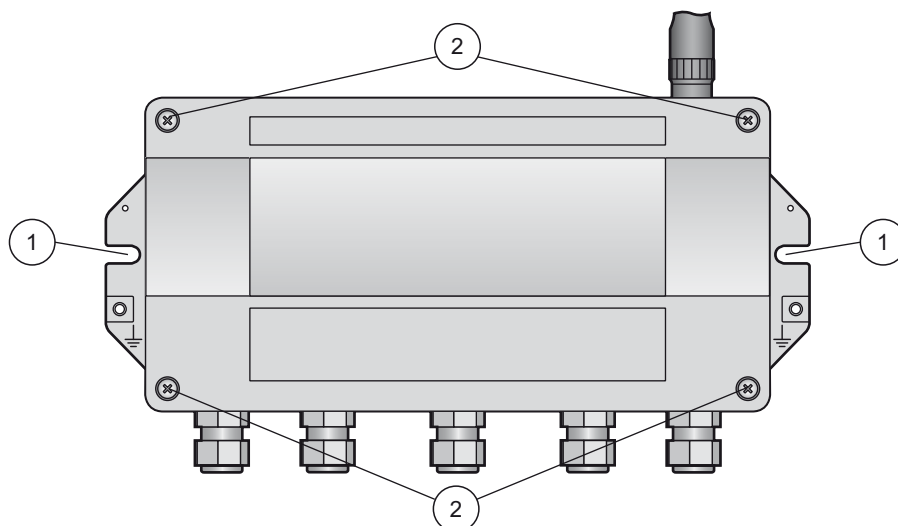

Fig. 4-5: Mounting holes and housing screws

- | | |
|----------------|----------------|
| 1 | 2 |
| Mounting holes | Housing screws |

Mounting the Fieldgate

1. Drill 2 holes in the mounting surface so that they match the holes of the housing (centers 240 mm to 250 mm apart). See the Technical Information document for "WirelessHART Fieldgate SWG70" (TI00027S).
2. Screw the device to the mounting surface.

5 Electrical Installation

5.1 Connections and interfaces

The connections and interfaces are only accessible with an open enclosure. In the case of the DIP switches, the user has the choice of using the switch settings, or overriding the settings by software. See Chapter 8 "Fieldgate configuration" on page 42.

WARNING

WARNING!

- If Fieldgate SWG70 is installed in a hazardous area Zone 2, you may only connect or disconnect the antenna and cables in the absence of any potentially explosive atmosphere or if the Fieldgate is not connected to the power supply.

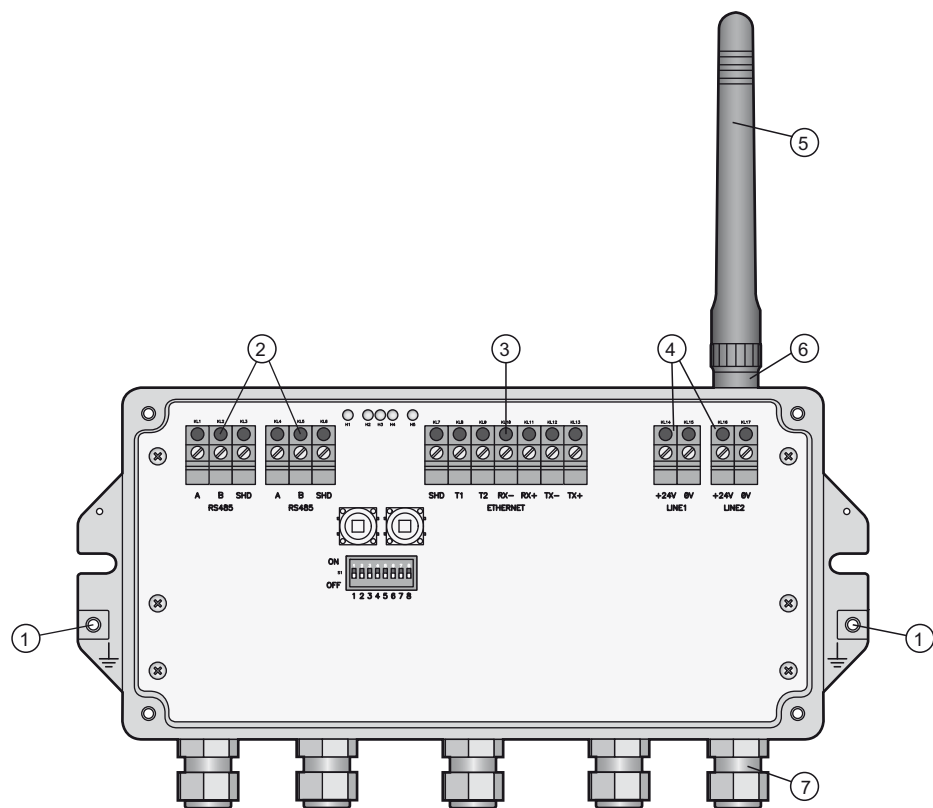

Fig. 5-1: Connections and interfaces

- | | | | |
|---|---|---|------------------|
| 1 | Grounding terminal | 5 | Antenna |
| 2 | RS-485 interfaces, duplicated terminal block for daisy-chain capability | 6 | Antenna terminal |
| 3 | Ethernet interface | 7 | Cable glands |
| 4 | Power supply connections (redundant) | | |

5.2 Connecting to power supply and grounding

There are two 24 VDC power supply terminal blocks located inside Fieldgate SWG70, allowing for redundant power supply. Open the housing cover to access the terminal blocks.

NOTICE

NOTICE!

- Ensure adequate strain relief for the cables.
- Pay attention to the bending radii of the cables. Do not drop below the permitted bending radii.

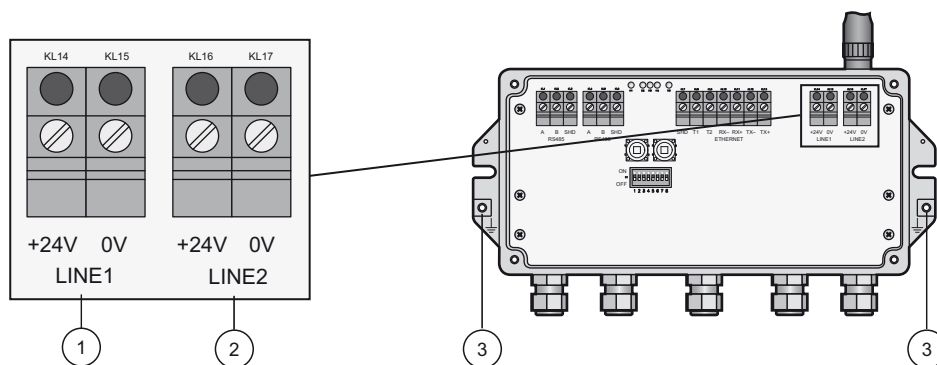

Fig. 5-2: Power supply

- | | |
|--|-----------------------|
| 1 First power supply connection | 3 Grounding terminals |
| 2 Second (redundant) power supply connection | |

Connecting to 24 VDC power supply and grounding

Fieldgate SWG70 must be connected to a 24 VDC power supply. For details, see the Technical Information document for "WirelessHART Fieldgate SWG70" (TI00027S).

DANGER

DANGER!

Risk of electric shock if the wrong power unit is used.

- Always use a SELV/PELV power unit to guarantee electrical safety.
1. Switch off the power supply.
 2. Connect the protective ground to one of the two ground terminals.
 3. Unscrew the 4 screws of the housing cover and remove the housing cover. See Figure 4-5 on page 19.
 4. Route the 24 VDC power cable through the second cable gland from right. The permissible cable diameter lies between 6 mm and 10 mm.
 5. Connect the 24 VDC power cable to the first power supply connection "Line 1" observing polarity. See Figure 5-1 on page 20.
 6. If you want to connect a redundant power supply (optional), route the second 24 VDC power cable through the cable gland on the far right of the housing.
 7. Connect the second power cable to the second power supply connection "Line 2" observing polarity.
 8. Switch on the power supply. The green power LED should light up immediately.
 9. Tighten the cable gland with appropriate torque. See Chapter 5.5 "Cable glands and housing cover" on page 25.

5.3 Connecting to Ethernet

WARNING

WARNING!

- If Fieldgate SWG70 is installed in a hazardous area Zone 2, you may only connect or disconnect the antenna and cables in the absence of any potentially explosive atmosphere or if the Fieldgate is not connected to the power supply.

NOTICE

NOTICE!

- Keep in mind that an access point of the Ethernet network has to be available. The maximum length of the cable running from the Fieldgate to the access point is 100 m, depending on the cable type and communication speed.
- Please note that older computers, hubs, switches or routers might not feature automatic TX/RX detection. In this case, use a crossover cable.
- Ensure adequate strain relief for the cables.
- Pay attention to the bending radii of the cables. Do not drop below the permitted bending radii.

5.3.1 Connecting the "Modbus" or "Modbus + OPC" versions to Ethernet

The Ethernet cable is connected directly to the Ethernet terminal block in the Fieldgate.

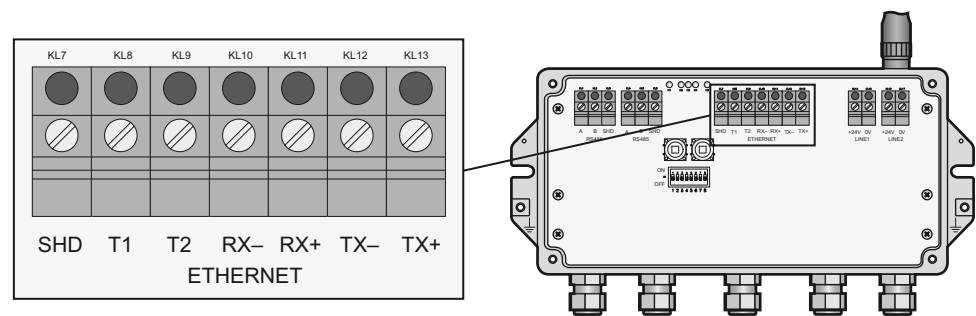
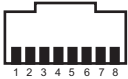

Fig. 5-3: Fieldgate with 5 cable entries and Ethernet terminal block

1. Switch off the power supply.
2. Unscrew the screws of the housing cover and remove the housing cover. See Figure 4-5 on page 19.
3. Route the Ethernet cable through the cable gland in the middle of the Fieldgate housing. The permissible cable diameter is between 6 mm and 10 mm.

- Connect the Ethernet cable to the terminal block labeled "Ethernet" according to the following table.

Computer		Fieldgate	
Pin Numbering	Connector	Crossover cable	Normal cable
	Pin 1	TX+	RX+
	Pin 2	TX-	RX-
	Pin 3	RX+	TX+
	Pin 4	T2	T2
	Pin 5	T2	T2
	Pin 6	RX-	TX-
	Pin 7	T1	T1
	Pin 8	T1	T1

- Screw the housing cover on the housing.
- Tighten the cable gland with appropriate torque. See Chapter 5.5 "Cable glands and housing cover" on page 25.
- Switch on the power supply.

5.3.2 Connecting the "EtherNet/IP" version to Ethernet

The Ethernet cable with a D-coded M12 connector is connected to the M12 socket of the Fieldgate housing.

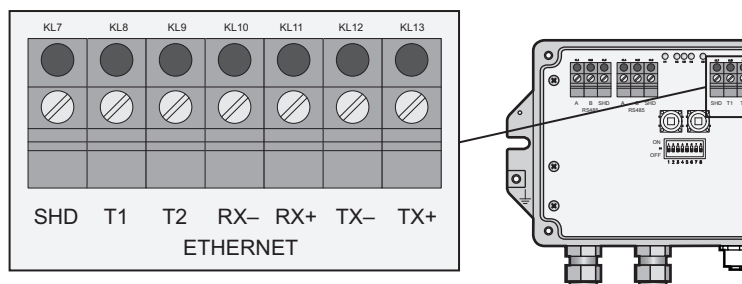

Fig. 5-4: Fieldgate with M12 socket in the middle

- Ethernet terminal block wired internally to M12 socket
- M12 socket, D-coded for connection to an Ethernet or Ethernet/IP network

- Switch off the power supply.
- Plug the D-coded M12 connector into the Ethernet socket of the Fieldgate. See Figure 5-4 on page 23.
- Tighten the coupling nuts on the M12 connector. The Fieldgate is connected to the Ethernet network.
- Switch on the power supply.

Internal wiring

The Ethernet socket is wired to the Ethernet terminal block. The internal wiring may not be modified.

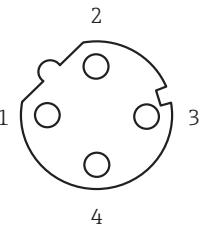
Pin Numbering	Connector	Signal	Internal Wire Colors
	Pin 1	TX+	Yellow
	Pin 2	RX+	White
	Pin 3	TX-	Orange
	Pin 4	RX-	Blue

5.4 Connecting to RS-485

Fieldgate SWG70 is equipped with a fully galvanic isolated RS-485 interface. A second RS-485 terminal block allows several Fieldgates to be connected through a daisy chain.

A terminating resistor is required at each end of the RS-485 cable. If the RS-485 cable is not routed to other devices (no daisy-chain connection), activate the terminating resistor using the corresponding DIP switches in the fieldgate. See Chapter 6.1.3 "DIP switches" on page 29.

NOTICE

NOTICE!

- The maximum length of the cable from the Fieldgate is 1200m (at reduced communication speed).
- Use shielded twisted pair (STP) cables only.
- If the cable shield is grounded, only connect the grounding to one cable end. This avoids potential equalization currents.
- Ensure adequate strain relief for the cables.
- Pay attention to the bending radii of the cables. Do not drop below the permitted bending radii.

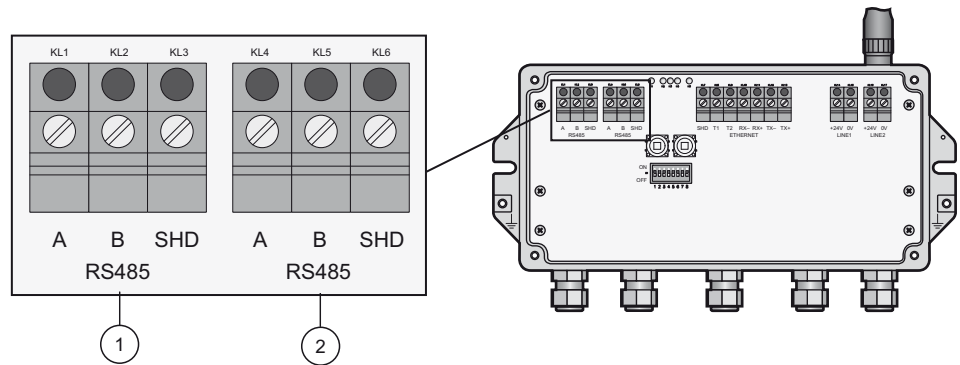

Fig. 5-5: RS-485 interface

1 First RS-485 connection

2 Second RS-485 connection for daisy chaining

Connecting to RS-485

1. Switch off the power supply.
2. Unscrew the screws of the housing cover and remove the housing cover. See Figure 4-5 on page 19.
3. Route the RS-485 cable through the first cable gland from left. The permissible cable diameter is between 6 mm and 10 mm.
4. Connect the RS-485 cable to the left terminal block labeled "RS-485" as follows (see the graphic above):

Wire RS-485 cable	Fieldgate terminal	Remarks
RxD/TxD- (RS-485 A)	A	RS-485 differential signal
RxD/TxD+ (RS-485 B)	B	
Shield	SHD	Cable shielding

5. For a daisy-chain connection, route the second RS-485 cable through the second cable gland from left and connect it to the right terminal block labeled "RS-485", see table above.
6. To activate the RS-485 termination, set DIP switch number 7 to "ON". See Chapter 6.1.3 "DIP switches" on page 29.
7. Screw the housing cover on the housing.
8. Tighten the cable gland with appropriate torque. See Chapter 5.5 "Cable glands and housing cover" on page 25.

5.5 Cable glands and housing cover

The degree of protection cannot be achieved if the cables and cable glands are not fitted correctly.

To ensure the IP degree of protection

- all screws of the housing / housing cover must have been tightened with the appropriate torque,
- only cables of the appropriate size must be used in the cable glands,
- all cable glands must be tightened with the appropriate torque,
- all seals must be undamaged and fitted correctly,
- all empty cable glands must be sealed with appropriate plugs.

The tightening torques of cable glands depend on what type of cable is used and must therefore be determined by the user. The cap nuts must be securely tightened. Tightening the cap nuts too tight can have a negative effect on the protection class. The following figures can be taken as rough guides.

Type of cable gland	Approx. installation torque
Plastic	2.5 Nm
Nickel-plated brass	4.1 Nm
Stainless steel	4.1 Nm

The Fieldgate housing cover must be tightened with a torque of 2.5 Nm.

6 Operation

6.1 Operating and display elements

Inside the fieldgate housing there are LED indicators, DIP switches and reset buttons. The controls and indicators are accessible with open enclosure.



WARNING!

- If Fieldgate SWG70 is installed in a hazardous area Zone 2, you may only operate the DIP switches and the keys and only connect or disconnect the cables in the absence of any potentially explosive atmosphere or if the Fieldgate is not connected to the power supply.

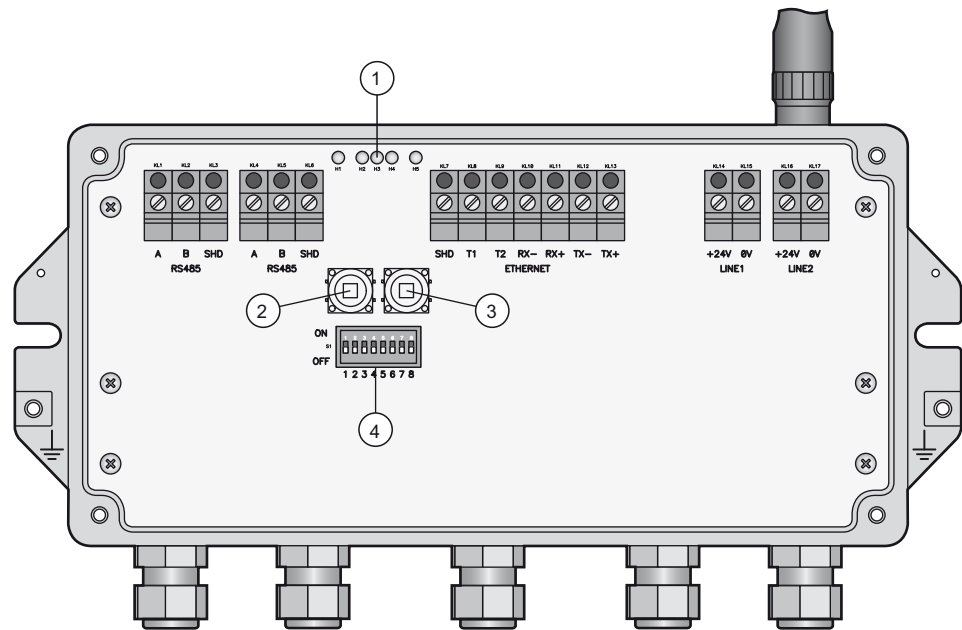

Fig. 6-1: Operating and display elements

- | | | | |
|---|-----------|---|--------------|
| 1 | LEDs | 3 | Button P2 |
| 2 | Button P1 | 4 | DIP switches |

6.1.1 LEDs

Five LEDs indicate the status of Fieldgate SWG70.

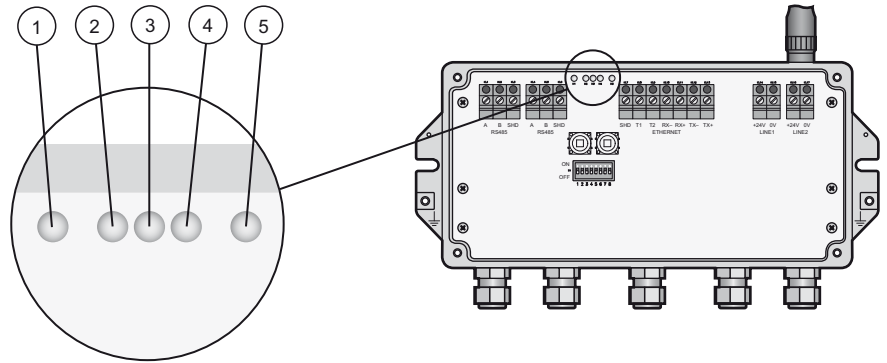

Fig. 6-2: LED indicators

- 1 Yellow LED: RS-485 communication status
- 2 Green LED: Power supply
- 3 Yellow LED: WirelessHART communication status
- 4 Red LED: Device status
- 5 Yellow LED: Ethernet communication status

Yellow LED: RS-485 communication status

Mode	Status	Meaning
Flashes	–	Flashes briefly whenever a valid message is received by the Fieldgate on the RS-485 communication line. – The LED does not flash if the message is not addressed to the Fieldgate or if a communication error was detected within the message.
Off	–	Currently no communication on the RS-485 line.

Green LED: Power supply and operation status

Mode	Status	Meaning
On	OK	Fieldgate SWG70 is powered up and running
Flashes	Not ready	On power-up, indicates that the Fieldgate application is running but the Fieldgate is not yet ready to answer HART commands.
Off	No power	The power supply is not connected/Fieldgate is not ready.

Yellow LED: WirelessHART communication status

Mode	Status	Meaning
Flashes	–	Flashes shortly whenever a valid WirelessHART message is received by the Fieldgate on the WirelessHART communication interface. – Messages include simple commands but not published bursts and event notifications.
Off	–	Currently no communication on the WirelessHART interface.

Red LED: Device status

Mode	Status	Meaning
On	Hardware fault	Fieldgate has detected a hardware fault that makes normal operation impossible.
Flashes	Recovering from hardware fault.	The Fieldgate application is trying to recover from the fault (not possible for all faults).
Off	No hardware fault	–

Yellow LED: Ethernet communication status

Mode	Status	Meaning
On	-	The connection to the Ethernet line is established.
Flashing irregularly	-	Fieldgate is receiving a message via the Ethernet interface. The LED does not flash in the following instances: <ul style="list-style-type: none"> ■ The message is not addressed to the Fieldgate. ■ A communication error was detected in the message.
Flashing (every second)	-	A conflict has been detected in the IP address. The Fieldgate IP address is already being used by another device in the Ethernet network Assign another IP address to the Fieldgate. See Chapter 7.1 "Ethernet connection" on page 31.
Off	-	There is no connection to the Ethernet network. This is often due to a bad cable connection. See Chapter 5.3 "Connecting to Ethernet" on page 22.

6.1.2 Buttons

Fieldgate has two pushbuttons.



WARNING!

- When Fieldgate SWG70 is installed in Ex-Zone 2 and the power is switched on, the operation of the pushbuttons is permitted only in the absence of any potentially explosive atmosphere.

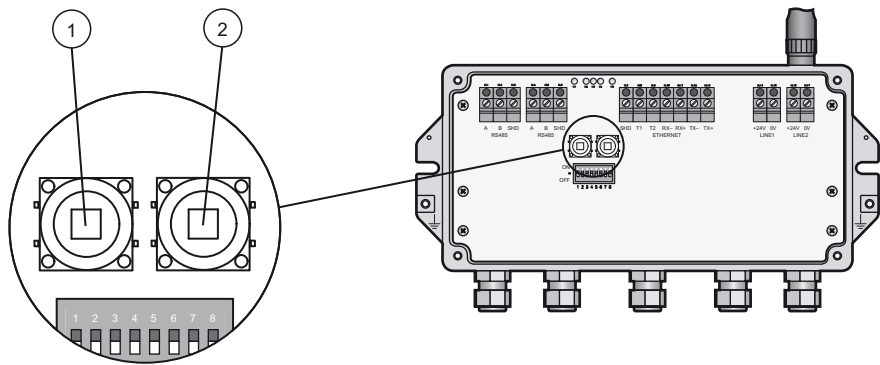

Fig. 6-3: Pushbuttons

1 Button P1

2 Button P2

The function of the buttons is as follows:

Buttons

Buttons	Function	Procedure
Button P1	Configuration reset	Press the button for more than 3 seconds. - All Fieldgate SWG70 configuration parameters are reset to factory settings with exception of the parameters set by button P2 and button P1 + P2. - After approx. 3 seconds, all LEDs light up to confirm the reset.
Button P2	Communication reset	Press the button for more than 3 seconds. - All Fieldgate SWG70 configuration parameters related to the wired communication channels are reset to factory settings. - After approx. 3 seconds, all LEDs light up to confirm the reset.
Button P1 + P2 DIP switch 8 OFF	Password reset	Press buttons P1 and P2 simultaneously for more than 3 seconds. - All Fieldgate SWG70 passwords are reset to the factory settings. - Passwords are used for access to the Command Line Interface and the Web Server (HTTPS). - For Web Server User name: admin; Password: admin - After approx. 3 seconds, all LEDs light up to confirm the reset.
Button P1 + P2 DIP switch 8 ON	Network manager reset	Press buttons P1 and P2 simultaneously for more than 3 seconds. - The Fieldgate SWG70 join key, network ID, radio power and access mode are reset to factory settings. - After approx. 3 seconds, all LEDs light up to confirm the reset.

6.1.3 DIP switches



WARNING!

- When Fieldgate SWG70 is installed in Ex-Zone 2 and connected to the power supply, the operation of DIP switches is permitted only in the absence of any potentially explosive atmosphere.



NOTICE!

- The same functions can be initiated from the Fieldgate SWG70 Web interface and DTM. See Chapter 8.3 "Interfaces (wired communication)" on page 48.

Fieldgate SWG70 has one 8-gang DIP switch. Fieldgate SWG70 is delivered with all DIP switches set to ON and with all DIP switch functions set by software controls.

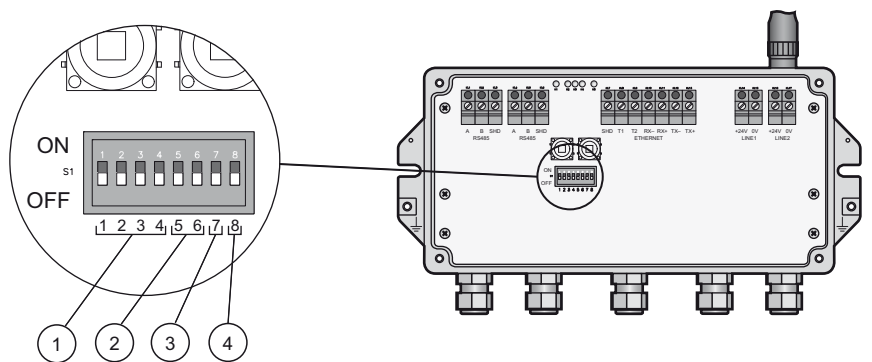

Fig. 6-4: DIP switches

- | | | | |
|---|--|---|---|
| 1 | DIP switches 1 to 4: HART device address | 3 | DIP switch 7: RS-485 terminating resistor |
| 2 | DIP switches 5 and 6:
Baud rate of RS-485 interface | 4 | DIP switch 8: Security mode |

DIP switch positions

Switch	Function	1	2	3	4	Value	1	2	3	4	Value
1 - 4	HART device address ¹⁾	OFF	OFF	OFF	OFF	0	OFF	OFF	OFF	ON	8
		ON	OFF	OFF	OFF	1	ON	OFF	OFF	ON	9
		OFF	ON	OFF	OFF	2	OFF	ON	OFF	ON	10
		ON	ON	OFF	OFF	3	ON	ON	OFF	ON	11
		OFF	OFF	ON	OFF	4	OFF	OFF	ON	ON	12
		ON	OFF	ON	OFF	5	ON	OFF	ON	ON	13
		OFF	ON	ON	OFF	6	OFF	ON	ON	ON	14
		ON	ON	ON	OFF	7	ON	ON	ON	ON	15
		5	6	Value			5	6	Value		
5 and 6	Baud rate of RS-485 interface	OFF	OFF	9600 bit/s			OFF	ON	38400 bit/s		
		ON	OFF	19200 bit/s			ON	ON	57600 bit/s		
7	RS-485 termination	■ OFF = disconnected					■ ON = connected				
8	Download Join Key/Network ID	■ OFF = disabled					■ ON = enabled				
1) You can set up HART device addresses from 0 to 63 by software.											

Security mode

When DIP switch 8 is OFF, it is not possible to download the Network ID and the Join Key to the Fieldgate. See Chapter 8.3.2 "Serial (RS-485)" on page 49. Fieldgate SWG70 is delivered with the download enabled by default, i.e. DIP switch 8 is ON.

7 Commissioning

NOTICE

NOTICE!

- We recommend that you first set up the Fieldgate SWG70, the WirelessHART Adapters and the HART devices on a test bench and test the network.

The Fieldgate SWG70 can be set up in the following ways:

- Via the Ethernet connection using the Web server
- Via the Ethernet connection using FieldCare and Fieldgate-DTM
- Via the RS-485 connection using FieldCare and Fieldgate-DTM

The structure of the parameter blocks and the parameters in the Fieldgate DTM and the Web server in the Fieldgate are identical.

Web server

The Fieldgate SWG70 has an integrated Web server.

You can set up the Fieldgate and the associated WirelessHART network via the Web server. See Chapter 7.1 for details on setting up the Fieldgate SWG70 via the Web server.

FieldCare

You can set up the Fieldgate and the associated WirelessHART network via FieldCare. In addition, you can also configure the WirelessHART Adapters SWA70 and the connected devices via FieldCare.

A prerequisite is that the WirelessHART Adapters and devices already use the same join key and network identifier as Fieldgate SWG70 and have joined the network. Configure connected WirelessHART Adapters and field devices via the relevant DTMs.

NOTICE

NOTICE!

- It is advisable to configure the adapters and connected HART devices via a direct connection. See Operating Instructions BA00061S/04/en. If FieldCare accesses the devices via the Fieldgate SWG70 DTM, the response times may be considerably longer than for a direct connection.

See Chapter 7.1 and Chapter 7.3. for details on setting up the Fieldgate SWG70 via FieldCare.

7.1 Ethernet connection

The Ethernet connection of Fieldgate SWG70 allows communication with a computer via the integral Web Server or via FieldCare.

The following requirements must be met:

- Internet Protocol TCP/IP is installed on your computer and is active.
- You have administration rights for your computer and network.
- You have an set of IP addresses that have been authorized by your IT department.
- Any proxy server for your Internet Browser is disabled.
- Firewalls allow communication on port 80, 433, 502, 3333 and 5094.

Fieldgate SWG70 is delivered with the default IP address:

- 192.168.1.1

NOTICE**NOTICE!**

- By default, the IP address of the WirelessHART Fieldgate EtherNet/IP version is automatically assigned via DHCP. Please contact your network administrator to identify the automatic set IP address, if necessary.

- Alternative 3rd party IP scanner software i.e. "BOOTP Utility Software" from Rockwell Automation enables you to scan the Ethernet network and being able to assign a dedicated IP address i.e. 192.168.1.1 to the WirelessHART Fieldgate. Please consider WirelessHART Fieldgate MAC address is required to be able to set a dedicated IP address with "BOOTP Utility Software" from Rockwell Automation.

- Please find below path to Rockwell Automation "BOOTP Utility Software" download and instruction page:
 1. Go to <http://www.rockwellautomation.com>
 2. Click "Products"
 3. Click "Reliance Electric Drives"
 4. Click "Software"

7.1.1 Establishing the connection between the host computer and the Fieldgate SWG70 Web server

Prerequisite

The Fieldgate SWG70 is connected to the Ethernet network. See Chapter 5.3 "Connecting to Ethernet" on page 22.

Procedure

1. Check that the computer can reach the Fieldgate via ports 80, 443, 502, 3333 and 5094. Please contact your network administrator if necessary.
2. Note the current settings for the IP address and network/subnet mask of the computer to restore them if necessary.
3. Change the IP address and the network/subnet mask of your computer:
 - IP address 192.168.1.200
 - Network/subnet mask 255.255.255.0.
4. The simplest way to check the connection is to call up the Fieldgate SWG70 Web server. For this, enter the default IP address of the Fieldgate SWG70 in your Internet browser: 192.168.1



5. Accept the site certificate in the dialog which now appears.
6. The Login of the Web page appears.
 - To open the Fieldgate SWG70 Web page, enter the **User name** (default: admin) and the **Password** (default: admin) and click **OK**.
 - You must change the password after logging in for the first time.



7. If the connection to the Fieldgate Web server fails, check the following points:
 - Are all the proxy servers in the browser switched off or not used for this address range?
 - Are ports 80, 443, 502, 3333 and 5094 open in all the firewalls?
 - Are you using the correct Ethernet cable? See Chapter 5.3 "Connecting to Ethernet" on page 22.
 - Is the Ethernet cable correctly connected? See Chapter 5.3 "Connecting to Ethernet" on page 22.

7.2 RS-485 connection

Prerequisite

The Fieldgate SWG70 is connected to the RS-485 bus. See Chapter 5.4 "Connecting to RS-485" on page 24.

Procedure

1. Connect the RS-485 bus to your computer via an RS-485/RS-232 signal converter or an RS-485/USB signal converter.
2. If you are using an RS-485/USB signal converter, install the correct driver.
3. Open the Windows device manager to find out which COM port the converter is connected to. For this purpose, enter "Device manager" in the search window in the Windows Start menu.
4. The signal converter and the assigned COM port are displayed under "Ports (COM & LPT)".

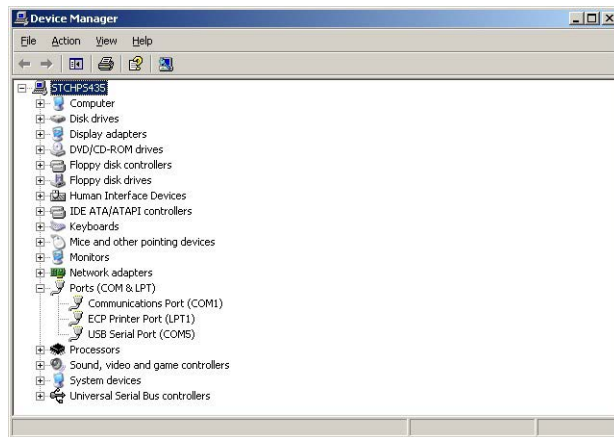

5. Note the COM port (in this case USB Serial Port (COM5)) and the baudrate etc. as you will need them to set up communication.

7.3 Creating a FieldCare project

Creating a FieldCare project will allow you to configure Fieldgate SWG70 and any HART device (field device or adapter) in the wireless network via its DTM. The configuration of a field device can be taken from the manufacturer's operating manual, the configuration of the adapter is described in Operating Instructions BA00061S/04/en, SWA70 Wireless Adapter.

7.3.1 Adding the HART IP CommDTM

The HART IP CommDTM is required for communication via Ethernet with FieldCare.

NOTICE

NOTICE!

- If you wish to connect to FieldCare via the RS-485 interface, the HART Communication CommDTM must be added and configured instead of the HART IP CommDTM.
- The procedure is similar to that described here, whereby the configuration involves other parameters such as selection of multiplexer option, COM port and baudrate.

1. In the FieldCare project workspace, right-click on the **Host Computer** node and select **Add Device**:

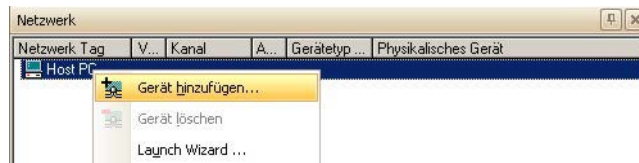

2. The **Add New Device** dialog opens:

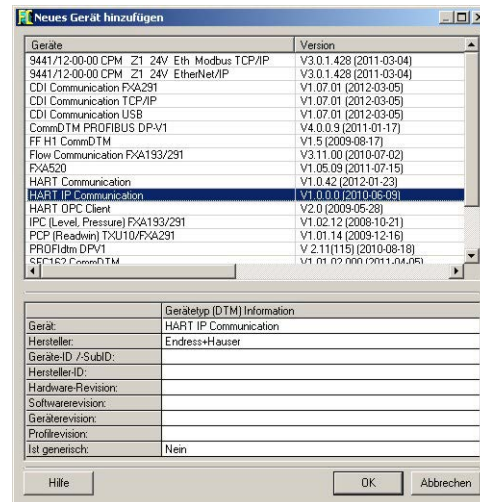

- Select **HART IP Communication** and press **OK**.
 - The dialog closes and the HART IP Communication DTM is added below the Host node.
3. If desired, the HART IP Communication DTM can be now configured offline.
 - Right-click on the node and select **Configuration**.
 - The node name and timeout (default 10000 ms) can be changed.
 - The changes are accepted when the **Apply** button is pressed.

7.3.2 Adding the Fieldgate SWG70

1. Right-click **HART IP Communication** and select **Add Device**:

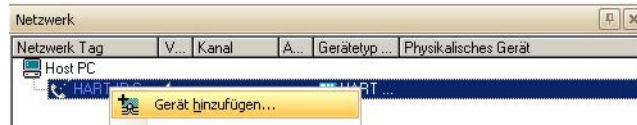

2. The **Add New Device** dialog opens:

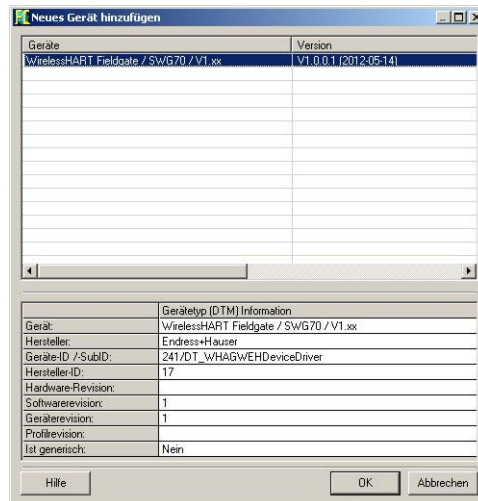

- Select **WirelessHART Fieldgate SWG70** and press **OK**.
3. The dialog closes and the Fieldgate SWG70 DTM is added below the HART IP node.

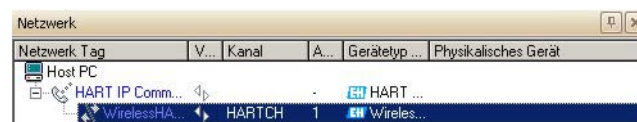

4. If the factory IP address (192.168.1.1) or the Ethernet Port (5094) of the Fieldgate SWG70 has been changed, right-click on the **HART IP Communication** node and select **Additional Functions => Set DTM Addresses...**
 - The **Set DTM Addresses Dialog** opens:

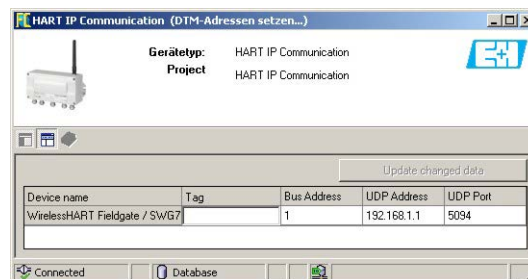

5. Enter the new IP address and/or Ethernet UDP Port number and press Update Changed Data.
6. Close the dialog – the Fieldgate SWG70 can now be put online.

7.3.3 Parameterizing Fieldgate SWG70

1. Right-click **HART IP Communication** and select **Connect**:
 - The HART IP CommDTM is put on-line and the two arrows turn green.

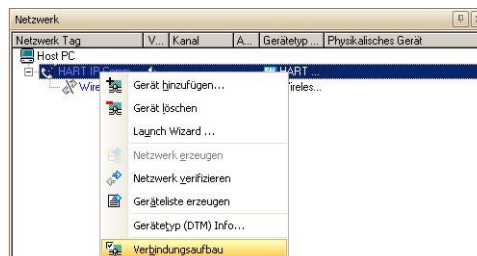

2. Right-click on the **Fieldgate SWG70** node and select **Connect**.
 - The Fieldgate SWG70 DTM is put on-line and the two arrows turn green.
3. Right-click on the **Fieldgate SWG70** node and select **Online Parameterize**:

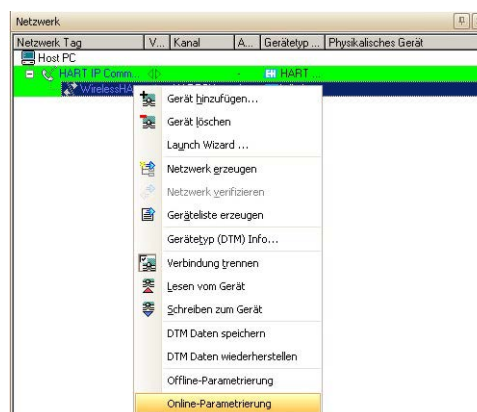

- The DTM of Fieldgate SWG70 opens.
4. Expand all the submenus of the directory tree to reveal the parameter blocks. (The "Identification" page is open in the graphic below):



- You are now ready to configure the device. See Chapter 8 "Fieldgate configuration" on page 42.

7.3.4 Scanning for wireless devices in the network

After Fieldgate SWG70 has been configured, see Chapter 8.2 onwards, you may want to scan for other devices in the network.

1. Right-click on the **Fieldgate SWG70** node and select **Create Network...**:
 - You can also click on the Create Network icon to do this.
 - The Fieldgate SWG70 is put on-line and the two arrows turn green.



2. The Fieldgate CommDTM now scans the wireless network and automatically adds all WirelessHART devices found to the network (in our case the SWA70 adapters):



NOTICE

NOTICE!

- If no device is found although communication has been established, check that the adapters have been configured with the correct network identification and join key.
- It may take up to ten minutes for a wireless device to join the network after download of the Network ID and Join Key.
- To increase the performance of a connection to an adapter it is possible to open a fast pipe. See Chapter 8.2.3 "Operating Modes" on page 47.

7.3.5 Scanning for devices connected to adapters

It is also possible to scan for the devices connected to the adapters. Depending on the size of the network and the connected field devices, however, it is possible that time out problems occur. In this case, FieldCare issues a warning and the user can choose to cut the connection, wait for connection or retry the connection.

1. Open a fast pipe to the corresponding adapter. See Chapter 8.2.3 "Operating Modes" on page 47.
2. Right-click on the **Adapter** node and select **Create Network...**:
 - You can also click on the Create Network icon to do this.

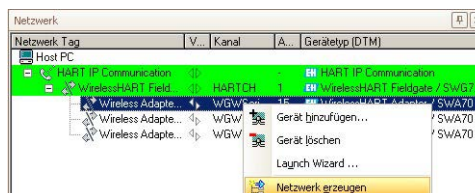

3. The adapter DTM now scans the wired interface and automatically adds all the HART devices found to the network (in this case, the temperature transmitter TMT162):
 - Depending upon FieldCare configuration and number of devices, this may occur automatically or after confirmation with **OK** in the Scanning Result dialog.
 - Depending upon FieldCare configuration, if only one device is found, the corresponding Device DTM will open, see below.

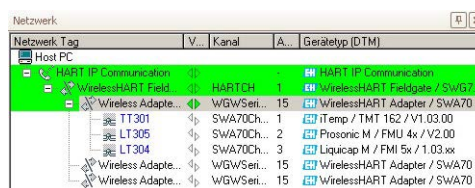

4. Repeat the process for all adapters in the network.
5. To open the Device DTM of an unconnected transmitter right-click on the Transmitter node and select Connect, then right-click again and select Online Parameterization.

7.4 User interface

The Web Server and DTM of the Fieldgate SWG70 are structured in the same manner, so that the configuration is identical. Before starting, the **Web Server** must be open, (see Chapter 7.1.1) or the **Online parameterization** dialog of the DTM must be open, see (Chapter 7.3.3). The user interface is structured as follows:

Structure	Chapter	Modbus	OPC	EtherNet/IP
Fieldgate configuration	Chapter 8			
Identification	Chapter 8.1	X	X	X
Wireless Communication	Chapter 8.2	X	X	X
Basic Setup and Advanced Setup	Chapter 8.2.1 and Chapter 8.2.2	X	X	X
Operating Modes	Chapter 8.2.3	X	X	X
Interfaces (wired communication)	Chapter 8.3	X	X	X
Ethernet	Chapter 8.3.1	X	X	X
Serial (RS-485)	Chapter 8.3.2	X	X	X
Protocols (wired communication)	Chapter 8.4			
Modbus via Ethernet or RS-485	Chapter 8.4.1	X		
EtherNet/IP via Ethernet	Chapter 8.4.2			X
HART via Ethernet or RS-485	Chapter 8.4.3	X	X	X
AMS via Ethernet	Chapter 8.4.4	X	X	X
Diagnostics	Chapter 9	X	X	X
Identification	Chapter 9.1	X	X	X
Wireless Communication	Chapter 9.2	X	X	X
Overview	Chapter 9.2.1	X	X	X
Details	Chapter 9.2.2	X	X	X
Burst Lists	Chapter 9.2.3	X	X	X
Topology View (Diagnostics)	Chapter 9.2.4	X	X	X
Wired Communication	Chapter 9.3	X	X	X
Overview	Chapter 9.3.1	X	X	X
HART	Chapter 9.3.2	X	X	X
Engineering	Chapter 10	X	X	X
Instrument List	Chapter 10.1	X	X	X
General	Chapter 10.1.1	X	X	X
Creating and editing an Instrument List	Chapter 10.1.2	X	X	X
Topology View (Engineering)	Chapter 10.2	X	X	X
Configuring Modbus	Chapter 10.3	X	X	
Modbus Settings	Chapter 10.3.1	X		
Input Status	Chapter 10.3.2	X		
Input Register	Chapter 10.3.3	X		
Configuring a WirelessHART OPC server	Chapter 10.4		X	
System architecture of an OPC WirelessHART network	Chapter 10.4.1		X	
Configuring the WirelessHART OPC server with "WirelessHART Fieldgate OPC Configurator"	Chapter 10.4.2		X	
Description of the WirelessHART Fieldgate OPC Configurator	Chapter 10.4.3		X	
Configuring bursts using the WirelessHART OPC server	Chapter 10.4.4		X	
EtherNet/IP configuration	Chapter 10.5			X
Setting up an EtherNet/IP connection	Chapter 10.5.1			X
Assigning data exchange connections via HART descriptors	Chapter 10.5.2			X
Burst commands for cyclic data exchange	Chapter 10.5.3			X
Integrating SWG70 into a PLC via EtherNet/IP	Chapter 10.5.4			X
Cyclic data exchange via the ControlLogix® controller system	Chapter 10.5.5			X
Connection parameters for cyclic data exchange	Chapter 10.5.6			X
Diagnostic bits in cyclic data exchange	Chapter 10.5.7			X

Structure	Chapter	Modbus	OPC	EtherNet/IP
Downstream Communication (for discreet field devices)	Chapter 10.6	X	X	
Substitution value (substitution value to DCS)	Chapter 10.7	X	X	
Burst message monitoring	Chapter 10.7.1	X	X	
Factory Acceptance Test (FAT)	Chapter 10.7.2	X	X	
Security – Whitelist, Temporary Join Key	Chapter 10.8	X	X	
Additional Functions	Chapter 11	X	X	X
Reset	Chapter 11.1	X	X	X
Self Test	Chapter 11.2	X	X	X
Firmware Upgrade (Web Server)	Chapter 11.3	X	X	X
Change Password (Web Server)	Chapter 11.4	X	X	X
Set DTM Addresses (DTM)	Chapter 11.5	X	X	X
Set Device Addresses (DTM)	Chapter 11.6	X	X	X
Upload Certificate (Web server)	Chapter 11.7	X	X	X
Auto Refresh	Chapter 11.7	X	X	
Measurement	Chapter 12	X	X	X

The Web interface differs from the DTM only in the presentation of the parameters. In the case of the Web interface, the parameters are presented in a single tree. In the case of the DTM, configuration, diagnostics and other functions are presented in separate DTM dialog boxes. To open the dialog boxes, you must right-click the Fieldgate SWG70 and select the desired option from the context menu. The DTM offers addition functions which are FDT-frame specific, e.g. Set Device Addresses. In both cases parameters are registered by pressing **Enter**. In some cases, in which more than one parameter is registered, an additional button must be pressed for the changes to take effect.

8 Fieldgate configuration

Parameter contains all parameters related to the set-up of Fieldgate SWG70. In the case of FieldCare, right-click **Fieldgate SWG70** and select **Online Parameterize**.

8.1 Identification

The parameters to be found in this leaf pertain to the identification of Fieldgate SWG70. The default parameters of Fieldgate SWG70 will appear in the appropriate input fields.

1. Click **Parameters => Identification** to display the associated parameters:

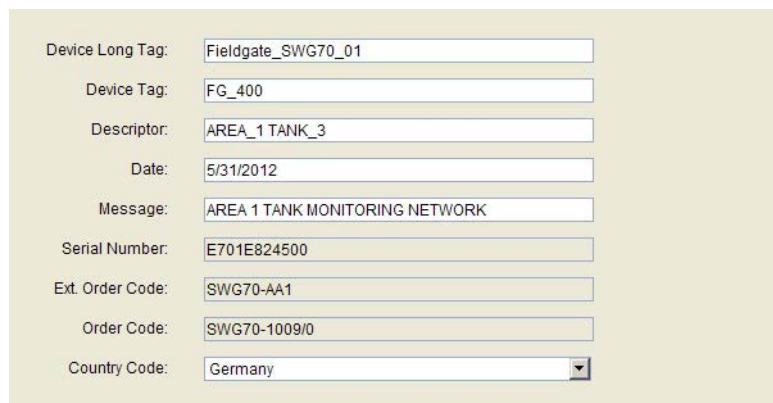

2. Enter at least a **Device Long Tag** and a **Device Tag**, pressing **Enter** to register the change.

Identification parameters

Parameter	Meaning	Default
Device Long Tag	Identifies Fieldgate within the plant network – Max. 32 character ASCII "Latin 1" string	–
Device Tag	Identifies Fieldgate within the plant network – Max. 8 character HART Packed ASCII string*	–
Descriptor	User text describing, e.g. function or location of Fieldgate SWG70 – Max. 16 character HART Packed ASCII string*	–
Date	Date in dd.mm.yyyy format; you can enter any date here, e.g. the date of the last configuration	01.04.2009
Message	User message, to be transmitted with information from the adapter – Max. 32 character HART Packed ASCII string*	–
Serial number	Indicates serial number of connected Fieldgate SWG70	–
Ext. Order Code	Indicates order code of connected Fieldgate SWG70	–
Order Code	Indicate order identification of the connected Fieldgate SWG70	–
Country Code	Country in which the Fieldgate is to be used - select from list – Governs the signal strength that can be set for the device	Germany
* Valid character set: @ A B C D E F G H I J K L M N O P Q R S T U V W X Y Z [\] ^ _ blank ! " # \$ % & ' () * + , - . / 0 1 2 3 4 5 6 7 8 9 : ; < = > ?		

8.2 Wireless Communication

8.2.1 Basic Setup

This leaf contains the parameters required to set up the WirelessHART communication offered by the Fieldgate SWG70.

1. Click **Parameter > Wireless Communication > Setup**, to display the associated parameters.

The screenshot displays the configuration page for the Fieldgate SWG70. The parameters are as follows:

- Network Tag: STERNENHOF
- Network Identification: 53574
- Join Key Part 1 of 4 (hex): *****
- Join Key Part 2 of 4 (hex): *****
- Join Key Part 3 of 4 (hex): *****
- Join Key Part 4 of 4 (hex): *****
- Execute Join: >>
- Real Time Clock Date: 3/7/2018
- Real Time Clock Time: 14:09:28.098
- Network start date: 2/17/2018
- Network start time: 11:44:14
- Network Access Mode: Open
- Radio Power: 10dBm
- Active Bandwidth Profile: Normal Bandwidth Profile
- Bandwidth Profile after Reform Network: Normal Bandwidth Profile
- Global Advertising Timeout: 5 min
- Activate Global Advertising: >>

Basic Setup parameters

Parameter	Meaning	Default
Network Tag	32-character network identification tag of Fieldgate SWG70	-
Network ID	Unique identification number of the network: Valid range 0-65535	1447
Join Key Part 1 of 4	User network password, 8 hexadecimal characters, Part 1 of 4	456E6472
Join Key Part 2 of 4	User network password, 8 hexadecimal characters, Part 2 of 4	65737320
Join Key Part 3 of 4	User network password, 8 hexadecimal characters, Part 3 of 4	2B204861
Join Key Part 4 of 4	User network password, 8 hexadecimal characters, Part 4 of 4	75736572
Execute Join	Click the button to download your changes and restart the network. The "Join Key" is sent to all network subscribers and changed.	-
RTC Date	Real time clock (RTC) – date, date setting for the network Enter the date in the following format: DD/MM/YYYY. The parameter is only available in the online mode.	-
RTC Time	Real time clock (RTC) – time, time setting for the network Enter the time in 24-hour format: hh:mm:ss. The parameter is only available in the online mode.	-
Network start date	Indicates the date on which the network was created	
Network start time	Indicates the time at which the network was created	
Allow New Devices	Determines whether new devices are allowed to join the network <ul style="list-style-type: none"> ■ All: any device can join the network ■ None: no device can join the network 	All
Radio Power	Determines power of the radio signal emitted by the device <ul style="list-style-type: none"> - Selection and default value depend on the Country Code - Observe local restrictions for 2.4 GHz equipment 	-
Bandwidth Profile	Determines Fieldgate's bandwidth profile	Normal
Global Advertising Timeout	Determines the period for global advertising on network start-up	-
Activate Global Advertising	Click this button to activate global advertising	-

NOTICE**NOTICE!**

- The **Join Key** parameters can only be entered when DIP switch 8 (inside the Fieldgate housing) is set to ON (factory default). See Chapter 6.1.3 "DIP switches" on page 29.

Basic Setup Procedure

1. Click on **Parameter => Wireless Communication => Setup**
2. Enter the following parameters, pressing **Enter** after each change:
 - **Network Tag**
 - **Network ID**
 - **Join Key Part 1 to Part 4.**
3. If your national regulations require it, set the **radio power** to OdBm (most allow 10 dBm).
4. Leave all other parameters at their default values, unless you want to activate global advertising and/or change the bandwidth profile.
5. Click the **Execute Join** button to download the join key.
 - The following message appears:

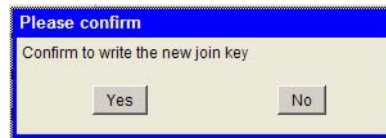

6. Click **Yes** to confirm.
 - The following message appears:

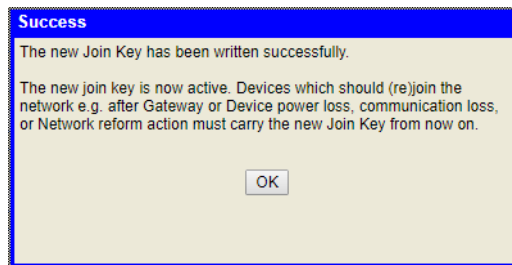

7. Click **OK** to acknowledge the message.
8. To start the network, select **Reform Network** in **Additional Functions > Reset**. See Chapter 11.1 "Reset" on page 106.
9. The wireless network is now up and running.

Bandwidth Profile

This option allows you to increase network performance by reducing network latency. If battery power is being used, this option increases energy consumption and reduces battery life. If a faster response time is more important than battery life, set the profile to medium or high.

To activate the profile, choose **Reform Network** in **Additional Functions => Reset**. See Chapter 11.1 "Reset" on page 106.

Global Advertising

If Global Advertising is activated, the Fieldgate and the network devices issue a series of identification messages at a rate higher than normal to identify new wireless devices and to reduce the network join time. The messages are sent until the **Global Advertising Timeout** is reached.

As Global Advertising increases energy consumption of the network devices it is recommended that it is activated only when needed, e.g. during the set up of the network.

1. Enter a **Global Advertising Timeout** (1 ... 255 minutes)
2. Click the **Activate Global Advertising** button; advertising starts immediately.

8.2.2 Advanced Setup

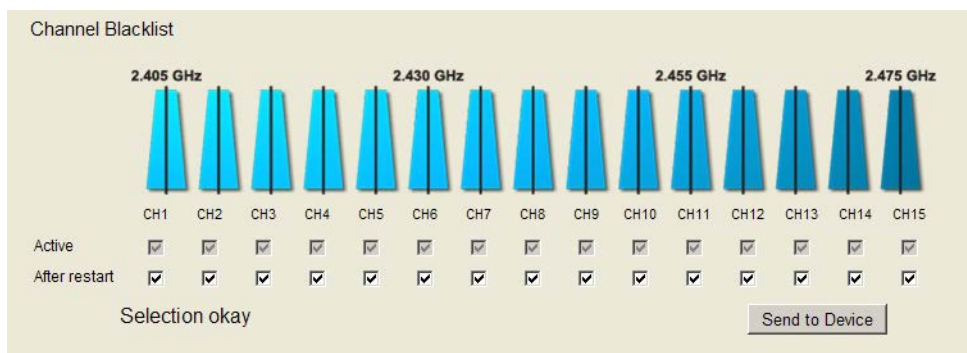

Channel Blacklist

With WirelessHART technology, Fieldgate SWG70 offers users a self-managed and self-healing wireless network. If several wireless networks are being operated at one location, the Fieldgate automatically selects the optimum channel assignment. If new networks are added, the channel assignment is adapted automatically.

Alternatively, you can also configure the channel assignment manually. Note that a WLAN/Wi-Fi channel based on the IEEE 802.11 standard is wider than a WirelessHART channel based on the IEEE 802.15.4 standard. The numbering of the channels is different for WLAN/Wi-Fi and WirelessHART.

Channel numbering WLAN/WiFi	Channel numbering WirelessHART
1	1 to 4
2	2 to 5
3	3 to 6
4	4 to 7
5	5 to 8
6	6 to 9
7	7 to 10

Channel numbering WLAN/WiFi	Channel numbering WirelessHART
8	8 to 11
9	9 to 12
10	10 to 13
11	11 to 14
12	12 to 15
13	13 to 15

Example: If the WLAN uses channel 5, channels 5 to 8 in the WirelessHART network must be disabled.

Disabling channels

1. Disable a channel by deactivating its check box in the Channel Blacklist.
 - The number of remaining active channels must be odd.
 - At least 5 channels must remain active.
2. Click **Send to Device** to transfer the updated blacklist settings to the Fieldgate.
 - Fieldgate stores the updated blacklist: the updated settings do not apply until the network is reformed.
3. Go to **Additional Functions > Reset**, and click **Reform Network** to apply the updated channel blacklist. See Chapter 11.1 "Reset" on page 106.







8.2.3 Operating Modes

Operating Modes contains a table listing all devices in the WirelessHART network together with their operation modes.

Whenever a wireless device joins the network, it is automatically inserted into the list, provided it is not already listed. Wired HART devices connected to a WirelessHART Adapter (SWA70) are also listed. The list retains all the devices Fieldgate has detected over the lifetime of the network, i.e. if a device is completely removed from the network, it will still be seen in the list. Such devices can be removed from the Operating Modes list by clicking on the button  which appears next to them.

- Click on **Parameter > Wireless Communication > Operating Modes** to display the table.

Operating Modes											Refresh
Long Tag	IO-Card	Channe...	Device Type	Com. Stat...	Dev. Status	Routing Device...	Fast Pipe	Force Identification	Flush Cache	Delete	
Fieldgate_SWG70_01	251	1	SWG70								
Wireless Adapter WA...	1	0	SWA70	<input checked="" type="checkbox"/>	<input checked="" type="checkbox"/>	<input checked="" type="checkbox"/>	<input type="checkbox"/>	<input type="checkbox"/>	<input type="checkbox"/>	<input type="checkbox"/>	
TT301	1	1	TMT162	<input checked="" type="checkbox"/>	<input checked="" type="checkbox"/>				<input type="checkbox"/>	<input type="checkbox"/>	
LT304	1	1	FM5x	<input checked="" type="checkbox"/>	<input checked="" type="checkbox"/>				<input type="checkbox"/>	<input type="checkbox"/>	
LT305	1	1	FMU4x	<input checked="" type="checkbox"/>	<input checked="" type="checkbox"/>				<input type="checkbox"/>	<input type="checkbox"/>	
Wireless Adapter WA...	2	0	SWA70	<input checked="" type="checkbox"/>	<input checked="" type="checkbox"/>	<input checked="" type="checkbox"/>	<input type="checkbox"/>	<input type="checkbox"/>	<input type="checkbox"/>	<input type="checkbox"/>	
TT303	2	1	TMT182	<input checked="" type="checkbox"/>	<input checked="" type="checkbox"/>				<input type="checkbox"/>	<input type="checkbox"/>	
Wireless Adapter WA...	3	0	SWA70	<input checked="" type="checkbox"/>	<input checked="" type="checkbox"/>	<input checked="" type="checkbox"/>	<input type="checkbox"/>	<input type="checkbox"/>	<input type="checkbox"/>	<input type="checkbox"/>	
PT306	3	1	CerabarS	<input checked="" type="checkbox"/>	<input checked="" type="checkbox"/>				<input type="checkbox"/>	<input type="checkbox"/>	

Parameter	Meaning
Long Tag	Identifies Fieldgate within the plant network <ul style="list-style-type: none"> – For HART 5.0 or less, this is the text in the Message parameter
IO card	Indicates the virtual I/O card number to which the device is mapped
Channel	Indicates the channel of the virtual I/O card to which the device is mapped
Device Type	Displays the device type as registered at the HART Communication Foundation
Status	Displays the communication status <ul style="list-style-type: none"> – <input checked="" type="checkbox"/> Connected –  Flashing: Device connected, being identified –  Continuous: Device connected but not identified –  Communication failure
Dev. Status	Displays the device status <ul style="list-style-type: none"> – <input checked="" type="checkbox"/> Good –  Out of specification –  Failure <p>Note that the device status that is displayed in the list may differ from the actual device status because the HART status bits may be interpreted differently.</p>
Routing Device	Indicates whether the device is allowed to act a routing device. <ul style="list-style-type: none"> ▪ To deactivate the routing functionality, deactivate the corresponding check box in the Routing Device column. ▪ This option enables you to set up a star network
Fast Pipe	Establishes a direct connection to a selected device. The fast pipe connection is about 4 times faster than a regular connection, which enables you to perform fast updates. <ul style="list-style-type: none"> ▪ Click on the check box to activate the Fast Pipe. <ul style="list-style-type: none"> – Note that you can activate the Fast Pipe option for only one device at a time.
Enforce Identification	Forces a device to resend its identification, for example if a communication failure occurred.
Flush Cache	Deletes the transmitted values.
Refresh	Click this button to reload the operational mode parameters of all network devices
Delete button 	Devices with no connection can be deleted by pressing the "Delete" button  .

8.3 Interfaces (wired communication)

All Fieldgate SWG70 versions feature an Ethernet interface and a serial interface. Depending on the device version, this interface can support different protocols.

Fieldgate SWG70 version	Interface	Protocol			
		Modbus	EtherNet/IP	HART	AMS
SWG70-xx-1 Modbus	Ethernet	X	-	X	X
	Serial (RS-485)	X	-	X	-
SWG70-xx-2 Modbus + OPC	Ethernet	X	-	X	X
	Serial (RS-485)	X	-	X	-
SWG70-xx-3 EtherNet/IP	Ethernet	-	X	X	X
	Serial (RS-485)	-	-	X	-

See this section for information about the interfaces. For information about the protocols, see Chapter 8.4 "Protocols (wired communication)" on page 50.

8.3.1 Ethernet

The parameters contained in this leaf pertain to the set up of the communication to the host via Ethernet interface offered by Fieldgate SWG70.

1. Click **Wired Communication > Interfaces > Ethernet** to display the associated parameters:

IP configuration mode (DHCP, DNS):

IP Address:

Netmask:

Gateway address:

DNS 1:

DNS 2:

MAC Address:

Write Ethernet Information:

2. Enter the parameters, pressing **Enter** after each change.
 - Note: Automatic IP address assignment requires that there is a DHCP server in the Ethernet network.
3. Click the **Write Ethernet Information** button when all parameters have been changed.
 - The Fieldgate will restart with the new parameters.
 - If the IP address was changed, communication will be lost.
 - Change your computer's address if necessary and re-establish communication with the new IP address.
 - If you are using the HART IP CommDTM, reconfigure the communication parameters, before making connection again. See Chapter 7.3.2 "Adding the Fieldgate SWG70" on page 36, Step 4.

Ethernet parameters

Parameter	Meaning	Default
IP Address Assignment (DHCP, DNS)	Specifies whether Fieldgate SWG70 IP network and DNS address is to be assigned manually or automatically. <ul style="list-style-type: none"> ▪ Manually: The settings in the dialog are used ▪ Automatically: The IP address of the DNS is assigned by a DHCP server 	Manually
IP Address	Sets fixed fieldgate IP network address for manual assignment mode	192.168.1.1
Netmask	Sets subnet mask IP network address for manual assignment mode	255.255.255.0
Gateway Address	Sets default gateway TCP/IP network address <ul style="list-style-type: none"> - This setting is currently not actively used by Fieldgate 	0.0.0.0
DNS 1	Sets preferred DNS server IP address for manual assignment mode <ul style="list-style-type: none"> - This setting is currently not actively used by Fieldgate 	0.0.0.0
DNS 2	Sets alternative DNS server IP address for manual assignment mode <ul style="list-style-type: none"> - This setting is currently not actively used by Fieldgate 	0.0.0.0
MAC Address	Displays the MAC address of the WirelessHART gateway. <ul style="list-style-type: none"> - Note that the MAC address is a characteristic of the device itself and cannot be changed. Each device has its own MAC address. 	-
Write Ethernet Information	Downloads the changed parameters to the Fieldgate <ul style="list-style-type: none"> - If the IP address was changed, communication will be lost - If the other addresses were changed, communication will be interrupted for a short period 	-

8.3.2 Serial (RS-485)

The parameters contained in this leaf pertain to the set up of the serial interface offered by Fieldgate SWG70.

1. Click **Wired Communication > Interfaces > Serial** to display the associated parameters:

Termination Resistor Selection:

Termination Resistor:

Protocol Selection:

2. Configure the serial interface for HART or Modbus RTU as required.
3. After configuration, set up the interface protocol parameters in the appropriate "Protocol" leaf.
 - Modbus serial allows access for one master. See Chapter 8.4.4 "AMS via Ethernet" on page 52.
 - HART serial allows access for one primary master and one secondary master. See Chapter 8.4.3 "HART via Ethernet or RS-485" on page 51.

Serial parameters

Parameter	Meaning	Default
Terminal Resistor Selection	Specifies whether hardware (DIP switch 6) or software termination settings are to be used	Software
Terminal Resistor	Sets the termination of the wireless fieldgate when Terminal Resistor Selection is set to Software <ul style="list-style-type: none"> - If "DIP-Switch" has been selected, this parameter displays this setting. 	Disconnected
Protocol Selection	Sets the protocol to be used over the serial port	Modbus RTU

8.4 Protocols (wired communication)

Equipped with interface. Depending on the Fieldgate SWG70 version, different protocols can be supported. For an overview see Chapter 8.3 "Interfaces (wired communication)" on page 48.

8.4.1 Modbus via Ethernet or RS-485

NOTICE

NOTICE!

- Section 10.2 is only relevant for Fieldgate versions with Modbus, order code: SWG70-xx-1 and SWG70-xx-2.

The parameters contained in this leaf pertain to the set up of the Modbus communication to the host on the interfaces offered by Fieldgate SWG70.

- Click **Wired Communication > Protocols > Modbus** to display the associated parameters:

The screenshot shows a configuration window for Modbus. It is divided into two sections: Serial and Ethernet. The Serial section includes dropdown menus for Bus Address Selection (set to Software), Baud Rate Selection (set to Software), Parity Bit (set to none), and Stop Bit (set to 1). Text input fields for Bus Address (1) and Baud Rate (19200) are also present. The Ethernet section includes a text input field for Port Number (502).

Modbus parameters

Parameter	Meaning	Default
Bus Address Selection	Specifies whether hardware (DIP switch 0-3) or software polling address settings are to be used	Software
Bus Address	Sets the HART address of the wireless fieldgate when Bus Address Selection is set to Software - When DIP-Switch is selected, displays the setting	1
Baud Rate Selection	Specifies whether hardware (DIP switch 4-5) or software baudrate settings are to be used ▪ DIP Switch Setting: 9600 Bit/s - 57600 Bit/s ▪ Software Setting: 1200 Bit/s - 115200 Bit/s	Software
Baud Rate	Sets the baudrate of the wireless fieldgate when Baud Rate Selection is set to Software - When DIP-Switch is selected, displays the setting	38400
Parity Bit	Sets the number of parity bits in the Modbus RTU telegram ▪ Odd, Even or None	Odd
Stop Bit	Sets the number of stop bits in the Modbus RTU telegram ▪ 1, 1.5 or 2	1
Port Number (Ethernet)	Sets Fieldgate port number for Modbus TCP transmission - If the port number is changed, the default port remains open - Modbus TCP allows access for up to five masters	502

8.4.2 EtherNet/IP via Ethernet

You do not need to make any settings for the EtherNet/IP protocol.

8.4.3 HART via Ethernet or RS-485

The parameters contained in this leaf pertain to the set up of the HART communication to the host on the interfaces offered by Fieldgate SWG70.

1. Click **Wired Communication => Protocols => HART** to display the associated parameters:

The screenshot shows a configuration window with two sections: 'Serial' and 'Ethernet'. Under 'Serial', there are four fields: 'Bus Address Selection' (dropdown menu set to 'Software'), 'Bus Address' (text input field containing '1'), 'Baud Rate Selection' (dropdown menu set to 'Software'), and 'Baud Rate' (dropdown menu set to '19200'). Under 'Ethernet', there is one field: 'Port Number' (text input field containing '5094').

2. If the default port number is changed, and FieldCare is in use, communication will be lost.
3. Reconfigure the HART IP CommDTM communication parameters, before making connection again. See Chapter 7.3.2 "Adding the Fieldgate SWG70" on page 36, Step 4.

HART parameters

Parameter	Meaning	Default
Bus Address Selection	Specifies whether hardware (DIP switch 0–3) or software bus address settings are to be used <ul style="list-style-type: none"> ■ DIP switch: 0 –15 ■ Software: 0 –63 	Software
Bus Address	Sets the HART address of the wireless fieldgate when Bus Address Selection is set to Software <ul style="list-style-type: none"> – When DIP-Switch is selected, displays the setting 	1
Baud Rate Selection	Specifies whether hardware (DIP switch 4–5) or software baudrate settings are to be used <ul style="list-style-type: none"> ■ DIP switch: 9600 Bit/s –57600 Bit/s ■ Software: 1200 Bit/s –115200 Bit/s 	Software
Baud Rate	Sets the baudrate of the wireless fieldgate when Baud Rate Selection is set to Software <ul style="list-style-type: none"> – When DIP-Switch is selected, displays the setting 	19200
Port Number	Sets the Fieldgate SWG70 Ethernet port number for HART via UDP/TCP transmission <ul style="list-style-type: none"> – If the port number is changed, the default port remains open – HART UDP allows access for two primary masters and two secondary masters – HART TCP allows access for one primary masters and one secondary master 	5094

8.4.4 AMS via Ethernet

If you would like to integrate Fieldgate SWG70 into Emerson's Asset Management System (AMS), this must be done via an Ethernet port. In rare cases you will need to change the port number. The default port setting is "33333".

1. Click **Wired Communication > Protocols > AMS**.

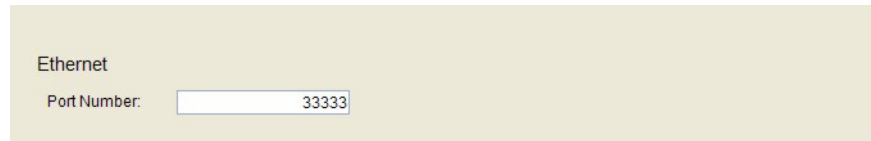

Ethernet

Port Number:

9 Diagnostics

Diagnosis contains all health and related information on Fieldgate SWG70. In FieldCare the corresponding function is called by right-clicking on the Fieldgate SWG70 node and selecting **Diagnostics**.

9.1 Identification

The **Identification** leaf contains information on the hardware and software of Fieldgate SWG70.

1. Click **Diagnostics > Identification** to display the associated parameters:

Device Long Tag:	Fieldgate_SWG70_01
Device Tag:	FG_400
Descriptor:	AREA_1 TANK_3
Date:	5/31/2012
Message:	AREA 1 TANK MONITORING NETWORK
Universal Command Revision:	7
Device Revision:	2
Software Revision:	25
Gateway Software Version:	01.05.00-rc4
Serial Number:	E701E824500
Ext. Order Code:	SWG70-AA1
Order Code:	SWG70-1009/0
Country Code:	Germany
Assembly Number:	0

Identification parameters

Parameter	Meaning
Device Long Tag	Identifies Fieldgate within the plant network
Device Tag	Identifies Fieldgate within the plant network
Descriptor	User text describing, e.g. function or location of Fieldgate
Date	Indicates a date
Message	User message, transmitted with information from Fieldgate SWG70
Universal Command Revision	Revision of the HART protocol supported by Fieldgate SWG70
Device Revision	HART Revision of device specific commands supported by Fieldgate SWG70
Software Revision	HART Software revision of Fieldgate SWG70
Gateway Software Versions	Indicates the firmware version installed in Fieldgate SWG70
Serial number	Indicates serial number of connected Fieldgate SWG70
Order Code	Indicates order code of connected Fieldgate SWG70
Order Ident	Indicate order identification of the connected Fieldgate SWG70
Country Code	Country Code to which Fieldgate SWG70 is set
Assembly Number	The assembly number of Fieldgate SWG70

9.2 Wireless Communication

The **Wireless Communication** leaf contains information on the operation of Fieldgate SWG70 within the wireless network.

9.2.1 Overview

Overview provides information about the I/O interfaces of the wireless network as well as network statistics.

1. Click **Diagnostics > Wireless Communication > Overview** to display the associated parameters:

"Wireless Communication - Overview" parameters

Parameter	Meaning
I/O System Capabilities	
Max. Card Number	Indicates the maximum number of cards in the I/O system. This corresponds to the maximum number of wireless devices that can be connected to the gateway.
Max. Channel Number	Indicates the maximum number of channels.
Max. Sub Dev. Number	Indicates the maximum number of sub devices that can be connected to a specific channel.
Number of Devices	Indicates the current number of subdevices. – Every device counts as a subdevice, no matter if it is a wireless device or a wired device connected to a WirelessHART Adapter (SWA70).
Lifetime Network Statistics	
Reliability	Ratio of the number of successful packet transmissions to the sum of the successful and permanently lost packet transmissions taken across the entire network
Stability	Ratio of the number of successful packet transmissions to the sum of the successful and unsuccessful packet transmissions taken across the entire network. – Unsuccessful transmissions are repeated for as many time as necessary using all communication paths available. If the repeat process is interrupted, e.g. by removing the device from the network, then the corresponding packets are counted as lost.
Latency	Average time taken for packets generated by the wireless devices to reach the gateway.
Lost Upstream Packages	Total number of packets generated by the wireless devices that were lost when transferred over the network.

9.2.2 Details

NOTICE

NOTICE!

- Diagnostic information is available only after the applicable statistics period has been completed (15 minutes). During this time, some information is set to 0 or replaced by wildcard characters.

Details shows all devices in the WirelessHART network together with their diagnostic information.

Whenever a wireless device joins the network, it is automatically inserted into the list if it is not already there. Wired HART devices connected to a WirelessHART Adapter (SWA70) are also listed. To remove a device from the list, use the Instrument List. See Chapter 10.1 "Instrument List" on page 62.

- Click on **Diagnostics > Wireless Communication > Details**:

Details														
Tree-View													Export	Refresh
Long Tag	IO-Card	Channel	Device Type	Com. Status	Dev. Status	Number of Joins	Join Time	Reliability	Latency	+/-	Neighbors	RSSI	Stability	
Fieldgate_SWG70_01	251	1	SWG70											
Wireless Adapter WAD...	1	0	SWA70	✓	✓	1	2012:10:5 13:25...	100 %	0.022 s		Fieldgate_SWG70...	-55 dBm	98.968941...	
				✓	✓						Wireless Adapter...	-25 dBm	100	
				✓	✓						Wireless Adapter...	-55 dBm	91.175948...	

Wireless Communication Details parameters

Parameter	Meaning
Tree-View	Deselect this option to sort devices by their sub-device index value
Instrument Identification	<p>Displays information identifying the device:</p> <ul style="list-style-type: none"> Long Tag: Long Tag of connected device IO card: Identifier of fieldgate card used by the device Channel: Identifier of card channel used by the device Device Type: Designation of connected device Status: Communication status of the associated device <ul style="list-style-type: none"> ✓ Connected ⚠ Flashing: Device connected, being identified ⚠ Continuous: Device connected but not identified ✖ Communication failure Dev. Status: Device status of the associated device <ul style="list-style-type: none"> ✓ Good ⚠ Out of specification ✖ Failure <p>Note that the device status that is displayed in the list may differ from the actual device status because the HART status bits may be interpreted differently.</p>
Number of Joins	Number of times the device has joined the network
Join Time	Date of the last time the device joined the network
Reliability	Percentage of the packets generated by the wireless devices that were correctly received by the gateway.
Latency	Average time taken for packets generated by the wireless devices to reach the gateway.
+/-	Show/hide the list of neighboring devices
Neighbors	Neighboring WirelessHART devices in reach of the selected device
RSSI	Indicates the power of the signal received from the selected device by the named neighboring device
Stability	Ratio of successful packet transmissions to the total number of packet transmissions on all wireless paths in the network
Refresh	Updates the instrument list
Export	Exports the details list to an Excel file

9.2.3 Burst Lists

Burst mode is a special mode of a HART slave device which allows it to periodically send the response to a selected HART command without the being polled by the master. For a WirelessHART slave device, it is the main operating mode. and can be used, for instance, to send the process values from an adapter or connected HART device to Fieldgate SWG70 at regular intervals.

The burst lists, contain information on the devices operating in this mode. The measured values sent by the devices can be viewed in the Measurement List. See Chapter 11 "Additional Functions" on page 106.

1. Click on **Diagnostics > Wireless Communication > Burst Lists**:

Burst Lists									Refresh
Long Tag	IO-Card	Channel	Device Type	Com. Status	Dev. Status	+/-	Burst command	Num Packets	
Fieldgate_SWG70_01	251	1	SWG70						
Wireless Adapter WAD_301	1	0	SWA70	☑	☑	-	Cmd 77	16	
				☑	☑		Cmd 33 Read Device Variables	2	
TT301	1	1	TMT162	☑	☑		Cmd 3 Read Dynamic Variables and Loop...	2	
LT304	1	1	FM5x	☑	☑		Cmd 3 Read Dynamic Variables and Loop...	6	
LT305	1	1	FMU4x	☑	☑		Cmd 3 Read Dynamic Variables and Loop...	7	
Wireless Adapter WAD_302	2	0	SWA70	☑	☑	-	Cmd 3 Read Dynamic Variables and Loop...	35	
				☑	☑		Cmd 77	33	
TT303	2	1	TMT182	☑	☑		Cmd 3 Read Dynamic Variables and Loop...	32	
Wireless Adapter WAD_303	3	0	SWA70	☑	☑	-	Cmd 3 Read Dynamic Variables and Loop...	3	
				☑	☑		Cmd 77	7	
PT306	3	1	CerabarS	☑	☑		Cmd 3 Read Dynamic Variables and Loop...	6	

Burst List parameters

Parameter	Meaning
Instrument Identification	Displays information identifying the device: <ul style="list-style-type: none"> ▪ Long Tag: Long Tag of connected device ▪ IO card: Identifier of fieldgate card used by the device ▪ Channel: Identifier of card channel used by the device ▪ Device Type: Designation of connected device ▪ Status: Communication status of the associated device <ul style="list-style-type: none"> - ☑ Connected - ⚠ Flashing: Devices connected, identification in progress - ⚠ Continuous: Devices connected but not identified - ❌ Communication failure ▪ Dev. Status: Device status of the associated device <ul style="list-style-type: none"> - ☑ Good - ⚠ Out of specification - ❌ Failure
+/-	Show/hide the burst list details
Burst Command	Command number of selected burst commands with explanation: <ul style="list-style-type: none"> ▪ 1: Returns the primary value and units ▪ 2: Returns the loop current and its associated percent of range. ▪ 3: Returns the loop current and up to four predefined dynamic variables and units (PV, SV, TV, QV) ▪ 9: Returns the value and status of up to eight device or dynamic variables with units ▪ 48: Returns the complete device status information ▪ 77: Embeds the commands of a connected wired device so that they can be transmitted by wireless
Num. Packets	Number of burst messages sent by the network device since the last network restart
Refresh	Updates the burst list

9.2.4 Topology View (Diagnostics)

Topology view is a graphical overview of all wireless devices within your network, including their connection status and connection paths. It is set up in **Engineering => Topology View**. See Chapter 10.2 "Topology View (Engineering)" on page 65.



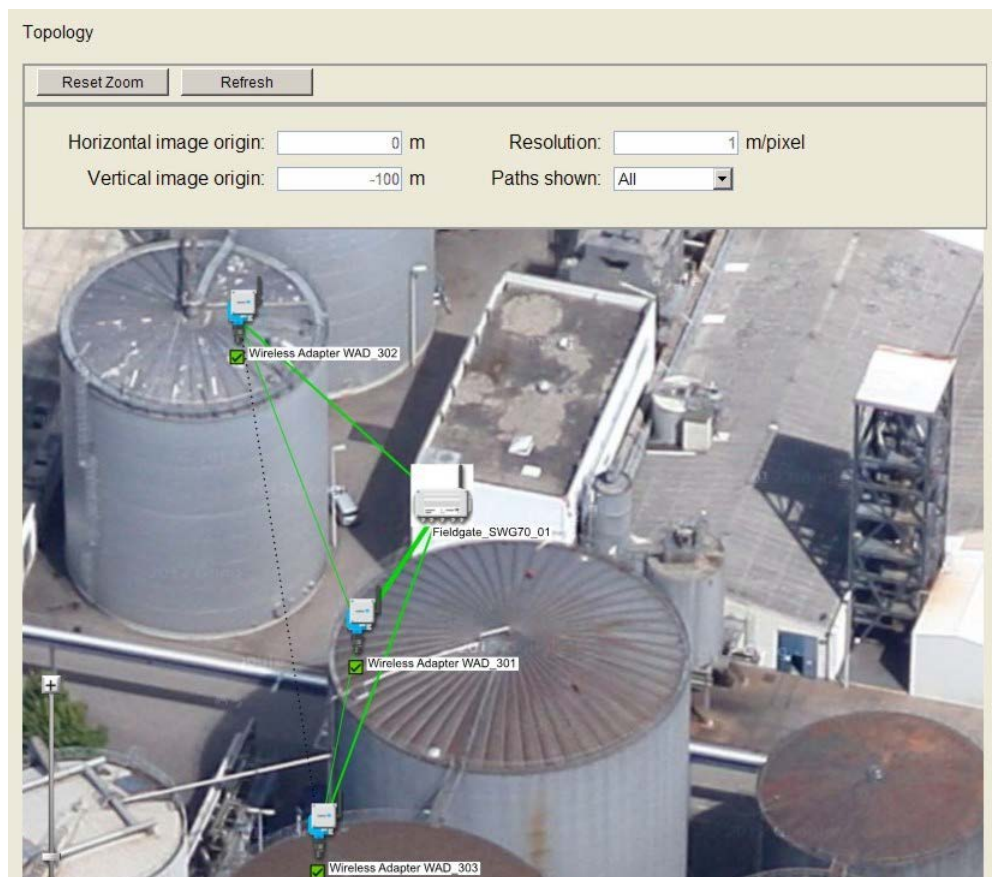











1. Click on **Diagnostics > Wireless Communication > Topology View** to open the dialog:

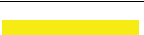

- The lines between the devices represent the connection paths.
 - The color and thickness indicate the connection quality respectively traffic for each connection path.
 - The significance of the colors, line thicknesses and other functions are to be found in the table which follows.
2. In the example above:
 - The most traffic flows between the Adapter WAD_301 and Fieldgate SWG70_01.
 - Less traffic flows between Adapter WAD_302 and WAD_303 respectively and Fieldgate SWG70_01 as well as between Adapter WAD_302 and WAD_303 respectively and Adapter WAD_301.
 - There is no traffic between Adapter WAD_302 and Adapter WAD_303, but the path is managed as a backup path in the event of one of the other paths failing.
 - The stability of all connections is good.
 3. Right-click on an adapter to display its network statistics.

Wireless Adapter WAD_302	
Reliability	100%
Latency	361ms
Number of Joins	2

Topology View parameters

Parameter	Meaning
Traffic	
	Dotted line: Path is unused at the moment
	Thin line: Path used by one third of connections
	Medium lines: Path used by two thirds of connections
	Thick line: Path used by all connections
Connection Quality	
	Signal Red: Signal stability 0 - 10% of maximum possible
	Red: Signal stability 10 - 20% of maximum possible
	Orange: Signal stability 20 - 30% of maximum possible
	Gold: Signal stability 30 - 40% of maximum possible
	Yellow: Signal stability 40 - 50% of maximum possible
	Lime: Signal stability 50 - 60% of maximum possible
	Light Green: Signal stability 60 - 70% of maximum possible
	Lawn Green: Signal stability 70 - 80% of maximum possible
	Bright Green: Signal stability 80 - 90% of maximum possible
	Green: Signal stability 90 - 100% of maximum possible
Operating elements	
Reset Zoom	Resets the zoom to show everything
Refresh	Updates the information on signal quality and traffic
Zoom rider - ----- +	Increases (+) or decreases (-) the magnification of the topology view
Horizontal image origin	Indicates the position of the horizontal origin of the image
Vertical image origin	Indicates the position of the vertical origin of the image
Resolution	Sets the resolution of the image
Paths shown	Selects the paths to be shown in the topology view <ul style="list-style-type: none"> - All: all paths are shown - In use: only those paths used by the network are shown - Selected: the paths associated with a device are shown when the cursor is moved to the said device - None: No paths are shown

9.3 Wired Communication

The **Wired Communication** leaf contains information on the communication interface used to connect to a supervisory system. It contains two submenus: **Overview** and **HART**.

9.3.1 Overview

Overview contains the performance parameters of the wired communication interface

1. Click on **Diagnostics => Wired Communication => Overview** to open the dialog:



Overview parameters

Parameter	Meaning
Messages received through HOST	Total number of messages received from the host since the start-up or last reset of Fieldgate SWG70.
Messages returned to HOST	Total number of messages returned to the host since the start-up or last reset of Fieldgate SWG70.
Number of requests forwarded to IO system	Total number of messages from the host forwarded to the devices in the wireless network since the start-up or last reset of Fieldgate SWG70.
Number of responses returned from IO system	Total number of messages for the host received from the devices in the wireless network since the start-up or last reset of Fieldgate SWG70.

9.3.2 HART

The HART page shows the possible statuses that may exist for HART devices in the network. A tick box beside each parameter indicates whether the described condition is currently valid.

- Click on **Diagnostics > Wired Communication > Overview** to open the dialog:

The screenshot displays a diagnostic dialog with the following sections and checkboxes:

- Extended Device Malfunction:**
 - Manager fault
 - Non-Volatile Memory Defect
 - Volatile Memory Defect
 - Ethernet communication fault
 - Electronic defect
 - RS-485 communication fault
- Gateway Operation in Progress:**
 - Block transfer
 - Delayed answer
 - Self-test
 - File update
 - Start-up phase
- Extended List changes:**
 - Instrument List Changed
 - Active Device List changed
- Cumulative Device Status:**
 - Primary Variable Out of Limits
 - Non-Primary Variable Out of Limits
 - Loop Current Saturated
 - Loop Current Fixed
 - More Status Available
 - Cold Start
 - Configuration Changed
 - Device malfunction
- Cumulative Extended Device Status:**
 - Maintenance Required
 - Device Variable Alert
 - Critical Power Failure
- Device Operation in Progress:**
 - "Configuration Changed bit reset" procedure
 - "Sub-Device update" procedure
 - "Device update" procedure

- In the case of the Cumulative Extended Device Status, the user must turn to the Wireless Communication Details list to get more information on the individual device status. See Chapter 9.2.2 "Details" on page 55.

**Wired Communication -
Details parameters**

Parameter	Parameter	Meaning
Extended Device Malfunction	Manager fault	Non-recoverable hardware fault: Fieldgate manager
	Non-Volatile Memory Defect	Non-recoverable hardware fault: Non-volatile memory
	Volatile Memory Defect	Non-recoverable hardware fault: Volatile memory
	Ethernet communication fault	Non-recoverable hardware fault: Ethernet controller fault
	Electronic defect	Non-recoverable hardware fault: Other case
	RS-485 communication fault	Non-recoverable hardware fault: RS-485 controller
Gateway Operation in Progress	Block transfer	Fieldgate transferring block
	Delayed answer	Fieldgate awaiting answer from device (buffer)
	Self test	Fieldgate is in self test mode, see Chapter 8.6.5
	File update	Fieldgate writing to non-volatile memory file
	Start-up phase	Fieldgate is starting up and building the network
Extended List changes	Instrument List Changed	Instrument list has changed since last refresh
	Active Device List Changed	Device list has changed since last refresh
Cumulative Device Status	Primary Variable Out of Limits	PV of a device in the network is out of limits
	Non-Primary Variable Out of Limits	SV, TV, QV of a device in the network is out of limits
	Loop Current Saturated	Loop current of a device in the network above 20 mA
	Loop Current Fixed	Loop current of a device in the network is fixed to 4 mA (multidrop mode)
	More Status Available	Device in the network has more status available flagged
	Cold Start	Device in the network has cold start flagged
	Configuration Changed	Configuration of a device in the network has changed
	Extended Device Malfunction	Device in the network has malfunctioned
Cumulative Extended Device Status	Maintenance required	The status "Maintenance required" has been set for a device in the network
	Device Variable Alert	The status "Device Variable Alert" has been set for a device in the network
	Critical Power Failure	The status "Critical Power Failure" has been set for a device in the network
Device Operation in Progress	"Configuration Changed bit reset" procedure	Fieldgate has reset the "Configuration Changes" bit of one of the devices
	"Sub-Device update" procedure	Fieldgate is carrying out the identification of a device connected to an adapter
	"Device update" procedure	Fieldgate is carrying out the identification of an adapter

10 Engineering

10.1 Instrument List

10.1.1 General

This leaf contains a list of instruments in the network. It is also possible to add individual devices that are still to be connected.

1. Click on **Engineering > Instrument List** to open the dialog:

Instrument List							
Export		Import		Refresh		Apply	
Index	Long Tag	IO-Card	Channel	Device ID	Extended Device Type Co...		
0	Wireless Adapter WAD_301	1	0	588011	11F0		✘
1	Wireless Adapter WAD_302	2	0	5C8009	11F0		✘
2	Wireless Adapter WAD_303	3	0	6E0072	11F0		✘
3	TT303	2	1	60822B	11C8		✘
4	TT301	1	1	31812C	11CA		✘
5	LT304	1	1	56028B	111D		✘
6	LT305	1	1	001A8B	1111		✘
7	PT306	3	1	6438AC	1118		✘

Instrument List parameters

Parameter/Field	Meaning
Instrument List	Displays tabular information identifying the device: <ul style="list-style-type: none"> ▪ Long Tag: Long Tag of connected device ▪ IO card: Identifier of fieldgate card used by the device ▪ Channel: Identifier of card channel used by the device ▪ Device ID: HART serial number that is assigned at manufacturing time and that differs for each HART device of a given type ▪ Extended Device Type Code: Unique code identifying the HART product family
Delete button ✘	Deletes a device from the instrument list <ul style="list-style-type: none"> - Click Apply to register the change in Fieldgate SWG70 - If the device is still communicating with the network, it will automatically reappear in the list at the next refresh - Caution! Deleting a device from the instrument list can change the Modbus register address if the Modbus addresses have been automatically generated.
Export/Export CSV	Exports the current instrument list as a CSV file
Import/Import CSV	Imports an instrument list that has been stored as a CSV file
Import Project Tree (DTM)	In Offline Parameterize dialog, imports the network view to the Instrument List
Refresh	Updates the instrument list <ul style="list-style-type: none"> - After switching on or resetting the device, wait at least one minute before pressing the Reset button.
Apply	Stores the current instrument list in Fieldgate SWG70

10.1.2 Creating and editing an Instrument List

Normally the Instrument List is only generated once the **Refresh** button is pressed after the network is up and running. It is possible, however, to create a list from scratch before any WirelessHART devices join the network. This allows the order in which the devices are displayed in the both the Instrument List and Operating Modes - and hence in the Modbus mapping - to be predetermined. The individual entries can also be edited.

NOTICE

NOTICE!

- When editing the instrument list, incomplete entries are highlighted in red. These data must be entered or corrected before the instrument list can be downloaded to Fieldgate SWG70.
- Entries marked with yellow already exist: the copies must be removed.

Procedure for Web Server

1. Click on **Engineering > Instrument List** to display the instrument list.
2. To add a device, click into the last row of the instrument list and enter the Long Tag of the device.

Index	Long Tag	I/O-Card	Channel	Device ID	Extended Device Type Co...	Delete
0	WirelessHART Adapter WAD_001	1	0	000000	1000	☒
1	PT101	1	1	000000	1000	☒
2	TT102	1	1	000000	1000	☒
3	WirelessHART Adapter WAD_002	2	0	000000	1000	☒
4	PT201	2	1	000000	1000	☒
5	WirelessHART Adapter WAD_003	3	0	000000	1000	☒
6	PT301	3	1	000000	1000	☒

3. Enter the following optional additional parameters by clicking on the appropriate field:
 - I/O Card to which the device should be attached.
 - Channel: adapters are assigned to Channel 0, devices to Channel 1.
 - Device ID: unique HART serial number assigned on manufacture of the device.
 - Extended Device Type Code: unique code identifying the HART family type. press **Enter** to confirm your entries.

NOTICE

NOTICE!

- If the values of the fields "Device ID" and "Extended Device Type Code" are unknown, "0" must be entered.
4. When the instrument list is complete, press **Apply** to download it to Fieldgate SWG70.
 5. When the devices join the network at a later time, they will be assigned to their allotted positions in the Operating Modes list.
 6. When all devices have joined the network, return to the **Instrument List** and press **Refresh** to import the latest list.
 7. Click **Export** to store a copy of the list on your computer as a CSV file.
 - The file can be re-imported into the Instrument List by pressing **Import** and navigating to the folder containing the file.

Procedure for FieldCare

In addition to the previous method, in FieldCare the instrument list can also be generated by importing a network tree created in off-line mode.

1. Create a FieldCare project. See Chapter 7.3.1 "Adding the HART IP CommDTM" on page 34 and see Chapter 7.3.2 "Adding the Fieldgate SWG70" on page 36
 - Put the **HART Communication IP CommDTM** and **Fieldgate SWG70 CommDTM** online.
2. Instead of scanning for devices use the **Add Device** context menu to add first an adapter, then the device or devices attached to it.
 - For WirelessHART devices without an adapter, just add the device.
3. Repeat Step 2 until the network is complete.
 - Edit the long tags so that they correspond to those stored in your devices.

Netzwerk Tag	Verb.	Kanal	A.	Gerätetyp (DTM)	Physikalisches Gerät
Host PC					
HART IP Communication				HART IP Communication	
WirelessHART Fieldgate FG_004		HARTCH	1	WirelessHART Fieldgate / SWG70 / V2.xx	
WirelessHART Adapter WAD_001		WGWSerialC...	15	WirelessHART Adapter / SWA70 / V2.xx	
PT101		SWA70Chan...	0	Cerabar S / PMx x3x / V7.1	
WirelessHART Adapter WAD_002		WGWSerialC...	15	WirelessHART Adapter / SWA70 / V2.xx	
PT201		SWA70Chan...	0	Delabar S / xMD x3x / V7.1	
FT202		SWA70Chan...	0	Promass / B3 / V3.01.0x	
LT203		SWA70Chan...	0	Microplot S / FMR 53x / V3.00	
WirelessHART Adapter WAD_003		WGWSerialC...	15	WirelessHART Adapter / SWA70 / V2.xx	
TT301		SWA70Chan...	0	tTemp / TMT 162 / V1.03.00	

4. Click on **Offline Parameterize > Engineering > Instrument List**, to display the empty instrument list.
 - You may have to enable the Engineering menu first.
5. Click **Import Project Tree** to import the network tree.

Index	Long Tag	IO-Card	Channel	Device ID	Extended Device Type Code	Delete
1	WirelessHART Adapter WAD_001	1	0	000000	0101	<input checked="" type="checkbox"/>
2	PT101	1	1	000000	0000	<input checked="" type="checkbox"/>
3	WirelessHART Adapter WAD_002	2	0	000000	0101	<input checked="" type="checkbox"/>
4	PT201	2	1	000000	0000	<input checked="" type="checkbox"/>
5	FT202	2	1	000000	0000	<input checked="" type="checkbox"/>
6	LT203	2	1	000000	0000	<input checked="" type="checkbox"/>
7	WirelessHART Adapter WAD_003	3	0	000000	0101	<input checked="" type="checkbox"/>
8	TT301	3	1	000000	0000	<input checked="" type="checkbox"/>

6. Click **Export CSV** to store the instrument list on your computer.
7. Close the **Offline Parameterize** dialog and open the **Online Parameterize** dialog.
 - Click on **Engineering > Instrument List** to display the empty instrument list.
8. Click **Import CSV** and import the file you have just created.
9. Click **Apply** to download the instrument list to the Fieldgate.
10. When the devices join the network at a later time, they will be assigned to their allotted positions in the Operating Modes list.
11. When all devices have joined the network, return to the **Instrument List** and press **Refresh** to import the latest list.
12. Click **Export** to store a copy of the list on your computer as a CSV file.
 - The file can be re-imported into the Instrument List by pressing **Import** and navigating to the folder containing the file.

10.2 Topology View (Engineering)

Topology view is a graphical overview of all wireless devices within your network, including their connection status and connection paths. The view set up in the dialog described here is shown in **Diagnosis => Wireless Communication => Topology View**, see Chapter 9.2.4.

1. Click on **Engineering > Topology View**, to open the dialog:

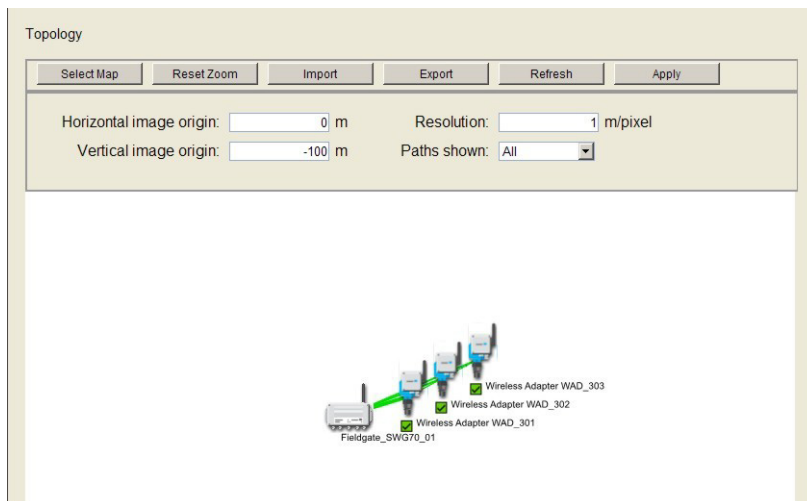

- The dialog opens with icons and long tags for Fieldgate SWG70 and all WirelessHART devices connected to the network positioned in a blank workspace.

Topology View parameters

Parameter	Meaning
Select Map	Uploads a map in .jpg format
Reset Zoom	Resets the zoom to the minimum value
Import	Uploads the current devices and positions from a CSV file
Export	Stores the current devices and positions in a CSV file
Refresh	Updates the information on signal quality and traffic
Zoom rider - ----- +	Increases (+) or decreases (-) the magnification of the topology view
Horizontal image origin	Indicates the position of the horizontal origin of the image
Vertical image origin	Indicates the position of the vertical origin of the image
Resolution	Sets the resolution of the image
Paths shown	Selects the paths to be shown in the topology view <ul style="list-style-type: none"> - All: all paths are shown - In use: only those paths used by the network are shown - Selected: the paths associated with a device are shown when the cursor is moved to the said device - None: No paths are shown

Topology View set-up

The WirelessHART devices are automatically added to the topology view. If required, click **Refresh** to reload the device information. Note that reloading the device information takes some time.

1. Click **Select Map**, to select a background image for the topology view.
 - For example, a satellite photo, a floor plan or a diagram.
 - The image must be in .jpg format.
2. In the dialog that now appears, click **Browse** to navigate to the background image.

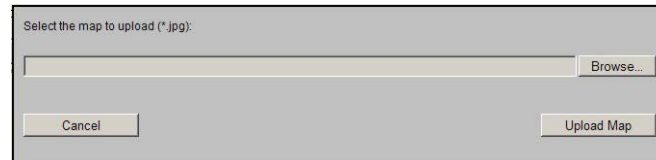

3. Click **Upload Map** to upload the background image.

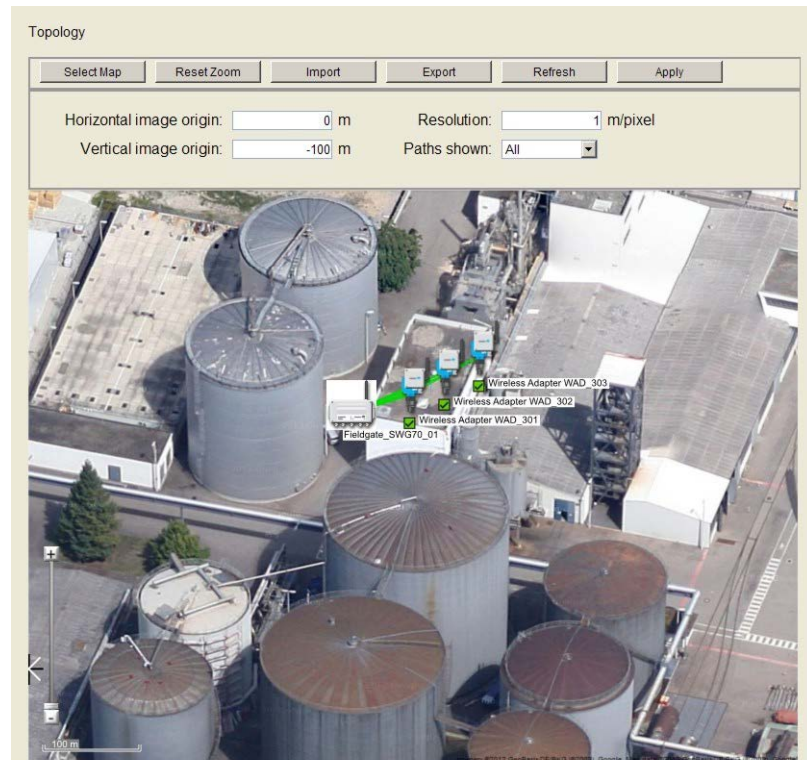

4. If required, edit the coordinates of the image origin in the **Horizontal Image Origin** and **Vertical Image Origin** boxes.
5. Enter a value in the **Resolution** box to scale the background image, for example 0.4 m/pixel.
6. Arrange the WirelessHART devices in the topology view by dragging and dropping the icons to a selected position.
 - For more accurate positioning use the slider to zoom in or out of the topology view.
 - Click **Reset Zoom** to reset the zoom so that all parts become visible.

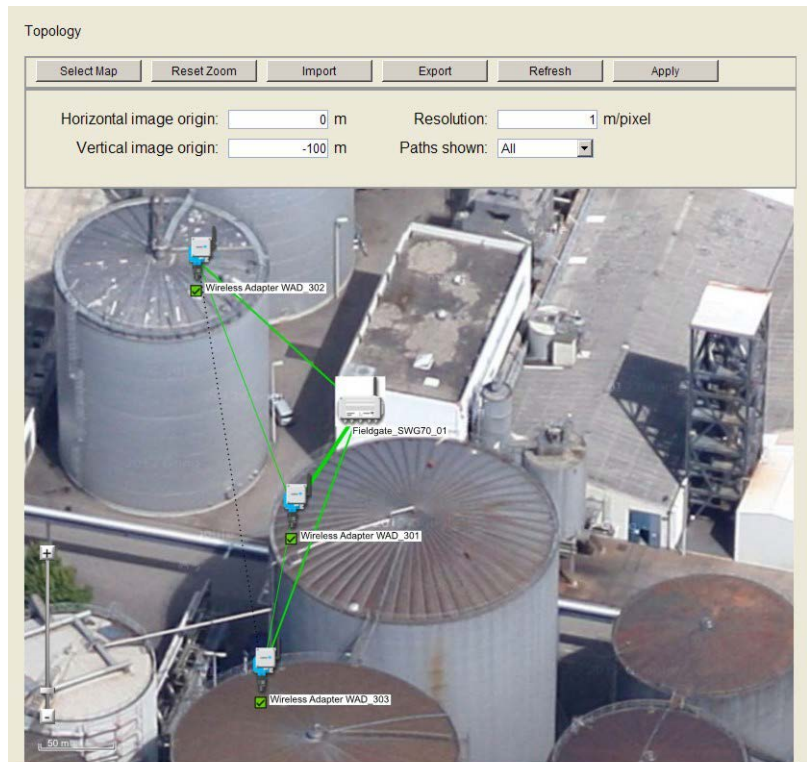

7. When the Topology View has been set up, click **Apply** to store it in Fieldgate SWG70.

Export and Import

1. To export the current devices and their positions to a CSV file, click **Export**.
2. To load a list of devices and their positions from a CSV file, click **Import**.

10.3 Configuring Modbus

NOTICE

NOTICE!

- The "Modbus" function is only available on WirelessHART Fieldgate models with versions "SWG70-xx-1-xx-xx" and "SWG70-xx-2-xx-xx". See Chapter 2.3 "Ordering information" on page 10.

10.3.1 Modbus Settings

Modbus Settings determines how the Modbus information is to be transmitted by Fieldgate SWG70 and where the information is to be found. It also allows the selection of automatic or manual mapping. The set-up of the Modbus communication parameters (address, baud-rate etc.) is described in Chapter 8.4.4.

More details on the Modbus Interface itself and the way in which the HART parameters are mapped to the Modbus registers is to be found in. See Chapter 16 "Modbus Interface" on page 118.

1. Click on **Engineering > Modbus Mapping > Modbus Settings** to open the dialog:

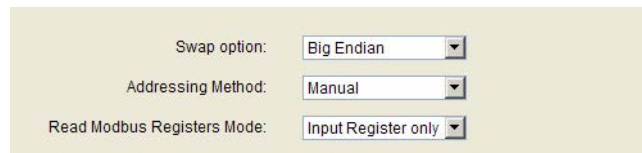

Modbus parameters

Parameter	Meaning	Example	Default												
Swap Option	<p>Selects frame format swap option for Modbus data transmission (see also Chapter 16.1.3)</p> <ul style="list-style-type: none"> ■ Big Endian: no swap; <table border="0" style="margin-left: 20px;"> <tr> <td>Register 0</td> <td>Register 1</td> </tr> <tr> <td>Source bytes: [0xABCD]</td> <td>[0xEFGH]</td> </tr> <tr> <td>Target bytes: [0xABCD]</td> <td>[0xEFGH]</td> </tr> </table> ■ Little Endian: Register swap; <table border="0" style="margin-left: 20px;"> <tr> <td>Register 0</td> <td>Register 1</td> </tr> <tr> <td>Source bytes: [0xABCD]</td> <td>[0xEFGH]</td> </tr> <tr> <td>Target bytes: [0xEFGH]</td> <td>[0xABCD]</td> </tr> </table> <p>The Swap Option does not apply to the Input Status registers</p>	Register 0	Register 1	Source bytes: [0xABCD]	[0xEFGH]	Target bytes: [0xABCD]	[0xEFGH]	Register 0	Register 1	Source bytes: [0xABCD]	[0xEFGH]	Target bytes: [0xEFGH]	[0xABCD]	Big Endian	Big Endian
Register 0	Register 1														
Source bytes: [0xABCD]	[0xEFGH]														
Target bytes: [0xABCD]	[0xEFGH]														
Register 0	Register 1														
Source bytes: [0xABCD]	[0xEFGH]														
Target bytes: [0xEFGH]	[0xABCD]														
Addressing Method	<p>Selects whether the mapping is to be done automatically or manually</p> <ul style="list-style-type: none"> ■ Auto: Mapping is done automatically according to the rules described in Chapter 16.2 <ul style="list-style-type: none"> - There is no automatic mapping of Input Status - The dialogs Input Status and Input Registers are deactivated ■ Manual: Mapping is done manually or semi-automatically in the Input Status and/or Input Register dialogged 	Manual	Auto												
Read Modbus Registers Mode	<p>Determines in which registers the mapping is to be done</p> <ul style="list-style-type: none"> ■ Input Registers only: Values mapped to Input Registers 300001 to 365536 ■ Input and Holding Values mapped to Input Registers 300001 to 365536 and Holding Registers 400001 to 465536 	Inactive	Inactive												

10.3.2 Input Status

Input Status allows the Modbus mapping of a device with single or multiple binary inputs. As Fieldgate SWG70 supports extended registers, values are normally assigned to the registers with the reference addresses 100001 to 165536. The reference addresses are obtained by adding the register number to 100,000. The dialog checks for completeness of entries (line turns red if not correctly filled out) as well as double assignment to the registers (line turns yellow).

The algorithm assumes that the discrete device delivers a maximum of 256 packed discrete values, each comprising 16 bits of an unsigned Integer16 (UINT16). Each bit represents a unique input status. Fieldgate first splits the data into two bytes, and reserves 8 registers for each byte, i.e. one for each bit contained.

- Least significant byte (Bits 0 - 7) maps e.g. to registers 100001 - 100008
- Most significant byte (Bits 8 - 15) maps e.g. to registers 100009 - 100016

The value entered after the byte selection determines which of the packed discrete values is to be mapped, e.g. 0 will map the first set of packed discrete values and 15 the sixteenth set of packed discrete values. More information is to be found in Appendix 16.2.2.

NOTICE

NOTICE!

- Some HART devices map their binary values and status as PV in HART CMD 3. In this case the value and status information will be found in the appropriate Input or Holding Register. See Chapter 10.3.3 "Input Register" on page 73.
- If a device status is mapped as UINT8 in the input status register, the status will only be found in one of the bit registers, e.g. in bit 0. The UINT8 is stored as a 16-bit value, the MSB is populated with "0", see Appendix 16.1.3.

1. Click on **Engineering > Modbus Mapping > Input Status** to open the dialog:



2. Click on **Generate** to open the Generate tab.

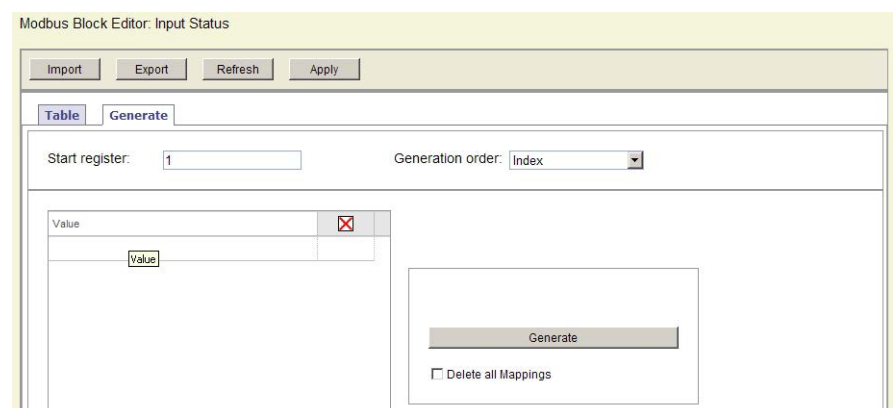

Input Status parameters

Parameter	Meaning	Example	Default
Table			
Registers	Defines the start register for the Digital I/O device values <ul style="list-style-type: none"> - For Input Status the first value is normally 10000 - The initial value can be overwritten only after a device has been selected in the Long Tag drop-down menu - Subsequent start registers are automatically generated 	1	1
End Register	End register for Digital I/O device values (generated automatically)	8	65536
Long Tag	Click to open a drop-down list of connected network devices	-	-
IO-Card	Identifier of fieldgate card used by the device	-	-
Channel	Identifier of card channel used by the device	-	-
Value	Click to open a drop-down list of values for the selected device <ul style="list-style-type: none"> - Least Significant Byte: maps bits 0 - 7 of a UINT16 to one register each - Most Significant Byte: maps bits 8 - 15 of a UINT16 to one register each 	-	-
Value field	Enter an appropriate value into the field (0 to 7) <ul style="list-style-type: none"> - which opens when a value is selected - 0: the 1st discrete value of a device is mapped ... 255: the 256th discrete value of a device is mapped 	0	0
Delete button <input checked="" type="checkbox"/>	Depending upon position, deletes the table or the table line	-	-
Generate			
Start Register	Defines the start register for the first Digital I/O device <ul style="list-style-type: none"> - For Input Status the first value is normally 1 	1	1
Generation Order	Order in which the devices are mapped to the Modbus registers. <ul style="list-style-type: none"> ▪ Index: According to the index number, see Instrument List, for example, Chapter 10.1 ▪ Alphabetical: In alphabetical order according to the Long Tag ▪ Alphabetical (sub-device): In alphabetical order according to the Long Tag of the sub-device. ▪ IO card & channel: According to the IO card & channel number of the wireless device. ▪ IO card & channel (sub-device): According to the IO card & channel number of the sub-device. 	-	-
Value	Click to open a drop-down list of values for the selected device <ul style="list-style-type: none"> - Least Significant Byte: maps bits 0 - 7 of a UINT16 to one register each - Most Significant Byte: maps bits 8 - 15 of a UINT16 to one register each 	-	-
Value field	Enter an appropriate value into the field <ul style="list-style-type: none"> - which opens when a value is selected - 0: the 1st discrete value of a device is mapped ... 255: the 256th discrete value of a device is mapped 	0	0
Delete button	Depending upon position, deletes the table or the table line	-	-
Generate	Writes mapping table to table in Table tab	-	-
Delete all mappings	<ul style="list-style-type: none"> ▪ Checked: Overwrites any table already in Table tab ▪ Unchecked: Adds any new devices found to existing table. 	-	-
Operating elements			
Import	Imports a mapping table in CSV format	-	-
Export	Exports the current mapping table in CSV format	-	-
Refresh	Loads the mapping table currently stored in Fieldgate SWG70	-	-
Apply	Stores the current mapping table to Fieldgate SWG70	-	-

Semi-automatic generation of Input Status mapping table

1. Click on the **Generate** tab to open the Generate dialog:

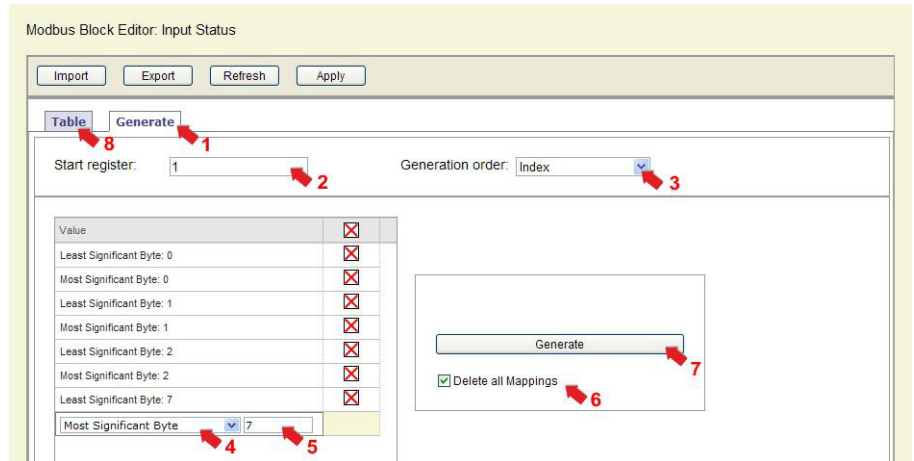

2. Enter an offset value in the **Start register** field.
 - For a typical application the start value is normally 1.
3. Select the order in which the devices are to be mapped to the Modbus registers in the **Generation order** drop-down list.
4. Select the values you want to read for each device in the **Value** column.
 - Least Significant Byte will map Bits 0 - 7 of an UINT16
 - Most Significant Byte will map Bits 8 - 15 of an UINT16
5. Enter the index of the UINT16 to be mapped (0 or 15) into the value field which now opens.
6. Repeat Steps 4 and 5 for all UINT16.
7. If required, check the **Delete all Mappings** checkbox to overwrite any existing mappings.
 - If the box is unchecked, any new devices found will be added to an existing table.
8. Click **Generate** to write the mapping to the table on the **Table** tab.
9. Click the **Table** tab to view the generated mapping table.

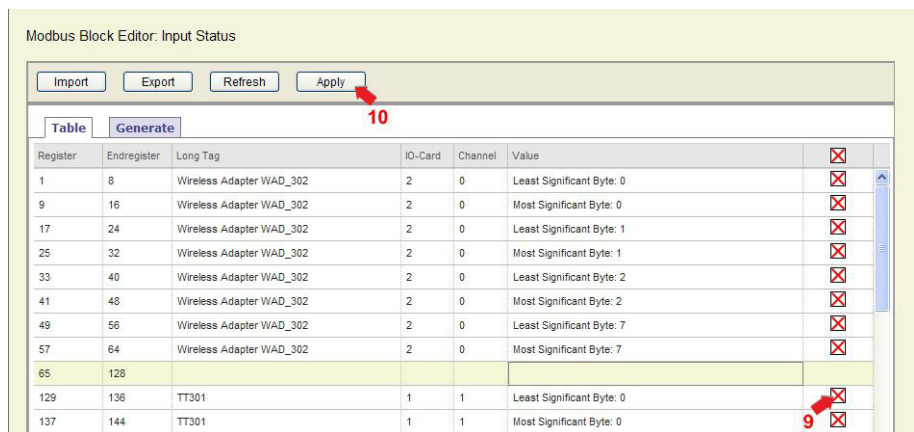

10. Manually edit the generated mapping table by deleting unwanted entries with the Delete button., e.g. all analog devices.
 - The registers occupied by the deleted entries remain free.
11. After the mapping table is complete, click **Apply** to store the table in Fieldgate SWG70.

Manual entry of an Input Status mapping table

1. Click on the **Table** tab to open the Table dialog:

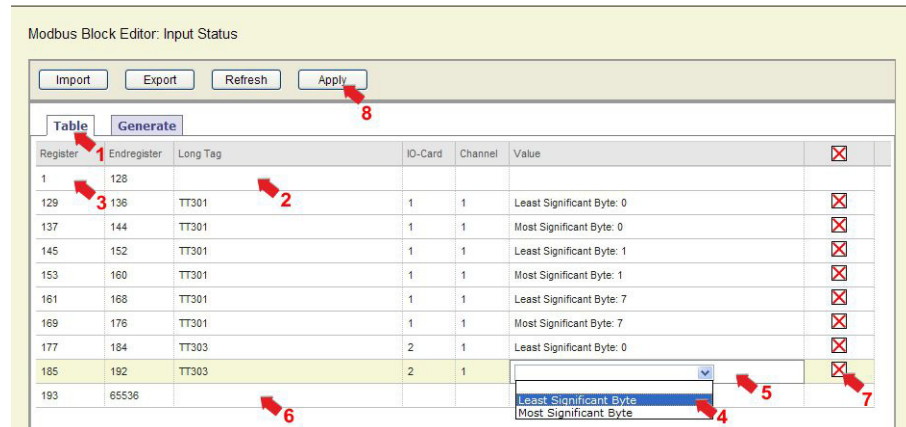

2. Select a device from the drop-down menu that appears when the **Long Tag** field is clicked.
3. Enter an offset value in the **Register** field.
 - For a typical application the start value is normally 1.
 - Offset values > 1: only values (n + 1) are allowed, where n is divisible by 8.
 - For the first device entered, an extra field will be added for the registers 0 to e.g. 200 that lie before the entered value.
 - The line turns red if information is missing.
 - and remains so until all entries are made.
 - For subsequent entries, missing values are outlined in red.
4. Select the value you want to read for the device in the **Value** column.
 - Least Significant Byte will map Bits 0 - 7 of an UINT16
 - Most Significant Byte will map Bits 8 - 15 of an UINT16
5. Enter the index of the UINT16 to be mapped (0 or 15) into the value field which now opens.
6. Repeat Steps 2, 4 and 5 for all other devices.
7. If required, manually edit the generated mapping table by deleting unwanted entries with the Delete button.
8. After the mapping table is complete, click **Apply** to store the table in Fieldgate SWG70.

Import and Export of mapping tables

The export/import functionality can be useful if you want to create the mapping table using a spreadsheet program, or if you want to import a backup of an existing mapping table.

1. To export the current mapping table to a CSV file, click **Export**.
2. To load the mapping table from a CSV file, click **Import**.
 - Click **Apply** to store the imported mapping table in Fieldgate SWG70.
3. To reload the mapping table currently used by Fieldgate SWG70, click **Refresh**.

10.3.3 Input Register

Input Register allows the Modbus mapping of Fieldgate SWG70 and the connected HART devices. As Fieldgate SWG70 supports extended registers, values are normally assigned the Input Registers with the reference addresses 300001 to 365536. In the case of some Modbus systems values must be assigned to the holding registers with reference addresses 400001 to 465536, see **Read Modbus Registers Mode** in Section 10.2.1. The dialog checks for completeness of entries (line turns red if not correctly filled out) as well as double assignment to the registers.

1. Click on **Engineering > Modbus Mapping > Input Register** to open the dialog:

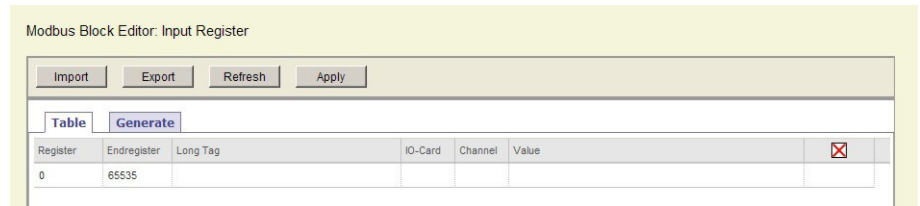

2. Click on **Generate** to open the Generate tab.

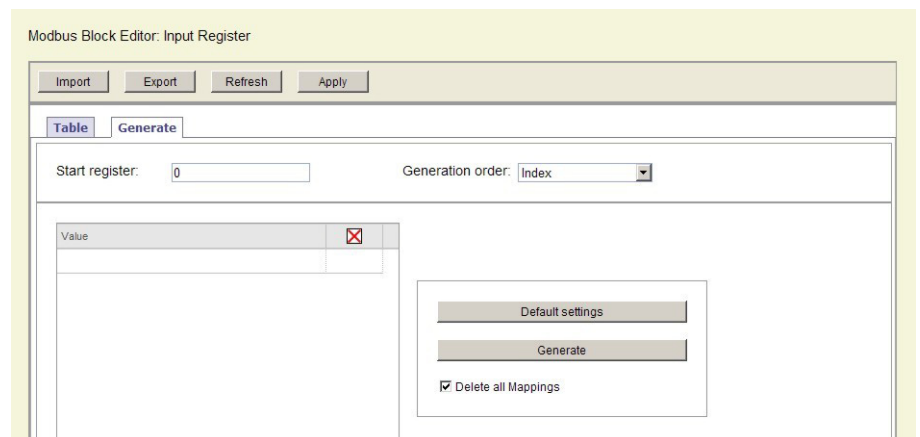

Input Register parameters

Parameter	Meaning	Example	Default
Table			
Registers	Defines the start register for the HART device value <ul style="list-style-type: none"> For Input Register the first value is normally 1 The initial value can be overwritten only after a device has been selected in the Long Tag drop-down menu Subsequent start registers are automatically generated 	13	1
End Register	End register for Digital I/O device values (generated automatically)	14	65536
Long Tag	Click to open a drop-down list of connected network devices	-	-
IO-Card	Identifier of fieldgate card used by the device	-	-
Channel	Identifier of card channel used by the device	-	-
Value	Click to open a drop-down list of values for the selected device	-	-
Delete button <input checked="" type="checkbox"/>	Enter an appropriate value into the field <ul style="list-style-type: none"> which opens when a value is selected 		
Generate			
Start Register	Defines the start register for the HART device value <ul style="list-style-type: none"> For Input Registers this is normally 1, depending on the Modbus system in use 	13	1
Generation Order	Order in which the devices are mapped to the Modbus registers. <ul style="list-style-type: none"> Index: According to the index number, see Instrument List, for example. See Chapter 10.1 "Instrument List" on page 62. Alphabetical: In alphabetical order according to the Long Tag Alphabetical (sub-device): In alphabetical order according to the Long Tag of the sub-device. IO card & channel: According to the IO card & channel number of the wireless device. IO card & channel (sub-device): According to the IO card & channel number of the sub-device. 	-	-
Value	Click to open a drop-down list of values for the selected device	-	-
Value field	Enter an appropriate value into the field <ul style="list-style-type: none"> which opens when a value is selected 	0	0
Delete button <input checked="" type="checkbox"/>	Depending upon position, deletes the table or the table line	-	-
Default Settings	Adds all HART Command 3 values to the value list, see See Chapter 16 "Modbus Interface" on page 118.	-	-
Generate	Writes mapping table to table in Table tab	-	-
Delete all mappings	<ul style="list-style-type: none"> Checked: Overwrites any table already in Table tab Unchecked: Adds any new devices found to existing table. 	-	-
Operating elements			
Import	Imports a mapping table in CSV format	-	-
Export	Exports the current mapping table in CSV format	-	-
Refresh	Loads the mapping table currently stored in Fieldgate SWG70	-	-
Apply	Stores the current mapping table to Fieldgate SWG70	-	-

Semi-automatic generation of Input Register mapping table

1. Click on the **Generate** tab to open the Generate dialog:

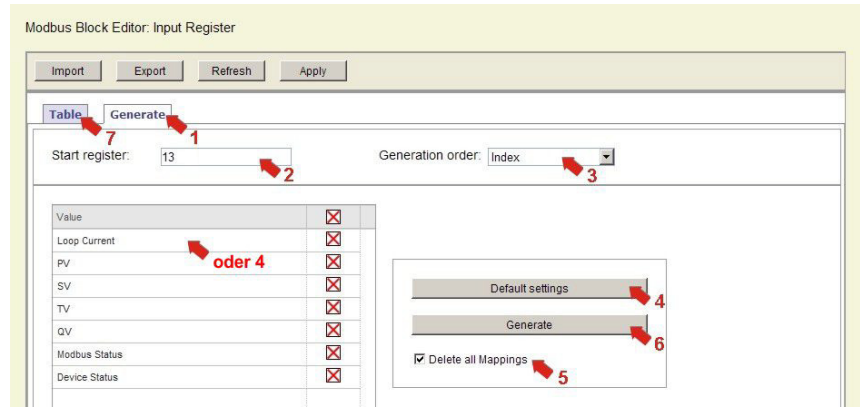

2. Enter an offset value in the **Start register** field.
 - For a typical application, e.g. monitoring of device values only, the Start value is normally 1.
 - If you intend to monitor Fieldgate SWG70 values, enter 13, in order to leave space for the Fieldgate values.
3. Select the order in which the devices are to be mapped to the Modbus registers in the **Generation order** drop-down list.
4. Click **Default Settings** to automatically load HART CMD 3 values as well as device and status information into the value list
 - Alternatively click in the value field and choose the values you require.
 - Note that the list will be replicated for all devices, so some editing may be required later.
5. If required, check the **Delete all Mappings** checkbox to overwrite any existing mappings.
6. If the box is unchecked, any new devices found will be added to an existing table.
7. Click **Generate** to write the mapping to the table on the **Table** tab.
8. Click the **Table** tab to view the generated mapping table.

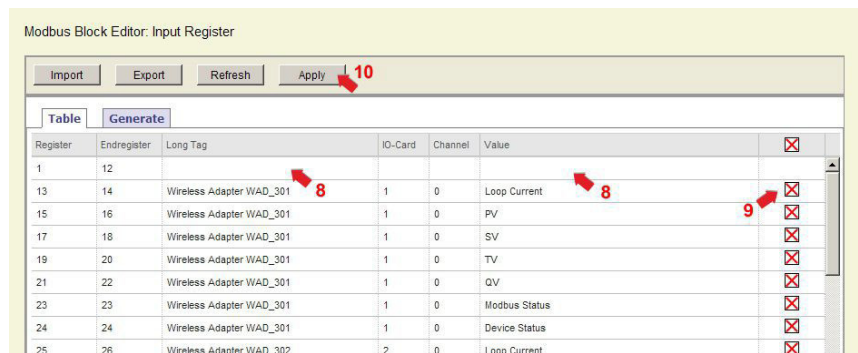

9. If you want to add Fieldgate SWG70 to the mapping table:
 - Select Fieldgate SWG70 in the Long Tag drop down menu.
 - Select a value from the value list.
 - Repeat the selection for as many Fieldgate SWG70 values as you wish to map.
10. If required, manually edit the generated mapping table by deleting unwanted entries with the Delete button.
11. After the mapping table is complete, click **Apply** to store it in Fieldgate SWG70.

Manual entry of an Input Register mapping table

1. Click on the **Table** tab to open the Table dialog:

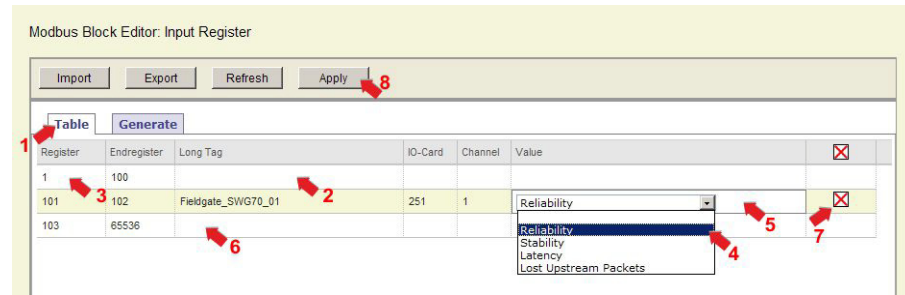

2. Select a device from the drop-down menu that appears when the **Long Tag** field is clicked.
3. Enter an offset value in the **Register** field.
 - Offset value >1: For the first device entered, an extra field will be added for the registers 0 to e.g. 200 that lie before the entered value.
 - The line turns red if information is missing.
 - and remains so until all entries are made.
 - For subsequent entries, missing entries are outlined in red.
4. Select the value you want to read for the device in the **Value** column.
 - If you select **CMD 48 Device Status** enter a response byte as well.
 - More information: see CMD48 Read Additional Status Information, Appendix 16.3.3.
5. Repeat Steps 2, 4 and 5 for all other devices.
6. If required, manually edit the generated mapping table by deleting unwanted entries with the Delete button.
7. After the mapping table is complete, click **Apply** to store the table in Fieldgate SWG70.

Import and Export of mapping tables

The export/import functionality can be useful if you want to create the mapping table using a spreadsheet program, or if you want to import a backup of an existing mapping table.

1. To export the current mapping table to a CSV file, click **Export**.
2. To load the mapping table from a CSV file, click **Import**.
3. Click **Apply** to store the imported mapping table in Fieldgate SWG70.
4. To reload the mapping table currently used by Fieldgate SWG70, click **Refresh**.

10.4 Configuring a WirelessHART OPC server

The WirelessHART OPC server for Fieldgate SWG70 can be easily configured with the program "WirelessHART Fieldgate OPC Configurator", which is to be found on the data medium supplied.

NOTICE

NOTICE!

- The "WirelessHART OPC server" function is only available on WirelessHART Fieldgate models with the version "SWG70-xx-2". See Chapter 2.3 "Ordering information" on page 10.

For information on operating the program see Chapter 10.4.2 "Configuring the WirelessHART OPC server with "WirelessHART Fieldgate OPC Configurator" on page 78. For a description of the program see Chapter 10.4.3 "Description of the WirelessHART Fieldgate OPC Configurator" on page 81.

10.4.1 System architecture of an OPC WirelessHART network

The following figure shows a typical architecture with the WirelessHART OPC server.

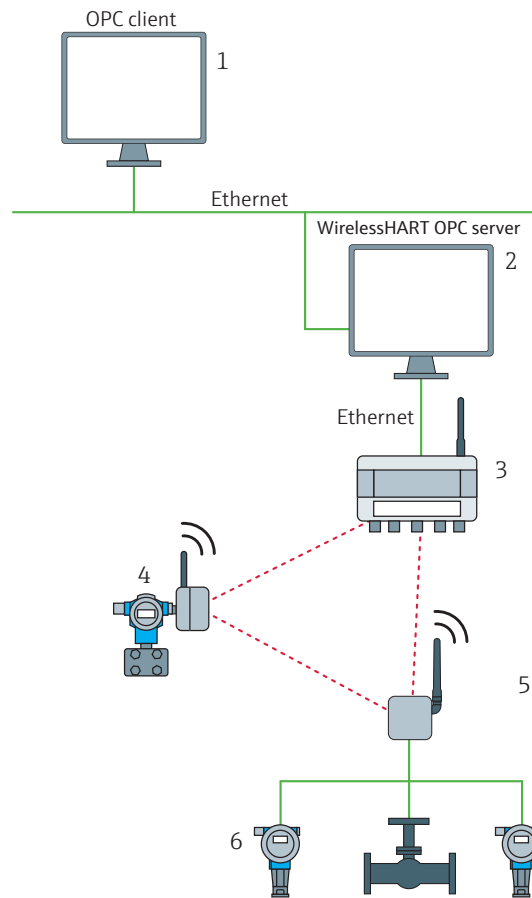

Fig. 10-1: System architecture of an OPC WirelessHART network

- | | | | |
|---|--|---|--------------------------------------|
| 1 | Computer as OPC client with OPC tunnel application, OPC tunnel application. See Chapter "OPC tunnel" on page 78. | 3 | Fieldgate SWG70 |
| 2 | Computer as WirelessHART OPC server with OPC tunnel application and the program "WirelessHART Fieldgate OPC Configurator". The program generates the necessary OPC configuration data for the communication with Fieldgate SWG70 | 4 | Field device with antenna (adapter) |
| | | 5 | WirelessHART-Adapter SWA70 (adapter) |
| | | 6 | Field devices (subdevices) |

OPC tunnel

An OPC tunnel is required in the following case:

- The WirelessHART OPC server and OPC client are running on different PCs. that are managed in different domains.

An OPC tunnel is not required in the following cases:

- The WirelessHART OPC server and OPC client are running on the same computer.
- The WirelessHART OPC server and OPC client are running on different computers, but the computers are managed in the same domain.

In this way, configuration problems due to DCOM security settings and DCOM interruptions are avoided.

The OPC tunnel is not included in the scope of supply and must be separately licensed.

Examples of OPC tunnel products are:

- Softing: PC Easy Connect Suite
- MatrikonOPC: OPC-Tuneller™

10.4.2 Configuring the WirelessHART OPC server with "WirelessHART Fieldgate OPC Configurator"

Installing the WirelessHART OPC server

Install the program "Wireless HART Fieldgate OPC server" on the computer that is to be used as the WirelessHART OPC server. The program can be found on the data medium supplied. Follow the instructions of the Installation Wizard.

"Learn" – add objects automatically to the device tree

1. Start the program either via the Windows Start icon or via the program icon on the desktop. The following window appears:

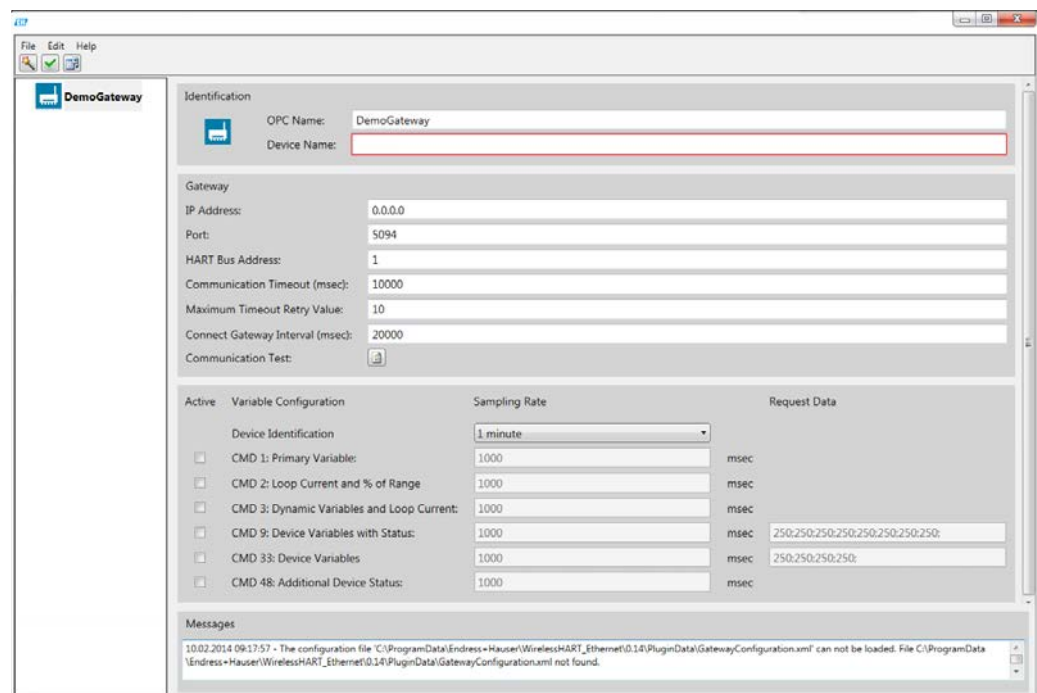

2. In the left pane, click on the Fieldgate.
3. Enter a name for the Fieldgate in the field "OPC Name". The name is added to the device tree in the left pane. The OPC client identifies the Fieldgate through its OPC name.
4. Enter the "Long Tag Name" of the Fieldgate in the field "Device Name". The "Device Name" must be identical to the "Long Tag Name", since the designation of the Fieldgate is identified through it.
5. Enter the appropriate data in the fields "IP Address", "Port" and "HART Bus Address".
6. Click on the button "Communication Test", in order to check whether the Fieldgate can be found.

NOTICE**NOTICE!**

- If the test is unsuccessful, check your entries in the fields "Device Name", "IP Address" as well as the Ethernet configuration. If necessary, consult your IT department.
7. Click on the icon "Learn"  in the top left of the menu tray.
All objects that are connected to the Fieldgate are imported into the device tree. These may be:
 - Adapters: adapters such as a WirelessHART Adapter SWA70 or a field device with antenna. You can add several field devices below an adapter.
 - Subdevices: field devices without an antenna. You cannot add other objects below a field device (subdevice).
 8. In the left pane, click on Fieldgate SWG70.
 9. Configure the remaining parameters. See Chapter 10.4.3 "Description of the WirelessHART Fieldgate OPC Configurator" on page 81.
 10. Configure all the adapters and field devices (subdevices) as described in Chapter 10.4.3. In order to enable parameterization, select the adapter or field device concerned in the left pane. The device tree can be structured using the object "Folder".
 11. Use the **File** menu to store the configuration file.
 - File > **Save Active**: the configuration file is stored under the name **GatewayConfiguration.xml** in the folder that is accessed by the WirelessHART OPC server.
 - File > **Save As**: You can select your own file name and storage location for the configuration file.

"Add" – add objects manually to the device tree

1. Start the program either via the Windows Start icon or via the program icon on the desktop. The following window appears:

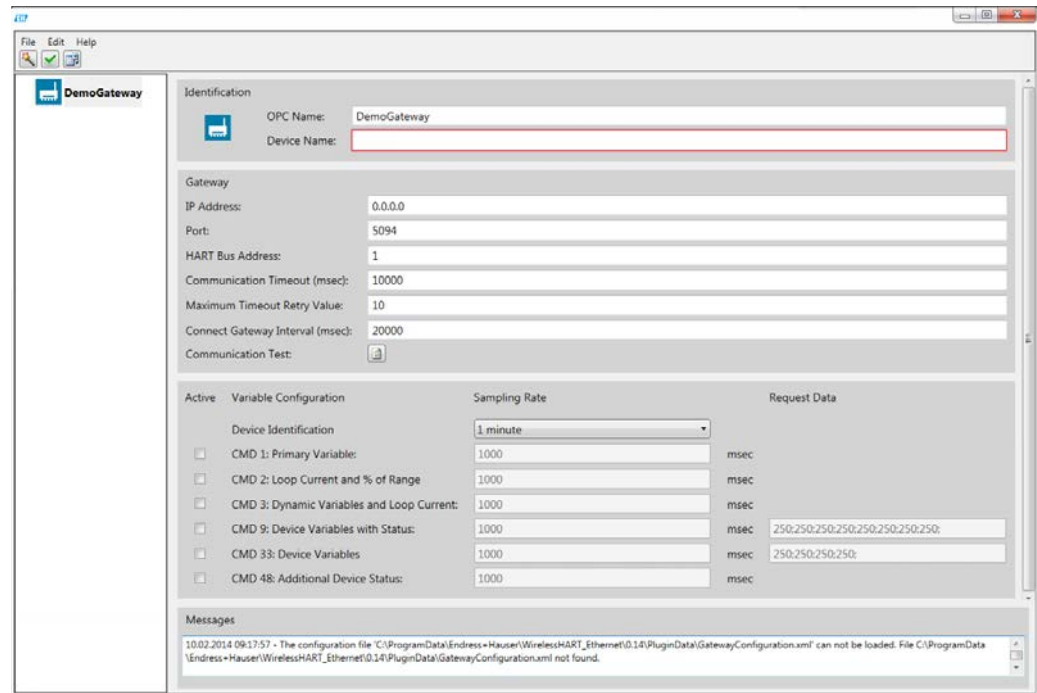

2. Configure the Fieldgate SWG70. See Chapter 10.4.3 "Description of the WirelessHART Fieldgate OPC Configurator" on page 81.
3. In the left pane, click on the Fieldgate.
4. Right click on the Fieldgate to open the context menu.
5. Using the **Add** menu, add other objects such as a **Folder**, **Adapter** or **Subdevice (field device)**. The device tree in the left pane is extended as appropriate.
 - Folder: the object "Folder" can be used to structure the device tree. "Folder" may contain several adapters and field devices (subdevices).
 - Adapters: adapters such as a WirelessHART Adapter SWA70 or a field device with antenna. You can add several field devices below an adapter.
 - Subdevices: field devices without an antenna. You cannot add other objects below a field device (subdevice).
6. Configure all the adapters and field devices (subdevices) as described in Chapter 10.4.3. In order to enable parameterization, select the adapter or field device concerned in the left pane.
7. Use the **File** menu to store the configuration file.
 - File > **Save Active**: the configuration file is stored under the name **GatewayConfiguration.xml** in the folder that is accessed by the WirelessHART OPC server.
 - File > **Save As**: You can select your own file name and storage location for the configuration file.

10.4.3 Description of the WirelessHART Fieldgate OPC Configurator

Entry fields in the right pane

The Fieldgate, adapters and field devices are configured with the parameters in the right frame. Select the object to be configured in the left pane. The right pane displays the parameters that must be entered for that object.

Identification

Enter the names for the Fieldgate, the selected adapter or the selected field device in the **Identification** area.

Parameter	Meaning
OPC Name	A character string that identifies the Fieldgate, adapters or field devices. The name entered is displayed in the device tree in the left pane.
Device Name	A character string that identifies the Fieldgate. It is recommended that the "Device Name" is identical to the "Long Tag Name".

Gateway

Enter the access and communication data for the Fieldgate in the **Gateway** area.

Parameter	Meaning
IP Address	IP address of the Fieldgate
Port	Port number of the Fieldgate. Standard: 5094
HART Bus Address	HART bus address of the Fieldgate. Factory setting: 1
Communication Timeout	Time that elapses between two successive failed attempts to open communication between the WirelessHART OPC server and the Fieldgate. Valid range: 1000...10000 ms, Factory setting: 1000 ms
Maximum Timeout Retry Value	Maximum number of successive attempts to open communication between the WirelessHART OPC server and the Fieldgate. Valid range: 1-20. Factory setting: 10
Connect Gateway Interval	Time that elapses after an unsuccessful attempt to open communication before the WirelessHART OPC server tries to open communication again. Valid range: 20000...60000 ms. Factory setting: 20000
Communication Test	Check the connection between the WirelessHART OPC server and the Fieldgate.

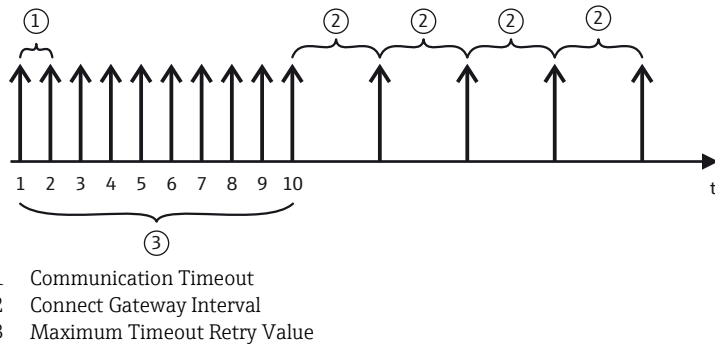

HART commandos

Enter the settings for the HART commands in the **Variable Configuration** area. The HART command is activated only when the corresponding **Active** checkbox is ticked.

NOTICE**NOTICE!**

- In order to minimize the scanning time, you must enter the same parameters for the **Sampling Rate** and **Request Data** that you have already used for the WirelessHART Adapter (SWA70).

For example, when a WirelessHART Adapter transmits Command 2 every 15 minutes and Command 48 every 60 minutes, only CMD 2 and CMD 48 should be activated and the corresponding times entered in the Sampling Rate field.

For more information see the WirelessHART Adapter operating instructions.

Parameter	Meaning
Device Identification	Identification of the device. Options: every minute or every hour.
CMD 1: Primary Value	Transmits the primary variable and its unit at the selected interval.
CMD2 Loop Current and % of Range	Transmits the value of the 4...20 mA signal and the corresponding percentage value at the selected interval.
CMD 3: Dynamic Variables and Loop Current	Transmits the value of the 4...20 mA signal and up to four predefined process variables (PV, SV, TV and QV) and corresponding units at the selected interval.
CMD 9: Device Variables with Status	Transmits the values, units and status of up to eight field device variables at the selected interval.
CMD 33: Device Variables	Transmits the values and units of up to four field device variables at the selected interval.
CMD 48: Additional Device Status	Transmits the entire device status information at the selected interval.

Menus**File menu**



Designation	Meaning
New	Opens an empty configuration file.
Recent	Opens the last used configuration file.
Open	Opens a configuration file.
Open Active	Opens the configuration file that is accessed by the WirelessHART OPC server.
Save As	Saves a configuration file with a new file name and in any desired folder.
Save Active	Saves the configuration file under the name "GatewayConfiguration.xml" in a predefined folder. The WirelessHART OPC server accesses this file.
Exit	Closes the "WirelessHART Fieldgate Configurator" program.

Edit menu

This menu corresponds to the context menu which opens when an object is right clicked.

Designation	Meaning
Add	Add an object such as a Folder, Adapter or Subdevice (field device). The device tree in the left pane is extended as appropriate. <ul style="list-style-type: none"> - Folder: the object "Folder" can be used to structure the device tree. "Folder" may contain several adapters and field devices (subdevices). - Adapters: adapters such as a WirelessHART Adapter SWA70 or a field device with antenna. You can add several field devices below an adapter. - Subdevices: field devices without an antenna. You cannot add other objects below a field device (subdevice).
Delete	Delete an object.
Cut	Delete an object and put it in the clipboard.
Copy	Copy an object.
Paste	Add an object from the clipboard.

Symbols (icons)

Designation	Meaning
	<p>Learn</p> <p>Click on this icon to check whether a Fieldgate is connected to the WirelessHART OPC server. If this is the case, all objects that are connected to the Fieldgate and online are displayed in the device tree. If there is no connection to the Fieldgate an error message appears in the "Messages" area.</p>
	<p>Verify</p> <p>Click on this icon to check a manual configuration of the device tree against the actual configuration of the connected Fieldgate. The status of the Fieldgate, adapters and field devices (subdevices) is indicated by a colored border.</p> <ul style="list-style-type: none"> - Red border: object was not found. - Yellow border: object was found, but is not represented in the device tree. - Green border: object was found and is represented in the device tree. <p>If there is no connection to the Fieldgate an error message appears in the "Messages" area.</p> <p>The verification of the configuration with that of the connected WirelessHART network is done by means of the device "Long Tag". Enter the "Long Tag Name" in the field "Device Name" in the "WirelessHART Fieldgate Configurator" program. The designation entered in the field "OPC Name" is that displayed in the device tree.</p>
	<p>Import CSV</p> <p>Click on the icon to import a CSV file such as the Fieldgate's "Instrument List" or "Modbus".</p> <p>The device tree will then be generated and displayed in accordance with the contents of the CSV file.</p>

10.4.4 Configuring bursts using the WirelessHART OPC server

By using OPC technology, the WirelessHART OPC server offers the possibility of aligning the burst rate with the WirelessHART Adapter SWA70 in accordance with the application requirements. This means that no other program, for example FieldCare, is required for the configuration.

Prerequisites

The following prerequisites are necessary for burst configuration:

- The WirelessHART OPC server has been installed.
- The WirelessHART OPC server has been configured with the program "WirelessHART Fieldgate OPC Configurator". The configuration file was saved with the menu item "Save Active".
- The OPC client is connected to the WirelessHART OPC server.
- The link to the OPC server has been established in the WirelessHART OPC client. The device tree structure created in the "WirelessHART Fieldgate OPC Configurator" appears:

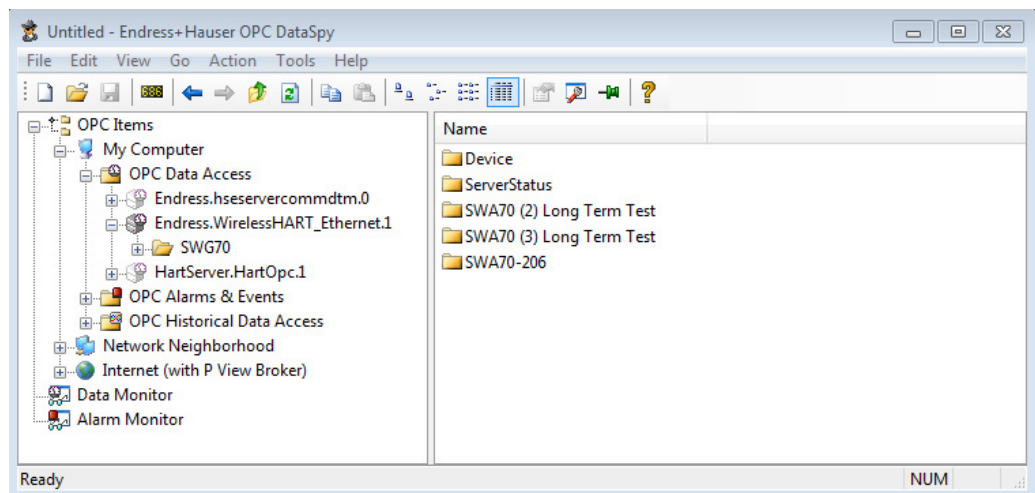

Burst configuration

The burst configuration is described and illustrated on the basis of the OPC client "OPC Data Spy". Designations and procedures may differ for other OPC clients.

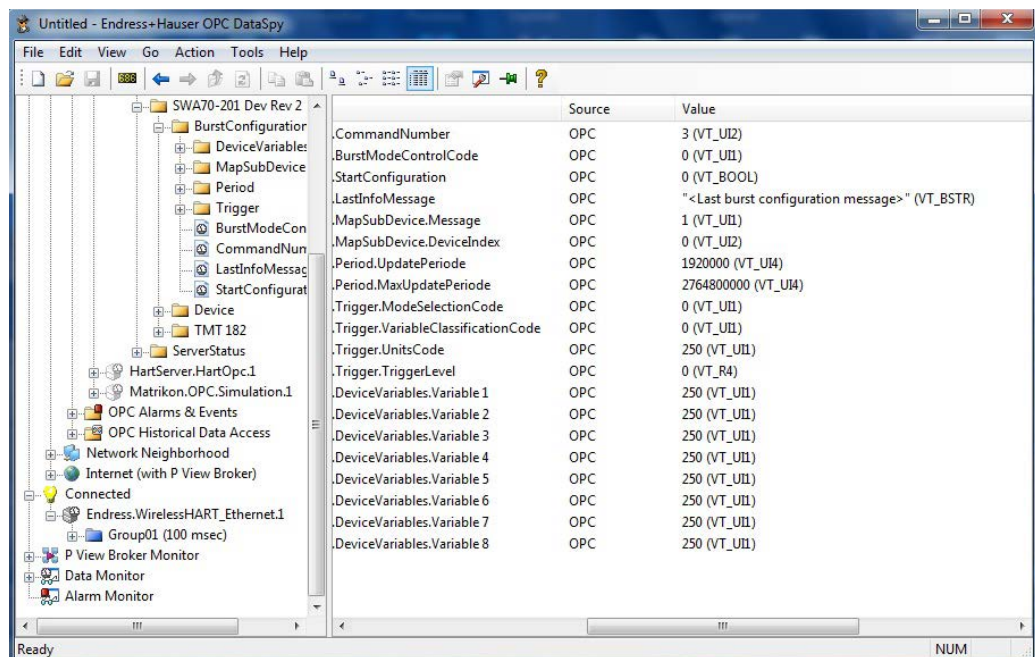

1. Select a WirelessHART Adapter.
2. Open the folder "Burst Configuration" for the selected WirelessHART Adapter. Every WirelessHART Adapter has its own "Burst Configuration" folder. The folder contains the required "Burst OPC Data Items".
3. Activate the "Monitor" function for the folder "Burst Configuration".
4. Change to the folder "Data Monitor". The folder shows the current values of the "Burst OPC Data Items".
5. Configure the "Burst OPC Data Items" according to your requirements. For a description see Chapter "Description of the Burst OPC Data Items" on page 85
 - Click on the "Burst OPC Data Item" that you want to configure.
 - Select the client function "Sync Write" with a right click.
 - Enter the new value. The newly entered value appears in the column "Value". Note that the value has not been sent to the Fieldgate at this point.
 - Repeat the procedure for every "Burst OPC Data Item" to be configured.
6. Set the "Burst OPC Data Item" **StartConfiguration** to the value "1" in order to transmit burst configuration to the Fieldgate.
 - Before transmission begins, the entered values are checked. If the values are invalid, the transmission is stopped. The "Burst OPC Data Item" **LastInfoMessage** indicates the error.
 - If there are no errors, the "Burst OPC Data Item" **LastInfoMessage** displays the current status.
 - Once the burst has been successfully transmitted and activated, the "Burst OPC Data Item" **LastInfoMessage** shows a message to this effect.

Description of the Burst OPC Data Items

Designation	Meaning
BurstConfiguration. BurstModeControlCode (Burst-Modus)	Enter a number to switch the burst on or off. <ul style="list-style-type: none"> ▪ 0: Off ▪ 2: Wireless
BurstConfiguration. CommandNumber	Enter the command number that is to be transmitted. <ul style="list-style-type: none"> ▪ Valid commands when the burst is for an adapter: (MapSubDevice.DeviceIndex = 0): 1, 2, 3, 9, 33, 48 ▪ Valid commands when the burst is for a field device (MapSubDevice.DeviceIndex = from 1 to 4): 0 - 255 Check the field device manual for supported commands.
BurstConfiguration. Device Variable.Variable1-8	If you use burst commands "9" or "33" or both, enter the appropriate codes for the device variables. Codes for the WirelessHART-Adapter SWA70 are listed in see Chapter "Device Variable Codes" on page 87. Check the appropriate manual for the codes of other field devices. <ul style="list-style-type: none"> ▪ Device variables 1 - 8 are available for burst command "9". ▪ Device variables 1 - 4 are available for burst command "33".
BurstConfiguration. LastInfoMessage	Displays information over the burst parameter set that should be or has been transmitted. Possible information: error messages if the burst parameter set has errors before transmission; status messages during transmission; a message indicating successful transmission and activation of the burst.
BurstConfiguration. MapSubDevice.DeviceIndex	Enter the device from which the burst command was transmitted. <ul style="list-style-type: none"> ▪ 0: Adapter ▪ 1: HART Subdevice 1 ▪ 2: HART Subdevice 2 ▪ 3: HART Subdevice 3 ▪ 4: HART Subdevice 4
BurstConfiguration. MapSubDevice.Message	Configures up to 10 burst messages. Valid range: 1 - 10

Designation	Meaning
BurstConfiguration. Period.UpdatePeriod (time period)	If the "Trigger Mode" is set to "Continuous", enter the time that must elapse between two burst messages. If the "Trigger Mode" is set to any other option, this parameter determines the fastest rate. <ul style="list-style-type: none"> ▪ Valid range: 1 second to 24 hours (32000 – 2764800000) ▪ 1 second = 32000 ▪ 10 seconds = 320000 For more information see the Operating Instructions for the WirelessHART Adapter SWA70, Chapter "Burst Mode", Table "Burst Mode Parameters", Parameter "Period".
BurstConfiguration. Period.MaxUpdatePeriod (Max. time period)	If the "Trigger Mode" is set to a value other than "Continuous", enter the maximum period in seconds that can elapse between two burst messages if the condition ("Trigger Level") is not met. <ul style="list-style-type: none"> ▪ Valid range: 1 second to 24 hours (32000 – 2764800000) ▪ 1 second = 32000 ▪ 10 seconds = 320000 For more information see the Operating Instructions for the WirelessHART Adapter SWA70, Chapter "Burst Mode", Table "Burst Mode Parameters", Parameter "Max. Period".
BurstConfiguration. StartConfiguration	Starts the transmission of a burst configuration. <ul style="list-style-type: none"> ▪ 0: Default value – the burst configuration is not transmitted. ▪ 1: The entire burst parameter set is transmitted to the WirelessHART Adapter concerned.
BurstConfiguration. Trigger.ModeSelectionCode (Trigger mode)	Specifies the event that triggers a burst message from a device. Options: <ul style="list-style-type: none"> ▪ 0: Continuous ▪ 1: Window ▪ 2: Rising ▪ 3: Falling ▪ 4: On change For more information see the Operating Instructions for the WirelessHART Adapter SWA70, Chapter "Burst Mode", Table "Burst Mode Parameters", Parameter "Trigger Mode".
BurstConfiguration. Trigger.TriggerLevel (Trigger level)	Specifies the threshold for switching from "Period" to the "Max. Period", i.e. from the fast to the slow setting. <ul style="list-style-type: none"> – The switching mode is specified in the "Trigger Mode".
BurstConfiguration. Trigger.UnitsCode (Unit (Trigger))	See Chapter 18 "Table Device Variable Classification and Unit Code" on page 131.
BurstConfiguration.Trigger. VariableClassificationCode (Class of device variable (Trigger))	See Chapter 18 "Table Device Variable Classification and Unit Code" on page 131.

Device Variable Codes

Device Variable Codes for WirelessHART Adapter SWA70

For additional information, see the Operating Instructions for the WirelessHART Adapter SWA70, Chapter "Device Variable Mapping".

Device Variable codes	Meaning
0	Battery temperature
1	Minimal battery temperature
2	Maximal battery temperature
3	Battery voltage
4	Consumed energy
5	RSL to best neighbor
6	RSL to second best neighbor
7	Battery voltage with load
8	Battery voltage without load
9	Normalized consumed energy
243	Estimated lifetime of battery
244	Percent range of loop current
245	Loop current
246	Primary variable
247	Secondary variable
248	Tertiary variable
249	Quaternary variable

Device Variable Codes for field devices (subdevices)

If you configure a burst for a field device (subdevice), use the Device Variable Codes to be found in the corresponding manual.

10.5 EtherNet/IP configuration

NOTICE

NOTICE!

- The "EtherNet/IP" function is only available on WirelessHART Fieldgate models with the version "SWG70-xx-3". See Chapter 2.3 "Ordering information" on page 10.

The Fieldgate SWG70-xx-3 makes cyclic data available from up to 39 devices (WirelessHART Adapters and field devices) via EtherNet/IP. In addition, data from Fieldgate itself can also be made available via EtherNet/IP. Fieldgate offers 10 cyclic data exchange connections for this purpose. Cyclic data from up to 4 devices can be exchanged via a data exchange connection.

10.5.1 Setting up an EtherNet/IP connection

1. Set up the WirelessHART network. See Chapter 5.3 "Connecting to Ethernet" on page 22. See Chapter 7.1 "Ethernet connection" on page 31.
2. Define the HART descriptors for all the HART and WirelessHART field devices that should be monitored via EtherNet/IP according to the naming conventions. See Chapter 10.5.2 "Assigning data exchange connections via HART descriptors" on page 88.
3. Define the burst commands for all the HART and WirelessHART field devices that should be monitored via the cyclic EtherNet/IP connection. See Chapter 10.5.3 "Burst commands for cyclic data exchange" on page 89.
4. Integrate the WirelessHART Fieldgate SWG70 into your control system. For this purpose, install the Add-On Profile (AOP) or the EDS file. See Chapter 10.5.4 "Integrating SWG70 into a PLC via EtherNet/IP" on page 90.
5. Make the configuration for cyclic or direct data exchange with the HART and WirelessHART field devices. See Chapter 10.5.5 "Cyclic data exchange via the ControlLogix® controller system" on page 90.

10.5.2 Assigning data exchange connections via HART descriptors

The "HART Descriptor" parameter is used to make available the cyclic data from field devices and Fieldgates. You can configure this parameter in the corresponding DTM or DD.

The "HART Descriptor" parameter has the following structure for all field devices and for the Fieldgates:

- Up to 13 characters of customized text
- Identifier with 3 characters.

The customized text is used to identify the devices in readable format. You can enter the tag name here for example.

The identifier is used to assign the cyclic data and has the following structure:

- 1st character: @
- 2nd character: choice of one of the 10 cyclic data exchange connections. The letter "A" corresponds to connection "1" and the letter "J" to connection "10".
- 3rd character: device identifier

The identifier @A0 is pre-assigned by Fieldgate and may not be used for WirelessHART Adapters or field devices.

Application example

The WirelessHART network consists of a Fieldgate, 4 adapters and 4 measuring devices.

HART descriptors for HART field devices:

- LT101@A1
- PT101@A2
- FT101@A3
- TT101@B0

HART descriptors for adapters:

- ADAPTER1@B1
- ADAPTER2@B2
- ADAPTER3@B3
- ADAPTER4@C0

10.5.3 Burst commands for cyclic data exchange

In the case of WirelessHART, the variables from field devices and WirelessHART Adapters are transmitted to the Fieldgate by burst commands. You must configure the burst commands accordingly.

Use the DTM or DD of the corresponding WirelessHART device and flag the following burst commands:

- Command 9: Read Device Variables with Status
- Command 48: Read Additional Status

As an alternative to command 9, you can flag command 3 "Read All Dynamic Variables and Loop Current" or command 33 "Read Device Variables".

The following variables are available with HART commands 3, 9, 33 and 48:

Cyclic data variables	In the HART command			
	3	9	33	48
PV, SV, TV, QV	x	x	x	
PV Status, SV Status, TV Status, QV Status		x		
PV Unit, SV Unit, TV Unit, QV Unit	x	x	x	
Additional Device Status Information				x

As an alternative to command 9, you can flag command 3 "Read All Dynamic Variables and Loop Current" or command 33 "Read Device Variables".

Bit ".NoDataBurstConfigured" in "DeviceStatus_Struct" means that neither command 3, 9 nor command 33 has been flagged. Bit ".NoDataBurstConfigured" in "DeviceStatus_Struct" means that command 48 has not been flagged.

See Section "Data block of the WirelessHART Fieldgate" on page 95. See Section "Data block of the HART devices" on page 97.

NOTICE**NOTICE!**

- You can check the burst commands of all the HART devices in the WirelessHART network in the Fieldgate Web server or in the DTM as follows: Diagnostics > Wireless Communication > Burst Lists. See Chapter 9.2.3 "Burst Lists" on page 56.

10.5.4 Integrating SWG70 into a PLC via EtherNet/IP

Rockwell Automation ControlLogix®

You can integrate the WirelessHART Fieldgate into ControlLogix® via an Add-On Profile (AOP).

Add-On Profile can be found on www.endress.com.

Once the Add-On Profile (AOP) has been installed, you can access the WirelessHART Fieldgate via the device catalog in ControlLogix®.

Other controller systems

For other controller systems, the WirelessHART Adapter is integrated via the EDS file (Electronic Data Sheet). You can identify the WirelessHART Fieldgate in the network configuration tool and put it into operation via the EDS file.

EDS file can be found on www.endress.com.

For more information on how to install the EDS file and integrate a new device, please see the documentation for the controller system.

10.5.5 Cyclic data exchange via the ControlLogix® controller system

NOTICE

NOTICE!

- The integration of the WirelessHART Fieldgate is described using the example of a Rockwell ControlLogix® controller. If other controllers and software are used, please see the corresponding documentation for the controller/software.

Configuring the IP address of SWG70

1. In the "Controller Organizer" window, double-click "WirelessHART Fieldgate".

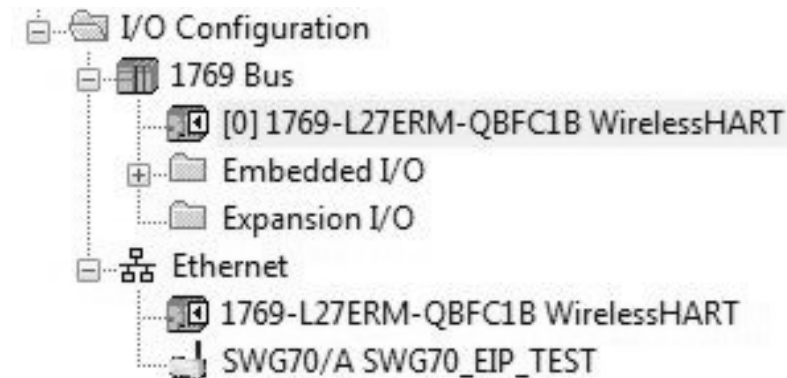

- The Add-On Profile of the WirelessHART Fieldgate opens.

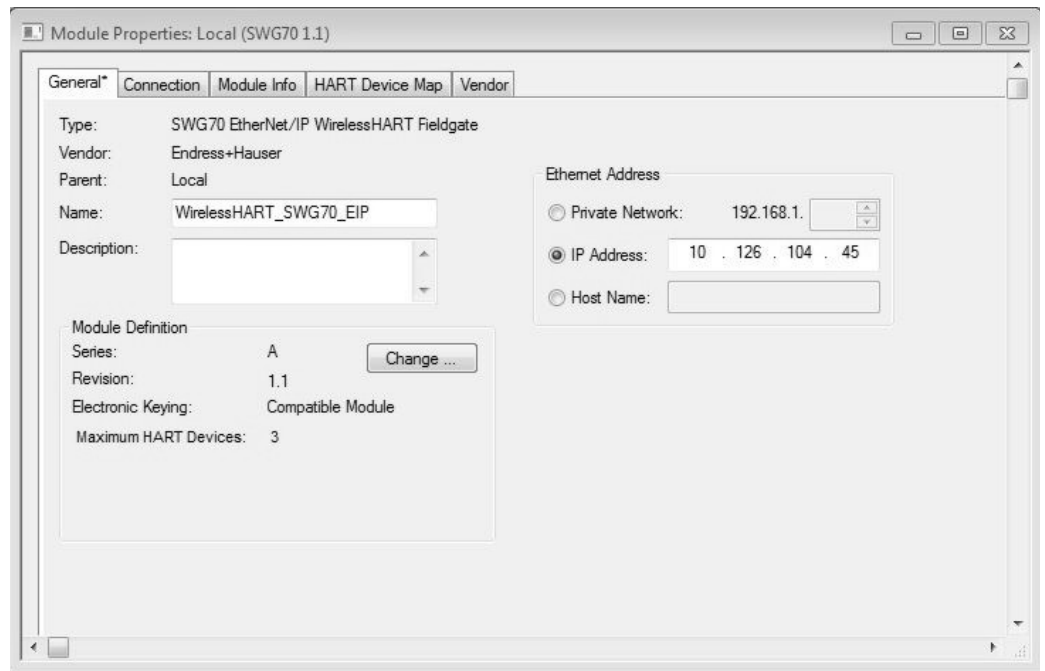

- Enter the IP address of the WirelessHART Fieldgate in the "Ethernet Address" section of the "General" tab.

Configuring the maximum number of HART devices

- Select the "General" tab in the Add-On Profiles section of the WirelessHART Fieldgate.
- Click the "Change" button under "Module Definition".
The "Module Definition" window opens. Use this dialog to configure specific parameters for the cyclic EtherNet/IP connection and the number of HART devices.

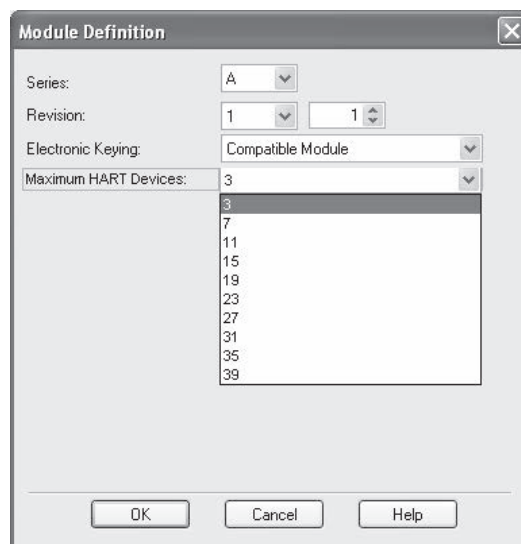

Checking connected HART devices

1. Select the "HART Device Map" tab in the Add-On Profiles of WirelessHART Fieldgate.
2. The "HART Device Map" is displayed.

HART Device	Descriptor	Long Tag Name	HART Comm Fail	Descriptor Not Unique	Data Burst Not Configured	Cmd48 Burst Not Configured
A1	SWA70@A1	SWA70 Adapter				
A2	PT001@A2	PT001				
A3			X			
B0			X			
B1			X			
B2			X			
B3			X			
C0			X			
C1			X			
C2			X			
C3			X			
D0			X			
D1			X			
D2			X			
D3			X			
E0			X			
E1			X			

NOTICE

NOTICE!

- It can take up to 10 minutes to update the HART Device Map. If a device is connected to the network or is removed from the network, it can take up to 10 minutes for this device to appear in the overview or be deleted.

HART Device Map

Displayed information	Description
HART Device	Displays the HART device identifier. This identifier is identical to the last 3 characters of the device's HART descriptor. See Chapter 10.5.2.
Descriptor	Displays the HART descriptor of the device. The HART descriptor must comply with the dedicated naming conventions. See Chapter 10.5.2.
Long Tag Name	Displays the long tag name of the device.
HART Comm Fail	This bit is flagged if a device is not available, e.g. because it is not possible to establish the connection to the device. Make sure that the maximum number of HART devices in the "Module Definition" window is greater than the actual number of HART devices.
Descriptor Not Unique	This bit is flagged if the HART descriptor of the HART device is not unique. Change the HART descriptor using the associated HART device DTM.
Data Burst Not Configured	This bit is flagged if HART command 9 (alternatively command 3 and 33) has not been flagged as burst in the HART device. Flag HART command 9 (alternatively command 3 or 33) using the associated device DTM. See Chapter 10.5.3.
Cmd48 Burst Not Configured	This bit is flagged if HART command 48 has not been flagged by the HART device. Flag HART command 48 using the associated device DTM. See Chapter 10.5.3.

Displaying available variables

1. In the "Controller Organizer" window, double-click "Controller Tags".



2. The "Monitor Tags" section shows a detailed overview of the variables available. See Chapter 10.5.6 "Connection parameters for cyclic data exchange" on page 95.

Name	Value	Force Mask	Style	Data Type
+ Timer	{...}	{...}		TIMER
- WirelessHART_SWG70_EIP:11	{...}	{...}		EH:SWG70_A3:1...
+ WirelessHART_SWG70_EIP:11.CommStatus	2#0000_0000_0000_0000...		Binary	DINT
- WirelessHART_SWG70_EIP:11.CommFit	0		Decimal	BOOL
- WirelessHART_SWG70_EIP:11.SWG70	{...}	{...}		EH:SWG70:1:0
- WirelessHART_SWG70_EIP:11.SWG70.NetworkReliability_pct	100.0		Float	REAL
- WirelessHART_SWG70_EIP:11.SWG70.NetworkStability_ratio	96.57599		Float	REAL
+ WirelessHART_SWG70_EIP:11.SWG70.NetworkLatency_ms	228		Decimal	DINT
+ WirelessHART_SWG70_EIP:11.SWG70.LostUpstreamPackets	0		Decimal	DINT
+ WirelessHART_SWG70_EIP:11.SWG70.DeviceStatusGW	{...}	{...}		EH:DeviceStatus...
+ WirelessHART_SWG70_EIP:11.SWG70.Tag	{...}	{...}		EH:Tag:1:0
+ WirelessHART_SWG70_EIP:11.SWG70.Cmd48	{...}	{...}		EH:Cmd48:1:0
- WirelessHART_SWG70_EIP:11.A1	{...}	{...}		EH:Device:1:0
- WirelessHART_SWG70_EIP:11.A1.PV	4.0		Float	REAL
- WirelessHART_SWG70_EIP:11.A1.SV	26.6		Float	REAL
- WirelessHART_SWG70_EIP:11.A1.TV	-43.0		Float	REAL
- WirelessHART_SWG70_EIP:11.A1.FV	261.97308		Float	REAL
+ WirelessHART_SWG70_EIP:11.A1.PVStatus	16#00		Hex	SINT
+ WirelessHART_SWG70_EIP:11.A1.SVStatus	16#00		Hex	SINT
+ WirelessHART_SWG70_EIP:11.A1.TVStatus	16#00		Hex	SINT
+ WirelessHART_SWG70_EIP:11.A1.FVStatus	16#00		Hex	SINT
+ WirelessHART_SWG70_EIP:11.A1.PVUnit	16#27		Hex	SINT
+ WirelessHART_SWG70_EIP:11.A1.SVUnit	16#20		Hex	SINT
+ WirelessHART_SWG70_EIP:11.A1.TVUnit	16#F1		Hex	SINT
+ WirelessHART_SWG70_EIP:11.A1.FVUnit	16#35		Hex	SINT
- WirelessHART_SWG70_EIP:11.A1.PVLowerRangeValue	4.0		Float	REAL
- WirelessHART_SWG70_EIP:11.A1.PVUpperRangeValue	20.0		Float	REAL
+ WirelessHART_SWG70_EIP:11.A1.DeviceStatus	{...}	{...}		EH:DeviceStatus...
+ WirelessHART_SWG70_EIP:11.A1.Tag	{...}	{...}		EH:Tag:1:0
+ WirelessHART_SWG70_EIP:11.A1.Cmd48	{...}	{...}		EH:Cmd48:1:0
+ WirelessHART_SWG70_EIP:11.A2	{...}	{...}		EH:Device:1:0

10.5.6 Connection parameters for cyclic data exchange

Data block of WirelessHART Fieldgate, used in cyclic data transfer

The format of the data block of the WirelessHART Fieldgate which is transmitted in the first position of the first connection is as follows.

Data block of the WirelessHART Fieldgate

Structure	Data type	Size	Invalid values	Description	
Gateway_struct		84			
	.NetworkReliability_percent	REAL	4	Quiet NaN ¹⁾	Percentage of the packets generated by wireless devices that were correctly received by the WirelessHART Fieldgate.
	.NetworkStability_ratio	REAL	4	Quiet NaN ¹⁾	Ratio of successfully transmitted packets to all the packets transmitted on all the wireless connections
	.NetworkLatency_ms	DINT	4	-1 ¹⁾	Average time required for the packets generated by a wireless device to the WirelessHART Fieldgate
	.LostUpstreamPackets	DINT	4	-1 ¹⁾	Total number of packets that have been lost during transmission by a wireless device
Sub-structure	DeviceStatus_Struct		4	(always valid)	
	.GeneralStatus	BYTE	1		
	.InternalError	BOOL			Displays an internal error. The values ".NetworkReliability_percent", ".NetworkStability_ratio", ".NetworkLatency_ms" and ".LostUpstreamPackets" are set to an invalid value and the "HART Comm Fail" bit of all the devices is flagged.
	.DescriptorNotUnique	BOOL			The same HART descriptor has been assigned for at least two HART devices. This is an aggregate bit for all the HART devices. See Chapter 10.5.7 "Diagnostic bits in cyclic data exchange" on page 98.
	.NoDataBurstConfigured	BOOL			Indicates that at least one HART device in cyclic data exchange has not flagged command 3, 9 or 33. See Chapter 10.5.7 "Diagnostic bits in cyclic data exchange" on page 98.
	.NoCmd48BurstConfigured	BOOL			Indicates that at least one HART device in cyclic data exchange has not flagged command 48. See Chapter 10.5.7 "Diagnostic bits in cyclic data exchange" on page 98.
	.PassThroughQueueOccupied	BOOL			Not used
	.PassThroughResponseReady	BOOL			Not used
	.UnusedStatus1	BYTE	1		
	.FieldDeviceStatus	BYTE	1		Original status byte returned by WirelessHART Fieldgate. For more details see Page 96, "HART Device Status" Table.
	.ExtendedDeviceStatus	BYTE	1		Original status byte returned by WirelessHART Fieldgate. For more details see Page 96, "HART Extended Device Status" Table.
Sub-structure	Tag_Struct		32	(always valid)	
	.Name	BYTE[32]	32		HART Long Tag (ISO/IEC 8859-1)
Sub-structure	CMD48_Struct		28	(always valid)	
	.Cmd48Data	BYTE[25]			CMD 48 data
	.Cmd48Reserved	BYTE[3]			Fill bytes

The statistics values marked with 1) are only invalid if the WirelessHART Fieldgate has been started and the statistics values have not yet been calculated. The statistics values remain valid for as long as the WirelessHART Fieldgate is in operation.

HART Device Status

Bit	Parameter	Description
0x80	Device malfunction	Device in the network has malfunctioned
0x40	Configuration changed	Configuration of a device in the network has changed
0x20	Cold start	Device in the network has cold start flagged
0x10	More status available	Device in the network has more status available flagged
0x08	Loop current fixed	Loop current of a device in the network is fixed to 4 mA (multidrop mode)
0x04	Loop current saturated	Loop current of a device in the network above 20 mA
0x02	Non-primary variable out of limits	SV, TV, QV of a device in the network is out of limits
0x01	Primary variable out of limits	PV of a device in the network is out of limits

HART Extended Device Status

Bit	Parameter	Description
0x01	Maintenance required	The device requires maintenance.
0x02	Device variable alert	One of the device variables reports the "Alarm" or "Warning" status.
0x04	Critical power failure	Only for battery-powered devices. The power supply is no longer adequate. The device can no longer maintain the network connection for 15 minutes.
0x08	Failure	At least one variable (e.g. measured values or control values) is invalid due to a malfunction of the field device or a peripheral.
0x10	Out of specification	The current conditions deviate from the permitted ambient and process conditions to such an extent that affects the accuracy of the measurement and/or control.
0x20	Function check	At least one device variable is temporarily invalid due to checks being performed on the device.

Data block of HART devices, used in cyclic data transfer

This data structure is used for all WirelessHART field devices and HART devices within a WirelessHART network. The WirelessHART devices must support HART Revision 7 or higher. The HART field devices must support HART Revision 5 or 6. Not all values can be used for HART-5 and HART-6 devices, and some values are replaced by other values. The different behavior is described in the following table.

Data block of the HART devices

Structure		Data type	Size	Invalid values	Description
Device_struct			96		
	.PV	REAL	4	Quiet NaN	Primary Value (HART CMD 3/9/33)
	.SV	REAL	4	Quiet NaN	Secondary Value (HART CMD 3/9/33)
	.TV	REAL	4	Quiet NaN	Third Value (HART CMD 3/9/33)
	.QV	REAL	4	Quiet NaN	Fourth Value
	.PVStatus	BYTE	1	0	Status byte (HART CMD 9) ¹⁾
	.SVStatus	BYTE	1	0	Status byte (HART CMD 9) ¹⁾
	.TVStatus	BYTE	1	0	Status byte (HART CMD 9) ¹⁾
	.QVStatus	BYTE	1	0	Status byte (HART CMD 9) ¹⁾
	.PVUnit	BYTE	1	0	Units Code (HART CMD 3/9/33)
	.SVUnit	BYTE	1	0	Units Code (HART CMD 3/9/33)
	.TVUnit	BYTE	1	0	Units Code (HART CMD 3/9/33)
	.QVUnit	BYTE	1	0	Units Code (HART 3/9/33)
	.PVLowerRangeValue	REAL	4	Quiet NaN	Lower measuring range of the primary value (HART CMD 15)
.PVUpperRangeValue	REAL	4	Quiet NaN	Upper measuring range of the primary value (HART CMD 15)	
Sub-structure	DeviceStatus_Struct		4		
	.GeneralStatus	BYTE	1	(always valid) ²⁾	
	.HARTCommFail	BOOL			HART communication error: device not found/HART is not activated. ³⁾ See Chapter 10.5.7 "Diagnostic bits in cyclic data exchange" on page 98.
	.DescriptorNotUnique	BOOL			Indicates that the same HART descriptor has been assigned to at least one other HART device. See Chapter 10.5.7 "Diagnostic bits in cyclic data exchange" on page 98.
	.NoDataBurstConfigured	BOOL			Indicates that neither command 3, 9 nor 33 have been configured to be sent by the HART device. See Chapter 10.5.7 "Diagnostic bits in cyclic data exchange" on page 98.
	.NoCmd48BurstConfigured	BOOL			Indicates that command 48 has not been configured to be sent by the HART device. See Chapter 10.5.7 "Diagnostic bits in cyclic data exchange" on page 98.
	.PassThroughQueueOccupied	BOOL			Not used
	.PassThroughResponseReady	BOOL			Not used
	.UnusedStatus1	BYTE	1		Fix: 0x00
	.FieldDeviceStatus	BYTE	1	(always valid) ²⁾	Original status byte is returned by the device. For more details see Page 96, "HART Device Status" Table.
.ExtendedFieldDeviceStatus	BYTE	1	0x00	Original status byte is returned by the device. ⁴⁾ See device documentation.	
Sub-structure	Tag_Struct		32	(always valid) ²⁾	
	.Name	BYTE[32]	32		HART Long Tag (ISO/IEC 8859-1) ⁵⁾
Sub-structure	Cmd48_Struct		28		
	.Cmd48Data	BYTE[25]		filled with 0x00 ⁷⁾	CMD48 data
	.Cmd48Reserved	BYTE[3]			Fill bytes

Footnote number	Description
1)	Status values only apply if the associated values PV, SV, TV or FV are valid. The default value "0" indicates that either no value has been received up to now (PV, SV, TV, or FV are invalid) or that the associated values are really bad (PV, SV, TV, FV do not have "Quiet NaN" as a value). Use the following status for HART 5 devices that do not support burst command CMD 9: <ul style="list-style-type: none"> ■ 00-hex: Not connected as long as no values are received from the device (PV, SV, TV, FV contains Quiet NaN) ■ C0-hex: Connected, if the values for PV, SV, TV, FV contain valid data from the device
2)	Always valid as long as the ".HARTCommFail" bit is not flagged. All the values are invalid whenever the ".HARTCommFail" bit is flagged.
3)	If this bit is "1", none of the other data in "Device_struct (including substructures)" are valid.
4)	Only valid for HART devices with Revision 6 and higher that support burst command 9 or 48.
5)	HART devices with Revision 5 return the content of command 12 (Read Message) in the "Long Tag" field because the long tag is not defined in HART Revision 5. Message data also contain 32 bytes.
6)	If "Cmd48Data" is populated by 0x00, this does still not indicate that "Cmd48Data" is invalid. "Cmd48Data" is only invalid if ".NoCmd48BurstConfigured" is also flagged.

10.5.7 Diagnostic bits in cyclic data exchange

The cyclic data contain 4 error bits for every HART device. Each of these error bits can suddenly appear during cyclic communication either when communication is lost or the configuration of one or more devices has changed.

.HARTCommFail

This bit indicates that the device with the HART descriptor calculated from the cyclic connection number and the data offset cannot be reached, does not respond or is still initializing. The bit is reset as soon as the device is initialized. This bit is reset as soon as the connection is lost.

.DescriptorNotUnique

The HART descriptors of all the devices in the WirelessHART network are read during the basic device identification procedure. If EtherNet/IP discovers that more than two devices share the same HART descriptor, the ".DescriptorNotUnique" bit is flagged in the cyclic data exchange for the devices concerned. In addition, the ".DescriptorNotUnique" bit is also flagged in the cyclic data exchange for WirelessHART itself to indicate that at least one HART descriptor collision has been detected.

As devices with identical HART descriptors would share the same data offset in the same cyclic connection, the cyclic data would be populated by random data from these devices. To avoid this, the cyclic data are populated with the data of the device for which the identical HART descriptor was first discovered. This prevents the loss of cyclic data if a new HART device with an identical HART descriptor is added to the network.

.NoDataBurstConfigured

This bit indicates that the device concerned has not been configured with burst command 3, 9 or 33. The missing burst configuration is either discovered during the detailed initialization procedure or following a change to the configuration. Command 3, 9 or 33 must be flagged in order to publish cyclic data via EtherNet/IP.

Burst configuration of the wired devices must be performed via the bridge device. Burst commands that are sent directly to the wired device are not recognized and cause the ".NoDataBurstConfigured" bit to be flagged.

.NoCmd48BurstConfigured

This bit indicates that the device concerned has not been configured with burst command 48. The missing burst configuration is either discovered during the detailed initialization procedure or following a change to the configuration. Command 48 must be flagged in order to publish cyclic data via EtherNet/IP.

Burst configuration of the wired devices must be performed via the bridge device. Burst commands that are sent directly to the wired device are not recognized and cause the ".NoCmd48BurstConfigured" bit to be flagged.

Note that the ".NoCmd48BurstConfigured" bit remains active for devices that do not support Command 48, such as HART devices Revision 5.

10.6 Downstream Communication (for discreet field devices)

You can use the **Downstream Communication** view to configure Downstream Communication. With Downstream Communication, data are transmitted to discreet field devices for control applications.

1. Click **Engineering > Downstream Communication**.

Downstream Communication

Index	Long Tag	IO-Card	Channel	Upload Period	HART Index	Number of Variables	Disable
0	ANALYS_B3_EAST	1	0	00:00:00	0	0	
1	REP_AUDITORIUM_WEST_OUT	12	0	00:00:00	0	0	
2	TEMP_F2_NORD	2	0	00:00:00	0	0	
3	TEMP_B2_WEST	3	0	00:00:00	0	0	
4	REP_B2_SOUTH	4	0	00:00:00	0	0	
5	TEMP_F2_NORTHWEST	5	0	00:00:00	0	0	
6	Solar Battery Test	6	0	00:00:00	0	0	
7	REP_AUDITORIUM_EAST	7	0	00:00:00	0	0	
8	REP-AUDITORIUM_WEST	13	0	00:00:00	0	0	
9	TEMP_B1_EAST	8	0	00:00:00	0	0	
10	PRES_B2_EAST	9	0	00:00:00	0	0	

The following modes are available:

- On-change update mode
- Periodic update mode

On-change update mode

By default, all Modbus output variables are updated with a change procedure. The Fieldgate detects any change in the output status caused by the Modbus Master. The Fieldgate adds the changes to a queue and transfers these changes to the discreet field devices as quickly as possible.

Periodic update mode

The periodic update mode is activated by an update interval that is different to "00:00:00".

1. Click **Engineering > Downstream Communication**.
2. Enter the update interval in the **Upload Period** column for the relevant discreet field device.
3. Click **Apply**. All specified variables are transferred periodically to the discreet field device.

10.7 Substitution value (substitution value to DCS)

The WirelessHART Fieldgate detects when the last measured value is obsolete. This means that the **Global Age Threshold Warning** limit or the **Global Age Threshold Error** limit is exceeded.

In this case, you can specify one of the following substitution values:

- Last value
- NaN1 (0x7FE00000)
- NaN2 (0x7FA00000)
- Upscale (ffffff)
- Downscale (000000)
- User Defined

NOTICE

NOTICE!

- You can perform a Factory Acceptance Test with the substitution value. See Chapter 10.7.2.

Setting a substitution value

1. Click **Engineering > Substitution Value**

Substitution Value

Import CSV Export CSV Refresh Apply

Global Selection: NaN2

Global Age Threshold Warning: 150

Global Age Threshold Error: 300

Long Tag	IO-Car...	Chann...	Device Type	Com. Stat...	Dev. Status	Loop Cu...	PV	SV	TV	QV	Age Thres...	Age Thres...
☐ STERNENHOF	251	1	SWG70									
☐ ANALYS_B3_EAST	1	0	SWA70	✓	✓	Latest	Latest	Latest	Latest	Latest	150	300
▪ REP_AUDITORI...	12	0	SWA70	✓	✓	Latest	Latest	Latest	Latest	Latest	150	300
☐ TEMP_F2_NORD	2	0	SWA70	✓	✓	Latest	Latest	Latest	Latest	Latest	150	300
☐ TEMP_B2_WEST	3	0	SWA70	✓	✓	Latest	Latest	Latest	Latest	Latest	150	300
▪ REP_B2_SOUTH	4	0	SWA70	✓	✓	Latest	Latest	Latest	Latest	Latest	150	300
☐ TEMP_F2_NORT...	5	0	SWA70	✗	✓	Latest	Latest	Latest	Latest	Latest	150	300
☐ Solar Battery Test	6	0	SWA70	✗	✓	Latest	Latest	Latest	Latest	Latest	150	300
▪ REP_AUDITORI...	7	0	SWA70	✓	✓	Latest	Latest	Latest	Latest	Latest	150	300
▪ REP-AUDITORIU...	13	0	SWA70	✓	✓	Latest	Latest	Latest	Latest	Latest	150	300

2. Select an option in the **Global Selection** field, or specify a value for the **User Defined** option.
3. Click **Apply**. The value is set globally for all field devices.

Setting different substitution values for individual field devices

1. Click the relevant **Loop Current**, **PV**, **SV**, **TV** or **QV** column for the device in question.
2. Enter the desired value.
3. Click **Apply**. The value is set for this field device.

10.7.1 Burst message monitoring

The web interface provides the option of configuring notification limits in the event that the value of a buffered dynamic variable or the "Additional Device Status" command 48 of a wireless device is obsolete.

By specifying Global Age Threshold Warning / Age Threshold Warning limits and **Global Age Threshold Error /Age Threshold Error** limits, early detection of communication losses is possible. If a limit value is exceeded, a warning message or error message is generated.

For burst message monitoring, the field devices must have appropriate burst rates.

The Fieldgate reads the expected burst rates from each field device and assigns a timestamp to each burst message received. In this way, each buffered value is calculated as a percentage value of the burst rate.

The Fieldgate uses the value calculated to determine if a message is sent within the burst rate of the field device or if it is overdue. When a message is received, the "counter" is reset and incremented again until the next message is received.

Setting warning limits and error limits

1. Click **Engineering > Substitution Value**.

The screenshot shows the 'Substitution Value' configuration page. At the top, there are buttons for 'Import CSV', 'Export CSV', 'Refresh', and 'Apply'. Below these are three input fields: 'Global Selection' (dropdown menu set to 'NaN2'), 'Global Age Threshold Warning' (text input '150'), and 'Global Age Threshold Error' (text input '300').

The main part of the page is a table with the following columns: Long Tag, IO-Car..., Chann..., Device Type, Com. Stat..., Dev. Status, Loop Cu..., PV, SV, TV, QV, Age Thres..., and Age Thres... The table lists several devices under the 'STERNHOF' tag, including 'ANALYS_B3_EAST', 'REP_AUDITORI...', 'TEMP_F2_NORD', 'TEMP_B2_WEST', 'REP_B2_SOUTH', 'TEMP_F2_NORT...', 'Solar Battery Test', 'REP_AUDITORI...', and 'RFP-AUDITORIU'. Each row shows the device's communication status (green checkmark or red X) and its deviation status (green checkmark).

Long Tag	IO-Car...	Chann...	Device Type	Com. Stat...	Dev. Status	Loop Cu...	PV	SV	TV	QV	Age Thres...	Age Thres...
STERNHOF	251	1	SWG70									
ANALYS_B3_EAST	1	0	SWA70	✓	✓	Latest	Latest	Latest	Latest	Latest	150	300
REP_AUDITORI...	12	0	SWA70	✓	✓	Latest	Latest	Latest	Latest	Latest	150	300
TEMP_F2_NORD	2	0	SWA70	✓	✓	Latest	Latest	Latest	Latest	Latest	150	300
TEMP_B2_WEST	3	0	SWA70	✓	✓	Latest	Latest	Latest	Latest	Latest	150	300
REP_B2_SOUTH	4	0	SWA70	✓	✓	Latest	Latest	Latest	Latest	Latest	150	300
TEMP_F2_NORT...	5	0	SWA70	✗	✓	Latest	Latest	Latest	Latest	Latest	150	300
Solar Battery Test	6	0	SWA70	✗	✓	Latest	Latest	Latest	Latest	Latest	150	300
REP_AUDITORI...	7	0	SWA70	✓	✓	Latest	Latest	Latest	Latest	Latest	150	300
RFP-AUDITORIU	13	0	SWA70	✓	✓	Latest	Latest	Latest	Latest	Latest	150	300

- In the **Global Age Threshold Warning** field, enter the warning limit value for all field devices as a percentage of the existing burst rate, e.g. "150" for "150 %".
- In the **Global Age Threshold Error** field, enter an error limit value for all field devices as a percentage of the existing burst rate, e.g. "300" for "300 %".
- Click **Apply** to determine the limit values for all field devices.
- If necessary, set individual limit values for individual field devices. To do so, click the relevant **Age Threshold Warning** or **Age Threshold Error** cell. Enter the value directly in the cell.

Displaying Age Threshold Warning and Age Threshold Error status

- Click **Engineering > Measurement List**

Measurement List												
Refresh												
Long Tag	IO-Car...	Chann...	Device Type	Com. Statu...	Dev. Status	Loop Cur...	PV	SV	TV	QV	Age	
STERNENHOF	251	1	SWG70									
ANALYS_B3_EAST	1	0	SWA70	✓	✓	21.46881...	21.46881...	17.70000...	-63 dBm	17175.171...	00:02:43	
REP_AUDITORIUM...	12	0	SWA70	✓	✓	0 mA	0 mA	16.4 °C	-73 dBm	-52.537857 d	00:03:56	
TEMP_F2_NORD	2	0	SWA70	✓	✓	4 mA	4 mA	12.6 °C	-61 dBm	1109.1174...	00:07:08	
TEMP_B2_WEST	3	0	SWA70	✓	✓	3.993681...	3.993681...	18.4 °C	-70 dBm	1906.3294...	00:07:56	
REP_B2_SOUTH	4	0	SWA70	✓	✓	0 mA	0 mA	16.79999...	-60 dBm	2677.1931...	00:07:45	
TEMP_F2_NORTH...	5	0	SWA70	✗	✓	0 mA	0 None	0 None	0 None	0 None	00:00:00	
Solar Battery Test	6	0	SWA70	✗	✓	0 mA	0 None	0 None	0 None	0 None	00:00:00	
REP_AUDITORIUM...	7	0	SWA70	✓	✓	0 mA	0 mA	27 °C	-55 dBm	419.970612 d	00:04:01	
REP-AUDITORIUM...	13	0	SWA70	✓	✓	0 mA	0 mA	25.5 °C	-57 dBm	587.553406 d	00:00:24	
TEMP_B1_EAST	8	0	SWA70	✓	✓	3.993782...	3.993782...	17.4 °C	-61 dBm	1558.9786...	00:08:21	
PRES_B2_EAST	9	0	SWA70	✓	✓	4 mA	4 mA	19 °C	-72 dBm	104.487228 d	00:00:14	
TEMP_B3_WEST	10	0	SWA70	✓	✓	4 mA	4 mA	19.70000...	-62 dBm	610.559204 d	00:08:15	
SWA70_MICROPILT	14	0	SWA70	✓	✓	11.1894...	11.1894...	27.5 °C	-36 dBm	13.12 V	00:00:01	
SWA70_TMT162	15	0	SWA70	✓	✓	16.41640...	16.41640...	32.20000...	-35 dBm	99999 d	00:09:29	

In the **Measurement List** you can check how old the burst messages are. In the **Age Threshold** column, the value is indicated as a percentage and the cell is highlighted using specific colors.

Status	Color of cell	Meaning	Remarks
Good value	Green	The current value is below the set value for Global Age Threshold Warning or Age Threshold Warning	–
Age Threshold Warning	Yellow	The current value has exceeded the set value for Global Age Threshold Warning or Age Threshold Warning.	This warning limit is normally used to identify temporary communication problems.
Age Threshold Error	Red	The current value has exceeded the set value for Global Age Threshold Error or Age Threshold Error.	This error limit is normally used to indicate what is likely to be the complete loss of the device, e.g. when a battery is removed.

10.7.2 Factory Acceptance Test (FAT)

The Factory Acceptance Test is a simulation to verify if the Distributed Control System (DCS) is receiving the correct values from the Fieldgate. During the simulation, the substitution values that were defined for the field devices are transmitted to the DCS. The simulation is successful if the DCS receives the substitution values as expected.

Running the Factory Acceptance Test

NOTICE

NOTICE!

- Run the Factory Acceptance Test without first starting the network.

1. Generate a Modbus mapping. See Chapter 16.
2. Define a substitution value. See Chapter 10.7.
3. The Factory Acceptance Test is successful if the DCS receives the substitution values as expected.

10.8 Security – Whitelist, Temporary Join Key

The Fieldgate supports the "Whitelist" security function.

New field devices can be added to the network only if their addresses are listed in this Whitelist and can be identified.

In addition, you can define a temporary join key, which automatically becomes invalid after a specified time period. This key can be used, for example, for field devices that are required on a temporary basis only due to maintenance reasons. If the specified time has elapsed, the temporary join key is overwritten by the permanent join key.

1. Click **Engineering > Security**.

The screenshot shows a configuration interface for security settings. At the top, 'Network Access Mode' is set to 'Open'. Below it is a 'Transfer Network to Whitelist' button with '>>' text. The 'Temporary Join Key' section consists of four input fields for 'Part 1 of 4 (HEX)', 'Part 2 of 4 (HEX)', 'Part 3 of 4 (HEX)', and 'Part 4 of 4 (HEX)', each containing seven asterisks. Below these is a 'Temporary Join Mode Time' dropdown menu set to '10min'. At the bottom are two buttons for 'Start Temporary Join Mode' and 'Stop Temporary Join Mode', both with '>>' text.

Parameters in "Security" window

Parameter	Meaning
Network Access Mode	Mode for the network access. <ul style="list-style-type: none"> Open: Opens the network. Whitelist: Opens the network for all field devices listed in the Whitelist. Temporary Join Mode Time: Opens the network for the time period specified via the "Temporary Join Mode Time" parameter. Closed: Closes the network.
Transfer Network to Whitelist	Copies the network's field devices to the Whitelist.
Temporary Join Key Part 1 of 4	Temporary network password, 8 hexadecimal numbers, part 1 of 4, temporarily overwrites the permanent network password
Temporary Join Key Part 2 of 4	Temporary network password, 8 hexadecimal numbers, part 2 of 4, temporarily overwrites the permanent network password
Temporary Join Key Part 3 of 4	Temporary network password, 8 hexadecimal numbers, part 3 of 4, temporarily overwrites the permanent network password
Temporary Join Key Part 4 of 4	Temporary network password, 8 hexadecimal numbers, part 4 of 4, temporarily overwrites the permanent network password
Temporary Join Mode Time	Time period for which the temporary join key is valid. You start the "Temporary Join Key" function via the "Start Temporary Join Mode" parameter. The function stops automatically when the specified time has elapsed. Alternatively, you can stop the function earlier via the "Stop Temporary Join Mode" parameter.
Start Temporary Join Mode	Starts the "Temporary Join Key" function.
Stop Temporary Join Mode	Stops the "Temporary Join Key" function before the specified "Temporary Join Mode Time" has elapsed.

Defining or changing the Whitelist

1. Click **Engineering > Security**.
2. In the **Network Access Mode** dropdown menu, select the **Open** option to open the network.
3. Click the >> button for the **Transfer Network to Whitelist** parameter.
4. A dialog appears. Note that once you confirm the displayed message, the current Whitelist will be changed. The previous version cannot be restored.
5. Click **Yes** to confirm. The Whitelist is generated. The specified field devices are highlighted in the **Whitelisted** column in the **Security** view.

The screenshot shows the Security configuration window. At the top, the Network Access Mode is set to 'Open'. Below it are fields for Temporary Join Key (Parts 1-4) and Temporary Join Mode Time (10min). There are buttons for 'Transfer Network to Whitelist', 'Start Temporary Join Mode', and 'Stop Temporary Join Mode'. Below the configuration fields is a table titled 'Security' with a 'Refresh' button. The table has columns: Long Tag, IO-Card, Channel, Device Type, Manufacturer, Extended Uniqu..., Com. Status, Dev. Status, Whitelisted, and Delete. The table contains several rows of device information, with some rows having a green checkmark in the 'Whitelisted' column.

Long Tag	IO-Card	Channel	Device Type	Manufacturer	Extended Uniqu...	Com. Status	Dev. Status	Whitelisted	Delete
STERNENHOF	251	1	SWG70	Endress+Hauser	11F180844E			<input type="checkbox"/>	
ANALYS_B3_EAST	1	0	SWA70	Endress+Hauser	11F076009E	✓	✓	<input type="checkbox"/>	
REP_AUDITORIUM_W...	12	0	SWA70	Endress+Hauser	11F06E0093	✓	✓	<input type="checkbox"/>	
TEMP_F2_NORD	2	0	SWA70	Endress+Hauser	11F06E00B2	✓	✓	<input type="checkbox"/>	
TEMP_B2_WEST	3	0	SWA70	Endress+Hauser	11F06E00AE	✓	✓	<input type="checkbox"/>	
REP_B2_SOUTH	4	0	SWA70	Endress+Hauser	11F06E0067	✓	✓	<input type="checkbox"/>	

6. In the **Network Access Mode** dropdown menu, change the **Open** option to **Whitelist**.
7. Confirm the displayed message with **Yes**.

All field devices highlighted as "Whitelisted" can be added to the network. Any attempt to add an unauthorized field device will be declined – even if the field device has a valid network ID and a join key.

Assigning a temporary join key

If you do not wish to reveal the permanent join key of your network, you can use the "Temporary Join Key" function. This temporary join key can be used, for example, to allow subcontractors to add field devices.

1. In the **Network Access Mode** dropdown menu, select the **Open** option to open the network.
2. Enter the temporary join key in the **Temporary Join Key Part 1 to 4 (HEX)** fields.
3. In the **Network Access Mode** dropdown menu, select the **Temporary Join Mode Time** option.
4. Select a time in the **Temporary Join Mode Time** field. Other field devices may be added to the network during this time.
5. For the **Start Temporary Join Mode** parameter, click the >> button to start the temporary connection mode.
6. For the **Transfer Network to Whitelist** parameter, click the >> button to copy all of the network's field devices to the Whitelist.
7. A dialog appears. Note that once you confirm the displayed message, the current Whitelist will be changed. The previous version cannot be restored.
8. Click **Yes** to confirm. The Whitelist is generated. The specified field devices are highlighted in the **Whitelisted** column in the **Security** view.
9. In the **Network Access Mode** dropdown menu, select the **Closed** option to close the network.

11 Additional Functions

Additional Functions contains a number of functions which may be required during the Fieldgate life-cycle but not for everyday operation. The functions offered depend upon the parametrization tool. In FieldCare the corresponding function is called by right-clicking on the Fieldgate SWG70 node and selecting **Additional Functions**.

11.1 Reset

Reset allows the Fieldgate, the instrument list and the network to be reset, see table. The reset is initiated by pressing the appropriate button. During reset, communication with the network will be temporarily lost.

1. Click **Additional Functions**> **Reset** to open the dialog:

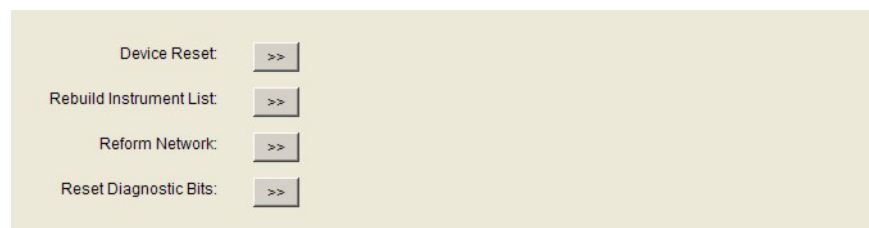

Reset options

Parameter group	Meaning
Device Reset	Click this button to restart Fieldgate without any impact on the established network. - Fieldgate SWG70 is restarted with all user settings intact.
Rebuild Instrument List	Click this button to regenerate the instrument list. - Create a backup of the existing instrument list before resetting. See Chapter 10.1. - The existing instrument list is overwritten. - The Modbus addresses of the devices in the network may change.
Reform Network	Click this button to restart and reestablish the network. - The existing instrument list is overwritten. - The Modbus addresses of the devices in the network may change. - Depending on the size of the network, this process may take some minutes.
Reset Diagnosis Bits	Click this button to reset the diagnosis bits in Fieldgate SWG70.

11.2 Self Test

Self test invokes a self testing procedure for Fieldgate SWG70.

1. Click **Additional Functions**> **Self Test** to open the dialog:

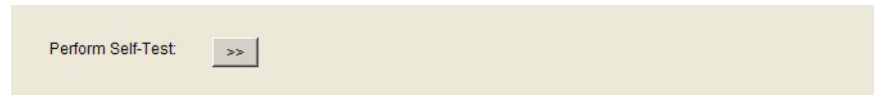

2. For this, click the **Perform Self-Test** button in the dialog.
 - Call this function in FieldCare by right-clicking Fieldgate SWG70 and then selecting the **Self Test** option in the context menu.
3. The results can be seen in the first two sections of the HART diagnosis dialog: **Diagnostics =>Wired Communication =>HART** dialog. See Chapter 9.3.2 "HART" on page 60.

11.3 Firmware Upgrade (Web Server)

Firmware Upgrade allows new firmware to be downloaded to the Fieldgate.

1. Click **Additional Functions** => **Firmware Upgrade** to open the dialog:

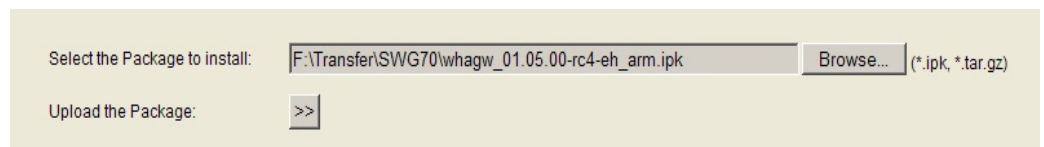

2. Browse to the folder or location where the firmware package is to be found (*.ipk, *.tar.gz)
3. Click to Upload the Package >>
 - The following page appears:

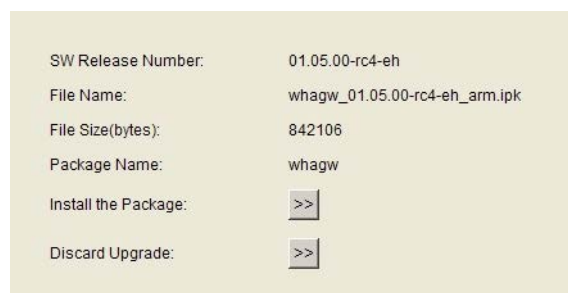

4. Click the **Install the Package** >> button to install the firmware.
 - To cancel the firmware upgrade, press **Discard Upgrade**.
5. The package will now be installed.
 - The installation process may take a while.
 - When the installation is finished, **Installation Successfully Completed** together with a log is displayed on the screen.
6. After installation, Fieldgate SWG70 restarts with the new firmware.
 - The network configuration of the old firmware is retained.

11.4 Change Password (Web Server)

To change the password for the web server, you must be logged in as "Administrator".

1. Click **Additional Functions > User Level**.

2. For the **Change User Level** parameter, click the >> button if you are not logged in as administrator. The Login dialog opens.
3. Enter the old password in the **Enter the old password** field.
4. Enter the new password in the **Enter a new password** and **Confirm new password** fields.
5. For the **Change password** parameter, click the >> button to download the new password.

11.5 Set DTM Addresses (DTM)

Set DTM Addresses allows the user to match the addressing in the DTM, i.e. the Long Tag in WirelessHART networks, to the physical devices. Any change must also be duplicated in the **Set Device Addresses** window (see Chapter 8.6.7), otherwise the DTM is not able to establish a connection to the adapter. See Chapter 11.6 "Set Device Addresses (DTM)" on page 109. Changes should be made only after all adapter DTMs have been closed. The function is not relevant to FieldCare but might be required for other FDT frames.

1. Click **Additional Functions => Set DTM Addresses** to open the dialog:

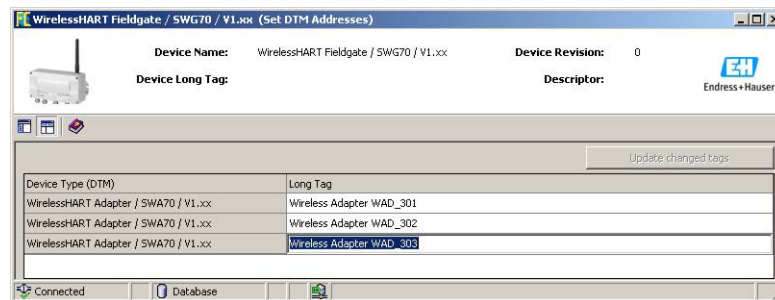

To change the DTM address:

2. Place the cursor inside a cell of the **Long Tag** column.
3. Change the device long tag as required. You may change the long tags of several devices at once, if needed.
4. Close any DTM dialogs of the devices whose long tags are to be changed.
5. To apply the new DTM address(es) press **Update Changed Tags**.
6. The new DTM addresses are displayed in the project view of FieldCare.

11.6 Set Device Addresses (DTM)

Set Device Addresses displays all adapters, together with their wired connections, that can be seen in the network. The device address is the device long tag stored in the device. Call this function in FieldCare by right-clicking Fieldgate SWG70 and then selecting the **More Functions => Set Device Addresses** options in the context menu.

Set DTM Addresses allows the user to match the address of a physical device, e.g. the Long Tag in WirelessHART networks, to the address saved in the DTM. The function is not relevant to FieldCare but might be required for other FDT frames.

1. Click **Additional Functions> Set Device Addresses** to open the dialog:

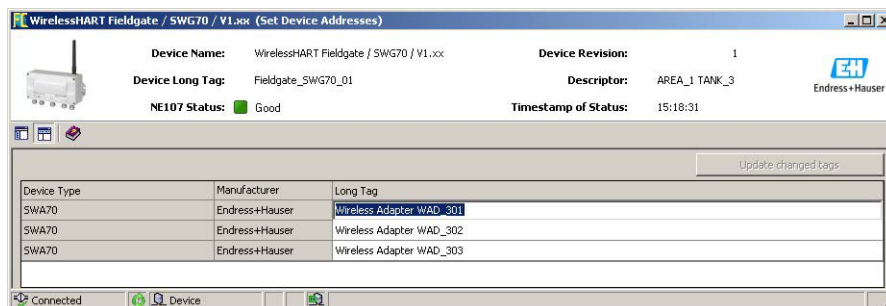

To change the device address:

2. Place the cursor inside a cell of the **Device Long Tag** column.
3. Change the device long tag as required. You may change the long tags of several devices at once, if needed.
4. To apply the new DTM address(es) press **Update Changed Tags**.
 - The new DTM addresses are stored to the devices.
 - **Refresh** updates the list.

11.7 Upload Certificate (Web server)

11.7.1 Self-signed security certificate

A digital certificate is an electronic document that binds a public key with an identity, for example, an organization or a user. The binding between a public key and the identity is done by a signature. This signature can be self-signed or authenticated by a certification authority.

Fieldgate SWG70 is delivered with a self-signed certificate for the HTTPS connection. If the web browser is unable to verify the authenticity of a self-signed certificate, a warning message appear:



You can proceed to the web server by clicking the appropriate option below the message.

11.7.2 Trusted security certificate

If you wish to avoid the security message, a trusted certificate must be obtained from a certification authority. This is usually connected with a fee and applies to one Fieldgate only.

On registering the web server you will receive files containing a certificate and a private key. As your computer is probably not connected to the Internet, these should be available on its hard disk or a USB stick before the certificate is uploaded to Fieldgate SWG70. Now proceed as follows:

1. Click on the **Additional Functions => Upload Certificate** leaf to open the dialog.

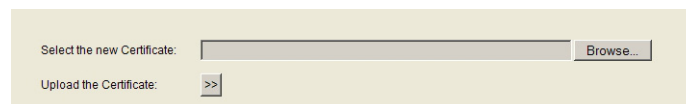

2. Click **Browse** and select the certificate file on the hard disk or USB stick.
3. Click >> to upload the certificate.
4. The **Upload Private Key** option appears: Click **Browse ...** and select the private key on the hard disc or USB stick.
5. Click >> to upload the private key.
6. The **Change Certificate and Private Key** option appears: Click >> to install the trusted certificate.
7. Go to **Additional Functions => Device Reset** and perform a device reset for the changes to take effect.

If the trusted certificate has been installed successfully, the address bar in the web browser displays a padlock icon,.

NOTICE

NOTICE!

- In some cases, you must also install the certificate locally on your operating system.
 - If so, click the warning message in the address bar of the web browser and select more information on the certificate.
 - In the following window, click **Install Certificate** and follow the instructions of the installation wizard.

11.8 Auto Refresh

All parameter values for the web server and the Fieldgate DTM are updated automatically in the factory.

1. Click **Additional Functions > Auto Refresh**.

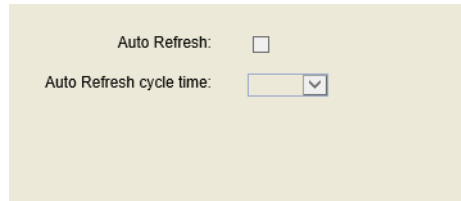

Auto Refresh:

Auto Refresh cycle time: ▾

Parameter

Parameter	Meaning
Auto Refresh	Activate or deactivate the "Auto Refresh" function.
Auto Refresh Cycle Time	Enter interval for automatic refresh.

12 Measurement

The Measurement table provides a comprehensive overview of all cached parameters and values of all sub-devices.

- As the list is stored in a non-volatile memory, the card and channel number assignment will remain the same after a restart of the Fieldgate or software.
- The dynamic values of each sub-device (analogue value, PV, SV, TV, QV) are cached by the Fieldgate only if the sub-device publishes these values.
- After a network restart, the instrument list needs time to rebuild. During this time, some information is set to 0 or replaced by wildcard characters.
- To remove a device from the list, use the Instrument List. See Chapter 10.1 "Instrument List" on page 62.

Whenever a new wireless device joins the network, it is automatically inserted into the list. Wired HART devices connected to a WirelessHART Adapter (SWA70) are also listed.

1. Click on the **Measurement**, leaf to open the dialog:
 - In FieldCare right-click on the Fieldgate SWG70 node and select **Observe**.

Long Tag	IO-Card	Channel	Device Type	Com. Status	Dev. Status	Loop Curr...	PV	SV	TV	QV
Fieldgate_SWG70_01	251	1	SWG70							
Wireless Adapter WAD...	1	0	SWA70	☑	☑	-/-	0.000000...	22.79999...	6.970000 V	-/-
TT301	1	1	TMT162	☑	☑	4.000000...	22.39291...	22.28518...	22.39291...	-/-
LT304	1	1	FMISx	☑	☑	4.000000...	224.5170...	45.55297...	23.00000...	-/-
LT305	1	1	FMU4x	☑	☑	4.000000...	33.29723...	21.76443...	-/-	-/-
Wireless Adapter WAD...	2	0	SWA70	☑	☑	0.000000...	0.000000...	27.29999...	-28.00000...	11185.0595...
TT303	2	1	TMT182	☑	☑	15.34105...	367.0527...	24.67886...	-/-	-/-
Wireless Adapter WAD...	3	0	SWA70	☑	☑	11.98427...	11.98427...	25.60000...	-40.00000...	1405.938721 d
PT306	3	1	CerabarS	☑	☑	11.99462...	-0.000673...	-0.000676...	-0.002449...	21.570496 °C

Parameter	Meaning
Long Tag	Identifies Fieldgate within the plant network - For HART 5.0 or lower, the texts in the "Message" parameter
IO card	Indicates the virtual I/O card number to which the device is mapped
Channel	Indicates the channel of the virtual I/O card to which the device is mapped
Device Type	Displays the device type as registered at the HART Communication Foundation
Status	Displays the communication status - ☑ Connected - ⚠ Flashing: Devices connected, identification in progress - ⚠ Continuous: Devices connected but not identified - ❌ Communication failure
Dev. Status	Displays the device status - ☑ Good - ⚠ Out of specification - ❌ Failure The device status displayed in the Operating Modes list may differ from the actual device status because the HART status bits may be interpreted differently.
Loop current	Current in mA (for HART Multidrop = 4 mA)
PV	Primary value of the device
SV	Secondary variable of the device
TV	Tertiary variable of the device
QV	Quaternary variable of the device
"+", "-"	Expands or contracts the tree view
Refresh	Click this button to reload the operational mode parameters of all network devices

13 Maintenance and repair

13.1 Maintenance

No special maintenance work is required for the Fieldgate SWG70.

13.2 Return to Endress+Hauser.

Fieldgate SWG70 must be returned if repairs are required or if the wrong device has been ordered or delivered. According to legal regulations, Endress+Hauser, as an ISO-certified company, is required to follow certain procedures when handling returned products, especially those that have been in contact with medium.

To ensure swift, safe and professional device returns, please read the return procedures and conditions on the Endress+Hauser website at www.services.endress.com/return-material.

13.3 Disposal

Fieldgate SWG70 must be disposed of in accordance with national regulations.

13.4 Contact addresses

Contact addresses can be found on our homepage at www.addresses.endress.com/world-wide. For inquiries, service etc. please contact your local Endress+Hauser Sales Center or Representative.

13.5 Accessories and spare parts

See the Technical Information document for "WirelessHART Fieldgate SWG70" (TI00027S) for accessories and spare parts.

14 Troubleshooting

14.1 Faults indicated by Fieldgate LEDs

	LED indication	Problem/Remedy
1	Red LED is lit	<ul style="list-style-type: none"> ■ Hardware fault which makes normal operation of the Fieldgate impossible. <ul style="list-style-type: none"> - Send Fieldgate back for repair.
2	Red LED flashes	<ul style="list-style-type: none"> ■ Under certain conditions the LED flashes while the Fieldgate application tries to eliminate the fault. <ul style="list-style-type: none"> - If this indication persists, even after a reboot, send the Fieldgate back for repair.

14.2 Wired Communication Faults

Fieldgate error messages are displayed in plain text in the **Diagnosis** leaf of the DTM, See Chapter 9 "Diagnostics" on page 53.

The following table summarizes the more common problems which might occur during commissioning and operation of the WirelessHART Fieldgate SWG70.

	Problem	Cause/Remedy
1	The computer is not able to establish an Ethernet connection to the Fieldgate although the Fieldgate and the computer are connected to the Ethernet.	<ul style="list-style-type: none"> ■ The Fieldgate is connected to the Ethernet with a standard cable although a crossover connection is necessary (or vice versa). <ul style="list-style-type: none"> - Wire in accordance with the table in Chapter 5.3. ■ The Ethernet parameters of the Fieldgate are incorrect. <ul style="list-style-type: none"> - Check the Fieldgate's Ethernet parameters (see Chapter 8.4.3) ■ The Local Area Connection Properties of your PC are not configured correctly. <ul style="list-style-type: none"> - Configure the Local Area Connection according to the instructions given (see Chapter 7.1). ■ If you are parameterizing via the web interface: Maybe your web browser uses proxies. <ul style="list-style-type: none"> - Deactivate proxies in your browser. ■ Firewall blocking communication. <ul style="list-style-type: none"> - Configure firewall to allow communication through ports 80, 443, 502 and 5094.
2	The computer is not able to establish a serial connection to the Fieldgate or the signal is of poor quality.	<ul style="list-style-type: none"> ■ The terminating resistor is not activated. <ul style="list-style-type: none"> - If the RS-485 cable ends at the Fieldgate (Fieldgate is last device), activate the terminating resistor via the DIP switch inside the Fieldgate housing (see Chapter 8.4.4) or via the DTM (see Chapter 6.1.3.). ■ Check cabling.

14.3 Wireless Communication Faults

	Problem	Cause/Remedy
1	Fieldgate SWG70 cannot find a WirelessHART device in the network.	<ul style="list-style-type: none"> ■ The device has not yet joined the network. <ul style="list-style-type: none"> - The joining process may take a while. - Check the join status in the Fieldgate's Instrument List. - Alternatively, check the wireless communication parameters (join status) of the device via a HART modem connected to the device. ■ The device carries the wrong network ID and/or the wrong join key. <ul style="list-style-type: none"> - Check the wireless communication parameters of the device via a HART modem connected to the device. The device and the Fieldgate must have the same network ID and join key.
2	The wireless connection to a WirelessHART device is poor and disappears from time to time.	<ul style="list-style-type: none"> ■ There are not enough neighboring WirelessHART devices within the device's antenna range. <ul style="list-style-type: none"> - Check the number of neighbors Diagnosis > Wireless Communication - There should be at least 2 neighbors. ■ Signal too weak <ul style="list-style-type: none"> - Check the signal level of next neighbor in the device diagnosis - this must be larger than -80 dBm if the network is to work properly. - Improve signal strength by repositioning the antenna or adding adapters as repeaters. ■ Walls or other static/moving objects block the radio signals, or the antenna is not aligned vertically. <ul style="list-style-type: none"> - Reposition the Fieldgate or use an external antenna.
3	The Network ID and the Join Key cannot be downloaded to Fieldgate SWG70.	<ul style="list-style-type: none"> ■ The security DIP switch 8 is OFF. <ul style="list-style-type: none"> - Set DIP switch 8 to ON. If the Fieldgate is installed in hazardous areas Zone 2, switch off the voltage supply before doing this. - If you want to continue using security mode, set the DIP switch 8 to OFF, after the Network ID and Join Key have been downloaded.
4	A device appears with a yellow icon in the instrument list.	<ul style="list-style-type: none"> ■ Either the device or the communication is faulty.
5	A device appears with a red icon in the instrument list.	<ul style="list-style-type: none"> ■ The device is faulty. ■ The network was switched off for some time, but the device has continued transmitting. <ul style="list-style-type: none"> - The device has gone into prolonged sleep mode. - Either wait until the device reappears (waiting time depends on how long the network was not present) or press the adapter's push button for 5 seconds to force joining.
6	A device is present in the network, but bursting is interrupted.	<ul style="list-style-type: none"> ■ The field device is being configured locally by a modem. When a modem is communicating with the adapter, it is impossible to measure the loop current and bursting is disabled. Bursting will restart when the modem is disconnected.

14.4 Error messages of the WirelessHART OPC server in the "Event Viewer" window

If the WirelessHART OPC server is used, the following messages may appear in Windows Event Viewer.

	Error message	Cause/Remedy
1	The WirelessHART OPC Server cannot connect to the configured Fieldgate because of wrong Ethernet IP address or port settings. Please make sure that the network is functional and the Ethernet IP address and port settings are correct.	The Ethernet configuration data are not valid. Check the network configuration parameters.
2	The WirelessHART OPC Server cannot connect to the configured Fieldgate because of the wrong HART bus address. Please check the configured HART bus address.	The HART bus address of the field device is not the same as that configured in the OPC server. Either change the address of the Fieldgate or the address in the "WirelessHART Fieldgate OPC Configurator".
3	The WirelessHART OPC Server cannot connect to the Fieldgate with the configured long tag "%s". Please check either the configuration of the long tag or the network settings of the attached Fieldgate.	The "Long Tag" of the Fieldgate is not the same as that configured in the WirelessHART OPC server. Either change the "Long Tag" of the Fieldgate or the "Device Name" in the "WirelessHART Fieldgate OPC Configurator".
4	The WirelessHART OPC Server cannot connect to the configured Fieldgate because of a general communication problem. Please make sure that the network is functional.	The WirelessHART OPC server cannot establish communication with the Fieldgate. General problems such as timeouts, lost or incomplete data telegrams, electrical interference etc. can cause this problem. Check the stability of the network function. If necessary, consult your IT department.
5	The WirelessHART OPC Server configuration was not found. The default configuration is used. Please use the 'WirelessHART OPC Server Configurator' to apply changes to the configuration.	Unable to find the configuration file of the WirelessHART OPC server. The default configuration file is used. Restart the program "WirelessHART Fieldgate OPC Configurator", in order to update the configuration.
6	The WirelessHART OPC Server configuration is corrupted. The default configuration is used. Please use the 'WirelessHART OPC Server Configurator' to apply changes to the configuration.	The configuration file of the WirelessHART OPC server is not valid. The default configuration file is used. Restart the program "WirelessHART Fieldgate OPC Configurator", in order to update the configuration.

15 Technical data

www.endress.com

For the technical data, see the Technical Information document for "WirelessHART Fieldgate SWG70" (TI00027S).

W@M Device Viewer

Alternatively, you can also download all the associated technical documentation via the W@M Device Viewer. Enter the serial number of the WirelessHART Fieldgate on our website, "www.endress.com/deviceviewer". You can find the serial number on the nameplate.

16 Modbus Interface

NOTICE**NOTICE!**

- The "Modbus" function is only available on WirelessHART Fieldgate models with the version "SWG70-xx-1-xx-xx". See Chapter 2.3 "Ordering information" on page 10.

16.1 Introduction

16.1.1 Modbus protocol

Modbus is a quasi-industrial standard developed some years ago by Gould-Modicon, and provides a messaging service that may run on a variety of physical layers. For Fieldgate SWG70 there are two possibilities for connecting Modbus:

- Modbus RTU (also known as Serial) can be connected point-to-point to the RS-485 interface. See Chapter 5.4 "Connecting to RS-485" on page 24.
- Modbus TCP (also known as Modbus TCP/IP) can be connected to an Ethernet Interface. See Chapter 5.3 "Connecting to Ethernet" on page 22.

The Modbus protocol exchanges data in a master-slave relationship. Each slave has a unique address, and the data are identified by their location in the slave address register. Certain characteristics of the Modbus protocol are fixed, such as the frame format, frame sequences, handling of communications errors, exception conditions and the functions performed. Other characteristics are user selectable; these include transmission medium, baudrate, character parity, number of stop bits, and transmission modes. Chapter 8.3 describes how both Ethernet and Serial interfaces can be set up. The contents of the data carried by the protocol are also freely selectable, i.e. nothing is said about strings, integers, floating-point numbers etc.

The Modbus protocol controls the query and response cycle between master and slave devices. Only the master can initiate a transaction. A query and response may involve only a single slave, or it may be in the form of a broadcast, in which case the slaves do not answer. The query is contained in a frame that includes the address of the intended receiver, what this slave is to do, data needed to perform the action, and a means of checking for errors. The slave checks if errors have occurred and performs the desired action. After the action is performed the slave builds the response and returns it to the master. The master can send another message to any slave as soon as it receives a valid response or after a user-selected time interval.

Data can be exchanged in two transmission modes: ASCII (American Standard Code for Information Interchange) and RTU (Remote Terminal Unit). The major differences between them are the type of error check performed on the message and the number of characters used. Fieldgate SWG70 supports RTU only. Modbus offers several read, write and test functions, each identified by a code number. They are designed as control commands for sensors and actuators, e.g. coils, inputs, input registers, holding or output registers, diagnosis and test reports, programs, polling control and reset. For Modbus TCP the serial frame is simply inserted into the Ethernet data frame. In addition, not all codes are implemented.

Modbus overview

	Modbus RTU	Modbus TCP
Standard compliance	"Modbus over Serial Line" V1	"Modbus over TCP" V1
Physical layer	RS-485	Ethernet
Transmission mode	RTU (binary mode)	TCP
Baudrates	1200 bit/s, 2400 bit/s, 4800 bit/s, 9600 bit/s, 19200 bit/s, 38400 bit/s, 57600 bit/s, 115200 bit/s	100 MBit/s
Parity	Odd, Even, None	-
Stop bits	1; 1.5; 2	-
Polling address	1...247	-
Port No.	-	502
Capabilities	<ul style="list-style-type: none"> ▪ Input registers starting at Modbus address 30013 ▪ HART Command 3 dynamic variables mapped into input registers ▪ 2 input registers map a single HART dynamic variable ▪ 32bit HART floating point format used ▪ Status information mapped on dedicated input registers 	

16.1.2 Modbus in Fieldgate

Fieldgate SWG70 is equipped with both a Modbus serial and Ethernet interface. As a result, it can be operated in one of the following roles:

- Modbus Serial Slave
- Modbus TCP Slave

A serial or TCP slave can be accessed by one Modbus master only.

Establishing communication

As a TCP slave, Fieldgate SWG70 will normally communicate with the master via Port 502. If this port is unavailable, it is possible to specify a secondary TCP/IP port number.

Modbus commands

Fieldgate SWG70 support for Modbus functions is currently as follows:

Function	Function Code	Hex	Function supported
Read discrete inputs	2	0x02	Yes
Read coils	1	0x01	No
Write single coil	5	0x05	No
Write multiple coils	15	0x0F	No
Read input register	4	0x04	Yes
Read holding register	3	0x03	Yes
Write single register	6	0x06	No
Write multiple registers	16	0x10	No
Read/Write multiple register	23	0x17	No

Registers

Modbus specifies four different types of register:

- Discrete input registers contain the discrete input values and possibly status
- Input registers contain analog input values and status
- Coil registers contain discrete output values and possibly status
- Holding registers contain analog output values and status

In addition, it is possible to "pack" discrete inputs and outputs into words, which are then stored as appropriate in the input or holding registers.

Fig. 16-1 overleaf gives an overview of the register and reference address ranges used for each register type.

For Fieldgate, the holding registers are a read only image of the input registers which can be accessed when the Read Modbus Registers Mode is set to "Input and Holding". See Chapter 10.3.1.

HART implementation

The Modbus implementation in Fieldgate SWG70 maps HART dynamic process variables over Modbus input registers and also uses input registers to provide device-related status information. The Modbus implementation is based on the following assumptions:

- The HART Command 3 dynamic variables are used for automatic Modbus mapping.
- For Modbus access, publishing must be enabled for all relevant devices.
- The Fieldgate caches the relevant information. Modbus commands will therefore access the internal Fieldgate memory.
- Modbus input registers are only supported if they are associated with HART dynamic process variables.
- A device can either be a WirelessHART device or a wired HART device connected to a WirelessHART Adapter (SWA70).
- WirelessHART and wired HART devices are mapped independently within the Modbus input registers.

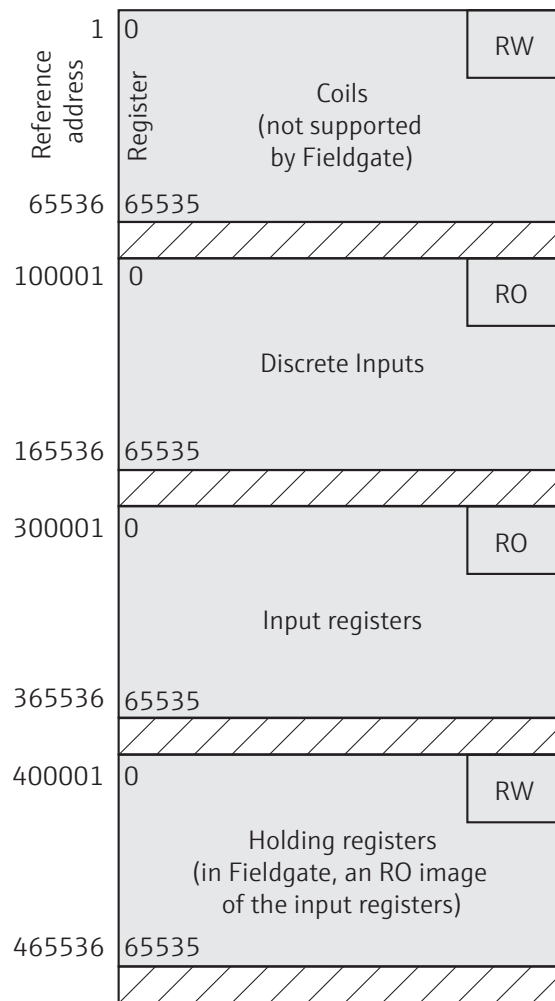

Fig. 16-1: Mapping of Modbus registers Fieldgate SWG70

Refresh time

Fieldgate SWG70 refreshes Modbus discrete inputs and input registers once every macro-cycle. The length of the macrocycle depends on the number of WirelessHART devices in the network, the response time of the devices and the number of parameters they transmit.

- In general, shorter refresh times can be attained by restricting the traffic over the network to essential parameters only.

16.1.3 Data types

Fieldgate SWG70 supports three different data types, which are interpreted and stored as described below:

- Floating point, Unsigned Integer16, Unsigned Integer8

Floating point

Value range	$(\pm) 1.175 * 10^{-38}$ to $3.403 * 10^{38}$	
Byte Structure	<p>31 23 0 Sign Exponent (8 bit) Fraction (23 bit)</p>	
Byte Structure	Float	Swapped Float
Modbus Register 1	15 0 	31 16
Modbus Register 2	31 16 	15 0

Unsigned16

Value range	0 to 65.535	
Byte Structure	<p>15 0 Value (16 bit)</p>	
Byte Structure	Unsigned Integer16	Swapped Unsigned Integer16
Modbus Register 1	15 0 	15 0

Unsigned8

Value range	0 to 255	
Byte Structure	<p>15 7 0 Value (8 bit)</p>	
Byte Structure	Unsigned Integer8 (Integer 8 without sign)	Swapped Unsigned Integer8
Modbus Register 1	15 7 0 	15 7 0

16.2 Rules for mapping

16.2.1 Automatic mapping of analog devices (HART CMD 3)

Each HART device is mapped into 12 consecutive Modbus input registers. The order of HART device mapping starting from register 13 is the same as the order of the sub-device identity summary (returned by HART CMD84). For example, the HART device with the sub-device index=1 is mapped starting at register 13. The device with the sub-device index = 2 is mapped starting at register 25, and so on.

To find out the starting register reference address of a certain sub-device, use the following formula:

- $SMIR = 300013 + 12 * (SDI - 1)$
- SMIR: is the starting Modbus input register of the associated HART device
- SDI: is the sub-device index value.

The following table shows an example of the mapping of the first two HART devices, i.e. the ones associated with SDI=1 and SDI=2. The assigned Modbus registers can be viewed in the Input Status and Input Register dialogs. See Chapter 10.3.3 "Input Register" on page 73.

Example of Modbus mapping of HART CMD 3

Reference address			Modbus RTU	Format:	Sub-device index
300013	300014	AI	Primary variable (loop current, mA unit)	32-bit floating point	1
300015	300016	PV	Primary variable (device-specific unit)		
300017	300018	SV	Secondary variable (device-specific unit)		
300019	300020	TV	Ternary variable (device-specific unit)		
300021	300022	QV	Quaternary variable (device-specific unit)		
300023	-	ModStat	Modbus Specific Status	16-bit unsigned integer	
300024	-	DevStat	HART Device Status		
300025	300026	AI	Primary variable (loop current, mA unit)	32-bit floating point	2
300027	300028	PV	Primary variable (device-specific unit)		
300029	300030	SV	Secondary variable (device-specific unit)		
300031	300032	TV	Ternary variable (device-specific unit)		
300033	300034	QV	Quaternary variable (device-specific unit)		
300035	-	ModStat	Modbus Specific Status	16-bit unsigned integer	
300036	-	DevStat	HART Device Status		

Modbus Specific Status

Bit	Parameter	Description
0x01 (LSB)	Cache validity	Set to 1 when the HART CMD 3 cache of the device is empty.
0x02 (LSB)	Identification ongoing	Set to 1 when the gateway is performing a device identification procedure.
0x04 (LSB)	Device off-line	Set to 1 when the device is offline

HART Device Status

Bit	Parameter	Description
0x80	Device malfunction	Device in the network has malfunctioned
0x40	Configuration changed	Configuration of a device in the network has changed
0x20	Cold start	Device in the network has cold start flagged
0x10	More status available	Device in the network has more status available flagged
0x08	Loop current fixed	Loop current of a device in the network is fixed to 4 mA (multidrop mode)
0x04	Loop current saturated	Loop current of a device in the network above 20 mA
0x02	Non-primary variable out of limits	SV, TV, QV of a device in the network is out of limits
0x01	Primary variable out of limits	PV of a device in the network is out of limits

16.2.2 Digital input/output devices

There is no automatic mapping of the Input Status registers. The user must generate the mapping table either semi-automatically or manually.

- A semi-automatic mapping will duplicate the values entered under the "Generate" tab for all devices in the network, irrespective of device type
- A manual mapping allows the table to be built up for each individual device (recommended)

Discrete devices publish their values by "bursting" HART CMD 64386. This tells Fieldgate SWG70 how many discrete values a device has as well as the index of the first discrete value. A maximum of 256 discrete values can be mapped for each device. At the moment, Fieldgate SWG70 does not map the status of the device.

Each discrete value is published as a UNIT16. Fieldgate SWG70 first splits the data into two bytes then reserves 8 registers for each byte, i.e. one for each bit.

- The **Least Significant Byte** (x) maps Bits 0 - 7 of the value with Index x
- The **Most Significant Byte** (x) maps Bits 8 - 15 of the value with Index x

Index "x" is not determined by the position of the discrete value in the device burst list but rather by its position in CMD 64385. For example, if the 1st and 4th discrete variables are selected in the burst list, the corresponding indexes are "0" and "3". Assuming that all bytes are of interest, the user must enter the following lines:

- Tag Device 1: Least Significant Byte 0
- Tag Device 1: Most Significant Byte 0
- Tag Device 1: Least Significant Byte 3
- Tag Device 1: Most Significant Byte 3

The following (manual) mapping table results:

Reference address	Device	Discrete Variable	Bit	Byte (Variable Index)
100001	Device 1	Variable 1	Bit 0	LSB (0)
100002	Device 1	Variable 1	Bit 1	LSB (0)
...				
100007	Device 1	Variable 1	Bit 6	LSB (0)
100008	Device 1	Variable 1	Bit 7	LSB (0)
100009	Device 1	Variable 1	Bit 8	MSB (0)
100010	Device 1	Variable 1	Bit 9	MSB (0)
...				
100015	Device 1	Variable 1	Bit 14	MSB (0)
100016	Device 1	Variable 1	Bit 15	MSB (0)
100017	Device 1	Variable 4	Bit 0	LSB (3)
...				
100025	Device 1	Variable 4	Bit 7	LSB (3)
100026	Device 1	Variable 4	Bit 8	MSB (3)
...				
100032	Device 1	Variable 4	Bit 15	MSB (3)
...				

When Fieldgate SWG70 receives CMD 64.386, it checks whether the variables have been mapped, then enters the associated information. Any values that are not mapped are discarded.

16.3 Mapping formats

16.3.1 Dynamic process variables

For each HART device, the 5 possible Command 3 floating-point dynamic variables are sequentially mapped (units code values are not mapped). If a device does not support a specific dynamic value, a "NaN" (Not a Number) floating-point value is returned (namely, 0x7F, 0xA0, 0x00, 0x00).

The CMD3 dynamic variables follow the IEEE-754 (IEC559) single-precision floating-point format.

1-bit Sign of Fraction	8-bit Exponent	23-bit Fraction
------------------------	----------------	-----------------

The same format is also used for the Modbus 32-bit floating point values.

The Modbus protocol does not explicitly specify any 32-bit data element. However, the usage of 2 consecutive 16-bit registers is the de-facto standard way to map a single-precision IEEE-754 floating-point value. The Modbus floating value will be transmitted in the "big-endian" or "little endian" style according to the swap selection in the Modbus dialog. See Chapter 8.4.4 "AMS via Ethernet" on page 52.

For example, the number 123456.00 as defined in the IEEE-754 standard appears as follows:

Byte 0	Byte 1	Byte 2	Byte 3
0x00	0x20	0xF1	0x47

This number will be transmitted from the Fieldgate to the Modbus master in the following sequence:

- 47 F1 20 00

in "big-endian" style where "00" – the less significant byte – is the first one to be transmitted. The sequence can be changed to "little-endian". See Chapter 10.3.1 "Modbus Settings" on page 68.

16.3.2 Status mapping

For each HART device, two 16-bit unsigned input registers are used to map the relevant status information. The status information is delivered as a series of independent flags. Within an input register, the unused bits are always returned as "0".

- ModStat: Modbus Specific Status
 - Bit 0: Cache validity
 - Bit 1: Identifications
 - Bits 2 – 15: Not used
- DevStat: The "Device Status" information according to the HART 7 specification
 - Bit 0: Primary variable out of limits
 - Bit 1: Non-primary variable out of limits
 - Bit 2: Loop current saturated
 - Bit 3: Loop current fixed
 - Bit 4: More status available
 - Bit 5: Cold start
 - Bit 6: Configuration changed
 - Bit 7: Device malfunction

For more information see the Modbus Specific Status and HART Device Status tables. See Chapter 16.2 "Rules for mapping" on page 123.

16.3.3 HART CMD48 Read Additional Status Information

Command 48 returns device status information not included in the response code or device status byte of Command 3. All field devices support at least bytes 0 ... 8. If a field device supports more than one analog channel, then bytes 9 ... 13 will be supported as well.

Response Data Bytes

Byte	Parameter	Description
0	Extended device malfunction (Device-specific status 0)	<ul style="list-style-type: none"> ▪ 0x01 Manager fault ▪ 0x02 Non-Volatile Memory Defect ▪ 0x04 Volatile Memory Defect ▪ 0x08 Ethernet communication fault ▪ 0x10 Wired Device Duplicated ▪ 0x20 Long Tag Duplicated ▪ 0x40 Electronic defect ▪ 0x80 RS-485 communication fault
1	Gateway Operation in Progress (Device-specific status 1)	<ul style="list-style-type: none"> ▪ 0x02 Block transfer (not currently supported) ▪ 0x04 Delayed answer ▪ 0x08 Self-test (not currently supported) ▪ 0x20 Device List update ▪ 0x40 Network Manager Reset In Progress ▪ 0x80 Start-up phase
2	Extended Lists Changes (Device-specific status 2)	<ul style="list-style-type: none"> ▪ 0x01 Instrument List Changed ▪ 0x04 Active Device List changed
3	Cumulative Device Status (Device-specific status 3)	<ul style="list-style-type: none"> ▪ 0x01 Primary Variable Out of Limits ▪ 0x02 Non-Primary Variable Out of Limits ▪ 0x04 Loop Current Saturated ▪ 0x08 Loop Current Fixed ▪ 0x10 More Status Available ▪ 0x20 Cold Start ▪ 0x40 Configuration Changed ▪ 0x80 Device malfunction
4	Cumulative Extended Device Status (Device-specific status 4)	<ul style="list-style-type: none"> ▪ 0x01 Maintenance Required ▪ 0x02 Device Variable Alert ▪ 0x04 Critical Power Failure
5	Device Operation in Progress (Device-specific status 5)	<ul style="list-style-type: none"> ▪ 0x02 "Configuration Changed bit reset" procedure ▪ 0x04 "Sub-Device update" procedure ▪ 0x08 "Device update" procedure
6	Extended device status	Not relevant for Gateway, always set to "0"
7	Device operating mode	For future expansions, always set to "0"
8	Standardized status 0	<ul style="list-style-type: none"> ▪ 0x01 Simulation active The device is in simulation mode and one or more of its device variables are not representative of the process. ▪ 0x02 Non-volatile memory defect The non-volatile memory check is invalid or maybe corrupt, or the battery of a battery-powered memory is defective ▪ 0x04 Volatile memory defect The RAM memory check is invalid or maybe corrupt. ▪ 0x08 Watchdog reset executed A watchdog reset has been executed. ▪ 0x10 Power supply conditions out of range The power supply is outside its allowable range. ▪ 0x20 Environmental conditions out of range An internal or environmental condition is beyond acceptable limits. ▪ 0x40 Electronic defect A hardware problem not related to the sensor has been detected.
9	Standardized status 1	For future expansions, always set to "0"
10	Analog channel saturated	Not relevant for Gateway, always set to "0"
11	Standardized status 2	<ul style="list-style-type: none"> ▪ 0x01 Sub-device list changed When set, the I/O system has lost communication with one of its sub-devices or discovered a new sub-device. This bit is reset if command 74 "Number of devices detected" is issued. The current sub-device list is read using command 84. ▪ 0x02 Duplicate master detected The adapter has discovered another master with the same address connected to its token-passing interface.

16.3.4 Read Digital Inputs

HART Specification 285 describes the requirements for discrete and hybrid field devices. A digital device will return binary values only. A hybrid device may return both analog and binary values. Digital inputs are read using HART command 64.386 which returns a block of binary variables (values and status). The length of the data string depends upon the device polled. For further details, please consult the device manual.

Request Data Bytes		
Byte	Format	Description
0-1	Unsigned16	Index of First Binary Variable to read
2	Unsigned8	Number of Binary Variables to read (n)
Response Data Bytes		
Byte	Format	Description
0-1	Unsigned16	Index of first Binary Variable Returned
2	Unsigned8	Number of Binary Variables returned (n)
3	Bits-8	Extended Device Status
4-7	Time	Time stamp for most recent change to Actual Value of first Discrete Variable Value
8-9	Unsigned16	First Discrete Variable Value
10	Bits-8	First Discrete Variable Status <ul style="list-style-type: none"> ▪ 0x01: 1 = Binary Variable in Simulation or Local Override ▪ 0x02: 1 = Binary Variable in Fault Mode ▪ 0x02-0x04: Reserved, bit set to zero
11-12	Unsigned16	Second Binary Variable Value
13	Bits-8	Second Binary Variable Status
.....		
3n+8-3n+9	Unsigned16	Last Binary Variable Value
3n+10	Bits-8	Last Binary Variable Status
Command-Specific Response Codes		
Code	Class	Description
0	Success	No Command-Specific Errors
1	Undefined	
2	Error	Invalid Selection
3-4	Undefined	
5	Error	Too Few data Bytes Received
6	Error	Device-Specific Command Error
7	Undefined	
7	Undefined	
8	Warning	Set to nearest value
9-15	Undefined	
16	Error	Access Restricted
17-127	Undefined	

17 CSV file formats

NOTICE

NOTICE!

- This section on "CSV file formats" is only relevant for Fieldgate versions with Modbus. The "Modbus" function is only available on WirelessHART Fieldgate models with the version "SWG70-xx-1-xx-xx". See Chapter 2.3 "Ordering information" on page 10.

17.1 Structure of the CSV files

When creating or editing CSV files for import into Fieldgate SWG70, the following rules apply:

- Use a semicolon ";" as separator for the values in the CSV file. If a value already contains a semicolon you must put the value into quote signs. If the value already contains quote signs, put the entire value into quote signs and replace the original quote signs with double quote signs.

Example!

The value - this is a "long tag" that contains quote signs - must be entered like this: "this is a "long tag" that contains quote signs"

- Avoid special characters. They can easily be corrupted or they can cause the whole data row to be skipped during the import of the CSV file.
- Avoid leading blanks, trailing blanks, and tabs, especially for integer or hexadecimal values.
- Respect the data type of each column.
- If a mandatory column is missing, the whole file is rejected and nothing is imported.
- If a mandatory value is missing, the corresponding data row is skipped.

17.2 Modbus Mapping CSV files

The files for MODBUS mapping contain the following columns

Expanded Device Type Code	Device ID	IO-Card	Channel	Long Tag	Registers	Register Type	Information Code	Mapping Code
4 digits hex	6 digits hex	integer	integer	string [32]	integer	integer	integer	integer
-	-	-	-	mandatory	mandatory	mandatory	mandatory	mandatory

The data in the RegisterType, InformationCode, and MappingCode columns is encoded as described in the tables below.

Register Type Codes

Value	Description
1	Discrete Input
3	Input Register

Information Code

Value	Description
0	HART Status (RegisterType Code = 3)
1	CMD 48 Status (RegisterType Code = 3)
2	Device Variables (RegisterType Code = 3)
3	Modbus Status (RegisterType Code = 3)
4	Discrete Variables LSB (RegisterType Code = 1)
5	Discrete Variables MSB (RegisterType Code = 1)
6	Network Statistic (RegisterType Code = 3)

Note that the Mapping Codes depend on the Information Code, see the following table.

Information Code	Value	Description
0 (HART Status)	0	Device Status
	1	Extended Device Status
	2	Device Status & Extended Device Status
1 (CMD 48 Status)	0 ... 12	CMD 48 status word to be mapped
	0	maps CMD 48 bytes 0&1
	1	maps CMD 48 bytes 2&3
	...	and so on
	12	maps CMD 48 byte 24 only
2 (Device Variable)	0 ... 242	Device Variables For more information on what device-specific information is available and on the device specific unit codes, see the manual of the subdevice.
	243	Battery Life
	244	Percent Range
	245	Loop Current
	246	Primary Variable
	247	Secondary Variable
	248	Tertiary Variable
	249	Quaternary Variable
	255	Slot 0 data time stamp
	3 (Modbus Status)	0
4 (Discrete Variable - LSB)	0 ... 255	Binary Variable Index The least significant byte of the variable is mapped.
5 (Device Variable - MSB)	0 ... 255	Binary Variable Index The most significant byte of the variable is mapped.
6 (Network Statistic)	0	Reliability
	1	Stability
	2	Latency
	3	Lost Upstream Packets
LSB: least significant byte, MSB: most significant byte		

17.3 Instrument List CSV files

The files for the instrument list contain the following columns:

Type Code	Device ID	IO-Card	Channel	Long Tag
4 digits hex	6 digits hex	integer	integer	string[32]
				mandatory

17.4 Topology View CSV file

The files for the topology view contain the following columns.

Expanded Device Type Code	Device ID	IO-Card	Channel	Long Tag	Units Code	Range	X-Coordinate	Y-Coordinate	Z-Coordinate
4 digits hex	6 digits hex	integer	integer	string[32]	integer	float	float	float	float
-	-	-	-	mandatory	-	mandatory	mandatory	-	-

Note that the X- and Y-origins of the background image are not part of the CSV file, as these coordinates are related to the background image.

17.5 Details

The files you can export under **Diagnostics > Wireless Communication > Details** contain the following columns. There are no mandatory columns as there is no import function. Nevertheless, you can export the data in CSV format for documentation.

Expanded Device Type Code	Device ID	IO-Card	Channel	Long Tag	Status	Device Status	Number Of Joins	Recent Join Date	Reliability	Latency	Neighbors	RSSI	Stability
4 digits hex	6 digits hex	integer	integer	string[32]	2 digits hex	2 digits hex	integer	yyyy: mm:dd hh:mm:ss	float	float	string[32]	integer	float

18 Table Device Variable Classification and Unit Code

Device Variable Classification	Classification Code	Unit Code	Description
Generic	0	240-249	Enumeration may be used for manufacturer specific
Generic	0	249	definitions
Generic	0	250	Not Used
Generic	0	251	None
Generic	0	252	Unknown
Generic	0	253	Special
Temperature	64	32	Degrees Celsius
Temperature	64	33	Degrees Fahrenheit
Temperature	64	34	Degrees Rankine
Temperature	64	35	Kelvin
Pressure	65	1	inches of water at 68 degrees F
Pressure	65	2	inches of mercury at 0 degrees C
Pressure	65	3	feet of water at 68 degrees F
Pressure	65	4	millimeters of water at 68 degrees F
Pressure	65	5	millimeters of mercury at 0 degrees C
Pressure	65	6	pounds per square inch
Pressure	65	7	bars
Pressure	65	8	millibars
Pressure	65	9	grams per square centimeter
Pressure	65	10	kilograms per square centimeter
Pressure	65	11	pascals
Pressure	65	12	kilopascals
Pressure	65	13	torr
Pressure	65	14	atmospheres
Pressure	65	145	inches of water at 60 degrees F
Pressure	65	170	centimeters of water at 4 degrees C
Pressure	65	171	meters of water at 4 degrees C
Pressure	65	172	centimeters of mercury at 0 degrees C
Pressure	65	173	pounds per square foot
Pressure	65	174	hectoPascals
Pressure	65	175	pounds per square inch absolute
Pressure	65	176	kilograms per square meter
Pressure	65	177	feet water 4 degrees C
Pressure	65	178	feet water at 60 degrees F
Pressure	65	179	meters of mercury at 0 degrees C
Pressure	65	180	1E6 psi million pounds per square inch
Pressure	65	237	megapascals
Pressure	65	238	inches of water at 4 degrees C
Pressure	65	239	millimeters of water at 4 degrees C
Volumetric Flow	66	15	cubic feet per minute
Volumetric Flow	66	17	liters per minute
Volumetric Flow	66	18	imperial gallons per minute
Volumetric Flow	66	19	cubic meter per hour
Volumetric Flow	66	22	gallons per second
Volumetric Flow	66	23	million gallons per day
Volumetric Flow	66	24	liters per second
Volumetric Flow	66	25	million liters per day
Volumetric Flow	66	26	cubic feet per second
Volumetric Flow	66	27	cubic feet per day
Volumetric Flow	66	28	cubic meters per second
Volumetric Flow	66	29	cubic meters per day
Volumetric Flow	66	30	imperial gallons per hour
Volumetric Flow	66	31	imperial gallons per day
Volumetric Flow	66	121	normal cubic meter per hour MKS System

Device Variable Classification	Classification Code	Unit Code	Description
Volumetric Flow	66	122	normal liter per hour MKS System
Volumetric Flow	66	123	standard cubic feet per minute U.S. System
Volumetric Flow	66	130	cubic feet per hour
Volumetric Flow	66	131	cubic meters per minute
Volumetric Flow	66	132	barrels per second
Volumetric Flow	66	133	barrels per minute
Volumetric Flow	66	134	barrels per hour
Volumetric Flow	66	135	barrels per day
Volumetric Flow	66	136	gallons per hour
Volumetric Flow	66	137	imperial gallons per second
Volumetric Flow	66	138	liters per hour
Volumetric Flow	66	170	beer barrels per second
Volumetric Flow	66	171	beer barrels per minute
Volumetric Flow	66	172	beer barrels per hour
Volumetric Flow	66	173	beer barrels per day
Volumetric Flow	66	174	normal liter per day
Volumetric Flow	66	175	normal liter per minute
Volumetric Flow	66	176	normal liter per second
Volumetric Flow	66	177	standard liter per day
Volumetric Flow	66	178	standard liter per hour
Volumetric Flow	66	179	standard liter per minute
Volumetric Flow	66	180	standard liter per second
Volumetric Flow	66	181	normal cubic meter per day
Volumetric Flow	66	182	normal cubic meter per minute
Volumetric Flow	66	183	normal cubic meter per second
Volumetric Flow	66	184	standard cubic feet per day
Volumetric Flow	66	185	standard cubic feet per hour
Volumetric Flow	66	186	standard cubic feet per second
Volumetric Flow	66	187	standard cubic meter per day
Volumetric Flow	66	188	standard cubic meter per hour
Volumetric Flow	66	189	standard cubic meter per minute
Volumetric Flow	66	190	standard cubic meter per second
Volumetric Flow	66	235	gallons per day
Velocity	67	20	feet per second
Velocity	67	21	meters per second
Velocity	67	114	inches per second
Velocity	67	115	inches per minute
Velocity	67	116	feet per minute
Velocity	67	120	meters per hour
Volume	68	40	gallons
Volume	68	41	liters
Volume	68	42	imperial gallons
Volume	68	43	cubic meters
Volume	68	46	barrels
Volume	68	110	bushels
Volume	68	111	cubic yards
Volume	68	112	cubic feet
Volume	68	113	cubic inches
Volume	68	124	bbl liq
Volume	68	166	normal cubic meter MKS System
Volume	68	167	normal liter MKS System
Volume	68	168	standard cubic feet U.S. System
Volume	68	170	beer barrel
Volume	68	171	standard liter
Volume	68	172	standard cubic meter
Volume	68	236	hectoliters
Length	69	44	feet
Length	69	45	meters

Device Variable Classification	Classification Code	Unit Code	Description
Length	69	47	inches
Length	69	48	centimeters
Length	69	49	millimeters
Length	69	151	feet in sixteenths
Length	69	170	µm micron
Length	69	171	µin microinch
Time	70	50	minutes
Time	70	51	seconds
Time	70	52	hours
Time	70	53	days
Time	70	170	ms milliseconds
Time	70	171	µs microseconds
Time	70	172	ns nanoseconds
Mass	71	60	grams
Mass	71	61	kilograms
Mass	71	62	metric tons
Mass	71	63	pounds
Mass	71	64	short tons
Mass	71	65	long tons
Mass	71	125	ounce
Mass Flow	72	70	grams per second
Mass Flow	72	71	grams per minute
Mass Flow	72	72	grams per hour
Mass Flow	72	73	kilograms per second
Mass Flow	72	74	kilograms per minute
Mass Flow	72	75	kilograms per hour
Mass Flow	72	76	kilograms per day
Mass Flow	72	77	metric tons per minute
Mass Flow	72	78	metric tons per hour
Mass Flow	72	79	metric tons per day
Mass Flow	72	80	pounds per second
Mass Flow	72	81	pounds per minute
Mass Flow	72	82	pounds per hour
Mass Flow	72	83	pounds per day
Mass Flow	72	84	short tons per minute
Mass Flow	72	85	short tons per hour
Mass Flow	72	86	short tons per day
Mass Flow	72	87	long tons per hour
Mass Flow	72	88	long tons per day
Mass per Volume	73	90	specific gravity units
Mass per Volume	73	91	grams per cubic centimeter
Mass per Volume	73	92	kilograms per cubic meter
Mass per Volume	73	93	pounds per gallon
Mass per Volume	73	94	pounds per cubic foot
Mass per Volume	73	95	grams per milliliter
Mass per Volume	73	96	kilograms per liter
Mass per Volume	73	97	grams per liter
Mass per Volume	73	98	pounds per cubic inch
Mass per Volume	73	99	short tons per cubic yard
Mass per Volume	73	100	degrees twaddell
Mass per Volume	73	102	degrees baume heavy
Mass per Volume	73	103	degrees baume light
Mass per Volume	73	104	degrees API
Mass per Volume	73	146	micrograms per liter
Mass per Volume	73	147	micrograms per cubic meter
Mass per Volume	73	148	percent consistency
Mass per Volume	73	170	milligrams per liter
Viscosity	74	54	centistokes

Device Variable Classification	Classification Code	Unit Code	Description
Viscosity	74	55	centipoise
Viscosity	74	170	Ps-s Pascal second
Angular Velocity	75	117	degrees per second
Angular Velocity	75	118	revolutions per second
Angular Velocity	75	119	revolutions per minute
Energy (Work)	77	69	joule
Energy (Work)	77	89	Dth deka therm / MMBtu Million British thermal unit
Energy (Work)	77	126	foot pound force
Energy (Work)	77	128	kilo watt hour
Energy (Work)	77	162	mega calorie
Energy (Work)	77	164	mega joule
Energy (Work)	77	165	Btu British thermal unit
Force	78	68	N Newton
Force	78	170	kN kilo Newton
Power	79	127	kilo watt
Power	79	129	horsepower
Power	79	140	mega calorie per hour
Power	79	141	mega joule per hour
Power	79	142	British thermal unit per hour
Power	79	170	MJ/s megajoules per second / MW Megawatt
Power	79	171	MJ/d megajoules per day
Power	79	172	MMBtu/s million British thermal units per second
Power	79	173	MMBtu/h million British thermal units per hour
Power	79	174	MMBtu/d million British thermal units per day
Power	79	127	kilo watt
Power	79	129	horsepower
Power	79	140	mega calorie per hour
Power	79	141	mega joule per hour
Power	79	142	British thermal unit per hour
Power	79	170	MJ/s megajoules per second / MW Megawatt
Power	79	171	MJ/d megajoules per day
Power	79	172	MMBtu/s million British thermal units per second
Power	79	173	MMBtu/h million British thermal units per hour
Power	79	174	MMBtu/d million British thermal units per day
Frequency	80	38	hertz
Analytical	81	57	percent
Analytical	81	59	pH
Analytical	81	150	percent steam quality
Analytical	81	160	percent plato
Analytical	81	161	percent lower explosion level
Capacitance	82	153	picofarads
Electromotive / Electric Potential / EMF	83	36	millivolts
Electromotive / Electric Potential / EMF	83	58	volts
Current	84	39	milliamperes
Current	84	39	milliamperes
Current	84	170	nA: nanoamperes
Current	84	171	µA: microamperes
Current	84	170	nA: nanoamperes
Current	84	171	µA: microamperes
Resistance	85	37	ohms
Resistance	85	163	kohms
Resistance	85	170	MOhm mega ohms
Resistance	85	171	Ohm cm
Resistance	85	172	kOhm cm
Resistance	85	173	MOhm cm
Resistance	85	174	mΩ milli Ohms
Resistance	85	37	Ohms
Resistance	85	163	kilo ohms

Device Variable Classification	Classification Code	Unit Code	Description
Resistance	85	170	mega ohms
Resistance	85	171	Ohm cm
Resistance	85	172	kohm Cm
Resistance	85	173	MOhm cm
Resistance	85	174	milli Ohms
Angle	86	143	degrees
Angle	86	144	radian
Angle	86	143	degrees
Angle	86	144	radian
Conductance	87	56	microsiemens
Conductance	87	66	milli siemens per centimeter
Conductance	87	67	micro siemens per centimeter
Conductance	87	56	microsiemens
Conductance	87	66	milli siemens per centimeter
Conductance	87	67	mmm siemens per centimeter conductivity
Volume Per Volume	88	149	volume percent
Volume Per Volume	88	154	milliliters per liter
Volume Per Volume	88	155	microliters per liter
Volume per Volume	88	149	volume percent
Volume per Volume	88	154	milliliters per liter
Volume per Volume	88	155	microliters per liter
Volume per Mass	89	107	degrees balling
Volume per Mass	89	152	cubic feet per pound
Volume per Mass	89	107	degrees balling
Volume per Mass	89	152	cubic feet per pound
Concentration	90	57	Percent
Concentration	90	105	percent solids per weight
Concentration	90	106	percent solids per volume
Concentration	90	108	proof per volume
Concentration	90	109	proof per mass
Concentration	90	139	ppm parts per million
Concentration	90	169	ppb parts per billion
Concentration	90	101	°Bx degrees brix
Concentration	90	170	ppth parts per thousand
Acceleration	96	170	g - Gravitational Acceleration
Acceleration	96	171	feet per second
Acceleration	96	172	meter per second squared
Turbidity	97	170	FNU: Formazin Nephelometric Units ISO
Turbidity	97	171	FTU: Formazin Turbidity Unit
Turbidity	97	172	NTU: Nephelometric Turbidity Unit
Volumetric Gas Flow per Second	99	186	standard cubic feet per second
Volumetric Gas Flow per Second	99	176	normal liter per second
Volumetric Gas Flow per Second	99	180	standard liter per second
Volumetric Gas Flow per Second	99	183	normal cubic meter per second
Volumetric Gas Flow per Second	99	190	standard cubic meter per second
Volumetric Gas Flow per Minute	100	123	standard cubic feet per minute
Volumetric Gas Flow per Minute	100	175	normal liter per minute
Volumetric Gas Flow per Minute	100	179	standard liter per minute
Volumetric Gas Flow per Minute	100	182	normal cubic meter per minute
Volumetric Gas Flow per Minute	100	189	standard cubic meter per minute
Volumetric Gas Flow per Hour	101	185	standard cubic feet per hour
Volumetric Gas Flow per Hour	101	122	normal liter per hour
Volumetric Gas Flow per Hour	101	178	standard liter per hour
Volumetric Gas Flow per Hour	101	121	normal cubic meter per hour
Volumetric Gas Flow per Hour	101	188	standard cubic meter per hour
Volumetric Gas Flow per Day	102	184	standard cubic feet per day
Volumetric Gas Flow per Day	102	174	normal liter per day
Volumetric Gas Flow per Day	102	177	standard liter per day

Device Variable Classification	Classification Code	Unit Code	Description
Volumetric Gas Flow per Day	102	181	normal cubic meter per day
Volumetric Gas Flow per Day	102	187	standard cubic meter per day
Volumetric Liquid Flow per Second	103	174	Imperial Fluid ounces per second
Volumetric Liquid Flow per Second	103	175	US Fluid ounces per second
Volumetric Liquid Flow per Second	103	176	milliliter (cc) per second
Volumetric Liquid Flow per Second	103	24	liters per second
Volumetric Liquid Flow per Second	103	178	hectoliter per second
Volumetric Liquid Flow per Second	103	28	cubic meter (kiloliter) per second
Volumetric Liquid Flow per Second	103	180	million liters (megaliter) per second
Volumetric Liquid Flow per Second	103	22	US gallons per second
Volumetric Liquid Flow per Second	103	182	US kilogallon per second
Volumetric Liquid Flow per Second	103	183	US million gallons per second
Volumetric Liquid Flow per Second	103	137	imperial gallons per second
Volumetric Liquid Flow per Second	103	185	imperial million gallons per second
Volumetric Liquid Flow per Second	103	26	cubic feet per second
Volumetric Liquid Flow per Second	103	187	Acre–Feet per second
Volumetric Liquid Flow per Second	103	188	US drum per second
Volumetric Liquid Flow per Second	103	189	US liquid barrel per second
Volumetric Liquid Flow per Second	103	170	US beer barrel per second
Volumetric Liquid Flow per Second	103	132	Oil barrels per second
Volumetric Liquid Flow per Second	103	192	UK beer barrel per second
Volumetric Liquid Flow per Minute	104	174	Imperial Fluid ounces per minute
Volumetric Liquid Flow per Minute	104	175	US Fluid ounces per minute
Volumetric Liquid Flow per Minute	104	176	milliliter (cc) per minute
Volumetric Liquid Flow per Minute	104	17	liters per minute
Volumetric Liquid Flow per Minute	104	178	hectoliter per minute
Volumetric Liquid Flow per Minute	104	131	cubic meter (kiloliter) per minute
Volumetric Liquid Flow per Minute	104	180	million liters (megaliter) per minute
Volumetric Liquid Flow per Minute	104	16	US gallons per minute
Volumetric Liquid Flow per Minute	104	182	US kilogallon per minute
Volumetric Liquid Flow per Minute	104	183	US million gallons per minute
Volumetric Liquid Flow per Minute	104	18	imperial gallons per minute
Volumetric Liquid Flow per Minute	104	185	imperial million gallons per minute
Volumetric Liquid Flow per Minute	104	15	cubic feet per minute
Volumetric Liquid Flow per Minute	104	187	Acre–Feet per minute
Volumetric Liquid Flow per Minute	104	188	US drum per minute
Volumetric Liquid Flow per Minute	104	189	US liquid barrel per minute
Volumetric Liquid Flow per Minute	104	170	US beer barrel per minute
Volumetric Liquid Flow per Minute	104	133	Oil barrels per minute
Volumetric Liquid Flow per Minute	104	192	UK beer barrel per minute
Volumetric Liquid Flow per Hour	105	174	Imperial Fluid ounces per hour
Volumetric Liquid Flow per Hour	105	175	US Fluid ounces per hour
Volumetric Liquid Flow per Hour	105	176	milliliter (cc) per hour
Volumetric Liquid Flow per Hour	105	138	liters per hour
Volumetric Liquid Flow per Hour	105	178	hectoliter per hour
Volumetric Liquid Flow per Hour	105	29	cubic meter (kiloliter) per hour
Volumetric Liquid Flow per Hour	105	180	million liters (megaliter) per hour
Volumetric Liquid Flow per Hour	105	136	US gallons per hour
Volumetric Liquid Flow per Hour	105	182	US kilogallon per hour
Volumetric Liquid Flow per Hour	105	183	US million gallons per hour
Volumetric Liquid Flow per Hour	105	30	imperial gallons per hour
Volumetric Liquid Flow per Hour	105	185	imperial million gallons per hour
Volumetric Liquid Flow per Hour	105	130	cubic feet per hour
Volumetric Liquid Flow per Hour	105	187	Acre–Feet per hour
Volumetric Liquid Flow per Hour	105	188	US drum per hour
Volumetric Liquid Flow per Hour	105	189	US liquid barrel per hour
Volumetric Liquid Flow per Hour	105	172	US beer barrel per hour
Volumetric Liquid Flow per Hour	105	134	Oil barrels per hour

Device Variable Classification	Classification Code	Unit Code	Description
Volumetric Liquid Flow per Hour	105	192	UK beer barrel per hour
Volumetric Liquid Flow per Day	106	174	Imperial Fluid ounces per day
Volumetric Liquid Flow per Day	106	175	US Fluid ounces per day
Volumetric Liquid Flow per Day	106	176	milliliter (cc) per day 10 ⁻³ Liter
Volumetric Liquid Flow per Day	106	177	Liters per day
Volumetric Liquid Flow per Day	106	178	Hectoliter per day
Volumetric Liquid Flow per Day	106	19	cubic meter (kiloliter) per day
Volumetric Liquid Flow per Day	106	25	million liters (megaliter) per day
Volumetric Liquid Flow per Day	106	235	US gallons per day
Volumetric Liquid Flow per Day	106	182	US kilogallon per day
Volumetric Liquid Flow per Day	106	23	US million gallons per day
Volumetric Liquid Flow per Day	106	31	imperial gallons per day
Volumetric Liquid Flow per Day	106	185	imperial million gallons per day
Volumetric Liquid Flow per Day	106	27	cubic feet per day
Volumetric Liquid Flow per Day	106	187	Acre-Feet per day
Volumetric Liquid Flow per Day	106	188	US drum per day
Volumetric Liquid Flow per Day	106	189	US liquid barrel per day
Volumetric Liquid Flow per Day	106	173	US beer barrel per day
Volumetric Liquid Flow per Day	106	135	Oil barrels per day
Volumetric Liquid Flow per Day	106	192	UK beer barrel per day
Thermal Expansions	107	170	/C
Thermal Expansions	107	171	/F
Miscellaneous	-	156	dB: Decibel
Volumetric Energy Density	-	170	kJ/l kilojoules per liter
Volumetric Energy Density	-	171	Btu/ft ³ British thermal units per cubic foot

Index

A

Age Threshold Error	101
Age Threshold Warning	101
AMS Ethernet port	52
Antenna	16
Automatic mapping	123

B

Burst Lists	56
Burst message monitoring	101
Burst OPC Data Items	85
Buttons	28

C

Cable glands	25
Cache	14
Commissioning	6, 31
Configuration	42
CSV files	128

D

Data types	122
Degree of protection	25
Device Variable Codes	87
Diagnostics	53, 56–57, 60, 114
DIP switches	29
Discreet field devices	99
Downstream Communication	99

E

Electrical symbols	8
Ethernet	22, 31, 48

F

Factory Acceptance Test	103
FAT	103
Field devices with wireless	11
FieldCare	31, 34

G

Global Age Threshold Error	101
Global Age Threshold Warning	101

H

HART CMD 3	123, 125
HART CMD 48	126
HART CMD 64386	127
HART communication parameters	51
HART IP CommDTM	34, 36–37
Hazardous areas	6

I

Identification	42, 53
Input Register	73
Input Status	69
Installation	6
Instrument list	13, 62–64

Interfaces	48–49
------------------	-------

L

LEDs	27
------------	----

M

Message monitoring	101
Modbus interface parameters	50
Modbus Mapping	68–69, 73
Modbus RTU	118
Modbus Settings	68
Modbus TCP	118
Mounting	19

N

Nameplate	9
Network management	12

O

On-change update mode	100
Online Parameterization	42
OPC server	
Burst configuration	84
Configuring	78
OPC tunnel	78
OPC WirelessHART network	
System architecture	77
Operating elements	26
Ordering information	10
Overview	54–55, 59–60

P

Parameter	42, 53–55
Power supply	21
Protocols	50, 52

R

Repair	113
Reset	106
Reset options	106
RS-485	24, 34

S

Scope of delivery	9
Security	103
Security management	12
Self Test	107
Serial parameters	49
Set Device Addresses	109
Storage and transport	9
Substitution value	100

T

Technical data	117
Topology View	57, 65
Type of protection	8

U

User interface 40

W

W@M Device Viewer 117

Web server 31

Website Security Certificate 110

Whitelist 103

Wired Communication 59–60

Wireless Communication 54, 56–57

WirelessHART Fieldgate 11

WirelessHART Fieldgate OPC Configurator 78, 81

WirelessHART network 11

WirelessHART OPC server
Configuration 76

WirelessHART protocol 11

www.addresses.endress.com
