

SWG 100

biogas

USER MANUAL



Die leeren Seiten der Bedienungsanleitung sind kein Fehler
sondern herstellungsbedingt erforderlich!

The blank pages of the operating instructions are not a mistake
but due to manufacturing required!

Пустые страницы в инструкции по эксплуатации не ошибка,
а требуется производством!

Les pages vides sont pas fauses, mais dûs à la production requise!

Content

1. General Information	6
1.1. Weather and environmental conditions	6
1.2. Installation instructions	6
1.3. General important instructions for the plant operator	6
1.4. Important information about the user's operation manual	7
1.5. Safety Information	7
1.6. Packing	9
1.7. Return of hazardous waste	9
1.8. Return of analyzer	9
1.9. MRU Warranty conditions	9
2. Analyzer Description	11
2.1. Intended use	11
2.2. Type plate	11
2.3. Possible applications and analyzer options	12
2.4. Principle of operation	12
2.5. Special functions of the analyzer	14
2.6. Physical characteristic of the gas analyzer	15
3. Scope of supply and delivery	17
4. SD-card content	18
5. Installation manual	19
5.1. Overview	19
5.2. Installation of the analyzer	20
5.3. Connection of main power supply	22
5.4. I/O modules: Installation and setting	23
6. Operation of the analyzer (HMI)	25
6.1. Display and keypad	25
7. Analyzer commissioning manual	26
7.1. Check country and language	26
7.2. Check date and time of the instrument	26
7.3. Configuration of the alarm relays	27
7.4. Configuration of the Modbus	29
8. Binding to a process control system: I/O modules	31
8.1. Position of the IO module inside the analyzer	31
8.2. Pin assignment	32
8.3. Analog outputs 4-20 mA	34
8.4. Alarm outputs	40
8.5. Analog inputs (4-20 mA)	45
8.6. Configuration of the external control (Option: IO module)	50
8.7. Mounting and installation of the gas cylinders for the auto calibration function	57
8.8. Cycle configuration	60
8.9. Administrator PIN code	66
8.10. Power-On of analyzer	66
9. Operating the analyzer	67
9.1. General process of the measurement cycle	67
9.2. Data Storage Menu	70
9.3. Extra menu: Overview	74
9.4. Update the firmware	83

10. Service and maintenance.....	87
10.1. Preparing and information about the maintenance	87
10.2. Regular maintenance work by the operator	87
10.3. Position and overview of the service-parts.....	88
10.4. Troubleshooting	95
11. Technical specification	96
11.1. Technical specification: Electrochemical sensors	98
11.2. Technical specification: NDIR-benches	99
12. APPENDIX.....	100
12.1. Modbus via RS485 specification	100
12.2. Analyser Status (address 0 and some mirror addresses)	104
12.3. Analyser System Alarm (address 2 and some mirror addresses).....	104
12.4. Spare parts list.....	105
13. Purchase options of the analyzer.....	108
13.1. Option: Electric sample gas cooler.....	108
13.2. Option: Cabinet heater.....	109
13.3. Option: Flame arrester.....	110
13.4. Option: Multiple sample point switching and monitoring (time sharing)	111
13.5. Option: Gas detector (%LEL CH4) to monitor air inside analyzer cabinet	112
13.6. Option: Extra IO module with 4 channel 4-20 mA.....	113
13.7. Option: H2S electrochemical cell measurement 0-2000ppm/4000ppm	114
13.8. Option: Extern condensate-trap.....	115
13.9. Option: RS485 to Profi-Bus converter.....	119
13.10. Option: RS485 to Ethernet converter	120
13.11. Configuration of the Ethernet module	121
13.12. Option: Connection the SWG100 with RS-485 converter to MRU4Win	128
13.13. Option: NDIR-bench for CH4/CO2 analysis, 0-100% / 0-100%	131
13.14. Option: H2 thermal conductivity detector measurement 0-100%.....	132
13.15. Option: NDIR-bench for 0-3.000ppm CO2/0-3.000...30.000ppm CH4	133
13.16. Option: Dilution-unit for H2S and CO electrochemical sensors	134
14. Declaration of conformity	140

Inspect Shipment for Damage

Carefully inspect the **entire shipment for damage in the presence of the shipper's agent**, removing packaging material if necessary. Note any damage to packaging **and/or goods on Packing List and have it signed by the shipper's agent prior to accepting the shipment**. Submit damage claim to MRU immediately.

NOTE: Damage claims not received by MRU within 3 days of receipt of shipment will not be accepted.

The products described in this manual are subject to continuous development and improvement and it is therefore acknowledged that this manual may contain errors or omissions. MRU encourages customer feedback and welcomes any comments or suggestions relating to the product or documentation.

Please forward all comments or suggestions to the Customer Feedback Department at the following address:

MRU GmbH
Fuchshalde 8 + 12
74172 Neckarsulm / Obereisesheim
GERMANY

Fon (+49) 71 32 99 62 0 (Reception)

Fon (+49) 71 32 99 62 61 (Service)

Fax (+49) 71 32 99 62 20

Email: info@mru.de

Homepage: www.mru.eu

This manual is intended solely as a guide to the use of the product.

MRU shall not be liable for any loss or damage whatsoever arising from content errors or misinterpretation of information's **from this manual** or any mis-use resulting from the use of this manual.

FOR MORE INFORMATIONS ABOUT COMPANY MRU PLEASE VISIT OUR WEBSITE

www.mru.eu



1. General Information

1.1. Weather and environmental conditions

The SWG100 BIOGAS analyser is designed for ambient temperatures of +5°C to +45°C (without cabinet heater) resp. -10°C to +45°C (with cabinet heater).

The analyser is designed for indoor mounting. In case of outdoor mounting it is important that the analyser is sufficiently protected against rain, sun and wind. In case of outdoor mounting under extreme environmental conditions like high humidity, salty sea air, etc. further protective measures are necessary. These should be clarified with the manufacturer (MRU).

Any additional protective measures for outdoor mounting have to be provided by the plant operator. The manufacturer (MRU) consults the plant operator in choosing appropriate protective measures.



NOTE

The SWG100Biogas analyser is designed for sampling biogas with condensate of max. 14ml/min.

If the sample biogas will be very wet (high condensate of more than 14ml/min), then – to protect the SWG100-Biogas analyser – please consider special precautions to remove the condensate.

If you not have your own feasible solution for this topic, please ask MRU.

1.2. Installation instructions

Installation instructions, which are described in chapter 3 of the operation manual, have to be strictly adhered to.



WARNING

Please check correct installation before powering up the analyzer!
Please operate the analyzer only in upright position!

1.3. General important instructions for the plant operator

To guarantee continuous operation of the SWG100 BIOGAS analyser, the functions, processes and operation of the analyser have to be monitored regularly by the plant operator – especially in case of any initial installation. Thus, it will be possible to take suitable measures to improve the availability and life time of the analyser.

As the plant operator gains more experience concerning the maintenance requirements of the analyser, the monitoring frequency may be reduced to more extended periods of time.

It is important that the filter-units, listed in chapter 10.1 of the operation manual, are checked regularly and, if necessary, service parts are changed.

IMPORTANT

In case of **not intended** use the guarantee will void. Regular controls, inspections and the exchange from polluted and exhausted filters by the operator are also an **important part of the determinations "not determined use"**- see chapter 10.1 regular maintenance work.

1.4. Important information about the user's operation manual

The users/operation manual is an important part of this delivery. It will explain how to use this analyzer properly and sets forth safety and environmentally friendly procedures.

It is the responsibility of all users to read and familiarize themselves with this manual, paying particular attention to the safety instructions.

The most important safety details are clearly marked with an attention sign.

1.5. Safety Information

The following safety procedures must be followed at all times. They are significant and essential part of this manual. Failure to follow safety procedures can result in the loss of your warranty claims.

Biogas or other similar gases (landfill gas, bio-methane, coal seam gas etc) is containing flammable gas component *CH₄* and toxic gas component as well (*H₂S* and *CO₂*).

Analyzer is continuously sampling a certain volume (approx. 50l/h) of the sample gas, and is venting it to ambient air.

For this reason, there are two aspects which must be considered:

Toxicity danger of sample gas**▲ WARNING*****Toxic gas***

Sample gas can contain toxic substances, which are harmful for health and can even cause death.

- It is the responsibility of analyzer user to ensure that person is skilled and trained in safety aspects of gases being analyzed and procedures to follow while using this instrument.
- Local regulations for possible exposure to toxic gases has to be known and obeyed by the user of the analyzer
- Using a personal gas detector inside the biogas plant is highly recommended since *H₂S* in higher (very dangerous) concentration cannot be detected by human nose. Only small concentrations around few ppm can be detected by human nose
- *CO₂* gas is heavier than air and therefore operator shall avoid working at underground levels. Beware of that *CO₂* is also odorless!
- It is not allowed to use the biogas analyzer in confined space or rooms without forced ventilation.

- Sample gas exiting the analyzer will flow in to the ambient air and only outdoor use or forced ventilation rooms are suitable for using the biogas analyzer.

Flammable gas



WARNING

Flammable gas

Biogas contains Methane (CH₄), which can be flammable.

Regarding flammable gases (e.g. *CH₄* methane) and operating-instruments in the hazardous areas, the user must also be able to recognize the area classification and be aware of using the instrument there. This area classification is country specific, please observe and adhere to it.

- Stationary analyzers are allowed to be mounted in hazardous area zone 2 only if they have the certificate of compliance. These instruments shall never be located in confined places or rooms without forced ventilation.

Only trained personnel should carry out installation of stationary instrument and/or maintenance, service and repair. Opening the stationary analyzer cabinet can expose personnel to injuries and shocks from electrical voltage!

Safety regulations

The analyzer may only be used as indicated in this manual. Our analyzers are checked according to the following regulations:

VDE 0411 (EN61010) and **DIN VDE 0701** before they leave the MRU GmbH factory. MRU technical products are designed and manufactured according to DIN 31000/VDE 1000 and UVV = VBG 4 of the professional guilds for fine mechanics and electrical engineering.

MRU GmbH assures that the analyzer complies to the essential requirements of the legal regulations of the member states of the electro-magnetic compatibility (89/336/EWG) and to the low-voltage regulations (3/23/EWG).

Specific safety regulations

No part of the analyzer, or any other metal parts & accessories shall be used as electric conductors.

The analyzer shall not be used in or under water.

The analyzer shall not be placed near or directly exposed to open fire or heat.

The analyzer shall avoid dropping.

WARNING

Acid substances

Moisture or condensate, being pumped out of the condensate outlet port can be slightly acidic.



- In case of skin contact IMMEDIATELY: clean affected parts of the body.
- Avoid getting liquid in eyes.

Please carefully clean all parts that come into contact with the condensate.

1.6. Packing

Packing regulation of 12.07.1991

If your local waste facility does not accept MRU packing materials for disposal, you may return it to MRU or our local sales representative. Packing materials returned to MRU must be returned prepaid.

1.7. Return of hazardous waste

Waste Disposal/Returns/Warranty -

MRU GmbH is required to accept the return of hazardous waste such as electro-chemical sensors that cannot be disposed of locally. Hazardous waste must be returned to MRU prepaid.

1.8. Return of analyzer

MRU GmbH is required to accept the return, for proper disposal, of all analyzers delivered after 13th of August 2005. Analyzers must be returned to MRU prepaid.

1.9. MRU Warranty conditions

The SWG100 BIOGAS warranty is 12 months.

1. The warranty on spare parts is 6 months.
2. The term of the warranty conditions starts as of the invoice date.
3. The warranty is void under the following conditions:

- Improper use.
- Improper application.
- Improper mounting.
- Deliberate or negligent destructions.
- External influence like dropping, impact, solvents, acids, gases, or transport damages. This includes damage, which is caused by exposure to high pollution and/or moisture (condensate) in the gas path.

4. As well excluded from the guarantee conditions are typical consumable- and spare parts.

5. Use of original MRU consumable parts and sensors is required to maintain the warranty.

6. Removal of tampering of the serial number type plate will void the warranty.

7. The service of a guarantee conditions will not enlarge the guarantee time. Demands because of consequential damages are excluded.

8. MRU is not responsible for the transport costs for the warranty or replacement.

9. MRU reserves the right, to determine individual conditions or exceptions. These will be separately communicated.

MRU GmbH

01.09.2014

2. Analyzer Description

2.1. Intended use

The instrument is intended for analyzing the composition of biogases / landfill gases and determine the concentration of several components like CH₄, CO₂, O₂ and H₂S. The instrument may optionally be equipped to monitor several sites in time sharing technique (cyclical one by one sampling).

In particular, the instrument is not foreseen to serve as a gas detector or safety device.

In case of unintended use, the warranty is void. Regular controls, inspections and the replacement of polluted and exhausted filters by the operator are also an important part of proper use. See chapter 10.1 regular maintenance work.

2.2. Type plate

The type plate of the analyzer contains important information about the analyzer. It can be found:

- The serial-no.
- The power supply.
- The installed measurement options.
- Date built.



Table information: See below

The table below shows, which kind of measurement options may be installed in the analyzer.

1.	O ₂ , H ₂ S, H ₂ , CO	Electrochemical sensor
2.	CH ₄ /CO ₂	NDIR-bench
3.	H ₂	Thermal conductivity detector.

2.3. Possible applications and analyzer options

The biogas analyzer SWG100 is the industrial measuring solution to be used with:

- biogas (anaerobic digestion) plants
- cogeneration heat and power engines (CHP)
- municipal or industrial waste water treatment sites
- coal seam gas sites (coal bed methane)
- food and animal waste processing plants
- biomethane (gas to grid) plants
- landfill sites

This analyzer can be equipped with additional options and/or additional accessories to full fill multiple other measuring tasks such as

- CH₄ and CO₂ NDIR measurement
- O₂ measurement with long-life EC cell
- H₂Slow measurement with protected EC cell using cutoff solenoid valve and air purge pump
- H₂Shigh measurement with EC cell
- H₂ measurement with EC cell
- CO measurement with EC cell
- Electric gas cooler (Peltier) with automatic condensate draining pump
- Multiple sampling point switchover from 2x up to a maximum of 10x sites
- Module with 4 channel analog outputs/inputs 4-20mA, with 2x "fail safe" alarm relays
- Converter module of RS485 into Profibus
- Cabinet heater for freeze protection

Ask our sales representatives for available options and accessories or check out our MRU website.

2.4. Principle of operation

- Sample gas from one or more sampling points is fed into the analyzer by dedicated ports. Internally mounted electric valves select one point at a time to feed sample gas to the analysis unit.
- The instrument is equipped with a non-dispersive infrared (NDIR) bench for analysis of *CO₂* and *CH₄*. Two separate infrared detectors for each *CO₂* and *CH₄* are included, each operating with a different optical path length and stabilized by referring to a reference detector. The IR source is a highly efficient and stable IR emitter, pulsed at a frequency of several Hertz. By design NDIR technique offers good stability and selectivity together with long life time of sensor (only limited by corrosion or dust, which can be prevented or removed by regular servicing the instrument).
- The instrument is optionally equipped with a number of electro-chemical sensors ECS in order to detect gas components like oxygen *O₂* or *H₂S*. Those sensors offer a reliable and effective way to detect the target gases. They are typically of limited life time (several years) but may be easily replaced once the end-of-life is reached.
- In regular time intervals the instrument automatically switches to purge the sensors with fresh (ambient) air for re-adjust the zero point.

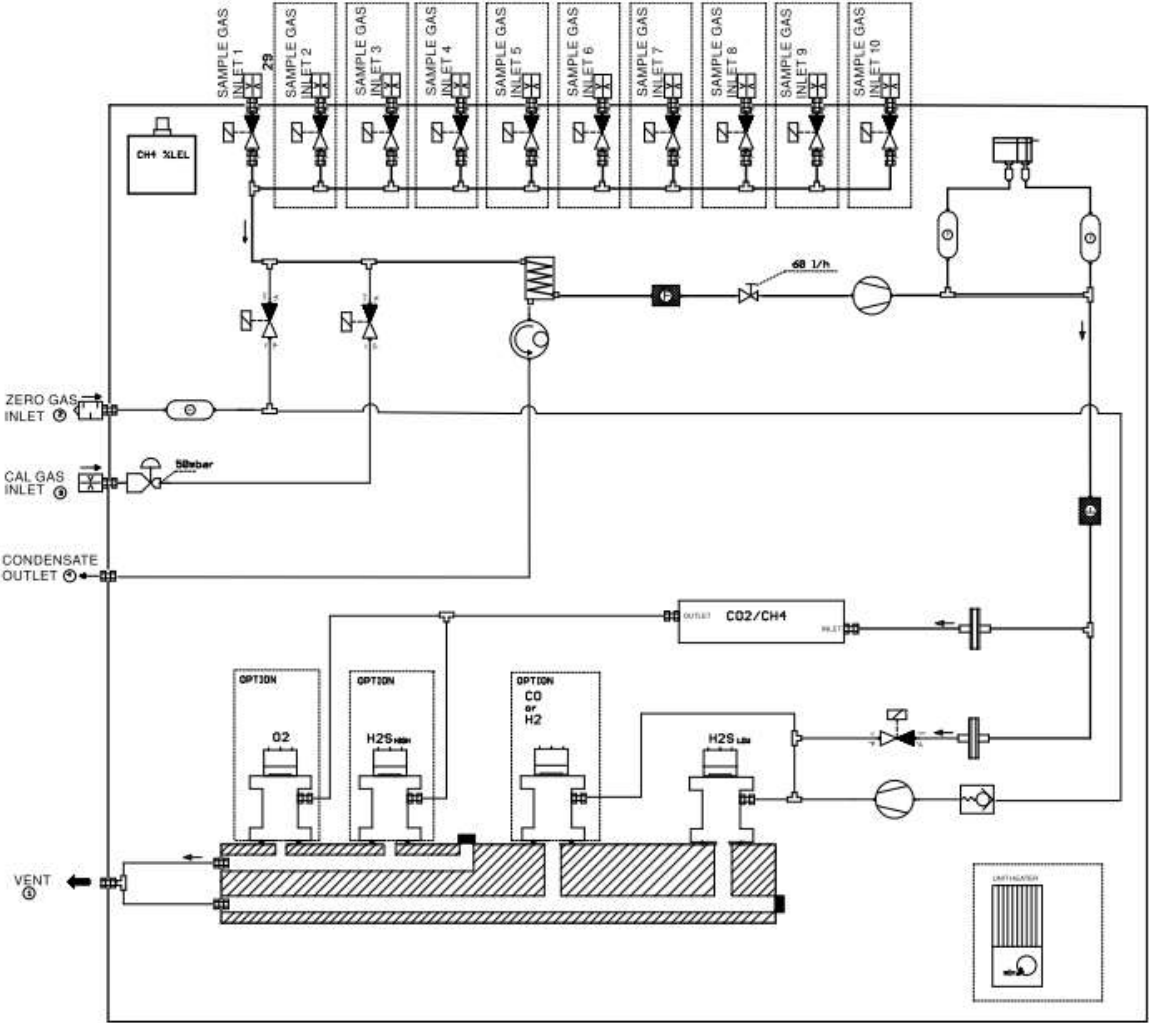

Picture above: Sample gas flow diagram.

2.5. Special functions of the analyzer

H₂S_{low} sensor protection (optional)

The instrument may be optionally equipped with a H₂S_{low} sensor. As this sensor typically shows limited life time when experiencing high H₂S concentrations, some precautions are taken to protect the sensor:

- The instrument is equipped with a cut-off solenoid valve and air purge pump to protect the H₂S_{low} sensor, without impacting the results of all other sensors.
- The purge unit is always activated after 3-10 minutes of active sensor measuring time.
- The measuring time of the H₂S_{low} sensor may be limited to less than 10 minutes by user setting
- The H₂S_{low} sensor may optionally not be included in all measuring cycles of sampling points. Instead the user may configure that the H₂S_{low} sensor is active only added at some of the measurement cycles.

2.6. Physical characteristic of the gas analyzer

Top view

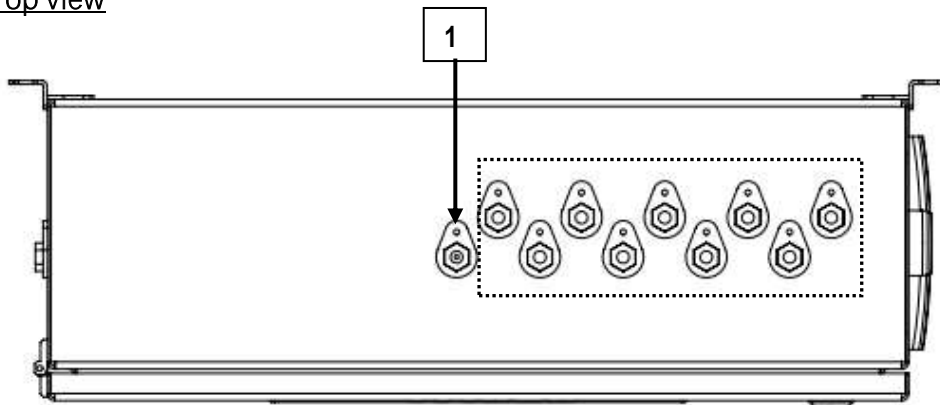

Front view

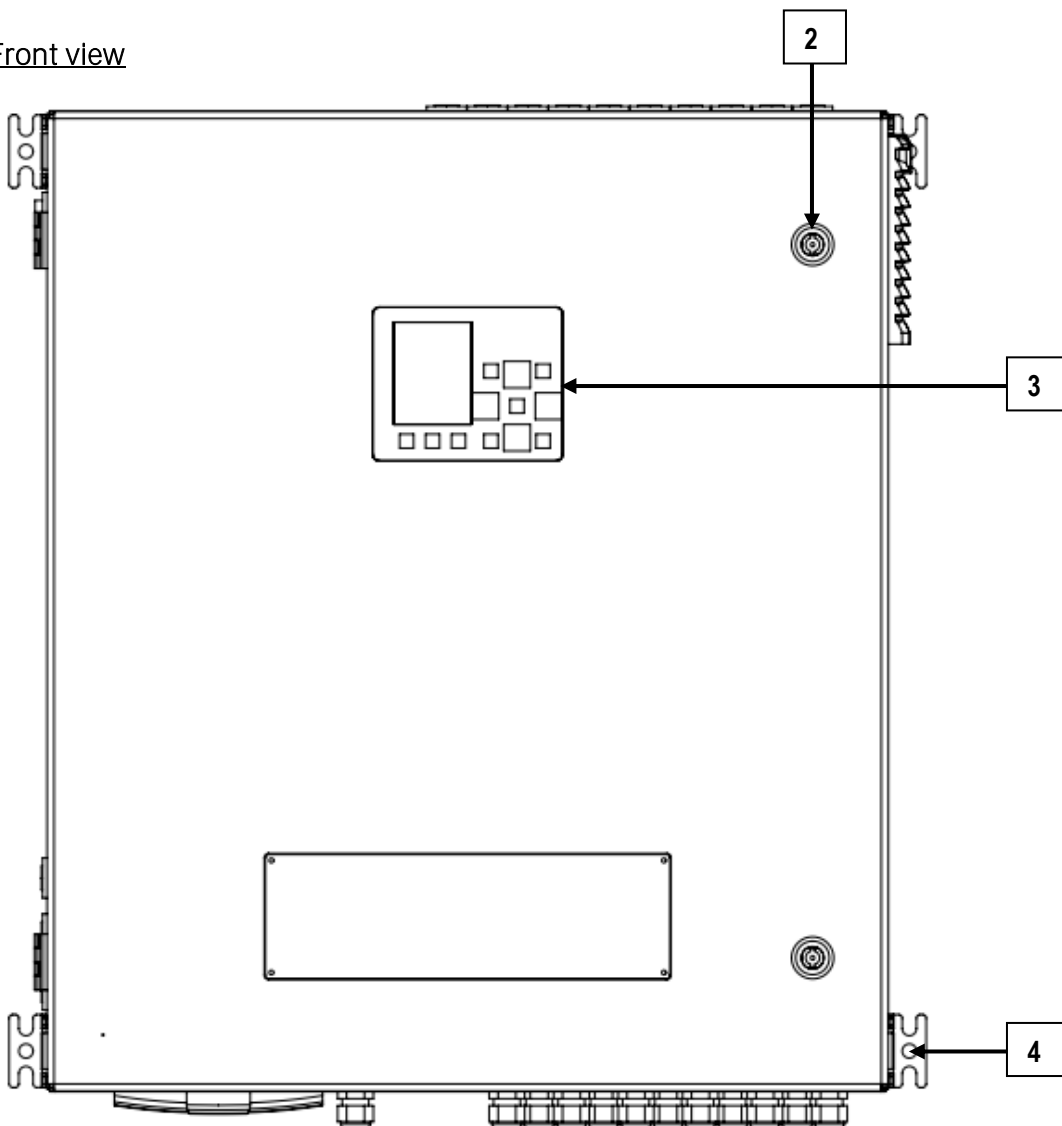

Reference:

1. Gas inlet (default x1/optional max.10)
2. Cabinet lock
3. Operation unit with display

4. Suspension for wall mounting

Right side view

Left side view

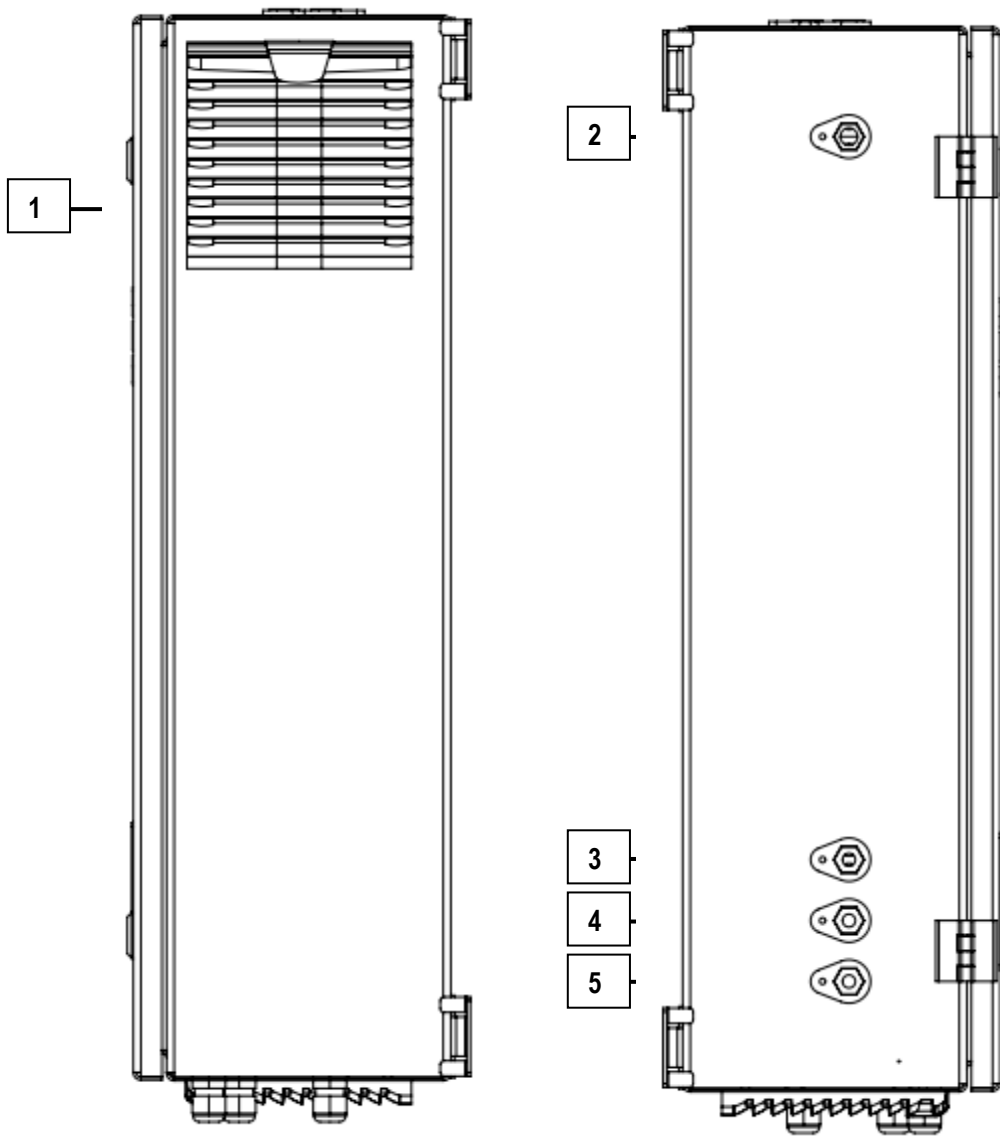

Bottom view

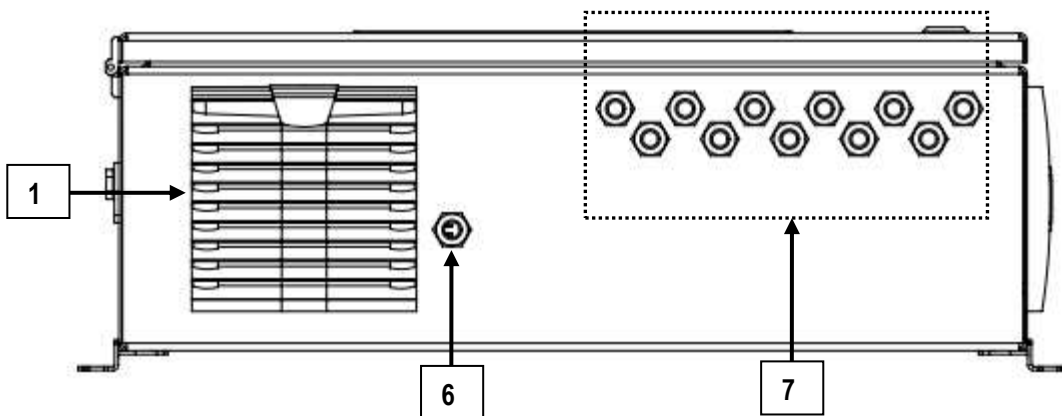





- 1. Fan filter
- 2. Sample gas outlet (Vent)
- 3. Calibration gas inlet
- 4. Zero gas inlet
- 5. Condensate outlet
- 6. Cable gland M16 for power supply
- 7. Cable gland M16 for IO

3. Scope of supply and delivery

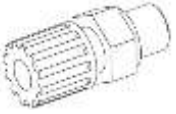
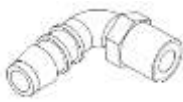
Your analyzer is delivered in a carton box and is protected with special edge protectors. Please do preserve the packing of your analyzer, for possible return shipment.

Inside the attachments box are different fittings:

	Quantity	Description	Position
	1 piece	1/8 G outlet thread for DN4/6mm	Condensate outlet (4)
	1 piece	1/4 G outlet thread 90°	Sample gas outlet (VENT) (5)
	2 pieces + 1 for every extra sample gas inlet	1/8 G outlet thread / DN 4/6mm	Sample gas inlet (1) Calibration gas inlet (2)
	1 piece	Filter 1/8 G outlet thread	Zero gas inlet (3)
	1 piece	Cabinet key	Cabinet locks
	2 pieces + 1 for every extra sample gas inlet	Copper seals for the restrictor orifice.	Sample gas inlet (1) Calibration gas inlet (2)

4. SD-card content

Following content are on the SD-Card:

- *Ethernet-Converter manual*
- *Profibus-Converter manual*
- *GSD-Files for profibus-converter*
- *SWG100-Bio manual (EN/DE)*
- *SWG100-Bio ModBus/Profibus specification (EN/DE)*

The SD-card can be found in the SD-card slot in the device (see sketch below).

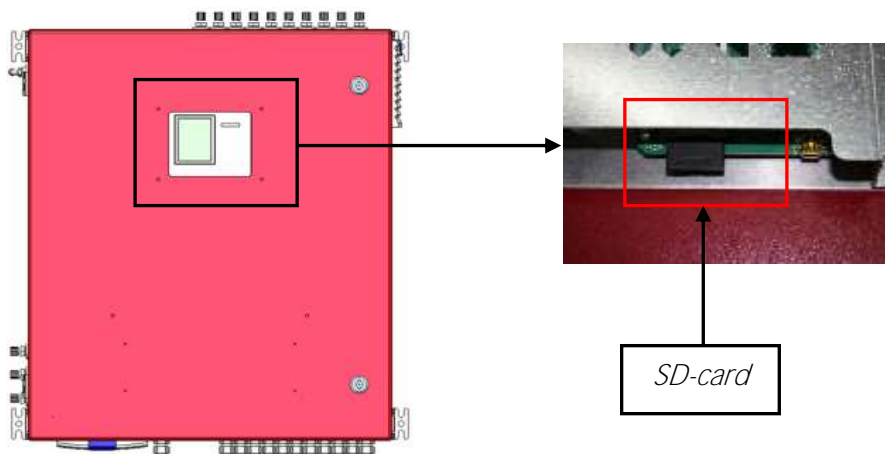

5. Installation manual

5.1. Overview

In this manual the installation of the different parts of the analyzer-system will be explained. An entire analyzer-system consists of these parts:

- The analyzer.
- A sample line.

The user has to install these parts correctly and put them together. The following flow chart shows the order of the installation.

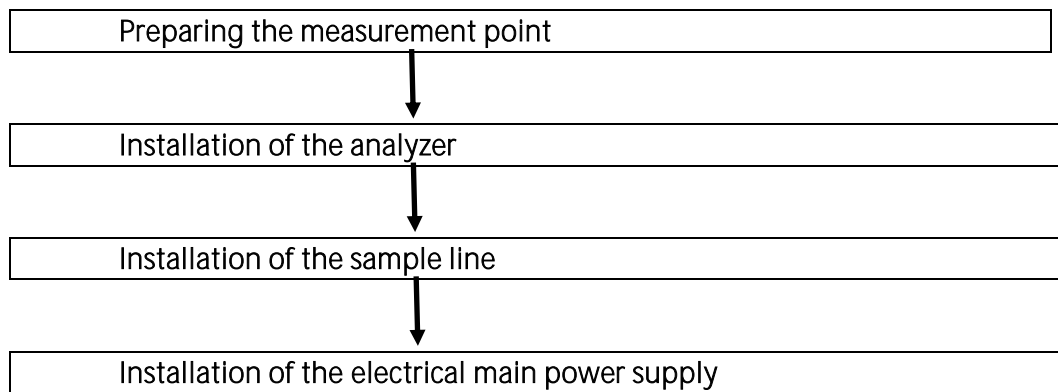

5.2. Installation of the analyzer

The analyzer is equipped with adapters for the wall mounting. The dimensions for the wall mounting are shown in picture below.

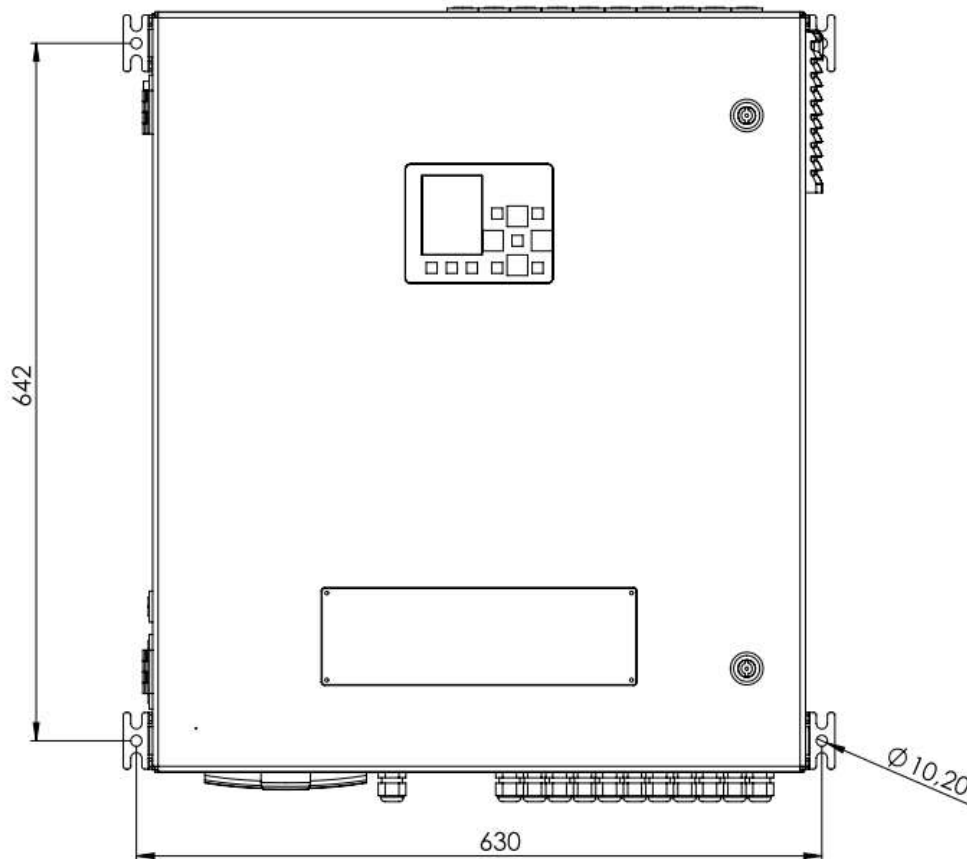

ATTENTION

Operation of the analyzer

Only operate the analyzer in an upright position.
Only power the device up after it is correctly mounted.

General installation rules

- Mount the device on a solid wall or steel rack.
- Be sure, that the air circulation is not obstructed.
- Let enough room for the tubing or piping.



For outdoor installation

Ensure that the analyzer is mounted on a rain and sun protected place (weather shade).

For indoor installation:

Ensure that the analyzer is installed on a dry and clean place. Be sure that the room is permanently vented with fresh air.

Connect the VENT gas-outlet of the device to ambient by using adequate tube with min $\varnothing 8\text{mm}$ ID.

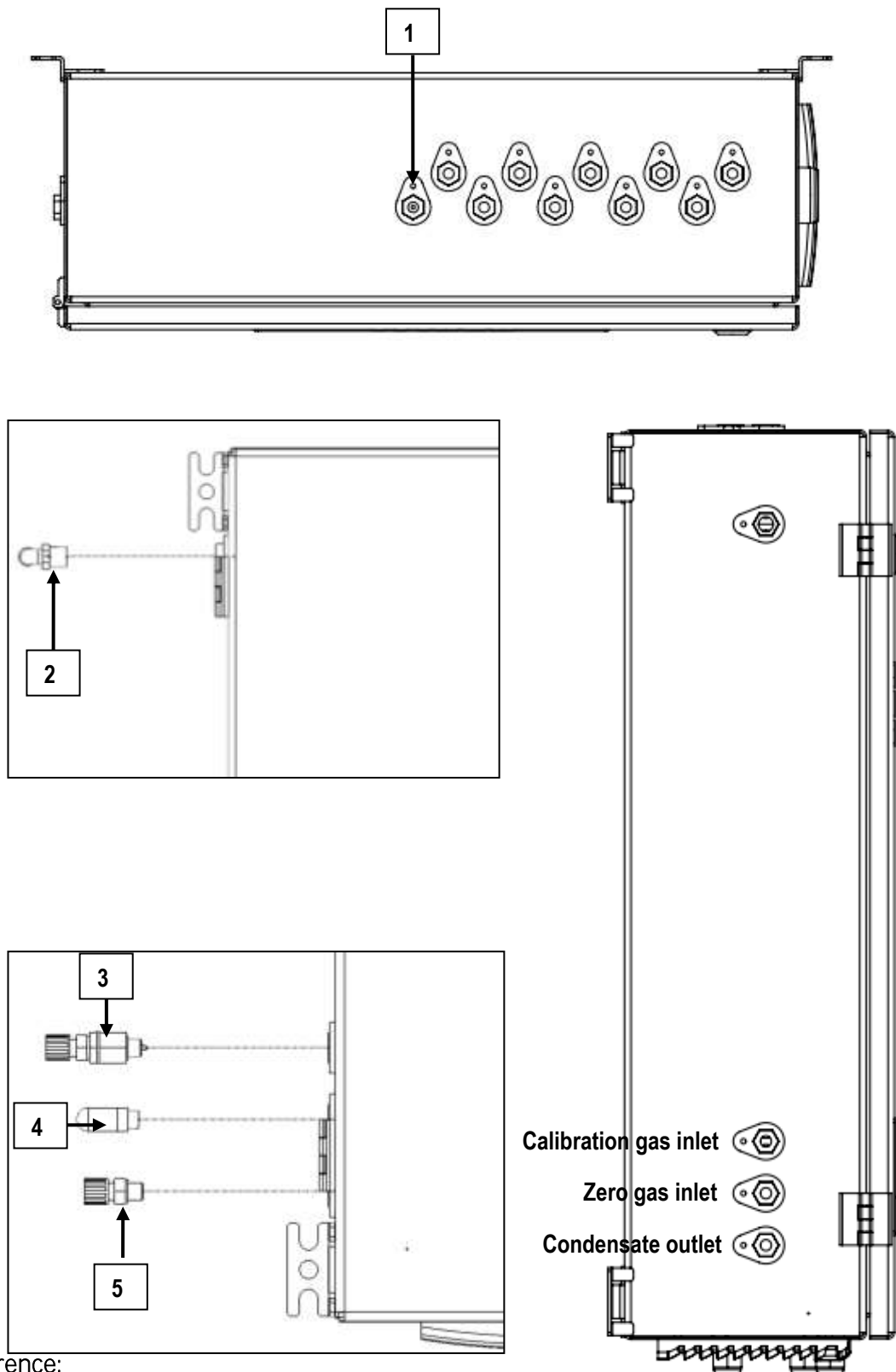

Reference:

1. Fitting for sample gas inlet G1/8
2. Fitting for sample gas outlet G1/4
3. Fitting with flow restrictor orifice gas inlet G1/8 for calibration gas inlet
4. Fitting filter for zero gas inlet G1/8.
5. Fitting for condensate outlet

5.3. Connection of main power supply



⚠ WARNING

Electric voltage

Power the system down and protect for reconnecting, before start maintenance work.

The analyzer needs a main power supply of 100-230 VAC/ 47-60 Hz. The power supply may be found on the DIN-rail.

Details:

- L and N phase on the circuit breaker (A in sketch below).
- PE on the connection terminal (B in sketch below.)

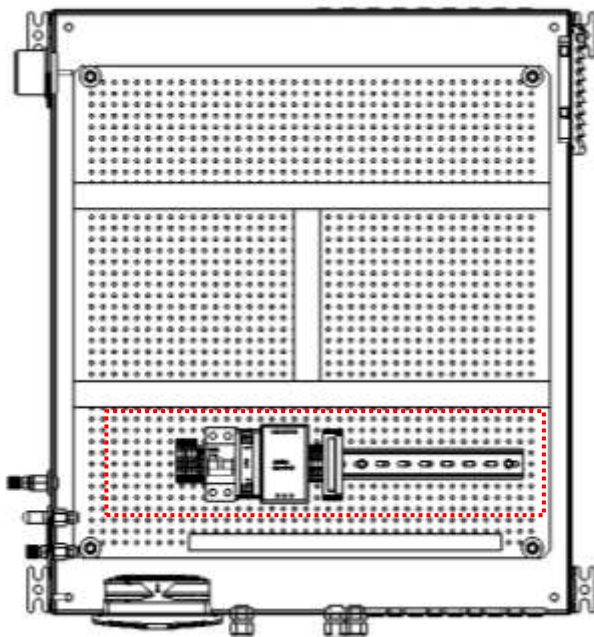

Position of the DIN-rail. On the DIN-rail can be found:

- Main power supply.
- I/O moduls (max. 10, 1 basic, all other optional)
- H2 TCD (optional).

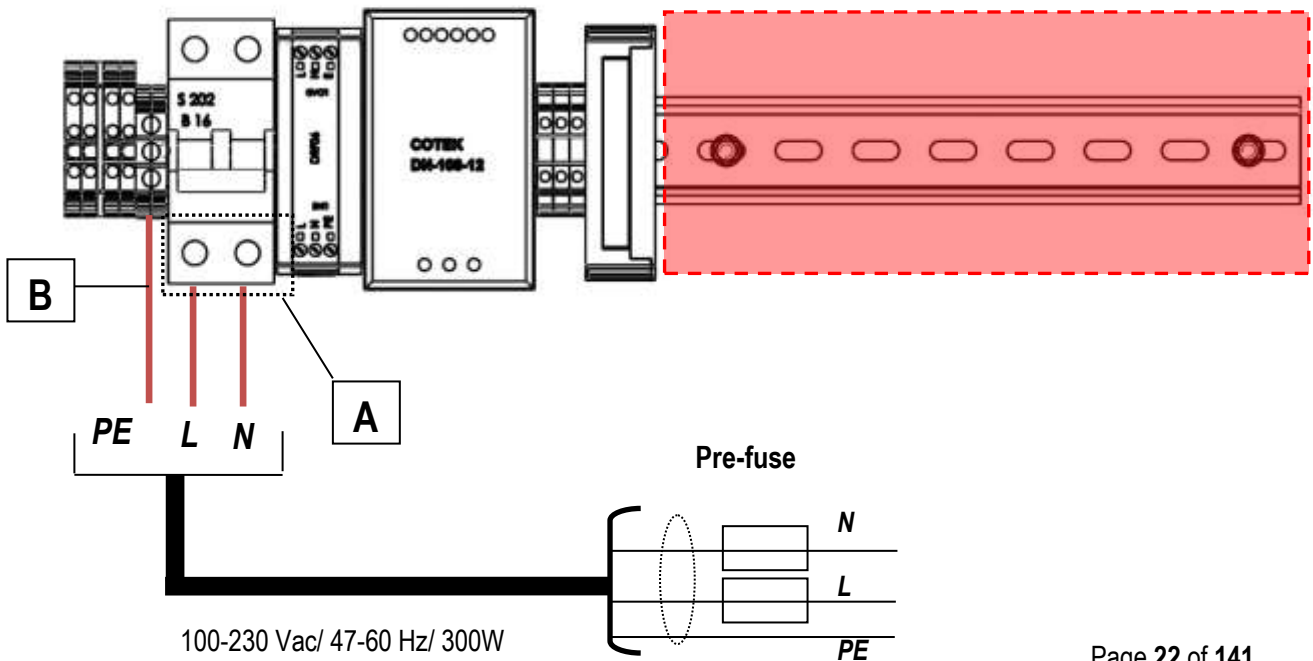

5.4. I/O modules: Installation and setting

The IO module is for monitors and allows for remote operating of the analyser. An IO module has the following features:

- Transmit 4-20 mA output.
- Trigger alarm outputs.
- Reads one PT1000.
- Reads one thermo couple.
- Reads current inputs signals (for sensors with max. 20 mA output signals).
- Reads voltage input signals (for sensors with max. 30 V output signals).
- External control of the analyser.

Connection of the I/O module

The option IO module can be found at the hat-rail. The position is shown at the sketch below.

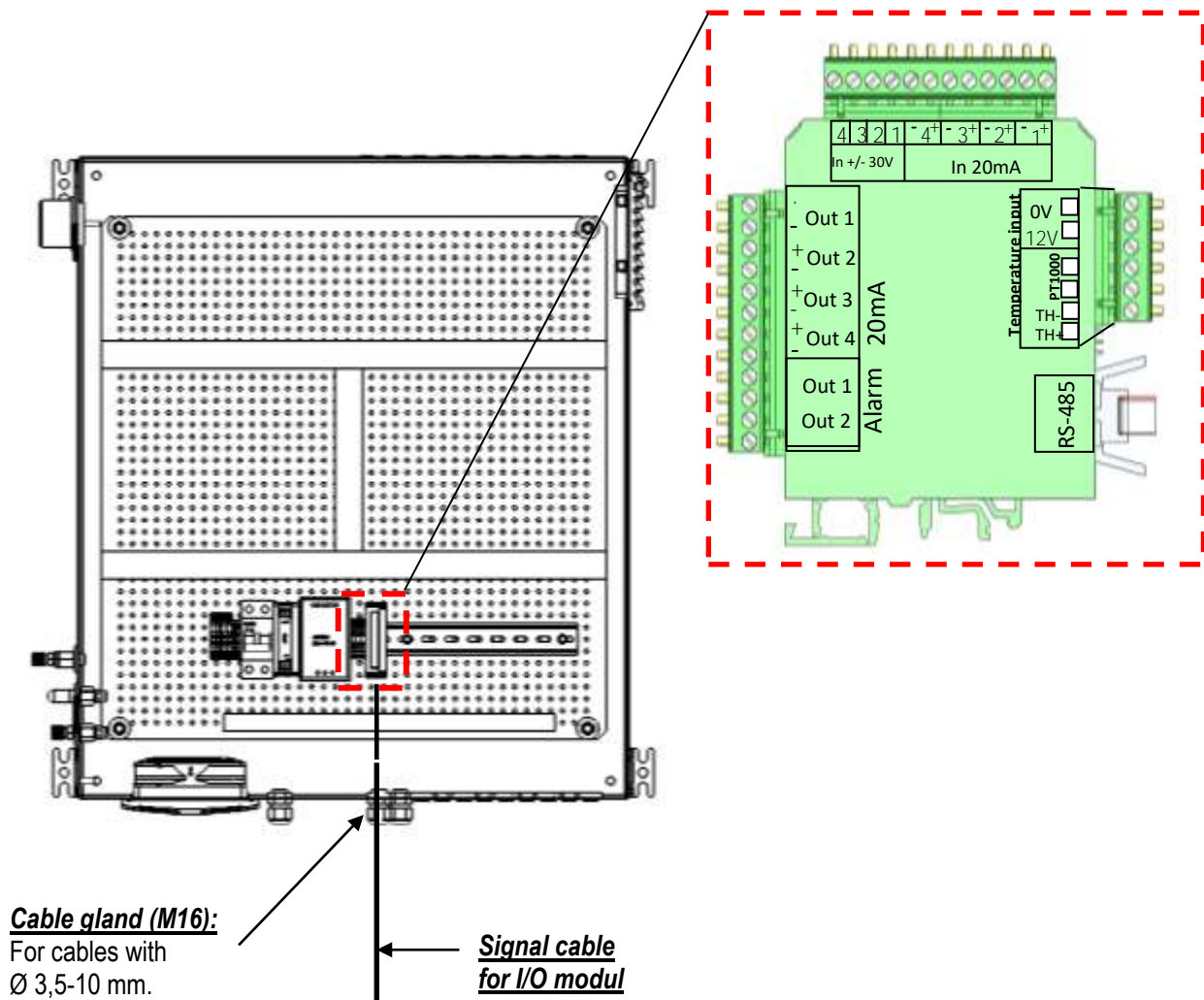

NOTE: analog output current 4-20mA load resistor is max. 5000ohm
analog output does not require power supply alarm relays Out1 and Out2 contacts are "fail safe" type:

- open contact in case of alarm or power failure
- closed contact for normal operation

Plug connector definition:
WARNING
Electric voltage

Power the system down and protect from reconnecting, before starting maintenance work.

Slit screws

Stripping length: 7 mm
Tightening torque min.-max.: 0,5-0,6 Nm

Conductor cross sections, which can be used:

Type of electric line	Conductor cross section min.-max.
<i>Solid</i>	0,2-2,5 mm ² (30-12 AWG)
<i>Stranded</i>	0,2-2,5 mm ² (30-12 AWG)
<i>Solid with ferrule (with/ or without plastic)</i>	0,25-2,5 mm ²

Information for cables, which go through the cable gland M16:

It is recommended to use only electric lines with ferrules.

6. Operation of the analyzer (HMI)

6.1. Display and keypad

All information required to operate the analyzer is displayed as shown below.

1	Menu indication bar - "air purging" or - "gas sampling" or - "measurement"
2	Function key bar - F1 "sample point" - F2 "storage" - F3 "extras"
3	Display area of - Menu - Measurement value...
4	SD-Card symbol - Indication green → read- and write access - Indication yellow → only read access (SD-Card write protected)
5	Sample point number

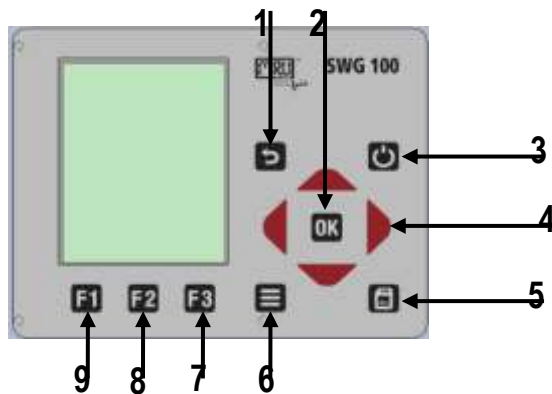

#	Symbol	Description
1		ESC: abort or return to the menu above
2		Prepare Power-Down: Press this key before you disconnect mains. The analyzer will store changed user settings and other operational data and will purge the sensors
3		Arrow keys: context dependent functions, e.g. scroll in between lines, change values, change view.
4		OK: confirmation key, select a marked menu point.
5		Screen shot: press this key in order to store a screen shot of the current display contents onto the SD card.
6		Menu key: Will show all available functions in the window that is currently in use – also those which have an individual key on the key pad like the printer and the three function keys.
7-9		Function Keys: Activates the functions seen on the display (2 function key bar)

7. Analyzer commissioning manual

After the first start of the analyzer it is necessary to make some settings at the analyzer. These settings are:

- Check the country and language.
- Check the date and time of the instrument.
- Configuration of the alarm relays.
- Configuration of the Modbus.
- Configuration of the external control via relay contacts (IO module).
- Configuration of the analog outputs at the I/O module.
- Configuration of the AUX inputs at the I/O module.
- Configuration of the alarm outputs at the I/O module.
- Configuration of the auto calibration.

7.1. Check country and language

Important note:

In case the analyzer shows a language, you don't understand, you may swap the language to English by pressing the menu key and selecting the function 'Set English language'.

Use the menu **EXTRAS – GENERAL SETTINGS**.

The analyser will automatically set some country-typical parameters like the language, the date format, the temperature unit, the daylight-savings time function and the CSV-export settings.

7.2. Check date and time of the instrument

The analyzer stores automatically measurement values including timestamps. Therefore the instruments' system clock should be set correctly.

Use the menu **EXTRAS – GENERAL SETTINGS – DATE & TIME**.

In case the date & time is not correct, press the key **F2**=modify, change date & time and then press the key **F2**=store.

Note:

According to the selected country (see previous chapter) the analyzer automatically switches the daylight saving time in spring and autumn. This function is active for most European countries. Whenever the daylight-saving time is currently active, then you'll see a '*' in the time line of the menu, thus 'Time *' instead of 'Time'.

7.3. Configuration of the alarm relays

On the main PCB there is one “system alarm” relay with “fail safe” NC contact. The following errors will turn the relay from NC to NO.

1. Main board is offline (internal RS485 bus communication failure)
2. Main board is in the “bootloader” phase
3. Gas leakage inside analyzer cabinet (CH₄ > 20% to 50% LEL)
4. Condensate alarm (contacts resistance < 35k Ω)
5. Low fan rotation (speed rotation < 900U/min)
6. Sample flow alarm (sample flow < 20 l/h)
7. Gas cooler high alarm (temperature > +10°C)
8. Gas cooler low alarm (temperature < +2°C)
9. Cabinet high temperature (> +55°C)
10. Cabinet low temperature (< +5°C)

Errors **1 to 5** alarm will force a measurement stop (all analog outputs are on hold or at 2mA, depending on configuration).

Errors **5 to 10** will be displayed as warning message only; analog outputs of active sampling point are live, all others are on hold.



ATTENTION

Analyzer system alarm relay is a potential-free contact, which max. 24VDC/VAC and a current of 1A (max.)

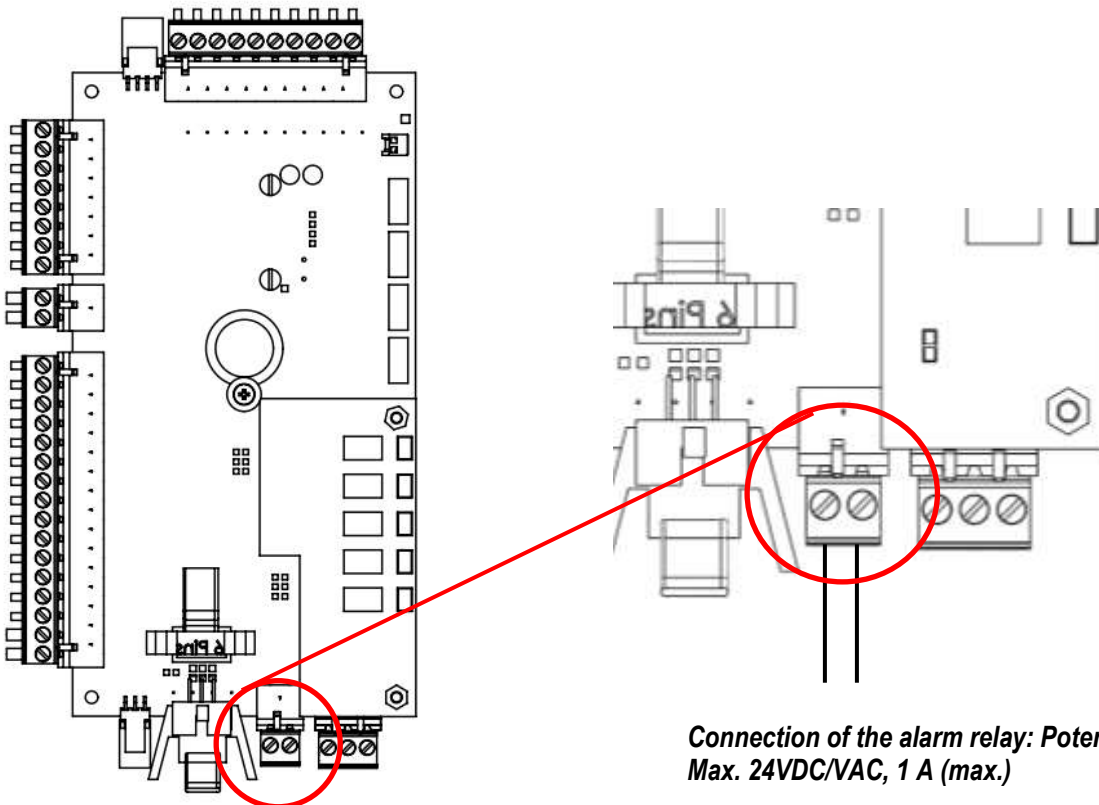

**Connection of the alarm relay: Potential-free
Max. 24VDC/VAC, 1 A (max.)**

Plug connector definition for the system alarm relay

Slit screws

Stripping length: 7 mm

Tightening torque min.-max.: 0,5-0,6 Nm

Conductor cross sections, which can be used:

Type of electric line	Conductor cross section min.-max.
<i>Solid</i>	0,2-2,5 mm ² (30-12 AWG)
<i>Stranded</i>	0,2-2,5 mm ² (30-12 AWG)
<i>Solid with ferrule (with/ or without plastic)</i>	0,25-2,5 mm ²

Information for cables, which go through the cable gland M16:

It is recommended to use only electric lines with ferrules.

Following analyzer errors will produce a system alarm (open contact of System Alarm relay)

7.4. Configuration of the Modbus

The Modbus connector can be found on the PCB-mainboard (see sketch below).

NOTE: for specification of Modbus (RTU) data transfer over RS485, please observe appendix.

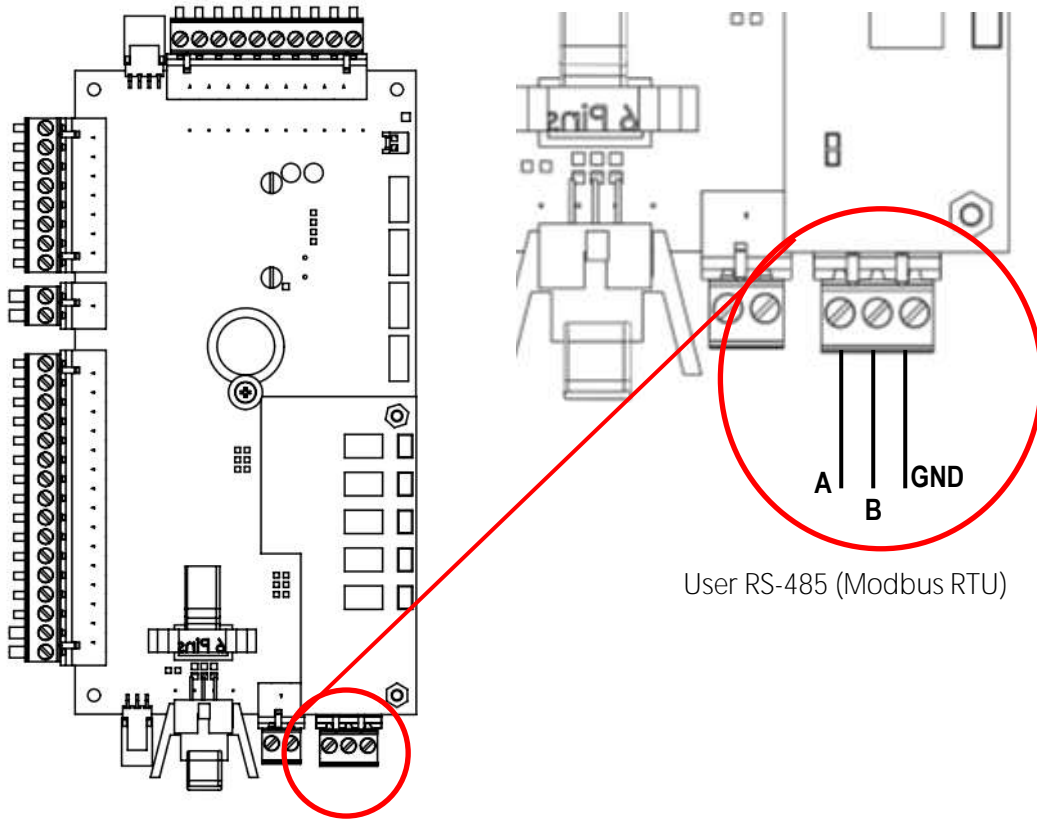

Plug connector definition for the system alarm relay

Slit screws

Stripping length: 7 mm

Tightening torque min.-max.: 0,5-0,6 Nm

Conductor cross sections, which can be used:

Type of electric line	Conductor cross section min.-max.
<i>Solid</i>	0,2-2,5 mm ² (30-12 AWG)
<i>Stranded</i>	0,2-2,5 mm ² (30-12 AWG)
<i>Solid with ferrule (with/ or without plastic)</i>	0,25-2,5 mm ²

Information for cables, which go through the cable gland M16:

It is recommended to use only electric lines with ferrules.

Configuration at the analyzer

1. Open the path EXTRAS/GENERAL SETTINGS.
2. Press **F3** "Modbus".
3. The Modbus store settings will be open. The user can commission the **slave's** settings.

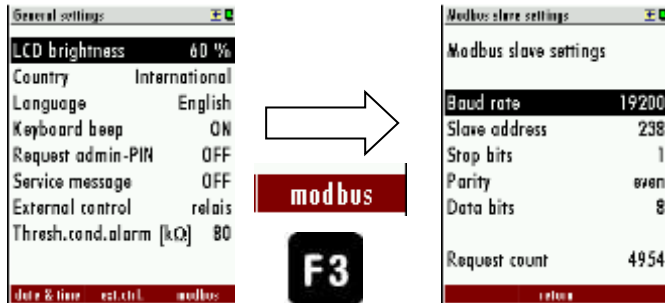

The following settings can be set:

- Baud rate.
- Slave address.
- Stop bits.
- Parity.
- Data bits.

8 Binding to a process control system: I/O modules

The IO module is a necessary module for the signal forwarding, into a control room. This module is an interface for signal transmitting, remote operating and to read signals, from extern transducers.

An IO module has the following features:

- Transmit 4-20 mA output.
- Trigger alarm outputs.
- Reads one PT1000.
- Reads one thermocouple.
- Reads current inputs signals (for sensors with max. 20 mA output signals).
- Reads voltage input signals (for sensors with max. 30 V output signals).
- External control of the analyzer.

8.1. Position of the IO module inside the analyzer

At the basic SWG100, one IO module is integrated. Optionally, an analyzer can be equipped with further IO modules (max. 10).

The IO module(s) are installed on the hat-rail (position: see sketch below).

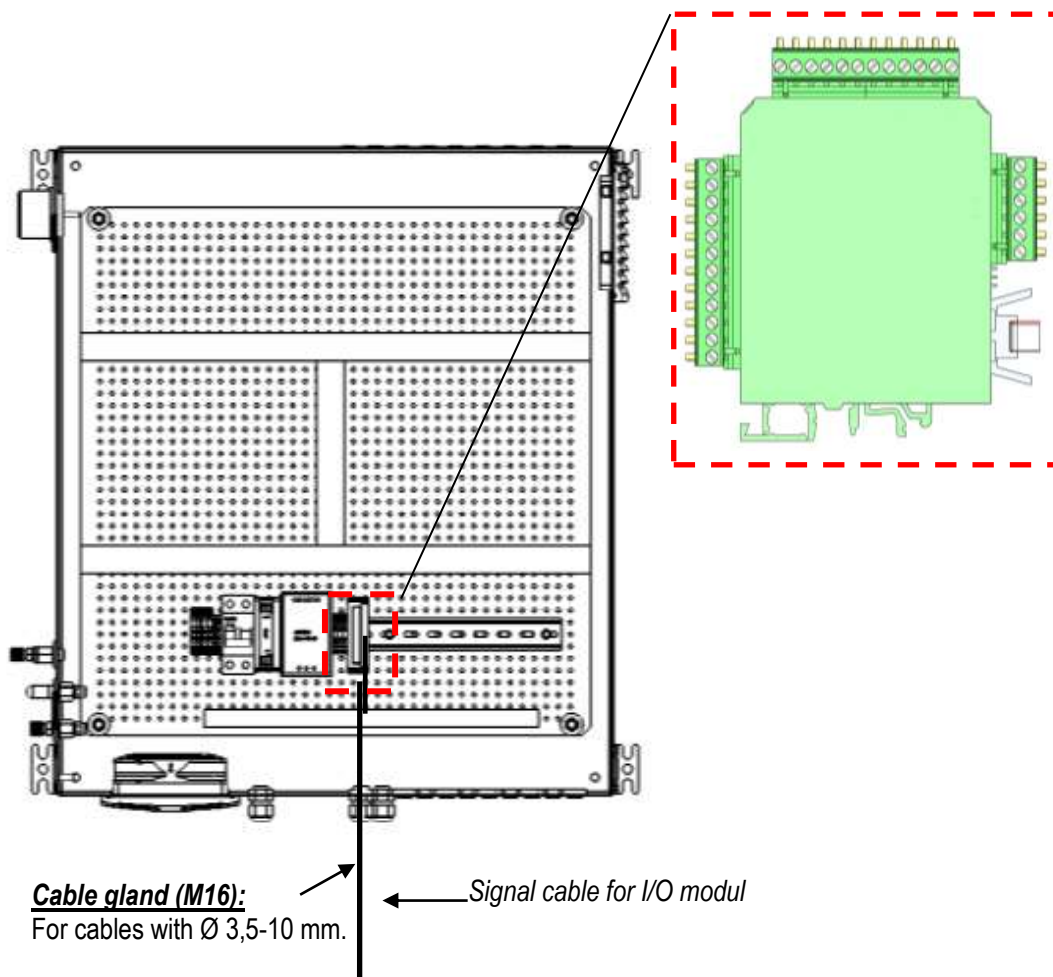

8.2. Pin assignment

The follow pin assignment-plan shows where the different pins for the interfaces can be found and which pins has a double occupancy.

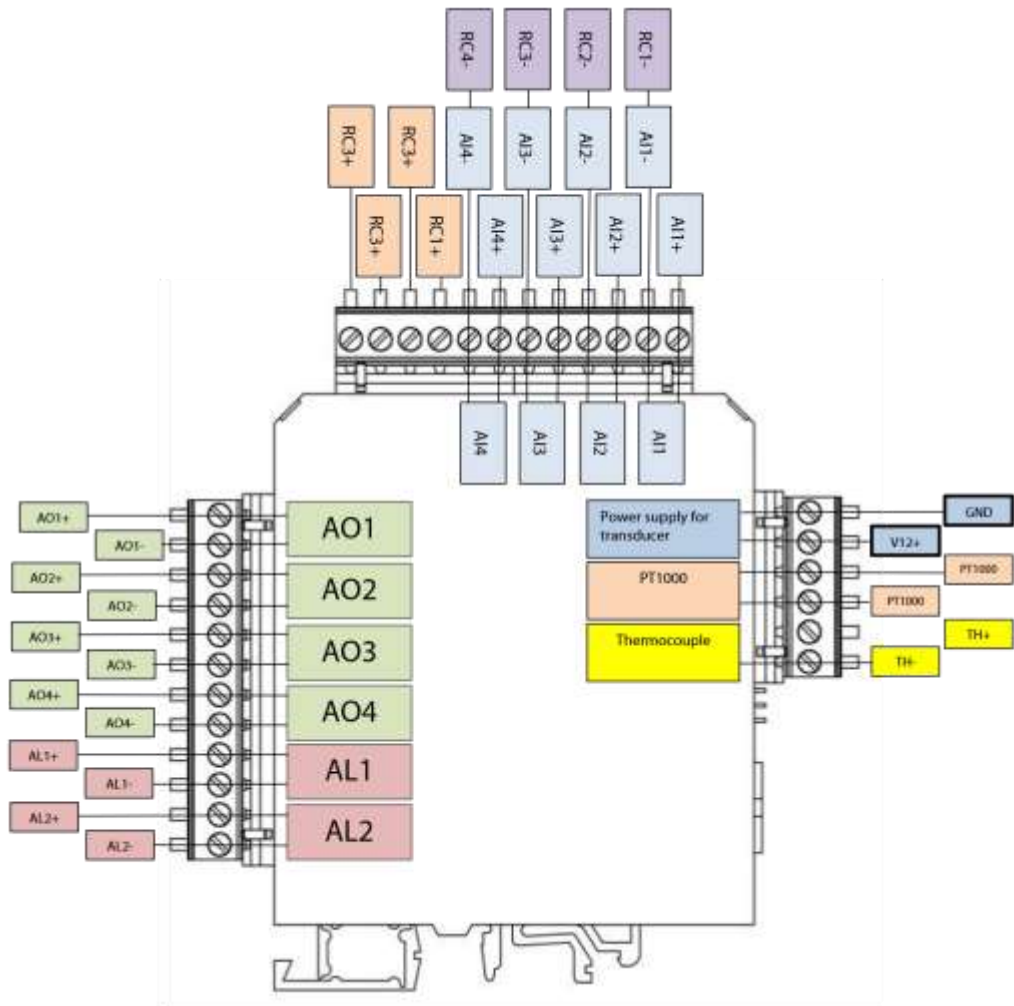

Description	Abbreviation	Pin	max. external Voltage	max. Load (for outputs)	Internal load (in inputs)	Double occupancy
Analog-Outputs 4-20 mA	AO1	AO1+	--	max. 500R	--	No
		AO1-	--	max. 500R	--	No
	AO2	AO2+	--	max. 500R	--	No
		AO2-	--	max. 500R	--	No
	AO3	AO3+	--	max. 500R	--	No
		AO3-	--	max. 500R	--	No
	AO4	AO4+	--	max. 500R	--	No
		AO4-	--	max. 500R	--	No
Alarmoutput _s	AL1	AL1+	24 VDC	--	--	No
		AL1-	24 VDC	--	--	No
	AL2	AL2+	24 VDC	--	--	No
		AL2-	24 VDC	--	--	No
Analog-Input 4-20 mA	PWROUT	V12+	--	--	--	No
		GND	--	--	--	No
	AI1	AI1+	--	--	50R	No
		AI1-	--	--	50R	RC1-
	AI2	AI2+	--	--	50R	No
		AI2-	--	--	50R	RC2-
	AI3	AI3+	--	--	50R	No
		AI3-	--	--	50R	RC3-
AI4	AI4+	--	--	50R	No	
	AI4-	--	--	50R	RC4-	
Remote control	RC1	RC1+	--	--	--	No
		RC1-	--	--	--	AL1-
	RC2	RC2+	--	--	--	No
		RC2-	--	--	--	AL2-
	RC3	RC3+	--	--	--	No
		RC3-	--	--	--	AL3-
	RC4	RC4+	--	--	--	No
		RC4-	--	--	--	AL4-
Analog-Input 0-10V	AVL1	AVL1+	--	--	--	JMP1_out
		AVL1-	--	--	--	JMP2_out
	AVL2	AVL2+	--	--	--	JMP3_out
		AVL2-	--	--	--	JMP4_out

8.3. Analog outputs 4-20 mA

Hardware-side

Every IO module has four 4...20 mA outputs. The outputs are marked at with the green labels.

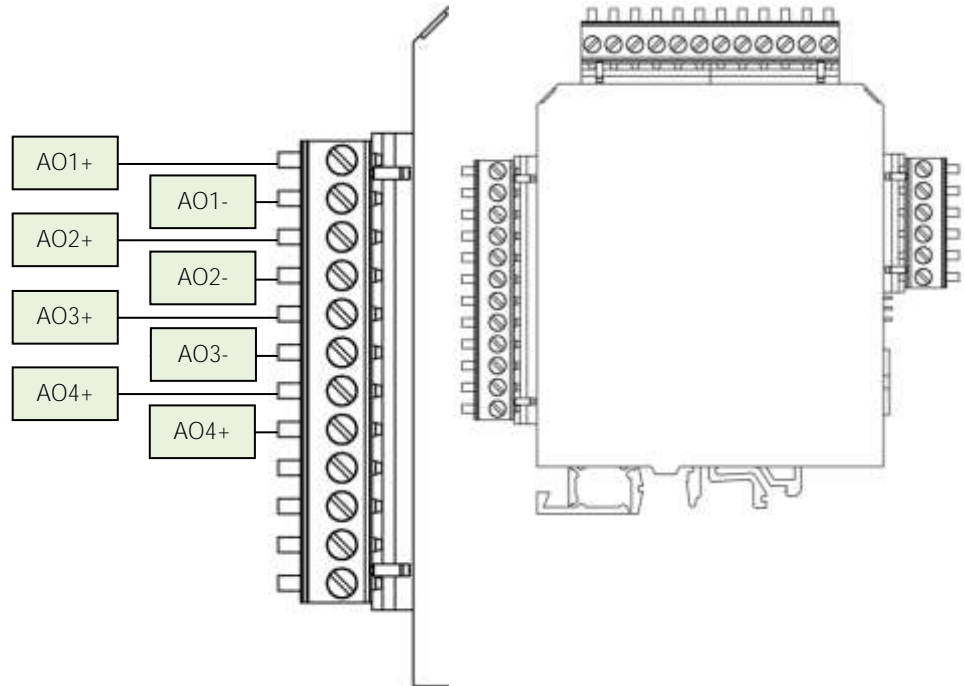

Information for connection:

Conductor cross section:
Max. Load (for output):

0,2...2,5 mm²
500 Ohm

Software-settings

- Open the menu: **Extras/Analog output configuration** (1).
- The overview screen appears. This menu shows, how much analog-outputs are available and how the analog outputs are occupied.
At the overview screen all analog-outputs are listed. The amount of the analog-outputs is dependent from the amount of the installed IO-modules. Every IO module has 4 analog-outputs. If two IO modules are installed, the entire amount of analog-outputs is eight. At the list, the user finds the information which analog signal is carry out at which analog-output channel. The follow list-notation can be found (example):

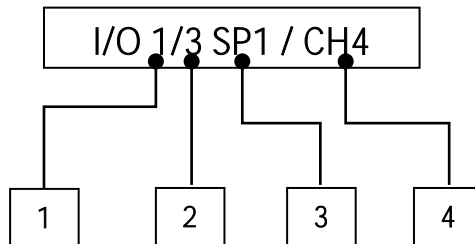

Reference:

1. The number of the IO module. 1 means, first IO module.
2. The value of the analog-output. 3 means, the third analog-output.
3. The sample point, from where the signal comes. SP1 means, the first sample point.
4. The signal-name. CH4 means, that this analog-output transfers CH4 signal.

This example means: At the third channel of the first IO module, the CH4 signal from the first sample point will be transferred.

At the sketch below, the menu-screen and the analog-outputs at the first, of two IO modules are shown.

1

Analog output configuration

I/O 1/1	SP1 / CH4	AO1
I/O 1/2	SP1 / O2	AO2
I/O 1/3	SP1 / H2S	AO3
I/O 1/4	SP1 / CO2	AO4
I/O 2/1	SP2 / CH4	
I/O 2/2	SP2 / O2	
I/O 2/3	SP2 / H2S	
I/O 2/4	SP2 / CO2	

details
auto-config
test

2

3

4

- List of the installed analog output ports (1): At this list the operator can select, which analog-output should be configured. To select an analog-output, move the up/down arrow keys.
- Details (2): Here the operator can open the configuration screen for the selected output port. To open the details-menu, push **F1** or **OK**.
- Auto configuration (3): If the operator pushes this key (**F2**) the output pins would be configured by default values.
- Test (4): The test-menu is for testing the analog outputs. To open the test-menu, push **F3** or **OK**.

The navigation inside the menu taken place with the *up/down* arrow keys. With the **OK** key, the analog-output can be edited:

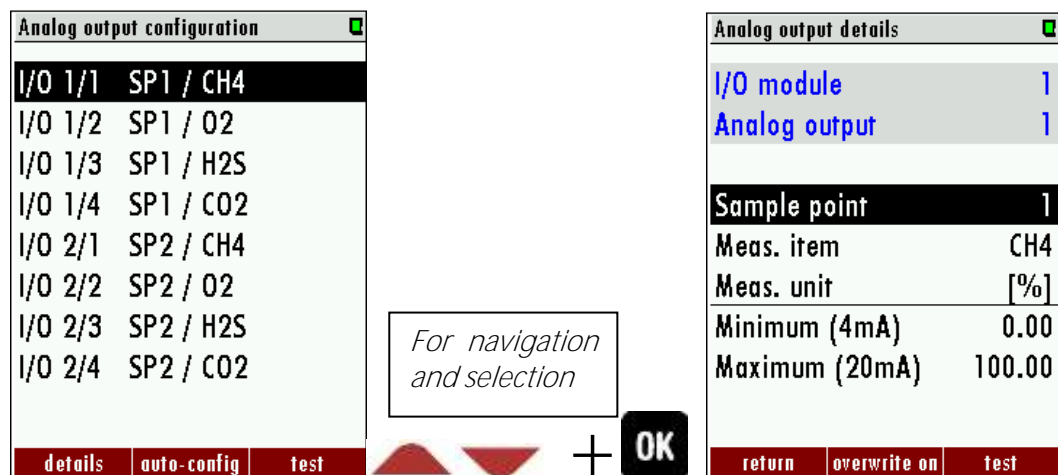

The settings for an analog-output can be change in the “Analog output details” menu. See the screenshot below.

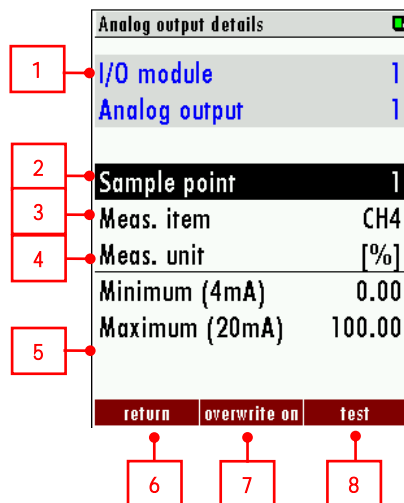

- Section (1): Shows the operator, which analog-output will be changed.
- Sample point (2): The operator can select the sample point. This means, that the analog-output signal from the choose sample point will be transmitted to the process control system.
- Meas. Item (3): At this point the operator selects the measurement item, which should be transmitted. At the chart below, the typical measurements items are listed. Basically, all measurement-channels, which can be measured, can be selected at this point.
- Meas. Unit (4): This point shows, which unit the transmit signal have. This point cannot be changed.
- Minimum (4mA) (5): Here the operator entering the equivalent measurement value, for a current of 4 mA.
- Maximum (20mA) (5): Here the operator entering the equivalent measurement

value, for a current of 20 mA. The IO module will create the linear relation.

- *Return (6)*: Leave the menu. Alternate push F1.
- *Overwrite on (7)*: A function to simulate values. If the overwrite function is activated, the set value will be transferred to the DCS.
- *Test (8)*: Further to a test-menu. Alternate push F3.

1. Example: 4-20 mA signal outputs to control room

Starting position:

A plan wants to read the measurement values from the CO₂ channel to their DCS¹. The SWG100 has only one IO module and three sample points. All outputs are free. The CO₂ values from the second sample point should be logged in the control room.

Follow steps must be done to do this:

1. Wiring the analog-output 1 with the DCS: Wiring the analog-output (AO1+/AO1-) with the DCS. For this, use a wiring with a conductor cross section between 0,2...2,5 mm².

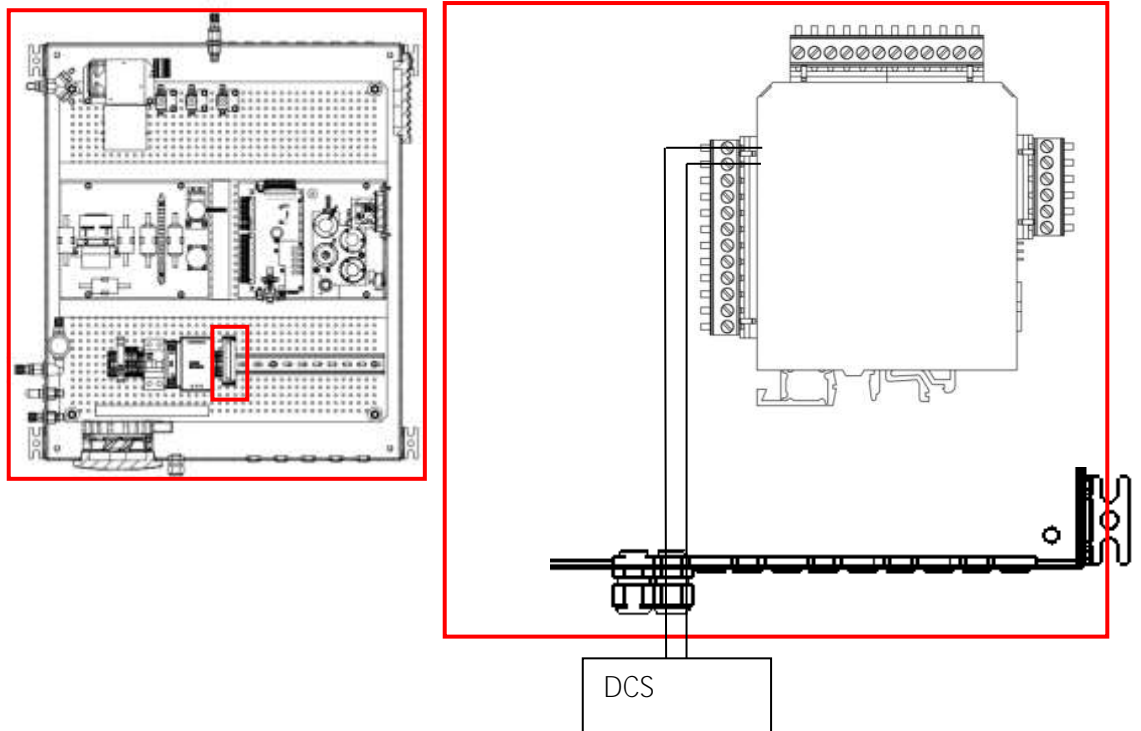

2. In the next step output 1 must be configured at the SWG100. To do this, open the menu: **EXTRAS/ CONFIGURATE ANALOG OUTPUTS**. The following menu overview will be appeared (see screenshot below). To configure the IO1, select the first record (channel I/O 1/1 SP1 / CH4) in the list and open it.

¹ DCS=Distributed Control System

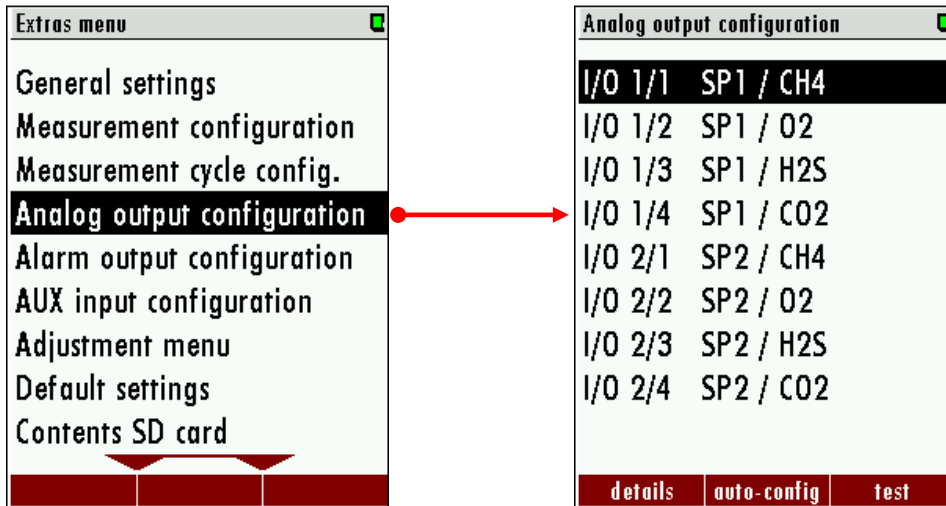

3. The follow screen appears. To configurate the channel 1, the red marked positions must be changed:

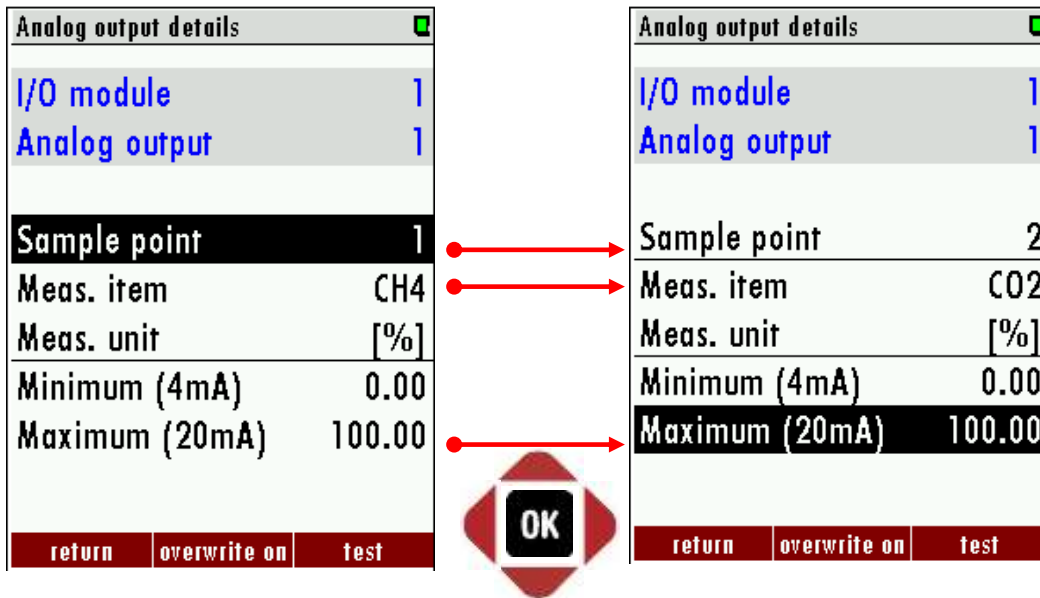

- In the last step the menu must be closed. Confirm the store message. The 4-20 mA output is now configuring.

8.4. Alarm outputs

Hardware side:

Every IO module has two alarm outputs. The position of the alarm-outputs are marked with the red labels.

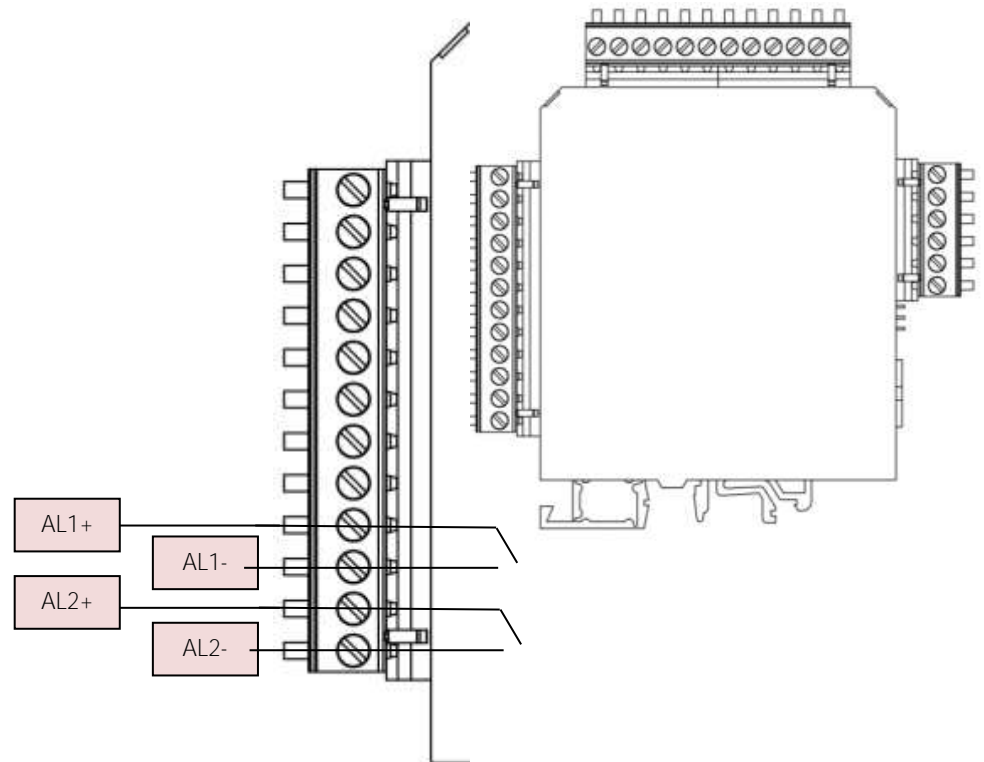

Information for connection:

Conductor cross section:

0,2...2,5 mm²

Relays-type:

Normally open

Voltage supply:

max. 24 VDC

Software-side

- Open the menu: **Extras/Analog output configuration** (1).
- The overview screen appears. This menu shows, how much alarm-outputs are available and how the alarm outputs are occupied.
At the overview screen all alarm-outputs are listed. The amount of the alarm-outputs is dependent from the amount of the installed IO-modules. Every IO module has 2 alarm-outputs. If two IO modules are installed, the entire amount of alarm-outputs is four. At the list, the user finds the information which alarm signal is carry out at which alarm-output channel. The follow list-notation can be found (example):

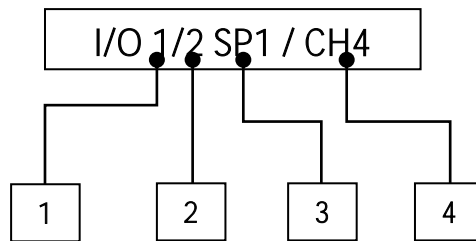

Reference:

1. The number of the IO module. 1 means, first IO module.
2. The value of the alarm-output. 3 means, the second alarm-output.
3. The sample point, from where the signal come. SP1 means, the first sample point.
4. The signal-name. CH4 means, that this alarm-output monitors the CH4 channel.

This example means: At the second channel of the first IO module, the CH4 signal from the first sample point will be transferred.

At the sketch below, the menu-screen and the analog-outputs at the first, of two IO modules are shown.

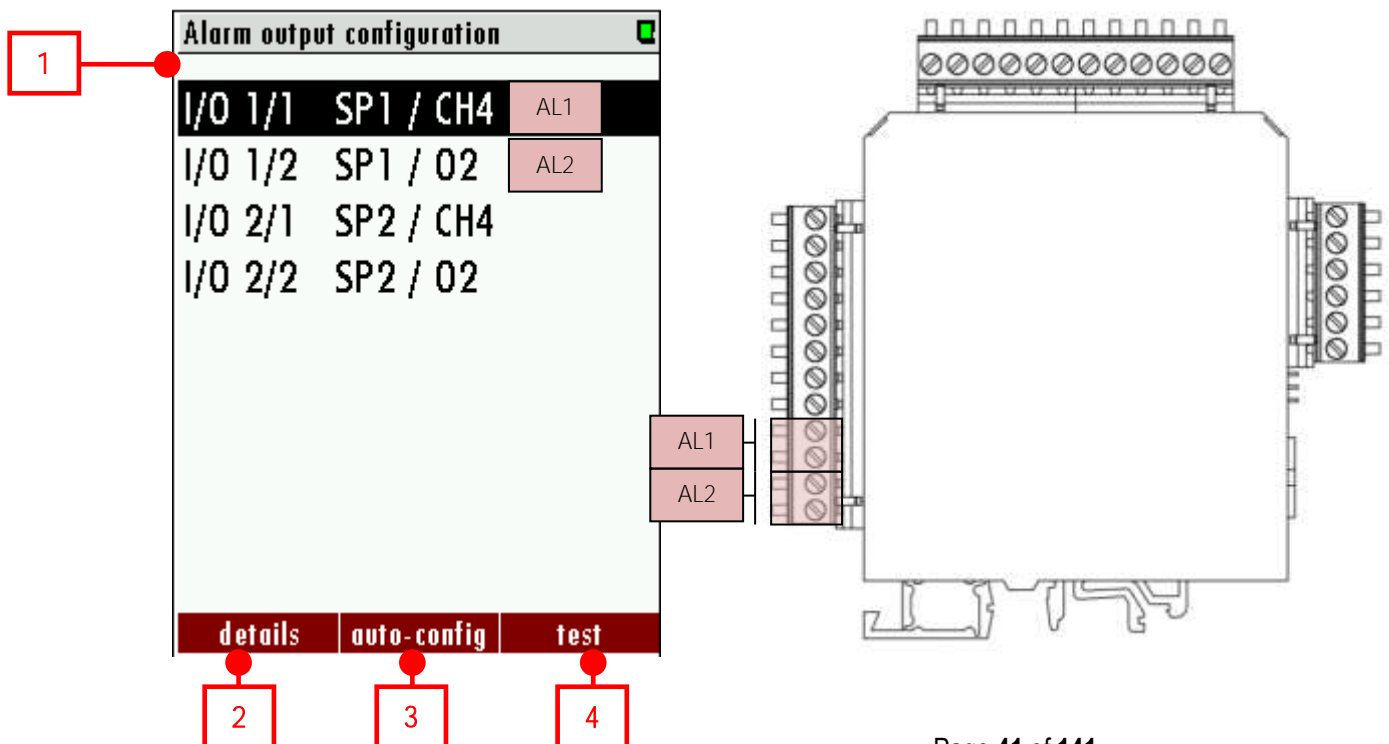

- List of the installed alarmoutput ports (1): At this list the operator can select, which alarm output should be configured.
- Details (2): Here the operator can open the configuration screen for the selected alarm output. To open the details-menu, push **F1** or **OK**.
- Auto configuration (3): If the operator pushes this key (**F2**) the output pins would be configured by default values.
- Test (4): The test-menu is for testing the alarm outputs. To open the test-menu, push **F3** or **OK**.

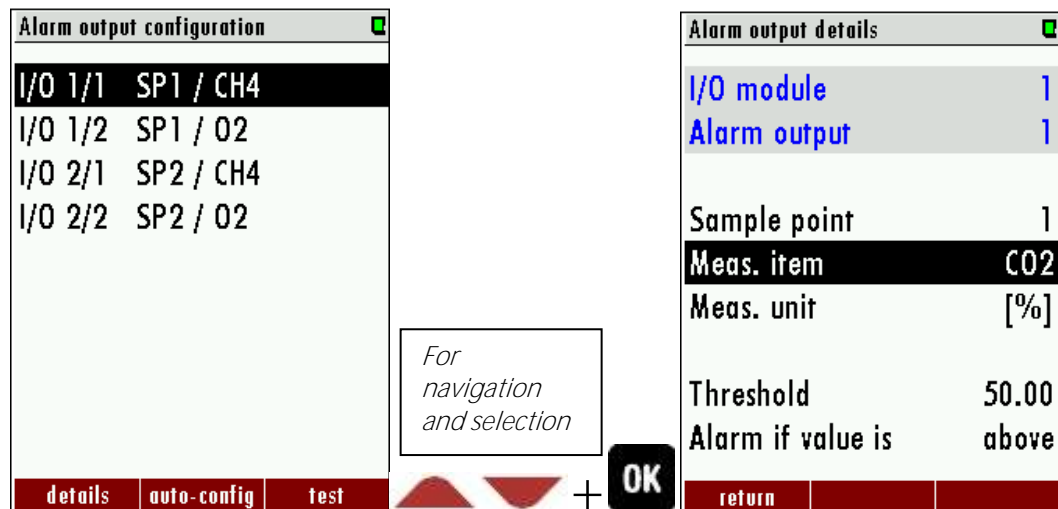

The settings for an alarm-output can be changed in the "Alarm output details" menu. See the screenshot below.

-
- The screenshot shows the "Alarm output details" menu with the following settings and callouts:
- | | | |
|---|-------------------|-------|
| 1 | I/O module | 1 |
| | Alarm output | 1 |
| 2 | Sample point | 1 |
| 3 | Meas. item | CO2 |
| 4 | Meas. unit | [%] |
| 5 | Threshold | 50.00 |
| 6 | Alarm if value is | above |
| 7 | return | |
- Section (1): Shows the operator, which alarm-output will be change.
 - Sample point (2): The operator can select the sample point. This means, that the alarm-output signal from the choose sample point will be transmitted to the process control system.
 - Meas. Item (3): At this point the operator selects the measurement item, which should be monitored. At the chart below, the typical measurements items are counted. Basically, all measurement-channels, which can be measured, can be selected at this point.
 - Meas. Unit (4): This point shows, which unit the transmit signal have. This point cannot be changed.
 - Threshold (5): Here the threshold will be determined.
 - Alarm of value is (6): The operator can determine, if the alarm will be triggered **above** the determine threshold, or **below** the threshold.
 - Return (7): Leave the menu. Alternate push F1.

2. *Example: Alarm output to control room*

Starting position:

A warning light should be installed inside the plant. It should be powered up, if the H₂S concentration is **over** 550 ppm in the **sample point 2**. The SWG100 has **one IO module**. Both alarm outputs are not connected.

Follow steps must be done:

- Both alarm outputs are equipped with a potential-free relay. The maximal voltage of the power supply is 24 VDC. So, the operator must provide a 24 VDC power supply and a warning light, which works with 24 VDC.

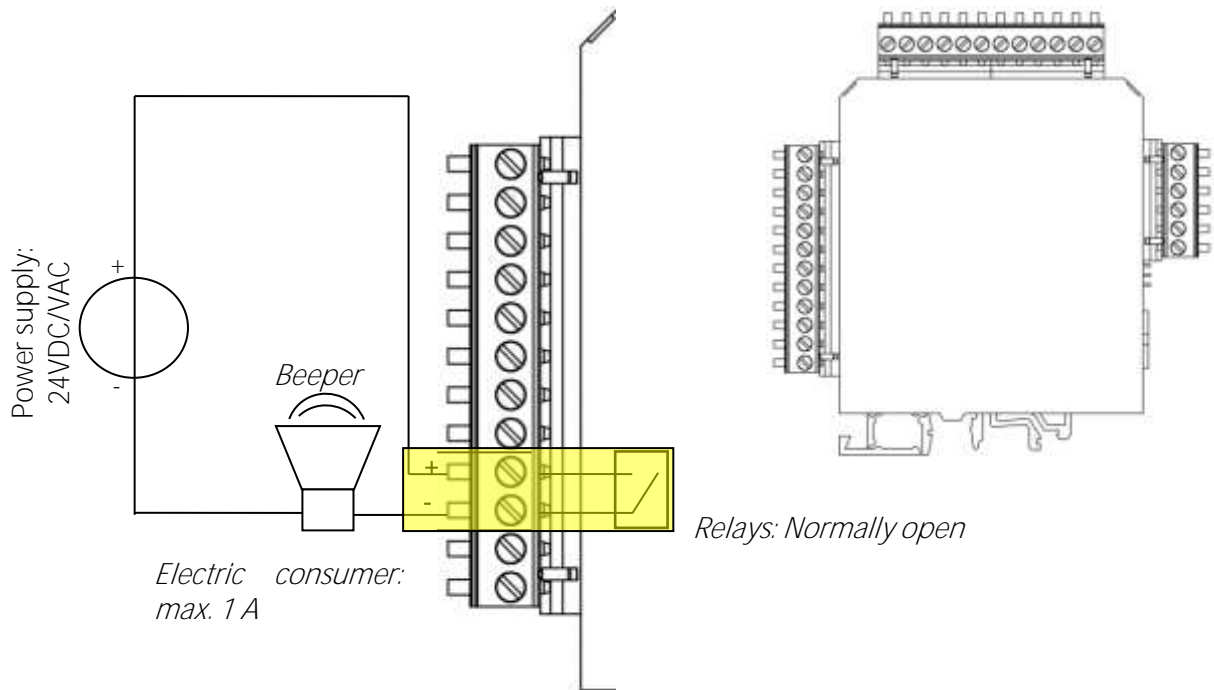

- Connect the parts with the relay inside the IO module.
- In the next step the alarm 1 must be configured at the SWG100. To do this, open the menu: **EXTRAS/ ALARM OUTPUT CONFIGURATION**. The following menu overview will be appeared (see screenshot below). To configure the alarm 1, select the first record (channel I/O 1/1 SP1 / CH4) in the list and open it.

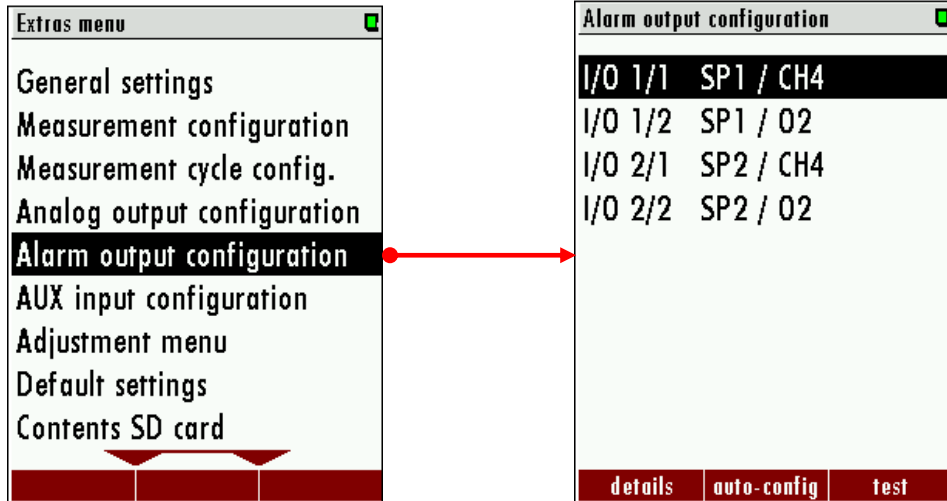

- The follow screen appears. To configure the channel 1, the red marked positions must be changed:

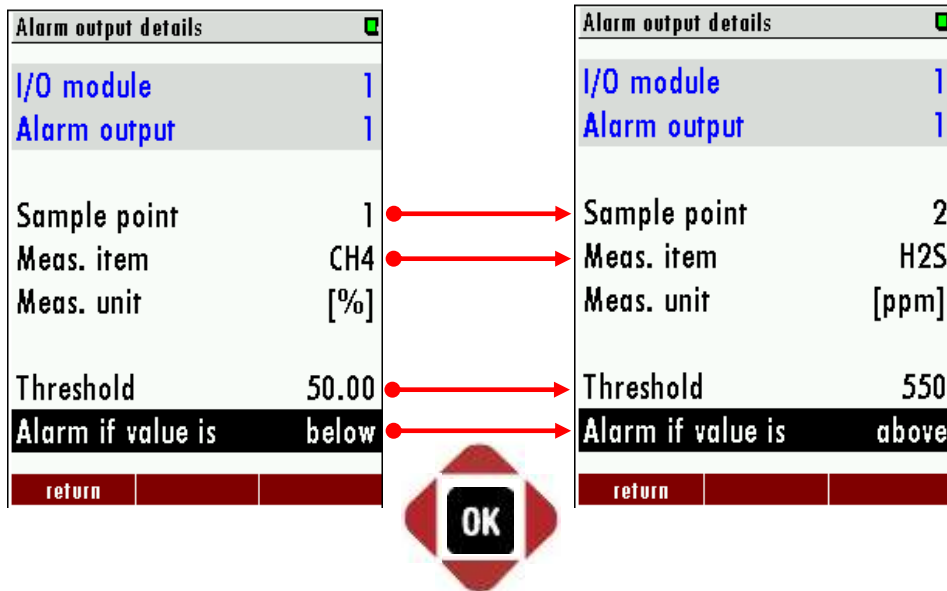

8.5. Analog inputs (4-20 mA)

Hardware-side:

The analog inputs are on the top of the IO module. They are marked with a blue label. Through the help of the analog inputs, the IO module can read all common 4-20 mA transducer in the analyzer directly. The IO module has a separate 12 V power source, for the supply of the transducer. At the sketch below, the inputs and the power supply, for the transducer are marked.

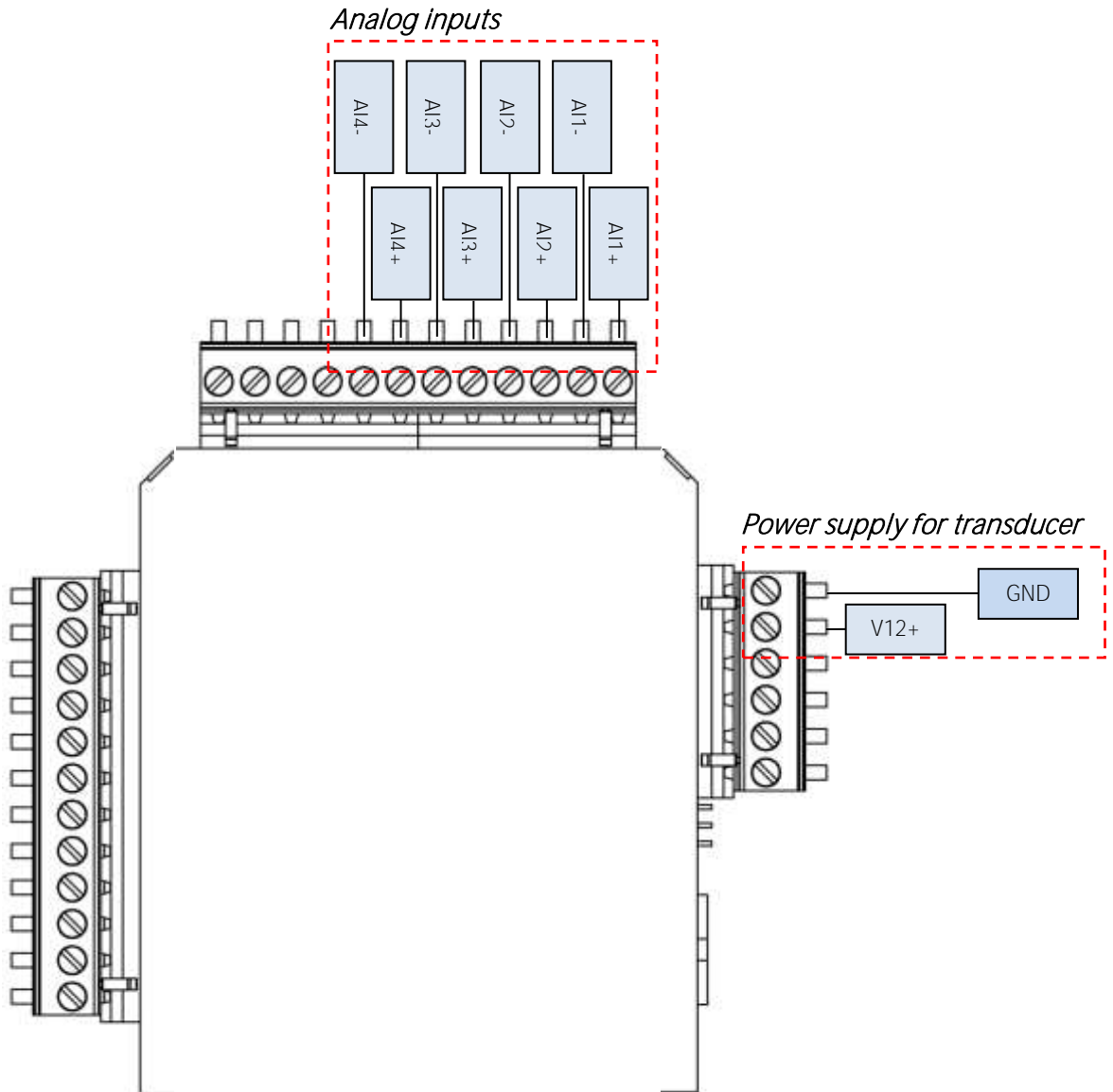

Information:

Internal Load:	50 Ohm
Power supply for transducer:	12VDC / 200 mA

The sketches below show how the common transducer can connect to the IO module.

2-wire transducer:

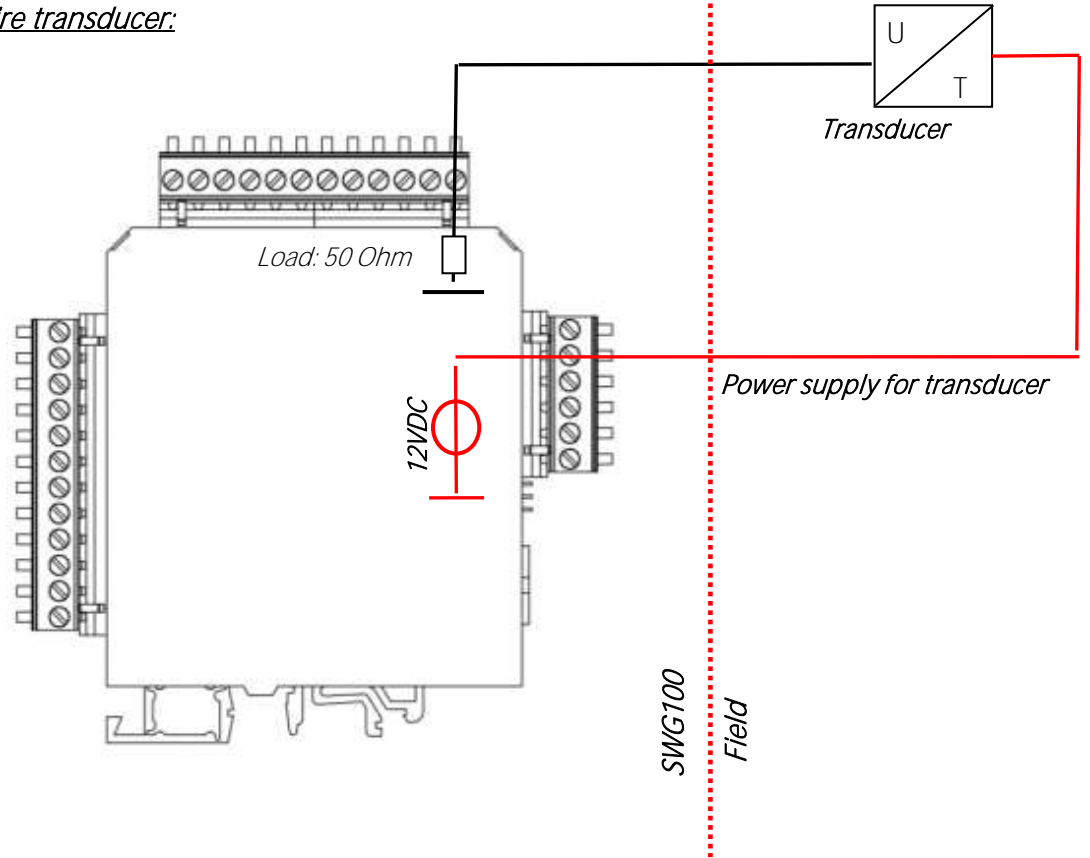

4-wire transducer:

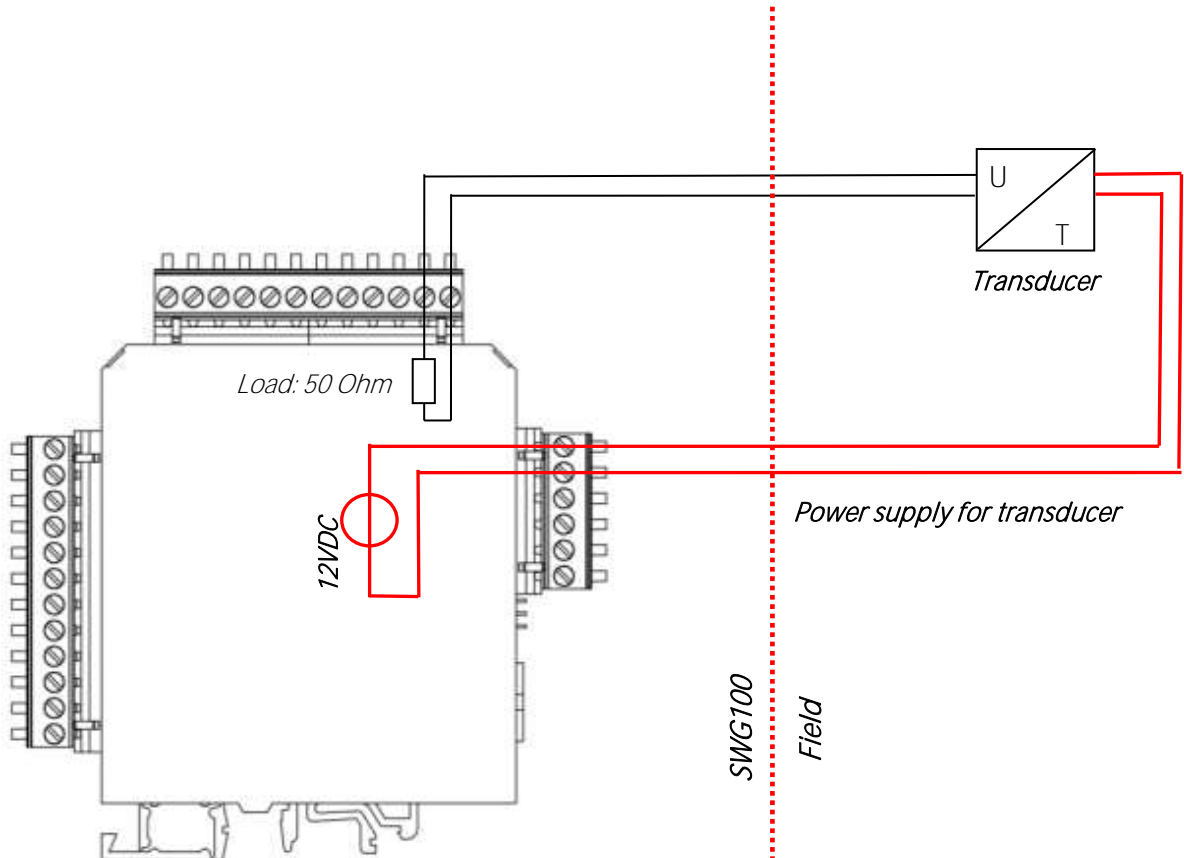

Software-side

- Open the menu: EXTRAS/AUX INPUT CONFIGURATION (1).
- The overview screen appears. At the overview-screen, the installed AUX-inputs are listed. Every IO module has four AUX-inputs. At the default settings all AUX-inputs are deactivated (OFF at the overview-screen).
- To activate an AUX-input, push **F1** (=details). The different IO-inputs can be selected with the up/down arrow keys.
- After one AUX-input is selected, the measurement item must be activated. To do this, turn the measurement item from OFF to definable.
- The measurement item “definable” is an individually measurement configuration, where the user can configure by himself.

The measurement item “definable” is an individual configuration channel. The menu “AUX input details” contains some pre-configured settings, like for temperature, or pressure sensors.

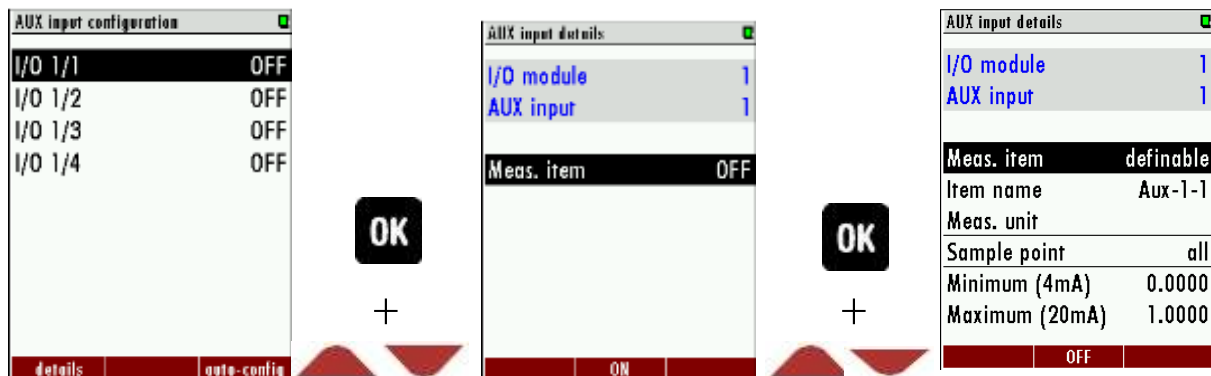

The structure of the menu “AUX input details”, for the channel “definable” is given at the screenshot below.

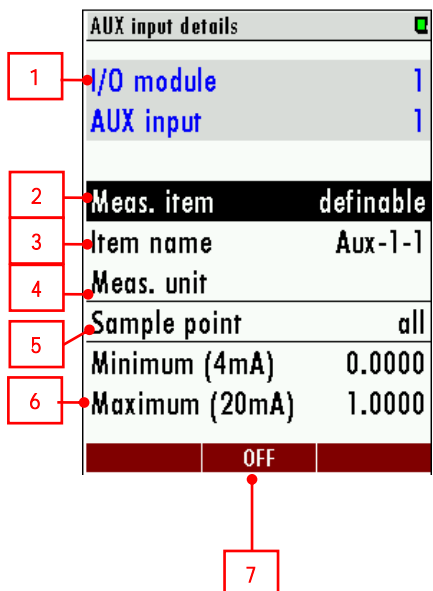

- **Section (1):** Show the operator, which analog-input will be changed.
- **Meas. item (2):** The operator can select the sample point. This means, that the analog-output signal from the choose sample point will be transmitted to the process control system.
- **Item name (3):** At this point the operator selects the measurement item, which should be transmitted. At the chart below, the typical measurements items are counted. Basically, all measurement-channels, which can be measured, can be selected at this point.
- **Meas. unit (4):** The dimension of the measurement item (example: %,ppm...)
- **Sample point (5):** This point shows, which unit the transmit signal have. This point cannot be changed.
- **Minimum (4mA) (6):** Here the operator entering the equivalent measurement value, for a current of 4 mA.
- **Maximum (20mA) (6):** Here the operator entering the equivalent measurement value, for a current of 20 mA. The IO module will create the linear relation.
- **OFF (6):** Leave the menu. Alternate push **F2**.

Example: Read 4-20 mA signal from an external temperature sensor

An operator wants to read an external temperature sensor signal inside a SWG100. The temperature sensor gives a 4-20 mA signal out and needs *a 7-30 VDC power source*. It will use *a two-wire transducer*. The temperature range is between -5...150°C.

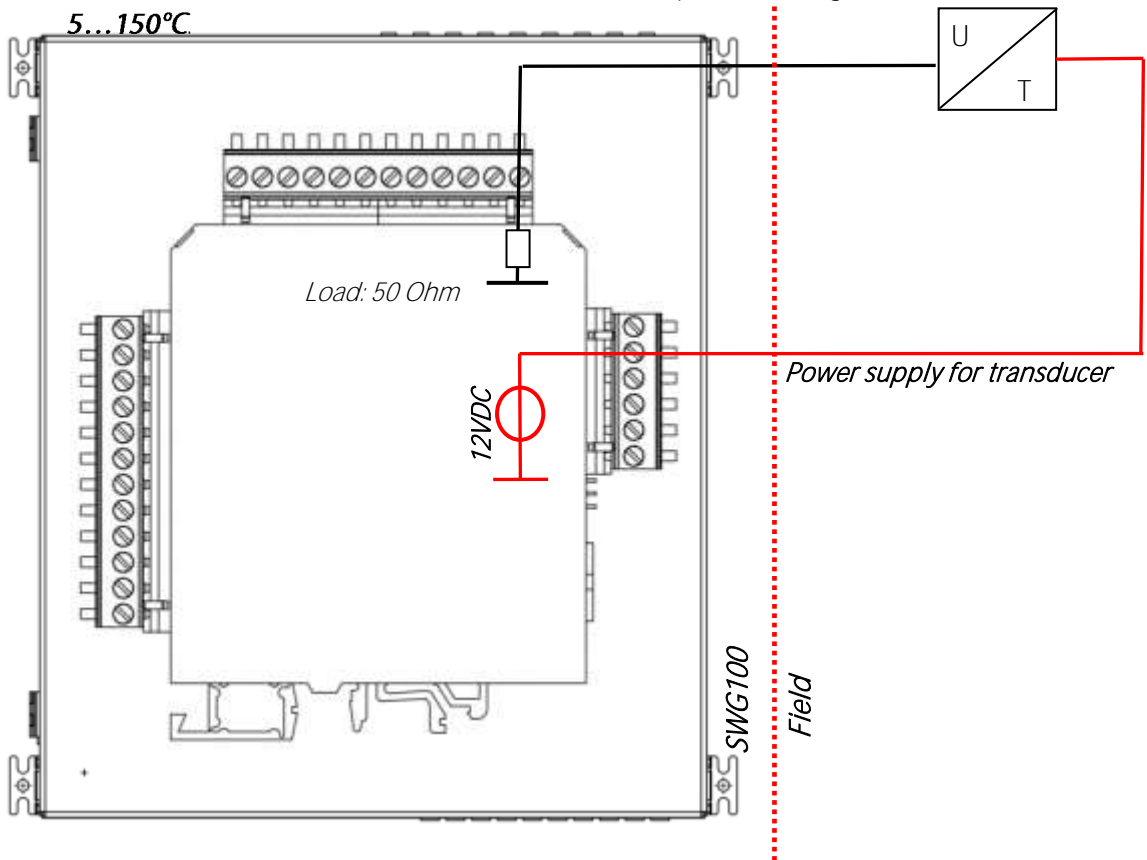

After the sensor is connected to the IO-module correctly, the sensor must be configured at the SWG100.

- Open the menu: AUX-input configuration. This menu can be found at the path: Extras/AUX-input.

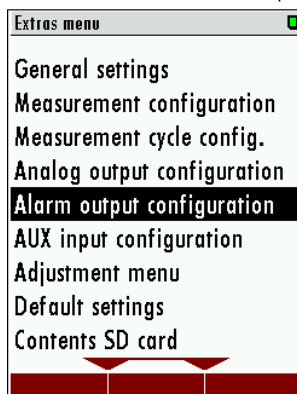

- First the operator sees an overview, which shows with kinds of sensors are mounted at the IO-module. In this example, there is no transducer mounted at the SWG100.
- To configure a new sensor, push **F1**.

- The follow screen appears. Here, the sensor can get an individual name.
- At the toolbar, the operator can select the options:
 - Details (F1): Here the select analog-inputs can be configured. If **F1** is pressed the follow screen appears.

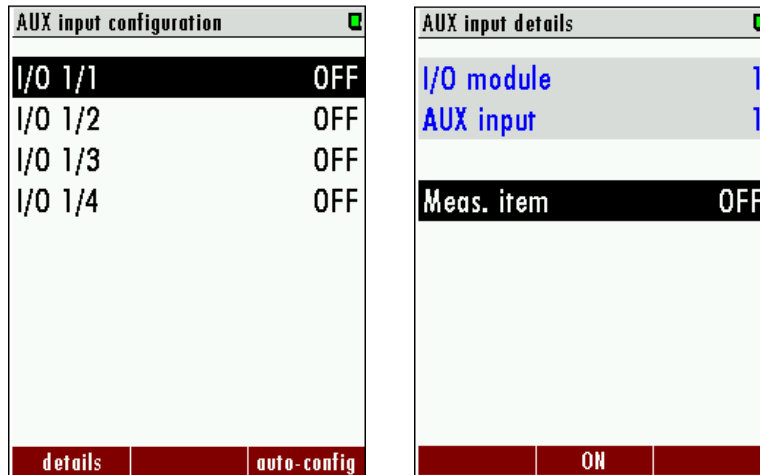

This screen means, that no transducer is configured. Meas. Item is OFF (default). With the ON key (F2) or the arrow right/ left key, the operator can skip inside the menu.

- If the AUX input is activated, the follow screen appears. At this screen the operator can define the incoming signal.
 - Meas. Item: This is the skip menu-point. Push the right/ left arrow key, to activate another define AUX-input.
 - Item name: Here the operator can enter a name for the AUX-input. To enter a name, press the OK key. An alphabet will appear, where the operator can enter a name.

8.6. Configuration of the external control (Option: IO module)

This feature requires an I/O module (optional) and the function must be activated.

This feature can be used for the external control of the analyser. With the help of the external control follow operations can be done:

- Externally controlled sampling point selection,
- Stand-by.

The commands will be given by a 4-bit binary number, which will be built through four external signals. The pins for the signal are shown in the sketch below. It exists two different types to set the four pins:

- Potential free relay contacts.
- 4-20 mA signal inputs.
- Through one 4...20mA input.
- Through Modbus.

The settings-menu can be found at the path: **EXTRAS/GENERAL SETTINGS → EXTERNAL CONTROL**.

The user can set three different types for the external control. The types can be found at the sketch below.

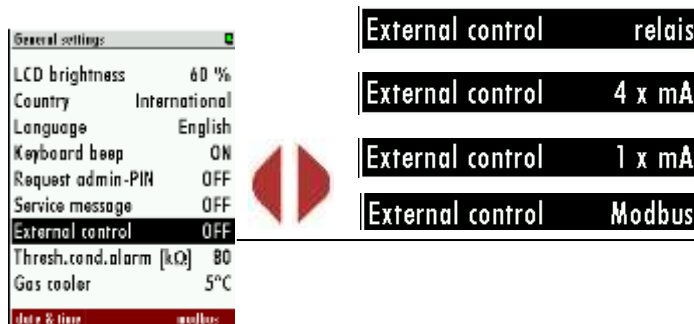

Connection of the external control via relay contact

This feature can be used for externally controlled sampling point selection, zeroing and stand-by, using external potential free relay contacts, see also diagram in §4.4. The relay contacts build a 4-bit binary number: RC4 - RC3 - RC2 - RC1 open=0, closed=1.

Let us show this number 'status number'.

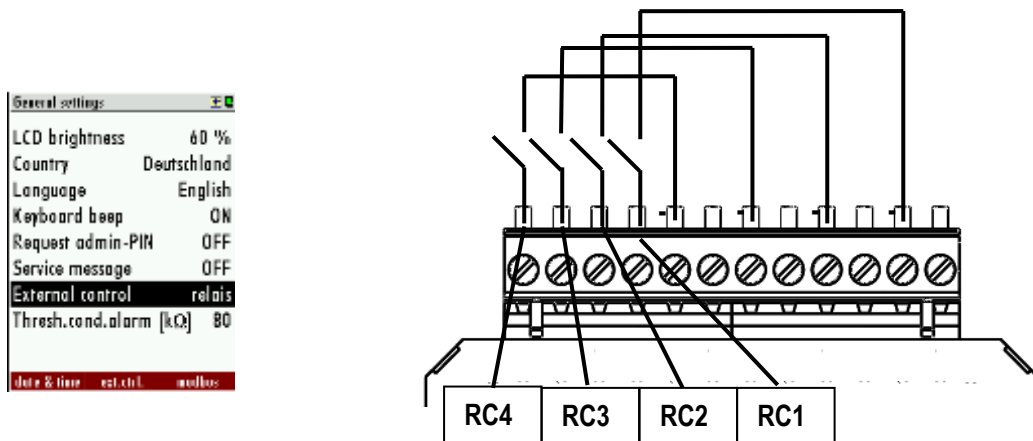

Status of external signal source				Status number	Description
RC4	RC3	RC2	RC1	-	-
0	0	0	0	0	Automatic sampling point switching
0	0	0	1	1	Analyzer is sampling the point SP1 (*1, *2)
0	0	1	0	2	Analyzer is sampling the point SP2 (*1, *2)
0	0	1	1	3	Analyzer is sampling the point SP3 (*1, *2)
0	1	0	0	4	Analyzer is sampling the point SP4 (*1, *2)
0	1	0	1	5	Analyzer is sampling the point SP5 (*1, *2)
0	1	1	0	6	Analyzer is sampling the point SP6 (*1, *2)
0	1	1	1	7	Analyzer is sampling the point SP7 (*1, *2)
1	0	0	0	8	Analyzer is sampling the point SP8 (*1, *2)
1	0	0	1	9	Analyzer is sampling the point SP9 (*1, *2)
1	0	1	0	10	Analyzer is sampling the point SP10 (*1, *2)
1	0	1	1	11	Analyzer is "stand-by" (*3)
1	1	0	0	12	Analyzer is "stand-by" (*3)
1	1	0	1	13	Analyzer is "stand-by" (*3)
1	1	1	0	14	Remote reset of all system alarms
1	1	1	1	15	Analyzer is "stand-by" (*3)

Connection of the external control via 4-20 mA input signals

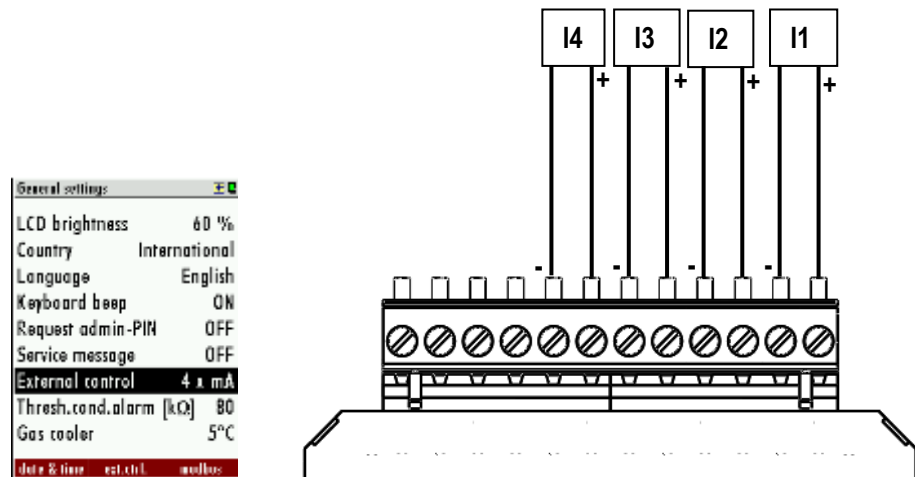

The signal inputs built a 4-bit binary number: I4 – I3 – I2 – I1: 0-11 mA=open=0; 11/12-20 mA=closed=1.

Status of external signal source				Status number	Description
I4	I3	I2	I1		
				-	-
0	0	0	0	0	Automatic sampling point switching
0	0	0	1	1	Analyzer is sampling the point SP1 (*1, *2)
0	0	1	0	2	Analyzer is sampling the point SP2 (*1, *2)
0	0	1	1	3	Analyzer is sampling the point SP3 (*1, *2)
0	1	0	0	4	Analyzer is sampling the point SP4 (*1, *2)
0	1	0	1	5	Analyzer is sampling the point SP5 (*1, *2)
0	1	1	0	6	Analyzer is sampling the point SP6 (*1, *2)
0	1	1	1	7	Analyzer is sampling the point SP7 (*1, *2)
1	0	0	0	8	Analyzer is sampling the point SP8 (*1, *2)
1	0	0	1	9	Analyzer is sampling the point SP9 (*1, *2)
1	0	1	0	10	Analyzer is sampling the point SP10 (*1, *2)
1	0	1	1	11	Analyzer is "stand-by" (*3)
1	1	0	0	12	Analyzer is "stand-by" (*3)
1	1	0	1	13	Analyzer is "stand-by" (*3)
1	1	1	0	14	Remote reset of all system alarms
1	1	1	1	15	Analyzer is "stand-by" (*3)

Connection of the external control via one 4-20 mA input signal

The user can control the analyzer with only the first 4-20mA input (see sketch below). The different commands will be given by the changing of the current signal. The offset-signal is 4 mA. Every 1 mA step describes a condition of for the external control. Overall the analyzer can take 16 different statuses. The first status is by 5 mA (4 mA+1 mA) the second is by 6 mA (4 mA + 2 mA) and so on until the 20mA signal is reached.

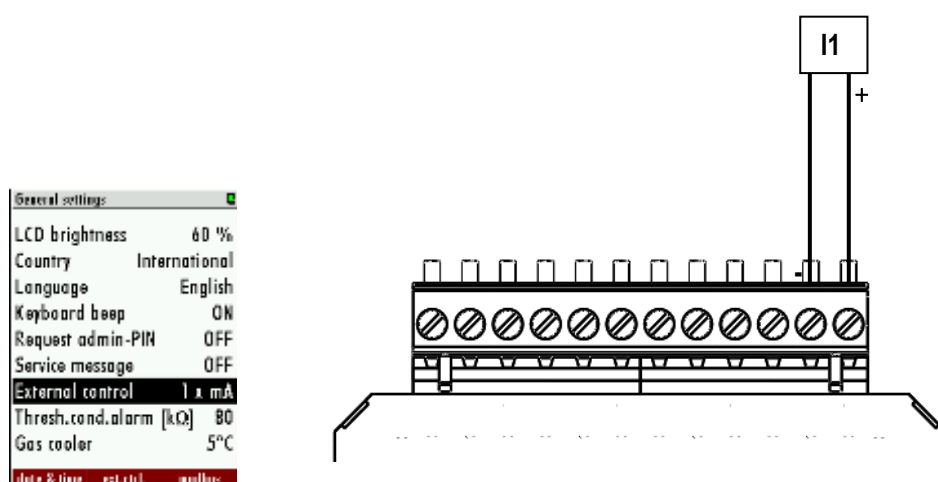

The connection of the one 4-20 mA signal is a two-wire connection.

Status of external signal source I [mA]	Status number	Description
4	0	Automatic sampling point switching
5	1	Analyzer is sampling the point SP1 (*1, *2)
6	2	Analyzer is sampling the point SP2 (*1, *2)
7	3	Analyzer is sampling the point SP3 (*1, *2)
8	4	Analyzer is sampling the point SP4 (*1, *2)
9	5	Analyzer is sampling the point SP5 (*1, *2)
10	6	Analyzer is sampling the point SP6 (*1, *2)
11	7	Analyzer is sampling the point SP7 (*1, *2)
12	8	Analyzer is sampling the point SP8 (*1, *2)
13	9	Analyzer is sampling the point SP9 (*1, *2)
14	10	Analyzer is sampling the point SP10 (*1, *2)
15	11	Analyzer is "stand-by" (*3)
16	12	Analyzer is "stand-by" (*3)
17	13	Analyzer is "stand-by" (*3)
18	14	Remote reset of all system alarms
19	15	Analyzer is "stand-by" (*3)

Connection of the external control via Modbus

A further option is, to control the external control via Modbus. To do this, follow steps must be done:

- Connect the RS485 to Modbus converter to the Modbus connector found at the main pcb. A description can be found in the chapter 7.4.
- Set the external control: Open the menu point "General settings": EXTRAS/GENERAL SETTINGS. Select the menu-point "EXTERNAL CONTROL" → MODBUS.
- The master writes a value on the address 6000, the value is the same than with external control via digital or analog inputs:



Status number values	Description
0	Automatic sampling point switching
1	Analyzer is sampling the point SP1 (*1, *2)
2	Analyzer is sampling the point SP2 (*1, *2)
3	Analyzer is sampling the point SP3 (*1, *2)
4	Analyzer is sampling the point SP4 (*1, *2)
5	Analyzer is sampling the point SP5 (*1, *2)
6	Analyzer is sampling the point SP6 (*1, *2)
7	Analyzer is sampling the point SP7 (*1, *2)
8	Analyzer is sampling the point SP8 (*1, *2)
9	Analyzer is sampling the point SP9 (*1, *2)
10	Analyzer is sampling the point SP10 (*1, *2)
11	Analyzer is "stand-by" (*3)
12	Analyzer is "stand-by" (*3)
13	Analyzer is "stand-by" (*3)
14	Remote reset of all system alarms
15	Analyzer is "stand-by" (*3)

Configuration at the analyzer

1. Open the path: EXTRAS/GENERAL SETTINGS.
2. Switch the menu-point "External control" from "OFF" to "Relays" "4 x mA" or "1 x mA" (dependent from the connected signal input). When the external control is activated an arrow symbol will appear at the title line.

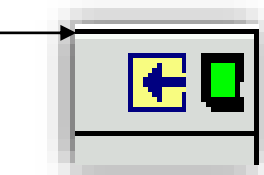

Arrow-Symbol: Shows the activation of the external control.

3. If a valid input state (>0) is present, an arrow in the title line will appear. The analyzer is now slave and will perform the measurement until it gets another command from the master unit. Some external control settings can be configured. This can be found at the path: **EXTRA/GENERAL SETTINGS** then **F2=ext.crtl.**
The user can set the zeroing time, suction/response time and stand-by purge time.

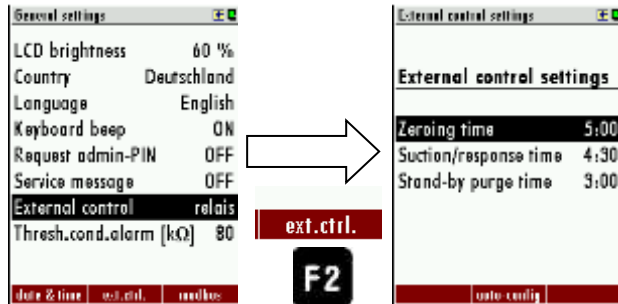

Case 1: Stand-by

The Stand-by mode will be activated if the input state is higher than the number of sample points (example: 4 sample points and input state 5...15). The Stand-by mode has the following pass:

- Purging with zero gas (for the configured duration)
- Standby until the input state is below or equal the number of sample points (e.g. 4 sample points and input state 1.4)

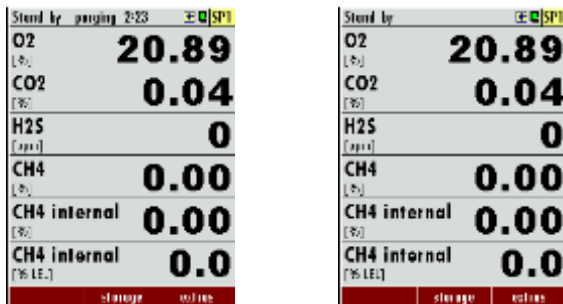

Case 2: External control of a sample point

-Zeroing: First the zeroing will be done. The duration of the zeropoint can be set at the menu **ext. ctrl.** (see point *"configured at the analyzer"* in the same chapter).

-Gas sampling: The gas sampling is for purging the entire system and give the analyzer enough time for response. (Response time). To set the suction/ response time, see point *"configured at the analyzer"* in the same chapter.

-Measurement: The measurement will be started after the response/ suction time is finished. It will be only abort, if the user changes the status of the external signal sources. The chart below shows the possible statuses, which can be set at the analyzer:

(*1): Whenever the selected sample point will be changed, then the analyzer will start a zeroing before measuring the new sample point.

(*2): Not only status numbers 4 to 15, but all status numbers larger than the number of installed sample points will start the "stand-by" (example: when you have 4 sample points, then status numbers 5 to 15 will trigger "stand-by").

(*3): When the status number changes to a "stand-by" number, then the analyzer will purge the sensors, then it will close all solenoid valves and switch off the gas pump. When the status number changes back to a value less or equal to the number of installed sample points, then a "set to zero" cycle will start and afterwards the selected sample point will be measured.

Note: The "stand-by" status can easily be used to initiate just a zeroing without any "stand-by" and without changing the sample point.

Example: - status number=1 (for any time period, recommended max. 1 hour)
- status number=15 (for a few seconds, recommended min. 10 seconds)
- status number=1 (for any time period, recommended max. 1 hour)

After installation and power-up of the analyzer few steps should be processed in order to operate the instrument properly.

8.7. Mounting and installation of the gas cylinders for the auto calibration function

Mounting and installation of the gas cylinders for the auto calibration function

The auto calibration function allows the calibration of the analyzer. To use the auto calibration function it is necessary to install the calibration gas bottles on the analyzer.

▲ WARNING



High pressure

- Only educated staff is allowed to install the gas cylinders on the analyzer.
- All gas cylinders must be equipped with a pressure reducer. The pressure must be set to **500 mbar**.

Recommended gas concentration for the gas bottle:

CO ₂	~39,95 Vol.%
CH ₄	~60,00 Vol.%
H ₂ S	~500 ppm

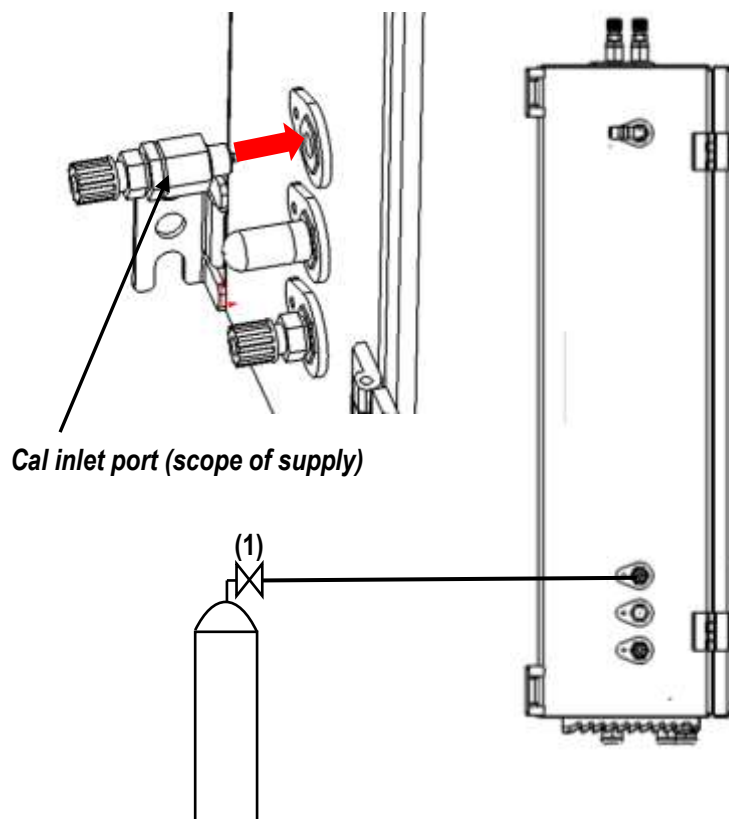

The diagram above shows the necessary installations for the auto calibration. The mixed gas cylinder is installed on the left side of the analyzer.

Software side: Adjustment for the option auto-calibration:

1. Open the menu "Setup auto-calibration". It can be found on the path: "EXTRAS/ ADJUSTMENT MENU/ SETUP- AUTO.-CALIBRATION".

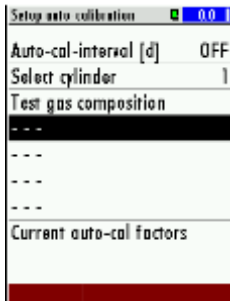

2. Select the menu point "test gas composition" to set the gas composition from the calibration gas cylinder. With the arrow keys "up/ down" an empty area can be selected. With the arrow keys "left/ right" the different gas compositions can be set.

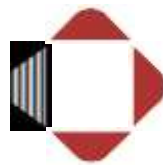
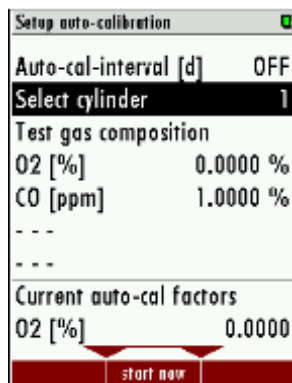

Arrow keys left/ right: With these keys the gas composition can be set.

Arrow keys up/ down: Single positions for the different gas compositions can be selected.

3. With **OK** the user is able to set the gas concentrations for the different gas compositions. First select the gas component, then press **OK**. A blue screen will be appeared. With the arrow keys the gas concentration can be set.

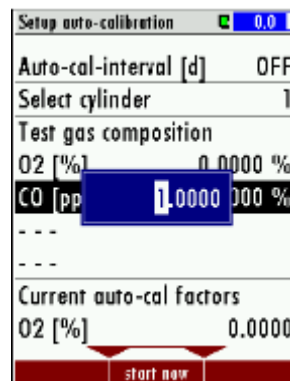
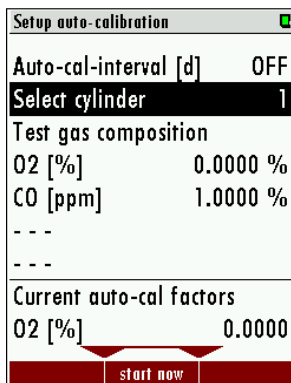

4. After the gas composition is set, the interval for the calibration can be set, too.

**NOTE**

All gas concentrations are in percent! The factory from percent to ppm is:
1%= 10.000 ppm.

5. The user has the following options:

- leave the menu: The set gas concentrations are stored and the auto calibration will start after the interval is reached.
- Start the auto- calibration immediately: Press *F2*(start now).

6. During the auto calibration the stored gas concentrations are compared with the measure gas concentrations. If the gas concentrations are not differing too much, the measured **values will be shown "green" on the display.**

7. The new gas factors will be stored, after successful calibration.

8.8. Cycle configuration

Path and default setting

EXTRA/ MEASUREMENT CYCLE CONFIG.

When the menu „MEASUREMENT CYCLE CONFIG.“ is selected the user definable setting for the measurement cycle will appear (see screenshot below).

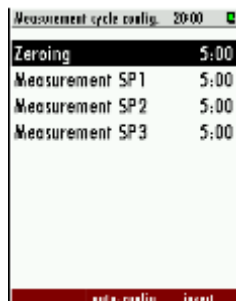

Measurement cycle config. 20:00	
Zeroing	5:00
Measurement SP1	5:00
Measurement SP2	5:00
Measurement SP3	5:00

Screenshot shows default setting, when the „MEASUREMENT CYCLE CONFIG.“ will be started the first time.

General information

The menu point „CYCLE CONFIGURATION“ allows the user to configure an individual measurement cycle. Every installed sample point can be configured. For the configuration the user has the following phases, which can be selected:

- Zeroing.
- Purging.
- Stand-by.
- Measurement SPx (SPx stands for Sample point 1, 2...).

The configuration is performed with the three function keys **F1**, **F2** and **F3**.

- **F1:** Delete a phase.
- **F2:** Make an Auto-config.
- **F3:** Insert a new phase.
- **OK:** View/change phase details
- **Left/right:** Change the phase type.

Auto configuration

With **F2** the „Auto-config.“ can be selected. The user can select one of two default cycle configurations.

- One zeroing / cycle.
- One zeroing / sample point.

The first program is for applications where the different measurement points have almost the same gas concentrations. The zeroing is not necessary at every change of the measurement SPX. The second program is for applications where the different measurement points have different gas concentrations. A zeroing is recommended after every measurement point change. The screenshots below show the „One zeroing / cycle“ and „One zeroing / sample point“ in comparison.



The two auto-configurations, which can be selected.

Depending on the analyser type, the first or the first and second phase cannot be deleted, deactivated or moved to another position.

Delete a phase

With **F1** a phase can be deleted. To do this, select the phase, which should be deleted and press **F1**.

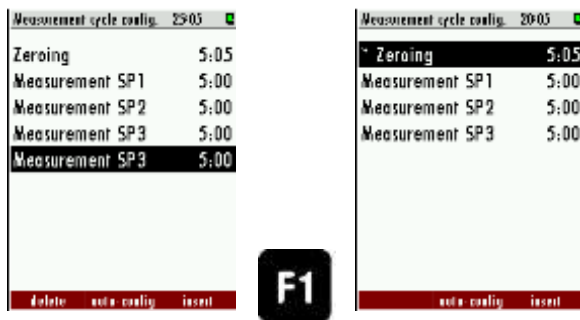

Screenshot shows how a phase can be deleted. In this example the last phase "Measurement SP3" is deleted.

Insert a phase

With **F3** a new phase is inserted in the measurement cycle. With the *right/left arrow keys* the different phase types can be selected.

In the title-bar the entire cycle time is shown. It is called "Measurement cycle config."
With **OK** the "Cycle phase details" can be shown and changed.

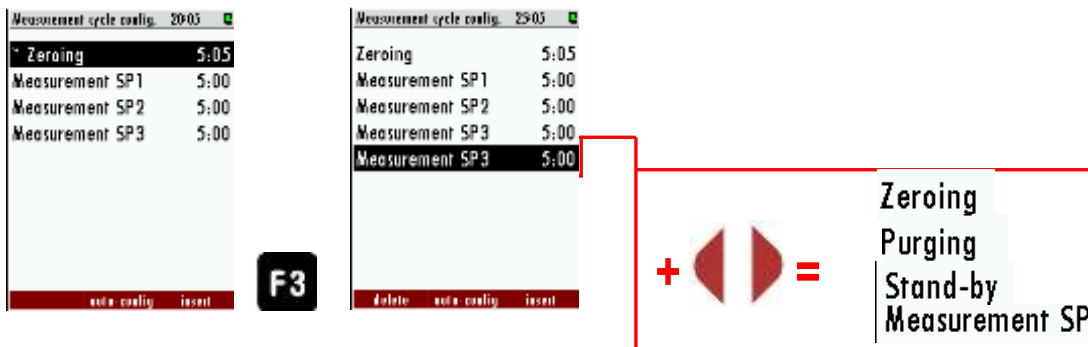

Configuration of the phase details

In this chapter the different cycle phase details will be explained.

Zeroing (Cycle phase details): In the cycle phase detail "ZEROING" the zeroing time can be configured.



ZEROING	
Measuring site valves	Valves closed
Zeroing valve	Valve open
Duration	2min to 1 h
Recommendation	5min., in general not to be changed by user as depending only on analyzer internal setup

Measurement SPX (Cycle phase details): In the cycle phase details of "Sample point X" the measurement time and the suction delay can be configured. Each sample point can be configured individually. In the cycle phase details the following times can be set:

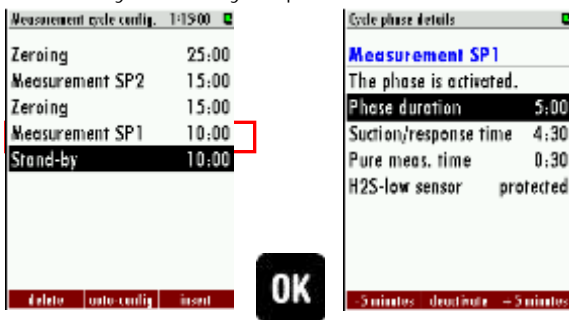

MEASUREMENT SPx	
Measuring site valves	Valve of selected site is open, others closed
Zeroing valve	Valve closed
Duration	Phase duration: 2 min. to 24 h Suction/response time: 30 sec. to 1h Pure measurement: calculated H2S-low: Activated/protect (Optional)

Stand-by (cycle phase details): In the cycle phase details "Stand-by" the sleep mode time can be configured. In the cycle phase details the following times can be set:



- *Phase duration:* Entire Stand-by time (Purging time + Quiet time = Phase time).
- *Purging time:* The time, to purge the analyser with ambient air, through the zero gas inlet.
- *Quiet time:* The time, where the analyser is in the pure stand-by mode.

STAND-BY	
Measuring site valves	Valves closed
Zeroing valve	Valve closed
Duration	Phase duration: 2 min to 24h Purging time: 30 sec. to 1h Quiet time: calculated

- *Purging (cycle phase details):* The purging is a separate configuration point to purge the analyser with ambient air through the zero gas inlet. It can be helpful, if the analyser must switch between a sample point with different sample gas concentrations.



PURGING	
Measuring site valves	Valves closed
Zeroing valve	Valve open
Duration	30 sec. to 1 h

Activated/deactivated a phase

The user has the opportunity to deactivate a phase in the measurement configuration cycle. This could be necessary for example if a sample point is temporarily not in use. The activation and deactivation of a phase can be done in the cycle phase details of the concerning phase.

Example for the deactivation of a phase

In this example the "Measurement SP2" will be deactivated. The deactivated phase is grey out.

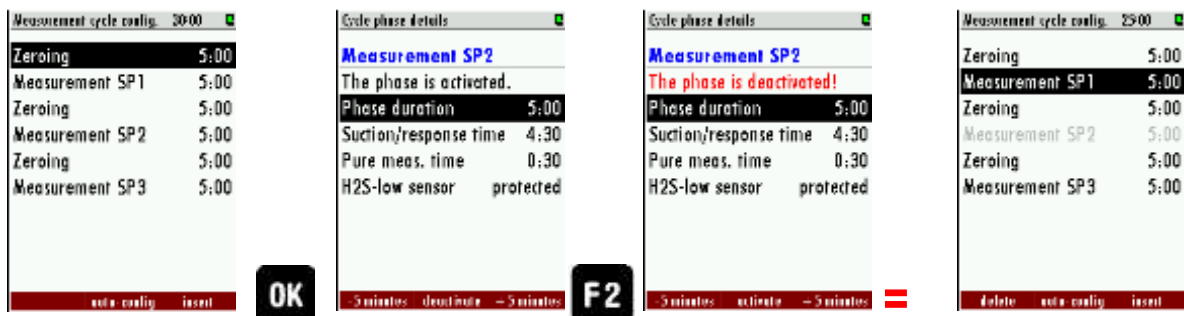

Example for a measurement cycle configuration

In this chapter an individual measurement cycle should be created with the features described at the chapters below.

The measurement cycle should have the following sequence:

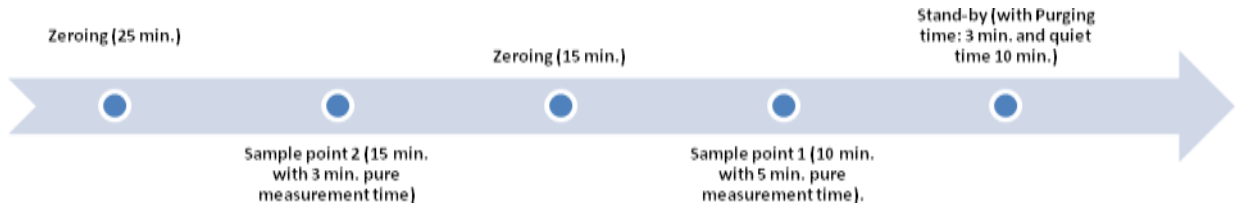

Following points must be done to configure the individual measurement cycle:

1. Open the measurement cycle config. menu: Path: EXTRA/ MEASUREMENT CYCLE CONFIG.
2. The default measurement cycle will appear. Open the cycle phase detail of the first zeroing and adjust the phase duration at 25 min.



3. Leave the cycle phase detail and select the second point. Switch with the *left/right arrow keys* until the measurement SP2 is selected.



4. Open with the *OK* key the cycle phase detail of the measurement SP2. Adjust the duration-phase at 15 min. and the suction/response time until the pure meas. time has the value of 3 min. Use for this operation the *arrow keys*.



- Leave the cycle phase detail and select the next phase. Select with the *left/right arrow keys* the phase "zeroing" and go in the cycle phase detail. Adjust the phase-duration at 15 min. and leave the cycle phase detail.



- Switch to the next point and select with the *left/right arrow key* the measurement SP1. Go in the cycle phase detail of the measurement SP1. Here adjust the duration-phase 10 min. and the pure measurement time: 5 min.



- At last push *F3* key for insert a new phase and select with the *left/right arrow* key the "Stand-by" phase. Go into the cycle phase detail and adjust the Purging time at 3 min. and the Quiet-time at 10 min.



Leave the menu and save the adjustments. The individual configuration is done.

8.9. Administrator PIN code

All functions and menus which may disturb the analyzer's normal measurement can be protected against unauthorized access by activating the administrator PIN code request.

We highly recommend activating this function, when unauthorized persons could access the analyzer.

The PIN code is: **F1 - F1 - F3 - F2 - Up - Down**

The PIN code request can be activated and deactivated in the menu Extras/General settings:

The deactivation of the PIN code request requires at least one time PIN code input.

Once the user has inputted the correct administrator PIN code the analyzer will stay in administrator mode (password free) for 10min after last time key press. Each key acting will trigger another 10 minute password free operation.

8.10. Power-On of analyzer

When the analyzer is connected with mains power (Power-On) it will start the system boot process which usually takes very few seconds. Then the display will show the self-test menu.

9. Operating the analyzer

This chapter has the follow structure:

- In the first part it will be explained, how to start the analyzer and the self-test menu.
- Part three shows the submenu, which are listed at the EXTRA menu.
- Part four shows the store menu.

9.1. General process of the measurement cycle

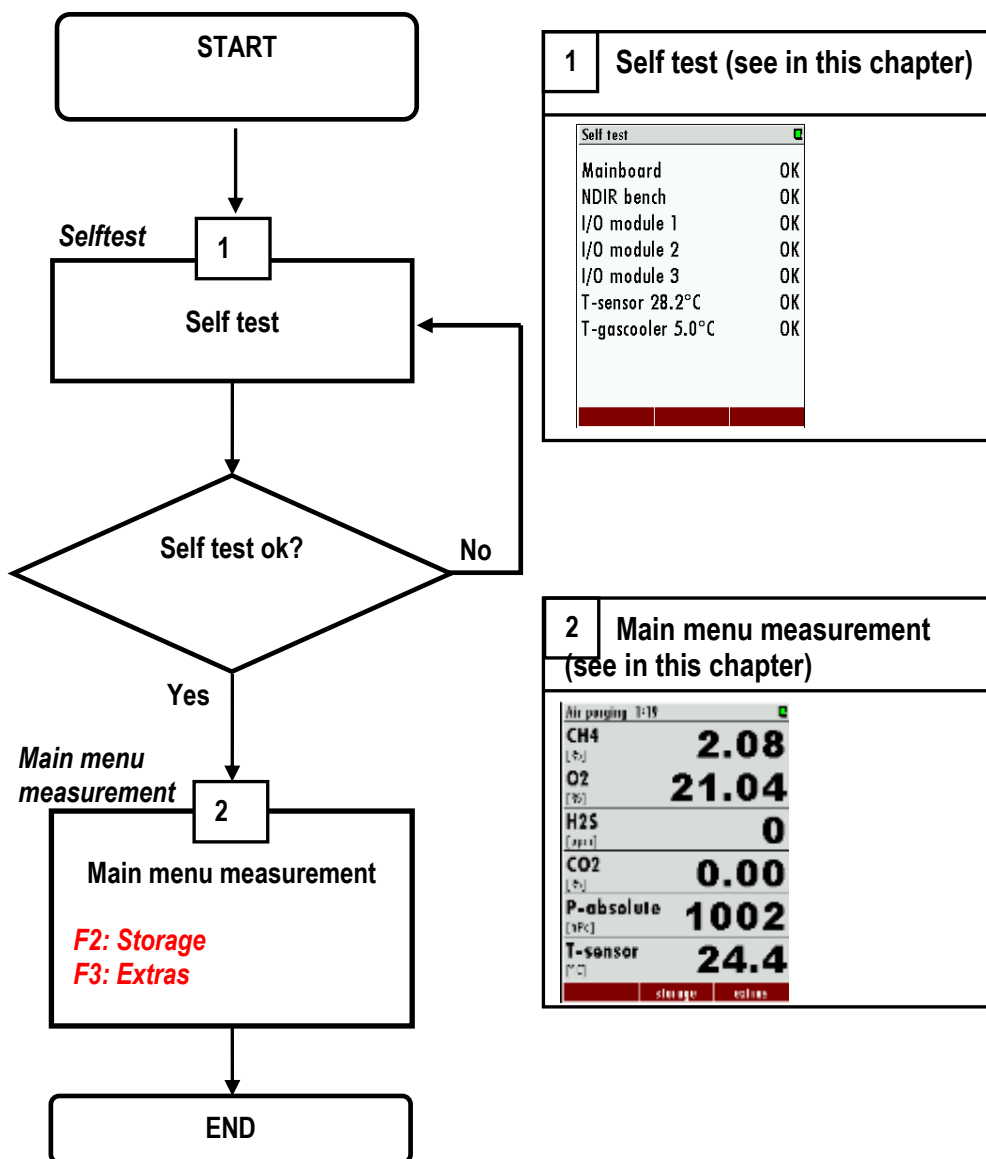

Self-Test

The first menu to be displayed after Power-On is the self-test menu. The analyzer won't leave this menu before all sub-systems will be connected and the gas cooler (option) has reached the target operation temperature.

During the self-test phase

- the gas pump is switched off
- all analog outputs will deliver 2mA
- all alarm outputs will have alarm status (open contacts)

Usually the self-test will be left automatically as soon as all conditions for measurement are satisfied. Then the first zeroing will be started.

If one of the internal RS485 bus participants are issuing alarm (faulty) status, the user can still leave the self-test manually by pressing F2='forward' (PIN code requested), even if not all sub-systems or the gas cooler are ready.

NOTE: this is for service purpose only!

Main menu measurement

This menu is the root of all menus and will be shown automatically as soon as the self-test is finished. The title bar you can see on the left the current measurement cycle status and how long it lasts and the actual sampling point number. In the middle section of the actual measurement values are displayed.

Measurement 6:14		SP1
CH4 [%]	58.13	
O2 [%]	0.33	
H2S [ppm]	196	
CO2 [%]	40.46	
CH4 ambient [% LEL]	0.4	
CH4 ambient [%]	0.02	
Sample point	storage	extras

Representation during the status "measurement"

The title bar you can see on the left "measurement" and the remaining measurement duration, and the right **light blue highlighted** sampling point number SPx (x = 1 to 10) that is being measured. In the middle section of the menu, the current (live) values are displayed.

Representation outside the status of "measurement"

The title bar you can see on the left "air purging" or "gas sampling SPx" and the remaining duration of the current status. On the top right you can see the **yellow highlighted** sampling point number SPx previously measured or that you have selected for display and their measuring values are held until it is measured again. In the middle section of the menu held measured values of these measurement sites are displayed.

Air purging 1:12		SP2
CH4 [%]	60.52	
O2 [%]	0.26	
H2S [ppm]	197	
CO2 [%]	38.08	
CH4 ambient [% LEL]	0.4	
CH4 ambient [%]	0.02	
Sample point	storage	extras

Change the Display Zoom / Standard

Two display modes are available:

- standard view mode with 6 values per page, up to 4 pages (indicating up to 24 values)
- zoom view mode with 2 values per page, up to 6 pages (indicating up to 12 values)

The indication mode can be swapped with the menu key and the selection of zoom view or standard view.

For devices with just one measuring point the switching is additionally possible with the arrow keys up / down.

Change the displayed page

Use the arrow keys left / right can be changed in both display modes the page. The new page number is displayed in the title bar for a moment just after the successful change.

Change sampling point displayed

For analyzers with several measuring points can use the arrow keys up / down the displayed (not measured) measuring point can be changed. In this way you can get an overview very quickly over the last measured values for all points. In the background, the analyzer uses the measurement cycle continues uninterrupted. However, once a measurement phase is completed, the display automatically switches to the actual measurement location.

Configuration of the measurement window (display content)

The measuring values selection and arrangement is user configurable in both display modes.

Press the content menu key and select the function 'Define measuring window'. A cursor (inverted line) will appear. The cursor can be moved with the arrow keys up and down. The arrow keys left and right will change the measuring value in the selected line. When the cursor is moved over the top or under the bottom line, then the next definable page will show up.

As soon as you have finished the configuration, press the ESC key (or press again the menu key and select the function 'Save measuring window'). You will be asked, whether the changed settings shall be stored or discarded. Select 'keep them' in order to store your changes.



9.2. Data Storage Menu

The data storage menu can be reached by pressing **F2**= 'storage' in the measurement menu:

The menu provides an overview of stored measurements of each sample point and of the memory usage.

NOTE



DATA STORAGE

The analyzer makes use of an internal flash memory to store measurement values automatically.

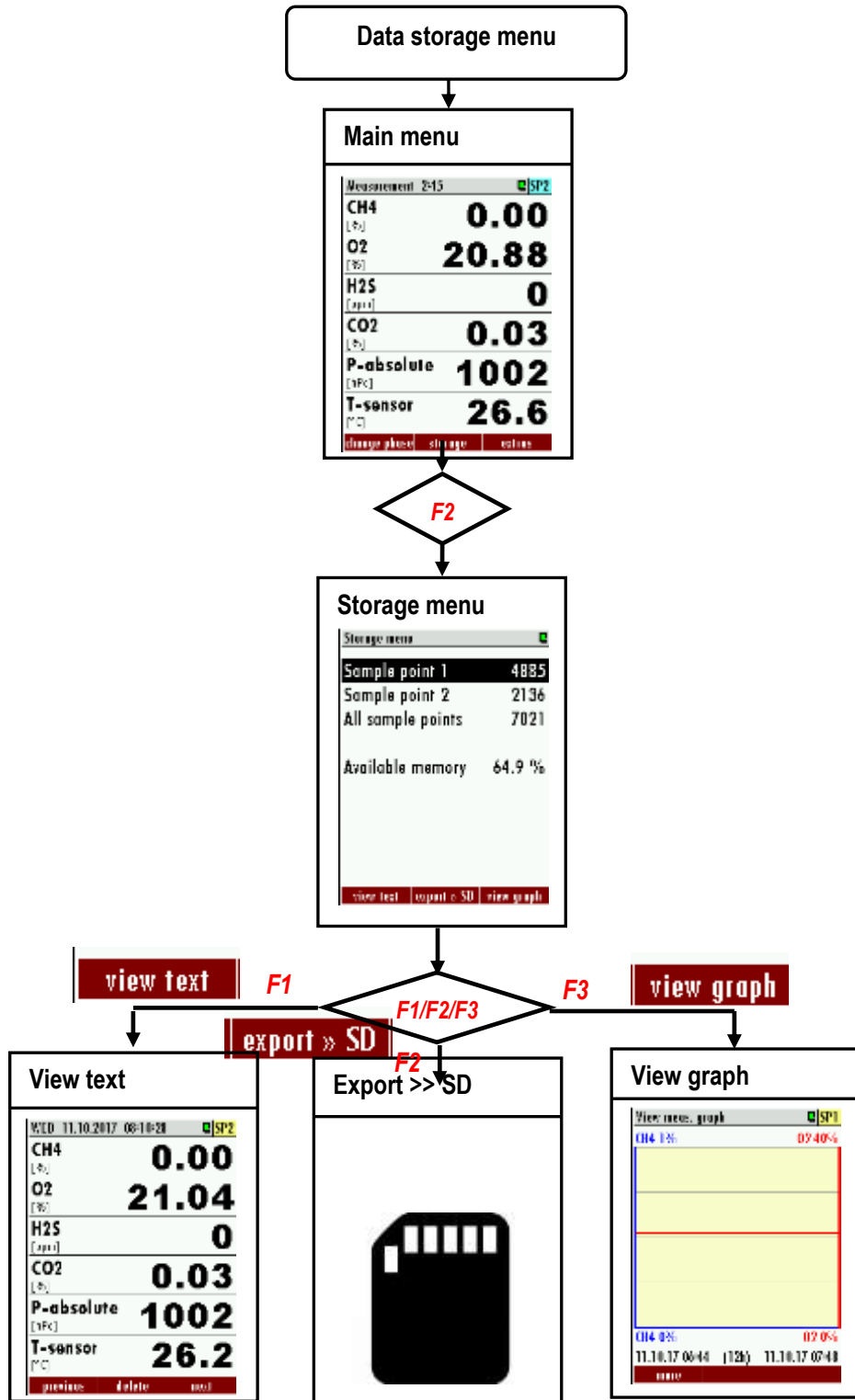

General information about the data storage

Data storage strategy is as follows:

- The analyser may store up to 20,000 measurement points (including all relevant data).
- At the end of each measurement cycle (per sampling point) the current values will be stored.
- The memory is used as a ring buffer. As soon as the memory is completely occupied, the latest measurements will replace the oldest measurements.

Specifically:

If the used memory is 99%, then the oldest 20% of the measurements will automatically be exported to SD card in CSV format and then deleted from the memory. In case the SD card export doesn't succeed (SD Card missing or read-only), then only the oldest 4% of the measurements will be deleted. The file names reflect the date of the most recent measurement contained in the export file, e.g. "20141031.csv".

Example:

An analyser with 2 sample points and a total configured cycle time of 32 minutes saves $2 * 24 * 60/32 = 90$ measurements per day (45 of each sample point). So the ring buffer will provide measurements of the last $20000/90 = 222$ days (more than 7 months).

View stored measurements in text mode

This function can be reached from the Data Storage Menu by selecting one or all sample points and by pressing F1='view text':

When entering the menu the latest stored measurement will be displayed. With the keys F1='previous' and F3='next' the measurements can be browsed (F3 will lead to the oldest measurement when the latest was displayed before - wrap-around).

You may delete a single measurement here, usually you won't need this function. The arrow keys have the same function than in the measurement menu.

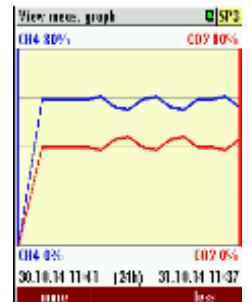

View stored measurements in graphic mode

This function can be reached from the Data Storage Menu by selecting one sample point (not all) and by pressing F3='view graph':

Two curves for one pair of data are shown at the same time in one diagram. The used scales are determined automatically and can't be changed by the user.

The offered pairs of data are determined by the setting of the zoom values in the measurement menu. The displayed pair of data can be changed by pressing the arrow keys up or down.

When entering the menu the measurements of the last 24 hours will be displayed. This interval can be changed by pressing the keys F1='more' or F3='less'.

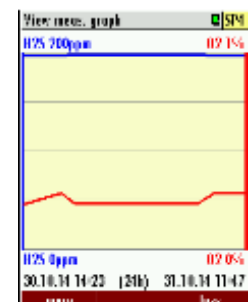

Export of measurements to SD card

This function is used to export the measurements from the analyzer to a PC. The used format is CSV (comma-separated values). Many computer programs are able to read this format, e.g. spread sheet calculation programs.

The CSV format is not exactly the same in all countries. The analyser selects a fitting format variation according to the selected country. Nevertheless the CSV output can be changed the Data Storage Menu.

This function is only available, when a SD card is inserted and is not write protected. The export can be started in the Data Storage Menu by selecting one or all sample points and by pressing *F2='export >> SD'*. The created files have names like 'BIOxxxx.csv', in which the xxxxx are continuing 5 digit numbers with leading zeros.

The 1st line of the created file is a column header with the following information: Sample point number, Date, Time and all measurements. The following lines contain the data.

CSV-configuration settings

1. Push „store“ (*F2*) in the main-menu.

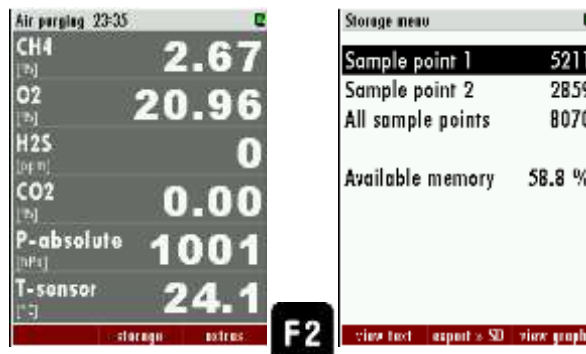

2. Open the context-menu in the store-menu. Select the menu-point “CSV-configuration” in the context-menu.



3. It appears a list of all configured csv-datas. With the keys *F1*, *F2* and *F3* the user can navigate through the configuration-menu. The single keys mean:
 - F1=insert: Insert an entry below the cursor-position.
 - F2=move: Move the entry from the cursor-position to another one.
 - F3=delete: Delete the entry from the list.
4. Inside the CSV-configuration, the user can change between three predefined lists. To open the selection of these, open the context-menu inside the CSV-configuration-menu and select one of the lists. The lists get the follow features:

- Set maximal list: In this list all available measurement values and all 9 asset lines are pictured.
 - Set default list: In this list all available measurement values and 2 asset lines are pictured.
5. Set small list: In this list the general measurement values are pictured.

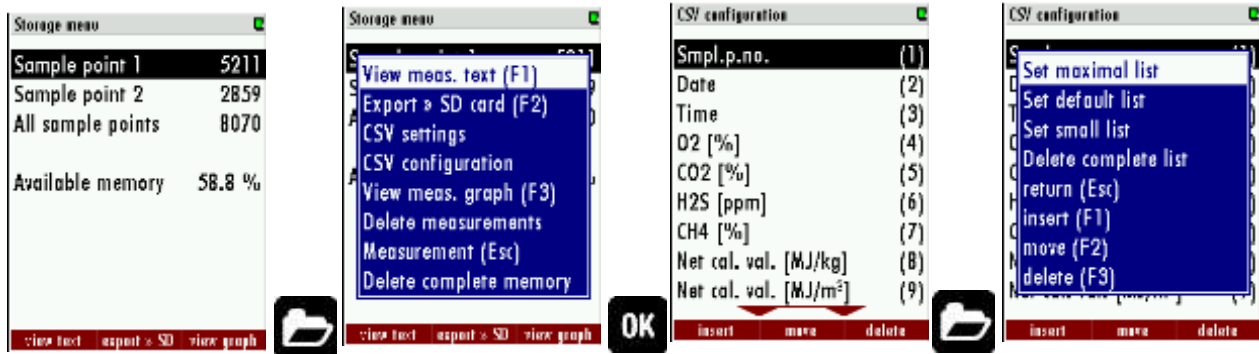

9.3. Extra menu: Overview

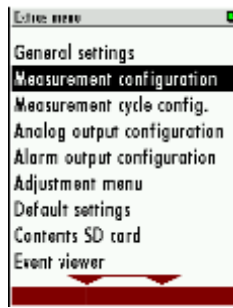

- General settings
- Measurement configuration
- Measurement cycle config.
- Analog output configuration
- Alarm output configuration
- Adjustment menu
- Default settings
- Content SD card
- Even viewer
- Device info

General settings

Path: EXTRA/GENERAL SETTINGS

Structure:

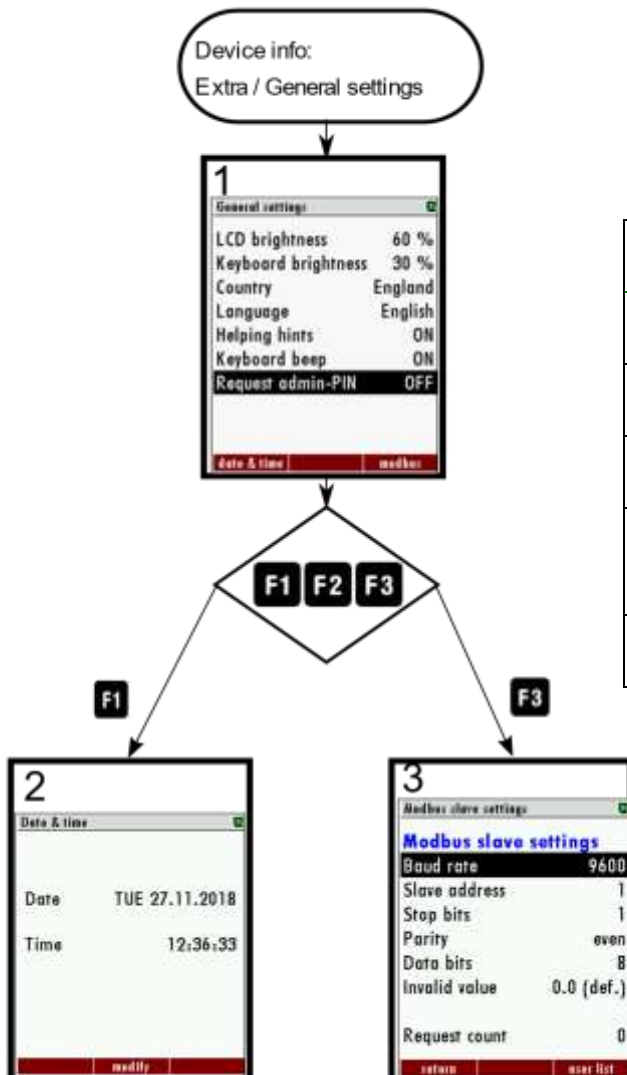

LCD brightness	10% until 100% / default 60% / 5% steps
Country	Diverse /default English
Language	Diverse / default English
Keyboard beep	<i>ON</i> or <i>OFF</i> / default <i>ON</i>
Request admin-PIN	<i>ON</i> or <i>OFF</i> / default <i>ON</i>
Service message	<i>ON</i> or <i>OFF</i> / default <i>ON</i>

3:	
Baud rate	9600 or 19600
Parity and stop bits	Even / 1 or None / 2
Slave address	0...238

Measurement configuration

Path: EXTRA/MEASUREMENT CONFIGURATION

Structure:

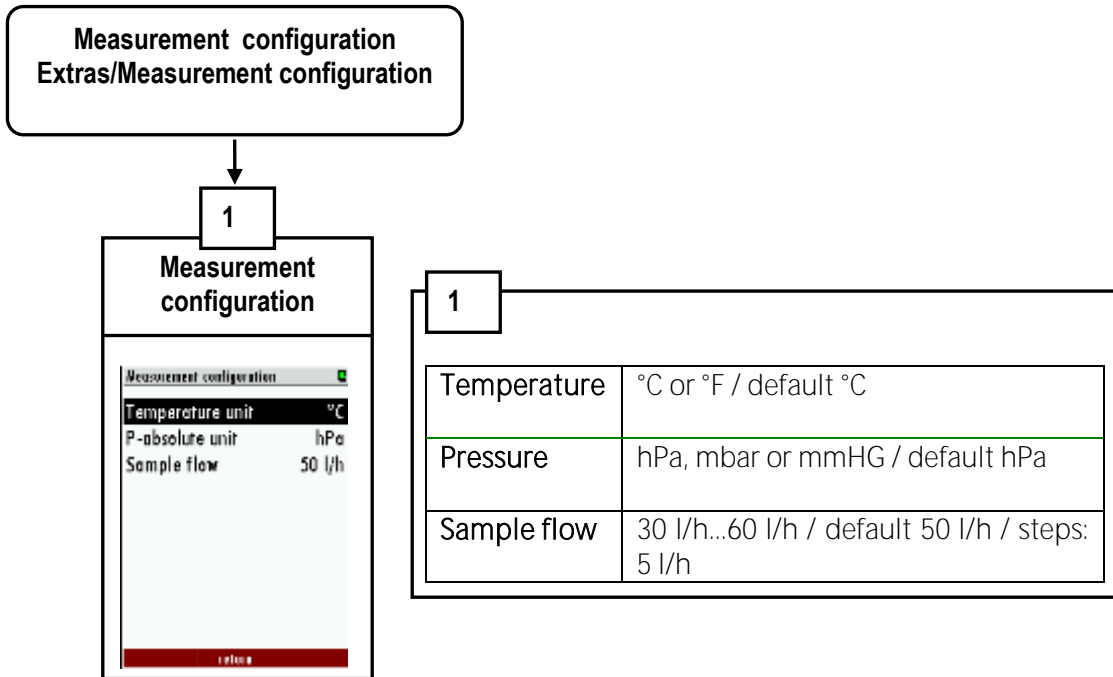
Measurement cycle config.

See chapter 7.10.

Analog output configuration

See chapter 7.6.

Alarm output configuration

See chapter 7.3.

Adjustment menu

Path: EXTRAS/ADJUSTMENT MENU

Structure:

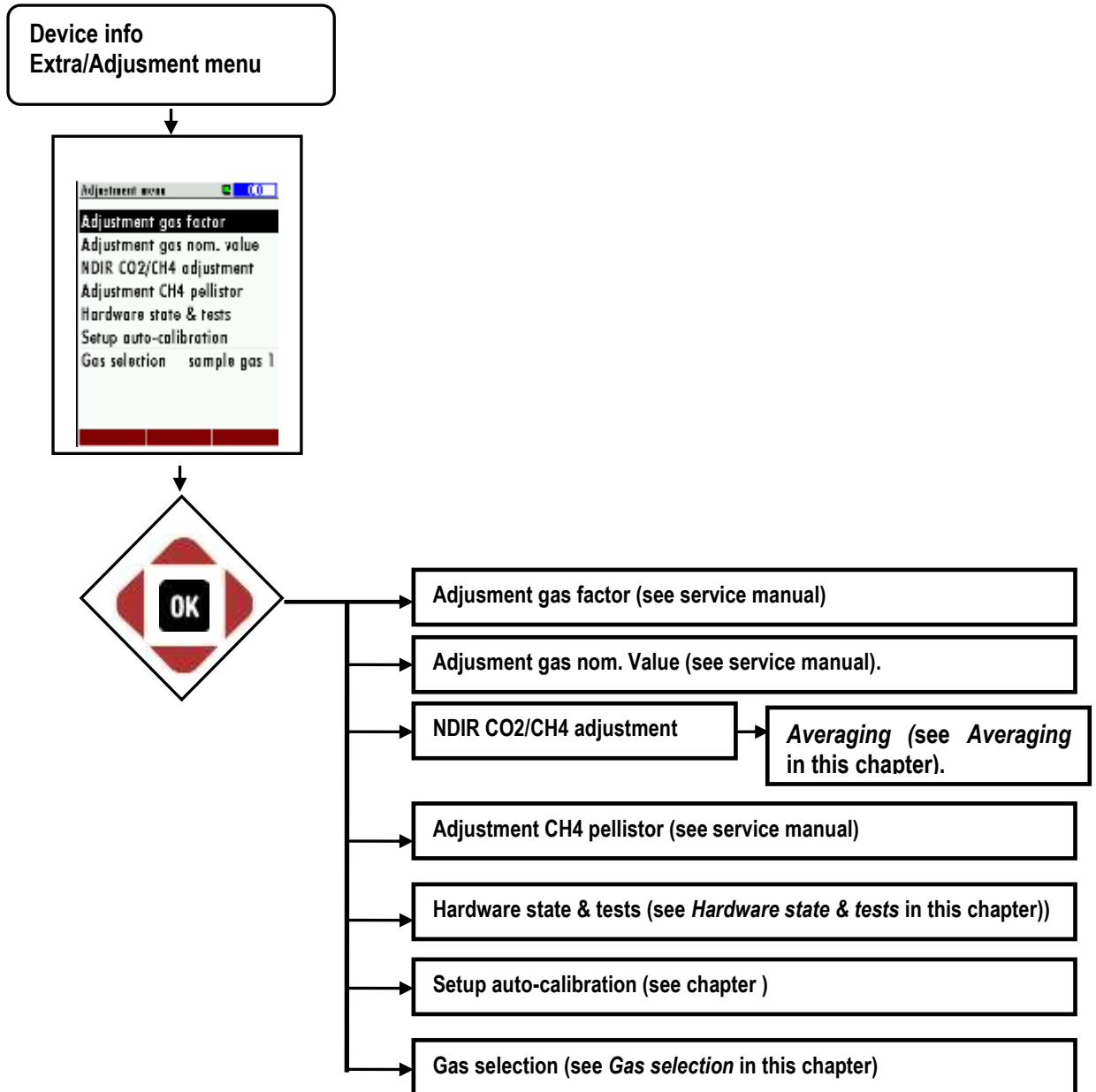

Hardware state & tests:

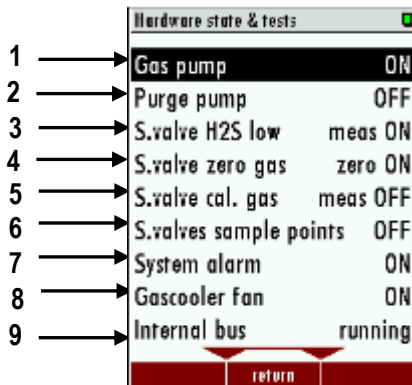

#	Hardware	Settings
1	Gas pump	ON or OFF
2	Purge pump (optional)	ON or OFF
3	Solenoid valve H2S low (optional)	ON or OFF
4	Solenoid valve zero gas	ON or OFF
5	Solenoid valve cal. Gas	ON or OFF
6	Solenoid valve sample points	ON or OFF able to skip to the next one
7	System alarm	ON (NO) or OFF (NC)
8	Gascooler fan	ON or OFF
9	Internal bus	RUNNING or QUIET

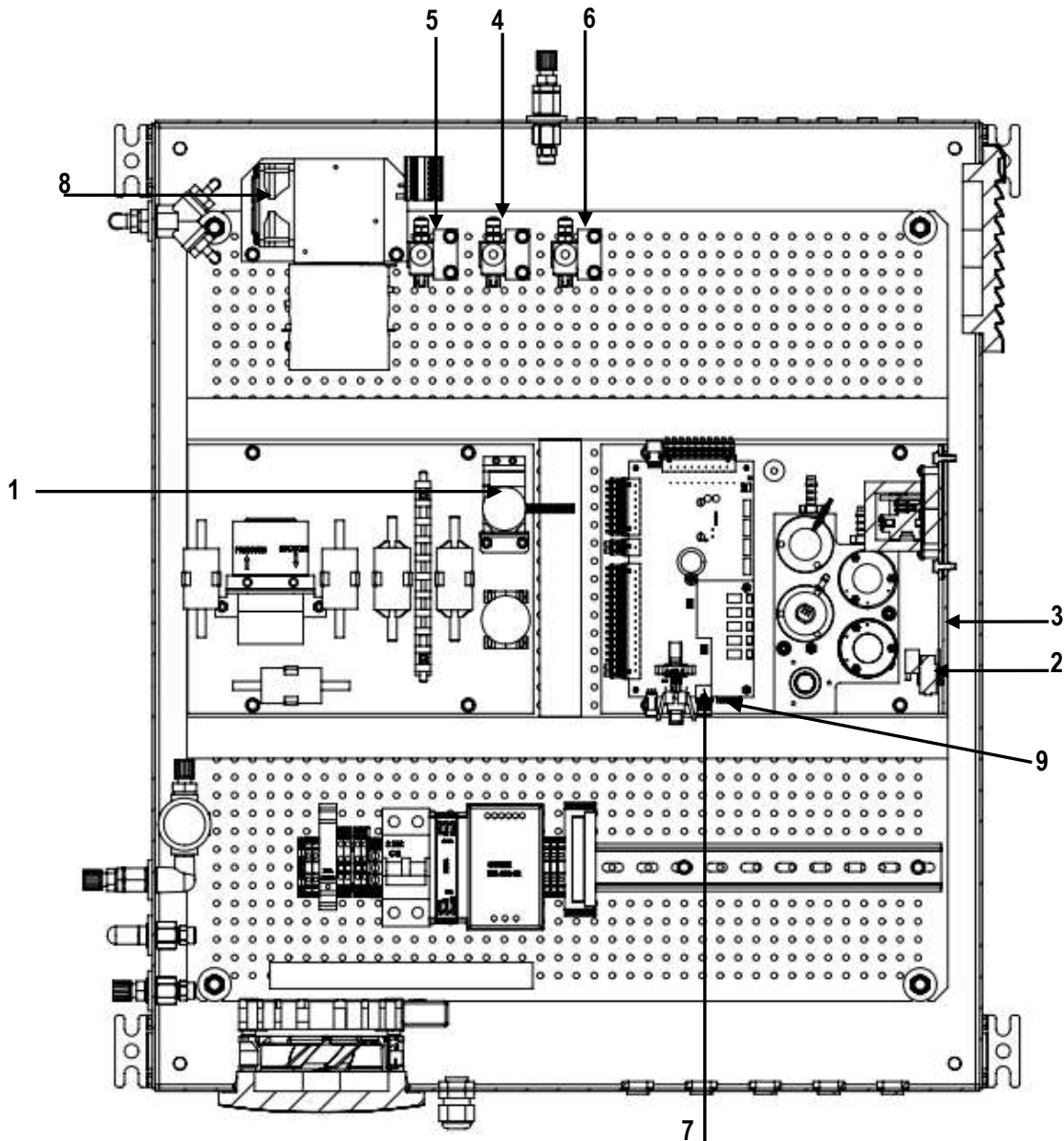

Adjustment of the average-time for CO₂/CH₄ NDIR-bench (optional)

If the analyser is equipped with a CO₂/CH₄ NDIR-bench, the user has the possibility to set the average time.

1. Open the path: Extras/ Adjustment menu/ NDIR CO₂/CH₄ adjustment.

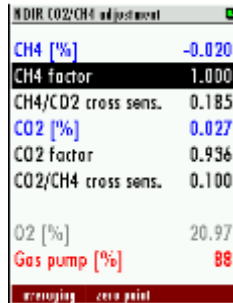

NDIR CO ₂ /CH ₄ adjustment	
CH ₄ [%]	-0.020
CH ₄ factor	1.000
CH ₄ /CO ₂ cross sens.	0.185
CO ₂ [%]	0.027
CO ₂ factor	0.936
CO ₂ /CH ₄ cross sens.	0.100
O ₂ [%]	20.97
Gas pump [%]	88
averaging zero point	

2. Open "averaging" with the **F1**-key.



3. Configuration of averaging time: In this menu is able to set the averaging time with the *left/right arrow keys* and the **F1** or **F3** keys.

The fast averaging time : 20 s
 The smooth averaging time : 240 s

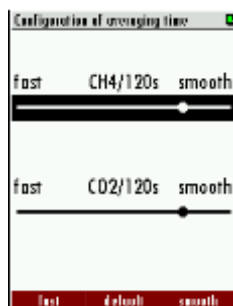

Configuration of averaging time		
fast	CH ₄ /120s	smooth
fast	CO ₂ /120s	smooth
fast	default	smooth

NOTE



Effect of the average time

A smooth averaging time smooths the measurement signal but increase the response time of the measurement signal.

Default configuration

Use the menu MEASUREMENT -> EXTRAS -> DEFAULT SETTINGS for the default configuration:

DEFAULT CONFIGURATION				
Parameter	Analog output 4-20mA		Alarm output relay contact open	
	4mA	20mA		
CH4 [%]	0	100	less than	50
O2 [%]	0	25	more than	1
H2S [ppm]	0	1000	more than	300
CO2 [%]	0	100	more than	50
H2 [ppm]	0	500	more than	500
	0	500	more than	500
CH4 ambient [%]	0	5	more than	1
CH4 ambient [%LEL]	0	100	more than	20
Temperature sensor [°C]	0	50	more than	50
Fan rotation [rpm]	0	2000	less than	1200
Pump rotation [rpm]	0	5000	less than	1500
Sample flow [l/hr]	0	60	less than	30
Temperature cooler [°C]	0	20	more than	10
Net calorific value [MJ/kg]	0	40	less than	30
Gross calorific value [MJ/kg]	0	40	less than	30
Net calorific value [MJ/m3]	0	40	less than	30
Gross calorific value [MJ/m3]	0	40	less than	30

Contents SD card

Path: EXTRAS/CONTENT SD CARD

Structure:

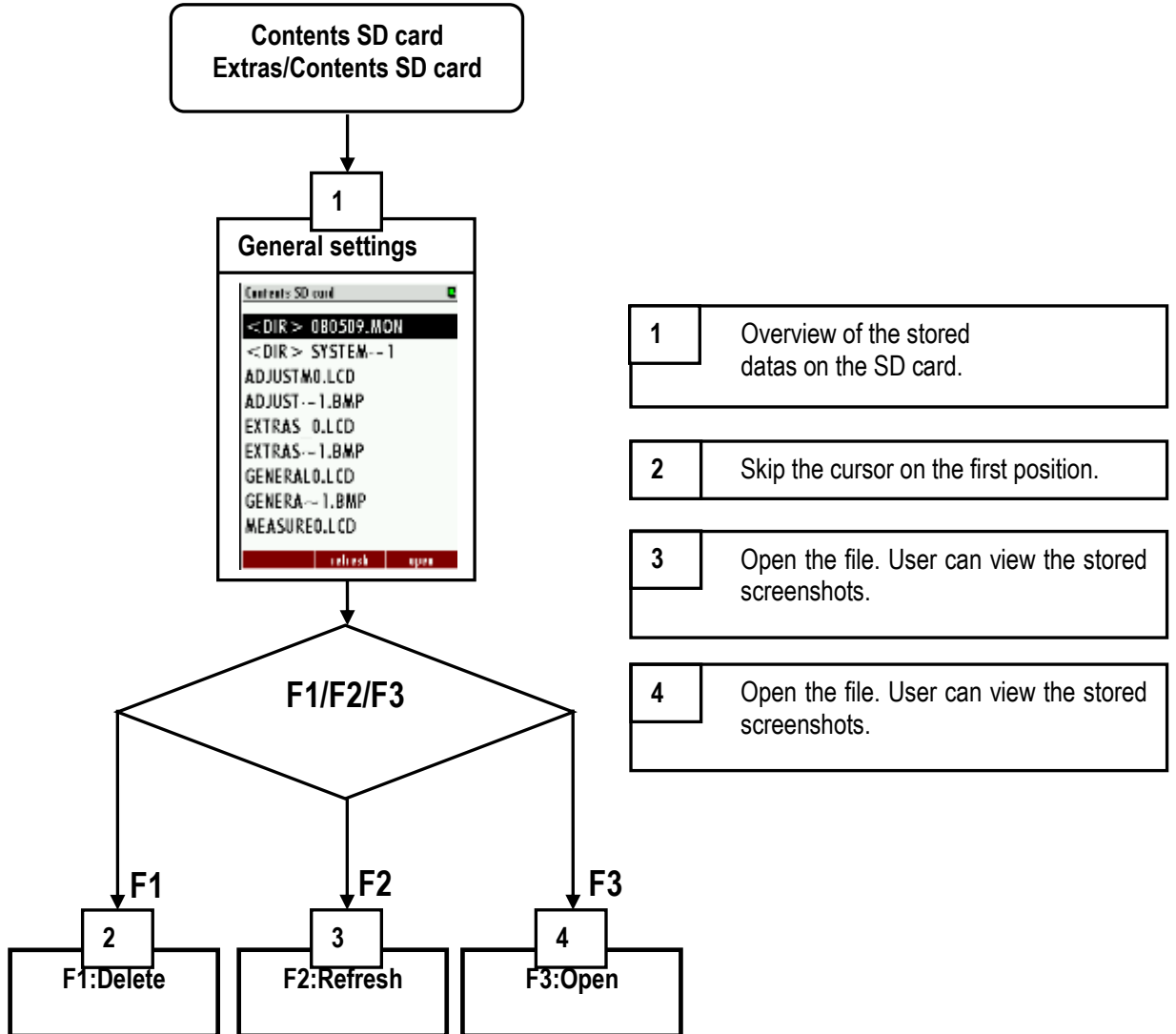

Device info

Path: EXTRAS/DEVICE INFO

Structure:

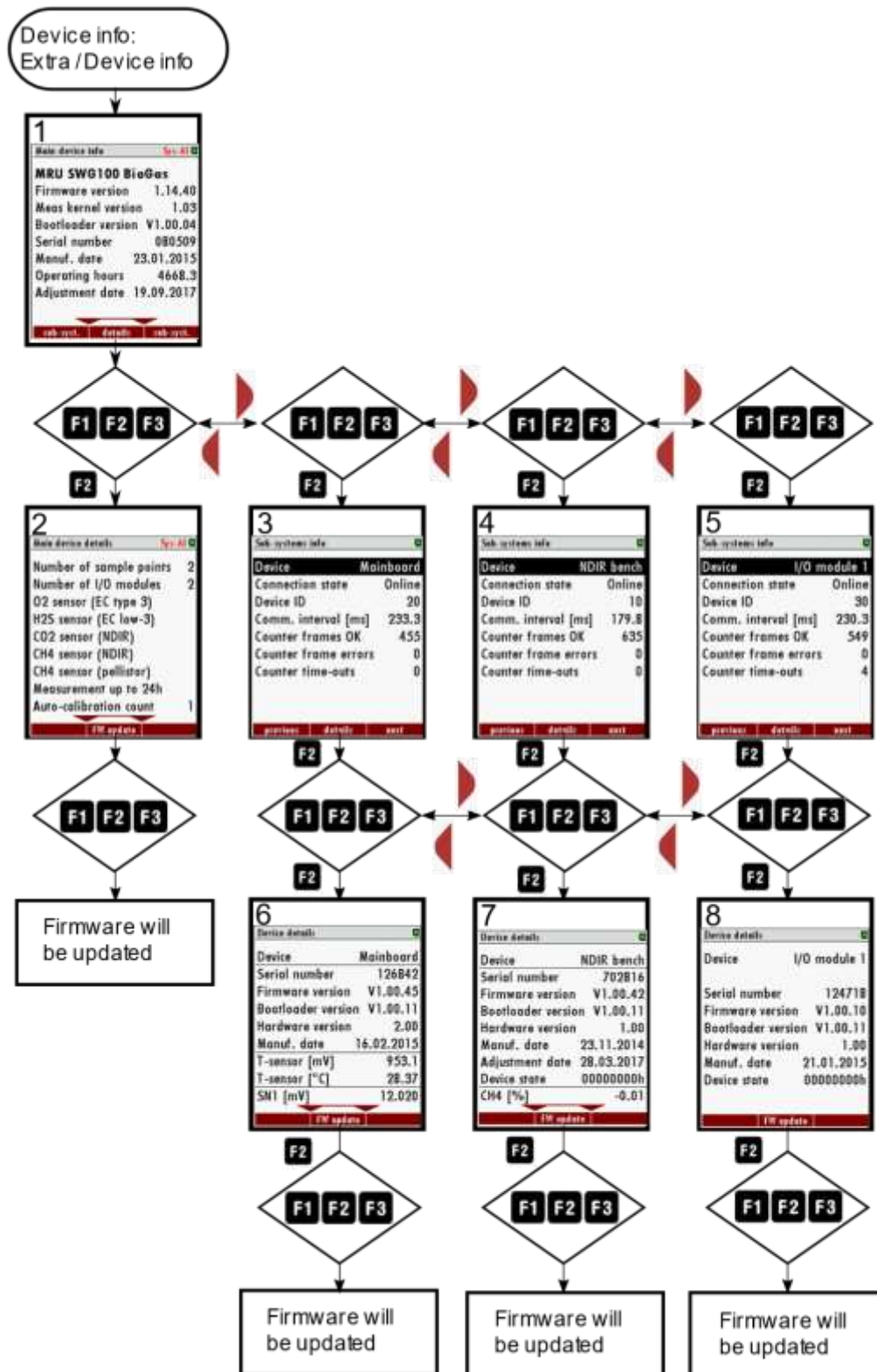

Power-Down of analyzer

Before the analyzer is disconnected from mains, it should be prepared for the Power-Down, because

- operational data should be stored
- eventually changed user settings should be stored
- the sensors should be purged with fresh air

Press the **OFF** key in any menu in order to prepare the analyzer for the Power-Down. The analyzer will store operational data and user settings and will offer to start a sensor purge cycle:

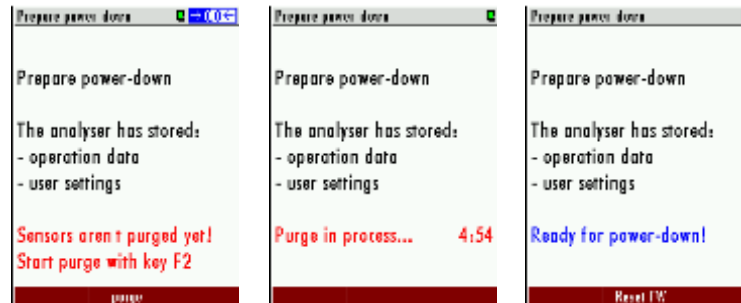

Start the purge cycle with the **F2** key (PIN code requested). The analyzer will purge the sensors with fresh air and will indicate a count-down. Then the analyzer will be ready for power-down.

Now it's not possible to continue directly the ordinary measurement process. Only power-down by disconnecting mains or a software restart by pressing **F2**= 'Reset FW' is offered.

Note:

You also may enter this menu by pressing the **OFF** key and leave it by pressing the ESC key (without starting the purge cycle), when you just want to store operational data and user settings.

Backup/restore all individual user-settings

It's a quite amount of work to configure the analyzer, especially when the analyzer has several sample points, several IO-modules and when the analog outputs are used. Therefore, we recommend to back up all your found settings on the SD card.

In order to back up the settings, do the following:

- use the menu **EXTRAS**.
- insert an SD card (without write-protection)
- press the menu key and select the function 'Export user settings'

The analyzer will write the backup file 'settings.usr' to the SD card.

In order to restore the settings, do the following:

- use the menu **EXTRAS**.
- insert an SD card containing the backup file 'settings.usr'
- press the menu key and select the function 'Import user settings'

The analyzer will replace the current settings by the settings from the backup file.

9.4. Update the firmware

The analyzer and different installed options can be updated if it is necessary. Following options can be updated:

- The firmware for the analyzer.
- The firmware for the pcb- mainboard.
- The firmware for the NDIR-bench.
- The firmware for the installed I/O modules.

General steps for the firmware-update

1. Copy the actual firmware for the analyzer or the firmware from the option on a SD-card. Be sure, that the firmware is in the mean root of the SD-card. All firmware **updates have the ending "fwb"**.
2. Put the SD-card on the card slot on the operation unit. The card slot can be found inside the door (see sketch below).

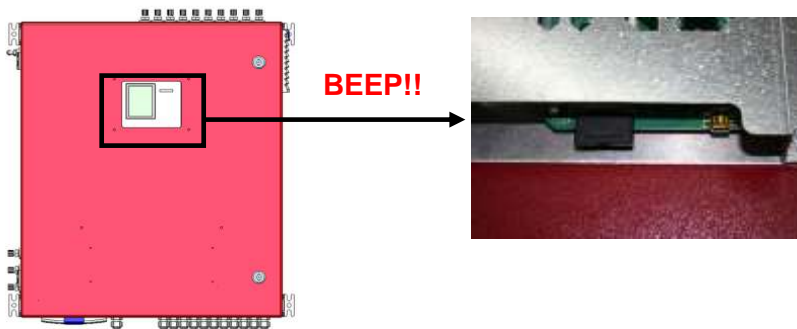

3. If the SD-card is recognized, the analyzer will make a noise.
4. Open the path: `EXTRA/DEVICE INFO`. Dependent from the firmware update it can be necessary to open the different submenus.

Update the analyzer (Firmware-Updates with filename "1106.fwb")

1. Open the path: EXTRA/DEVICE INFO

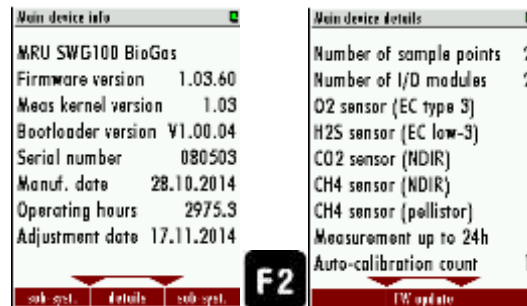

2. Press **F2 = details** to open the details for the main device menu.
3. Press **F2 = FW update**. The analyzer will start the update from the SD-card.

Update the pcb-mainboard (Firmware-Update with filename "1106mb.fwb")

1. Open the path: EXTRA/DEVICE INFO

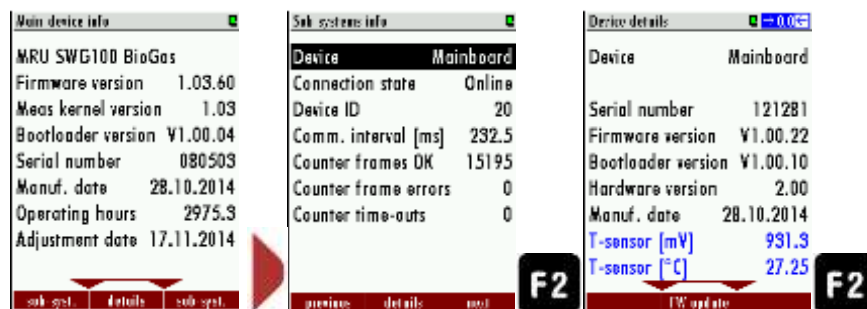

2. Press **F3 = sub.syst.** to open the menu "SUB SYSTEMS INFO".
3. Press **F2 = details**, to open the details from the mainboard. Be sure, that the device is "Mainboard" to update the pcb-mainboard.
4. The Update will start from the SD-card, if a firmware with the filename "1106mb.fwb" is at the SD-card.

Update the NDIR-bench (Firmware-Update with filename "1106ndir.fwb")

1. Open the path: EXTRA/DEVICE INFO

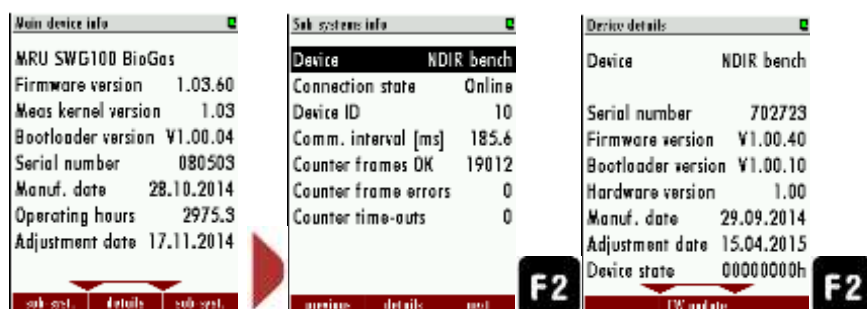

2. Press **F3 = sub.syst.** to open the menu "SUB SYSTEMS INFO".
3. Press **F2 = details**, to open the details from the NDIR bench. Be sure, that the device is "NDIR bench" to update the NDIR-bench.

- The Update will start from the SD-card, if a firmware with the filename "1106ndir.fwb" is at the SD-card.

Update the IO modules (Firmware-Update with filename "1106iom.fwb")

- Open the path: EXTRA/DEVICE INFO

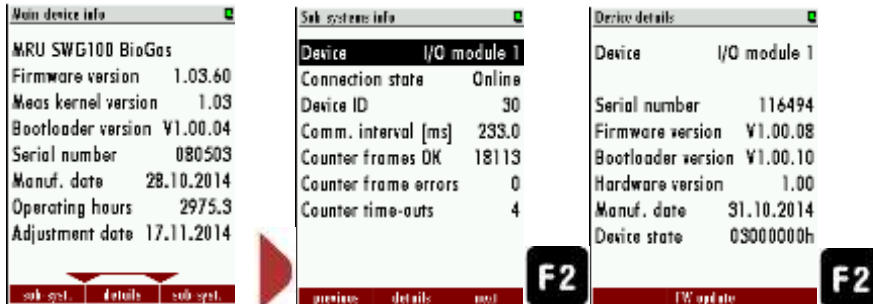

- Press **F3 = sub.syst.** to open the menu "SUB SYSTEMS INFO".
- Press **F2 = details**, to open the details from the I/O module. Be sure, that the device is "Mainboard" to update the I/O module.
- The Update will start from the SD-card, if a firmware with the filename "1106iom.fwb" is at the SD-card.

10. Service and maintenance

For a reliable function and high measurement quality it is necessary to inspect and service the analyser regularly.

Besides the regular routine control by the operator (see chapter 10.1.-) MRU recommends a regular bi-annual maintenance at a minimum, which must carry by a qualified technician.



DANGER

Apply personality safety equipment, against high H₂S concentrations before open the device.



Under special conditions the device can accumulate with toxic gases.

- Measure the atmosphere, around the device, before opening it.
- After the opening of the device, ventilate sufficiently.

10.1. Preparing and information about the maintenance

It is important to power off the mains supply before the maintenance can be started. Even if the main fuse is powered off, dangerous voltage is present.

It can be required to cut off the electric supply and save this from an accidental switch-on.

For maintenance work on the gas analyser, please take care that dangerous and toxic gases may leak. The gas supply must be cut-off.

It is important to comply with all country and local codes.

10.2. Regular maintenance work by the operator

All inspections- and maintenance works are dependent from individual operating conditions, and site. The specified intervals below are only benchmarks.

Review	Recommended intervals	Actions
Moisture in the analyzer.	Weekly	Remove the moisture. Call vendor specialist.
Dirt and depositions in analyzer.	Weekly	Remove the dirt, prevent further penetration of dirt. Inform vendor.
Dirt and moisture in the filter- unit	Weekly	Exchange the filter- unit.
Testing the gas pipes of leakage with a "sniffer"..	Weekly	Tighten or exchange the gas pipe if it is necessary
Inspecting the conditions of the gas filters	Every month	Exchange if is necessary

In the follow chapters there will be introduced some service parts, which are important for the reliable operation. These parts are independent from the regular checks and must be replaced in a minimum interval of minimum 6 months.



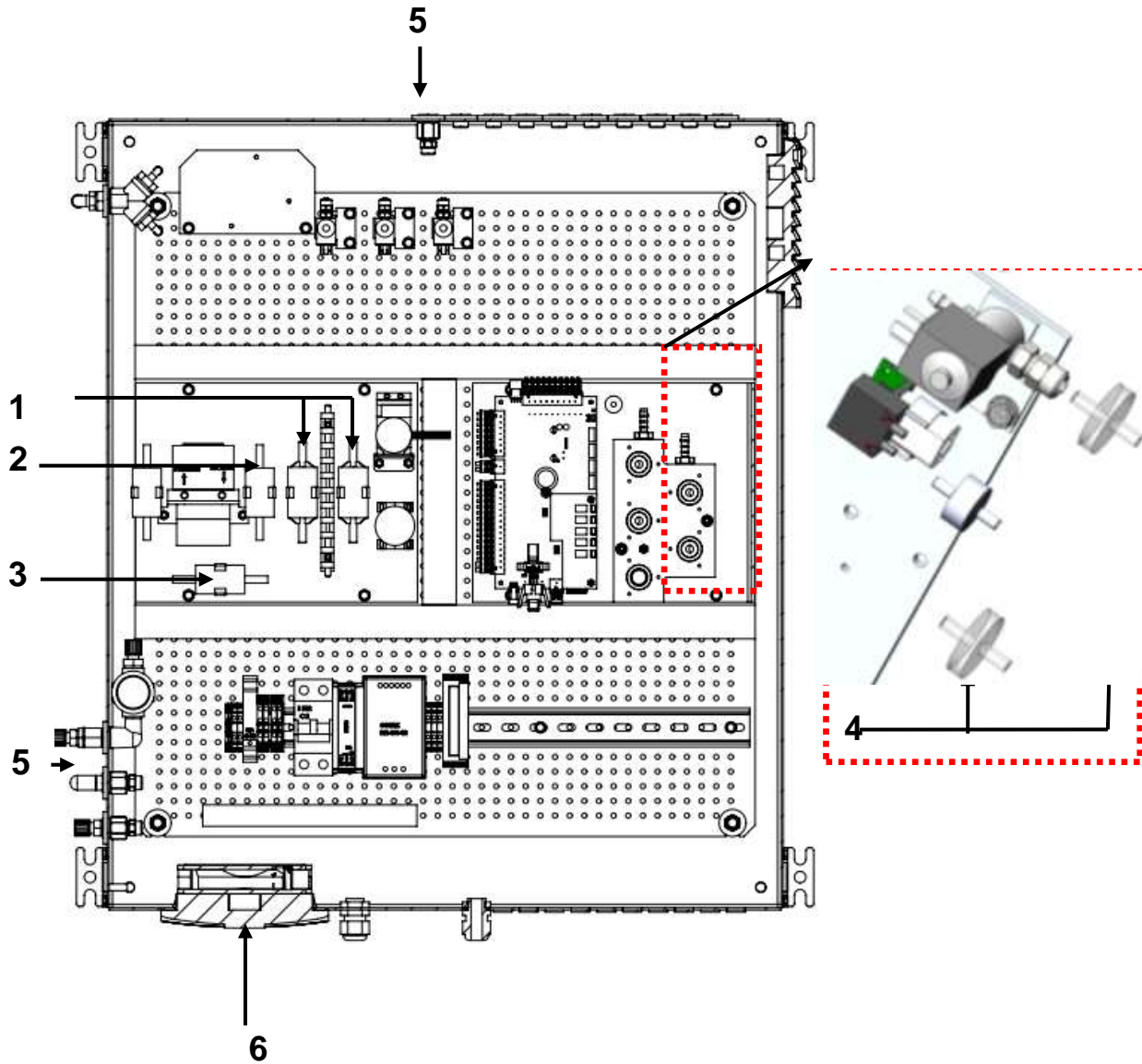



10.3. Position and overview of the service-parts



Description of the different service parts, please see next page.

Content of the service-set (offer-number: 66174)

Single components can be offered under their article number directly.

#	Image	name	Interval	Quantity	Offer-number
1		Acid-gas filter	New state: purple beads Used: white beads Life time: 2-6 month, dependent of gas concentrations. Visual inspection is necessary.	2 pieces	56795
2		Dust- and particle filter	New state: white Used: dark/black Life time: 6 month, dependent of the dust- and dirt concentration. Visual inspection is necessary.	1 piece	65533
3		Dust- and particle filter (fine filter)	New state: white Used: dark/black Life time: 12 month, dependent of the dust- and dirt concentration. Visual inspection is necessary.	1 piece	66088
4		PTFE-filer	New state: white Must be changed, if the PTFE filter is blocked. The analyzer shows the warning "Gas flow is too low" .	2 pieces	51513
5		Sintered filter	New state: sintered surface Must be changed, if the PTFE filter is blocked. The analyzer shows the warning "Gas flow is too low" .	2 pieces	65988
6		Filter mat for the fan- unit	New state: white Used: dark/black, dependent of the dust- and dirt concentration. Visual inspection is necessary.	1 UP (5 pieces)	60320

Position 1: Acid-gas filter (#56795)

Required materials 2x Acid gas filter (#56795), contained in the service- set.

Required tools: Needle-nose pliers.

Exchange interval: Exchange necessary, if filter turns from purple to white.

Mounting direction: Irrelevant

Steps:

1. Remove exhausted acid gas filter from the clips.
2. Pull the Viton tubes from the exhausted acid gas filter. If it is necessary, use needle-nose pliers.
3. Plug the Viton tubes on the new acid gas filters. Be sure, that the tubing is correct. (The single tubes are signed with "+" and "-", see sketch on the right side.)

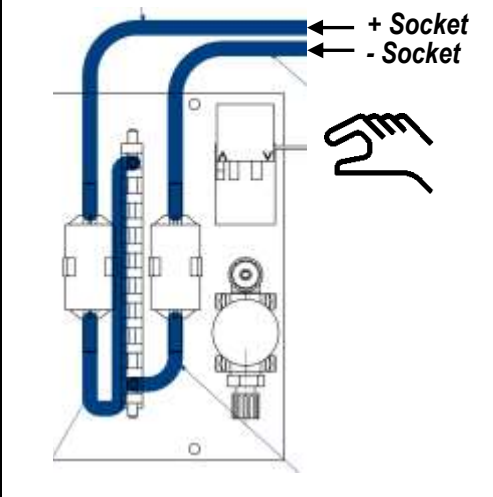

Steps:



Pull the Viton-tubes from the filter unit. If it is necessary, pliers can be used to solve the tubes from the filter unit.

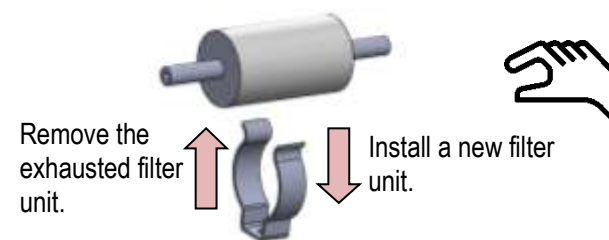

Remove the exhausted filter unit from the clip.

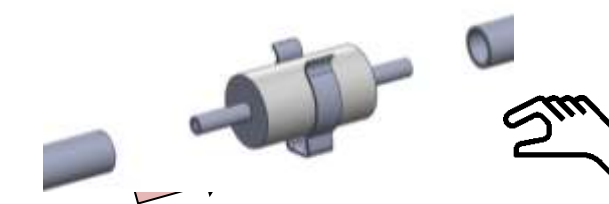

Plug the Viton tubes on the filter unit. Push the filter unit on the clip.

Position 2 and 3: Dust- and particle filter (#65533 and #66088)

Required materials: Dust- and particle filter (#65533 and #66088) contained in the service set.

Required tools: needle-nose pliers.

Exchange interval: Exchange necessary, if the filter gets dark or black.

Mounting direction:

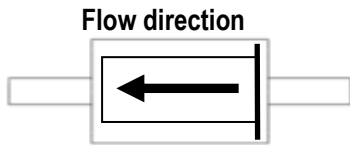

Steps:



Pull the Viton-tubes from the filter unit with the hand. If it is necessary, pliers can be used to solve the tubes from the filter unit.

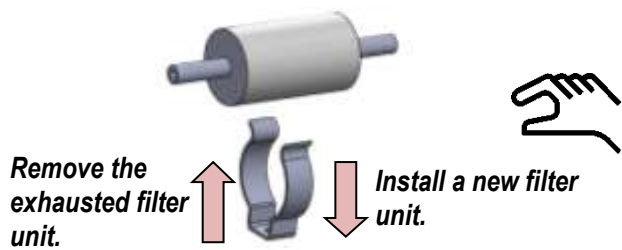

Remove the exhausted filter unit from the clip.



Plug the viton tubes on the filter unit. Push the filter unit on the clip.

Position 4: PTFE Filter (#51513)

Required materials: PTFE filter (#51513) contained in the service set.

Required tools: needle-nose pliers.

Exchange interval: Exchange necessary, if gas flow is too low.

Mounting direction: Irrelevant

Steps:

Pull the exhausted filter-unit from the viton tube and exchange it with a new one. If it necessary, the tube can be solved from the tube with a needle-nose pliers.

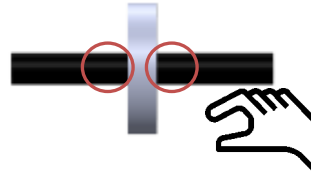
**Position 5: Sintered filters (#65988)**

Required materials: Sintered filters (65988), contained in the service-set.

Required tools: Spanner (range:17)

Exchange interval: Every 2 month, dependent from the dust- and pollution load.

Steps:

1. Remove the gas tube. Be sure, that no process gas emits in the environment. The upper part from the nozzle can be removed with a spanner (range 17).
2. Inside of the nozzle is a sintered filter tablet with an O-ring. Remove the exhausted sintered filter tablet and the O-ring and exchange both parts through a new one. The compensation parts can be found in the service-set.
3. The gas tube can now connect with the nozzle again.

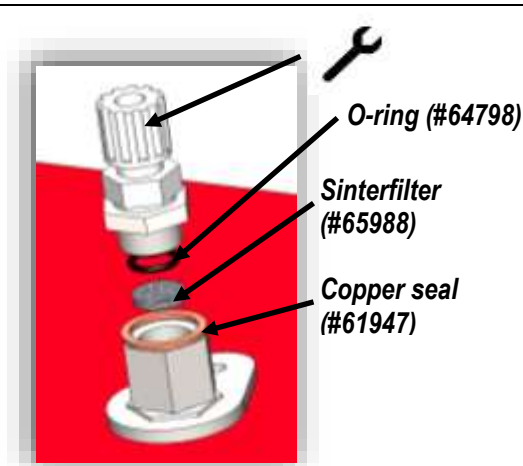



Position 6: Filter mats (#60320)

Required materials: 2x filter mats (#60320) contained in the service-set.

Exchange interval: Exchange necessary, if filter revolution is reduced.

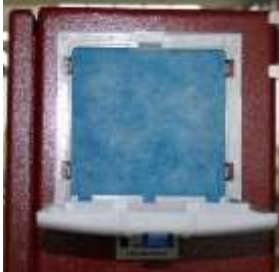
Steps:

Open the filter-unit by pulling the blue lash.	
Replace the exhausted filter mat through a new one.	
Close the cover from the filter unit.	

10.4. Troubleshooting

Error	Possible causes	Solutions
Display does not work.	<ul style="list-style-type: none"> - System is not power-up. 	<ul style="list-style-type: none"> - connect main power supply. - power up automatic fuse. - contact customer support.
Analyzer powers down by itself.	<ul style="list-style-type: none"> - The fan is defective. - Filter mat from the fan is clogged. - The protection switch has been triggered. 	<ul style="list-style-type: none"> - exchange the fan. - exchange the filter mat. - Internal short circuit. <p>Contact an electrician to determine cause of defect.</p>
Gas cooler unit does not work.	<ul style="list-style-type: none"> - The device is not ready, after a new start of the analyzer. - The ambient temperature is too hot. - The gas cooler unit is defective. 	<ul style="list-style-type: none"> - wait until the gas cooler-unit is ready. - be sure, that ambient temperature is within operating range. -Contact customer support.

11. Technical specification

Allgemein		General
Deutsch	Angabe	English
Betriebstemperatur(ohne Frostschutzheizung)	+5°C ... +45 °C / 41 °F ... 113 °F	Operating temperature (w/o heating)
Betriebstemperatur (mit optionaler Frostschutzheizung)	-10 °C ... +45°C / 14 °F ... 113 °F	Operating temperature (with internal heating, option)
Rel. Luftfeuchtigkeit bei Betrieb, nicht-kondensierend	95%	Rel. Humidity, non-condensing
Lagertemperatur	-20°C ... +50°C / -4°F ... 122°F	Storage Temperature
Schutzart	IP52	Protection Class
Aufstellbedingungen	geschützt vor direkter Sonneneinstrahlung und Regen	Installation Requirements
	do not expose to direct sun light or rain	
Akku intern, Pufferzeit für Sensor Bias	NiMH, 3 Monate / 3 months	Internal Battery Pack, buffer time for sensor bias
Stromversorgung	100 - 240 V, 200 W	Power supply
Gewicht, typisch mit Sensoren, Gaskühler	25 kg / 55 lbs	Weight, typically incl sensors and gas cooler unit
Maße	600x700x210 mm	Size
	23.6x 27.6 x8.3 in	
Gehäusematerial	Aluminium/Aluminum	Housing material
max. Unterdruckbereich der Gaspumpe	300 hPa	Max suction range gas pump
typischer Gasdurchfluss	50 l/h	gas flow typ.
Schnittstellen		Interfaces
Deutsch	Angabe	English
Benutzerschnittstelle	Angabe	User Interface
Anzeigetyp	3,5 TFT	Display type
Anzahl gleichzeitig angezeigter Messwerte	6	Number of siultaneously displayed values

Tastatur mit Anzahl Tasten	12	Keyboard with qty of keys
Elektrische Aus-/Eingänge		Electrical I/O
Serielle Schnittstelle	RS485	Serial interface
Protokoll	Modbus RTU	Protocol
Typ Analogausgang	4 ... 20 mA	Type of analog output
Anzahl Ausgangskanäle pro I/O-Modul (optional)	4	Number of output channels per I/ module (optional)
Typ Analogeingang	4 ... 20 mA	Type of analog input
Anzahl Eingangskanäle pro I/O - Modul (optional)	4	Number of input channels per I/ module (optional)
Anzahl Alarmausgänge pro I/O - Modul (über Relais)	2	Number of alarm output signal via relays
maximal mögliche Anzahl I/O - Module	10	Max number of I/O modules to be equipped
Systemalarm-Ausgang	Relaiskontakt	system alarm output
	relay contact	
Gas Ein- und Ausgänge		Gas input and output
Anzahl <u>parallel</u> zu überwachender Messstellen	1	Number of <u>simultaneously</u> monitored sampling points
Anzahl Messgaseingänge (serielle Umschaltung)	10	Number of sampling points (serial sampling point switching)
Gehäuseverschraubung Messgaseingang	G1/8	Screw joint sampling point
Gasausgang	G1/8	gas output
Frischluf (für Nullpunktnahme)	G1/8	Fresh air (for zeroing)
Kalibriergas	optional, G1/8	Calibration gas

11.1. Technical specification: Electrochemical sensors

Deutsch	Angaben zur Messgenauigkeit	English
Elektrochemischer Sensor	O2 Long Life	Electrochemical Sensor
Messbereich	0 .. 21 %	Measuring Range
Auflösung	0,01 %	Resolution
Genauigkeit abs.	± 0,2 Vol%	Abs. Accuracy
Ansprechzeit T90	< 20s	Response Time T90
Jahre erwartete Lebensdauer an Luft	2	Years expected lifetime (@air)
Elektrochemischer Sensor	H2S low200	Electrochemical Sensor
Messbereich	0-200 ppm	Measuring Range
Auflösung	1 ppm	Resolution
Überlastbereich	< 1000 ppm	Overload Range
Genauigkeit abs.	±5 ppm / 5% (0 ... 200 ppm) 10% (> 200 ppm)	Abs. Accuracy
Ansprechzeit T90	< 40s	Response Time T90
Jahre erwartete Lebensdauer an Luft	2	Years expected lifetime (@air)
Elektrochemischer Sensor	H2S high10.000	Electrochemical Sensor
Messbereich	0-10000 ppm	Measuring Range
Auflösung	1 ppm	Resolution
Überlastbereich	< 50000 ppm	Overload Range
Genauigkeit abs.	± 50 ppm / 5% (0 ... 10000 ppm) 10% (> 10000 ppm)	Abs. Accuracy
Ansprechzeit T90	< 90s	Response Time T90
Jahre erwartete Lebensdauer an Luft	2	Years expected lifetime (@air) (Depending on chosen sensor)
(abhängig von gewähltem Sensor)		
Elektrochemischer Sensor	H2S low2000	Electrochemical Sensor
Messbereich	0-2000 ppm	Measuring Range
Auflösung	1 ppm	Resolution
Überlastbereich	< 5000 ppm	Overload Range
Genauigkeit abs.	< 5% (0...500 ppm) <15% (501...2500 ppm)	Abs. Accuracy
Ansprechzeit T90	< 35s	Response Time T90
Jahre erwartete Lebensdauer an Luft		Years expected lifetime (@air) (Depending on chosen sensor)

(abhängig von gewähltem Sensor)		
Elektrochemischer Sensor	CO/4000	Electrochemical Sensor
Messbereich	0-4000 ppm	Measuring Range
Auflösung	1 ppm	Resolution
Überlastbereich	< 10000 ppm	Overload Range
Genauigkeit abs.		Abs. Accuracy
Ansprechzeit T90	< 40s	Response Time T90
Jahre erwartete Lebensdauer an Luft		Years expected lifetime (@air) (Depending on chosen sensor)
	3	
Elektrochemischer Sensor	H2/1000	Electrochemical Sensor
Nominaler Messbereich	0-1000 ppm	Nom. Measuring Range
Überlastbereich	< 2000 ppm	Overload Range
Auflösung	1 ppm	Resolution
Genauigkeit absolut / vom Messwert	5% (0 ... 1000 ppm) 10% (> 1000 ppm)	Accuracy abs. / reading
Ansprechzeit T90	< 50s	Response Time T90

11.2. Technical specification: NDIR-benches

Nicht-dispersive Infrarotmessung (NDIR)	CO₂/CH₄/100 %	Non-dispersive Infrared Measurement (NDIR)
Nominaler Messbereich	0-100 Vol%	Nom. Measuring Range
Auflösung	0,01 Vol%	Resolution
Genauigkeit abs. /vom Messwert	± 0,3 Vol% /	Accuracy abs./reading
	3%	
Ansprechzeit T90	< 35 s	Response Time T90

12. APPENDIX

12.1. Modbus via RS485 specification

General information

- The Modbus (slave function) requires the firmware version V1.01.70 dated 17.11.2014 or later.
- The analysers are able to work as Modbus slave using the RS232 or RS485 port (possibly with external RS232/RS485 adapter)
- supports RS485 interface with 2/4 wires (half/full duplex)
- supports only the binary Modbus protocol (RTU)
- supports Modbus command *Read Holding Register* (command no 3)
- supports Modbus command *Read Input Register* (command no 4)
- the slave Modbus address is user definable from 1 to 238
- communication parameter are user definable as follows:
 - 9600 baud
 - 19200 baud
 - even parity and 1 stop bit
 - no parity and 2 stop bits
- Multi byte values are transmitted in Motorola® byte order (Big-Endian). Only the CRC16 at the end of each frame is transmitted in Intel® byte order (Little-Endian).
In case you need Little-Endian byte order in the master's system:
 - 16bit values (occurs only in the frame): swap bytes 0<=>1
 - 32bit values (occurs only in the data): swap bytes 0<=>3 and swap bytes 1<=>2
- All addresses written in this document are decimal (not hexa-decimal)
- All readable data are 32bit values, therefore the analyser only accepts even addresses and even number of registers to be read.
- The maximal number of 32bit-values to be read with one single read command is 63
(126 modbus registers)
- Data types (used in table below):
 - U32 32 bit unsigned integer value (0..4.294.967.295)
 - FL 32 bit floating point value (reads -1E38, when not available)

- Defined registers to be read by the master.

modbus address	profibus address	data type	register content
Status & Device info			
0	0	U32	Analyser Status (more details read below)
2	4	U32	System Alarm (more details read below)
4	8	U32	Serial number
6	12	U32	Analyser type (11060 = SWG100biogas)
8	16	U32	Firmware version (e.g. 12345 = V1.23.45)
10	20	U32	Elapsed seconds since Power-On
12	24	U32	Counter Modbus Frame Error
14	28	FL	CH4 amb. [%]
16	32	FL	CH4 amb. [% LEL]
18	36	FL	T-sensor [°C/°F] (unit depends on user settings)
20	40	FL	Sample Flow [l/h]
22	44	FL	T-gascooler [°C/°F] (unit depends on user settings)
24	48	FL	Case fan rotations [rpm]
26	52	FL	Gas pump rotations [rpm]
28	56	FL	P-absolute [hPa] (= [mbar])
30	60	FL	P-absolute [inchHG]
32		U32	not (yet) defined (reads zero)
34		U32	not (yet) defined (reads zero)
36		U32	not (yet) defined (reads zero)
38		U32	not (yet) defined (reads zero)
Status & current measurement values (live values!)			
40		U32	Analyser Status (more details read below)
42		U32	System Alarm (more details read below)
44		FL	O2 [%]
46		FL	CO2 [%] (or CO2 [ppm], if CO2 [%] isn't available)
48		FL	CH4 [%] (or CH4 [ppm], if CH4 [%] isn't available)
50		FL	H2S [ppm] (optional)
52		FL	H2 [ppm] (optional)
54		FL	Net calorific value [MJ/kg]
56		FL	Gross calorific value [MJ/kg]
modbus address	profibus address	data type	register content
58		FL	Net calorific value [MJ/m ³]
60		FL	Gross calorific value [MJ/m ³]
62		FL	CO [ppm] (optional)
64		FL	CH4 [ppm] (optional, when CH4 [%] also available)
66		FL	CO2 [ppm] (optional, when CO2 [%] also available)
68		U32	not (yet) defined (reads zero)
Status & measurement values of sample point 1			
70		U32	Analyser Status (more details read below)
72		U32	System Alarm (more details read below)
74	64	FL	O2 [%]
76	68	FL	CO2 [%] (or CO2 [ppm], if CO2 [%] isn't available)
78	72	FL	CH4 [%] (or CH4 [ppm], if CH4 [%] isn't available)
80	76	FL	H2S [ppm] (optional)

82	80	FL	H2 [ppm] (optional)
84	84	FL	Net calorific value [MJ/kg]
86	88	FL	Gross calorific value [MJ/kg]
88	92	FL	Net calorific value [MJ/m ³]
90	96	FL	Gross calorific value [MJ/m ³]
92	100	FL	CO [ppm] (optional)
94	104	FL	CH4 [ppm] (optional, when CH4 [%] also available)
96		FL	CO2 [ppm] (optional, when CO2 [%] also available)
98		U32	not (yet) defined (reads zero)
Status & measurement values of sample point 2 (optional)			
100		U32	Analyser Status (more details read below)
102		U32	System Alarm (more details read below)
104	108	FL	O2 [%]
106	112	FL	CO2 [%] (or CO2 [ppm], if CO2 [%] isn't available)
108	116	FL	CH4 [%] (or CH4 [ppm], if CH4 [%] isn't available)
110	120	FL	H2S [ppm] (optional)
112	124	FL	H2 [ppm] (optional)
114	128	FL	Net calorific value [MJ/kg]
116	132	FL	Gross calorific value [MJ/kg]
118	136	FL	Net calorific value [MJ/m ³]
120	140	FL	Gross calorific value [MJ/m ³]
122	144	FL	CO [ppm] (optional)
124	148	FL	CH4 [ppm] (optional, when CH4 [%] also available)
126		FL	CO2 [ppm] (optional, when CO2 [%] also available)
128		U32	not (yet) defined (reads zero)
Status & measurement values of sample point 3-10 (optional)			
130-369	152...	...	add 30/44 to the addresses for each sample point

Optional AUX values are not available via Profibus.

protocol address	data type	numb. of registers	register content
AUX-values (read by up to 10 IO-modules)			
370	FL	2	AUX-value read by IO-module 1 - Input 1
372	FL	2	AUX-value read by IO-module 1 - Input 2
374	FL	2	AUX-value read by IO-module 1 - Input 3
376	FL	2	AUX-value read by IO-module 1 - Input 4
378	FL	2	AUX-value read by IO-module 2 - Input 1
380	FL	2	AUX-value read by IO-module 2 - Input 2
382	FL	2	AUX-value read by IO-module 2 - Input 3
384	FL	2	AUX-value read by IO-module 2 - Input 4
386	FL	2	AUX-value read by IO-module 3 - Input 1
388	FL	2	AUX-value read by IO-module 3 - Input 2
390	FL	2	AUX-value read by IO-module 3 - Input 3
392	FL	2	AUX-value read by IO-module 3 - Input 4
394	FL	2	AUX-value read by IO-module 4 - Input 1
396	FL	2	AUX-value read by IO-module 4 - Input 2
398	FL	2	AUX-value read by IO-module 4 - Input 3
400	FL	2	AUX-value read by IO-module 4 - Input 4
402	FL	2	AUX-value read by IO-module 5 - Input 1
404	FL	2	AUX-value read by IO-module 5 - Input 2
406	FL	2	AUX-value read by IO-module 5 - Input 3
408	FL	2	AUX-value read by IO-module 5 - Input 4
410	FL	2	AUX-value read by IO-module 6 - Input 1
412	FL	2	AUX-value read by IO-module 6 - Input 2
414	FL	2	AUX-value read by IO-module 6 - Input 3
416	FL	2	AUX-value read by IO-module 6 - Input 4
418	FL	2	AUX-value read by IO-module 7 - Input 1
420	FL	2	AUX-value read by IO-module 7 - Input 2
422	FL	2	AUX-value read by IO-module 7 - Input 3
424	FL	2	AUX-value read by IO-module 7 - Input 4
426-241	FL	16	8 AUX-values read by IO-modules 8 & 9
442	FL	2	AUX-value read by IO-module 10 - Input 1
444	FL	2	AUX-value read by IO-module 10 - Input 2
446	FL	2	AUX-value read by IO-module 10 - Input 3
448	FL	2	AUX-value read by IO-module 10 - Input 4

12.2. Analyser Status (address 0 and some mirror addresses)

The Analyser Status is a 32bit-word and must be interpreted bitwise.

Bit	Description
0	Power-On (until the first zeroing has been done)
1	System-Alarm, see table below
2	Air Purging (zeroing)
3	Gas Sampling (preparing measurement, not measurement!)
4-7	Currently sampled sample point number (1...10, reads 0 while air purging)
8-31	reserved for later applications (read zero)

Some status examples:

Decimal	Hexadecimal	Binary	state description
1	0001h	0000 0001	Power-On (self-test)
5	0005h	0000 0101	First Air Purging (Power-On + Air Purging)
24	0018h	0001 1000	Preparing meas. smp.pt.1 (Gas Sampling + smp.pt.1)
16	0010h	0001 0000	Measuring sample point 1
32	0020h	0010 0000	Measuring sample point 2
48	0030h	0011 0000	Measuring sample point 3
18	0012h	0001 0010	Measuring sample point 1 + System-Alarm

12.3. Analyser System Alarm (address 2 and some mirror addresses)







The Analyser System Alarm is a 32bit-word and must be interpreted bitwise.





Bit	Description	Meas. halted
0	Mainboard Offline (some communication problems)	YES
1	Mainboard is in bootloader mode	YES
2	CH4 ambient > threshold value	YES
3	Condensate	YES
4	Sample flow < 20 l/h	-
5	Case fan rotations < 900 rpm	-
6	T-gas cooler > 10°C	-
7	T-gas cooler < 2°C	-
8	T-Sensor > 55°C	-
9	T-Sensor < 5°C	-
10-31	reserved for later applications	

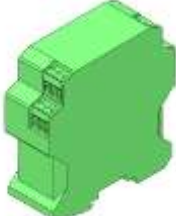

Some system alarm examples:

Decimal	Hexadecimal	Binary	state description
1	0001h	0000 0001	Mainboard is offline, measurement is halted
8	0008h	0000 1000	Condensate Alarm, measurement is halted
80	0050h	0101 0000	Sample flow < 20 l/h and T-gas cooler > 10°C.

12.4. Spare parts list

<i>Article</i>	<i>Description – Serial number</i>
	<p><i>Gas cooler - #60467HT</i></p> <p><i>Required to dry the sample gas</i></p>
	<p><i>Condensate pump - #11230</i></p> <p><i>Required to drain the condensate</i></p>
	<p><i>Sample gas pump - #65032</i></p> <p><i>Used for sample gas pumping</i></p>
	<p><i>H2S solenoid valve - #65470</i></p> <p><i>Required for cut-off sample gas supply to H2Slow sensor.</i></p>
	<p><i>H2S purge pump - #54150</i></p> <p><i>Required for air purging of H2Slow sensor.</i></p>
	<p><i>NDIR CH₄/CO₂ - #65128</i></p> <p><i>Infrared measuring device of CH₄ and CO₂</i></p>
	<p><i>Power supply - #64845</i></p> <p><i>Input: 100-240 VAC / 47-63 Hz</i></p> <p><i>Output: 12 VDC / 90 W</i></p>
	<p><i>Power supply - #65325</i></p> <p><i>Only for use in hazardous area Zone 2</i></p>

	<p><i>Axial fan - #65097</i></p> <p><i>For ventilation of analyzer cabinet</i></p>
	<p><i>Solenoid valve - #65470</i></p> <p><i>Used for sampling point switching.</i></p>
	<p><i>CxHy gas detector - #65469</i></p> <p><i>Required for monitoring the CH₄ concentration inside analyzer cabinet</i></p>
	<p><i>Heater - #65425</i></p> <p><i>Used for freeze protection of analyzer cabinet</i></p> <p><i>Only for use in hazardous area Zone 2</i></p>
	<p><i>Display and operation unit #65133</i></p> <p><i>Control unit for the user.</i></p>

	<p><i>I/O-Module #65179 + #65430</i></p> <p><i>Used for analog output data transfer and sample point switching.</i></p>
	<p><i>I/O Module - #65179</i></p> <p><i>Used for analog output data transfer</i></p>
	<p><i>Heater #65734</i></p> <p><i>Used for freeze protection of analyzer cabinet installed in safe area</i></p>

13. Purchase options of the analyzer

In this chapter the different available options are explained. The chapter shows:

- The place of the options in the analyzer.
- The characteristic of the options.
- How to install the option if it is necessary.

13.1. Option: Electric sample gas cooler

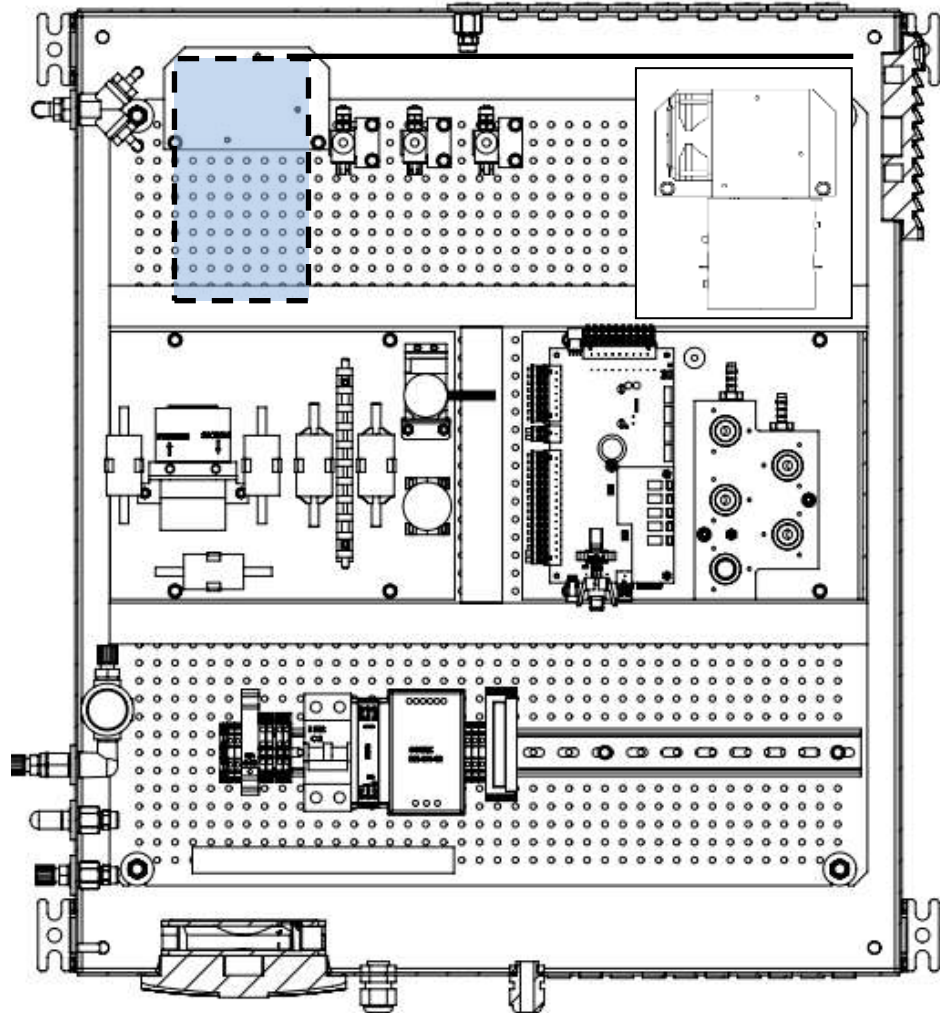

The gas cooler-unit is equipped with a peltier-element. It is for drying the gas feed of a dew point of 5°C. It is recommended to use this option, if the gas feed from the biogas has a high moisture content.

This option must be purchased separate, because it is not contain in the basic version.

13.2. Option: Cabinet heater

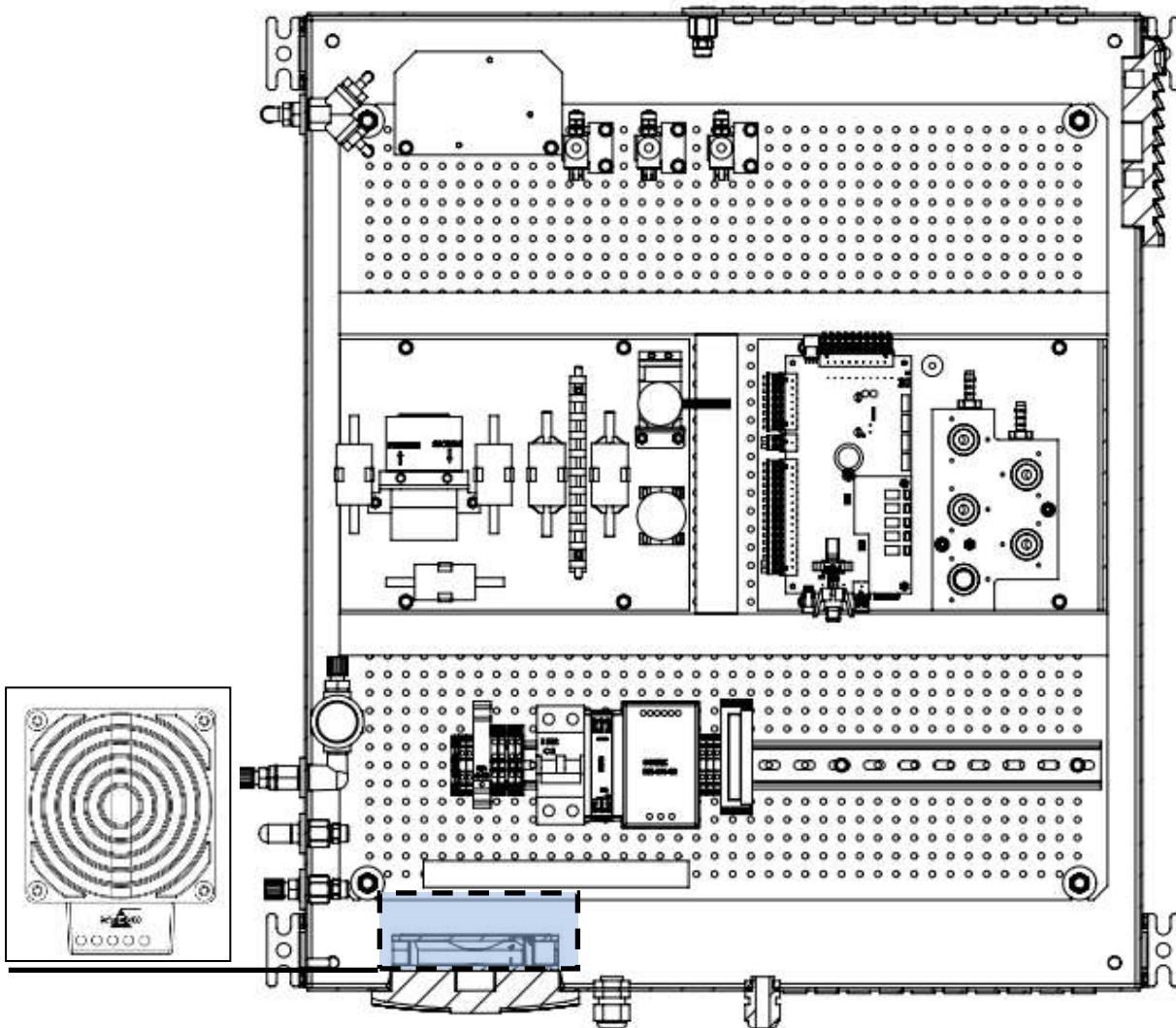

The feature cabinet heater is necessary to operate the analyzer at low ambient air temperatures (-10°C ... $+5^{\circ}\text{C}$). The device starts heating, when the ambient temperature is fallen $<18^{\circ}\text{C}$. The electrical power from the cabinet heater is 200 Watt.

This option exists in a 230 VAC and an 115VAC variant.

13.3. Option: Flame arrester

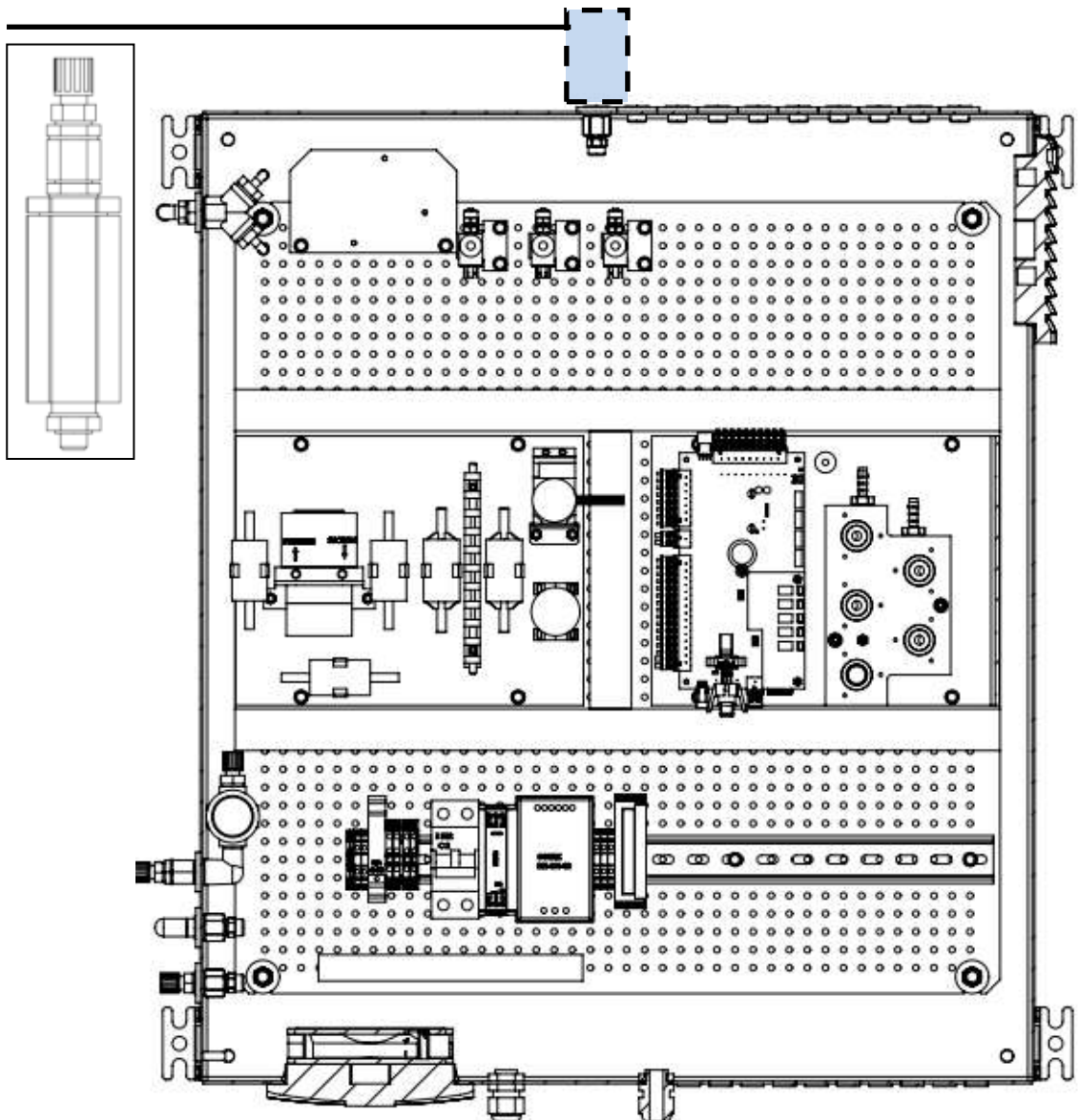

It can be necessary to install separate flame arresters at the sample gas inlets. The flame arrester, which can be purchased by MRU, has permission for ATEX areas zone 2 (DIN EN ISO 16852).

13.4. Option: Multiple sample point switching and monitoring (time sharing)

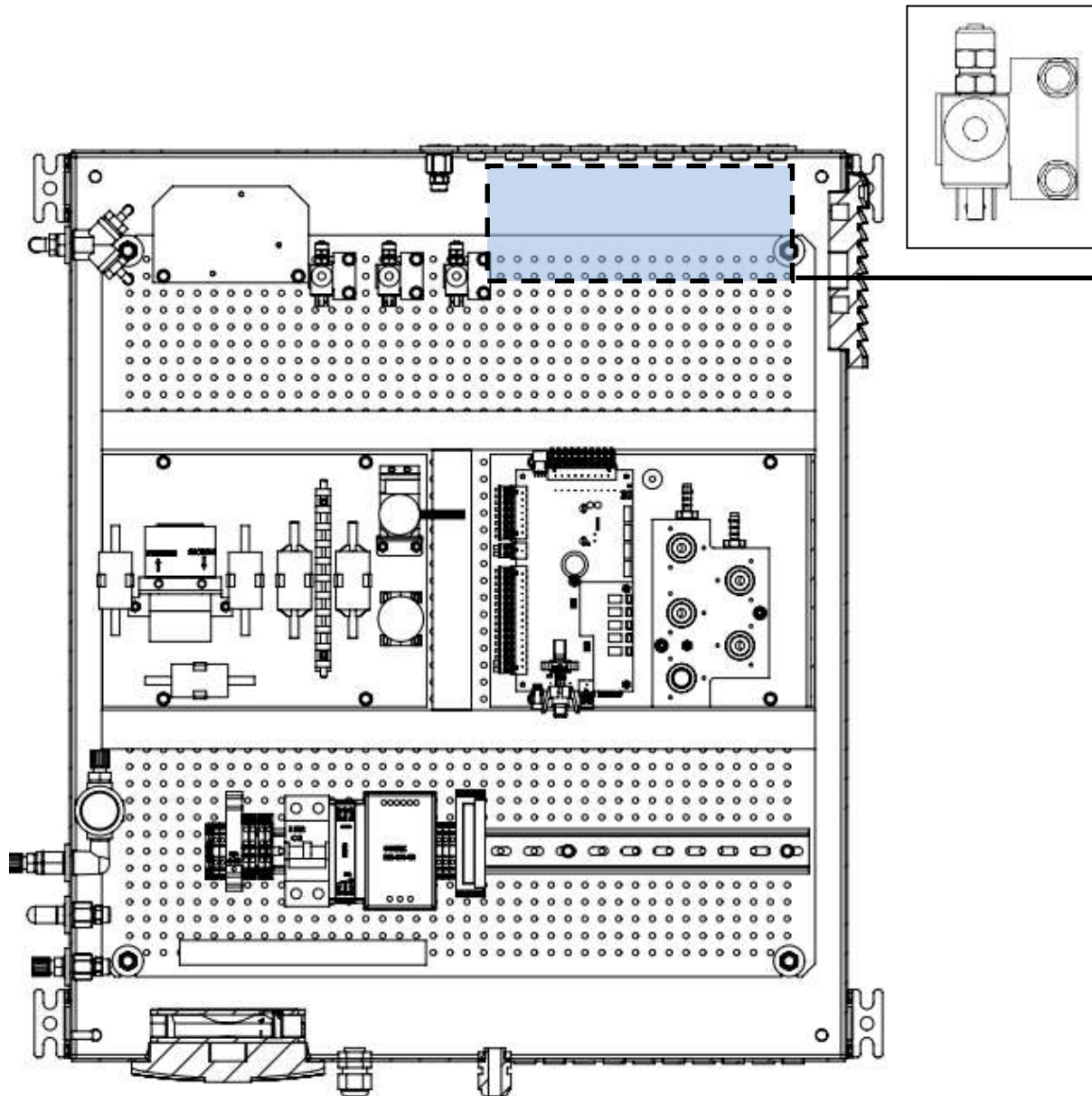

The analyser is by default equipped with one sample point (see market above). It can be offered with several sample points (max. 10). The sample points are not measured simultaneously but one at a time (round robin technique). The sample points can be set in the menu "Cycle configuration" (see chapter 6.10).

13.5. Option: Gas detector (%LEL CH₄) to monitor air inside analyzer cabinet

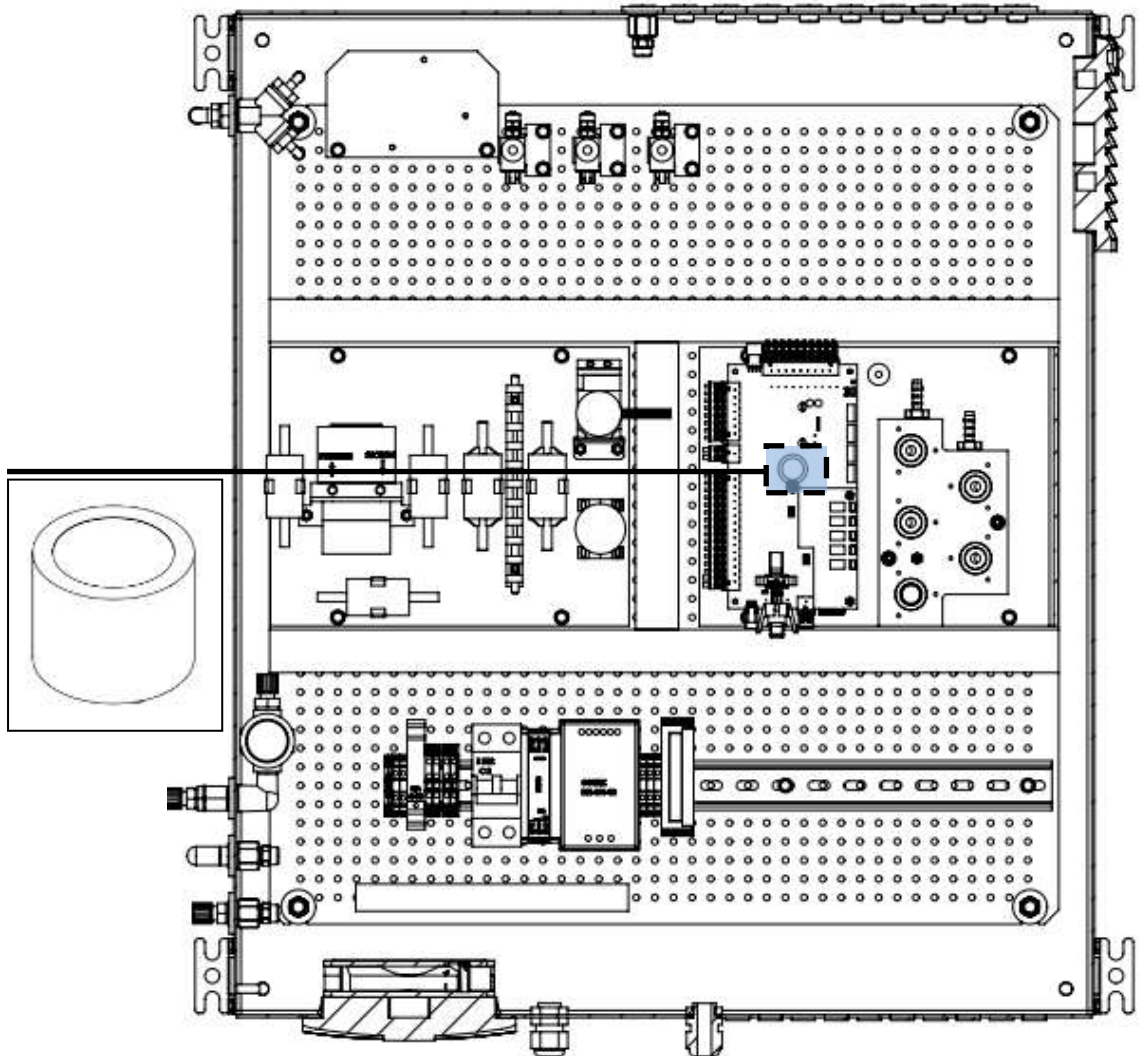

With this option the CH₄ concentration inside the analyser can be determined and monitored. This menu is only installed, if the gas detector is installed.

13.6. Option: Extra IO module with 4 channel 4-20 mA

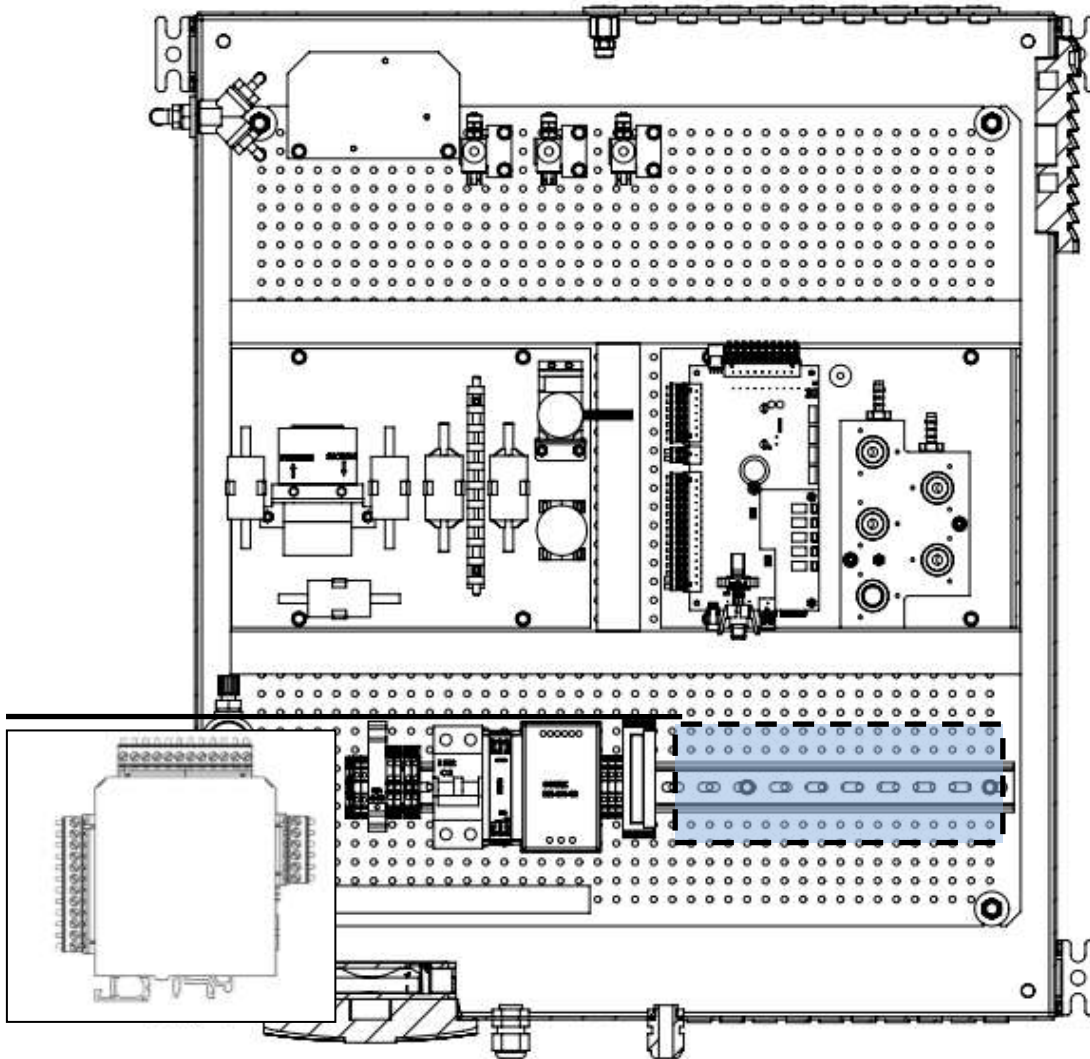

The analyser is by default equipped with one IO module (see market above). It can be offered with a different number of IO modules (max.10). Every single installed IO module can be driven independent from each other. The different IO modules can be set in the menu "" (see chapter 5.4).

13.7. Option: H₂S electrochemical cell measurement 0-2000ppm/4000ppm

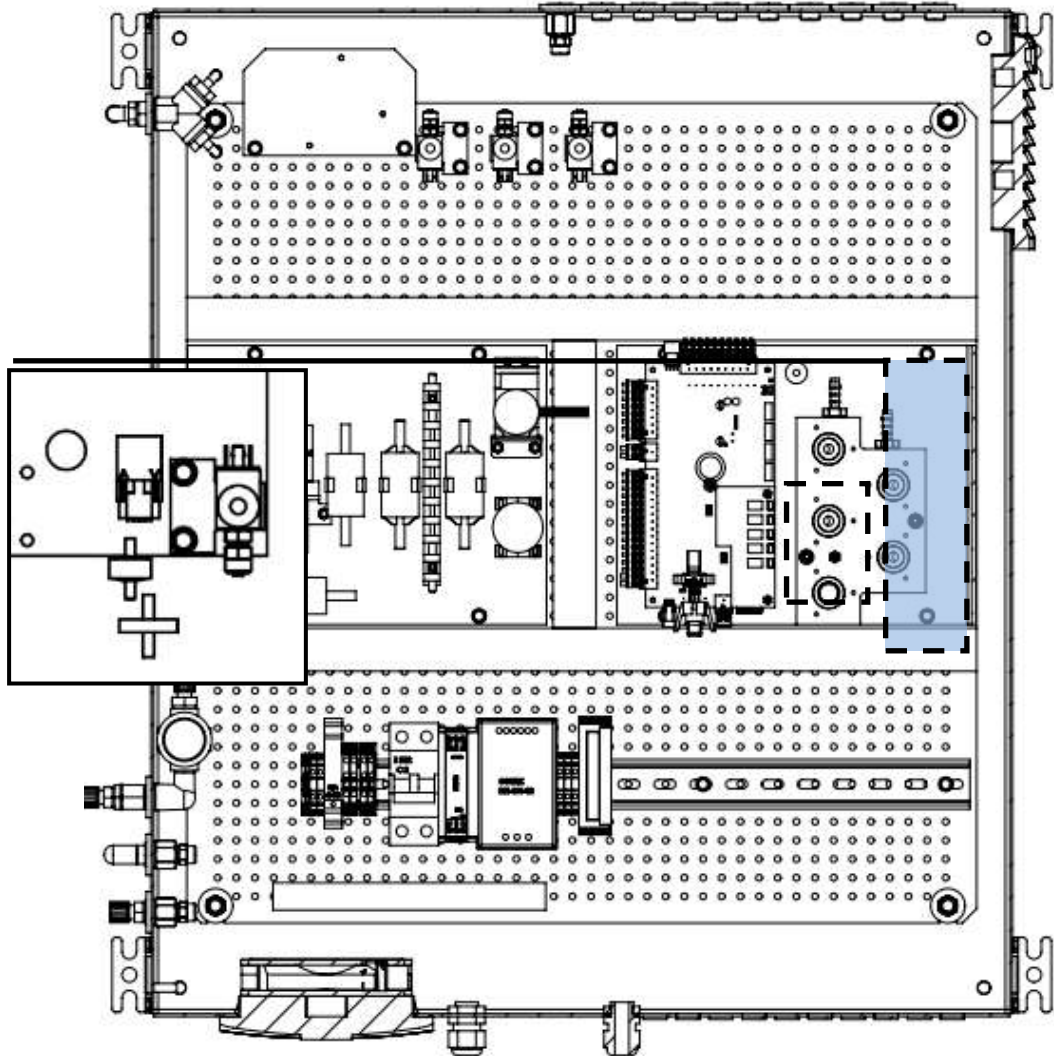

The H₂S electrochemical sensor is offered with two different functions:

- Without cut-off solenoid valve and air purge pump.
- With cut-off solenoid valve and air rising pump.

The cut-off solenoid valve with air rising pump have the advantage, that the electrochemical sensor can be purge with ambient air, after the sensor has determined the sample gas. This enhance the live time of the sensor.

13.8. Option: Extern condensate-trap

The external condensate trap is a pre-filter unit, which is for wet and dirty sampling points with condensate higher than 14ml/min.

Mounting of the external condensate trap

The schematic above shows the tubing of the external condensate trap:

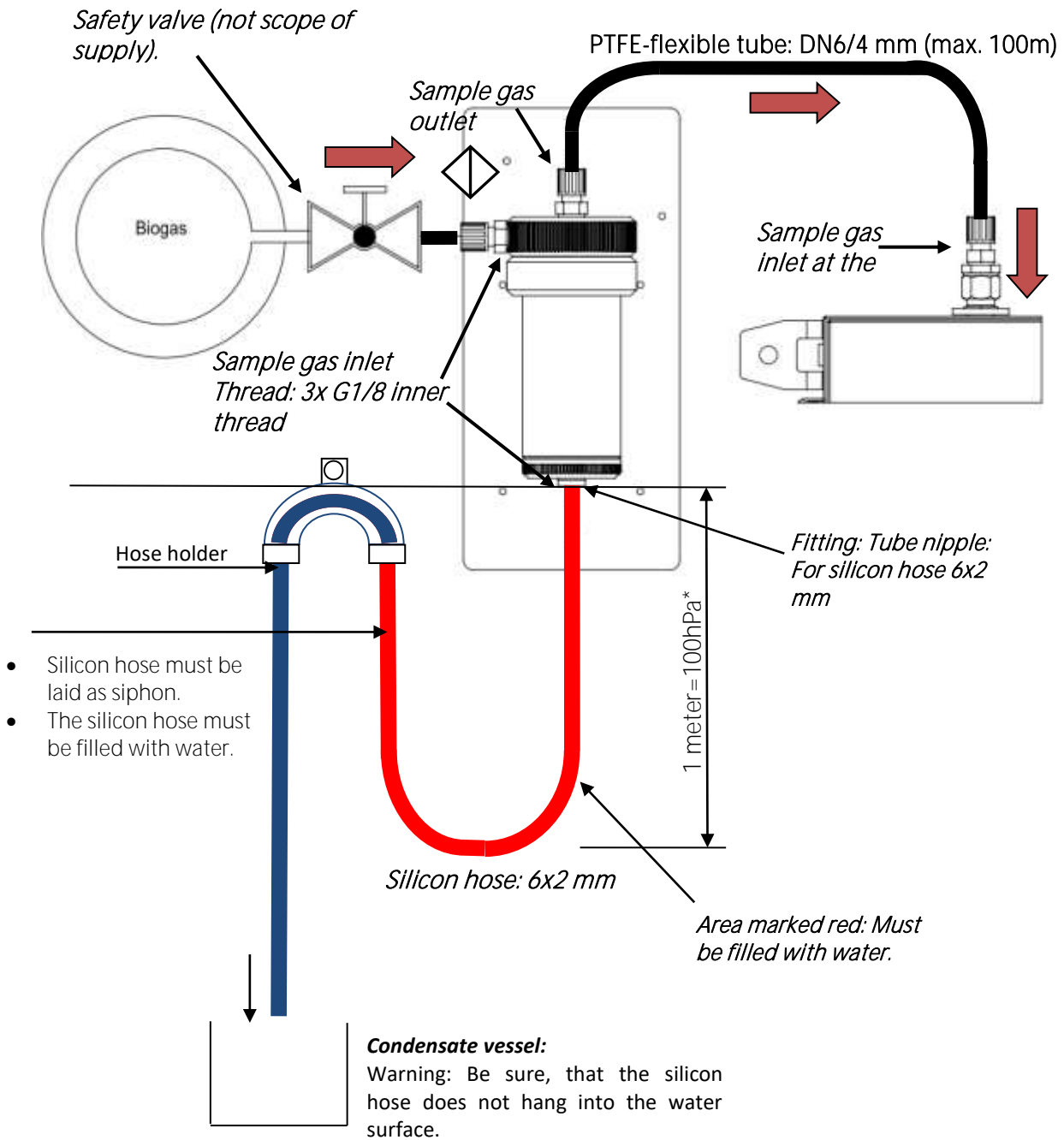

*Height of water column is dependent from the overpressure, which should be created.

Installation of the mounting panel

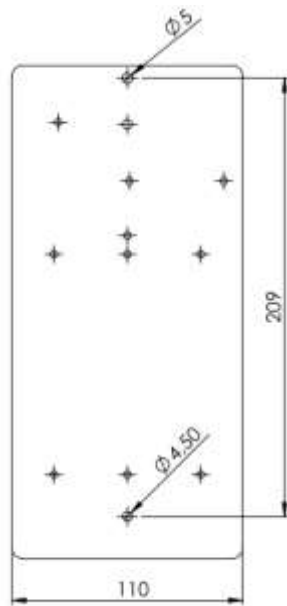

Exchanging the filter element

1. Close the safety valve at the gas inlet.

▲ CAUTION



Risk of negative pressure inside the system.

The following order must be considered:

- ▶ Shut the system down.
 - ▶ Close the safety valve at the gas inlet.
- This will prevent the build-up of negative pressure.

2. Remove sample gas inlet and sample gas outlet from the condensate trap.
Remove the silicon hose, which builds the siphon.

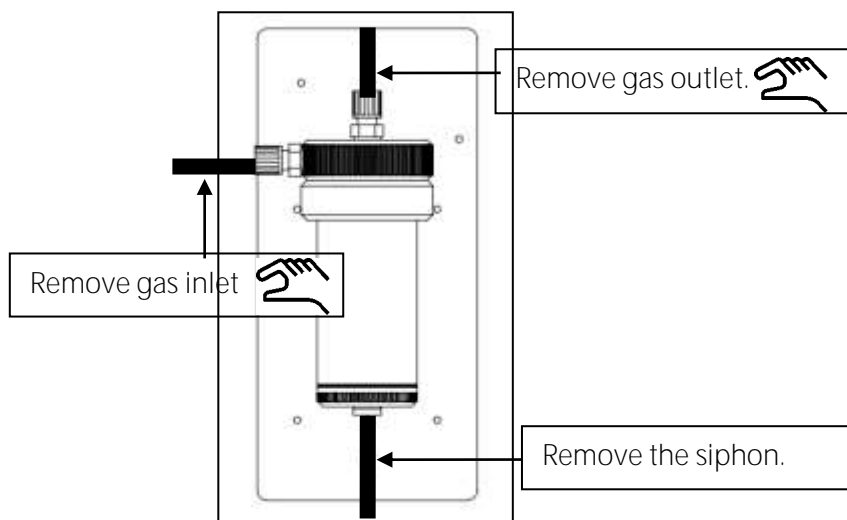

3. Remove the filter unit from the retention fixture (see picture 1).

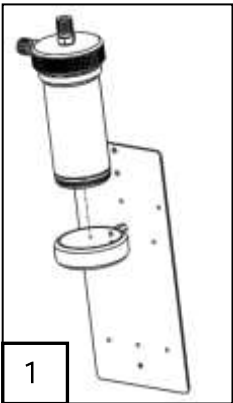

4. Unscrew filter the side glass from the external condensate trap (see picture 2).

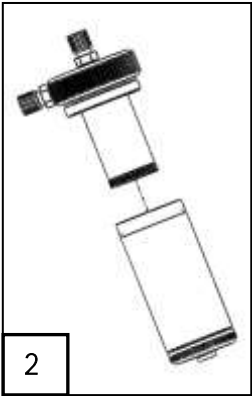

5. Unscrew the filter bracket (see picture 3).

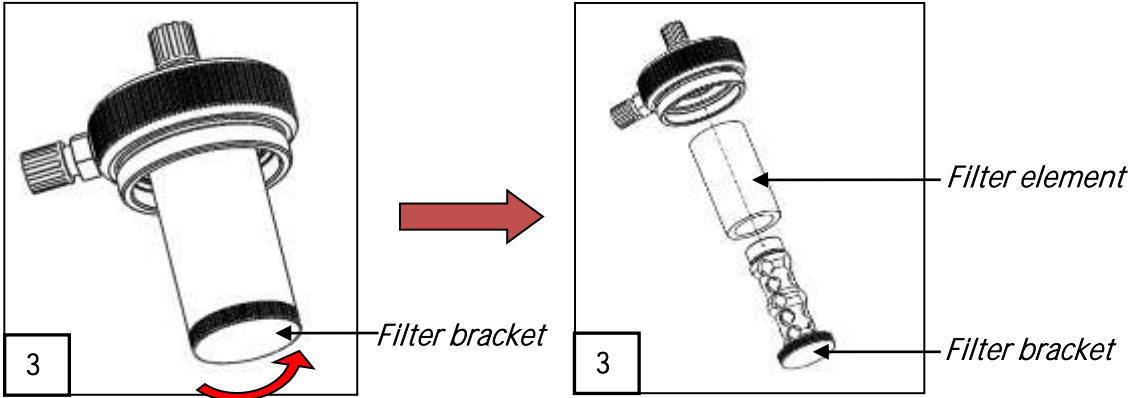

6. Delete the exhausted filter and exchange it with a new one (see picture 4).

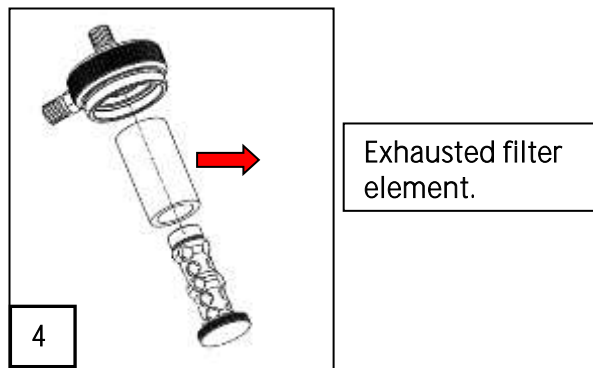

7. Screw the filter bracket back in the filter unit (see picture 5).

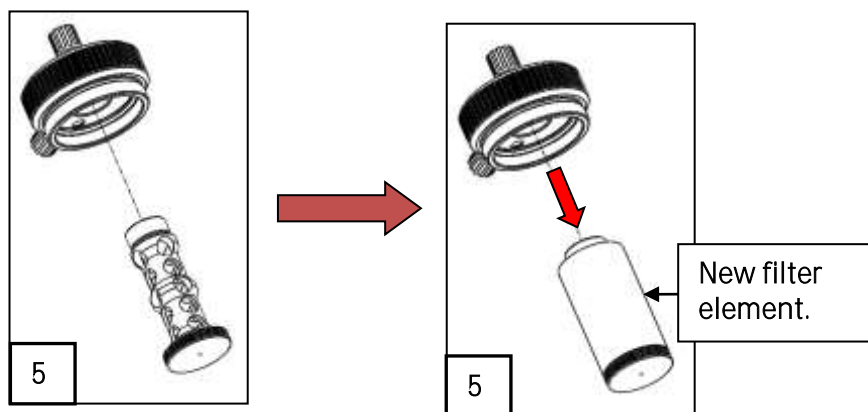

8. Screw the side glass back in the filter-unit.

Unscrew filter holding and remove exhausted filter element. Replace the filter element by a new one (pictures: 1-5).

13.9. Option: RS485 to Profi-Bus converter

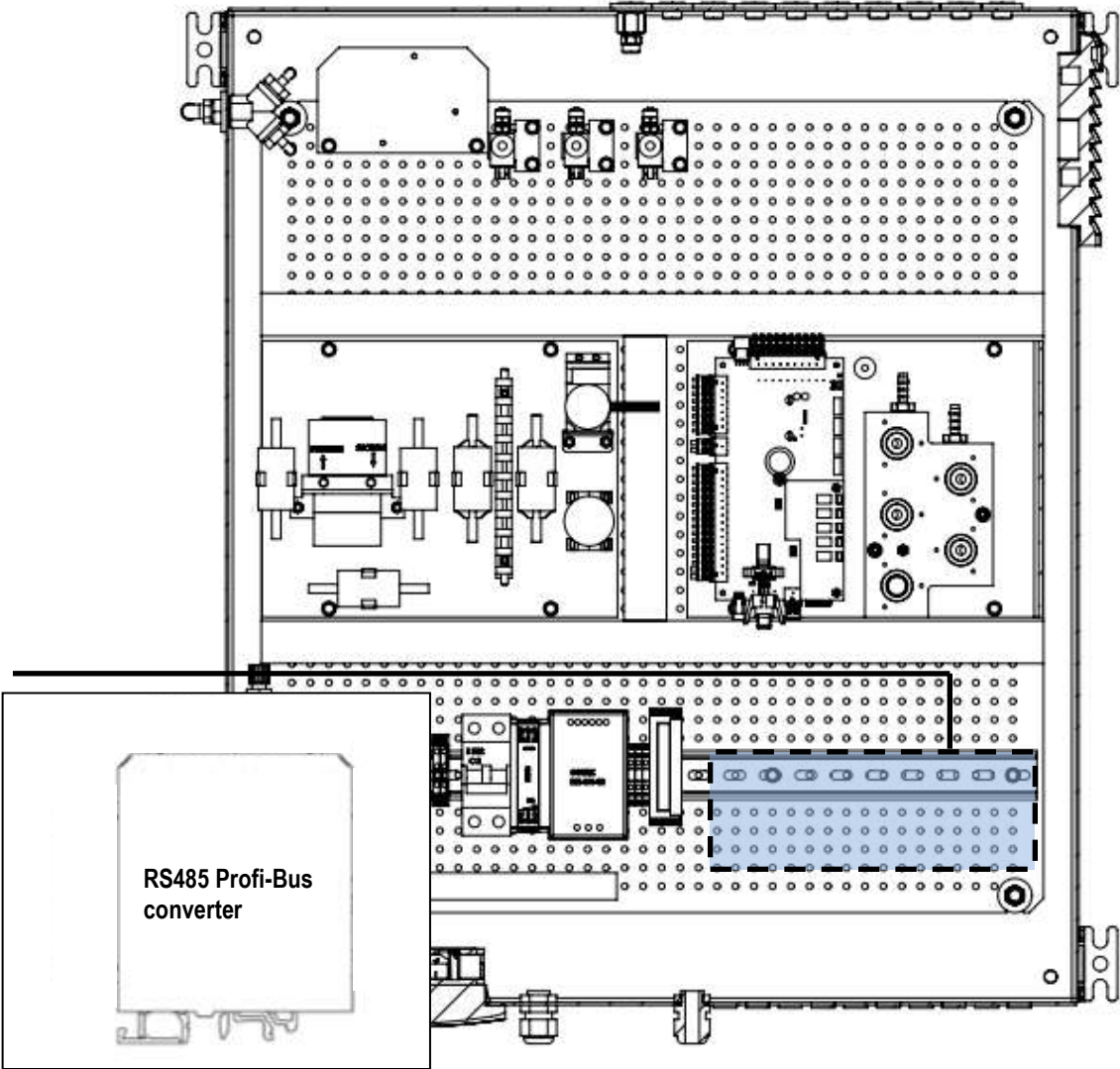

Normally the analyzer communication is Modbus RTU. If it is wanted, a RS485-Modbus/ Profibus converter can be installed at the DIN-rail. This hat-rail module will be explained in a separate manual.

13.10. Option: RS485 to Ethernet converter

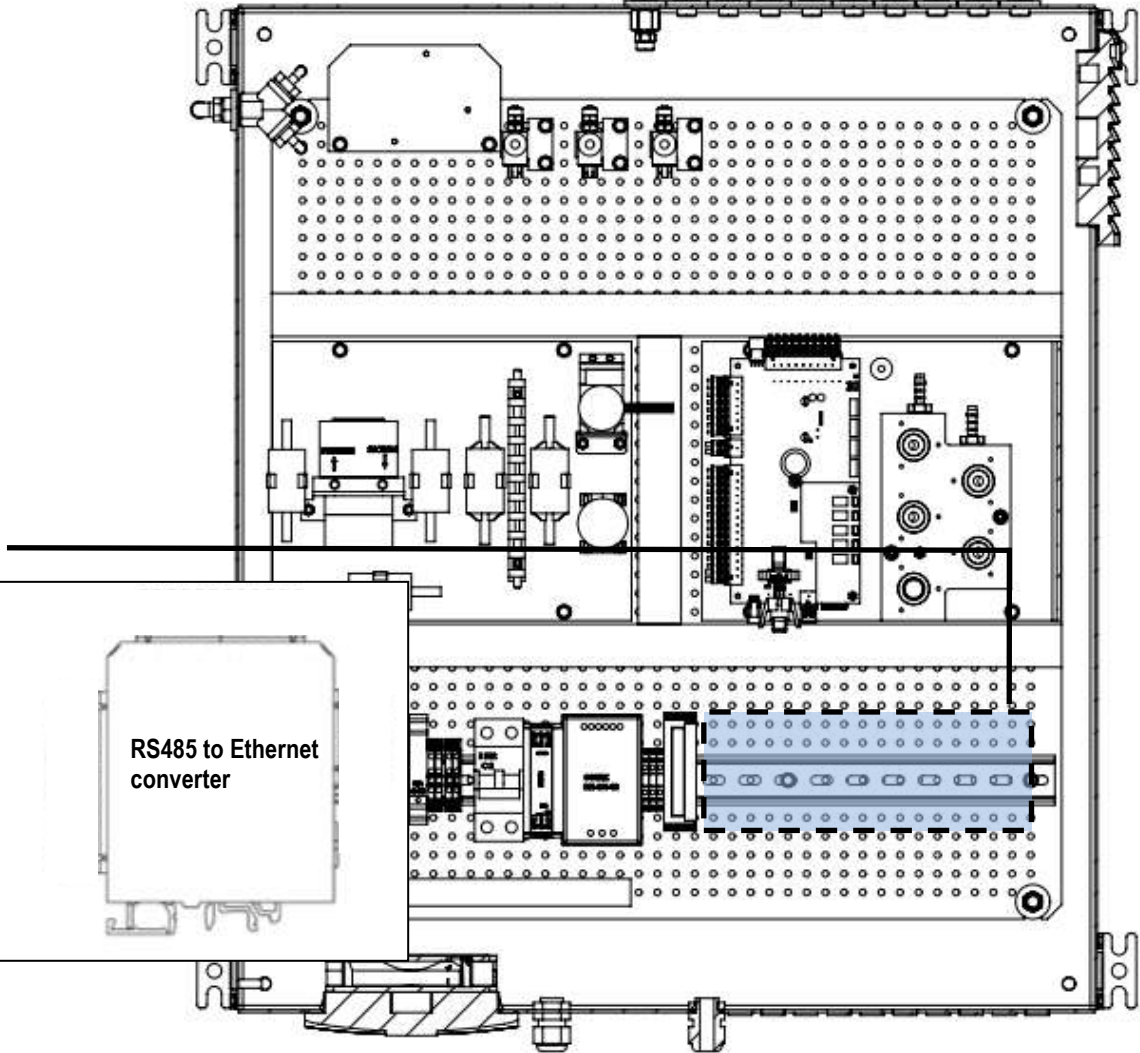

Normally the analyzer communication is Modbus RTU. If it is wanted, a RS485-Modbus/Ethernet Bus converter can be installed at the DIN-rail. This hat-rail module will be explained in a separate manual.

13.11. Configuration of the Ethernet module

1. Start the software "Easy setup".
 - The following screen will appear. Select Z-Key at the register called "Products in alphabetical order" (market with 1 in screenshot).
 - Push the "Start" key (market with 2 in screenshot).



- The following screen appears. To test the communication pushes the key "Test" (1). The current IP-address, which is saved at the module will appear.



- Get back in the menu and push the key "Setup" (2). Connect the Ethernetmodule with an USB-port of a pc. Then the key "Automatic search" (3). A screen appears, allowing to set the TCP protocol. After a correct TCP is set push the key "Next".



- At the next screen push the key "Send IP configuration to Z-key". The settings will be written to the module.

ATTENTION

. It can happen that the following message will appear:

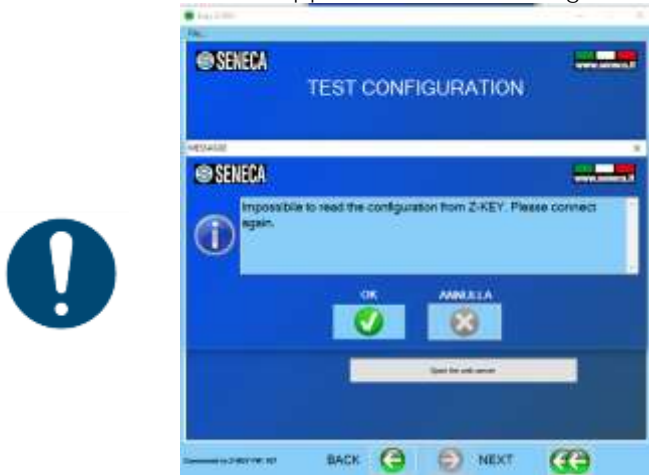

Just confirm the message and test, whether the settings are set. Normally the message can be ignored.

5. The settings are saved at the module now.

Adjustment of the SWG100 with the Ethernet

After the settings are configured the analyzer can be connected with the Ethernet.

1. Connect the Ethernet module with the network. For the connection use a LAN cable.

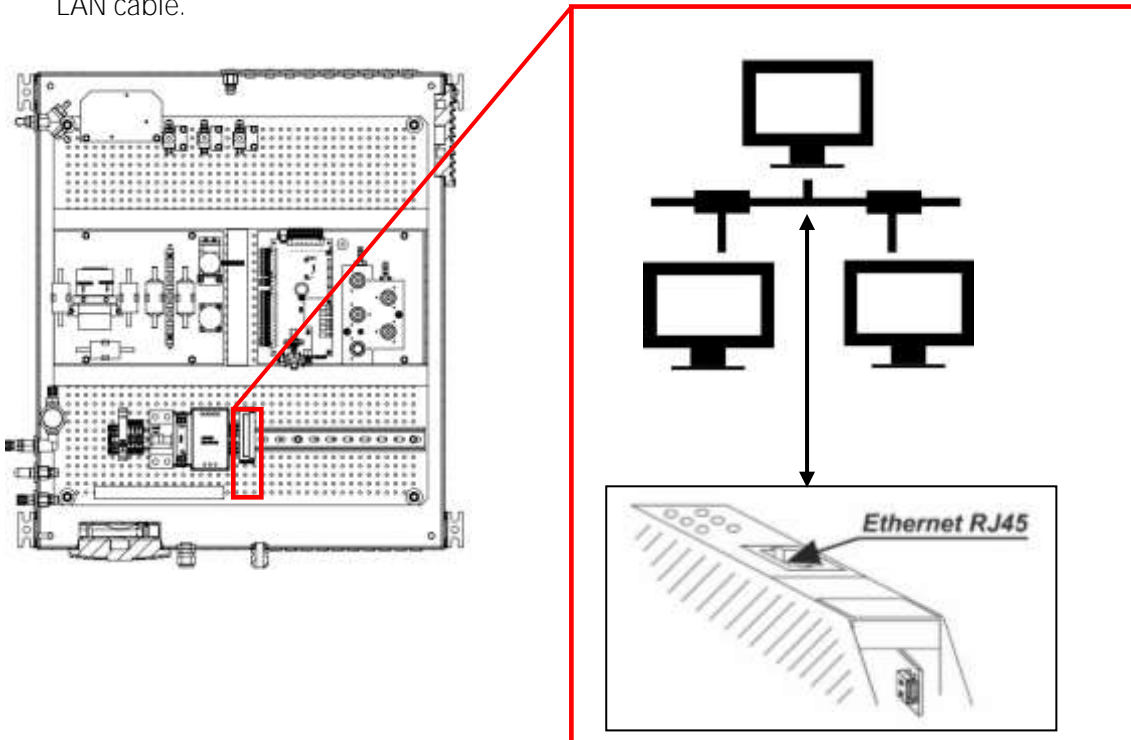

- Open the path Extras/General settings, at the analyzer. Push **F3=Modbus**. At this menu the Modbus slave parameters can be configured.

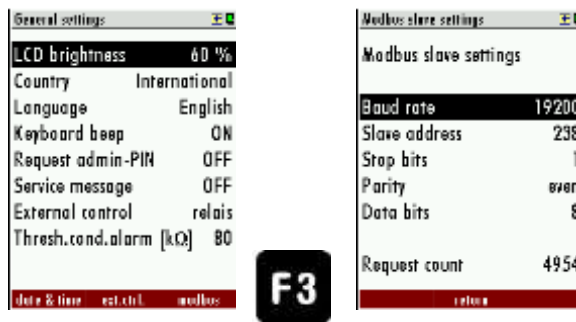
**Example:**

Baud rate: 19200
 Slave address: 238
 Stop bits: 1
 Parity: even
 Data bits: 8

Picture: The screenshot shows an example of a Modbus slave settings.

- In the next step it is necessary to build a connection between the analyzer and the network. To do this open the browser at a pc and open the webserver with the address:

- <http://192.xxx.xxx.xxx/maintenance/index.html>

	Important
	With the test modus for the alarm outputs of the IO module, the alarm relays at the IO modules and the relay at the PCB mainboard can be activated.

	Important
	The 192.xxxx.xxx.xxx is the IP-address, which is configured at the module (see chapter xx).

Example:

The IP-address of the module is 192.168.100.154, then the correct address to invoke the webserver is: <http://192.168.100.154/maintenance/index.html>.

- The webserver-address is protected with a password. The default password is:
 - Username: admin
 - Password: admin.
- The following screen appears.



6. Push "Setup". A list with the actual adjustments will be appeared.

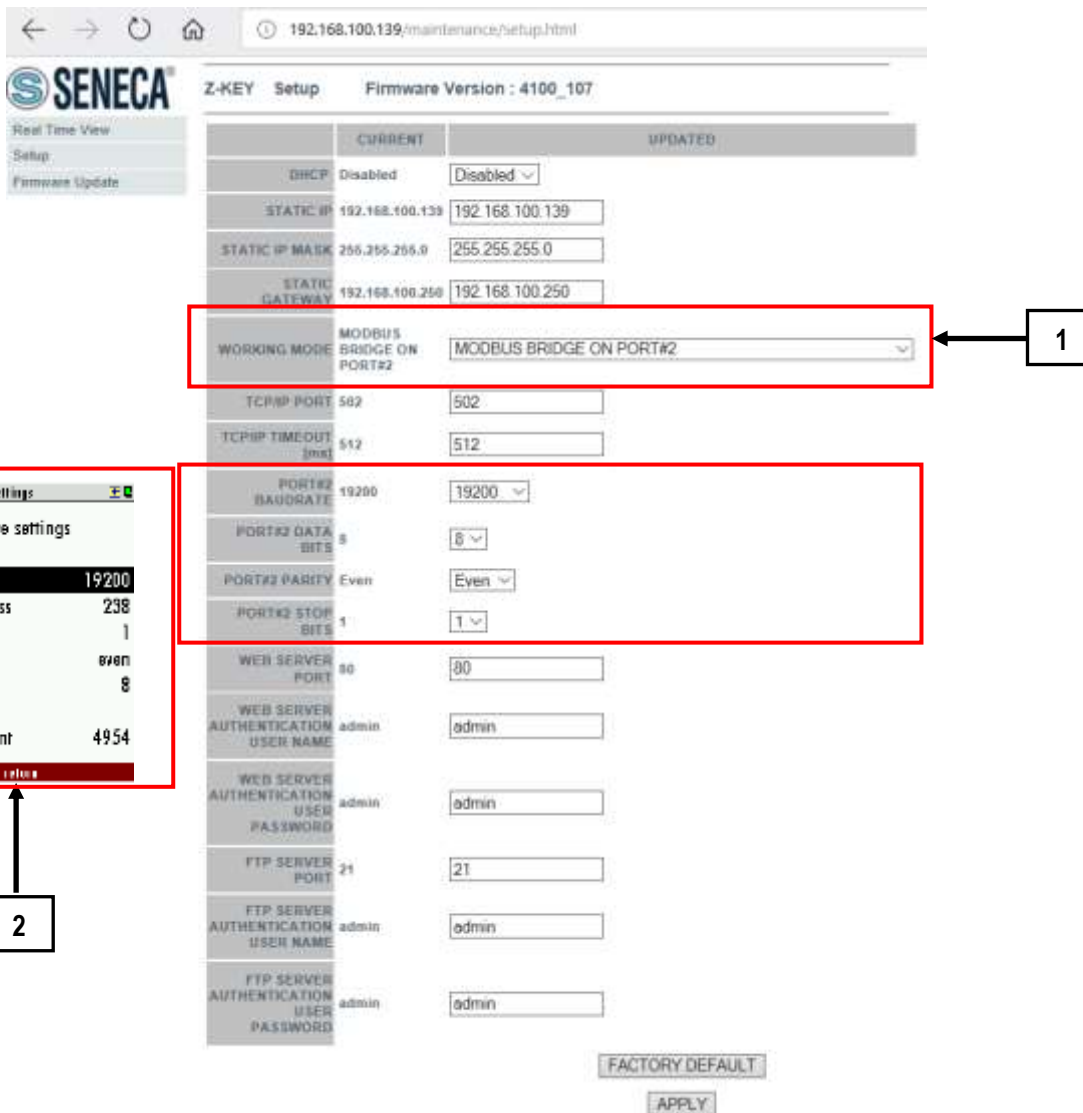

At this protocol the following adjustments must be set:

- 6. Working mode: MODBUS BRIDGE ON PORT#2 (1).
- 7. Baudrate (2):
- 8. Data Bits (2).
- 9. Parity (2).
- 10. Stop Bits (2).

- The baudrate, data bits, parity and stop bits must be the same like at the SWG100. After the settings are done, push the key "Apply".

Connection the SWG100 with MRU4WIN

1. Open MRU4WIN.
2. Push the key "Create new Modbus device" (1).

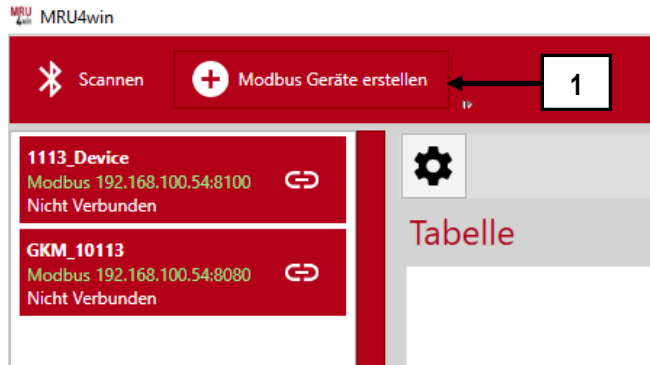

3. Set the Modbus setting from Serial to TCP(2).

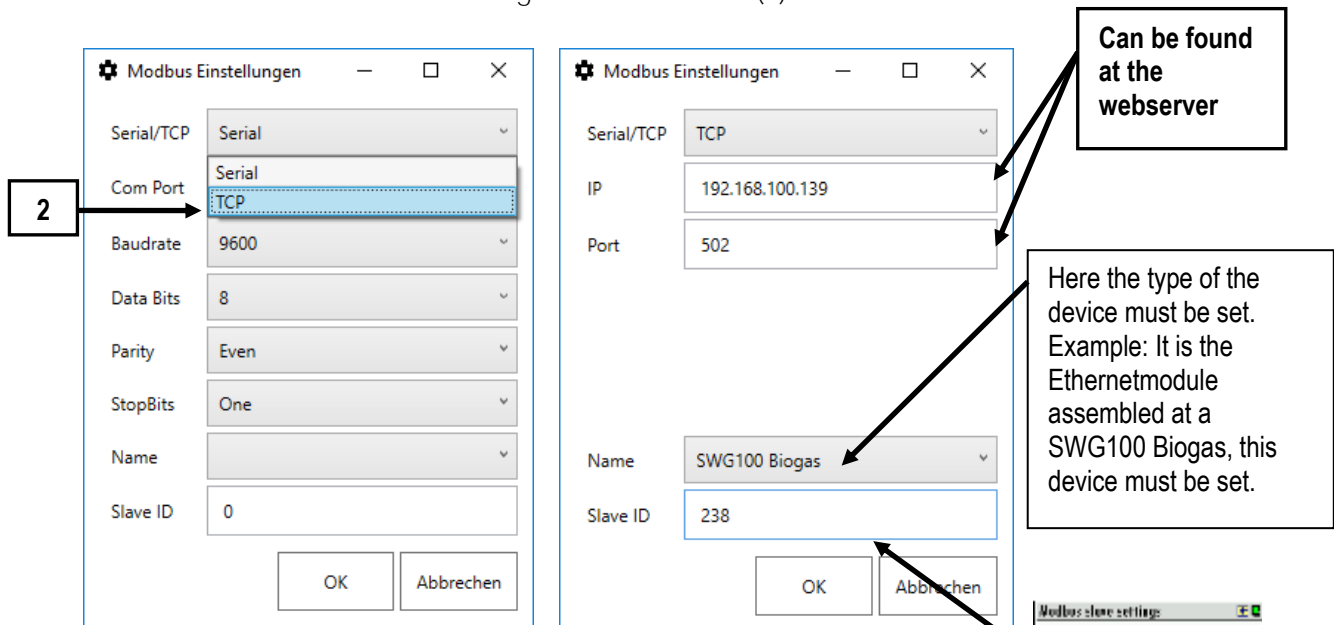

4. In the menu the following points must be set:

-
- IP-Address
- Port number
- Device
- Slave-ID
-



- The slave ID can be found at the modbus settings (see screenshot).
The port number (called Port at the setting) can be found at the Ethernet protocol (see chapter 1.1 point 6).
5. The new created device can be found at the left side of the MRU4WIN screen. Activated it and start the logging.

13.12. Option: Connection the SWG100 with RS-485 converter to MRU4Win

It is possible to connect the SWG-100 to MRU4Win, via a RS-485 converter. For the connection a MRU4Win-license and a RS-485 converter (offer-number: #62543) is required. Follow steps must be done:

- At the bottom side of the RS-485 converter is a DIP-switch. To configure the RS-485 converter it is necessary to switch the DIP-block in the follow position:

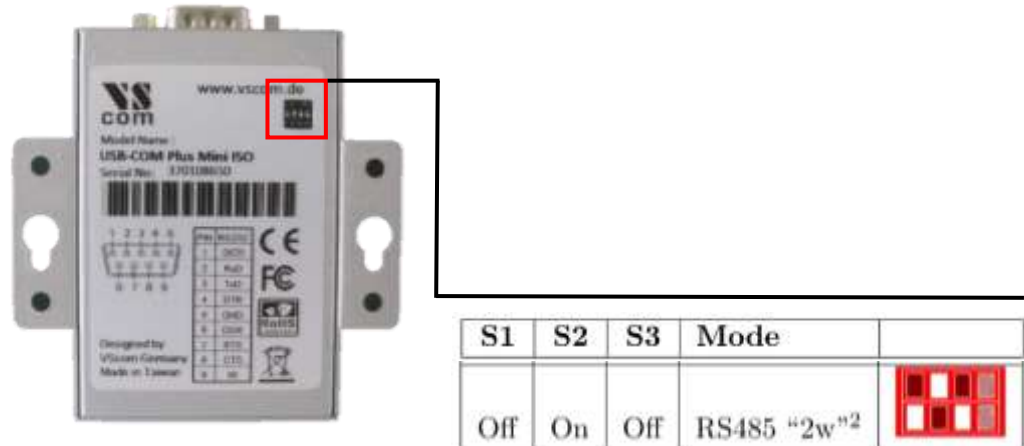

- Before the RS-485 converter can be used, a USB-driver must be installed at the PC. Normally, this driver installed at a common PC. If it is not installed, the USB-Driver can be download at the follow Web-Side: <http://www.visionssysteme.de/produkte/usb-com-plus-mini-usb-com-plus-mini-iso.html>. The download can be found under the topic "Downloads". The USB-driver is under the hyperlink "Current Windows x86 & x64". Without the USB-driver, the PC is not able to recognize the COM-port.
- Connect the RS-485 converter via USB cable with a PC having installed MRU4Win software.



- Normally the RS-485 converter should be recognized from the PC. For testing the connection, open the device manager of the PC. A new COM-

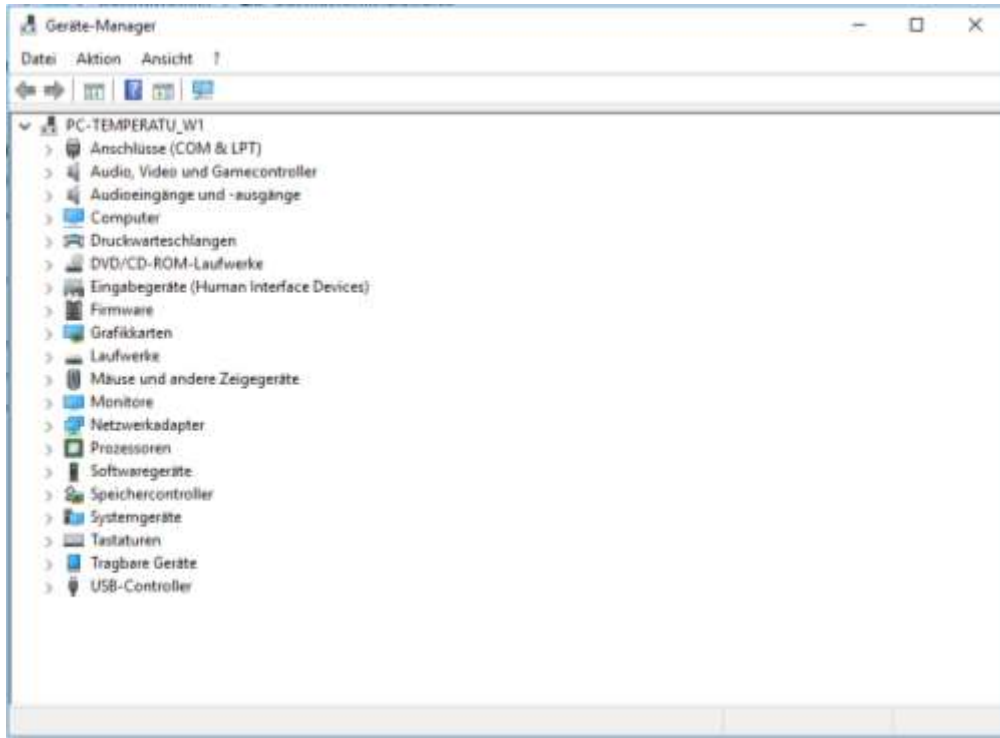

port must appear.

- Connect the RS-485 converter with the Modbus connector at the main-pcb at the SWG100.

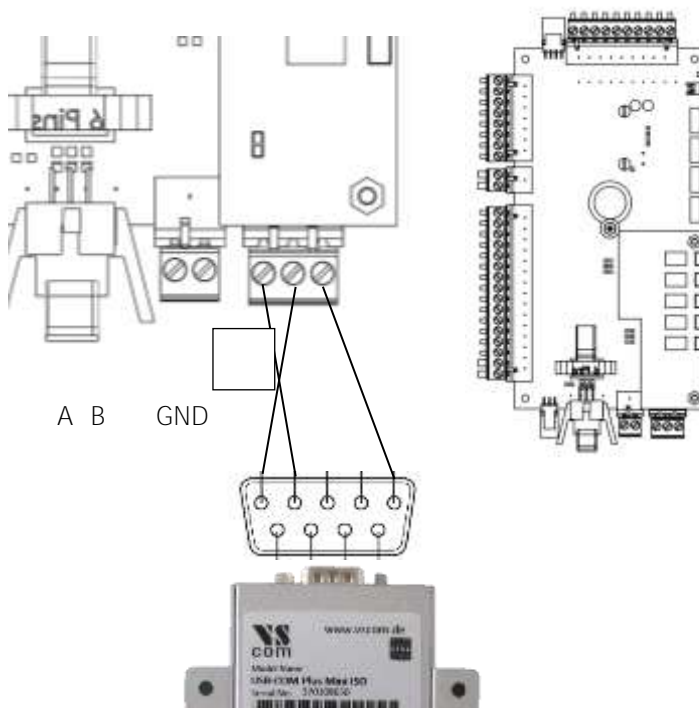

- Open the menu: Extras/general infos at the SWG100.
- Get in the menu "Modbus". To do this, press the F2-key.

- At this screen, the settings, for the SWG-100 can be set. The screen shot below shows an instance. Of course, it can be set other baud rates or settings.

Modbus slave settings	
Modbus slave settings	
Baud rate	9600
Slave address	1
Stop bits	1
Parity	even
Data bits	8
Invalid value	0.0 (def.)
Request count	241
<input type="button" value="return"/> <input type="button" value="user list"/>	

- Open the MRU4Win program. Press the button "Create Modbus device".

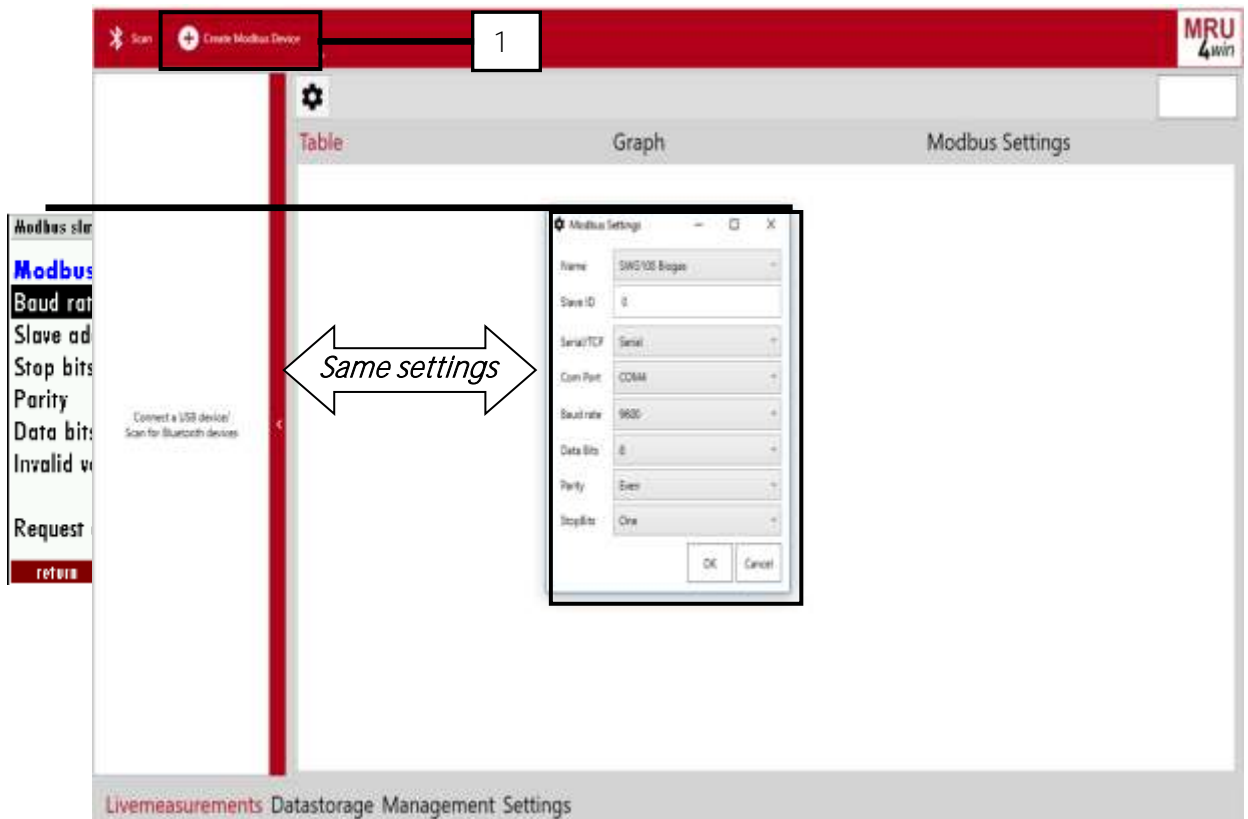

- A window, with modbus-settings will appear. At this window the same settings, like in the SWG-100 **must be entered**. At the first point, "Name" it is necessary to select the right device. This setting point is dependent from the SWG100-type. In this example SWG100 Biogas.
- The device will appear at the left side. For connection, press the connection symbol in the list.
- The PC is now connected with the SWG100. To start a log, press the Start Logging button at the upper right side.

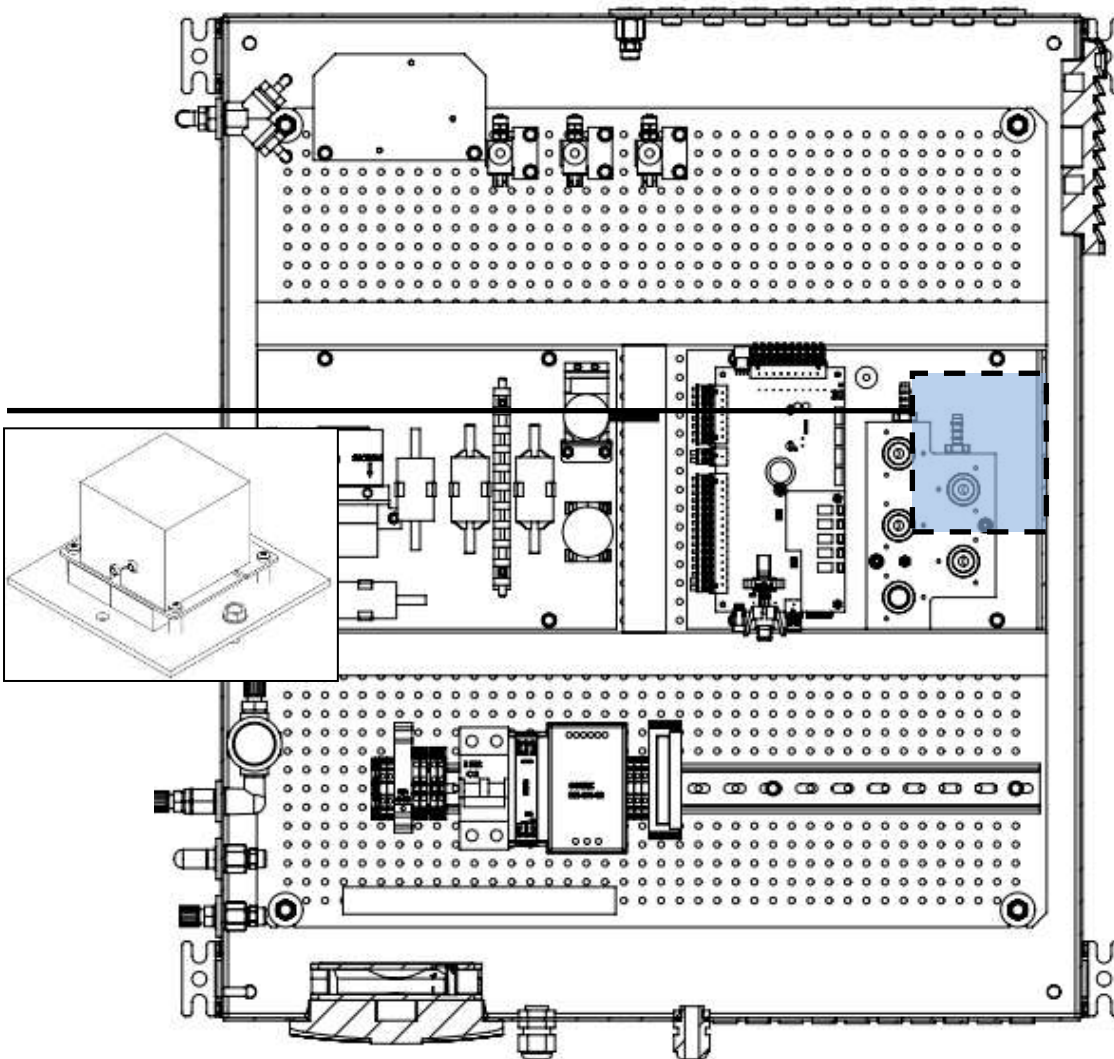
13.13. Option: NDIR-bench for CH₄/CO₂ analysis, 0-100% / 0-100%

This NDIR-bench is for biogas at AD plants. It detects CH_4 and CO_2 in percent range.

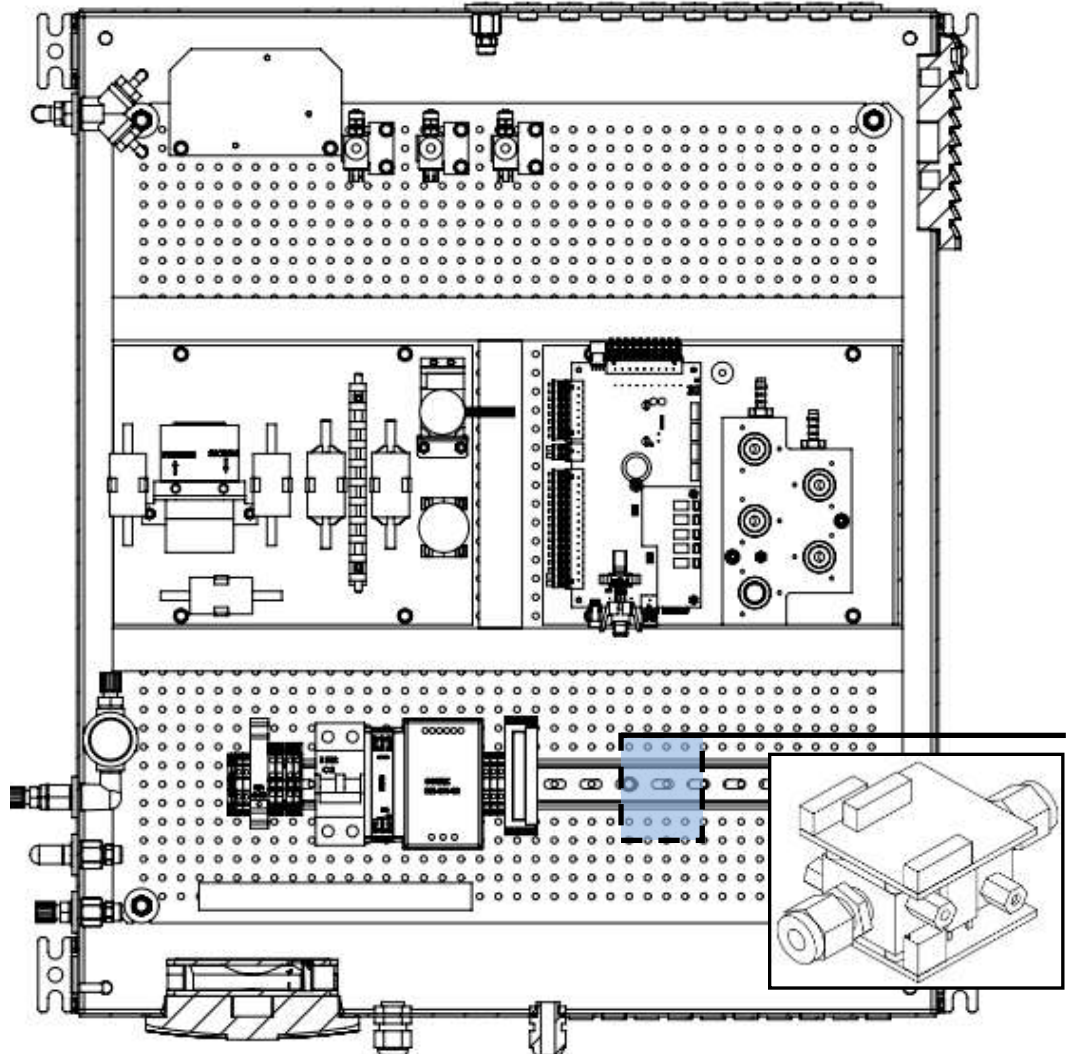
13.14. Option: H₂ thermal conductivity detector measurement 0-100%

It can equip the analyzer with a H_2 thermal conductivity detector, with a measurement range from 0-100%.

13.15. Option: NDIR-bench for 0-3.000ppm CO₂/0-3.000...30.000ppm CH₄

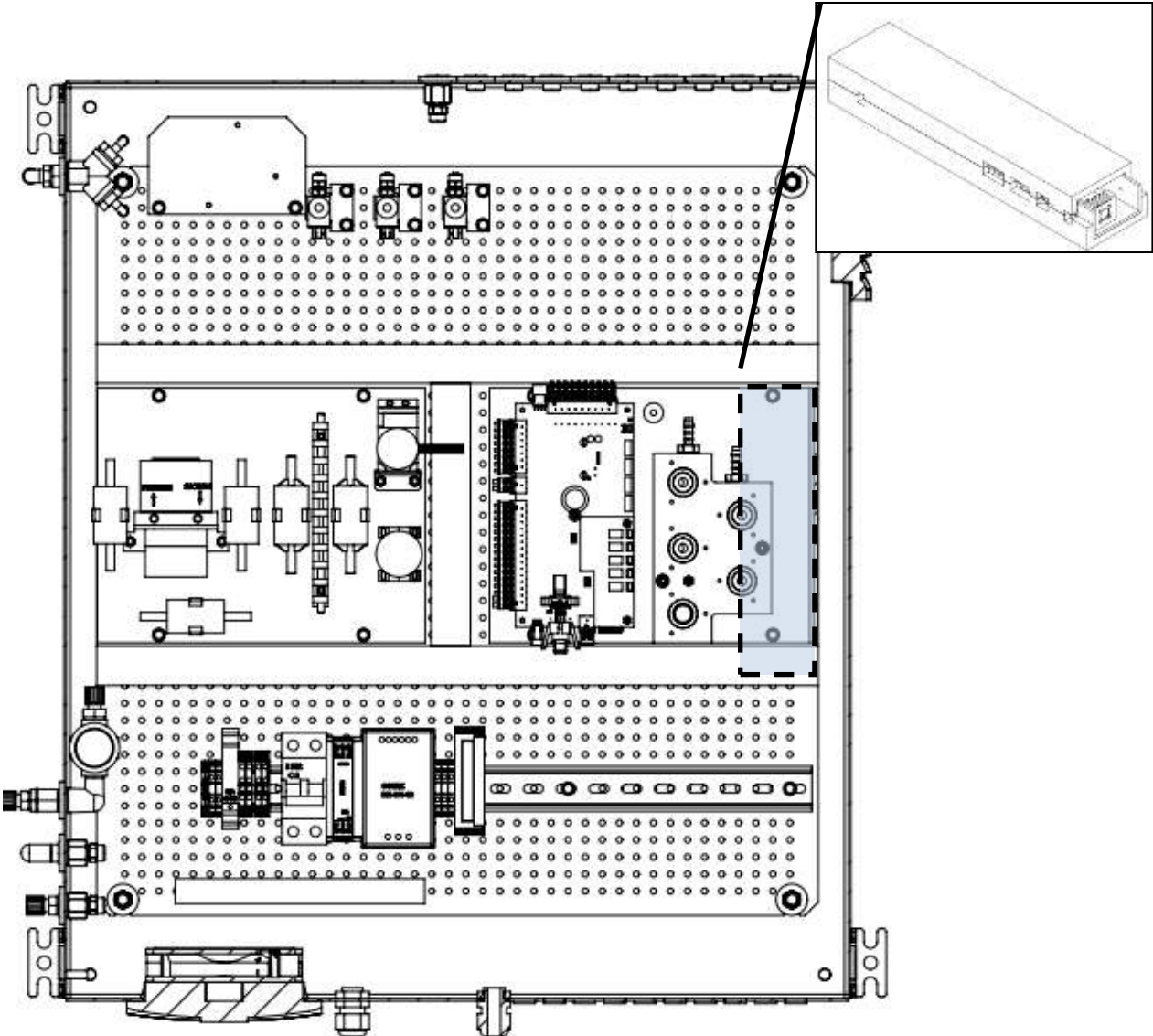

13.16. Option: Dilution-unit for H2S and CO electrochemical sensors

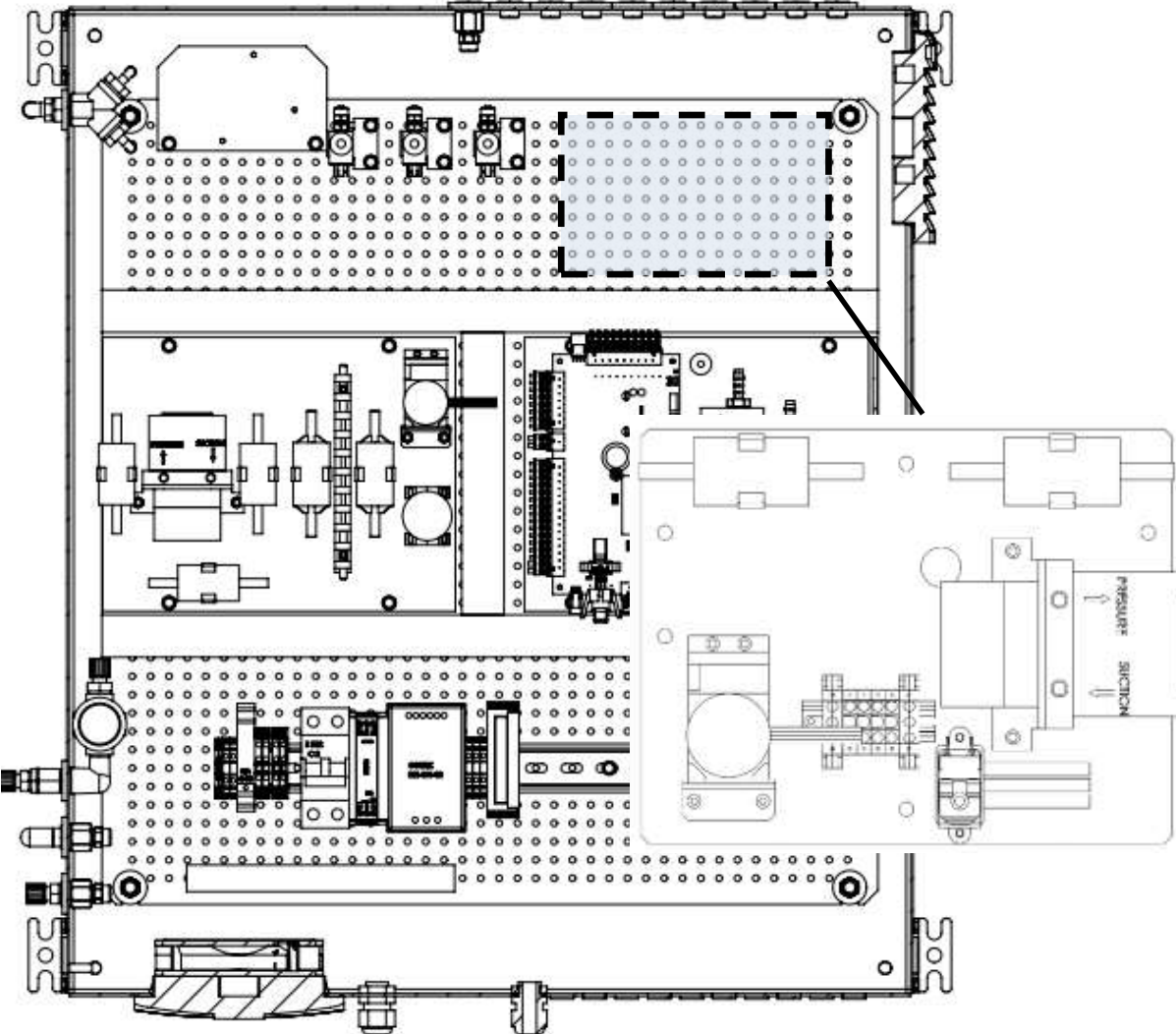

Dilution-unit

The dilution-unit inside the analyser dilutes the sample gas flow with a fix ratio. The unit is preadjusted. The operator must do a fine calibration of the device, to improve the accuracy of the measurement. For the fine calibration it is indispensable to tube the vent and all sample gas inlets, before making the actual calibration. The correct order for the fine calibration is shown in the flow chart.

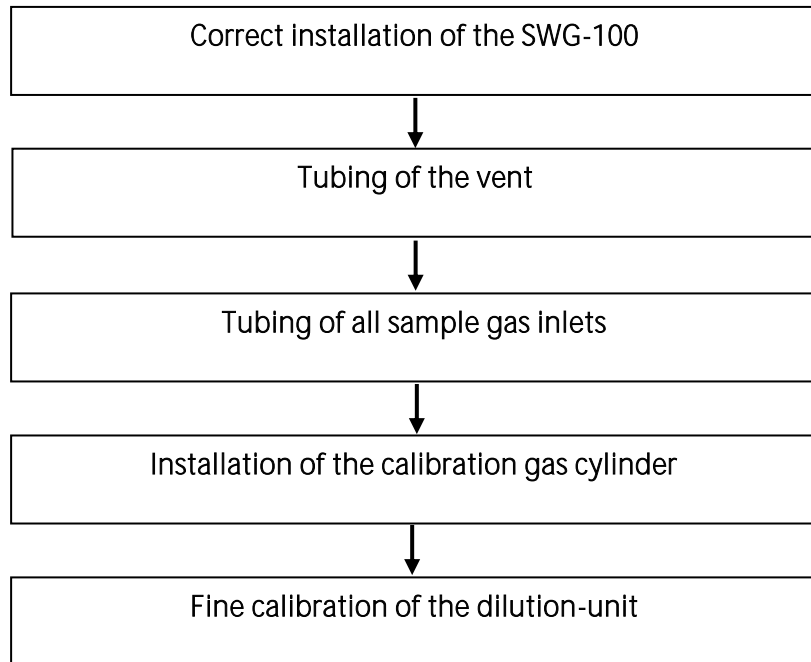

Fine calibration of the dilution-unit

If the steps above are done, the device should look like in the sketch below:

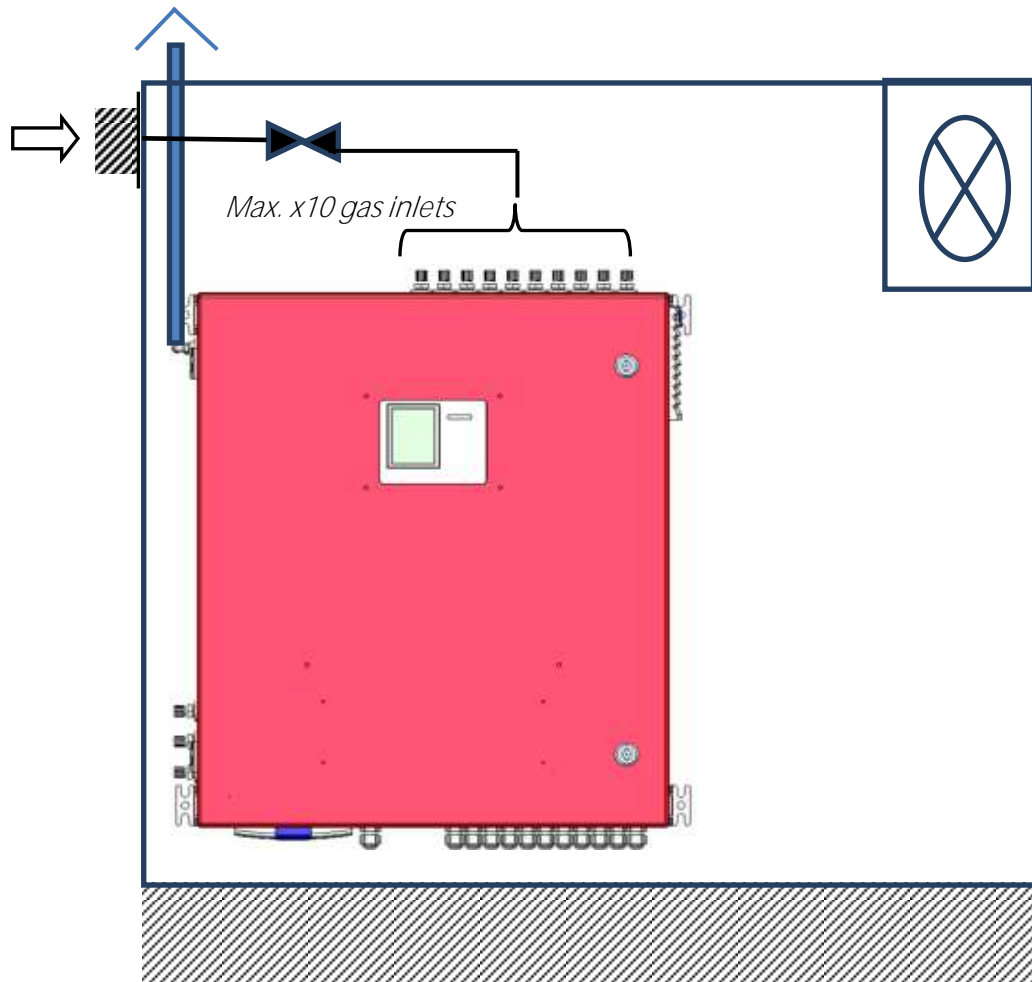

Follow steps must be done, for the fine calibration of the dilution-unit. The steps below show the entire adjustment on the example of a H₂S-sensors.

1. Installation of the calibration gas cylinder (gas cylinder for the undilute calibration).
2. Adjustment of the undilute electrochemical sensor.
 - a. Open the path: EXTRAS/ ADJUSTMENT MENU/ ADJUSTMENT GAS FACTOR
 - b. Select the electrochemical sensor, which should be adjusted.

Adjustment gas factor		
O2	20.95 %	
CO	-0.1 ppm	1.000
CO/H2		1.000
H2S high	473 ppm	1.000
T: 657 s G: 0.0 %/min		
O2-air Auto Span rross		

- c. Impinge the device with the calibration gas. Wait until the gas concentration, of the sensor will not change anymore.
 - d. The actual value is displayed at the screen. This actual value must be adjusted with the set point, from the gas cylinder. To do this, changes with the right/left arrow keys the gas factor until the actual value is adjusted with the set point.
3. Adjustment of the dilution-unit.
 - a. Installation of the calibration gas cylinder, for the dilution-unit. This gas cylinder must have a min. concentration of 500 ppm of the target gas.
 - b. Open the path: EXTRAS/ADJUSTMENT MENU/ GAS DILUTION ADJUSTMENT.
 - c. The follow screen appears. The menu has the follow structure:

Gas dilution adjustment	
Gas dilution adjustment	
Dilution factor	48.95
CO [ppm]	-0
H2S [ppm]	23174
O2 [%]	20.98
return	

- i. ***Dilution factor (1)***: Means the dilution ratio. For example: the value 50 means a ratio from 1:50. Hence, 10,000 ppm pure H2S, for example, will dilute to 200 ppm. The mathematical basic formula is:

$$C_{pure} = C_{Dilution} * f_{Dilution}$$

C_{pure} = Undilution gas concentration [in ppm].

$C_{Dilution}$ = Dilute gas concentration [in ppm].

$f_{Dilution}$ = Dilution factor [do dimension].

- ii. Dilutable gases and the actual values (2): This show the dilutable gases and the calculated undiluted actual gas concentration value (C_{pure}).
- d. To fine calibrate the dilution-unit select the dilutable gas and impinge the analyser with the calibration gas. Wait until the gas concentration will not change anymore. Shift with the right/left arrow keys the dilution factor, until the actual value has the gas concentration of the calibration gas cylinder.

Software-settings

The operator can do following settings.

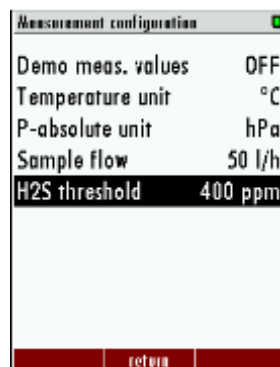

- Threshold: The operator can change the threshold. If the value is above this threshold, the dilution will turn on.
 - The path for this setting is: EXTRAS/MEASUREMENT CONFIGURATION.
 - Marked the setting “**threshold**” with the cursor. With the left/right arrow keys the value can be changed.
 - Leaving the menu and confirm the modification.

Setting the dilution cycle

In the default setting the dilution is set automatically. This means, the first cycle will be measured dilute. If the gas concentration is under the threshold, the next cycle will be measured undiluted. If the sample gas concentration will reach the threshold again, the dilution will be activated. During the activation, the measurement value will be hold for 90 sec. At the display, the dilute measurement value will be displayed with “hold”. After the 90 sec. the life-values will turn on again.



90 sec.

Measurement 59:50	
CH4 [%]	0.00
O2 [%]	20.97
H2S hold [ppm]	473
CO2 [%]	0.03
CO [ppm]	0
CH4 internal [% LEL]	0.0

Threshold

Measurement 57:51	
CH4 [%]	0.00
O2 [%]	20.91
H2S dil. [ppm]	23665
CO2 [%]	0.05
CO [ppm]	0
CH4 internal [% LEL]	0.0

The operator can change the dilution settings, from every measurement phase setting, from “automatically” to “ON”. ON means, the dilution is permanent activate for this measurement phase. Other measurement phases are not affected. For example: If the SWG-100 has a sample gas junction, with three sample gas inlets and the dilution-setting from sample gas-inlet 1 is permanently activated (ON), the two other sample gas-inlets are further set to automatically.

To change the dilution setting follow steps must be done:

- Open the path: EXTRAS/MEASUREMENT CYCLE CONFIG.
- Open the measurement phase, from the sample-point, which should be set.
- Press the OK key, to turn into the detail menu of the measurement phase.
- Change the dilution from “automatically” to “ON”.

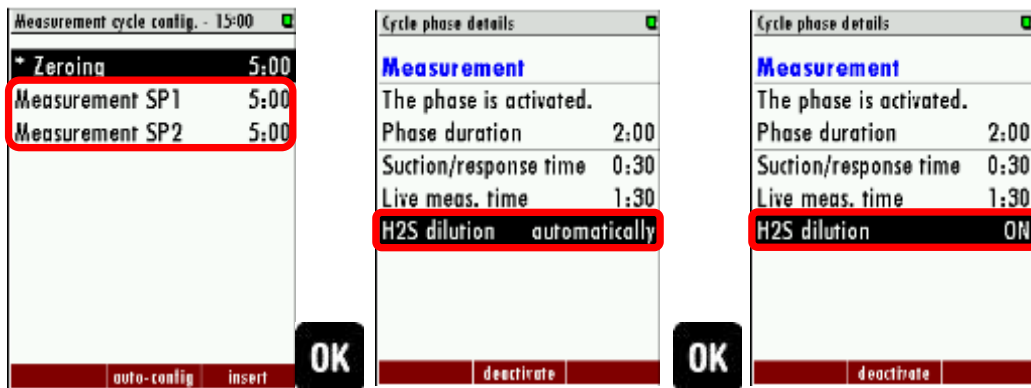

14. Declaration of conformity



MRU Messgeräte für Rauchgase und Umweltschutz GmbH



Fuchshalde 8 + 12
 74172 Neckarsulm-Oberseesheim
 Deutschland / Germany
 Tel.: +49 (0) 7132 - 99 62 0
 Fax: +49 (0) 7132 - 99 62 20
 E-Mail / mail: info@mru.de
 Internet / site: www.mru.eu



Bevollmächtigte Person, für die Zusammenstellung der technischen Unterlagen
Person authorized to compile the technical documents

Name / name: Dierk Ahrends
 Funktion / function: QM-Beauftragter / QM-Representative
 Firmenname / company: Messgeräte für Rauchgase und Umweltschutz GmbH
 Straße / street: Fuchshalde 8 + 12
 Ort / city: 74172 Neckarsulm
 Land / country: Deutschland / Germany

Produkt/Product

Bezeichnung / designation: Gasanalysator
 Gas analyser
 Produktname / name: SWG100
 Funktion / function: Gasanalyse / gas analysis

Hiermit erklären wir, dass das oben beschriebene Produkt allen einschlägigen Bestimmungen entspricht, es erfüllt die Anforderungen der nachfolgend genannten Richtlinien und Normen:

We declare the conformity of the product with the applicable regulations listed below:

- EMV-Richtlinie / *EMV-directive* 2014/30/EU
- Niederspannungsrichtlinie / *low voltage directive* 2014/35/EU
- RoHS-Richtlinie / *RoHS directive* 2011/65/EU (RoHS II)

Neckarsulm, 20.06.2016



Erwin Hintz, Geschäftsführer / *Managing Director*

V01.02.EN