



SOLAR-500

Solar Analyzer

Users Manual

- Mode d'emploi
- Bedienungshandbuch
- Manual d'Uso
- Manual de uso



SOLAR-500

Solar Analyzer

Users Manual

English

July 2009, Rev.1
©2009 Amprobe Test Tools.
All rights reserved. Printed in Taiwan

Limited Warranty and Limitation of Liability

Your Amprobe product will be free from defects in material and workmanship for 1 year from the date of purchase. This warranty does not cover fuses, disposable batteries or damage from accident, neglect, misuse, alteration, contamination, or abnormal conditions of operation or handling. Resellers are not authorized to extend any other warranty on Amprobe's behalf. To obtain service during the warranty period, return the product with proof of purchase to an authorized Amprobe Test Tools Service Center or to an Amprobe dealer or distributor. See Repair Section for details. THIS WARRANTY IS YOUR ONLY REMEDY. ALL OTHER WARRANTIES - WHETHER EXPRESS, IMPLIED OR STATUTORY - INCLUDING IMPLIED WARRANTIES OF FITNESS FOR A PARTICULAR PURPOSE OR MERCHANTABILITY, ARE HEREBY DISCLAIMED. MANUFACTURER SHALL NOT BE LIABLE FOR ANY SPECIAL, INDIRECT, INCIDENTAL OR CONSEQUENTIAL DAMAGES OR LOSSES, ARISING FROM ANY CAUSE OR THEORY. Since some states or countries do not allow the exclusion or limitation of an implied warranty or of incidental or consequential damages, this limitation of liability may not apply to you.

Repair

All test tools returned for warranty or non-warranty repair or for calibration should be accompanied by the following: your name, company's name, address, telephone number, and proof of purchase. Additionally, please include a brief description of the problem or the service requested and include the test leads with the meter. Non-warranty repair or replacement charges should be remitted in the form of a check, a money order, credit card with expiration date, or a purchase order made payable to Amprobe® Test Tools.

In-Warranty Repairs and Replacement – All Countries

Please read the warranty statement and check your battery before requesting repair. During the warranty period any defective test tool can be returned to your Amprobe® Test Tools distributor for an exchange for the same or like product. Please check the "Where to Buy" section on www.amprobe.com for a list of distributors near you. Additionally, in the United States and Canada In-Warranty repair and replacement units can also be sent to a Amprobe® Test Tools Service Center (see address below).

Non-Warranty Repairs and Replacement – US and Canada

Non-warranty repairs in the United States and Canada should be sent to a Amprobe® Test Tools Service Center. Call Amprobe® Test Tools or inquire at your point of purchase for current repair and replacement rates.

In USA

Amprobe Test Tools

Everett, WA 98203

Tel: 877-AMPROBE (267-7623)

In Canada

Amprobe Test Tools

Mississauga, ON L4Z 1X9

Tel: 905-890-7600

Non-Warranty Repairs and Replacement – Europe

European non-warranty units can be replaced by your Amprobe® Test Tools distributor for a nominal charge. Please check the "Where to Buy" section on www.amprobe.com for a list of distributors near you.

European Correspondence Address*

Amprobe® Test Tools Europe

In den Engematten 14

79286 Glottertal, Germany

Tel.: +49 (0) 7684 8009 - 0

*(Correspondence only – no repair or replacement available from this address. European customers please contact your distributor.)

A) Front Panel

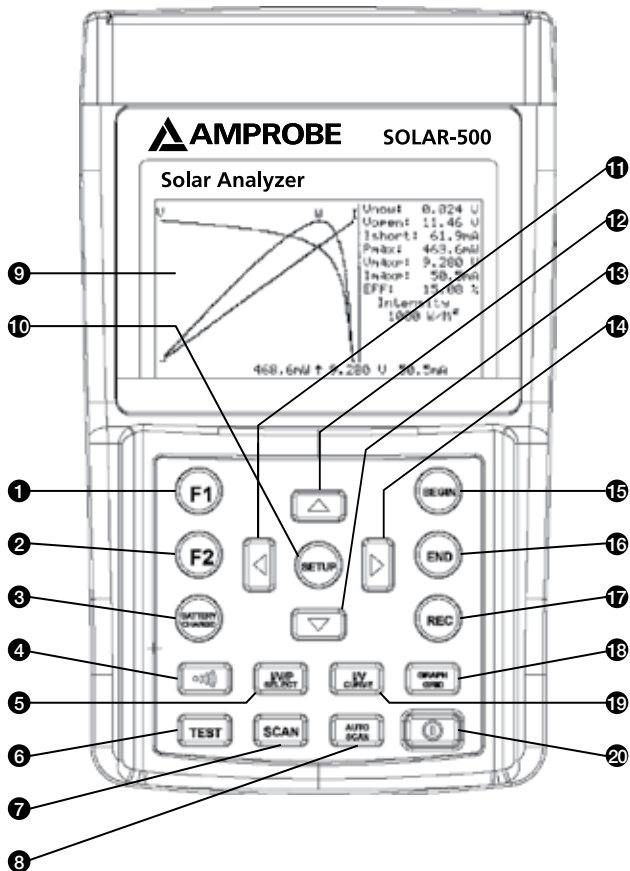

1)  **F1 Button:** (Reserved)

2)  **F2 Button:** (Reserved)

3)  **Battery Charge Button**

When Solar Module Analyzer is turned on, press BATTERY CHARGE button to recharge batteries (*please do not use regular batteries for recharging*)

4)  **(Buzzer) Button**

Press this button to turn on/off the beeper (low Power) alarm function

5)  **I/V/P Select Button**

Select display of I-V/ V-I curve, P-V/P-I curve, or both curves

6)  **Test Button**

Single point I-V test based up specified value

7)  **Scan Button**

Manual scan I-V curve test based upon specified value

8)  **Auto Scan Button**

Auto scan I-V curve test

9) **LCD**

LCD displays measurement data and curves

10)  **Setup Button**

Enter/Exit SETUP menu

11)  **Button**

(1) In a curve, press it to move the cursor left

(2) In SETUP menu, press it to decrement value by 1

12)  **Button**

In the SETUP menu, press ▲ button to select previous item

13)  **Button**

In the SETUP menu, press ▼ button to select next item

14)  **Button**

(1) In a curve, press it to move the cursor right

(2) In SETUP menu, press it to increment value by 1

15)  **Begin Button**

Start scanning point (current) setting

16)  **End Button**

Stop scanning point (current) setting

17)  **Rec Button**

(1) Record the present measurement data

(2) How to clear recorded data: keep pressing REC button and turn on the analyzer, then all the data recorded in the analyzer will be deleted

18)  **Graph Grid Button**

Display/Cancel graph grid

19)  **I/V Curve Button**

Select I or V as horizontal coordinate

20)  **Power Button**

Turn on/off the power of Solar Analyzer

B) Rear Panel

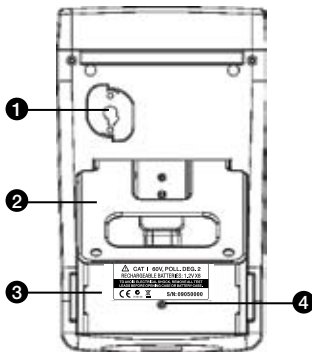

- 1) Communication Window**
To connect Solar Analyzer with PC via USB cable
- 2) Stand**
- 3) Battery Cover**
- 4) Screw of Battery Cover**

C) TOP Panel (Connectors)

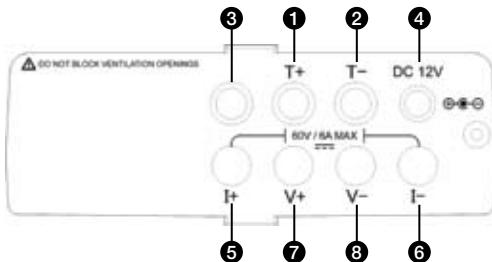









- | | |
|--|---|
| 1) T+ Terminal (Kelvin Clips) | 5) I+ Terminal (Alligator Clips) |
| 2) T- Terminal (Kelvin Clips) | 6) I- Terminal (Alligator Clips) |
| 3) Terminal Reserved for Factory Test | 7) V+ Terminal (Alligator Clips) |
| 4) ±DC 12V | 8) V- Terminal (Alligator Clips) |

CONTENTS

SYMBOLS, WARNINGS AND PREPARATION	2
UNPACKING AND INSPECTION	2
INTRODUCTION	3
OPERATION	7
Preparation.....	7
Precaution	8
Connecting Diagram.....	9
Selected Condition of Auto Scan, Manual Scan, or Test Auto Scan.....	10
Auto Scan	12
Manual Scan	13
Single Point Test.....	14
Save Testing Results	15
Clear recorded testing data.....	16
Setup Menu	17
SPECIFICATION	18
Electrical Specifications.....	18
General Specifications	19
MAINTENANCE AND REPAIR	20
Battery Replacement / Recharging	21
Fuse Replacement	22
PC CONNECTION, SOFTWARE INSTALLATION AND OPERATION	24
INTRODUCTION	24
Operating Environment	24
Hardware	24
Connecting Procedures	24
SOFTWARE INSTALLATION	25
Install Application Program	25
Install USB Driver	25
SOFTWARE OPERATION	26
Start Executing Program	26
Parameter Setting.....	27
Save/Print LCD.....	28
Download.....	29
Auto Scan Solar Module.....	31

SYMBOLS

	Caution ! Refer to the explanation in this Manual
	Caution, Risk of Electric Shock
	This equipment is not for measurements performed for CAT II, III, and IV
	Please remove all the test leads before performing maintenance, cleaning, battery replacement, fuse replacement, etc
	Earth (Ground)
	DC--Direct Current
	Conforms to relevant Australian standards
	Complies with European Directives
	Do not dispose of this instrument as unsorted municipal waste. Contact a qualified recycler for disposal.

WARNING!

Do not operate this instrument in the presence of gasoline, natural gas, propane, or in other combustible atmospheres.

UNPACKING AND INSPECTION

Your shipping carton should include:

- 1 SOLAR-500 Solar Analyzer
- 1 Carrying Bag
- 1 Users Manual
- 1 AC Adaptor
- 1 RS232C (to USB Bridge) Cable
- 8 Rechargeable Batteries
- 1 Software CD
- 1 Software Manual
- 1 Kelvin Clips (6A max, 1 pair)

If any of the items are damaged or missing, return the complete package to the place of purchase for an exchange.

INTRODUCTION

The SOLAR-500 can be used in Quality Control for Production Line, Warehouse or Site of Installation.

Manufacturers of solar panels can test the characteristics for quality control purpose in the production line. Due to the advantage of portability of the unit, quality inspectors can randomly pick samples of solar panels and test them in the warehouse to assure quality before shipment.

Installation engineer can randomly test samples of solar panels at site to verify the quality of solar panels used at site of installation.

Example A: Identify the Solar Power System Requirement

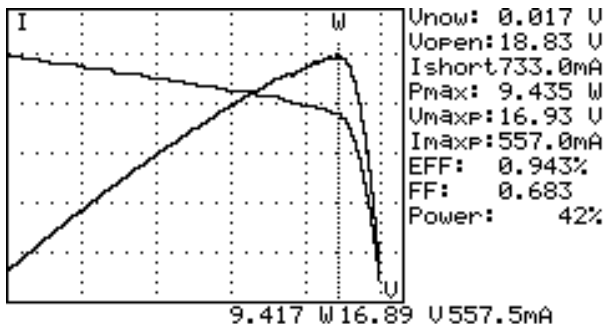

Measure the actual maximum power (P_{max}), voltage (V_{maxP}), and current

(I_{maxP}) at maximum power. Instead of using the rated maximum power, the system designer needs to be aware of the actual solar power from the solar panel under actual operating condition. So designer can actual know how many pieces of solar panels are required to generate specific power.

The voltage and current under actual operating condition (in the morning, at noon, and in the afternoon) are required for system designer to design the optimal charging system, so most of the solar power can be absorbed and stored in the battery.

Users can test the characteristics of solar panel at different time of day and store the data. Then design can know if the solar system can generate appropriate power at any time.

Example B: Maintenance of Solar Panels

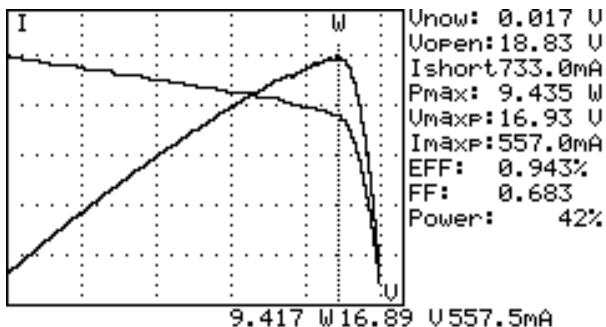

Abnormal I-V Curve (Cells at the corner of solar panel are defected)

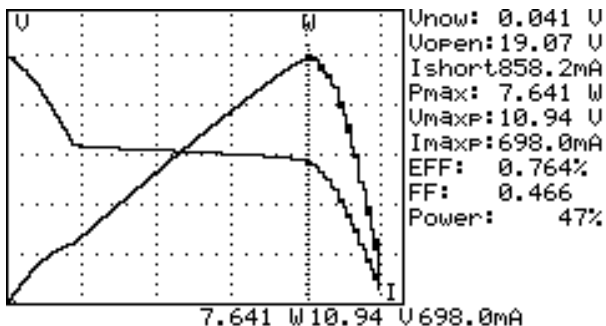

Abnormal I-V Curve (defected cells scattered over the solar panel)

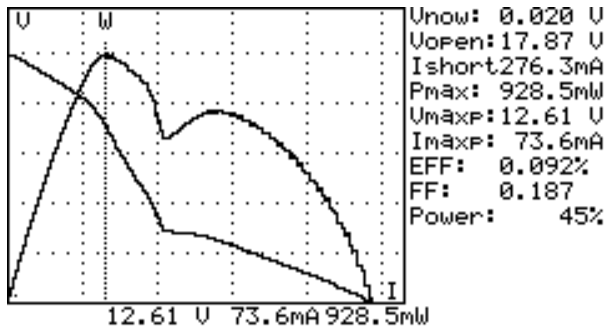

The technicians or maintenance engineers can store the characteristics data of solar panels in the beginning. And compare the characteristics data in the weekly, monthly or yearly maintenance. If the characteristics of any solar panels are different from the previous data, technicians or maintenance engineers can further identify the problems of solar panels.

For example, if any cells of solar panels are damaged, the I-V curve would be very different from a typical curve. If the solar panels are covered by a lot of dust, the I-V curve or the maximum power would be much lower than previously stored data. Once defected panels are found, technicians or maintenance engineers can replace them with new panels.

Example C: Verify the Best Installation Angle of Solar Panels

Engineers can collect data of installation angle at different date and time by using the unit at site of installation. The data can be used as reference to design automated angle adjustment system. Or the data can be used to select an optimal angle for a fixed angle installation.

Feature

- I-V Curve Test for Solar Cell.
- Single Point I-V Test.
- Maximum Solar Power (Pmax) search by auto-scan.
- Maximum Voltage (Vmaxp) at Pmax.
- Maximum Current (Imaxp) at Pmax.
- Voltage at open circuit (Vopen).
- Current at short circuit (Ishort).
- I-V curve with cursor.
- Efficiency (%) calculation of solar panel.
- Scan delay setting. (0 ~ 9999 mS)
- Solar panel area setting. (0.001 m² ~ 9999 m²)
- Standard light source setting. (10 W/m² ~ 1000 W/m²)
- Min. power setting for alarm function.
- Built-in Calendar Clock.
- Rechargeable batteries with built-in charging circuit.
- RS232C (to USB Bridge) cable for PC.
- Option: portable thermal printer (model: 300XP) to print (hardcopy) the LCD displays of Solar Module Analyzer.

OPERATION

Preparation

This Solar Module Analyzer uses rechargeable batteries. Before using new rechargeable batteries, please charge them first for 10~12 hours continuously for better battery life. The charging steps are:

1. Unscrew and remove the battery cover.
2. Put in new recharging batteries (pay attention to the correct polarities).
3. Replace and screw the battery cover.
4. Connect the provided AC Adaptor.
5. Turn on Solar Module Analyzer and press BATTERY CHARGE button to start battery charging.
6. During recharging, LCD displays "Power: Charge".
7. It takes at least 10~12 hours to charge batteries. Please do not interrupt the charging process during this period.

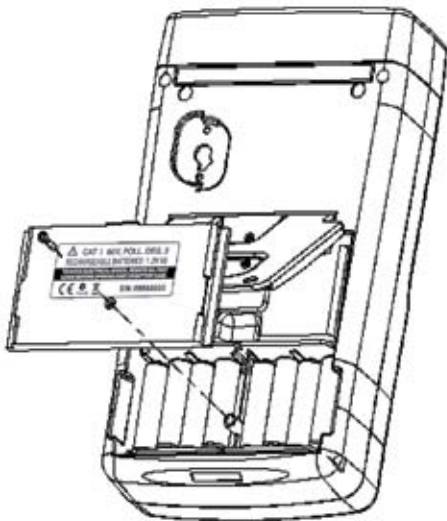

Precaution

⚠ WARNING!

when users see "Overheated" warning shown in LCD

1. Users must wait during this "Overheated: cooling" period before they start next simulation.
2. And if users would like to turn the unit off, they must wait for another 3 min. (at least) for the cooling fan to cool off the internal components.

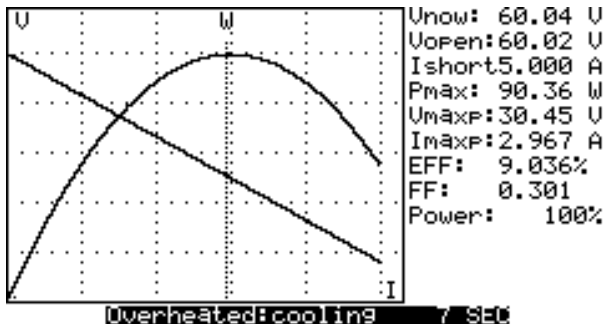

Connecting Diagram

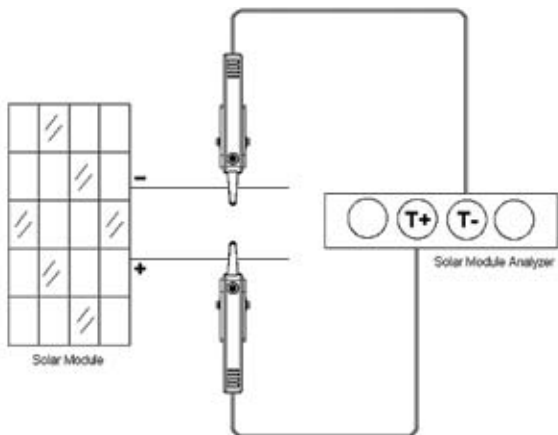

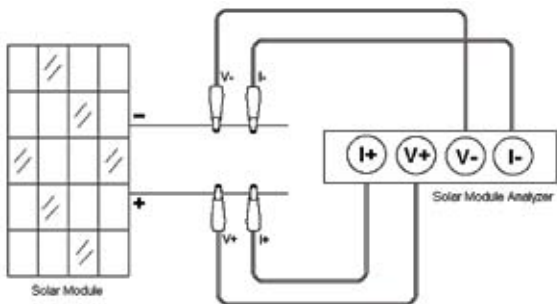

Kelvin Clip Connecting Diagram



Alligator Clip Connecting Diagram

Selected Condition of Auto Scan, Manual Scan, or Test

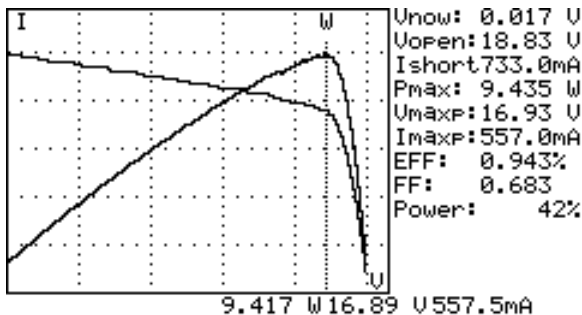

Users should first select **AUTO SCAN** () to obtain a general idea of characteristics of a solar panel.

1. Press  button to turn on the Analyzer. Properly connect the pair of Kelvin clips to the solar panel and the Analyzer. The red Kelvin clip is for positive pole and the black Kelvin clip for negative pole.
2. Press  button to start **AUTO SCAN**. After the scanning is finished, the result will come out like below.



Afterward, if users are interested in a specific operating range, they can enter the beginning and ending values of scan in the setup menu.

Press **SCAN** () button to test the specific range.

1. Press  button to turn on the Analyzer. Properly connect the pair of Kelvin clips to the solar panel and the Analyzer. The red Kelvin clip is for positive pole and the black Kelvin clip for negative pole.
2. Press  button to enter the SETUP menu: (Type in the current range for scanning)

Current Range of Scan begin: 200mA

Current Range of Scan end: 548mA

After setting up the current range, press  button again to exit the SETUP menu.

Note: If the "Current Range of Scan begin" is over "Ishort", then the scanning will not be performed and no result will come out.

3. Press **SCAN** button to start **MANUAL SCAN**. After the scanning is finished, the result will come out like below.

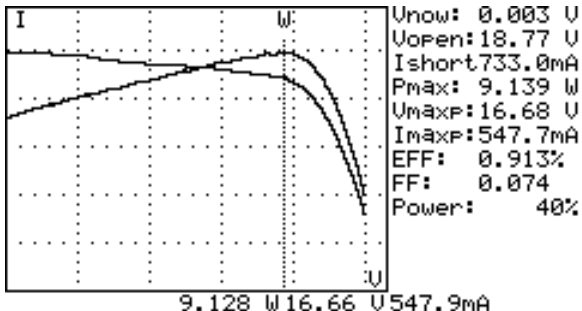

If users are interested in a specific point of test current, users can enter the current value for a Single Test Point. Press **TEST** (**TEST**) to test the characteristics at the current.

1. Press **0** button to turn on the Analyzer. Properly connect the pair of Kelvin clips to the solar panel and the Analyzer. The red Kelvin clip is for positive pole and the black Kelvin clip for negative pole.
2. Press **SETUP** button to enter the **SETUP** menu: (Type in the testing current)



Single Test Point: 609mA

After setting up the current range, press **SETUP** button again to exit the **SETUP** menu.

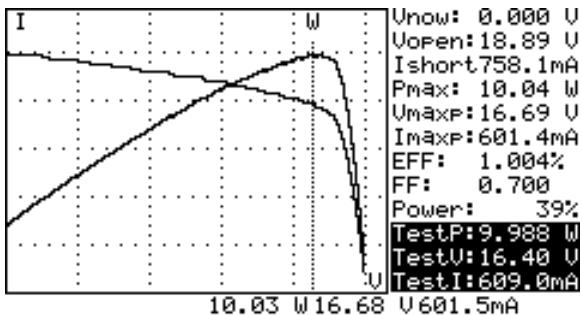
3. Press **TEST** button to start Testing a Single Test. After the testing is finished, the result will come out like below. The result (P, V, I) is shown in reverse video as below.



Auto Scan

1. Press  button to turn on the Analyzer.
2. Properly connect the pair of Kelvin clips to the solar panel and the Analyzer. The red Kelvin clip is for positive pole and the black Kelvin clip for negative pole. (refer to above Connecting Diagram).
3. Turn on standard light source and let it illuminates solar panel uniformly.
4. Press  (**AUTO SCAN**) button to perform Auto-scan. After the scanning is finished, the result will come out like below.
5. The unit automatically measures the followings parameters: V_{open} , I_{short} , P_{max} , V_{maxp} , and I_{maxp} . Based upon those parameters, the unit run simulation and draw I-V / V-I curve and P-V / P-I curves in LCD.
6. Users can move the cursor to review each individual values along the curve.

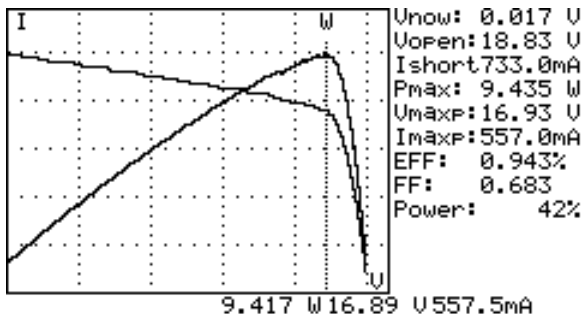



⚠ WARNING!

There is a time delay before the unit performs the "Auto Scan". This time delay allows the light source to be turned on before "Auto Scan" starts. Time delay can be set in the SETUP menu.

Note: If the short circuit current (I_{short}) exceeds 6A, Auto Scan will not be performed. Please select Manual Scan and limit the ending value of Scan to be less than 6A.

Manual Scan

1. Press  button to turn on the Analyzer.
2. Properly connect the pair of Kelvin clips to the solar panel and the Analyzer. The red Kelvin clip is for positive pole and the black Kelvin clip for negative pole.
3. Press  button to enter the SETUP menu: (Type in the current range for scanning)

Current Range of Scan begin: 200mA

Current Range of Scan end: 548mA

After setting up the current range, press  button again to exit the SETUP menu.

Note: If the "Current Range of Scan begin" is over "Ishort", then the scanning will not be performed and no result will come out.

4. Press  (SCAN) button to start MANUAL SCAN. The analyzer run simulation from the BEGIN value to END value, and draw I-V / V-I curve and P-V / P-I curve in LCD. Users can move the cursor to review each individual values along the curve.

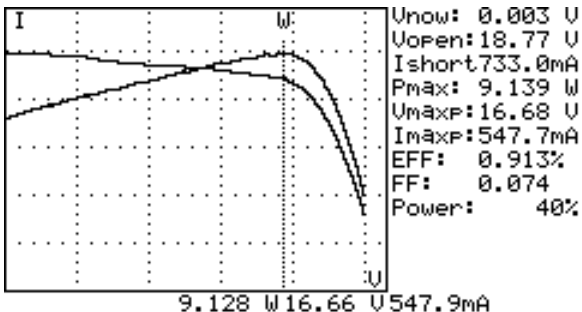

After the scanning is finished, the result will come out like below.



⚠WARNING!

There is a time delay before the unit performs the "Manual Scan". This time delay allows the light source to be turned on before "Manual Scan" starts. Time delay can be set in the SETUP menu.

Single Point Test

1. Press  button to turn on the Analyzer.
2. Properly connect the pair of Kelvin clips to the solar panel and the Analyzer. The red Kelvin clip is for positive pole and the black Kelvin clip for negative pole.
3. Press  button to enter the SETUP menu: (Type in the current range for scanning)

Single Test Point: 609mA

After setting up the current range, press  button again to exit the SETUP menu.

4. Press  button to start Testing a Single Test. After the testing is finished, the result will come out like below. The result (P, V, I) is shown in reverse video as below.

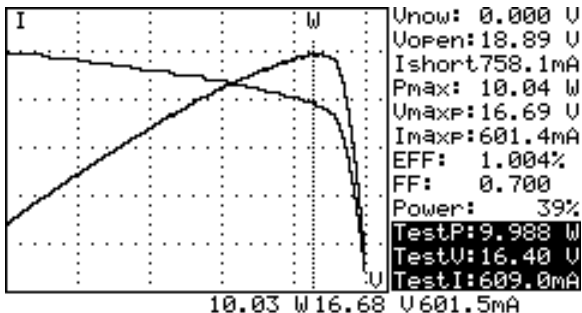

⚠WARNING!

Time delay in the "Single Point Test" allows the current simulation to last longer. Though the max. value is 9.999 sec., the time delay is changed to 10 msec. if power is over 100 W. The time delay is extended to 3 seconds if power is less than 100 mW.

Save Testing Results

When users finish a test (by taking one of the above-mentioned methods; Auto-scan, Manual-scan or Single Point Test), the testing result can be saved in the memory of the analyzer.

The procedures of saving testing results:

1. Perform a test by Auto-scan, Manual-scan or Single point test.
2. After the test is finished, press  (REC) button to save the (present) testing result on display. On the top right display it shows

REC:1 (in reverse video) which means the first record was saved.

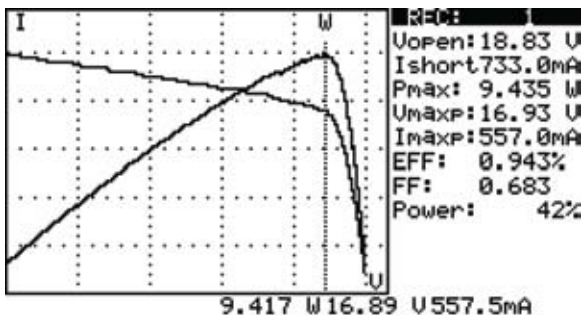



⚠ WARNING!

Please use the application software provided with the Analyzer to read the saved testing results. (refer to the Software Manual)

Clear recorded testing data

Users can clear the recorded testing data in the Analyzer.



The procedures of deleting saved data:

1. Keep pressing  (REC) button and turn on the Analyzer (i.e. press  button) at the same time.
2. After turning on the Analyzer, all the data recorded in the Analyzer (memory) will be deleted. When the buzzer beeps twice, it means the record data is already cleared.





⚠ WARNING!

After performing this CLEAR function, all the recorded data in Analyzer (memory) will be deleted completely and can not be restored. If it is necessary to keep the testing data, please use the Application Software to download and save them before deleting them from the Analyzer. (refer to the Software Manual)

Setup Menu

1. Press  (SETUP) button to enter the Parameter Setting screen.
2. Press  or  buttons to select the setting items.

Time delay before scan: 2000mS						U1.00
Current Range of Scan begin: 900.0mA						
Current Range of Scan end: 99.9mA						
Area of Solar Cell or Panel: 517.5 Cm ²						
Irradiance: 1000W/m ²						
Single Test Point: 500.0mA						
Alarm of Low Power: 99.88 W						
Year	Month	Date	Hour	Minute	Second	
2008	11	10	8	46	40	

- (1) Time delay before scan
 - (2) Current Range of Scan begin
 - (3) Current Range of Scan end
 - (4) Area of Solar Cell or Panel
 - (5) Irradiance
 - (6) Single Test Point
 - (7) Alarm of Low Power
3. Press  or  buttons to select the setting items.
Press  or  buttons to change the setting values, or press them for few seconds to promptly change setting values.
 4. After setting Parameters, press  button to exit SETUP menu.

SPECIFICATION

General Specifications

Battery Type : Rechargeable, 2500mAh (1.2V) x 8

AC Adaptor : AC 110V or 220V input
DC 12V / 1 ~ 3 A output

Dimension : 257(L) x 155(W) x 57(H) mm (10.1 (L) x 6.1 (W) x 2.2 (H) in)

Weight : 1160g / 40.0oz (Batteries included)

Operation Environment : 0°C ~ 50°C (32°F ~ 122°F), 85% RH

Temperature Coefficient : 0.1% of full scale / °C (<18°C or >28°C)

Storage Environment : -20°C ~ 60°C (-4°F ~ 140°F), 75% RH

CE - EMC: EN 61326-1: 2006
- LVD: EN 61010-1: 2001

This product complies with requirements of the following European Community Directive: 2004/108/EC (Electromagnetic Compatibility) and 2006/95/EC (Low Voltage). However, electrical noise or intense electromagnetic fields in the vicinity of the equipment may disturb the measurement circuit. Measuring instruments will also respond to unwanted signals that may be present within the measurement circuit. Users should exercise care and take appropriate precautions to avoid misleading results when making measurements in the presence of electronic interference.

Electrical Specifications (23°C ±5°C, Four-wire Measurement)

DC Voltage Measurement		
Range (60V / 6A)	Resolution	Accuracy
0 ~ 6 V	0.001 V	± 1 % ± (1 % of Vopen ± 9 mV)
6 ~ 10 V	0.001 V	± 1 % ± (1 % of Vopen ± 0.09 V)
10 ~ 60 V	0.01 V	± 1 % ± (1 % of Vopen ± 0.09 V)

Vopen: open circuit voltage of solar cell or module.

If users use alligator clips to measure voltage only (I+ clip is not connected), clips (V- and I-) must be shorted together. Thus, 4-wire measurement is converted to 2-wire measurement.

DC Current Measurement		
Range (60V / 6A)	Resolution	Accuracy
0 ~ 0.6 A	0.1 mA	± 1 % ± (1 % of Ishort ± 0.9 mA)
0.6 ~ 1 A	0.1 mA	± 1 % ± (1 % of Ishort ± 9 mA)
1 ~ 6 A	1 mA	± 1 % ± (1 % of Ishort ± 9 mA)

Ishort: short circuit current of solar cell or module.

Internal Resistance at Ishort: 0.05 Ohm.

Ishort is measured with internal resistance, circuit resistance, and test lead resistance.

DC Current Simulation		
Range (60V / 6A)	Resolution	Accuracy
0 ~ 1 A	0.1 mA	± 1 % ± 0.9 mA
1 ~ 6 A	1 mA	± 1 % ± 9 mA

If Current is greater than 6A, test (Auto-Scan, Scan, or Test) can not be Performed.

Maximum duration of simulation is 9.999 seconds if power is less than 100 W.

Duration of simulation is 10m seconds if power is greater than 100 W.

MAINTENANCE AND REPAIR

If there appears to be a malfunction during the operation of the meter, the following steps should be performed in order to isolate the cause of the problem.

1. Check the battery. Replace the battery immediately when LCD displays the Power is $\leq 2\%$.
2. Review the operating instructions for possible mistakes in operating procedure.

Except for the replacement of the battery, repair of the meter should be performed only by a Factory Authorized Service Center or by other qualified instrument service personnel. The front panel and case can be cleaned with a mild solution of detergent and water. Apply sparingly with a soft cloth and allow to dry completely before using. Do not use aromatic hydrocarbons, Gasoline or chlorinated solvents for cleaning.

Please remove all the batteries if users won't use the Solar Module Analyzer for a long time.

Battery Replacement / Recharging

When Rechargeable Batteries are used, please follow below steps to charge the batteries

1. Connect the AC Adaptor with the Solar Module Analyzer.
2. Turn on the Solar Module Analyzer.
3. Press the BATTERY CHARGE button to start recharging.
4. During recharging (takes 10 hours), LCD displays "Power: Charge".
5. After recharging, LCD displays "Power: 100%".
6. Remove the AC Adaptor.

⚠ WARNING!

1. *Do not use non-rechargeable batteries to perform charging.*
2. *Users are suggested to do recharging only when LCD displays the Power is $\leq 2\%$.*
3. *Do not stop recharging when it is not finished so that the battery life can be maintained.*

When regular batteries are used and LCD displays the Power is $\leq 2\%$, please replace the batteries:

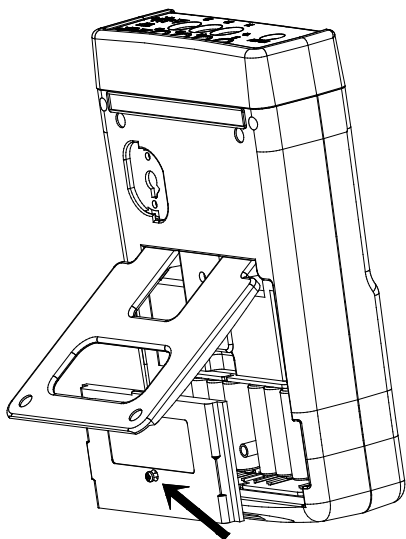

1. Turn off the Solar Model Analyzer.
2. Remove the screw of the battery cover.
3. Lift and remove the battery cover.
4. Remove the old batteries and insert eight new 1.5V SUM-3 batteries.
5. Install the battery cover and secure the screw.

Fuse Replacement

When the voltage can not be measured ($V_{\text{now}} = 0V$) after properly connecting the Analyzer and the solar panel, please check the fuse.

If the fuse is damaged (burned), please replace a new fuse by following the procedures:

1. Turn off the Analyzer and remove all the connecting wires and power sources.
2. Unscrew the battery cover. Remove the battery cover. Remove the two batteries on the furthest east and west.
3. Unscrew the (4pcs.) screws of the back cover. Remove the back cover. Remove the power connector connecting the back cover and the circuit board (J2).
4. Remove the damaged (burned) fuse.
5. Put in a new fuse of the same specifications (5A / 250V).
6. Connect the power connector. Replace and screw the back cover.
7. Replace the two batteries on the furthest east and west. Replace and screw the battery cover.

⚠ WARNING!

After removing the battery cover, please do not touch the parts on the circuit board, especially the communication LED. Or the communication function will be damaged.



Unscrew and remove the battery cover and the back cover.

Location of Fuse

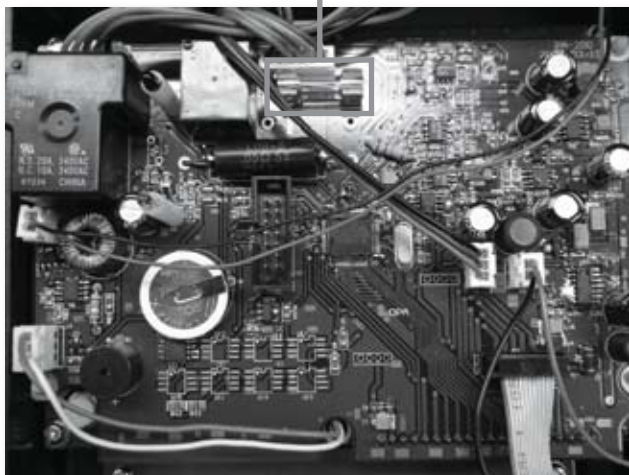

PC Connection, Software Installation And Operation

INTROODUCTION

Operating Environment

- Application program should be installed in the operation system of Microsoft Windows Vista/ XP / 2000 (SP3).
- NI-VISA Runtime Engine should be installed (Application program will install it automatically).
- USB driver program should be installed (Application program will install it automatically).

Hardware

- Personal Computer (PC): we recommend the processor of Pentium III Celeron 600MHz or above.
- RAM: min. 256MB, but we recommend 512MB of RAM or more.
- Screen resolution: requires 1,024 x 768 pixels.
- Solar Analyzer.
- USB cable.

Connecting Procedures

Step 1: Turn on PC and Solar Analyzer.

Step 2: Connect USB Cable.

Step 3: Start Application Program of Solar Analyzer.

Step 4: Select correct "Serial Port Number".

SOFTWARE INSTALLATION

Install Application Program

Execute Install.bat (which is in installation disc) to enter the procedures of installing Application Program. Please follow the instructions to install Application Program. When performing the installation of Application Program, the USB driver program and NI-VISA Runtime Engine will be installed automatically.

Remark:

1. If users have ever installed our Programs (NI-VISA) of other versions in his PC, first please (go to Control Panel to) remove them.
2. After putting the installation disc into CD-ROM drive, the application program will automatically execute the installation.
3. If the installation is not automatically executed, please choose the Install.bat program in the installation disc to perform the installation.
4. After Application Program has been installed, please Restart the system.

Install USB Driver

When performing the installation of Application Program, the USB driver program will be installed automatically.

However, if users need to manually install the USB driver program, please choose USBDriver Directory in the installation disc, click CP210xVCPInstaller.exe program (for Windows Vista / XP / 2000) to execute the installation of USB Driver.

Remark:

1. If the driver can't detect the hardware, please remove the hardware and then plug it in properly.

SOFTWARE OPERATION

Start Executing Program

Step 1: n Start -> All Programs, choose "Solar Analyzer" or click the shortcut to start executing program.

Step 2: Select the Serial Port connected to Solar Analyzer.



Remark:

1. Click **COM 1** to select the Serial Port connected to Solar Analyzer.
2. After selecting the correct Serial Port, press **Enter** to confirm it.
3. Before entering the Application Program of Solar Analyzer, please turn on PC, Solar Analyzer and properly connect the USB cable so that the Application Program can automatically set up the correct Serial Port.
4. It is necessary to perform this function only when the Application Program can't automatically set up the correct Serial Port.

Parameter Setting

Set up the parameters of Solar Analyzer.

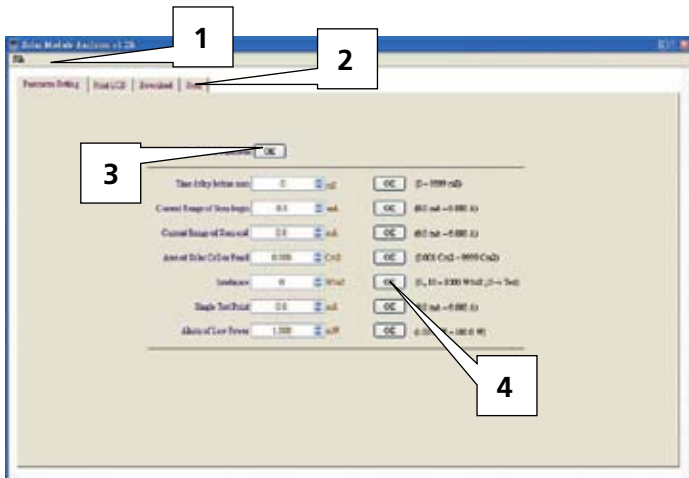

Remark:

1. Tool bar includes: Languages (Mandarin, English) and Exit.
2. Functions includes: Parameter Setting, Print LCD, Download, Scan.
3. Press the OK button on the right side of "Read ALL Parameter" to read all the present parameters of Solar Analyzer.
4. Press the OK buttons of each parameter to set up the parameters. (refer to the Manual for the description of all the parameters.)

Save/Print LCD

Save or print the present LCD data of Solar Analyzer.

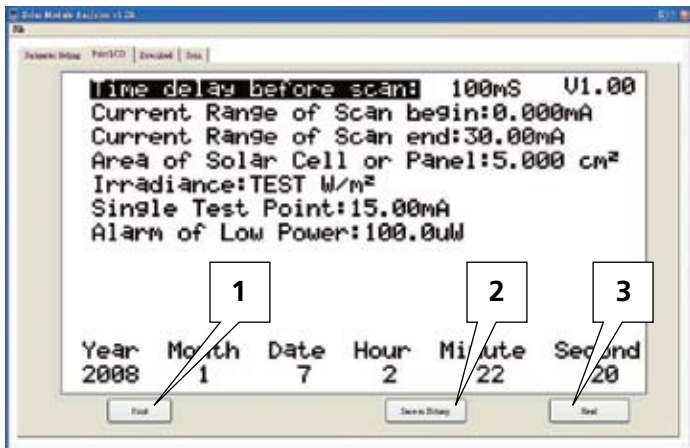

Remark:

1. Press "Read" button to read the present LCD data of Solar Analyzer.
2. Press "Save as Bitmap" to save the present LCD data as a (single-color) bitmap.
3. Or Press "Print" button to print out the present LCD data.

Download

Download the logged data in the memory of Solar Analyzer.

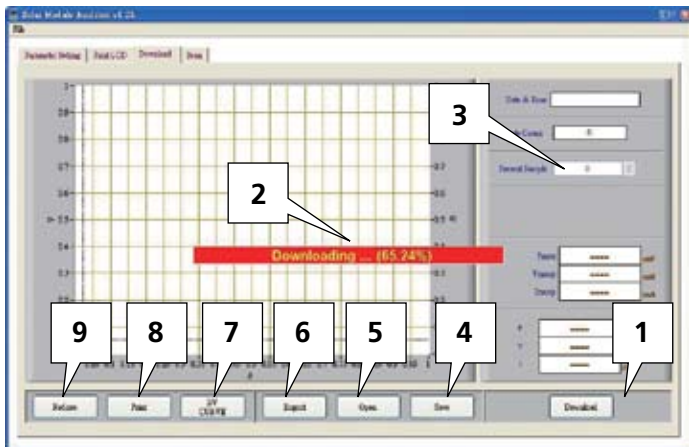

Remark:

1. Press "Download" to download the logged data in the memory of Solar Analyzer.
2. The red block in the center shows the Downloading status.
3. Press "Present Sample" to change the present sample (location) to last or next logged data. The information of the present sample will be showed on the LCD: Logged Date & Time, Pmax, Vmaxp, Imaxp, P, V, I (Power, Voltage and Current of the cursor position).
4. Save: to save the present downloaded data into PC. (file name: *.200 Data)
5. Open: to read the downloaded data saved in PC.

-
6. Export: to save/export the data (i.e. the Voltage/Current curve data) of Present Sample as/in a .CSV file for users to read in Excel.
 7. I/V CURVE: to select the X-axis of the present curves based on I or V.
 8. Print: to print out the present LCD data.
 9. Redraw: users can move the cursor in the diagram to change the cursor position. When users move the cursor and make the whole diagram disordered, they can press "Redraw" button to make the present diagram returned to the initial status.

Note:

1. After exporting logged data, they can't be read (imported) anymore. Please read them in the Excel software.
2. If it is necessary to read the logged data in the future, please be sure to perform the Save/Open (logged data) functions.

Auto Scan Solar Analyzer

Auto Scan the Solar panel to obtain measurement results

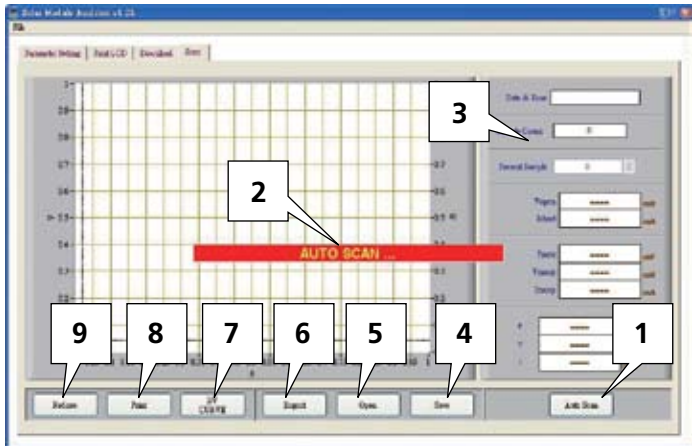

Remark:

1. Press "Auto Scan" to auto scan the solar pane.
2. The red block in the center shows the Auto Scan status.
3. Press "Present Sample" to change the present sample (location) to last or next logged data. The information of the present sample will be showed on the LCD: Logged Date & Time, Vopen, Ishort, Pmax, Vmaxp, Imaxp, P, V, I (Power, Voltage and Current of the cursor position).
4. Save: to save the present scanned data into PC. (file name: *.200 Record)
5. Open: to read the scanned data saved in PC.

-
6. Export: to save/export the data (i.e. the Voltage/Current curve data) of Present Sample as/in a .CSV file for users to read in Excel.
 7. I/V CURVE: to select the X-axis of the present curves based on I or V.
 8. Print: to print out the present LCD data.
 9. Redraw: users can move the cursor in the diagram to change the cursor position. When users move the cursor and make the whole diagram disordered, they can press "Redraw" button to make the present diagram returned to the initial status.

Note:

1. After exporting scanned data, they can't be read (imported) anymore. Please read them in the Excel software.
2. If it is necessary to read the scanned data in the future, please be sure to perform the Save/Open (scanned data) functions.

Visit www.Amprobe.com for

- Catalog
- Application notes
- Product specifications
- User manuals



Please Recycle