



The

# SIL O<sub>2</sub> Oxygen Analyser

## User Operation Manual



Rev. 1.1

30/11/2018



## Contents

1. Introduction .....	6
1.1 The purpose of this User and Operation Manual.....	6
2. Installation and Operation.....	7
2.1 Notes for a safe installation.....	7
2.2 Installation.....	10
2.2.1 Mounting the SIL O2 Analyser.....	10
2.3 Electrical and Interface Connections.....	11
2.3.1 Sensor Input and Customer Interface Wiring.....	11
2.3.2 Operational Settings and Wiring Configuration .....	12
2.3.3 Typical Relay Configuration.....	13
2.3.4 Sensor Process Connection options .....	15
2.4 Operation.....	16
2.4.1 Calibration Procedures.....	16
2.4.2 Setting the Zero point. ....	17
2.4.3 SPAN Calibration .....	18
.....	18
3. Operational safety and maintenance instructions.....	19
3.1 Fault conditions.....	19
3.2 Wire break.....	19
3.3 System faults .....	19
3.4 Troubleshooting .....	20
Possible Faults and their solutions.....	20
3.4.1 Possible Sensor Faults .....	21
3.5 General Maintenance .....	22
4. Specifications.....	23
5. Appendices .....	26
5.1 SIL O2 Analyser and Sensor Connection Diagrams .....	27
5.2 SIL O2 Analyser CE and ATEX Certificates.....	28
5.3 Sensor CE and ATEX Certificates .....	29

<b>Revision History</b>		
<b>Revision No.</b>	<b>Change Description</b>	<b>Date</b>
0	First Issue	19-10-2018
1	Note added for Non-ATEX Sensor usage	22-10-2018
1.1	Reference to 15% O2 in trouble shooting section removed.	30-11-2018
	Calibration Span instruction amended and note added	



## 1. Introduction

The Ntron SIL O<sub>2</sub> Analyser is a ATEX approved SIL 2 rated Oxygen measuring instrument. It contains three programmable alarm settings, industry standard Analogue Output(active source) and a non-programmable safety trip relay. The range of operation is 0 to 25% Oxygen. The Resolution is to 0.01%.

Together with one of the range of Ntron ATEX approved Oxygen Sensors, it forms a SIL2 rated measurement unit which can operate on its own or as part of a larger installation.

**Note. Non-Atex (Ex) Sensors variants of the models listed in the manual may also be used with the SIL O<sub>2</sub> Analyser as long as they are installed in a Non-ATEX (Ex) or ,Safe' area or zone.**

The Alarm settings are typically factory set according to the end user's requirements. Interface software and hardware is available for the user to perform such functions themselves. Contact Ntron for further details.

### 1.1 The purpose of this User and Operation Manual

This Manual is limited to providing the user with necessary details on installation, interface wiring, operation and maintenance of the SIL O<sub>2</sub> Analyser and Oxygen Sensor, to ensure safe and reliable operation of this Analyser and Sensor unit.

**Note: This manual does not cover the design or application of a safety Instrumented System (SIS) into which the SIL O<sub>2</sub> Analyser unit may be incorporated. Further details of this can be obtained in the [Ntron SILO<sub>2</sub> Technical and Safety Manual](#).**

#### The main user interface features

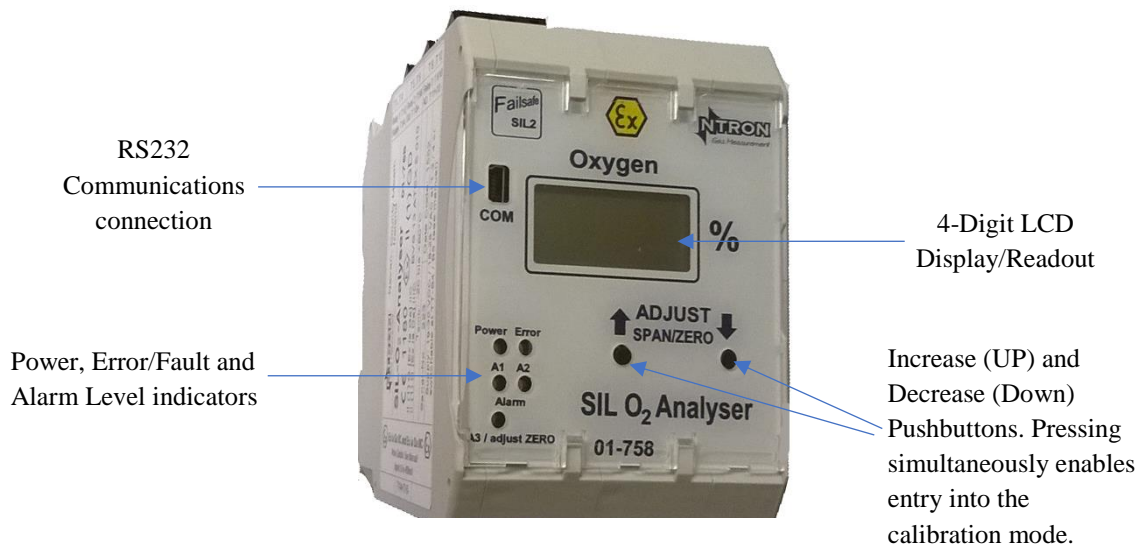

## 2. Installation and Operation

**Note: For system application information, consult the SIL O2 Analyzer Technical User Manual**

### 2.1 Notes for a safe installation



Please do not short-circuit the + and -ve sensor cables while connecting to the SIL O2 Analyzer. This could damage the sensor.

This system can also be used in a non-Ex area application. In all applications, the SIL O2 Analyzer Din rail module is always located in the non-Ex area!



Assignment of the mounting rail housing terminals with intrinsically safe circuits and non-intrinsically safe circuits is indicated on the nameplate and is clearly indicated. In addition, the 4-pin terminals of intrinsically safe circuits follow the standard color protocol for intrinsically safe terminal connections and are coloured Blue. Connections for intrinsically safe external circuits are arranged in such a way that, in accordance with EN 60079-11, the exposed parts are at least 50 mm from the exposed connections and parts of the non-intrinsically safe circuits.

For safe operation, a protective ground/earth connection to terminal 13 or 15 should be made.

Assembly / disassembly, installation, operation and maintenance may only be performed by qualified personnel in accordance with regulatory requirements and the SIL O2 Oxygen Analysis Manual.



During installation, the technical data and the electrical values of the connected circuits must be respected.

Electrical supply. The SILO2 Analyser operates with an Extra low Voltage (ELV) supply. (See specification section in this manual) No special precautions are necessary but the ELV supply to the SIL O2, if generated from a Mains power source, that mains power source and associated wiring must be in accordance with IEC/EN standards and is the responsibility of the user to provide and to ensure correct and safe installation of such.

When the SIL O2 analyzer is integrated into another system, also refer to the system manual for additional operational information.

The Ntron SILO2 Analyser is designed for use with a range of Ntron ATEX certified Oxygen Sensors to form a measurement system. These Sensor options are detailed in the Specification section of this manual.

If the SIL O2 Analyser has been supplied with a Sensor, the two units will have been calibrated at the Ntron factory prior to delivery. Otherwise, if a Sensor is supplied separately from the SIL O2 Analyser, a calibration will be required prior to putting the system into operational service.

The Ntron Sensors suitable for use with the SIL O2 analyser are listed in the Installation section which follows.





The SIL O2 oxygen analyzer is an associated explosion-proof [Ex ia] IIC or [Ex ib] IIC electrical device and should always be used outside potentially explosive areas (in a safe area). Only electrical circuits, certified as intrinsically safe, can be connected to other intrinsically safe circuits in the Ex zone.

Before operation, the intrinsic safety must be verified for the SIL O2 oxygen analyzer circuit connected to the circuit of other equipment, including the interconnecting cabling.

The data contained in the EC test certificate and the regulations of EN 60079-14: 2011-10 must be observed.

The Sensors are ATEX rated devices and have certain conditions of use assigned.

**Note. Non-Atex (Ex) Sensors variants of the models listed in the manual may also be used with the SIL O2 Analyser as long as they are installed in a Non-ATEX (Ex) or ,Safe‘ area or zone.**

For Acetal-bodies Sensors, the following instructions apply;



The Sensor should be installed in such a way that it is not subject to impact by other objects and should not be located close to additional heat sources. Note the ambient temperature range as it appears on the Sensor labelling.



Care must be taken when installing equipment with plastic enclosures or plastic parts of enclosures to ensure that the equipment is protected from any situations that could cause a build up of static charge. The equipment must not be installed into locations in which it could come into contact with, through normal or abnormal circumstances, fast moving dust laden air/gas or non-conductive fluids. The equipment must be cleaned only with a damp cloth.

## 2.2 Installation

The installation must be in accordance with the local electrical codes and taking into account the details in the Specification section of this manual.

The SIL O2 analyzer is designed for DIN rail mounting and can be supplied mounted in an additional enclosure or provided without an additional enclosure for customer mounting in a system enclosure or control panel.

The Sensor option chosen will determine the process connection/installation for that Sensor type. The Sensor types and related process connections are given below.

### Sensor Type:

Model OC-25

Model OC-26

Model OC-200 'Oxyprobe' series

### Process Connection:

Ntron Sensor base, Flow Through or Tri-Clamp

KF40 Flange

Bushing insert or Extract\* Probe Holder

The Sensor is typically supplied with a corresponding connection cable of either standard length or to a customer specified length.

\*The Ntron OxyExtract Manual or Automatic probe insertion mechanism.

### 2.2.1 Mounting the SIL O2 Analyser

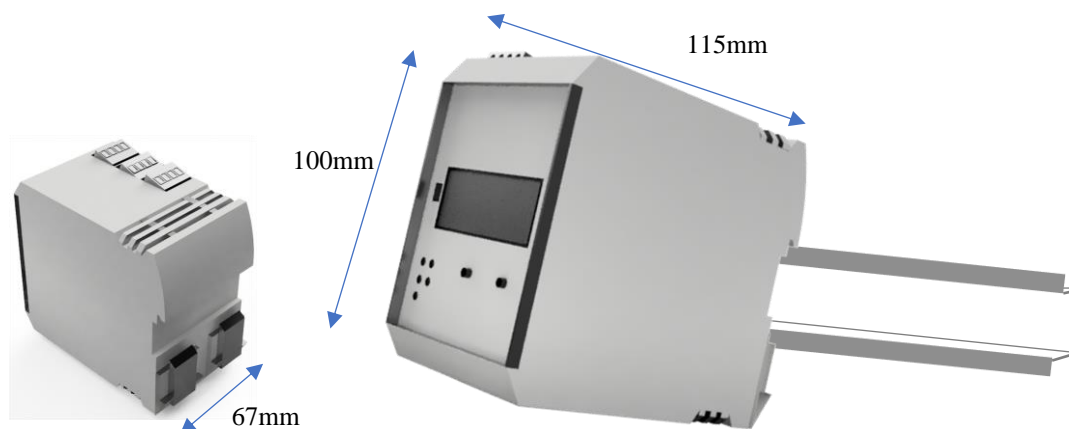

Mount the SIL O2 Analyser onto 35mm DIN rail as shown. Any Trunking/wireways above and below the Analyser when in situ, must be positioned so that there is a minimum of 30mm clearance between such trunking and the Analyser connection terminals.

## 2.3 Electrical and Interface Connections

### 2.3.1 Sensor Input and Customer Interface Wiring

The Ntron ATEX Sensor selected for use with the SIL O2 Analyser as listed in the Installation section previously, has intrinsically safe parameter values which match the Isolation Barrier output which is built into the SIL O2 Analyser. The Sensor connects to the Blue terminals as shown below.

The dark Grey terminals are for safe (Non-Ex area) customer interface connections. See the configuration section on the following page.

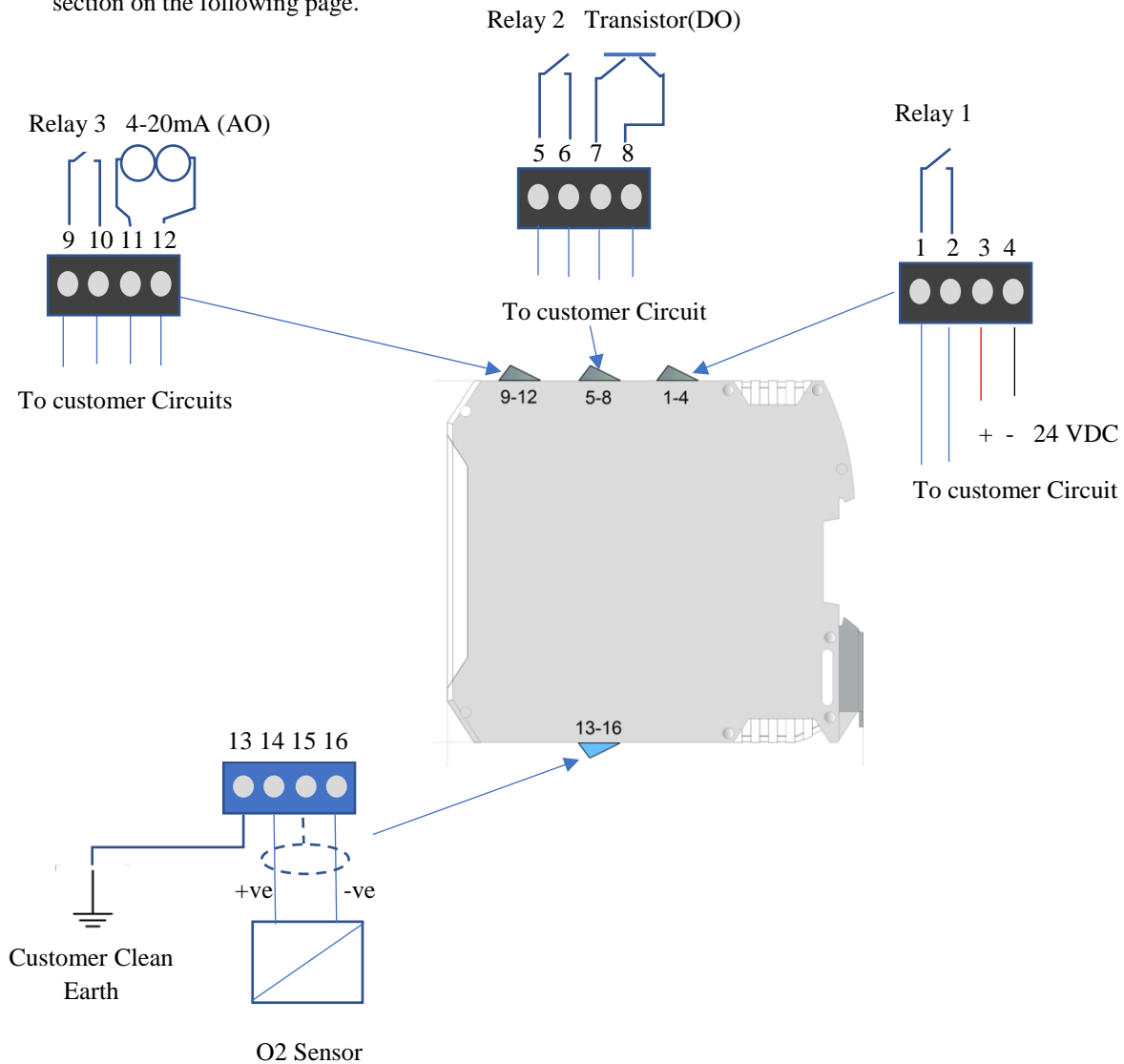

### 2.3.2 Operational Settings and Wiring Configuration

The SIL O2 Analyser has two presettable alarm levels and associated Relays, referred to as RL1 and RL2. It also has a third presettable alarm level with an associate Transistor Digital Output (DO) The programmed setting of these outputs can vary depending on application. The Inspection and Calibration certificate supplied with each SIL O2 Analyser and Sensor unit will detail these settings. See the Ntron SIL O2 Technical and Safety manual for further details.

The SIL O2 Analyser has a main trip Relay referred to as RL3. This is not programmable and is normally open(contacts)/de-energised when the Analyser is not under power. The Relay energises and its associate contacts close when power is applied and the Analyser and Sensor are healthy and ready to operate.

The Analogue output is an industry standard 4-20mA active source output. The connected circuit should be of maximum resistance 420 ohm.

To meet the SIL 2 operational requirements as an Analyser and Sensor unit, the main trip Relay is required to be connected in series with other elements within the Analyser as shown in the diagrams below. For any other configurations, [See the Ntron SIL O2 Technical and Safety manual for further details.](#)

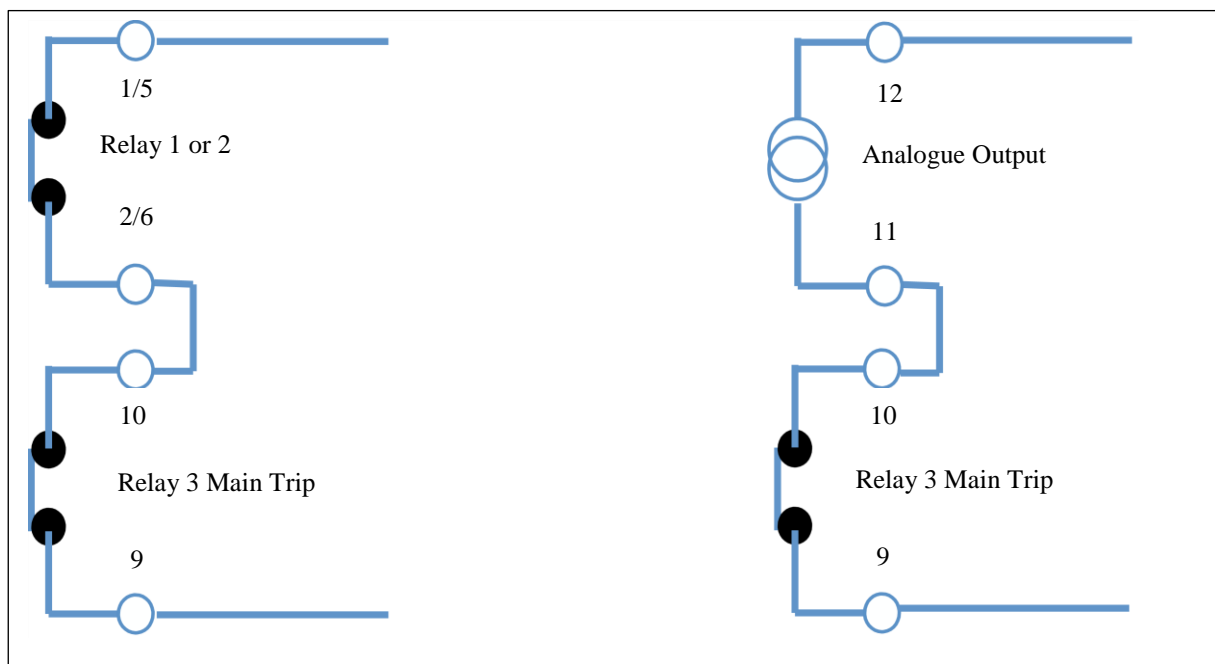

#### **\*Special case for use of the 4-20 mA analogue output within a safety system**

When using the 4-20 mA analogue output from the SILO2 Oxygen Analyser within the safety system, this signal would typically be required to be processed by a safety PLC which would then activate the Final Trip Element. [See the Ntron SIL O2 Technical and Safety manual for further details.](#)

### 2.3.3 Typical Relay Configuration

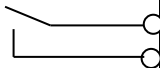
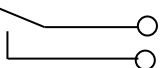
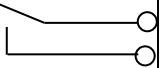
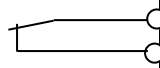
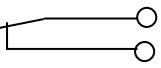
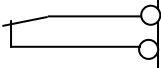
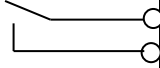
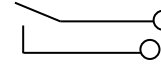
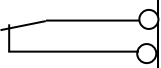
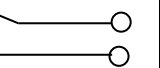
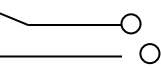
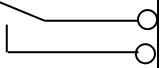
Power to the Analyser	Relay Contact 1	Relay Contact 2	Relay Contact 3	Comments
<b>Power Off (All relay contacts in Fail Open condition)</b>				<b>Relays De-energised</b>
<b>Power on and system good/healthy</b>	** 	** 		<b>All Relays Energised</b>
<b>Power on and O2 alarm level(s) reached</b>	* 	* 		<b>Relays 1 &amp; 2 De-energised</b>
<b>Power on and System fault</b>	** 	** 		<b>All Relays De-energised</b>

These relays are programmed to respond to the measured Oxygen level setpoints (Alarms), rising or falling in the range 0-25% Oxygen. These are pre-set to the customer's requirements.

They operate in 'Fail Safe' mode which means that they are energized (under current), presenting a closed contact to the customer/user when the SIL O2 module is under power and the status is healthy/good.

When at a level setpoint (Alarm) or when the SIL O2 module is not-powered, the relays are de-energised (not under current), presenting an open contact to the customer/user. This is also known as 'Fail Open' (FO) condition.

#### Transistor (DO)

This is an NPN device that can switch 24VDC and can be configured to be normally open or normally closed.

#### Analogue 4-20mA

This is an active output and requires connection to a passive external circuit suitable for proper operation.

It is set to the range 0-25% Oxygen / 4-20mA (0% Oxygen = 4mA, 25% Oxygen = 20mA.)

This range can not be adjusted.

If the 4-20 mA output is not used, the SIL O2 terminals T11 and T12 must be wired by the user. This output is internally connected in series with the SIL O2 Analyzer digital display, which will not work if the aforementioned terminals are in open circuit!



### 2.3.4 Sensor Process Connection options

The Sensors are suitable for mounting directly onto process Lines via a selection of process fittings. The electrical signal connectors are rated to IP67.

**OC-25 Sensor**



**Tri-Clamp Sensor Base**



**Flow Through Sensor Base**



**OC-26 Sensor KF40 Process fitting**

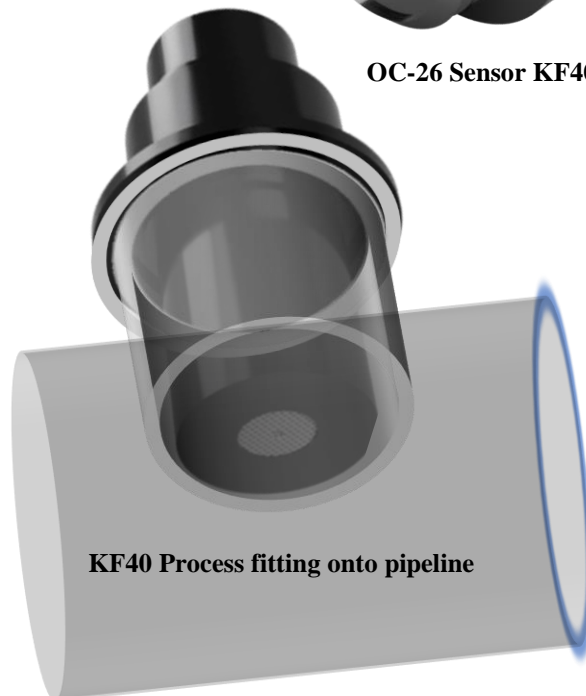

**KF40 Process fitting onto pipeline**



**OC-200 Sensor with Screwed Bush Process fitting**

## 2.4 Operation

Before turning on the SIL O2 analyzer for the first time or after disconnecting the sensor for maintenance / replacement, make sure that a working sensor is connected. Otherwise, the SIL O2 analyzer will go into failure mode, with the red error indicator on and the RL3 relay disabled. As the fault circuit performs a cyclic check every 30 seconds or so. When the sensor is connected, resetting the red indicator and relay 3 occurs automatically, but it is advisable to power off the system to allow the sensor to be disconnected / reconnected under normal circumstances, if possible.

Turn on/apply power to the SIL O2 Analyser.

When operating under normal process/system conditions, the SIL O2 Analyser will give a digital readout of the measured Oxygen level (from the Sensor in the process).

This measurement is converted into a 4-20mA output signal proportional to the Oxygen being measured.

If an Alarm level even occurs, the relevant programmed output device will operate (Relay or Transistor) and the ineterface circuit to the user equipment will be interrupted. For further alarm or fault events and their conditions, please see the troubleshooting section at the end of this Manual.

### 2.4.1 Calibration Procedures

The SIL O2 Analyser and Sensor unit requires periodic calibrations performing, the timing between such calibrations being determined by the application and process requirements.

Typically, a periodic calibration check would reveal if any calibration adjustment is necessary. The SPAN calibration point of 20.9% O2 (Air) is the important setting and typically, if calibration adjustment is required, this is the value that would be adjusted. This adjustment can be made ussing ambient air as the calibration standard or, for greater accuracy, certified cylinder gas at 20.9% O2.

It is possible to also adjust the Zero point of the SIL O2 Analyser. Typically this would only be required when fitting a new/replacement Sensor. A Complete calibration procedure is given below.

Note: Calibration Adjustment procedure.

**The displayed number change starts with the digit to the far right of the decimal point. Press and hold the Up or Down buttons to change the reading. This gives an accelerated adjustment. More accurate adjustment is achieved by pressing the Up or Down button at one press (press release, release of press, etc.). When the display reads 20.9%, the calibration of the range is complete**

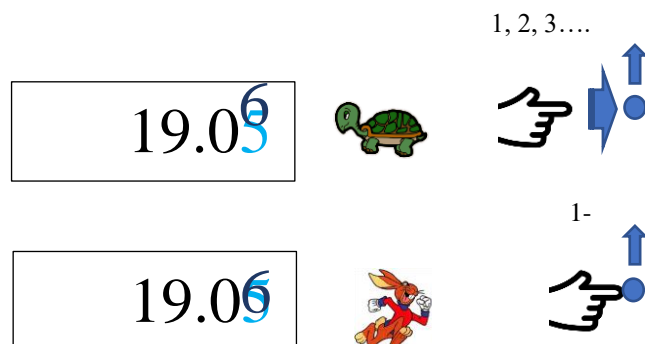



### 2.4.2 Setting the Zero point.

This must be done each time a new sensor is installed before a span calibration is performed.

Subsequently, a zeroing can be performed periodically as needed.

A zeroing operation requires the application of a zero oxygen gas to the sensor, typically nitrogen (minimum quality <100 ppm). Note: Accessing the Zero function when the sensor is in ambient air (20.9% O<sub>2</sub>) will result in an error / fault condition.

Depending on the type of sensor installed, zero gas must be applied through a process fitting or calibration adapter, and be sure to leave a free exhaust at a suitable location so that the sensor does not become pressurized.

The sensors to be used with the SIL O<sub>2</sub> unit will generally give a small output at zero oxygen levels. The zero adjustment function allows the user to adjust this small signal so that the SIL 2 analyzer displays 0.0 when no oxygen is present in the measured gas.

- ZERO mode is activated after pressing the UP and DOWN button simultaneously for more than one second. As an acknowledgment of receipt, the A3 LED flashes. An adjustment of the indicated value is made by pressing the UP or DOWN buttons individually as required.
- The change starts with the digit to the right of the decimal point. (00.0) Press and hold the Up or Down buttons to change the displayed reading. This allows an accelerated adjustment. Accurate adjustment is achieved by pressing the Up or Down button at one press (press release, release of press, etc.). When the display reads 0.0% O<sub>2</sub>, the setting is complete. By simultaneously pressing the two buttons or a delay of 20 seconds, the ZERO operating mode ends.

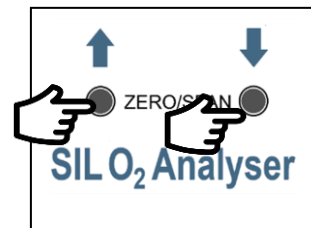

0.00

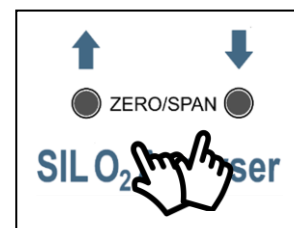

### 2.4.3 SPAN Calibration

This can be done periodically or as needed in accordance with the requirements of the calibration protocol.

Calibration can be performed by applying either clean ambient air or a 20.9% certified oxygen rate to the sensor.

Note:

- The SIL 2 analyzer should only be calibrated at approximately 20.9% oxygen.
- If an ambient air calibration is performed, it is recommended to confirm the oxygen level with a certified portable oxygen analyzer prior to calibration.
- If a zero setting is made first, then after the end of the zero operation mode, the Span mode is automatically activated after a delay of 20 seconds.
- **If A Span only calibration is required, then just press the UP or DOWN buttons individually to increase or decrease the displayed value of oxygen to read 20.9. Note: Ensure the Sensor is in 20.9% oxygen when you do this!**



20.90

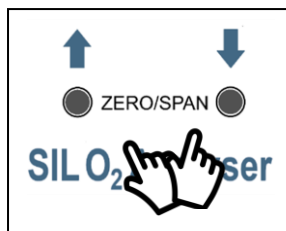

- Calibration complete.

### 3. Operational safety and maintenance instructions.

If it is assumed that safe operation is no longer possible, the device must be taken out of service and protected against accidental use. The reasons can be:

visible damage to the device

failure of the electrical function

long shelf life at temperatures above 85 ° C

Transport damage

Before the device can be put back into service, a professional routine check must be carried out in accordance with DIN EN 61010, part. 1. This examination must be carried out by the manufacturer. Repair work on Ex devices may only be carried out in accordance with § 9 of Ex. (Elex V).

#### 3.1 Fault conditions

The SIL O2 Analyzer failure operation is not locked out by a fault. When a fault condition is repaired, the trip relay RL3 and the red fault indicator will return to their "healthy" or "operational" state after a few seconds following an automatic internal cyclic check.

#### 3.2 Wire break

When manually disconnecting the sensor (for example for maintenance) or following a break in the sensor connection cable, the SIL O2 Analyzer RL3 fault relay switches off and interrupts the safety circuit.

The red fault indicator will illuminate on the SIL O2 analyzer and the 4-20 mA analog output will reach a constant high value of 22.0 mA. At the same time, the setpoint relays RL1 and RL2 will be deactivated.

When the sensor is reconnected or the cable fault is corrected, the RL3 relay automatically resets after about 30 seconds and the red LED goes out. At the same time, RL1 and RL2 are reset according to their setpoints and the measured gas level. See also note on page 13 of this manual for reset requirements under specific conditions.

#### 3.3 System faults

A number of internal faults in the SIL O2 analyzer generate a fault output and interrupt the safety circuit. In some cases, cycling the power supply of the SIL O2 analyzer may be sufficient to remedy the problem. Otherwise, please contact Ntron for assistance.

## 3.4 Troubleshooting

### Possible Faults and their solutions

The following possible conditions are applicable to a system (Sil Analyser and Sensor) already installed and commissioned. Some conditions below may also be applied to new systems not yet commissioned.

- **Action: Performing a Zero calibration when the Oxygen Sensor is in ambient air.**



**Problem:** An incorrect Zero level input to the Analyser will result in an overrange fault. This can occur if a Zero calibration is performed when the Sensor is in ambient air. If this occurs, the Red fault LED will illuminate and the Analyser display and Analogue output will read an over-range value. The Alarm level LED's may also illuminate. This may also occur if a genuine overrange event takes place, with gas containing more than 25% O<sub>2</sub> being applied. (25% O<sub>2</sub> displayed)

**Solution:** re-calibrate with Nitrogen gas (Zero) and then re-calibrate at the Span point of 20.9%.

- **Action: Powering on the Analyser with no sensor connected or a wire break to the sensor.**



**Problem:** If the sensor is disconnected, this would ordinarily cause relays R1, R2 and R3 to de-energise. Analyser display and Analogue output will read a fault value. (28% O<sub>2</sub> displayed and 22mA output)

**Solution:** Check Sensor wiring and connect the sensor to the Analyser. After approximately 30 seconds, the Analyser will reset and the Red LED should extinguish.

- **Action: Unable to perform a Span calibration.**



**Problem:** The Analyser cannot be adjusted to display 20.9% O<sub>2</sub> during Span calibration.

**Solution:** The Sensor may be approaching end of life or has been damaged and cannot generate sufficient output. Replace the sensor

Alarm level LED's may or may not be illuminated depending on configuration.

- **Action: Alarm Level LED's (Yellow) illuminated.**



**Problem:** Alarm level LED's illuminated.

**Solution:** Genuine Oxygen level alarm event.

Incorrect sample gas levels being applied to the Sensor or incorrect alarm level settings are configured within the Analyser. If this is not expected then check sample gas with independent instrument gas/and/or re-configure Analyser Alarm setpoints. This will require interface with PC based software.

- **Action: Red Fault LED illuminated when none of the above conditions are present.**

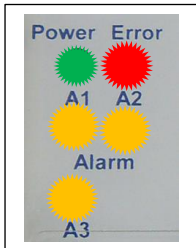

**Problem:** Analyser in fault condition. Analyser display and Analogue output will read a fault value. (28% O2 displayed and 22mA)

**Solution:** Internal Analyser electronics or programming fault. Try Power On/Off cycle to reset.

If fault does not clear then seek further assistance.

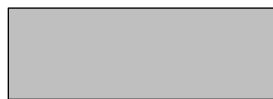

**Problem:** No Analyser display (Blank)

**Solution:** Analogue output circuit is broken or interrupted. Investigate and repair.

### 3.4.1 Possible Sensor Faults

Applicable to all sensor types (OC-25, OC-26, OC-200)

**Problem:** SIL O2 Analyser will not calibrate (Cannot be set to 20.9%)

**Solution:** Sensor is at end of life. Sensor has been wetted or contaminated. The Sensor output signal can be checked at the SIL O2 Analyser terminals 14 and 16. See specification section for details of a healthy output signal.

**Problem:** SIL O2 Analyser reads Zero (0.00)

**Solution:** Actual low Oxygen measurement. Sensor wires have been shorted together, damaging the Sensor. Verify the Oxygen level by other means. Check the Sensor output signal. Replace Sensor as necessary.

### 3.5 General Maintenance

Establish a periodic checking and maintenance routine in line with the requirements for Safety Instrumented Systems. See the Ntron SIL O2 Analyser Technical and Safety manual for further details.

**The SIL O2 Analyser** requires little physical maintenance. The user Enclosure into which it is housed should provide protection against a build up of dust or other contaminants on the surface of the SIL O2 Analyser housing. If such contaminants are seen during regular inspection, such can be removed by gentle suction device or by wiping with a damp but not wet, cloth. The ingress of such contaminants should be investigated.

Ensure all wiring to the SIL O2 Analyser is secure and in good condition, paying particular attention to the security of the connection terminals if the user enclosure is subject to vibrations.

There are no user serviceable parts within the SIL O2 Analyser. If any malfunction is detected, mechanical or electrical, the SIL O2 Analyser should be immediately removed from service following the correct protocols.

**The Sensor** used has a finite life span. The Performance of the Sensor is verified by calibration check and this should be performed according to the protocols required by the safety system. Replacement of the Sensor is necessary when it does not meet the required performance levels.

During operation life, the Sensor should be kept clean of contaminants. It can be wiped with a soft damp cloth. Observe the restrictions regarding potential static charges as detailed on the Sensor Installation Instruction Documents found in the appendix to this manual.

When removing Sensors from their process installation for replacement or other service requirements, observe the following points.

- Ensure any and all system shut down protocols are followed as applicable.
- Do not disconnect the Sensor from the connecting cables whilst the system is operating or is 'Live'.
- Ensure the process being measured is shut down or the Sensor connection is isolated by any intermediate valve mechanism if fitted.
- Always remove the Sensor connector before unscrewing the OC-25/OC-200 Sensors or unclamping the OC-26 Sensors from their process fittings
- Block off the exposed process connection if required during the period the Sensor is disconnected.
- Protect the disconnected Sensor cable from damage during the period the Sensor is disconnected.



## 4. Specifications

SIL O2 Analyser	Specifications-Electrical																				
Supply Voltage	24VDC +/- 10%																				
Supply Power	1.5 Watt																				
Analogue Output	4-20mA active source. 22mA Max output . Load 390 Ohm@22mA, Max 420 Ohm@20mA constant current.																				
Communications	RS232/Com 9600bps																				
Relay Contact outputs RL1/RL2/RL3	Um 125VAC/110VDC (Typically 30VDC)@ 1Amp. Min Current 10uA DC. Min. Voltage 10mVDC. Type According to IEC 947-5-1 resp. EN 60947)																				
Transistor Output (Do)	Switching parameters: <28V @<50mA																				
Intrinsically Safe Connection	<table> <tr> <td>voltage Uo</td> <td>DC</td> <td>6</td> <td>V</td> </tr> <tr> <td>current intensity Io</td> <td></td> <td>0,2</td> <td>mA</td> </tr> <tr> <td>power Po</td> <td></td> <td>0,3</td> <td>mW</td> </tr> <tr> <td>max. outer inductivity Lo</td> <td></td> <td>1000</td> <td>mH</td> </tr> <tr> <td>max. outer capacity Co</td> <td></td> <td>10</td> <td>µF</td> </tr> </table>	voltage Uo	DC	6	V	current intensity Io		0,2	mA	power Po		0,3	mW	max. outer inductivity Lo		1000	mH	max. outer capacity Co		10	µF
voltage Uo	DC	6	V																		
current intensity Io		0,2	mA																		
power Po		0,3	mW																		
max. outer inductivity Lo		1000	mH																		
max. outer capacity Co		10	µF																		
	Specifications-Mechanical																				
Terminal /Wire Size	Pluggable/Quick Releas terminals, capacity 2.5mm <sup>2</sup>																				
Mounting	35mm Din rail																				
Housing Material	PBT																				
Protection Class	IP20																				
Combustibility Class	VO according to UL																				
Weight	300g																				
Enviromental	Temperature: -20 to +60°C, 10-95% Humidity, no condensation.																				
Dimensions	67 mm x 114.5 mm x 99 mm																				
Indications	4 Digit LCD Display, Green OK led, Red Fault LED, Amber Alarm LED.																				

Certification/Standards	<p>CE, ATEX <b>2014/34/EU</b>/ EN 60079-0:2012 + A11:2013, EN 60079-11: 2012, EN 60079-26: 2015 C <math>\text{C} \text{E} 0158 \text{Ex}</math> II (1) G II (1) D ; [Ex ia Ga] IIC; [Ex ia Da] IIIC</p> <p>Functional safety: SIL2 according to IEC 61508/61511</p> <p><b>EMC 2014/30/EU</b></p> <p>EN 61326-3-2:2008; EN 61000-6-3: 2007 + A1: 2011</p> <p>EN 61000-4-2:2009; EN 61000-4-3: 2006 + A1: 2008 + A2: 2010</p> <p>EN 61000-4-4:2012</p> <p>2006 + A1: 2008 + A2: 2010</p> <p>EN 61000-4-5:2014</p> <p>EN 61000-4-6:2014</p>
-------------------------	--

<b>Oxygen Sensor</b>	<b>Specifications-Electrical</b>															
<b>Models</b>	OC-25, OC-26, OC-200 series															
<b>Range</b>	0-25% Oxygen															
<b>Signal Output</b>	300-375mV in Air OC25, OC-26. 135-160mV in Air OC-200															
<b>Technology/Lifespan</b>	Electrochemical Solid State Long Life / 3-5+ Years application dependant. Storage Life 1 Year.															
<b>Connections</b>	Circular Pluggable IP67 Connector with cable to specified length.															
<b>Intrinsically Safe Sensor Input Connection Parameters.</b>	<table> <tr> <td>voltage <math>U_0</math></td> <td>DC</td> <td>12 V</td> </tr> <tr> <td>current intensity <math>I_0</math></td> <td></td> <td>120 mA</td> </tr> <tr> <td>power <math>P_0</math></td> <td></td> <td>0.55 W</td> </tr> <tr> <td>max. outer inductivity <math>L_0</math></td> <td></td> <td>0 mH</td> </tr> <tr> <td>max. outer capacity <math>C_0</math></td> <td></td> <td>1.2 <math>\mu</math>F</td> </tr> </table>	voltage $U_0$	DC	12 V	current intensity $I_0$		120 mA	power $P_0$		0.55 W	max. outer inductivity $L_0$		0 mH	max. outer capacity $C_0$		1.2 $\mu$ F
voltage $U_0$	DC	12 V														
current intensity $I_0$		120 mA														
power $P_0$		0.55 W														
max. outer inductivity $L_0$		0 mH														
max. outer capacity $C_0$		1.2 $\mu$ F														
	<b>Specifications-Mechanical</b>															
<b>Dimensions OC-25</b>	100mm High x 50mm Diameter															
<b>Dimensions OC-26</b>	75mm High x 55 Diameter (KF40)															
<b>Dimensions OC-200</b>	Variable length to order, typically 200mm long x 12mm Diameter probe. Max. Diameter is 30mm.															



<b>Protection Class</b>	IP67 When inserted into process fitting with Connector fitted.
<b>Process Connection</b>	OC-25 =Ntron Sensor base; OC-26 = KF40 Flange, OC-200 = Probe Holder mechanism or Bushing
<b>Weight</b>	OC-25= 250g; OC-26=150g, OC-200=180g
<b>Environmental</b>	Temperature: -20 to +45-50°C, 10-95% Humidity, no condensation.
<b>Certification/Standards</b>	CE, ATEX <b>2014/34/EU/</b>  <b>1180</b>  <b>II 1 GD</b> EN60079-0:2012 + A11:2013 EN60079-11:2012 ATEX II 1 GD; Ex ia IIC T6 Ga(-20°C≤Ta≤+55°C) Ex ia IIIC T90°C Da( -20°C≤Ta≤+55°C) IECEX BAS 09.0148X

## 5. Appendices

- SIL O2 Analyser and Sensor Connection Diagrams
- SIL O2 Analyser CE and ATEX Certificates
- Sensor CE and ATEX Certificates

## 5.1 SIL O2 Analyser and Sensor Connection Diagrams

- E364 SIL O2 with OC-25 Sensor
- E511 SIL O2 with OC-26 Sensor
- E395 SIL O2 with OC-200 'Oxyprobe'

HAZARDOUS AREA  
ZONE DANGEREUSE

SAFE AREA  
ZONE PROTEGÉE

SIL02 ANALYSER

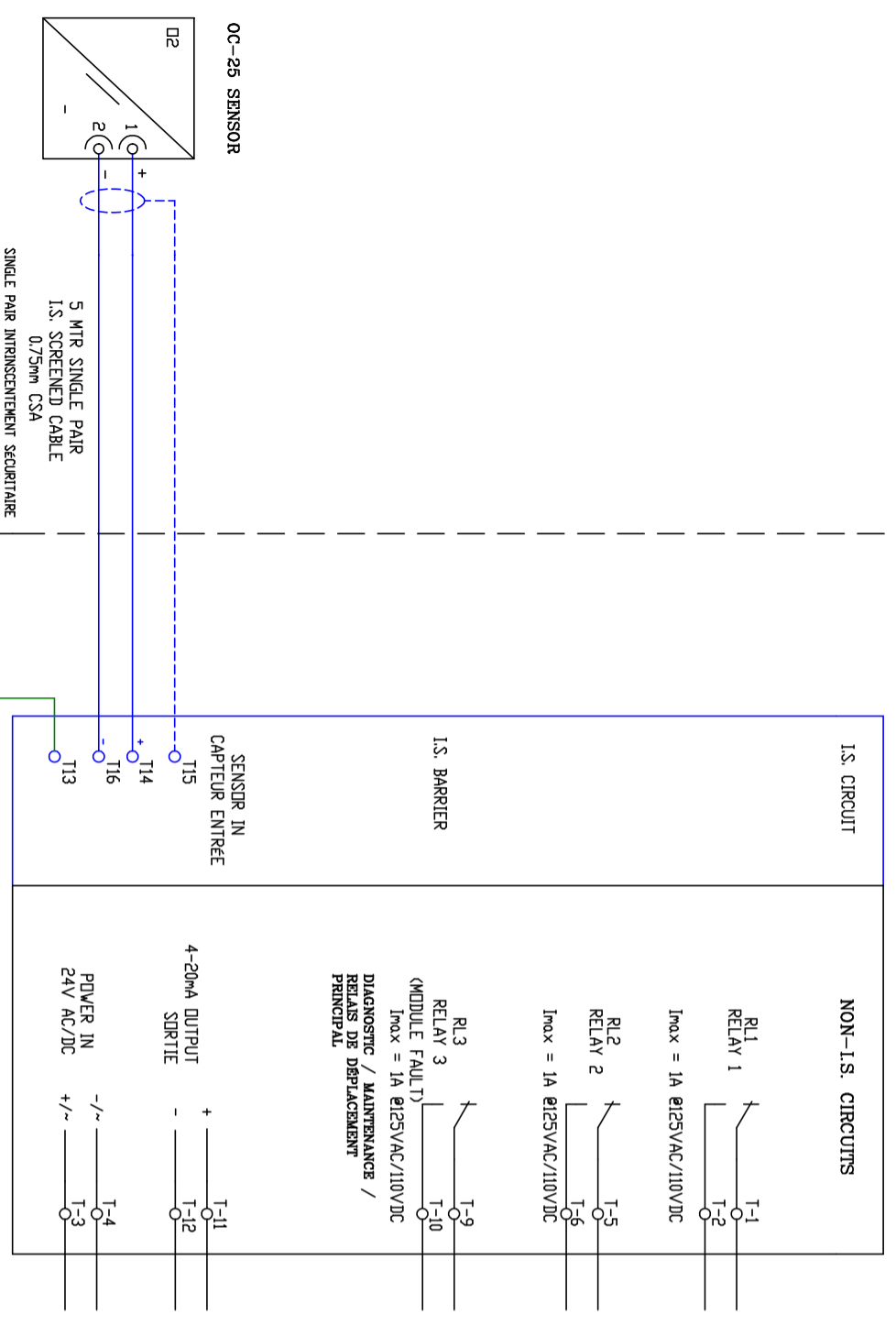

SIL RATED CONNECTIONS AS REQUIRED BY CUSTOMER  
SEE CONNECTION OPTIONS ADJACENT.  
SIL CONNECTIONS À FAIRE CONFORMÉMENT AU NIVEAU DU CLIENT. VOIR LE SCHEMA ADJACENT.

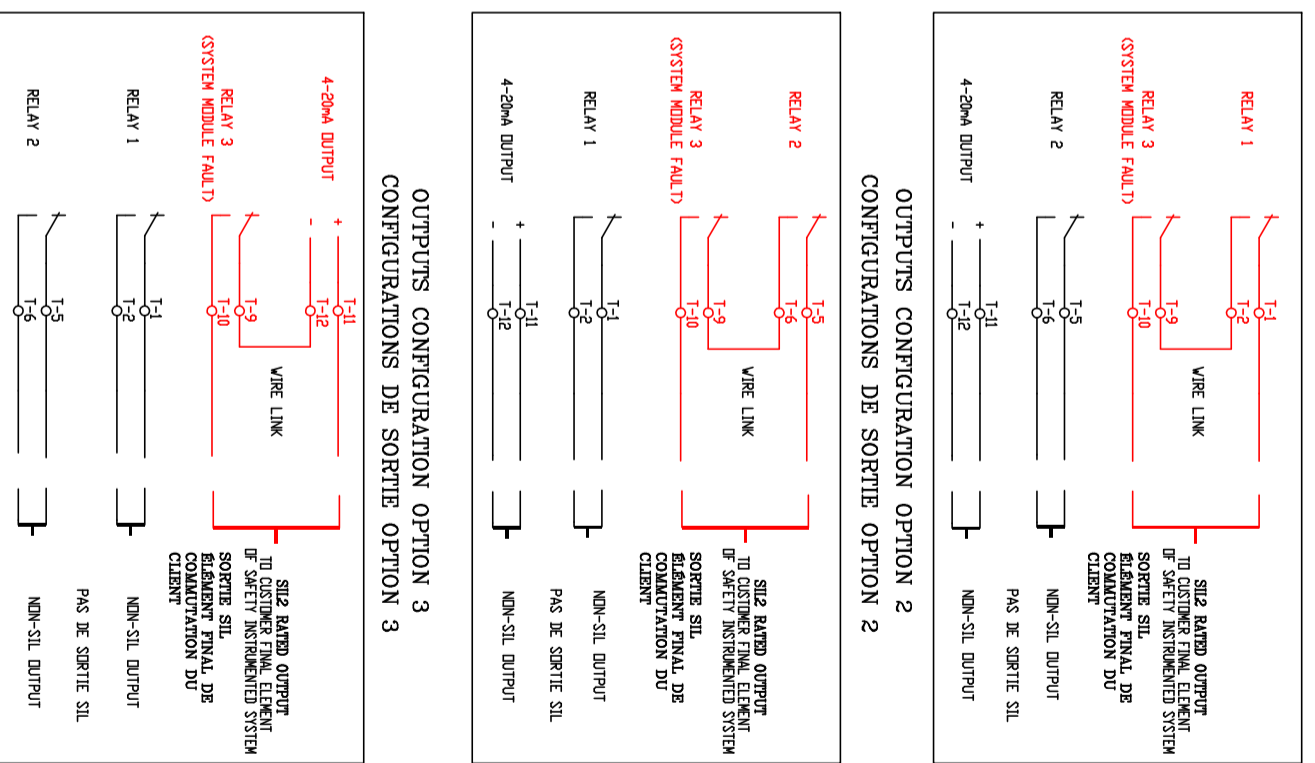

ELECTRICAL INTERFACE CONNECTIONS  
NOTE: ALL RELAYS ARE SHOWN IN THE FAIL CONDITION (NO POWER TO THE ANALYSER)  
TO COMPLY WITH IEC61508 PART 2, THE ANALYSER DIAGNOSTIC RELAY RL3 MUST BE CONNECTED IN SERIES WITH EITHER THE ANALOGUE OUTPUT OR RELAY OUTPUTS (RL1, RL2).  
TO PRESENT A SIL RATED OUTPUT TO THE USER'S FINAL SWITCHING ELEMENT, IF THE ANALOGUE OUTPUT IS USED IN THIS WAY, THEN TYPICALLY A SAFETY PLC OR SIMILAR DEVICE WILL BE REQUIRED TO INTERFACE WITH THE ANALOGUE OUTPUT AND THE FINAL SWITCHING DEVICE OF THE SAFETY SYSTEM. ANY SUCH ADDITIONAL DEVICE MUST BE TAKEN INTO ACCOUNT WHEN THE OVERALL ASSESSMENT FOR THE COMPLETE SAFETY INSTRUMENTED SYSTEM IS MADE BY THE USER.

CONNEXIONS D'INTERFACE ELECTRIQUE  
REMARQUE: TOUTS LES RELAIS SONT INDIQUEES DANS L'ETAT DE DEFAUT (PAS DE PUISSANCE ALIMENTEE A L'ANALYSEUR)  
A RESPECTER CEI 61508 PARTIE 2, LES RELAIS DE DIAGNOSTIC DE L'ANALYSEUR RL3 DOIT ETRE CONNECTE EN SERIE AVEC SOIT SORTIE ANALOGIQUE OU SORTIES RELAIS (RL1, RL2) POUR PRESENTER UNE SORTIE Nominale A L'ELEMENT DE COMMUTATION FINAL DE L'UTILISATEUR.  
SI LA SORTIE ANALOGIQUE EST UTILISEE DE CETTE FAÇON, PUIS UN APPAREIL DE SECURITE ANALOGIQUE ET LE DISPOSITIF DE COMMUTATION FINAL DU SYSTEME DE SECURITE, UNE TELLE LE DISPOSITIF ADDITIONNEL DOIT ETRE PRIS EN COMPTE QUAND L'EVALUATION GENERALE POUR LE SYSTEME COMPLETE DE SECURITE EST FAIT PAR L'UTILISATEUR.

REV.	DESCRIPTION	DRN.	CHD.	APP
3	CORRECTIONS FOR RELAY 1 AND 2	MW	DB	DB
4	CONNECTION CONFIGS TO IEC61508 ADDED	MW	DB	DB
5	FRENCH TEXT ADDED	MW	DB	DB
6	SIL OUTPUTS TEXT AMENDED	MW	MM	MM
7	RELAY ELECTRICAL PARAMETERS ADDED	MW	MM	MM

**NTTRON**  
Gas Measurement

**TITLE:** SIL02 AND OC25-SENSOR  
GENERIC ELECTRICAL SCHEMATIC  
DIAGRAM

S.D.No	N/A	DRAWING NUMBER	DRN.	CHD.	APP.	REV.
Q.No.	N/A	E364	MW	DB	DB	7
SCALE	N.T.S.					
DATE	14-09-2018	PAGE 1	DF			1

EXPLOSIONGEFÄHRDETEN BEREICHEN

NICHT-EXPLOSIONGEFÄHRDETEN BEREICHEN

SILO2 ANALYSER

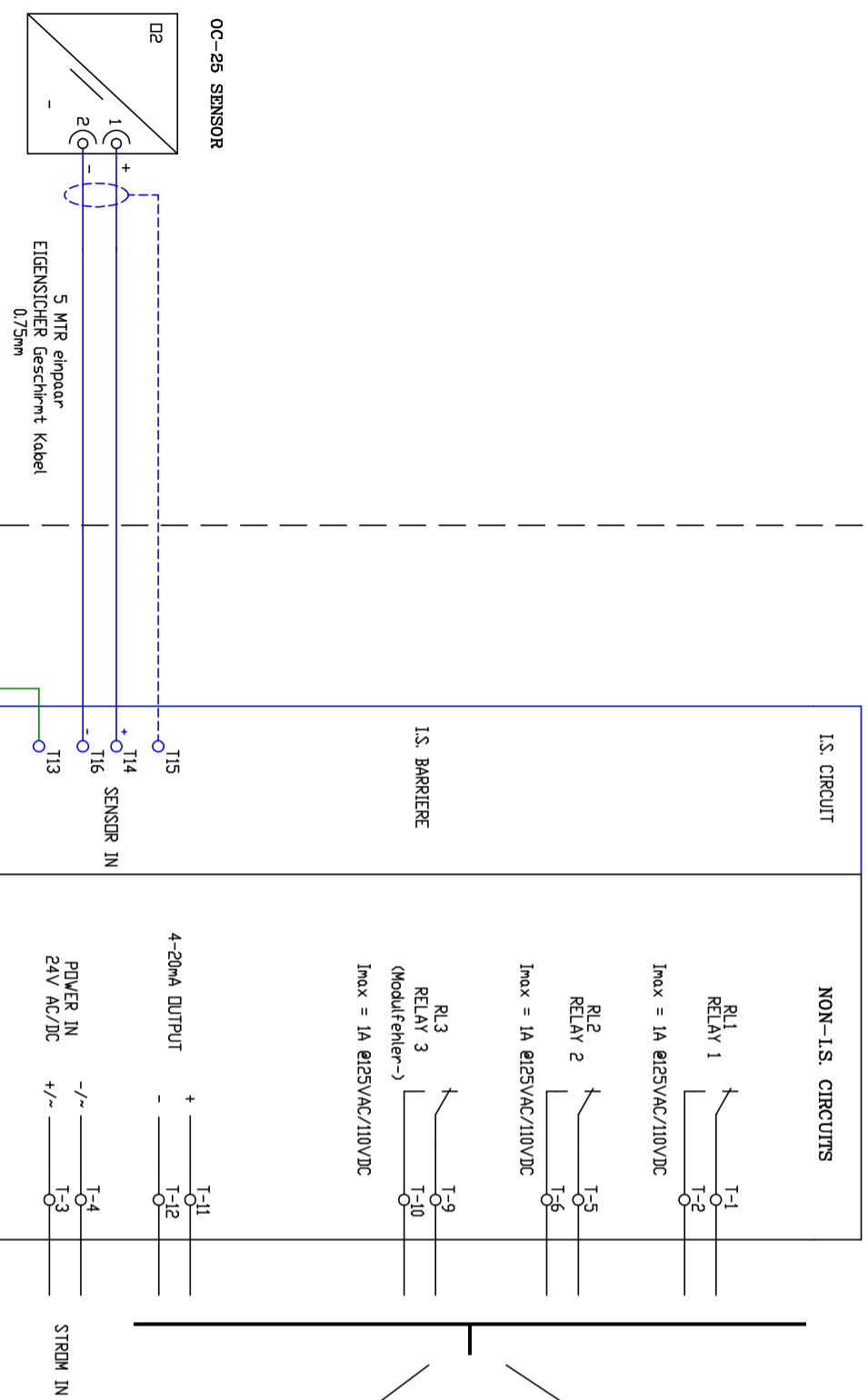

ELEKTRISCHE SCHNITTSTELLENANSCHLUSSE  
 HINWEIS: ALLE RELAIS WERDEN IM FEHLERHAFTEN ZUSTAND KEINE STROMVERSORGUNG ZUM ANALYSER) GEZEIGT

UM IEC61508 TEIL 2, DAS ANALYZER-DIAGNOSE-RELAIS RL3 ZU ERFÜLLEN MUSS IN SERIE MIT DEN ANALOGEN AUSGANGS- ODER RELAIS-AUSGÄNGEN (RL1, RL2) VERBUNDEN WERDEN. EINEN SIL-BEZUGENEN AUSGANG ZUM ENDSCHALT ELEMENT DES BENUTZERS VORZUNEHMEN, WENN DER ANALOGAUSGANG WIRD AUF DIESE WEISE VERWENDET, DANN WIRD TYPISCHERWEISE EINE SICHERHEITS-SPS ODER EIN ÄHNLICHES GERÄT ZUR SCHNITTSTELLE BENÖTIGT. MIT DEM ANALOGAUSGANG UND DER ENDSCHALTUNG DES SICHERHEITSSYSTEMS, JEDER ZUSÄTZLICHE VORRICHTUNG MUSS BEI DER GESAMTBEURTEILUNG FÜR BERÜCKSICHTIGT WERDEN FÜR DAS VOLLSTÄNDIGE SICHERHEITSINSTRUMENTIERTE SYSTEM WIRD DURCH DEN BENUTZER GEMACHT.

AUSGÄNGE KONFIGURATION OPTIONEN 1

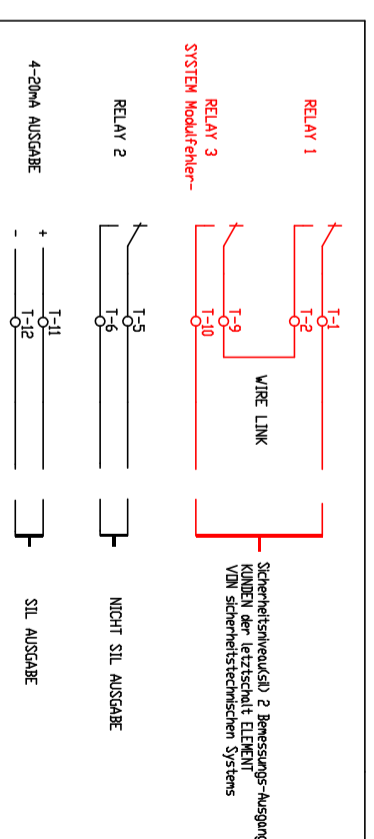

AUSGÄNGE KONFIGURATION OPTIONEN 2

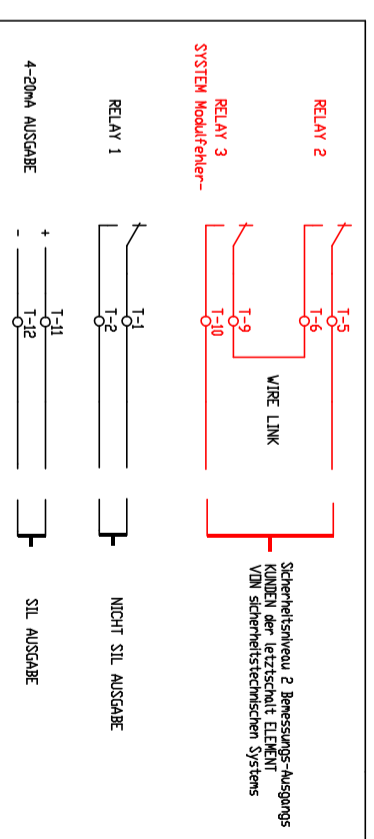

AUSGÄNGE KONFIGURATION OPTIONEN 3

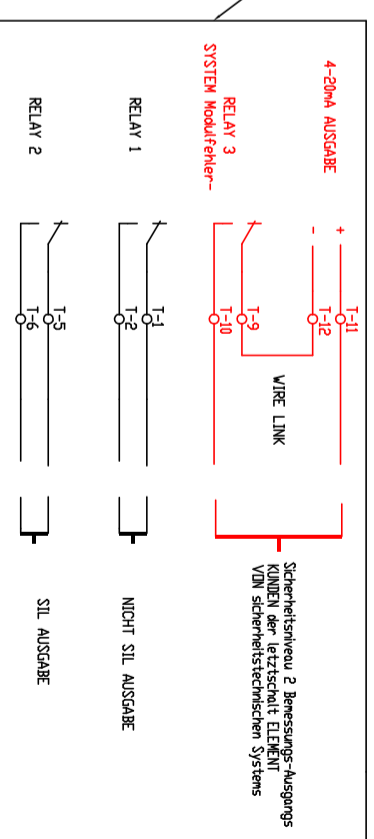

REV.	DESCRIPTION	DRN.	CHD.	APP					TITEL:	SIL02 UND OC25-SENSOR	DRN.	CHD.	APP.	REV.
1	SIL OUTPUTS TEXT AMENDED	MW	MM	MM					GENERICISCHEN ELEKTRISCH SCHEMATIC	E364-DE	MW	DB	DB	2
2	RELAY ELECTRICAL PARAMETERS ADDED	MW	MM	MM					SCALE	N.T.S.				
					DATE	14-09-2018	PAGE	1	DF	1				

ELECTRICAL INTERFACE CONNECTIONS

NOTE: ALL RELAYS ARE SHOWN IN THE FAIL CONDITION (NO POWER TO THE ANALYSER)

TO COMPLY WITH IEC61508 PART 2, THE ANALYSER DIAGNOSTIC RELAY RL3 MUST BE CONNECTED IN SERIES WITH EITHER THE ANALOGUE OUTPUT OR RELAY OUTPUTS (RL1, RL2), TO PRESENT A SIL RATED OUTPUT TO THE USER'S FINAL SWITCHING ELEMENT. IF THE ANALOGUE OUTPUT IS USED IN THIS WAY, THEN TYPICALLY A SAFETY PLC OR SIMILAR DEVICE WILL BE REQUIRED TO INTERFACE WITH THE ANALOGUE OUTPUT AND THE FINAL SWITCHING DEVICE OF THE SAFETY SYSTEM. ANY SUCH ADDITIONAL DEVICE MUST BE TAKEN INTO ACCOUNT WHEN THE OVERALL ASSESSMENT FOR THE COMPLETE SAFETY INSTRUMENTED SYSTEM IS MADE BY THE USER.

SIDE ELEVATION

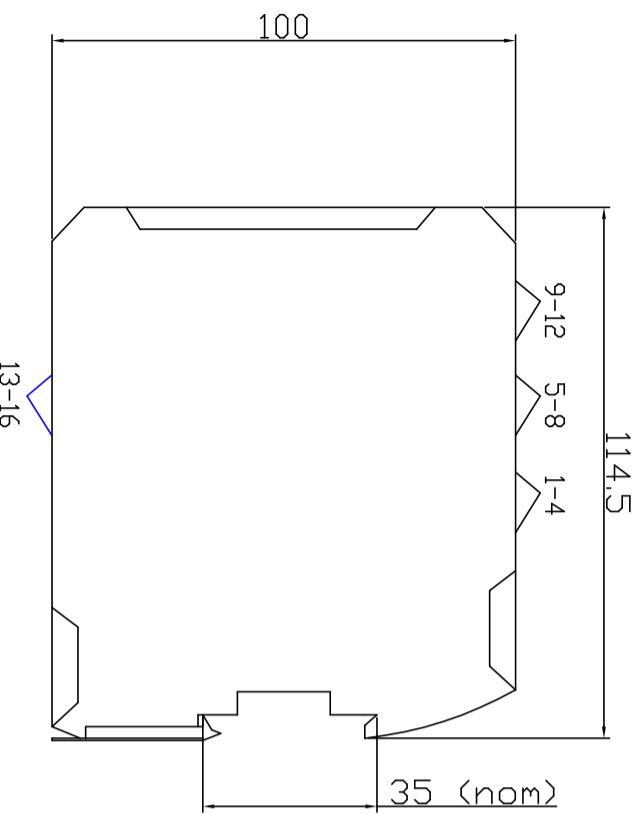

SUITABLE FOR 35x15 OR 35x7.5 MOUNTING RAIL

SIO2 ANALYSER

PART No.: 01-758

FRONT ELEVATION

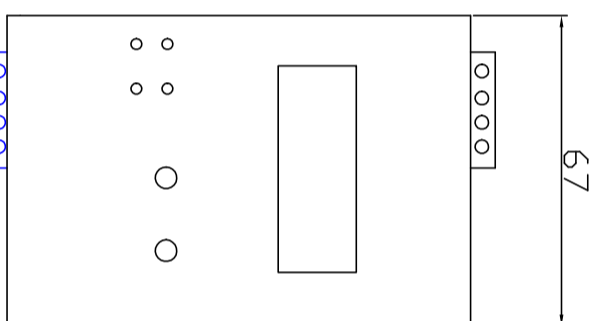

KF40 FLANGE

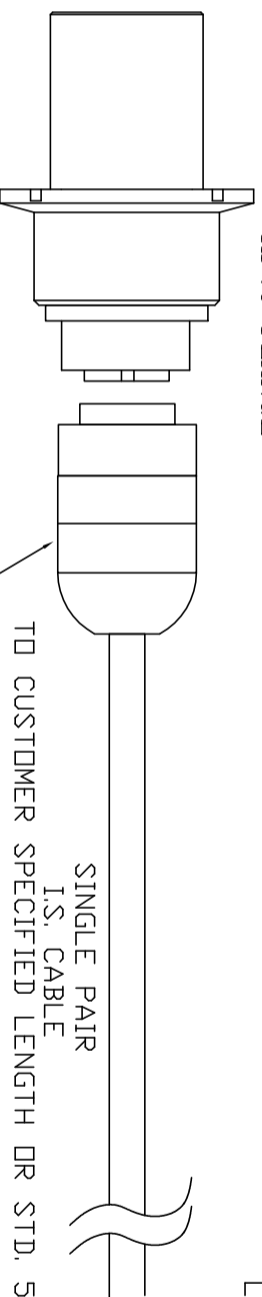

OC-26 SENSOR  
PART No.: 04-909

CONNEXIONS D'INTERFACE ELECTRIQUE  
ELEKTRISCHE SCHNITTSTELLENANSCHLUSSE  
ELECTRICAL INTERFACE CONNECTIONS

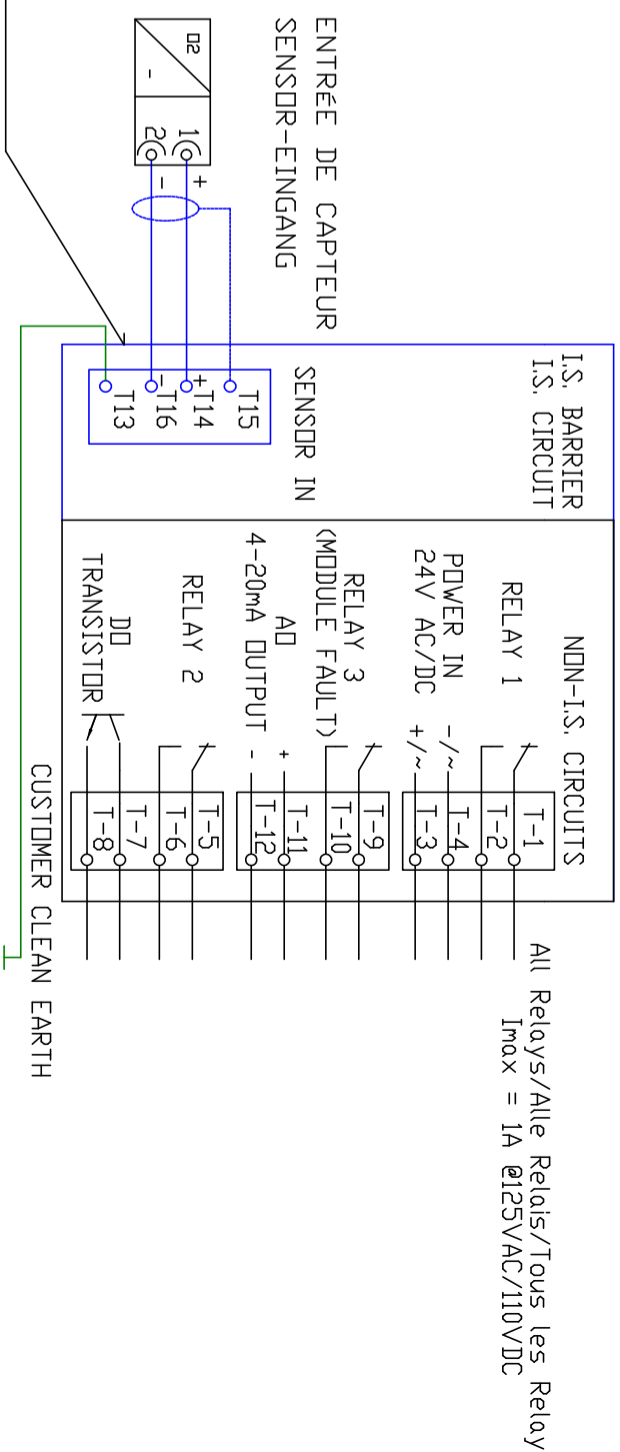

KUNDE SAUBERE ERDE  
LE CLIENT DE LA TERRE PROPRE

CONNEXIONS D'INTERFACE ELECTRIQUE

REMARQUE: TOUS LES RELAIS SONT INDIQUEES DANS L'ÉCHEC (NO POWER TO THE ANALYSER)

ELEKTRISCHE SCHNITTSTELLENANSCHLUSSE

HINWEIS: ALLE RELAIS WERDEN IM FEHLERHAFTEN ZUSTAND (KEINE STROMVERSORGUNG ZUM ANALYSER) GEZEIGT

A RESPECTER CEI 61508 PARTIE 2, RELAIS DE DIAGNOSTIC DE L'ANALYSEUR RL3 DOIT ÊTRE CONNECTÉ EN SÉRIE AVEC SOIT SORTIE ANALOGIQUE OU SORTIES RELAIS (RL1, RL2), POUR PRÉSENTER UNE SORTIE NOMINALE À L'ÉLÉMENT DE COMMUTATION FINAL DE L'UTILISATEUR. SI LA SORTIE ANALOGIQUE EST UTILISÉ DE CETTE FAÇON, PUIS UN APPAREIL DE SÉCURITÉ (PLC) OU UN DISPOSITIF SIMILAIRE SERA REQUIS POUR INTERFACE AVEC LA SORTIE ANALOGIQUE ET LE DISPOSITIF DE COMMUTATION FINAL DU SYSTÈME DE SÉCURITÉ. UNE TELLE LE DISPOSITIF ADDITIONNEL DOIT ÊTRE PRIS EN COMPTE QUAND L'ÉVALUATION GÉNÉRALE POUR LE SYSTÈME COMPLETE DE SECURITE EST FAIT PAR L'UTILISATEUR.

UM IEC61508 TEIL 2, DAS ANALYSER-DIAGNOSE-RELAIS RL3 ZU ERFÜLLEN MUSS IN SERIE MIT DEN ANALOGEN AUSGANGS- ODER RELAISAUSSANGEN (RL1, RL2) VERBUNDEN WERDEN, EINEN SIL-BEZUGENEN AUSGANG ZUM ENDSCHALTELEMENT DES BENUTZERS VORZUNEHMEN. WENN DER ANALOGENAUSGANG WIRD AUF DIESE WEISE VERWENDET, DANN WIRD TYPISCHERWEISE EINE SICHERHEITS-SPS ODER EIN ÄHNLICHES GERÄT ZUR SCHNITTSTELLE BENÖTIGT. MIT DEM ANALOGENAUSGANG UND DER ENDSCHALTUNG DES SICHERHEITSSYSTEMS. JEDER ZUSÄTZLICHE VORRICHTUNG MUSS BEI DER GESAMTBEURTEILUNG FÜR BERÜCKSICHTIGT WERDEN FÜR DAS VOLLSTÄNDIGE SICHERHEITSSYSTEM WIRD DURCH DEN BENUTZER GEMACHT.

1	PART NUMBER AMENDMENT	MW	MM	MM																	
2	FRENCH & GERMAN TEXT ADDED	MW	MM	MM																	
3	RELAY ELECTRICAL PARAMETERS ADDED	MW	MM	MM																	
REV.	DESCRIPTION	DRN.	CHD.	APP				TITLE:	SIO2 ANALYSER WITH OXYPROBE SENSOR OC-26 GENERAL ARRANGEMENT PART No.: 04-908			S.D. NO.	N/A	DRAWING NUMBER	DRN.	CHD.	APP.	REV			
								Q.No.	N/A		E511	MW	DM	DM	3						
								SCALE	N.T.S.												
								DATE	14-09-2018		PAGE	1	OF	1							

HAZARDOUS AREA

SAFE AREA

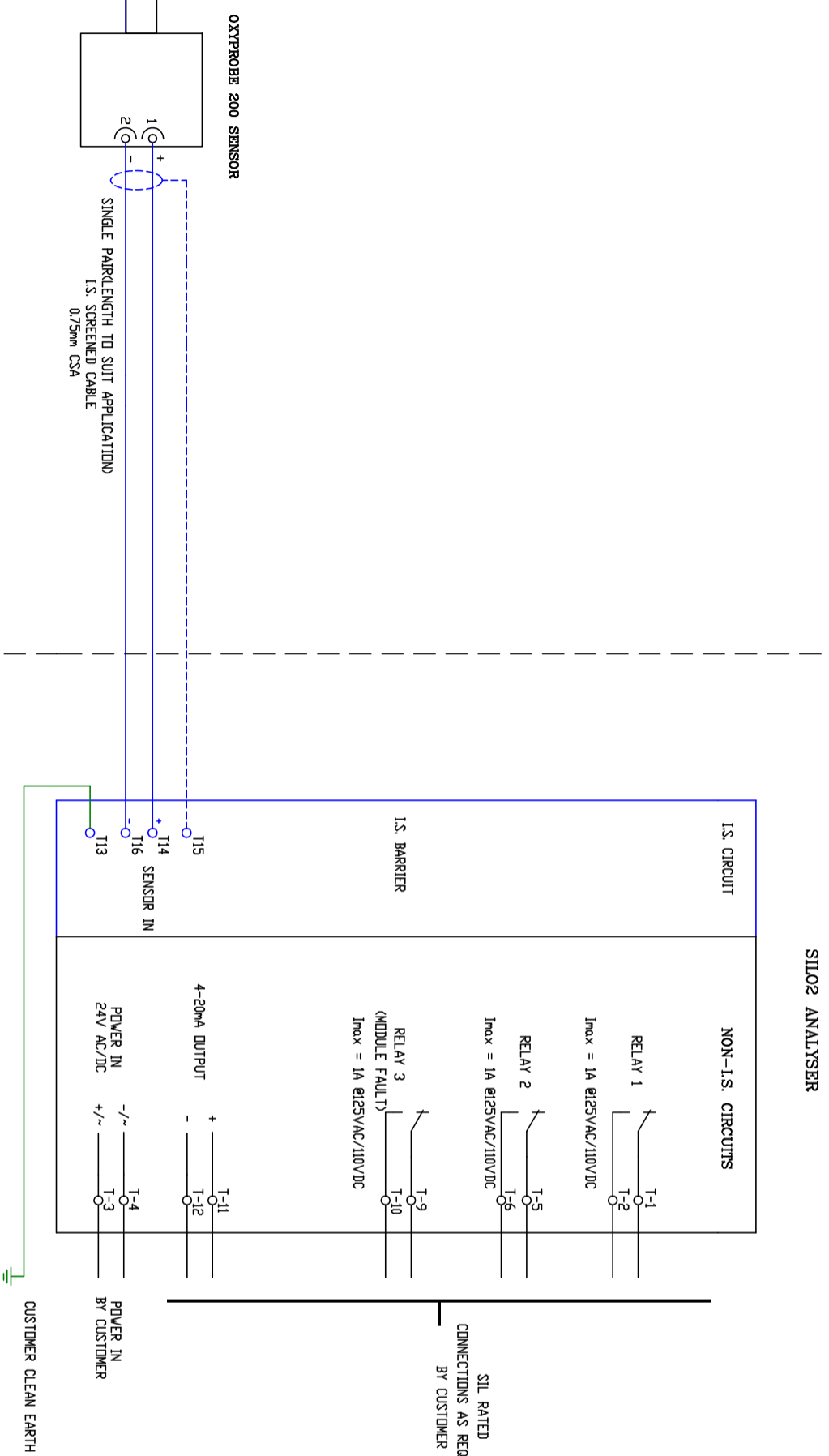

ELECTRICAL INTERFACE CONNECTIONS

NOTE: ALL RELAYS ARE SHOWN IN THE FAIL CONDITION (NO POWER TO THE ANALYSER)

TO COMPLY WITH IEC61508 PART 2, THE ANALYSER DIAGNOSTIC RELAY R3 MUST BE CONNECTED IN SERIES WITH EITHER THE ANALOGUE OUTPUT OR RELAY OUTPUTS (R1, R2). TO PRESENT A SIL RATED OUTPUT TO THE USER'S FINAL SWITCHING ELEMENT, IF THE ANALOGUE OUTPUT IS USED IN THIS WAY, THEN TYPICALLY A SAFETY PLC OR SIMILAR DEVICE WILL BE REQUIRED TO INTERFACE WITH THE ANALOGUE OUTPUT AND THE FINAL SWITCHING DEVICE OF THE SAFETY SYSTEM. ANY SUCH ADDITIONAL DEVICE MUST BE TAKEN INTO ACCOUNT WHEN THE OVERALL ASSESSMENT FOR THE COMPLETE SAFETY INSTRUMENTED SYSTEM IS MADE BY THE USER.

OUTPUTS CONFIGURATION OPTION 1

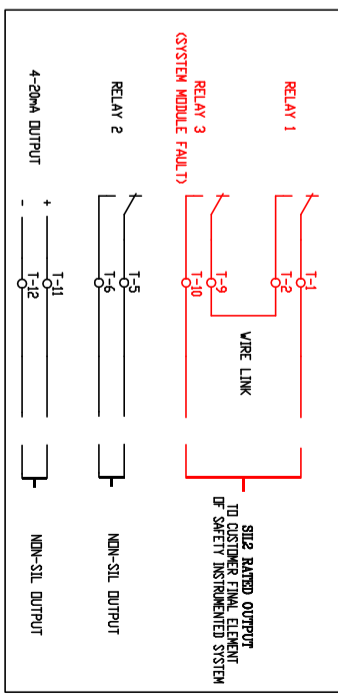

OUTPUTS CONFIGURATION OPTION 2

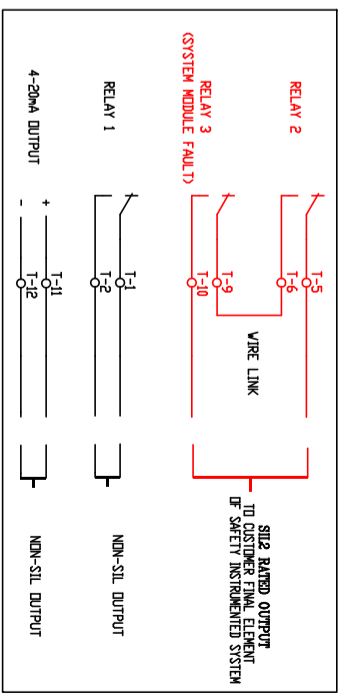

OUTPUTS CONFIGURATION OPTION 3

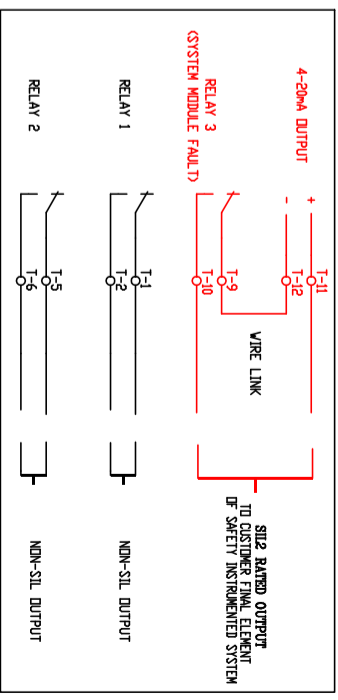

CONNEXIONS D'INTERFACE ELECTRIQUE

REMARQUE: TOUTS LES RELAIS SONT INDIQUEES DANS L'ETAT DE FAUTE (PAS DE PUISSANCE ALIMENTEE A L'ANALYSEUR)

A RESPECTER CETTE PARTIE 2, LES RELAIS DE DIAGNOSTIC DE L'ANALYSEUR R3 DOIT ETRE CONNECTE EN SERIE AVEC LA SORTIE ANALOGIQUE OU LA SORTIE RELAIS (R1, R2). POUR PRESENTER UNE SORTIE NOMINALE A L'ELEMENT DE COMMUTATION FINAL DE L'UTILISATEUR, SI LA SORTIE ANALOGIQUE EST UTILISEE DE CETTE MANIERE, UN APPAREIL DE SECURITE (PLC) OU UN DISPOSITIF SIMILAIRE SERA REQUIS POUR INTERFACER AVEC LA SORTIE ANALOGIQUE ET LE DISPOSITIF DE COMMUTATION FINAL DU SYSTEME DE SECURITE. UN TEL DISPOSITIF ADDITIONNEL DOIT ETRE PRENE EN COMPTE QUAND LA REEVALUATION GENERALE POUR LE SYSTEME COMPLETE DE SECURITE EST FAITE PAR L'UTILISATEUR.

REV.	DESCRIPTION	DRN.	CHD.	APP		<b>TITLE:</b> SILO2 AND OXYPROBE 200 SENSOR GENERIC ELECTRICAL SCHEMATIC DIAGRAM	S.D.No	N/A	DRAWING NUMBER	DRN.	CHD.	APP.	REV.
1	OUTPUT CONFIG. DETAIL ADDED	MW	MM	MM			Q.No.	N/A	E395	MW	MM	MM	3
3	RELAY ELECTRICAL PARAMETERS ADDED	MW	MM	MM			SCALE	N.T.S.					

DATE	14-09-2018	PAGE	1	DF	1
------	------------	------	---	----	---

EXPLOSIONSGEFÄHRTETEN BEREICHEN

NICHT-EXPLOSIONSGEFÄHRTETEN BEREICHEN

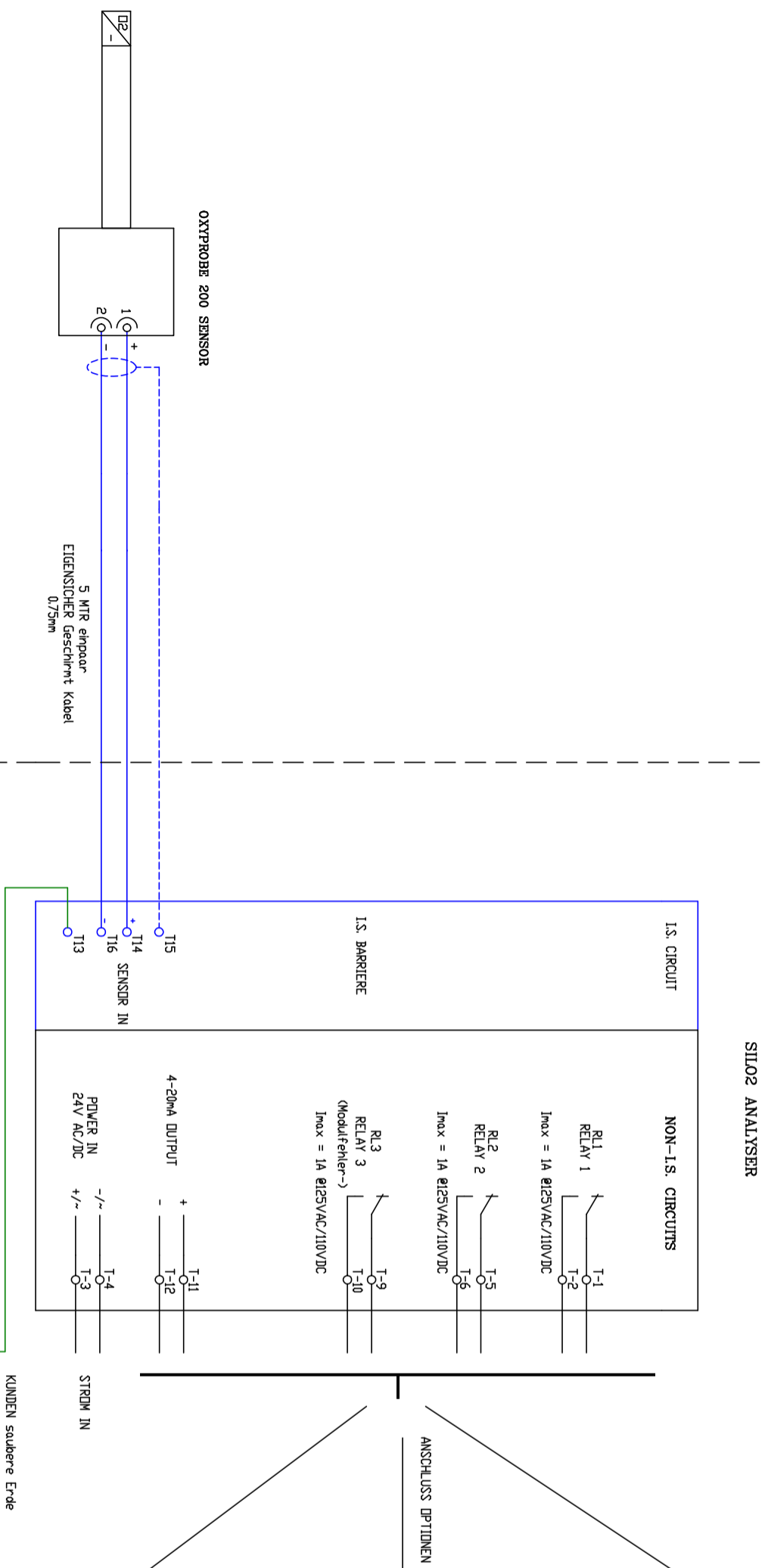

Hinweis: Alle Relais in FAIL Zustand gezeigt (nicht mit Strom AUSWERTERS)  
 ELEKTRISCHE SCHNITTSTELLENANSCHLUSSE  
 HINWEIS: ALLE RELAIS WERDEN IM FEHLERHAFTEN ZUSTAND (KEINE STROMVERSORGDUNG ZUM ANALYSER) GEZEIGT  
 UM IEC61508 TEIL 2, DAS ANALYSER-DIAGNOSE-RELAIS RL3 ZU ERFÜLLEN MUSS IN SERIE MIT DEN ANALOGEN AUSGANGS- ODER RELAIS-AUSGÄNGEN (RL1, RL2) VERBUNDEN WERDEN.  
 EINEN SIL-BEZUGENEN AUSGANG ZUM ENDSCHALTELEMENT DES BENUTZERS VORZUNEHMEN, WENN DER ANALOGAUSGANG WIRD AUF DIESE WEISE VERWENDET, DANN WIRD TYPISCHERWEISE EINE SICHERHEITS-SPS ODER EIN ÄHNLICHES GERÄT ZUR SCHNITTSTELLE BENÖTIGT.  
 MIT DEM ANALOGAUSGANG UND DER ENDSCHALTUNG DES SICHERHEITSSYSTEMS, JEDER ZUSÄTZLICHE VORRICHTUNG MUSS BEI DER GESAMTBEURTEILUNG FÜR BERÜCKSICHTIGT VERDEN FÜR DAS VOLLSTÄNDIGE SICHERHEITSTRUMENTIERTE SYSTEM WIRD DURCH DEN BENUTZER GEMACHT.

AUSGÄNGE KONFIGURATION OPTIONEN 1

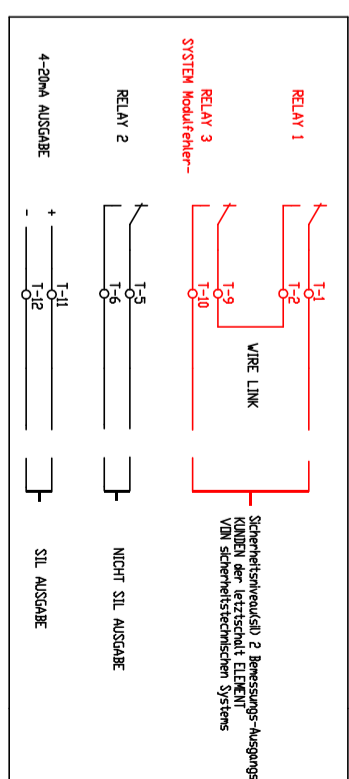

AUSGÄNGE KONFIGURATION OPTIONEN 2

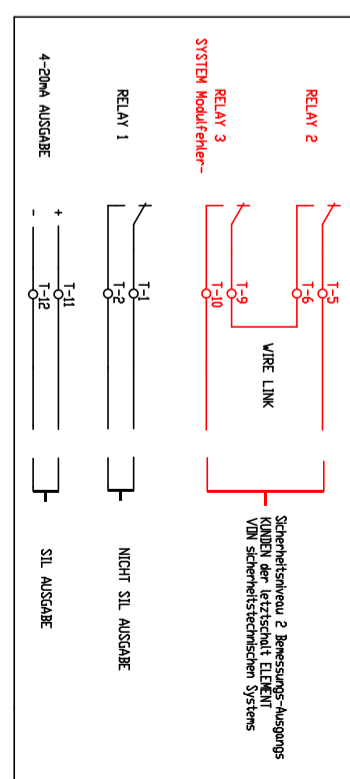

AUSGÄNGE KONFIGURATION OPTIONEN 3

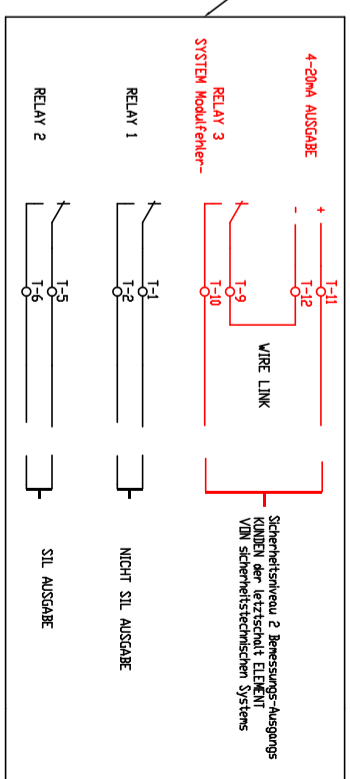

REV.	DESCRIPTION	DRN.	CHD.	APP					<b>TITTEL:</b> SILO2 UND OC25-SENSOR GENERISCHEN ELEKTRISCH SCHEMATIC				S.D.NO	N/A	ZEICHNUNGSNUMMER	DRN.	CHD.	APP.	REV.
1	SIL OUTPUTS TEXT AMENDED	MW	MM	MM					Q.No.	N/A	E395-DE	MW	DB	DB	2				
2	RELAY ELECTRICAL PARAMETERS ADDED	MW	MM	MM					SCALE	N.T.S.									
					DATE	14-09-2018	PAGE	1	DF	1									



## 5.2 SIL O2 Analyser CE and ATEX Certificates

- CE Certificate CETX003
- ATEX Certificate Dekra BVS 13 ATEX E 010

## **EU Declaration of Conformity/ EG-Konformitätserklärung/ Déclaration de conformité CE/ Declaración de conformidad CE/ Dichiarazione di conformità CE.**

**En: We declare, under our full responsibility, that we believe the products identified in this declaration, and to which this declaration relates are in conformity with the requirements of Council Directives:**

D: Wir erklären unter unserer vollen Verantwortung, dass wir glauben, dass die Produkte in dieser Erklärung identifiziert, auf die sich diese Erklärung bezieht, in Übereinstimmung mit den Anforderungen der Richtlinien:

Fr: Nous déclarons, sous notre entière responsabilité, que nous croyons que les produits identifiés dans la présente Déclaration, et à laquelle se réfère cette déclaration sont conformes aux exigences des directives du Conseil:

Es: Declaramos, bajo nuestra responsabilidad exclusiva, que creemos que los productos identificados en esta declaración, y al cual se refiere esta declaración son conformes con los requisitos de las Directivas del Consejo:

It: Dichiariamo, sotto la nostra piena responsabilità, che crediamo i prodotti identificati in questa dichiarazione, e al quale questa dichiarazione si riferisce sono conformi alle prescrizioni delle direttive del Consiglio:

### **This product meets the specifications according to the following European directives:**

Dieses Produkt erfüllt die Spezifikationen nach den folgenden Europäischen Richtlinien:

Ce produit est conforme aux spécifications selon les directives Européennes suivantes:

Este producto cumple con las especificaciones de acuerdo a las siguientes directivas Europeas:

Questo prodotto soddisfa le specifiche in base alle seguenti direttive Europee:

**Directive/ Richtlinie/ directive/ directiva/ direttiva 2014/34/EU- Equipment and protective systems intended for use in potentially explosive atmospheres./Richtlinie 2014/34 / EU Geräte und Schutzsysteme zur bestimmungsgemäßen Verwendung in explosionsgefährdeten Bereichen/ Directive 2014/34 / EU équipements et systèmes de protection destinés à être utilisés dans des atmosphères explosibles./ Directiva 2014/34 / UE equipos y sistemas de protección destinados a ser utilizados en atmósferas potencialmente explosivas./ apparecchiature e sistemi di protezione destinati all'uso in atmosfere potenzialmente esplosive.**

**Directive/ Richtlinie/ directive/ directiva/ direttiva 2014/30/EU–Electromagnetic Compatibility/Elektromagnetische Verträglichkeit/Compatibilité électromagnétique/ Compatibilidad Electromagnética/Compatibilità Elettromagnetica**

**Directive/ Richtlinie/ directive/ directiva/ direttiva 2011/65/EU and of Council of 8th June 2011 on the restriction of the use of certain hazardous substances in electrical and electronic equipment (RoHS2)(\*)**

\*OJ L 174, 1.7.2011, p.88 & P106 Annex IV 1b exemption./ und vom Rat vom 8. Juni 2011 zur Beschränkung der Verwendung bestimmter gefährlicher Stoffe in Elektro- und Elektronikgeräten (RoHS2) (\*)

ABl. L 174 vom 1.7.2011, S. 88 und P106 Anhang IV 1b Befreiung./ et du Conseil du 8 juin 2011 sur la limitation de l'utilisation de certaines substances dangereuses dans les équipements électriques et électroniques (RoHS2) (\*)

\* JO L 174 du 1.7.2011, p.88 et P106 Annexe IV 1b./ y del Consejo de 8 de junio de 2011 sobre la restricción del uso de determinadas sustancias peligrosas en equipos eléctricos y electrónicos (RoHS2) (\*)

\* DO L 174 de 1.7.2011, p.88 y P106 Anexo IV 1b exención./ e del Consiglio, dell'8 giugno 2011, sulla restrizione dell'uso di talune sostanze pericolose nelle apparecchiature elettriche ed elettroniche (RoHS2) (\*)

\* GU L 174 dell'1.7.2011, pag.88 & P106 Allegato IV, punto 1b.

**Description of Equipment/Beschreibung des Gerätes/Description de l'équipement/Descripción de Equipo/Descrizione delle attrezzature:**

### **SilO2 Oxygen Analyser.**

SilO2 Sauerstoff Analyser.

SilO2 Analyseur d'oxygène.

SilO2 Analizador de Oxígeno.

SilO2 analizzatore di ossigeno.

**Standards and marking/ Standards und Kennzeichnung/ Normes et marquage/ Normas y marcado/ Norme e marcatura:**

<b>Standards applied:</b> <b>Normen:</b> <b>Normes appliquées:</b> <b>De normas vigentes:</b> <b>Norme di riferimento:</b>	<b>ATEX:</b> <b>EN 60079-0: 2012 + A11: 2013</b> Explosive atmospheres - Part 0: Equipment - General requirements. <b>EN 60079-11:2012</b> Explosive atmospheres - Part 11: Equipment protection by intrinsic safety "i".  <b>EMC:</b> <b>EN61326-3-2:2008</b> Electromagnetic compatibility – immunity requirements for safety related systems and for equipment intended to perform safety related functions in industrial applications with specified electromagnetic environment. <b>EN 61000-6-3: 2007 + A1: 2011</b> , Emissions Light Industrial <b>EN61000-4-2:2009</b> , Electrostatic Discharge <b>EN61000-4-3: 2006 + A1: 2008 + A2: 2010</b> , Immunity Heavy Industrial <b>EN61000-4-4:2012</b> , Burst Immunity <b>EN61000-4-5:2014</b> , Surge Immunity <b>EN61000-4-6:2014</b> , Conducted Immunity
<b>Equipment marking:</b> <b>Kennzeichnung der Anlagen:</b> <b>Matériel de marquage:</b> <b>Equipo de marcado</b> <b>Contrassegno degli impianti:</b>	 <b>II (1)G (Ex ia Ga) IIC</b> <b>II (1)D (Ex ia Da) IIIC</b>
<b>Notified body:</b> <b>Benannte Stelle:</b> <b>Organisme notifié:</b> <b>Organismo notificado:</b> <b>Organismo notificato:</b>	DEKRA Exam GmbH. Dinnendahlstrasse 9 44809 Bochum Germany. BVS 13 ATEX E 010

**The Authorised Signatory to this declaration, on behalf of the manufacturer, is identified below:**

**Der Prokurist dieser Erklärung im Namen des Herstellers, ist unten angegeben:**

**Le Signataire autorisé à cette déclaration, le nom du fabricant, est identifié ci-dessous:**

**El Signatario autorizado a esta declaración, en nombre del fabricante, se identifica a continuación:**

**Il Firmatario autorizzato a tale dichiarazione, per conto del produttore, viene identificata di seguito:**

**Name/ Nom/Nombre/Nome:**

David Beirne

**Title/Position; Titel / Position; Titre / Position; Título / Puesto; Titolo / Ruolo :**

Managing Director/Geschäftsführer /Directeur Général/ Director Gerente/Amministratore Delegato

**Address/Anschrift/ adresse/ dirección/indirizzo**

Ntron Ltd, Mullaghboy Industrial Park, Navan, Co. Meath, Ireland.

**Signature**



**Date:** 25/02/2019

## Translation

# (1) EC-Type Examination Certificate

- (2) Equipment and protective systems intended for use in potentially explosive atmospheres - Directive 94/9/EC
- (3) No. of EC-Type Examination Certificate: **BVS 13 ATEX E 010**
- (4) Equipment: **Oxygen Analyser type SilO2**
- (5) Manufacturer: **Ntron Ltd.**
- (6) Address: **Mullaghboy Industrial Park, Navan, County Meath, Ireland**
- (7) The design and construction of this equipment and any acceptable variation thereto are specified in the appendix to this type examination certificate.
- (8) The certification body of DEKRA EXAM GmbH, notified body no. 0158 in accordance with Article 9 of the Directive 94/9/EC of the European Parliament and the Council of 23 March 1994, certifies that this equipment has been found to comply with the Essential Health and Safety Requirements relating to the design and construction of equipment and protective systems intended for use in potentially explosive atmospheres, given in Annex II to the Directive. The examination and test results are recorded in the test and assessment report BVS PP 13.2019 EG.
- (9) The Essential Health and Safety Requirements are assured by compliance with:
- EN 60079-0:2012 General requirements**  
**EN 60079-11:2012 Intrinsic safety 'i'**  
**EN 60079-26:2007 Equipment with equipment protection level (EPL) Ga**
- (10) If the sign "X" is placed after the certificate number, it indicates that the equipment is subject to special conditions for safe use specified in the appendix to this certificate.
- (11) This EC-Type Examination Certificate relates only to the design, examination and tests of the specified equipment in accordance to Directive 94/9/EC. Further requirements of the Directive apply to the manufacturing process and supply of this equipment. These are not covered by this certificate.
- (12) The marking of the equipment shall include the following:

 **II (1) G [Ex ia Ga] IIC**

DEKRA EXAM GmbH  
Bochum, dated 1<sup>st</sup> February 2013

Signed: Dr. Franz Eickhoff

\_\_\_\_\_  
Certification body

Signed: Ute Hauke

\_\_\_\_\_  
Special services unit

(13) Appendix to

(14) **EC-Type Examination Certificate  
BVS 13 ATEX E 010**

(15) 15.1 Subject and type

Oxygen Analyser type SilO2

15.2 Description

The Oxygen Analyser, which will be installed outside the hazardous area, is used for commutation of an intrinsically safe input signal into non intrinsically safe signals.

15.3 Parameters

4.1	Power supply circuit (terminals 3 and 4 resp. connection KT-B4 and KT-B5)				
	Nominal voltage		DC	19...30	V
			AC	18...28	V
	max. voltage	Um	AC/DC	250	V
4.2	Non intrinsically safe RS485 interface circuit (connection KT-B1 and KT-B2)				
	Nominal voltage		DC	6	V
	Nominal voltage			100	mA
	max. voltage	Um	AC/DC	48	V
4.3	Non intrinsically safe Relay contact circuit (terminals 1-2, 5-6 and 9-10)				
	Switching voltage		DC	30	V
	Switching current			1	A
	or				
	Switching voltage		AC	125	V
	Switching current			0.5	A
	max. voltage	Um	AC/DC	125	V
4.4	Non intrinsically safe digital output circuit (terminals 7 and 8)				
	Nominal voltage		DC	28	V
	Nominal voltage			50	mA
	max. voltage	Um	AC/DC	125	V
4.5	Non intrinsically safe analog output circuit (terminals 11 and 12)				
	Nominal voltage		DC	20	V
	Nominal voltage			50	mA
	max. voltage	Um	AC/DC	125	V
4.6	Intrinsically safe mV input circuit (terminals 14 und 16)				
	Voltage	Uo	DC	6	V
	Current	Io		0.2	mA
	Power	Po		0.3	mW
	External inductance	Lo		1000	mH
	External capacitance	Co		10	µF
	For the connection of an intrinsically safe circuit with the following max. value:				
	Voltage	Ui	DC	1	V
	For this circuit the following values apply:				
	Internal capacitance	Ci		0.2	µF
	Internal inductance	Li		negligible	
4.7	Ambient temperature range	Ta		- 20 °C up to + 60 °C	

(16) Test and assessment report

BVS PP 13.2019 EG as of 1<sup>st</sup> February 2013

(17) Special conditions for safe use

None

---

We confirm the correctness of the translation from the German original.  
In the case of arbitration only the German wording shall be valid and binding.

DEKRA EXAM GmbH  
44809 Bochum, 1<sup>st</sup> February 2013  
BVS-Schu/Ma A 20130046



---

Certification body



---

Special services unit

Translation

(1) **1<sup>st</sup> Supplement to the EC-Type Examination Certificate**

- (2) Equipment and protective systems intended for use in potentially explosive atmospheres - Directive 94/9/EC Supplement accordant with Annex III number 6
- (3) No. of EC-Type Examination Certificate: **BVS 13 ATEX E 010**
- (4) Equipment: **Sil-O2 Analyzer Type 01-758**
- (5) Manufacturer: **Ntron Ltd.**
- (6) Address: **Mullaghboy Industrial Park, Navan, Country Meath, Ireland**
- (7) The design and construction of this equipment and any acceptable variation thereto are specified in the appendix to this supplement.
- (8) The certification body of DEKRA EXAM GmbH, notified body no. 0158 in accordance with Article 9 of the Directive 94/9/EC of the European Parliament and the Council of 23 March 1994, certifies that this equipment has been found to comply with the Essential Health and Safety Requirements relating to the design and construction of equipment and protective systems intended for use in potentially explosive atmospheres, given in Annex II to the Directive. The examination and test results are recorded in the Test and Assessment Report BVS PP 13.2019 EG.
- (9) The Essential Health and Safety Requirements are assured by compliance with:
  - EN 60079-0:2012 + A11:2013 General requirements**
  - EN 60079-11:2012 Intrinsic safety "i"**
  - EN 60079-26:2007 Equipment with equipment protection level (EPL) Ga**
- (10) If the sign "X" is placed after the certificate number, it indicates that the equipment is subject to special conditions for safe use specified in the appendix to this certificate.
- (11) This supplement to the EC-Type Examination Certificate relates only to the design, examination and tests of the specified equipment in accordance to Directive 94/9/EC. Further requirements of the Directive apply to the manufacturing process and supply of this equipment. These are not covered by this certificate.
- (12) The marking of the equipment shall include the following:

 **II (1) G [Ex ia Ga] IIC**  
**II (1) D [Ex ia Da] IIIC**

DEKRA EXAM GmbH  
 Bochum, dated 2015-07-17

Signed: Simanski

Signed: Dr. Eickhoff

Certification body

Special services unit

- (13) Appendix to
- (14) **1<sup>st</sup> Supplement to the EC-Type Examination Certificate  
BVS 13 ATEX E 010**
- (15) 15.1 Subject and type  
Sil-O2 Analyzer Type 01-758  
  
15.2 Description  
The analyzer can be modified according to the descriptive documents as mentioned in the pertinent test and assessment report.  
The intrinsically safe circuit of the analyzer can also be led into areas endangered by explosive dust atmospheres. This leads to a modified marking.  
  
15.3 Parameters  
Not changed
- (16) Test and Assessment Report  
BVS PP 13.2019 EG as of 2015-07-17
- (17) Special conditions for safe use  
None

---

We confirm the correctness of the translation from the German original.  
In the case of arbitration only the German wording shall be valid and binding.

DEKRA EXAM GmbH  
44809 Bochum, 2015-07-17  
BVS-Schu/Ma A 20150555

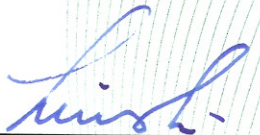

Certification body

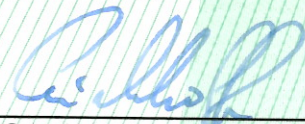

Special services unit



# (1) EG-Baumusterprüfbescheinigung

- (2) Geräte und Schutzsysteme zur bestimmungsgemäßen Verwendung in explosionsgefährdeten Bereichen - Richtlinie 94/9/EG
- (3) Nr. der EG-Baumusterprüfbescheinigung: **BVS 13 ATEX E 010**
- (4) Gerät: **Sauerstoff Analysator Typ SiLO2**
- (5) Hersteller: **Ntron Ltd.**
- (6) Anschrift: **Mullaghboy Industrial Park, Navan, County Meath, Ireland**
- (7) Die Bauart dieses Gerätes sowie die verschiedenen zulässigen Ausführungen sind in der Anlage zu dieser Baumusterprüfbescheinigung festgelegt.
- (8) Die Zertifizierungsstelle der DEKRA EXAM GmbH, benannte Stelle Nr. 0158 gemäß Artikel 9 der Richtlinie 94/9/EG des Europäischen Parlaments und des Rates vom 23. März 1994, bescheinigt, dass das Gerät die grundlegenden Sicherheits- und Gesundheitsanforderungen für die Konzeption und den Bau von Geräten und Schutzsystemen zur bestimmungsgemäßen Verwendung in explosionsgefährdeten Bereichen gemäß Anhang II der Richtlinie erfüllt. Die Ergebnisse der Prüfung sind in dem Prüfprotokoll BVS PP 13.2019 EG niedergelegt.
- (9) Die grundlegenden Sicherheits- und Gesundheitsanforderungen werden erfüllt durch Übereinstimmung mit
- EN 60079-0:2012 Allgemeine Anforderungen**  
**EN 60079-11:2012 Eigensicherheit „i“**  
**EN 60079-26:2007 Betriebsmittel mit Geräteschutzniveau (EPL) Ga**
- (10) Falls das Zeichen „X“ hinter der Bescheinigungsnummer steht, wird in der Anlage zu dieser Bescheinigung auf besondere Bedingungen für die sichere Anwendung des Gerätes hingewiesen.
- (11) Diese EG-Baumusterprüfbescheinigung bezieht sich nur auf die Konzeption und die Baumusterprüfung des beschriebenen Gerätes in Übereinstimmung mit der Richtlinie 94/9/EG. Für Herstellung und Inverkehrbringen des Gerätes sind weitere Anforderungen der Richtlinie zu erfüllen, die nicht durch diese Bescheinigung abgedeckt sind.
- (12) Die Kennzeichnung des Gerätes muss die folgenden Angaben enthalten:

 **II (1) G [Ex ia Ga] IIC**

DEKRA EXAM GmbH  
 Bochum, den 1. Februar 2013

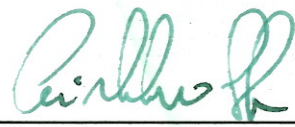

Zertifizierungsstelle



Fachbereich

- (13) Anlage zur
- (14) **EG-Baumusterprüfbescheinigung  
BVS 13 ATEX E 010**

(15) 15.1 Gegenstand und Typ

Sauerstoff Analysator Typ SilO2

15.2 Beschreibung

Der Sauerstoff Analysator, der außerhalb des explosionsgefährdeten Bereiches errichtet wird, dient zur Umwandlung eines eigensicheren Eingangssignals in nicht-eigensichere Signale.

15.3 Kenngrößen

15.3.1 Versorgungstromkreis (Klemmen 3 und 4 bzw. Anschl. KT-B4 und KT-B5)				
Bemessungsspannung		DC	19...30	V
		AC	18...28	V
max. Spannung	Um	AC/DC	250	V
15.3.2 Nichteigensicherer RS485-Schnittstellenstromkreis (Anschl. KT-B1 und KT-B2)				
Bemessungsspannung		DC	6	V
Bemessungsstromstärke			100	mA
max. Spannung	Um	AC/DC	48	V
15.3.3 Nichteigensichere Relaiskontakt-Stromkreise (Klemmen 1-2, 5-6 und 9-10)				
Schaltspannung		DC	30	V
Schaltstromstärke			1	A
oder				
Schaltspannung		AC	125	V
Schaltstromstärke			0,5	A
max. Spannung	Um	AC/DC	125	V
15.3.4 Nichteigensicherer Digital-Ausgangsstromkreis (Klemmen 7-8)				
Bemessungsspannung		DC	28	V
Bemessungsstromstärke			50	mA
max. Spannung	Um	AC/DC	125	V
15.3.5 Nichteigensicherer Analog-Ausgangsstromkreis (Klemmen 11 und 12)				
Bemessungsspannung		DC	20	V
Bemessungsstromstärke			50	mA
max. Spannung	Um	AC/DC	125	V
15.3.6 Eigensicherer mV-Eingangsstromkreis (Klemmen 14 und 16)				
Spannung	Uo	DC	6	V
Stromstärke	Io		0,2	mA
Leistung	Po		0,3	mW
Äußere Induktivität	Lo		1000	mH
Äußere Kapazität	Co		10	µF
Für diesen Stromkreis gelten auch die folgenden Werte:				
Innere Kapazität	Ci		0,2	µF
Innere Induktivität	Li		vernachlässigbar	
Zum Anschluss eines eigensicheren Stromkreises mit folgendem Höchstwert:				
Spannung	Ui	DC	1	V
15.3.7 Umgebungstemperaturbereich	Ta		- 20 °C bis + 60 °C	



(16) Prüfprotokoll

BVS PP 13.2019 EG, Stand 01.02.2013

(17) Besondere Bedingungen für die sichere Anwendung

Entfällt

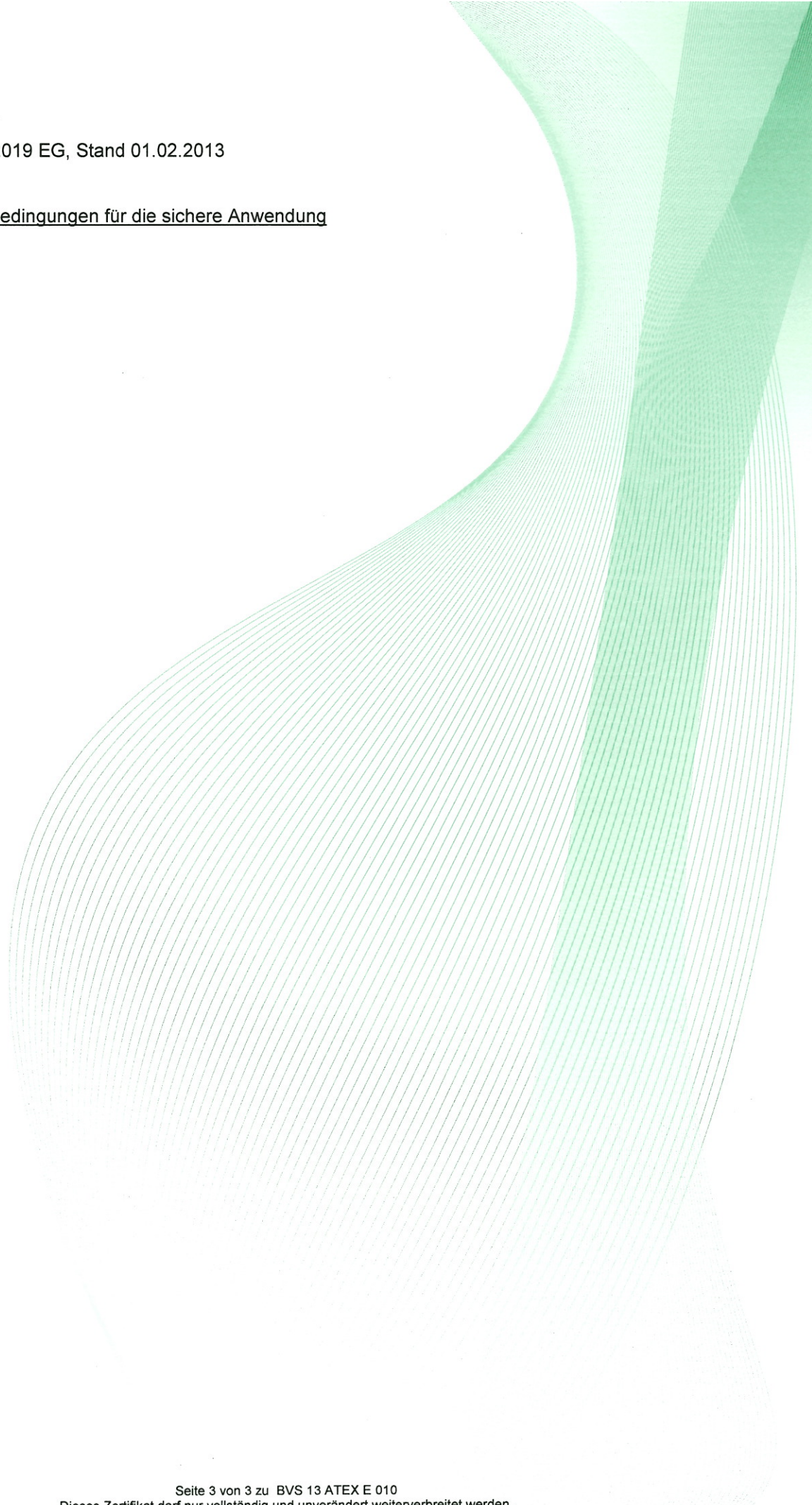

# (1) 1. Nachtrag zur EG-Baumusterprüfbescheinigung

- (2) Geräte und Schutzsysteme zur bestimmungsgemäßen Verwendung in explosionsgefährdeten Bereichen - Richtlinie 94/9/EG  
Ergänzung gemäß Anhang III Ziffer 6
- (3) Nr. der EG-Baumusterprüfbescheinigung: **BVS 13 ATEX E 010**
- (4) Gerät: **Sil-O2 Analysator Typ 01-758**
- (5) Hersteller: **Ntron Ltd.**
- (6) Anschrift: **Mullaghyboy Industrial Park, Navan, Country Meath, Ireland**
- (7) Die Bauart dieser Geräte sowie die verschiedenen zulässigen Ausführungen sind in der Anlage zu diesem Nachtrag festgelegt.
- (8) Die Zertifizierungsstelle der DEKRA EXAM GmbH, benannte Stelle Nr. 0158 gemäß Artikel 9 der Richtlinie 94/9/EG des Europäischen Parlaments und des Rates vom 23. März 1994, bescheinigt, dass diese Geräte die grundlegenden Sicherheits- und Gesundheitsanforderungen für die Konzeption und den Bau von Geräten und Schutzsystemen zur bestimmungsgemäßen Verwendung in explosionsgefährdeten Bereichen gemäß Anhang II der Richtlinie erfüllen. Die Ergebnisse der Prüfung sind in dem Prüfprotokoll BVS PP 13.2019 EG niedergelegt.
- (9) Die grundlegenden Sicherheits- und Gesundheitsanforderungen werden erfüllt durch Übereinstimmung mit  
  
**EN 60079-0:2012 + A11:2013 Allgemeine Anforderungen**  
**EN 60079-11:2012 Eigensicherheit „i“**  
**EN 60079-26:2007 Betriebsmittel mit Geräteschutzniveau (EPL) Ga**
- (10) Falls das Zeichen "X" hinter der Bescheinigungsnummer steht, wird in der Anlage zu dieser Bescheinigung auf besondere Bedingungen für die sichere Anwendung des Gerätes hingewiesen.
- (11) Dieser Nachtrag zur EG-Baumusterprüfbescheinigung bezieht sich nur auf die Konzeption und die Baumusterprüfung der beschriebenen Geräte in Übereinstimmung mit der Richtlinie 94/9/EG. Für Herstellung und Inverkehrbringen der Geräte sind weitere Anforderungen der Richtlinie zu erfüllen, die nicht durch diese Bescheinigung abgedeckt sind.
- (12) Die Kennzeichnung des Gerätes muss die folgenden Angaben enthalten:

**II (1) G [Ex ia Ga] IIC**  
**II (1) D [Ex ia Da] IIIC**

DEKRA EXAM GmbH  
 Bochum, den 17.07.2015

  
 \_\_\_\_\_  
 Zertifizierungsstelle

  
 \_\_\_\_\_  
 Fachbereich

- (13) Anlage zum
- (14) **1. Nachtrag zur EG-Baumusterprüfbescheinigung  
BVS 13 ATEX E 010**
- (15) 15.1 Gegenstand und Typ  
Sil-O2 Analysator Typ 01-758  
  
15.2 Beschreibung  
Der Analysator kann auch nach den im zugehörigen Prüfprotokoll aufgeführten Prüfungsunterlagen gefertigt werden.  
Der eigensichere Stromkreis des Analysators kann auch in Bereiche geführt werden, die durch Staubatmosphären explosionsgefährdet sind. Das führt zu einer geänderten Kennzeichnung.  
  
15.3 Kenngrößen  
Unverändert
- (16) Prüfprotokoll  
BVS PP 13.2019 EG, Stand 17.07.2015
- (17) Besondere Bedingungen für die sichere Anwendung  
Entfällt

### 5.3 Sensor CE and ATEX Certificates

- CE Certificate SUII01, SUII02
- ATEX Certificate BAS02ATEX1230X-11

**EU Declaration of Conformity**  
**EG-Konformitätserklärung / Déclaration de conformité CE /**  
**Declaración de conformidad CE:**

We declare, under our sole responsibility, that we believe the products identified in this declaration, and to which this declaration relates are in conformity with the requirements of the EU Council Directives as stated below; Directive 2014/34/EU equipment and protective systems intended for use in potentially explosive atmospheres. Directive 2011/65/EU and of Council of 8th June 2011 on the restriction of the use of certain hazardous substances in electrical and electronic equipment (RoHS2)(\*)

\*OJ L 174, 1.7.2011, p.88 & P106 Annex IV 1b exemption.

Wir erklären in alleiniger Verantwortung, dass wir der Ansicht sind, dass die in dieser Erklärung genannten Produkte, auf die sich diese Erklärung bezieht, den Anforderungen der unten aufgeführten Richtlinien des EU-Rats entsprechen; Richtlinie 2014/34 / EU Geräte und Schutzsysteme zur bestimmungsgemäßen Verwendung in explosionsgefährdeten Bereichen. Richtlinie 2011/65 / EU und des Rates vom 8. Juni 2011 zur Beschränkung der Verwendung bestimmter gefährlicher Stoffe in Elektro- und Elektronikgeräten (RoHS2) (\*) \* ABl. L 174 vom 1.7.2011, S. 88 & S. 106 Anhang IV 1b Befreiung.

Nous déclarons, sous notre seule responsabilité, que nous croyons que les produits identifiés dans cette déclaration, et auxquels cette déclaration se rapporte, sont conformes aux exigences des directives du Conseil de l'UE comme indiqué ci-dessous; Directive 2014/34 / EU équipements et systèmes de protection destinés à être utilisés dans des atmosphères explosibles. Directive 2011/65 / UE et du Conseil du 8 juin 2011 relative à la limitation de l'utilisation de certaines substances dangereuses dans les équipements électriques et électroniques (RoHS2) (\*) \* JO L 174 du 1.7.2011, p.88 et P106 Annexe IV 1b.

Declaramos, bajo nuestra exclusiva responsabilidad, que creemos que los productos identificados en esta declaración, y a los que se refiere esta declaración, están en conformidad con los requisitos de las Directivas del Consejo de la UE como se establece a continuación; Directiva 2014/34 / UE equipos y sistemas de protección destinados a ser utilizados en atmósferas potencialmente explosivas. Directiva 2011/65 / UE y del Consejo, de 8 de junio de 2011, sobre la restricción del uso de determinadas sustancias peligrosas en aparatos eléctricos y electrónicos (RoHS2) (\*) \* DO L 174 de 1.7.2011, p.88 y P106 Anexo IV 1b exención.

<i>Description of Equipment:</i> <i>Beschreibung des Gerätes:</i> <i>Description du matériel:</i> <i>Descripción de la máquina:</i>	OC-Type Oxygen Sensors For Use in Hazardous Areas.
--	--

<i>Standards applied:</i> <i>Normes appliquées:</i> <i>Normas aplicadas:</i>	EN60079-0:2012 + A11:2013 EN60079-11:2012
--	--

<i>Marking:</i> <i>Kennzeichnung:</i> <i>Marquage:</i> <i>Marcado:</i>	 II 1 GD Ex ia IIC T6 Ga(-20°C≤Ta≤+55°C) Ex ia IIIC T90°C Da(-20°C≤Ta≤+55°C) Certificate No: BAS02ATEX1230X (Other markings: IECEx BAS 09.0148X)
---	--

<i>Notified Body:</i> <i>Benannte Stelle:</i> <i>Organisme notifié:</i> <i>Organismo notificado:</i>	SGS Baseefa Rockhead Business Park Staden Lane, Buxton, Derbyshire, SK17 9RZ, UK. Notified Body Number: 1180
---	--

The Authorised Signatory to this declaration, on behalf of the manufacturer, is identified below:

**Name:** David Beirne      **Title/Titel/ Titre/ título:** Managing Director/Geschäftsführer/Directeur-Général/director Gerente

**Address/Adresse/ dirección:** Ntron Ltd  
Mullaghboy Industrial Estate  
Navan  
Co. Meath  
Ireland, C15 XD61  
Ph: 00353469071333  
Fx: 00353469071331  
email: info@ntron.com  
Web: www.ntron.com

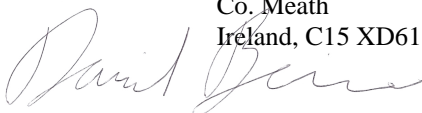
Signature:  Date: 12/02/2019





**1 EU - TYPE EXAMINATION CERTIFICATE**

**2 Equipment or Protective System Intended for use in Potentially Explosive Atmospheres  
Directive 2014/34/EU**

**3** EU - Type Examination Certificate **BAS02ATEX1230X – Issue 11**  
Number:

**3.1** In accordance with Article 41 of Directive 2014/34/EU, EC-Type Examination Certificates referring to 94/9/EC that were in existence prior to the date of application of 2014/34/EU (20 April 2016) may be referenced as if they were issued in accordance with Directive 2014/34/EU. Supplementary Certificates to such EC-Type Examination Certificates, and new issues of such certificates, may continue to bear the original certificate number issued prior to 20 April 2016.

**4** Product: **A Series of Oxygen Sensors**

**5** Manufacturer: **Ntron Limited**

**6** Address: **Mullaghboy Industrial Estate, Navan, County Meath, Ireland**

**7** This re-issued certificate extends EC - Type Examination Certificate No. BAS02ATEX1230X to apply to product designed and constructed in accordance with the specification set out in the Schedule of the said certificate but having any variations specified in the Schedule attached to this certificate and the documents therein referred to

**8** The original certificate was issued by The Electrical Equipment Certification Service, Notified Body Number 0600, which retains responsibility for its original documentation. SGS Baseefa, Notified Body Number 1180, in accordance with Article 17 of Directive 2014/34/EU of the European Parliament and of the Council, dated 26 February 2014, is responsible only for the additional work relating to this re-issued certificate and any other supplementary certificate it has issued.

The examination and test results are recorded in confidential Report No. **See certificate history**

**9** Compliance with the Essential Health and Safety Requirements has been assured by compliance with:

**EN 60079-0: 2012 + A11: 2013 EN 60079-11: 2012**

except in respect of those requirements listed at item 18 of the Schedule.

**10** If the sign “X” is placed after the certificate number, it indicates that the product is subject to the Specific Conditions of Use specified in the schedule to this certificate.

**11** This EU - TYPE EXAMINATION CERTIFICATE relates only to the design and construction of the specified product. Further requirements of the Directive apply to the manufacturing process and supply of this product. These are not covered by this certificate.

**12** The marking of the product shall include the following :

⊕ II 1GD **Ex ia IIC T6 Ga (-20°C ≤ Ta ≤ +55°C)**  
**Ex ia IIIC T90°C Da (-20°C ≤ Ta ≤ +55°C)**

SGS Baseefa Customer Reference No. **2144**

Project File No. **18/0344**

This document is issued by the Company subject to its General Conditions for Certification Services accessible at <http://www.sgs.com/en/Terms-and-Conditions.aspx> and the Supplementary Terms and Conditions accessible at <http://www.sgs.com/SGSBaseefa/Terms-and-Conditions.aspx>. Attention is drawn to the limitation of liability, indemnification and jurisdiction issues defined therein. Any holder of this document is advised that information contained herein reflects the Company's findings at the time of its intervention only and within the limits of Client's instructions, if any. It does not necessarily indicate that the equipment may be used in particular industries or circumstances. The Company's sole responsibility is to its Client and this document does not exonerate parties to a transaction from exercising all their rights and obligations under the transaction documents. This document cannot be reproduced except in full, schedule included, without prior written approval of the Company. Any unauthorized alteration, forgery or falsification of the content or appearance of this document is unlawful and offenders may be prosecuted to the fullest extent of the law.

**SGS Baseefa Limited**

Rockhead Business Park, Staden Lane,  
Buxton, Derbyshire SK17 9RZ

Telephone +44 (0) 1298 766600 Fax +44 (0) 1298 766601

e-mail [baseefa@sgs.com](mailto:baseefa@sgs.com) web site [www.sgs.co.uk/sgsbaseefa](http://www.sgs.co.uk/sgsbaseefa)

Registered in England No. 4305578.

Registered address: Rossmore Business Park, Ellesmere Port, Cheshire, CH65 3EN



R S SINCLAIR

TECHNICAL MANAGER

On behalf of SGS Baseefa Limited

D BREARLEY  
Certification  
Manager

ENGLISH

## SENSOR USE/INSTALLATION INSTRUCTIONS

### PRELIMINARY ADVICE

To ensure security of personnel, goods and plant it is important that the national standards laid down for the installation of electrical equipment are followed, that instructions on the nomenclature are achieved, and that the work is carried out by trained personnel. Furthermore, it is necessary to use the oxygen sensor in accordance with the advice and data given in this text.

Oxygen sensors for hazardous areas are especially designed to conform to national and international standards governing risks of explosion and certification for each type are issued by an approved organisation or notified body. Be careful! A certification number followed with 'X' or a 'U' requires specific conditions for use.

**The Specific Condition of Use for the sensor types listed below is: Possible Electrostatic Risk-Do not charge by Rubbing and do not clean with Solvent**

### STORAGE

The sensor should be stored in a cool dry place.

### HANDLING WARNINGS

Do not expose open end of sensor housing to liquids, particulates, grease, or oil.

Do not touch top of sensor with open end of sensor housing.

Do not allow vacuum grease to coat open end of sensor.

Do not expose sensor to sudden mechanical shocks.

### INSTALLATION & CALIBRATION

Remove the sensor plug from the old sensor.

Remove the old sensor by unscrewing counter clock wise.

Install the replacement sensor threading on clockwise.

Fully tighten the sensor housing.

Re-connect the sensor plug.

Calibrate the analyser to the new sensor.

Note: The system must not be put back on-line until the analyser has been calibrated to the new sensor.

### ELECTRICAL CERTIFICATION

Sensor\_Type's OxyProbe<sub>gas</sub> Sensor Probe carry the following markings:

OXYGEN SENSOR



1GD

BAS02A.TEX1230X  
Ex IIa IIC T100°C D1-20(CST:R5+55°C)  
Ex II IIC T100°C D1-20(CST:R5+55°C)  
IECEx BAS 09.0148X  
UL:12V, II:120mA, Pt: 0.55W, Cl:1.2Mf, LI:0

### Application Note For All Sensor Types:

The Oxygen Sensors must only be used within the temperature range quoted in the certification details, and will withstand a 500V isolation test between the input connection and frame of the apparatus.

### MAINTENANCE

If the sensor will no longer re-calibrate, it should be replaced. It is recommended that sensors be replaced after 36 months.

FRENCH

## INSTALLATION ET UTILISATION DU CAPTEUR

### INDICATIONS PRELIMINAIRES

Pour assurer la sécurité du personnel, des biens et de l'usine, il est important de respecter les normes nationales en vigueur pour l'installation des équipements électriques, de se conformer aux consignes figurant sur la plaque du constructeur et de confier la réalisation des travaux à un personnel qualifié. De plus, le capteur d'oxygène doit être utilisé dans le respect des indications et des données fournies par la présente notice.

Les capteurs d'oxygène pour zones dangereuses sont spécialement conçus pour respecter les normes nationales et internationales réglementant les risques d'explosion. En outre, des certificats sont délivrés pour chaque type de capteur par un organisme agréé ou un organisme notifié. Attention : un numéro de certificat suivi d'un « X » ou d'un « U » signifie que des conditions d'utilisation particulières sont requises.

Les conditions spécifiques d'utilisation pour les types de capteurs sont énumérées ci-dessous.  
**Possibles risques électrostatiques Ne pas charger par frottement et ne pas nettoyer avec des solvants.**

### STOCKAGE

Stockez le capteur dans un endroit sec et frais.

### NE PAS EXPOSER L'EXTÉRIEUR OUVERT DU BOUTIER DU CAPTEUR AUX LIQUIDES, AUX PARTICULES, À LA GRAISSE OU À L'HUILE.

Ne pas toucher la tête du capteur à travers l'extrémité ouverte du boîtier du capteur.

Ne pas laisser de graisse à vide recouvrir l'extrémité ouverte du capteur.

Ne pas exposer le capteur à des chocs violents.

### INSTALLATION MECANIQUE

Débrancher la prise du capteur de l'ancien capteur.

Retenir l'ancien capteur en dévissant dans le sens inverse des aiguilles d'une montre.

Poser le capteur de remplacement en vissant dans le sens des aiguilles d'une montre.  
Serrer Complètement à fond le boîtier du capteur.  
Retrancher la prise du capteur.

### CERTIFICATION ELECTRIQUE

Les capteurs de type OxyProbe<sub>gas</sub> Sensor Probedoportent les inscriptions suivantes :

OXYGEN SENSOR



1GD

BAS02A.TEX1230X  
Ex IIa IIC T100°C D1-20(CST:R5+55°C)  
Ex II IIC T100°C D1-20(CST:R5+55°C)  
IECEx BAS 09.0148X  
UL:12V, II:120mA, Pt: 0.55W, Cl:1.2Mf, LI:0

### Note concernant l'utilisation de tous les Types de capteurs :

Les capteurs d'oxygène doivent être utilisés uniquement dans la plage de température indiquée dans les détails de la certification, et ils résistent à un test d'isolation de 500 V entre la connexion d'entrée et le châssis de l'appareil.

### ENTRETIEN

Si le capteur ne sera plus recalibrer, il doit être remplacé. Il est recommandé que les capteurs être remplacés après 36 mois.

GERMAN

## BEDIENUNGS- UND INSTALLATIONSANLEITUNG DES SENSORS

### VORABHINWEIS

Um die Sicherheit von Personal, Gütern und Anlage gewährleisten zu können, ist es wichtig, dass die nationalen Normen für die Installation elektrischer Geräte befolgt werden, dass die Anweisungen auf dem Typenschild ausgeführt werden und dass die Arbeit von Fachpersonal erledigt wird. Des Weiteren ist es erforderlich, den Sauerstoffsensoren gemäß den Hinweisen und Angaben in diesem Text zu verwenden.

Sauerstoffsensoren für Gefahrenbereiche werden so konstruiert, dass sie nationalen und internationalen Normen entsprechen, um so einer Explosionsgefahr vorzubeugen, und für jeden Typ werden von einer anerkannten Organisation oder benannten Stelle Zertifikate ausgestellt. Vorsicht! Bei einer Zertifizierungsnummer mit einem 'X' oder einem 'U' am Ende sind spezielle Bedingungen für den Gebrauch erforderlich.

**Die spezifische Voraussetzung für die Nutzung der Sensor unten angegeben Typen ist möglicher elektrostatischer Risk-Laden Sie nicht durch Reiben und nicht mit Lösungsmittel reinigen.**

### LAGERUNG

Der Sensor sollte kühl und trocken gelagert werden.

### WARNHINWEISE

Setzen Sie das offene Ende des Sensorgehäuses nicht Flüssigkeiten, Schweißstoffen, Fett oder Öl aus.

Berühren Sie nicht die Spitze des Sensors im offenen Ende des Sensorgehäuses.

Achten Sie darauf, dass kein Vakuumfett das offene Ende des Sensors überzieht.

Setzen Sie den Sensor keinen plötzlichen mechanischen Erschütterungen aus.

### MECHANISCHE INSTALLATION

Ziehen Sie den Stecker vom alten Sensor aus.

Entfernen Sie den alten Sensor, indem Sie ihn entgegen dem Uhrzeigersinn losdrehen.

Installieren Sie den Austauschsensor, indem Sie ihn im Uhrzeigersinn einbringen.  
Ziehen Sie den Sensor Fall in vollem Umfang ein.  
Schließen Sie den Stecker des Sensors wieder an.

### ELEKTRISCHE ZERTIFIZIERUNG

Sensoren des Typs OxyProbe<sub>gas</sub> Sensor Probe weisen folgende Beschriftung auf.

OXYGEN SENSOR



1GD

BAS02A.TEX1230X  
Ex IIa IIC T100°C D1-20(CST:R5+55°C)  
Ex II IIC T100°C D1-20(CST:R5+55°C)  
IECEx BAS 09.0148X  
UL:12V, II:120mA, Pt: 0.55W, Cl:1.2Mf, LI:0

### Hinweis für alle Sensortypen:

Die Sauerstoffsensoren dürfen nur im Temperaturbereich in den Zertifizierungangaben zitiert eingesetzt werden, und halten einer 500 V-Isolationstprüfung zwischen Eingangsanschluss und Geräterahmen stand.

### WARTUNG

Wenn der Sensor nicht mehr neu zu kalibrieren, sollte sie ausgewechselt werden. Es wird empfohlen, Sensoren nach 36 Monaten ausgetauscht werden.

SPANISH

## MANUAL DE USO E INSTALACION DEL SENSOR

### INSTRUCCIONES PRELIMINARES

Con el fin de garantizar la seguridad del personal, de los productos y de las instalaciones, es importante que se cumplan los estándares nacionales establecidos para la instalación de equipos eléctricos, que se sigan las instrucciones que indica la placa y que el trabajo sea llevado a cabo por personal cualificado. Además, se requiere el uso del sensor de oxígeno de acuerdo con las instrucciones y la información que aporta este documento.

Los sensores de oxígeno para áreas peligrosas están especialmente diseñados para ajustarse a los estándares nacionales e internacionales que regulan los riesgos de explosión, y los certificados de cada tipo han sido expedidos por una organización autorizada o un organismo notificado. Advertencia: Un número de certificación seguido de 'X' o 'U' necesita unas condiciones específicas para su uso.

**Las condiciones específicas de uso de los tipos de sensores se enumeran a continuación. Posible riesgo electrostático-No cobrar por frotamiento y no limpiar con solvente.**

### ALMACENAJE

El sensor debe guardarse en un lugar fresco y seco.

### ADVERTENCIAS SOBRE EL MANEJO

No exponga el extremo abierto de la caja del sensor a líquidos, partículas, grasa o aceite.

No toque la parte superior dentro del extremo abierto de la caja del sensor.

Evite que la grasa de vacío cubra el extremo abierto del sensor.

No exponga el sensor a choques mecánicos bruscos.

### INSTALACION MECANICA

Retire el enchufe del sensor antiguo.

Retire el sensor antiguo desorientándolo en sentido contrario al de las agujas del reloj.

Instale el sensor sustituo enroscándolo en el sentido de las agujas del reloj.  
Apriete por completo, el sensor caja.  
Vuelva a conectar el enchufe del sensor.

### CERTIFICACION ELECTRICA

Los tipos de sensor OxyProbe<sub>gas</sub> Sensor Probe presentan las siguientes marcas:

OXYGEN SENSOR



II 1GD

BAS02A.TEX1230X  
Ex IIa IIC T100°C D1-20(CST:R5+55°C)  
Ex II IIC T100°C D1-20(CST:R5+55°C)  
IECEx BAS 09.0148X  
UL:12V, II:120mA, Pt: 0.55W, Cl:1.2Mf, LI:0

### Nota de aplicación para todos los tipos de sensor:

Los sensores de oxígeno solo deben utilizarse dentro del rango de temperatura citado en los detalles de certificación, y resisten una prueba de aislamiento de 500 V entre la conexión de entrada y el marco del aparato.

### MANTENIMIENTO

Si el sensor ya no se volverá a calibrar, debe ser reemplazado. Se recomienda que los sensores pueden reemplazarse después de 36 meses.

## EU Declaration of Conformity

### EG-Konformitätserklärung / Déclaration de conformité CE / Declaración de conformidad CE:

We declare, under our sole responsibility, that we believe the products identified in this declaration, and to which this declaration relates are in conformity with the requirements of the EU Council Directives as stated below;  
Directive 2014/34/EU equipment and protective systems intended for use in potentially explosive atmospheres.  
Directive 2011/65/EU and of Council of 8th June 2011 on the restriction of the use of certain hazardous substances in electrical and electronic equipment (RoHS2)(\*)

\*OJ L 174, 1.7.2011, p.88 & P106 Annex IV 1b exemption.

Wir erklären in alleiniger Verantwortung, dass wir der Ansicht sind, dass die in dieser Erklärung genannten Produkte, auf die sich diese Erklärung bezieht, den Anforderungen der unten aufgeführten Richtlinien des EU-Rats entsprechen; Richtlinie 2014/34 / EU Geräte und Schutzsysteme zur bestimmungsgemäßen Verwendung in explosionsgefährdeten Bereichen. Richtlinie 2011/65 / EU und des Rates vom 8. Juni 2011 zur Beschränkung der Verwendung bestimmter gefährlicher Stoffe in Elektro- und Elektronikgeräten (RoHS2) (\*) \* ABl. L 174 vom 1.7.2011, S. 88 & S. 106 Anhang IV 1b Befreiung.

Nous déclarons, sous notre seule responsabilité, que nous croyons que les produits identifiés dans cette déclaration, et auxquels cette déclaration se rapporte, sont conformes aux exigences des directives du Conseil de l'UE comme indiqué ci-dessous; Directive 2014/34 / EU équipements et systèmes de protection destinés à être utilisés dans des atmosphères explosibles. Directive 2011/65 / UE et du Conseil du 8 juin 2011 relative à la limitation de l'utilisation de certaines substances dangereuses dans les équipements électriques et électroniques (RoHS2) (\*) \* JO L 174 du 1.7.2011, p.88 et P106 Annexe IV 1b.

Declaramos, bajo nuestra exclusiva responsabilidad, que creemos que los productos identificados en esta declaración, y a los que se refiere esta declaración, están en conformidad con los requisitos de las Directivas del Consejo de la UE como se establece a continuación; Directiva 2014/34 / UE equipos y sistemas de protección destinados a ser utilizados en atmósferas potencialmente explosivas. Directiva 2011/65 / UE y del Consejo, de 8 de junio de 2011, sobre la restricción del uso de determinadas sustancias peligrosas en aparatos eléctricos y electrónicos (RoHS2) (\*) \* DO L 174 de 1.7.2011, p.88 y P106 Anexo IV 1b exención.

<i>Description of Equipment:</i> <i>Beschreibung des Gerätes:</i> <i>Description du matériel:</i> <i>Descripción de la máquina:</i>	OxyProbe200 - Oxygen Sensors For Use in Hazardous Areas. OxyProbe200 - Sauerstoff-Sensoren für den Einsatz in explosionsgefährdeten Bereichen/OxyProbe200 - capteurs d'oxygène pour une utilisation dans des zones dangereuses/ OxyProbe200 - Los sensores de oxígeno para su uso en áreas peligrosas.
--	---

<i>Standards applied:</i> <i>Normes appliquées:</i> <i>Normas aplicadas:</i>	EN60079-0:2012 + A11:2013 EN60079-11:2012
--	--

<i>Marking:</i> <i>Kennzeichnung:</i> <i>Marquage:</i> <i>Marcado:</i>	 II 1 GD Ex ia IIC T6 Ga(-20°C≤Ta≤+55°C) Ex ia IIIC T90°C Da(-20°C≤Ta≤+55°C) IECEx BAS 09.0148X Certificate No: BAS02ATEX1230X
---	--

<i>Notified Body:</i> <i>Benannte Stelle:</i> <i>Organisme notifié:</i> <i>Organismo notificado:</i>	SGS Baseefa Rockhead Business Park Staden Lane, Buxton, Derbyshire, SK17 9RZ, UK. Number/Anzahl/nombre/número: 1180
---	---

The Authorised Signatory to this declaration, on behalf of the manufacturer, is identified below:

Der Prokurist dieser Erklärung im Namen des Herstellers, ist unten angegeben:

Le signataire autorisé à cette déclaration, le nom du fabricant, est identifié ci-dessous:

El signatario autorizado a esta declaración, en nombre del fabricante, se identifica a continuación:

**Name:** David Beirne **Title/Titel/ Titre/ título:** Managing Director/Geschäftsführer/ Directeur-  
Général/ director Gerente

**Address/Adresse/ dirección:** Ntron Limited  
Mullaghboy Industrial Estate  
Navan  
Co. Meath  
Ireland, C15 XD61

Signature: 

Date: 25/02/2019

13 **Schedule**

14 **Certificate Number BAS02ATEX1230X – Issue 11**

15 **Description of Product**

The Series of Oxygen Sensors is designed to provide an electrical signal in proportion to the percentage oxygen present in the measured atmosphere. Alternative sensor types are as follows:

Model OC-2/202/224	Standard Oxygen Sensor
Model OC-7/207	In-situ Oxygen Probe
Model OC-16/216	Oxygen Sensor
Model OC-17/18/19/20	Oxygen Sensor
Model OC-21/22/23/24/221	Single or Dual Sensor
Model Oxyprobe 200	Oxygen Probe
Model OC-25	Oxygen Sensor
Model OC-47	Oxygen Sensor
Model OC-26	Oxygen Sensor
Model OC-26M	Oxygen Sensor (Metal Enclosure)
Model OC-28	Oxygen Sensor
Model OC-28M	Oxygen Sensor (Metal Enclosure)
Model OC-25M	Oxygen Sensor (Metal Enclosure)

Each Oxygen Sensor circuit consists of an electrochemical cell together with a resistor encapsulated within a plastic or metal enclosure. For the Dual Sensor versions two circuits are incorporated in one enclosure. An aperture at the bottom of the enclosure allows for gas transfer. External connections are made via an integral plug and socket.

This apparatus is not designed for use in oxygen enriched atmospheres greater than 21% oxygen.

**Input Parameters (Models OC-2, OC-7, OC-16 to OC-18, OC-21 to OC-24, OC-28, OC-28M, OC-47, OC-202, OC-207, OC-216, OC-221 and OC-224):**

$U_i = 30V$ ,  $I_i = 120mA$ ,  $P_i = 0.55W$ ,  $C_i = 0$ ,  $L_i = 0$

**Input Parameters (Oxyprobe 200, Models OC-19, OC-20, OC-25, OC-25M, OC-26 and OC-26M):**

$U_i = 12V$ ,  $I_i = 120mA$ ,  $P_i = 0.55W$ ,  $C_i = 1.2\mu F$ ,  $L_i = 0$

16 **Report Number**

GB/BAS/ExTR18.0198

17 **Specific Conditions of Use**

1. Care must be taken when installing equipment with plastic enclosures or plastic parts of enclosures to ensure that the equipment is protected from any situations that could cause a build-up of static charge. The equipment must not be installed into locations in which it could come into contact with, through normal or abnormal circumstances, fast moving dust laden air/gas or non-conductive fluids. The equipment must be cleaned only with a damp cloth.
2. The metal enclosure of the OC-25M, OC-26M and OC-28M Oxygen sensors are a potential source of electrostatic discharge. The OC-25M, OC-26M and OC-28M Oxygen sensors must be installed in its end-use application in a manner where the metal enclosure is earthed.

## 18 Essential Health and Safety Requirements

In addition to the Essential Health and Safety Requirements (EHSRs) covered by the standards listed at item 9, the following are considered relevant to this product, and conformity is demonstrated in the report:

Clause	Subject
1.2.7	LVD type requirements
1.2.8	Overloading of equipment (protection relays, etc.)
1.4.1	External effects
1.4.2	Aggressive substances, etc.

## 19 Drawings and Documents

New drawings submitted for this issue of certificate:

Number	Sheet	Issue	Date	Description
E165	1 of 1	4	03-07-2018	Sensor Certification Drawing Model OC-17 & 18 / OC-19 & 20
E195	1 of 1	5	15-08-2018	Sensor Certification Drawing Model OC-21, OC-221, OC-22, OC-23, OC-24, OC-25 & OC-47
E523	1 of 1	0	09-08-2018	Model OC-26 and OC-28 Sensors Certification Drawing

Current drawings which remain unaffected by this issue:

Number	Sheet	Issue	Date	Description
E148	1 of 1	G	23/10/2014	Standard Oxygen Sensor Model OC-2, OC-202 & OC-224
E120	1 of 1	5	30/10/14	Model OC-16/OC-216 Oxygen Sensor Certificate Drawing
E292	1 of 1	4	30/10/2014	Oxyprobe 200 Oxygen Sensor
E149	1 of 1	G	30/10/2014	In-Situ Oxygen Probe with Model OC-7, OC-207 Oxygen Sensor Certification Drawing

## 20 Certificate History

Certificate No.	Date	Comments
BAS02ATEX1230	3 September 2002	The release of the prime certificate. The associated test and assessment against the requirements of EN50014:1997 + Amendments 1 & 2, EN50020:1994 and EN50284 is documented in Test Report No. 02(C)0079.
BAS02ATEX1230/1	26 November 2003	To permit the inclusion further sensor types, a change of the first part of the marking to $\text{Ex}$ II 1GD and a change to input parameters for certain types, documented in Test Report No. 03(C)0659.
BAS02ATEX1230/2	3 March 2005	To permit minor changes to the labelling and the inclusion of further sensor types, documented in Test Report No. 05(C)0111.

Certificate No.	Date	Comments
BAS02ATEX1230X Issue 3	14 May 2010	This issue of the certificate incorporates previously issued primary & supplementary certificates into one certificate and confirms the current design meets the requirements of EN60079-0:2004, EN60079-11:2007, EN61241-0:2006 & EN61241-11:2006, and includes revision of the equipment marking in accordance with EN60079-0:2009. At the same time $P_i$ for the unit has been reduced from 1W to 0.75W. Also, in order to comply with the later standards, suffix 'X' has been added to the Certificate number. These changes are documented in Test Reports GB/BAS/ExTR09.0232/00 & GB/BAS/ExTR09.0233/00.
BAS02ATEX1230X Issue 4	29 July 2010	This issue introduces a new sensor model known as OxyExtract. This model is documented in Test Report GB/BAS/ExTR10.0156/00 and has been added to the list in the main schedule.
BAS02ATEX1230X Issue 5	1 October 2010	To permit minor changes to encapsulation in the OxyExtract model and to confirm that all sensors comply with EN60079-0:2009. Changes are documented in Test Report GB/BAS/ExTR10.0222/00
BAS02ATEX1230X Issue 6	23 November 2010	To permit the name OxyExtract to be changed to <i>Oxyprobe 200</i> . No Test Report required for this change.
BAS02ATEX1230X Issue 7	15 July 2011	To permit changes to drawing E148, including the removal of some internal oxygen cell types and the addition of Sensor type OC-224. At the same time the Certificate title and the description in the Schedule have been modified to reflect the way in which type numbers appear on the certification labels. Changes are documented in Test Report GB/BAS/ExTR11.0171/00
BAS02ATEX1230X Issue 8	18 March 2013	To permit various changes to the Oxyprobe 200 including; Alternative electrochemical cell, minor changes to the enclosure, the inclusion of additional optional components and to confirm the new input parameters.  To permit additional equipment, OC-25 to be incorporated in to this certificate  To add an additional of condition of safe use stating that "Models OC-2, OC-17, OC-18, OC-19 and OC-20 must be housed inside an IP-54 rated enclosure."  Changes are documented in Test Report GB/BAS/ExTR13.0051/00
BAS02ATEX1230X Issue 9	6 January 2015	To permit modification of the input parameters and extension of the rated ambient to -20°C to +55°C.  To allow the inclusion of an alternative oxygen sensor forming new models OC-202, OC-207, OC-216 and OC-221  To confirm that the Series of Oxygen sensors has been assessed against IEC 60079-0:2011 and IEC 60079-11:2011 with respect to the differences from IEC 60079-0:2004, IEC 60079-0:2007, IEC 60079-11:2006, IEC 61241-0:2004 and IEC 61241-11:2005 and that none of the differences affect the equipment.  Changes are documented in Test Report GB/BAS/ExTR14.0565/00  Change of Company Name

<b>Certificate No.</b>	<b>Date</b>	<b>Comments</b>
BAS02ATEX1230X Issue 10	3 December 2015	To permit the inclusion of an alternative Oxygen Sensor forming new Model OC-47.  Changes are documented in Test Report GB/BAS/ExTR15.0350/00
BAS02ATEX1230X Issue 11	3 September 2018	To permit the inclusion of an alternative Oxygen Sensor forming new Models OC-25M, OC-26, OC-26M, OC-28 and OC-28M. Certificate also permits new constructions for sensors OC-19 and OC-20. Changes are documented in Test Report GB/BAS/ExTR18.0198/00. Project 18/0344.

For drawings applicable to each issue, see original of that issue.

**Ntron Ltd.**  
**Mullaghboy Industrial Estate,**  
**Navan, County Meath, Ireland.**  
**00353 46 9071333**  
**[www.ntron.com](http://www.ntron.com)**