



## SERVOPRO 4900 Multigas Analyzer

### Quick Start Guide PN 0890000Q



## **IMPORTANT INFORMATION**

*Continued safe and reliable operation of this equipment is conditional on all installation, operation and maintenance procedures being carried out in accordance with the appropriate manuals, by personnel having appropriate qualifications, experience and training. Failure to observe the requirements of the manual may result in the user being held responsible for the consequences and may invalidate any warranty. Servomex accepts no liability for unauthorized modifications to Servomex supplied equipment.*

*Servomex has paid particular attention to Health and Safety throughout this manual. Where special precautions need to be taken due to the nature of the equipment or product, an appropriate safety icon and warning message is shown. Special attention should be made to section 2 – Safety, where all such messages are summarized.*

*This document, and all specifications and drawings within the document, are the property of Servomex, unless agreed otherwise by contract. They must not be reproduced, copied or transmitted in any form, or by any means, or used as the basis for the manufacture or sale of apparatus, programs or services without permission.*

*In line with our continuous policy of research and development, we reserve the right to amend models and specifications without prior notice therefore the information in this document is subject to change without notice and does not represent a commitment on the part of Servomex Group Limited. This handbook is accurate at the date of printing, but will be superseded and should be disregarded if specifications or appearance are changed. Check the internet for updates to the manual. The latest revision of this manual is available in Adobe Acrobat format at [www.servomex.com](http://www.servomex.com).*

*The customer agrees that in accepting and using this instrument Servomex's liability arising from or in any way connected with this instrument shall be limited exclusively to performing a new calibration or replacement or repair of the instrument or transducer, at Servomex's sole option, as covered by Servomex's warranty. In no event shall Servomex be liable for any incidental, consequential or special damages of any kind or nature whatsoever, including but not limited to lost profits arising from or in any way connected with this instrument or items hereunder, whether alleged to arise from breach of contract, express or implied warranty, or in tort, including without limitation, negligence, failure to warn or strict liability.*

*Servomex is a registered trademark of Servomex Group Inc. The use of all trademarks in this document is acknowledged.*

### **North America:**

Servomex Group Inc.  
4 Constitution Way  
Woburn MA 01801-1087  
United States

t: +1 781 935 4600  
t: +1 800 433 2552 (US toll free)  
f: + 1 781 938 0531  
e: [americas\\_sales@servomex.com](mailto:americas_sales@servomex.com)  
w: [www.servomex.com](http://www.servomex.com)

### **Europe:**

Servomex Group Ltd  
Jarvis Brook  
Crowborough  
East Sussex TN6 3FB  
United Kingdom

t: + 44 (0) 1892 652 181  
f: + 44 (0) 1892 662 253  
e: [europa\\_sales@servomex.com](mailto:europa_sales@servomex.com)  
w: [www.servomex.com](http://www.servomex.com)

### **Representative:**

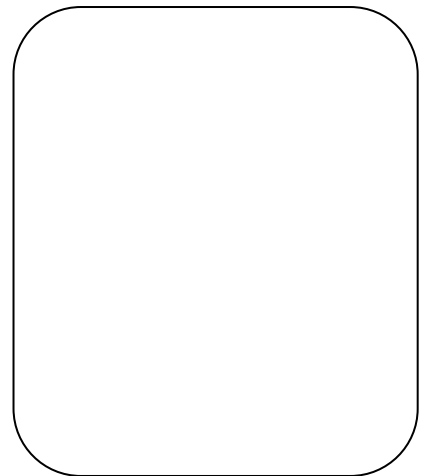

© 2018. Servomex Group Limited. A Spectris Company. All rights reserved

# Contents

<b>1</b>	<b>Introduction</b>	<b>5</b>
1.1	About this Quick Start Guide	5
1.2	Applicable EU Directives, Standards, Certification	6
1.3	Product overview	6
1.4	General description	7
1.5	Recommended calibration intervals	8
1.6	Automatic calibration options	9
1.7	Product identification	10
1.8	Sample requirements	12
<b>2</b>	<b>Safety</b>	<b>12</b>
2.1	General warnings	12
2.2	Chemical warnings	13
2.3	Electrical warnings	14
2.4	Electromagnetic Compatibility (EMC) considerations	14
2.5	Markings	15
<b>3</b>	<b>Installation and set-up</b>	<b>16</b>
3.1	Unpacking	16
3.2	Mechanical Installation	18
3.2.1	Bench mounting	18
3.2.2	Rack mounting	18
3.3	Electrical installation	19
3.3.1	Electrical safety	19
3.3.5	Connect the electrical supply	25
3.4	Sample / calibration gas connections	26
3.4.1	Sample and Calibration Gas Inlets and Outlets	26
3.4.2	Gas connections	27
3.4.3	Gas Flow Rate	27
3.5	View flow levels	28
3.6	Switch off the analyser	28
3.7	Power up	29
<b>4</b>	<b>User interface</b>	<b>31</b>
4.1	User Interface Overview	31
4.2	Introduction	31
4.3	General techniques	32
4.4	Touchscreen and Navigation overview	33
4.1	Home screen	36
4.2	Main Menu screen icons	37
4.3	Frequently Used Touchscreen icons	38
4.4	System and measurement status icons and notices	39

<b>5</b>	<b>Technical specification .....</b>	<b>40</b>
5.1	Mechanical specification.....	40
5.2	Electrical specification .....	41
5.3	Maximum voltage ratings.....	42
5.4	Environmental limits.....	42
<b>6</b>	<b>Storage and disposal.....</b>	<b>43</b>
6.1	Storage .....	43
6.2	Disposal .....	43
<b>7</b>	<b>Warranty 44</b>	
7.1	Maintenance policy .....	45
7.2	Return Authorization Request.....	45

**Quick Start Guide P/N: 0890000Q**

**Revision: MG4900QSG4.0**

# 1 Introduction

---

## 1.1 About this Quick Start Guide

### 1.1.1 Scope of the Quick Start Guide

This guide covers the basics of the installation, connections, software interface overview and routine maintenance of the 4900 Multigas Analyzer. It is not intended to be a full installation manual but is a quick guide for those that are familiar with the use and maintenance of analytical or process instrumentation.

A separate 4900 Multigas Analyzer Installation and Operations manual is also supplied with the analyzer that provides details on the software configuration and operation of the analyzer.

The information in this guide is general.

Use this manual for:

- Installation: To take commissioning to the point where the analyzer is powered and operational. The installer is advised to read the full manual completely before completing installation.
- Configuration: How to set up the clock, alarm levels, analogue outputs, relays and other parameters.

### 1.1.2 Safety information

Read this Quick Start Guide and the full 4900 Installation and Operations manual and make sure you fully understand its contents before you attempt to install or operate the analyzer.

The following icons are used throughout the manuals to identify any potential hazards that could cause serious injury to people. Always follow the safety instructions and be aware of the hazard.



**This symbol warns of specific hazards which, if not taken into account, may result in personal injury or death.**



**This symbol warns of specific hazards due to high voltages which, if not taken into account, may result in personal injury or death.**



**This symbol warns of specific hazards due to high temperatures which, if not taken into account, may result in personal injury or death.**



**This symbol warns of specific hazards due to hazardous substances which, if not taken into account, may result in personal injury or death.**



**This symbol warns of specific hazards due to caustic or corrosive substances which, if not taken into account, may result in personal injury or death.**



**This symbol highlights where you must take special care to ensure the analyzer or to other equipment or property is not damaged.**

### 1.1.3 Other information provided by the manual

*Note: Notes give extra information about the equipment.*

*Hint: Hints give helpful tips and highlights information which is useful for you to be aware of, for example, specific operating conditions.*

## 1.2 Applicable EU Directives, Standards, Certification

- Low Voltage Directive (2014/35/EU)
- Electromagnetic Compatibility (EMC) Directive (2014/30/EU)
- EN 61010-1:2010
- EN 61326-1:2013 / IEC 61326-1:2012
- Certified to MCERTS (EN15627-3) and (EN14181) QAL 1

EN15267-3:2007 & QAL 1 as defined in EN 14181: 2014 for O<sub>2</sub>, SO<sub>2</sub>, CO and NO

Certification Number: SIRA MC030013/11

## 1.3 Product overview

The 4900 Multigas Analyzer is designed to meet the needs of regulatory emissions monitoring and providing feedback / feedforward control purposes in industrial and combustion related processes.

The analyzer is highly customizable with very low maintenance that can monitor up to four gases at one time. Servomex uses ultra-stable paramagnetic and non-dispersive infrared (NDIR) technologies with gas filter correlation (GFx) or single beam single wavelength (SBSW) in the 4900 Multigas.

The standard unit has one inlet stream providing gas to all of the transducers at the same time. If an external Nitrogen Dioxide (NO<sub>2</sub>) converter is to be used, then the analyzer can be equipped with a second inlet and outlet stream isolating the NO transducer for direct use with the NO<sub>2</sub> converter.

The standard unit weighs approximately 14 kg (30.9 lbs), and the extended chassis section weighs approximately 13.7 kg (30.2 lbs), required when multiple GFx sensors are chosen.

The analyzer can be configured as 19-inch rack, panel or bench mounting. The standard bench analyzer (without ears for mounting) is 141.2mm (5.5") high (with extended chassis it is 273.7 mm (10.7") high), 430 mm (16.9") wide and 544.2 mm (21.4") deep; the rack mount analyzer is 132.5 mm (5.2") high (with the extended chassis it is 265.5 mm (10.5") high), 481.6 mm (19") wide and 544.2 mm (21.4") deep.

The analyzer is not intended for use with corrosive samples and requires a gas conditioning system if the gas stream is hot and wet. This provides protection of the analyzer and little routine maintenance. Replacement of filter element is the only maintenance item and then only if one is fitted external to the analyzer.

Calibration is essential for the accuracy of sample gas measurements and should be done on a regular basis per recommendations as found in the 4900 Installation and Operation Manual, or as required by the local regulatory body.

The 4900 Multigas product complies with BS EN61326-1:2013, Class A. 4900 Multigas is intended for professional measurement and control purposes in industrial process and industrial manufacturing environments or is a component of such equipment. It is not intended for use in domestic applications because the 4900 Multigas does not meet CISPR 11 class B emission limits for residential locations, which are directly connected to low voltage power supply networks.

## 1.4 General description

The 4900 Multigas analyzer is a chassis into which up to four gas modules may be fitted. It provides power, gas connections and other support functions to the gas sensor modules and receives their outputs from which it calculates sample gas concentrations. Gas measurements are shown on the analyzer display but at the same time can be sent out of the analyzer to other devices using serial, milliamp (mA), voltage or digital communications protocols.

### ***Included with each Analyzer ordered:***

- 4 Relays contacts provided free of charge (8 per option board, 32 max)

### ***Included with each Transducer ordered:***

- Each Transducer configured with one option board, 4 possible per analyzer
- Two alarms are activated (8 per transducer, 32 max)
- OUTPUT: 1 Isolated 4-20 mA (1 per option board, 4 max)

### ***If Auto-Cal is purchased, then the following is included:***

- 8 Relays per Transducer purchased
- 6<sup>th</sup>, 7<sup>th</sup>, 8<sup>th</sup> pre-assigned as Zero, Span, Sample per Transducer

### ***Options Available per Transducer:***

- Extra option boards can be ordered to get the desired features
- Four or 6 more alarms per transducer (8 per option board, 32 max)
- OUTPUT: 0 – 10 Vdc per transducer (1 per option board, 4 max)
- INPUT: 2 Digital per transducer (2 per option board, 8 max)
- INPUT: 1 Isolated 4-20 mA per transducer (1 per option board, 4 max)

The analyzer is simple to operate, with an intuitive user interface that also allows displaying data from external sources. The unit supports up to four external analog input signals that can then be displayed on the screen as another measurement signal, output through the analog and/or the serial outputs or accessed using Modbus or PROFIBUS protocols. These external input signals can be recorded, used to activate relays, trigger the auto-calibration / validation routines, or trigger the low / high alarms.

*Note: The full technical specification is presented in the full 4900 Installation and Operations manual.*

Many optional features are available for the 4900 Multigas analyzer, depending upon the analyzer configuration:

- Up to four gas modules can be selected. 0-25% O<sub>2</sub> must be selected with at least one other measurement.
- Flow meters to monitor and needle valves to control sample gas flow through the instrument – a maximum of two if the dual sample inlet / outlet option is used.
- A sample-flow switch to monitor sample-flow and alarm when the flow is too low – only one allowed per analyzer.
- Auto-calibration feature that provides 8 relay contacts for each transducer and software to allow auto-calibration / validation based upon a timer (gas switching is via user installed externally located valves).
- Second inlet and outlet gas sample stream if a user provided external NO<sub>2</sub> converter is added.

*Note: If a flow switch is ordered and an external NO<sub>2</sub> converter is added (this requires the dual sample inlet / outlet option), then the flow switch is installed on the main Stream #1 rather than Stream #2 which is isolated for use with the NO transducer after the NO<sub>2</sub> converter.*

- Serial Communications using RS232, RS485, RS232 & RS 485 Combo, Modbus RDU, Profibus.

*Note: It is recommended to fit an external 0.1 microns sample filter to protect the gas transducer modules from particulate contamination.*

## 1.5 Recommended calibration intervals

For optimum performance, it is necessary to routinely check the calibration of all the internal gas transducers within the analyzer. The recommended periods for each transducer type are shown in Table 1-1.

**Table 1-1: Recommended calibration periods**

<b>Gas transducer module</b>	<b>Low calibration</b>	<b>High calibration</b>
1210 GFX NDIR transducer	Weekly	Monthly
SBSW NDIR transducer	Weekly	Daily
Paramagnetic transducer	Weekly	Weekly

*Note: Most regulatory bodies require a daily validation, so it is best to follow the local requirements if they are more frequent than what is shown in Table 1-1.*





If the intended use of this equipment is to monitor process systems critical for Health and Safety purposes, it is the sole responsibility of the installer and operator to see that this instrument is commissioned, maintained and calibrated in a manner consistent with the customer's specific application. Continued safe and reliable operation of this equipment is conditional on all installation, operation and maintenance procedures being carried out in accordance with the appropriate manuals, by personnel having appropriate qualifications, experience and training. Failure to observe the requirements of the manual may result in the user being held responsible for the consequences. In no event shall Servomex be liable for any incidental, consequential or special damages of any kind or nature whatsoever, including but not limited to lost profits arising from or in any way connected with this instruments use.

## 1.6 Automatic calibration options

There are two functions that are allowed if the Auto-Cal feature is ordered:

Auto-calibration: This is performed on the transducer and will change the actual calibration curve.

Auto-validation: This only reads the value to determine if it is within the specified tolerance.

Each transducer can have up to three sequences of auto-calibration or auto-validation attached to it.

To use the auto-calibration / validation routine, customer supplied solenoid valves will be controlled by discrete wiring to the relays for each of the transducers (see 4900 Multigas Operation Manual section 11 for details).

The automatic calibration procedure may be started by any of the following:

- A trigger from the internal instrument clock
- An external contact closure
- A Modbus or PROFIBUS command

*Note: When the optional external auto-calibration is configured, a manual calibration adjustment or calibration check is used, the manual calibration process will use the auto-calibration valves to select the calibration gases as required.*

## 1.7 Product identification



Figure 1-1: Standard 4900 Multigas Gas Analyzer configured for rack-mount

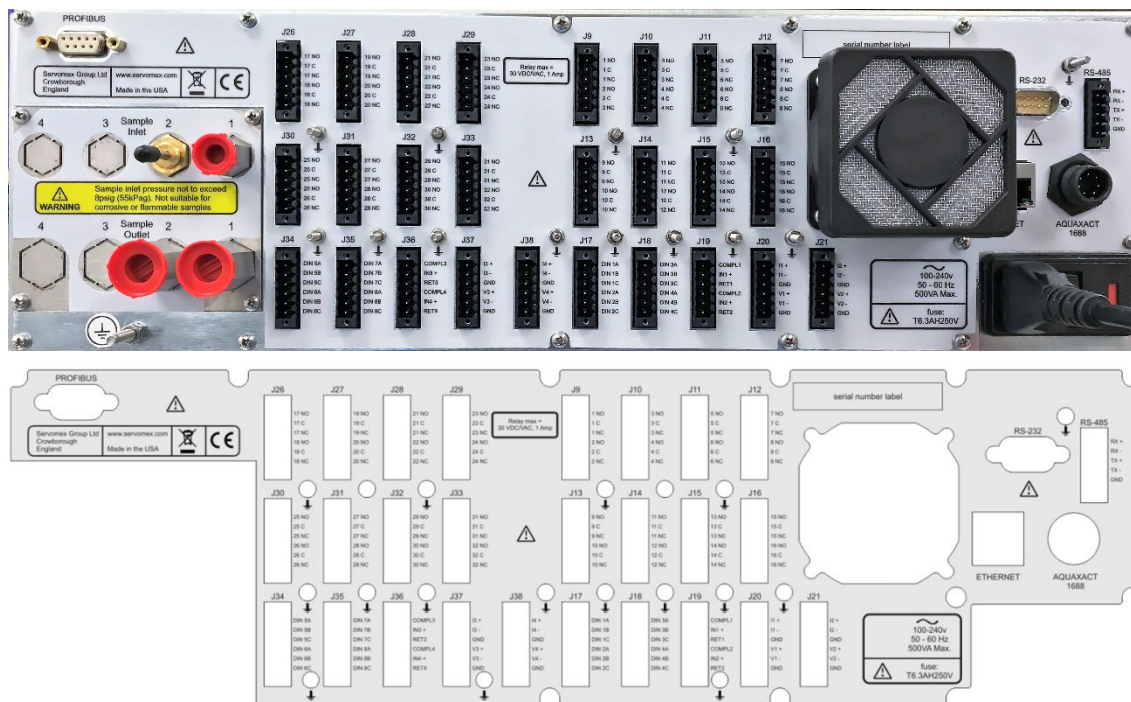

Figure 1-2: Rear of the 4900 Multigas Gas Analyzer configured for use with an external NO<sub>2</sub> Converter (two inlet / outlet lines included)

Note: The AquaExact 1688 port is not currently available for use in the 4900 Multigas.



**Figure 1-3: The Extended Chassis version of the 4900 Multigas Gas Analyzer**

Table 1-2 provides a general overview of the identification of the jumper on the back of the analyzer to the function. Some of the connections are for features that not part of the standard analyzer or transducer and must ordered as an option in order to activate them.

**Table 1-2: Rear panel connections**

ID	Description	ID	Description
J9 – J16	Relay I/O connections	J26 – J33	Relay I/O connections
J17	DIN (1A-C / 2A-C)	J34	DIN (5A-C / 6A-C)
J18	DIN (3A-C / 4A-C)	J35	DIN (7A-C / 8A-C)
J19	Option board 1&2 4-20 mA inputs	J36	Option board 3&4 4-20mA inputs
J20	4 – 20 mA output / voltage output (I1± / V1±)	J37	4 – 20 mA output / analog voltage output (I3± / V3±)
J21	4 – 20 mA output / voltage output (I2± / V2±)	J38	4 – 20 mA output voltage output (I4± / V4±)
PROFIBUS	Profibus connector	RS-232	RS232
ETHERNET	Ethernet connector <i>(not available at this time)</i>	RS-485	RS485 (Modbus)
AQUAXACT 1688	AquaXact 1688 connector <i>(not available at this time)</i>		Earth (ground) connection

## 1.8 Sample requirements

For best performance the flow (and pressure) supplied to the analyzer should be kept at a constant value for both normal sampling and for calibration gas input.

Flow Rate:	Nominal 1500 mL/min (Min 500mL/min, Max 2000 mL/min)
Temperature:	5 to 45°C / 41 to 113°F
Dew point:	5°C / 9°F below minimum ambient
Condition:	Oil free, non - condensing, filtered to 1µm
Vent:	Connect the outlet of the analyzer to a separate atmospheric vent, free from any back-pressure
Warm up Time:	Typically, 24 hours from cold start to 20°C / 68°F

**Note: High sensitivity measurements may take longer**



Pay particular consideration to the toxicity and asphyxiant nature of the sample gas when selecting a vent location.



Corrosive gases are not intended to be used in these analyzers.



Make sure that if pressurized gases are used to keep the pressure below 8psig (55kPa g).



Do not exceed the rated flow or pressure as transducer damage may result. Best practice is to place a pressure relief valve on the inlet line, venting any gas to a safe exhaust area.

## 2 Safety

---

### 2.1 General warnings



Before you attempt to install, commission or use the 4900 Multigas Analyzer, read this manual carefully.



Do not attempt to install, commission, maintain or use the 4900 Multigas Analyzer unless you are trained and know what you are doing. The analyzer must be maintained by a suitably skilled and competent person.



Do not connect the 4900 Multigas Analyzer to a power source until all relays, input/output signals and plumbing connections are made.



This analyzer must be operated in a manner consistent with its intended use and as specified in this manual.



The 4900 Multigas Analyzer is only suitable for installation in safe areas.



The maximum pressure to the analyzer must be limited 8psig (55kPa g) by means of a suitable release system such as a pressure release valve or needle valve installed in line with the analyzer inlet streams.



Do not modify the unit, either mechanically or electrically, or the certification and warranty of the instrument will be invalidated, and it may not operate safely.



The 4900 Multigas Analyzer includes few user-serviceable parts which, are called out in the spare list in the appendix.



Do not use the 4900 Multigas Analyzer as Personal Protective Equipment (PPE).



Make sure that all floors or platforms where you install the 4900 Multigas Analyzer are large enough for you to move freely and to change position.



The 4900 Multigas Analyzer may be attached to equipment that is hot. Always wear the appropriate PPE to minimize the risk of burns.

## 2.2 Chemical warnings



Sample and calibration gases may be toxic or asphyxiant:

- Make sure that the external connections are leak free at full operating pressure before you use sample or calibration gases.
- Make sure that the sample/bypass outlet pipes are vented to an area where the gases will not be a hazard to people.
- Make sure that the analyzer is used in a sufficiently well-ventilated environment, to prevent the build-up of toxic gases.
- Make sure that the pipes that you connect to the analyzer are routed so that they do not present a hazard to people.
- Never inspect the inlet filter(s), or service or repair the analyzer while such gases are still connected to it.
- If the analyzer is to be serviced or repaired, it is important that all pipework is flushed with an inert gas and the analyzer is allowed to freely vent to local atmosphere.



Where there is a risk of release of potentially harmful gases into the operating environment, always use suitable monitoring equipment.



The 4900 Multigas is not suitable for use with corrosive samples.

## 2.3 Electrical warnings



Always observe the appropriate electrical safety codes and regulations.



Make sure that the electrical installation of the analyzer conforms with all applicable local and national electrical safety requirements.



Potentially hazardous AC voltages are present within this instrument. Leave all internal servicing to qualified personnel. Disconnect the AC power source before installing or removing any external connections.



Make sure the analyzer is provided with a sound earth connection via the electrical supply plug.



Make sure the electrical supply coupler or plug is easily accessible for disconnection from the electrical supply.



All signal and electrical supply cables must be rated for temperatures of 70 °C or higher.



The I/O terminals and connections are separated from the analyzer mains circuits by reinforced insulation. The terminals must only be connected to circuits that are themselves separated from mains voltages by at least reinforced insulation.



Make sure that the cables that you connect to the analyzer are routed so they do not present a trip hazard.

## 2.4 Electromagnetic Compatibility (EMC) considerations

The 4900 Multigas Analyzer meets the essential requirements of the European EMC Directive (2014/30/EU). The transducer and the 4-20 mA loop are electrically connected but are isolated from the analyzer housing and sample cell fitting threads.

The analyzer generates and uses small amounts of radio frequency energy. There is no guarantee that interference to radio or television signals will not occur in an installation. If interference is experienced, switch off the analyzer to see if the interference disappears. If it does, try one or more of the following methods to correct the problem:

- Reorient the receiving antenna.
- Move the instrument with respect to the receiver.
- Place the analyzer and receiver on different AC circuits.

Always consider the following electromagnetic interference issues when installing the 4900 Multigas Analyzer:



To provide an acceptable noise environment for the 4900 Multigas Analyzer or other digital equipment in the proximity of switching inductive loads, Servomex recommends that you place varistors across the inductors to lessen high voltage spikes that occur during transitions.





Circuitry activated by relay contacts should allow for the contact bounce. One simple method is to place a capacitor across the relay contacts.



Route AC power wiring as far from the analyzer and its wiring as possible.

## 2.5 Markings

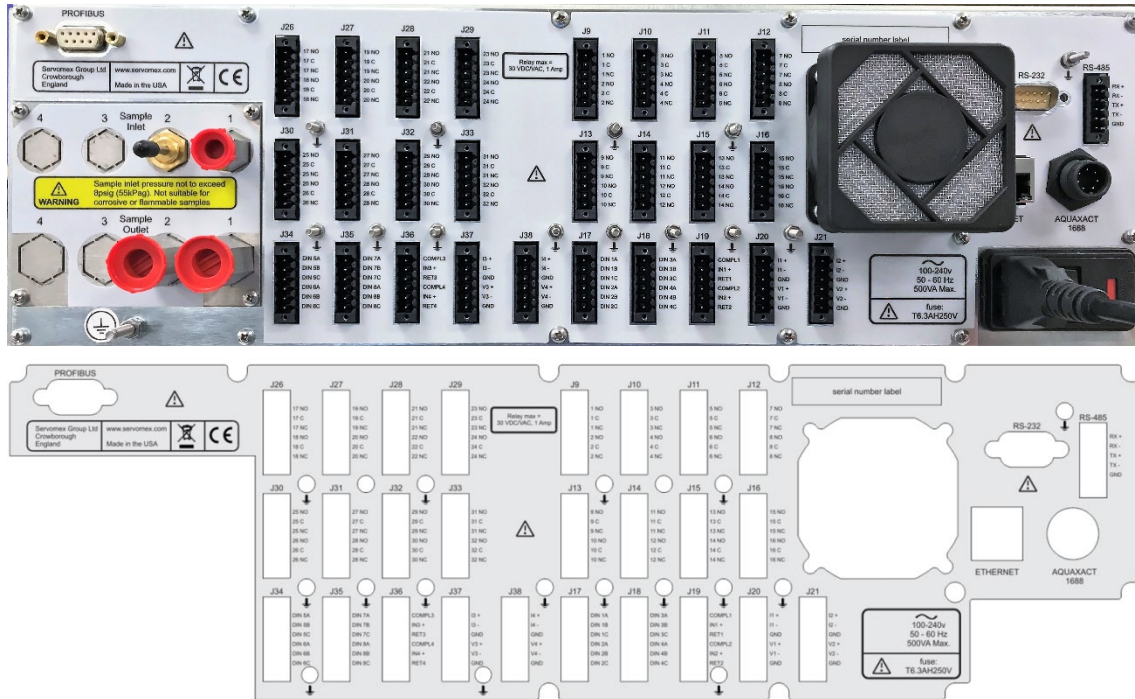

Figure 2-1: Rear of the 4900 Multigas analyzer

The 4900 Multigas Analyzer includes the following external markings on the rear panel and correspond to:



**Do not connect any cables carrying mains voltage or cables that have inadequate insulation between line and mains to any of the I/O connectors.**



**Earth / ground connections. These are screw terminals used to connect the ground shields of cables plugged into the nearby connectors. Do not connect any voltages to these connections.**



**This label identifies that:**

- The analyzer is considered to be within the scope of the Waste Electrical and Electronic Equipment (WEEE).
- The analyzer is not intended for disposal in a municipal waste stream (such as landfill sites, domestic recycling centers and so on), but must be submitted for material recovery and recycling in accordance with the local regulations which implement the WEEE Directive.

Follow the appropriate safety instructions and be aware of any warnings about potential hazards.

## 3 Installation and set-up

---



**Do not attempt to install, commission, maintain or use the 4900 Multigas Analyzer unless you have been trained or are an experienced instrument technician.**



**The 4900 Multigas Analyzer is only suitable for installation in safe areas.**



**Follow the instructions in this section to safely install the 4900 Multigas Analyzer.**



**Make sure that all floors or platforms where you install the 4900 Multigas Analyzer are large enough for you to move freely and to change position.**



**Do not install the unit in places subject to extreme mechanical vibration, temperature changes or shock. If you do, measurements may not be accurate, or the analyzer may be damaged.**

### 3.1 Unpacking



**Read this manual carefully BEFORE you remove the 4900 Multigas Gas Analyzer from its shipping container, or you attempt to install, commission or use the equipment.**



**The analyzer weighs main unit: 14kg (30.9 lb) approx. plus expansion chassis: 13.7 kg (30.2 lb) approx. so take care when handling the instrument. Always lift the instrument with hands positioned on either side on the base of the chassis.**

- Remove the analyzer and any other equipment from its packaging.
- Remove the protective plastic covers from the sample gas inlets and outlets on the rear of the analyzer (Figure 3-1).



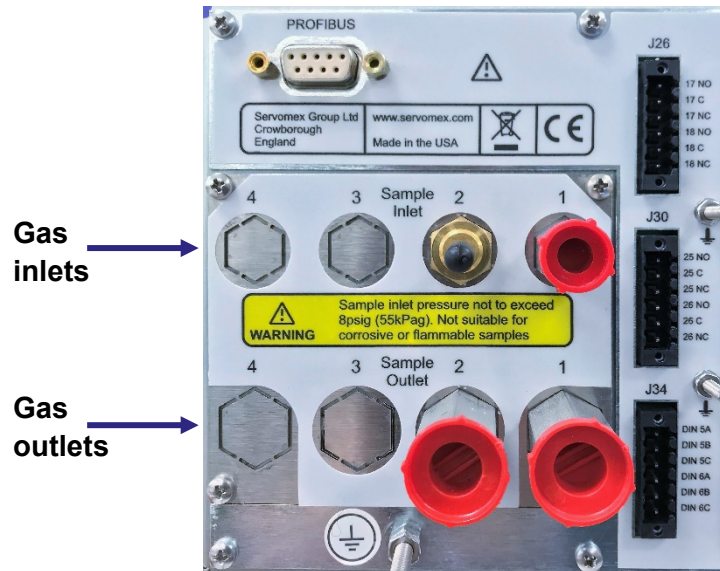

**Figure 3-1: Gas inlets and outlets on rear of the analyzer**

**Hint:** Remove the RED and BLACK protective covers before connecting to the sample gas pipework. If you do not intend to use the analyzer immediately, wait to remove the plastic covers until just before connecting to the sample gas pipework.

Inspect the analyzer and the other items supplied, and check that they are not damaged. If any item is damaged, contact Servomex or your local Servomex agent immediately.

Check that you have received all the items that you ordered with the packing list. If any item is missing, contact Servomex or your local Servomex agent immediately.

If you do not intend to use the analyzer immediately:

- Refit any protective plastic covers that you may have removed.
- Place the analyzer and any other equipment supplied back in its protective packaging.
- Store the analyzer as described in Section 6.1.

Read Section 2 – Safety before proceeding.

**Hint:** Keep all shipping packaging and documentation for future use when moving, storing or returning it for service or repair.

## 3.2 Mechanical Installation

### 3.2.1 Bench mounting

4 rubber feet beneath the analyzer allow use on a firm level bench or other suitable solid work surface.

### 3.2.2 Rack mounting

Before installing the analyzer, determine where you will install it in the rack enclosure. The standard analyzer is 3U in height and has two mounting bolts on each side.

There is an option for a sliding rack mount (Figure 3-2) as well as an extended chassis if multiple GFx transducers are ordered in one analyzer (Figure 3-3).

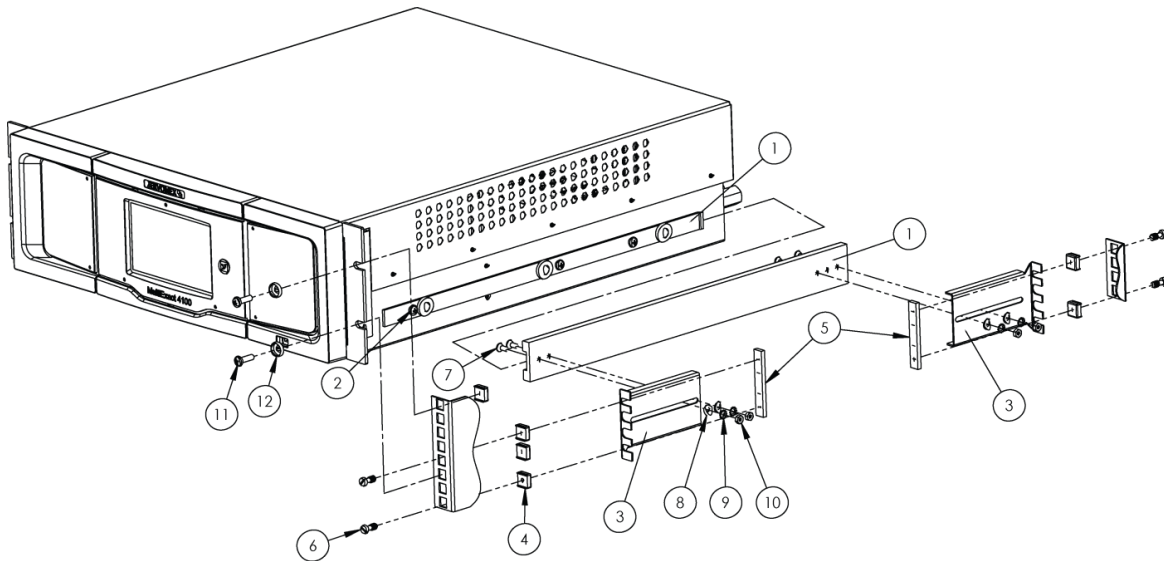

- |   |                        |    |                      |
|---|------------------------|----|----------------------|
| 1 | Telescopic slide       | 7  | M4 screw             |
| 2 | M5 screw               | 8  | M4 washer            |
| 3 | Slide support bracket  | 9  | M4 locking washer    |
| 4 | Cage nut               | 10 | M4 nut               |
| 5 | Slide support clamp    | 11 | M5 cross-head screw  |
| 6 | M5 waisted brass screw | 12 | Cup washer (plastic) |

**Figure 3-2: Sliding rack installation (M indicates metric value in mm)**

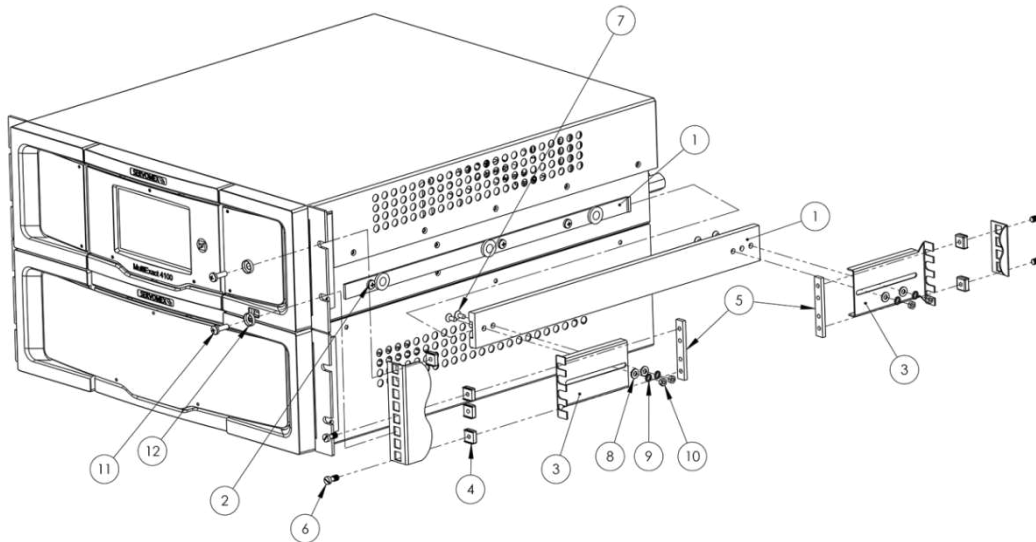

1	Telescopic slide	7	M4 screw
2	M5 screw	8	M4 washer
3	Slide support bracket	9	M4 locking washer
4	Cage nut	10	M4 nut
5	Slide support clamp	11	M5 cross-head screw
6	M5 waisted brass screw	12	Cup washer (plastic)

**Figure 3-3: Sliding rack installation for Extended Chassis version**  
(M indicates metric value in mm)

### 3.3 Electrical installation

#### 3.3.1 Electrical safety



Make sure that the electrical installation of the analyzer conforms with all applicable local and national electrical safety requirements.



Make sure the electrical supply plug is easily accessible for disconnection from the electrical supply.



Make sure the analyzer is provided with a sound earth connection via the electrical supply plug.



All signal and electrical supply cables must be rated for temperatures of 70 °C or higher.



Make sure that the cables that you connect to the analyzer are routed so they do not present a trip hazard.



Potentially hazardous AC voltages are present within this instrument. Leave all internal servicing to qualified personnel. Disconnect the AC power source before installing or removing any external connections.



Follow the instructions given below when you install the analyzer. If you do not, the analyzer warranty may be invalidated, the analyzer may not operate correctly, or it may be damaged.



Make sure your electrical supply can provide the necessary maximum power consumption.

### 3.3.2 Analog output signal connections



The analog output terminals are separated from the analyzer mains circuits by reinforced insulation. The terminals must only be connected to circuits that are themselves separated from mains voltages by at least reinforced insulation.



To comply with EMC requirements, shielded cables must be used to connect the analog outputs.

Use Table 3-1 to identify which screw terminal (J20, J21, J37, and J38) is connected to which gas transducer position:

**Table 3-1: Analog output interface connectors**

Screw Terminal	Gas Transducer	Screw Terminal	Gas Transducer
J20	Position / Measurement #1	J37	Position / Measurement #3
J21	Position / Measurement #2	J38	Position / Measurement #4

Connect the cable wires as shown to the pins on J20 (Gas #1), J21 (Gas #2), J37 (Gas #3), J38 (Gas #4) for the outputs available on the transducers using Table 3-2. The (X) in the table below indicates the gas measurement location in position 1, 2, 3, or 4 that matches the jumper listed in Table 3-2 with the label on the back of the analyzer:

*Note: All pin locations and functions listed in Table 3-2 are for J20, J21, J37, and J38 only which are the analogue out gas measurement signals.*

**Table 3-2: Analog output interface connections**

Pin	Use	Output Configuration	Pin	Use	Output Configuration
1	I(X)+	mA current	4	V(X) +	voltage
2	I(X) -	mA current	5	V(X) -	voltage
3	GND	Chassis ground	6	GND	Chassis ground

Connect the cable shielding to the ground point on the rear of the analyzer. The ground points are marked with the  $\perp$  symbol, or if more convenient the screw terminals at pins 3 and 6 may be used.

### 3.3.3 Analog input signal connections



The analog input terminals are separated from the analyzer mains circuits by reinforced insulation. The terminals must only be connected to circuits that are themselves separated from mains voltages by at least reinforced insulation.



To comply with EMC requirements, shielded cables must be used to connect the analog inputs.



The analyzer must supply power for any mA input devices. Do not allow devices on the inputs to supply power or the input readings may not be valid.



Analog input number “X” shares the same isolated reference as the analog output with the same number. This reference is isolated from the rest of the chassis as well as from the other analog inputs and outputs. Do not allow equipment wired to an input number X to be grounded to the same frame as equipment reading from output number X, or both input and output X readings may not be valid.

Refer to Table 3-1 to identify which screw terminal (J20, J21, J37, and J38) is connected to which gas transducer position.

**Table 3-3: Analog output interface connectors**

Screw Terminal	mA Input	Screw Terminal	mA Input
J19	Input #1, #2	J36	Input #3, #4

Connect the input cable wires to the pins on J19 (inputs #1 and #2), J36 (inputs #3 and #4), as shown in Table 3-4. The (X) in the table indicates the input location in position 1, 2, 3, or 4 that matches with the label on the back of the analyzer:

**Table 3-4: Analog input interface connectors**

Pin	Use	Input Configuration	Pin	Use	Input Configuration
1	COMPL(X)	Compliance out	4	COMPL(X)	Compliance out
2	IN(X) +	mA input return	5	IN(X) +	mA input return
3	RET(X)		6	RET(X)	

Connect the cable shielding to the ground point on the rear of the analyzer. The ground points are marked  with the symbol. Connect an external mA loop device “+” to the COMPL(X) pin and connect the external device “-” to the IN(X)+ pin. The RET(X) pins cannot currently be used.

### 3.3.4 Relay connections

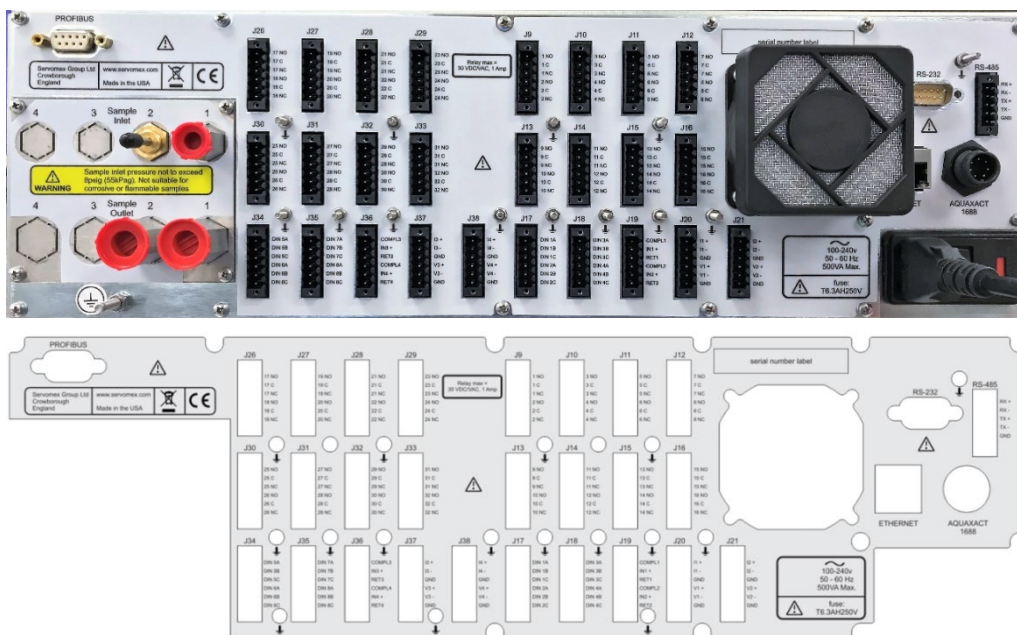

Figure 3-4: Rear of 4900 Multigas



**The relay connections are separated from the analyzer mains circuits by reinforced insulation. The terminals must only be connected to circuits that are themselves separated from mains voltages by at least reinforced insulation.**

*Note: The relays do not have default settings unless auto-calibration is selected. Users can create alarms and assign them to any relay (see 4900 Multigas Operation manual for details).*

*Note: When Auto-Cal is ordered, each transducer has 8 relays available with 3 relays preassigned with the 6<sup>th</sup> assigned to Zero, the 7<sup>th</sup> to Span and the 8<sup>th</sup> to the Sample gas. The 1<sup>st</sup> to the 5<sup>th</sup> relays do not have default settings and can be assigned to any alarm or function even if it is not related to that particular gas transducer (see 4900 Multigas Operation manual for details).*

The analyzer relays are accessible via the connectors J9-16 and J26-33. Connect one end of your cable wire to the screw terminal for the relevant relay connector as shown in Table 3-3. Each connector has two relays assigned to it where the “X” in XNO, XC, XNC represents the relay number, NO is Normally Open, C is Closed and NC is Normally Closed.

**Table 3-3: 4900 Multigas relay connections**

Relay	Use	Connector	Relay	Use	Connector	Relay	Use	Connector
1	1NO, 1C, 1NC	J9	12	12NO, 12C, 12NC	J14	23	23NO, 23C, 23NC Auto-Cal Span	J29
2	2NO, 2C, 2NC	J9	13	13NO, 13C, 13NC	J15	24	24NO, 24C, 24NC Auto-Cal Sample	J29
3	3NO, 3C, 3NC	J10	14	14NO, 14C, 14NC Auto-Cal Zero	J15	25	25NO, 25C, 25NC	J30
4	4NO, 4C, 4NC	J10	15	15NO, 15C, 15NC Auto-Cal Span	J16	26	26NO, 26C, 26NC	J30
5	5NO, 5C, 5NC	J11	16	16NO, 16C, 16NC Auto-Cal Sample	J16	27	27NO, 27C, 27NC	J31
6	6NO, 6C, 6NC Auto-Cal Zero	J11	17	17NO, 17C, 17NC	J26	28	28NO, 28C, 28NC	J31
7	7NO, 7C, 7NC Auto-Cal Span	J12	18	18NO, 18C, 18NC	J26	29	29NO, 29C, 29NC	J32
8	8NO, 8C, 8NC Auto-Cal Sample	J12	19	19NO, 19C, 19NC	J27	30	30NO, 30C, 30NC Auto-Cal Zero	J32
9	9NO, 9C, 9NC	J13	20	20NO, 20C, 20NC	J27	31	31NO, 31C, 31 NC Auto-Cal Span	J33
10	10NO, 10C, 10NC	J13	21	21NO, 21C, 21NC	J28	32	32NO, 32C, 32NC Auto-Cal Sample	J33
11	11NO, 11C, 11NC	J14	22	22NO, 22C, 22NC Auto-Cal Zero	J28			

Connect the wires in your cable to the screw terminals on the relevant connectors as shown in Table 3-4 showing Relay X (J odd numbers) and Relay Y (J even numbers) positions on the jumpers listed in Table 3-3 above:



**Table 3-4: Relay Screw Terminal Pin Connection**

Pin	Use	Output Configuration	Pin	Use	Output Configuration
1	(X) NO	Normally Open Relay X	4	(Y) NO	Normally Open Relay Y
2	(X) C	Close Relay X	5	(Y) C	Close Relay Y
3	(X) NC	Normally Closed Relay X	6	(Y) NC	Normally Closed Relay Y

For setting up the Zero Gas relay if Auto-calibration is purchased, connect the wires in your cable to the screw terminals to the relevant connectors J11, J15, J28, and J32 (based upon the number and position of the transducers in the analyzer) shown in Table 3-5 below. “Y” represents the jumper number J11 for gas #1, J15 for gas #2, J28 for gas #3 and J32 for gas #4:

**Table 3-5: Zero Gas Relay Screw Terminal Pin Connections for Auto-Calibration**

Pin	Use	Output Configuration
4	(Y) NO	Normally Open Relay Y Zero Gas Relay
5	(Y) C	Close Relay Y Zero Gas Relay
6	(Y) NC	Normally Closed Relay Y Zero Gas Relay

For setting up the Span Gas and Sample Gas relays, if Auto-Cal is purchased, connect the wires in your cable to the screw terminals to the relevant connectors of J12, J16, J29, and J33 as shown below to control the Span Gas Relays and / or Sample Gas Relays shown in Table 3-6 below. “X” represents the jumper J12 for gas #1, J16 for gas #2, J29 for gas #3 and J33 for gas #4 and Pins 1 – 3 control the Span Gas Relays while Pins 4 – 6 control the Sample Gas Relays:

**Table 3-6: Span and Sample Gas Relay Screw Terminal Pin Connections for Auto-Cal**

Pin	Use	Output Configuration
1	(X) NO	Normally Open Relay X Span Gas Relay
2	(X) C	Close Relay X Span Gas Relay
3	(X) NC	Normally Closed Relay X Span Gas Relay
4	(X) NO	Normally Open Relay X Sample Gas Relay
5	(X) C	Close Relay X Sample Gas Relay
6	(X) NC	Normally Closed Relay X Sample Gas Relay



### 3.3.5 Connect the electrical supply



**Make sure that your external electrical supply outlet is isolated and locked-out before you connect the conductors in the electrical supply cable.**



**Only use the power supply cord provided with the unit.**



**Make sure the analyzer is suitable for use with your electrical supply voltage and frequency (Section 5.2). If the analyzer is not suitable, it may not operate correctly, or it may be damaged if you operate it.**

The analyzer is supplied with an electrical supply cable and plug, configured for your electrical supply. Connect the electrical supply to the analyzer as follows:

1. Turn the Power Switch on the back of the unit to OFF: press the “O” on the On/Off switch shown in Figure 3-5 A.
2. Fit the IEC plug on the end of the electrical supply cable provided to the electrical supply socket on the rear of the analyzer (Figure 3-5 B).

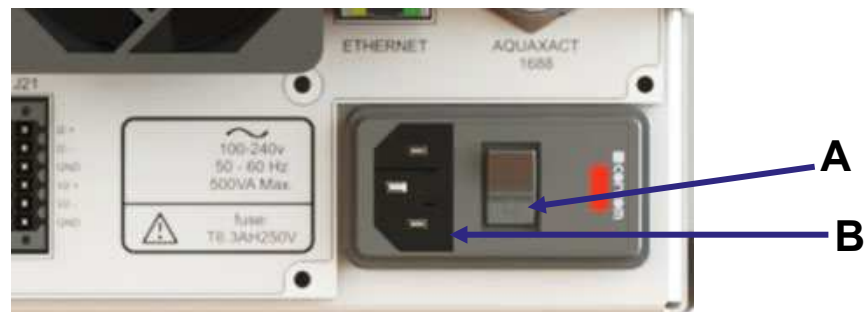

**Figure 3-5: Power switch (A) and electrical supply socket (B) on rear of analyzer**

3. Plug the other end of the electrical supply cable into your electrical supply outlet.
4. Check the earth (ground) continuity between your electrical supply outlet earth (ground) and the functional earth (ground) terminal on the rear of the analyzer.
5. If a local earth bonding is required, the functional earth stud can be used. The earth ground cable must be kept to less than 3 meters to comply with EMC standards.



**This does not replace the earth conductor on the electrical supply socket which must always be connected. Therefore never cut or remove any of the metal pieces off of the supplied plug.**

### 3.4 Sample / calibration gas connections



The 4900 Multigas must not be used with flammable gases.



Sample and calibration gases may be toxic or asphyxiant:



- Make sure that the external connections are leak free at full operating pressure before you use sample or calibration gases.
- Make sure that the sample/bypass outlet pipes are vented to an area where the gases will not be a hazard to people.
- Make sure that the analyzer is used in a sufficiently well-ventilated environment, to prevent the build-up of toxic gases.
- Make sure that the pipes that you connect to the analyzer are routed so that they do not present a hazard to people.



It is essential that the analyzer is isolated from the sample system until any cleaning solvents are fully purged from the pipelines. Failure to take this precaution may lead to contamination of the transducer, which will be observed as an offset and drift in output.

#### 3.4.1 Sample and Calibration Gas Inlets and Outlets

**Hint:** Sample and calibration gases pass into the analyzer via Sample Inlet 1 (Figure 3-6 A, and out via Sample Outlet 1 (Figure 3-6 B). Sample Inlet 2 and Sample Outlet 2 are only installed if an external NO<sub>2</sub> converter is used. Figure 3-6 shows the configuration set up for multiple gas transducers and an NO transducer fitted with an external converter for NO<sub>2</sub>.

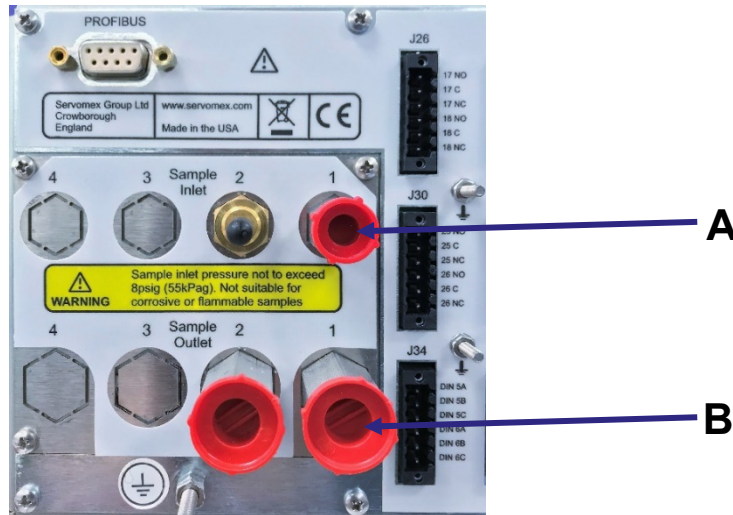

Figure 3-6: Gas inlets and outlets on rear of analyzer – Standard systems use Sample Inlet / Outlet #1 only.

### 3.4.2 Gas connections

Connect your sample/calibration gas inlet and outlet pipelines to the Sample Inlet 1 (Figure 3-6 A) and Sample Outlet 1 (Figure 3-6 B) fittings on the rear of the analyzer. Do not over-tighten the fittings.

Table 3-7 shows the inlet and outlet fitting connections for the Standard system (Inlet / Outlet #1) and the optional second stream (Inlet / Outlet #2) when an external NO<sub>2</sub> converter is used.

**Table 3-7: 4900 Multigas sample port configurations**

Component	Fitting	Comment
Sample Inlet 1	1/8" NPT female	Available as standard on the 4900
Sample Inlet 2	1/8" NPT female	Only available when an external NO <sub>2</sub> converted is used (customer supplied).
Sample Outlet 1	1/4" NPT female	Available as standard on the 4900
Sample Outlet 2	1/4" NPT female	Only available when an external NO <sub>2</sub> converted is used (customer supplied).

*Note: It is recommended an external filter is fitted at the analyzer inlet (08900920A - FILTER KIT) or, if preferred, at a convenient point in the sample line prior to the inlet.*

### 3.4.3 Gas Flow Rate

Optional rotameter flow meters can be installed to measure the flow of gas through the analyzer. If two gas stream inlet / outlets are configured, then float meter 1 on the front panel shows the flow on stream #1 while float meter 2 shows the flow on stream #2 (Figure 3-7).

The flow rate is obtained by observing the scale indication at the **top** of the float. The rotameters are used only for visually validating that is flow going through the analyzer and is not exceeding the flow rate of the instrument.

Flow control on the inlet to the analyzer must be provided by the end user using mass flow controllers, manual adjustable valves like needle valves, or electronically controlled metering valves. Optionally a float meter with an integrated metering valve can be configured with the analyzer when ordering through Servomex. In this case the flow adjustment is made with a small screw driver inserted through the hole under the flow meter.

An optional internal flow monitor can be configured with the analyzer when ordering through Servomex as a diagnostic indicator to alert locally or remotely when flow is not going through the analyzer.



Figure 3-7: Gas Flow Meter location on front panel of the standard analyzer

## 3.5 Operation



See Section 1.8 for pressure/flow rate requirements for the sample, zero and calibration gases. If the pressure/flow rates are outside the ranges specified in Section 1.8, you must regulate the gases externally, before they enter the analyzer.

### 3.5 View flow levels

The optional flow meters are visible via front panel and are calibrated for use with air / N<sub>2</sub>. They can be ordered with optional needle valves as well for adjustment. If the molecular weight of the background gas is much different from N<sub>2</sub>, the flowmeter reading is not accurate. Most other gases have molecular weights within  $\pm 25$  percent of air. Since the required flow rate is not extremely critical most gases produce reasonably correct readings. The exceptions are light gases such as Helium, whose flow rates should be set to approximately one-third that of Nitrogen.

If the optional needle valves are not ordered with the analyzer it is up to the user to install needle valves or mass flow controllers on the inlet gas stream to ensure that the transducers are not over pressurized.

### 3.6 Switch off the analyser

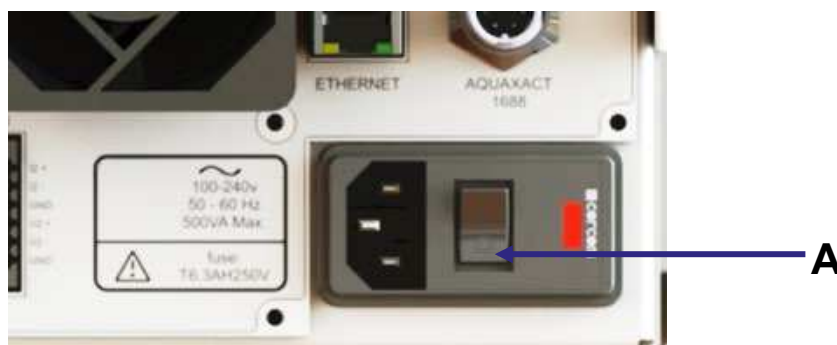

Figure 3-8: On/off switch on the rear of the analyzer

To switch off the analyser, press **O** on the On/Off switch on the rear of the analyser (Figure 3-8 A).

If you intend to leave the analyzer off for an extended period of time, for example, if you need to carry out plant/factory maintenance and will not use the analyzer for several days:

- Turn off the Analyzer and disconnect the electrical supply cable from the analyzer.
- Purge the transducers with Zero Air or Nitrogen gas to remove any sample gas.
- Close off the sample gas inlet and outlets using a shut off valve or the protective caps supplied with the analyzer.

### 3.7 Power up



**Sample and calibration gases may be toxic or asphyxiant:**



- Make sure that the external connections are leak free at full operating pressure using N<sub>2</sub> or Zero Air before you use sample or calibration gases.
- Make sure that the sample/bypass outlet pipes are vented to an area where the gases will not be a hazard to people.
- Make sure that the analyzer is used in a sufficiently well-ventilated environment, to prevent the build-up of toxic gases.
- Make sure that the pipes that you connect to the analyzer are routed so that they do not present a hazard to people.



**It is essential that the analyzer is isolated from the sample system until any cleaning solvents are fully purged from the pipelines. Failure to take this precaution may lead to contamination of the transducer, which will be observed as an offset and drift in output.**

The analyzer can now be powered up.

**Hint:** *When the electrical supply to the analyzer is switched on, a series of beeps will be heard, the readings are displayed on screen and the clock in the upper right hand corner of the screen starts running.*

To power up the analyser:

1. Make sure that the analyser power cord is connected to the back of the unit.
2. Press **I** on the On/Off switch on the rear of the analyser (Figure 3-9 A) to power on the analyser.

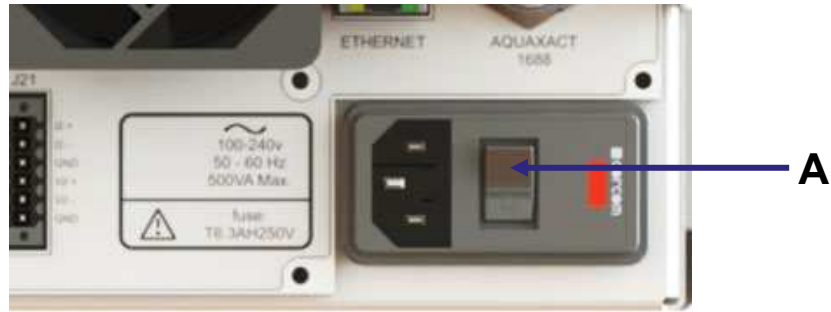

**Figure 3-9: On/Off switch on the rear of the analyzer, (A) points to the Power Switch “I” for ON position.**

- When the analyzer is first switched on, the screen displays a software loading progress bar, followed by the Home screen and the warmup signal **SSS** appears in front of any transducer which operates under isothermal conditions (Figure 3-10).

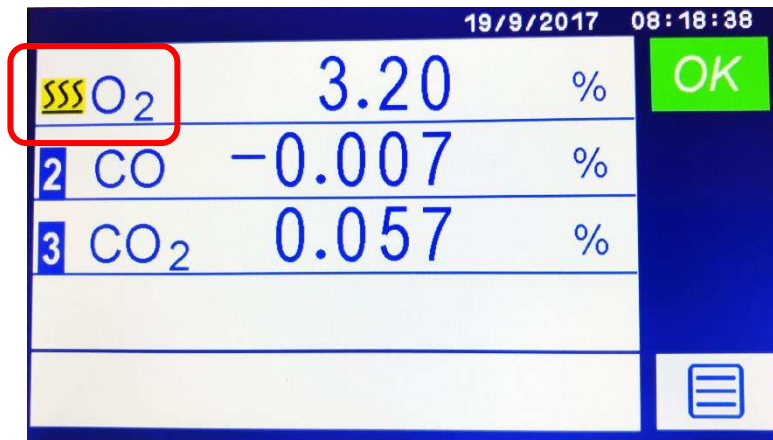

**Figure 3-10: Home screen for a 3-transducer analyzer showing the O<sub>2</sub> warming up**

**Hint:** Figure 3-10 shows the unit in Warm Up mode, indicated by the three wavy lines shown in the upper left corner encircled by the red box.



## 4 User interface

### 4.1 User Interface Overview

All configuration options referred to in this manual (for example, auto-calibrate / validate) must be specified at the time of purchase. If your analyzer does not have the corresponding product options, then menus and menu options associated with the option will not be available for use and will appear as grey colored icon button as seen in the red box of Figure 4-1.

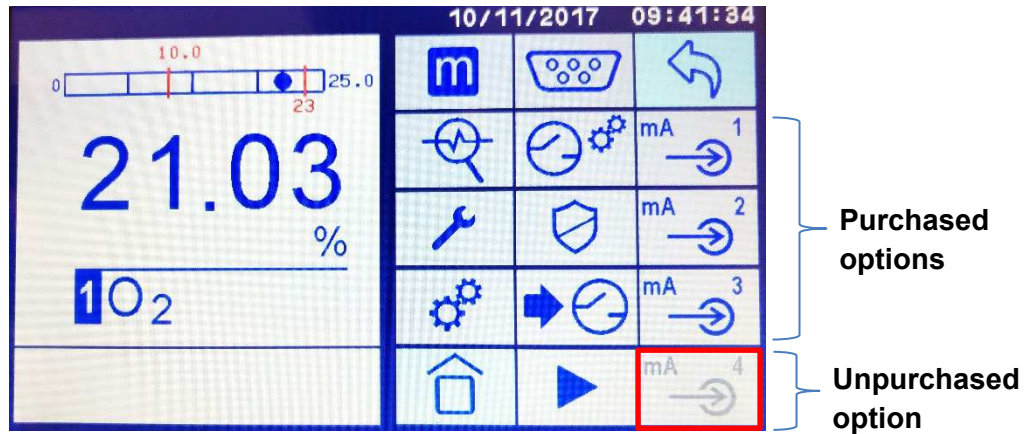

Figure 4-1: Setup Screen Icons showing 3 mA Inputs activated (purchased) and the bottom mA Input is grayed out (not purchased)

### 4.2 Introduction

The guided user interface (GUI) is a touchscreen display with icon-driven menus to allow for an intuitive operation of the 4900 Multigas Analyzer. Figure 4-2 shows the main display for a four-transducer analyzer with the *Main Menu* option icon in the lower right-hand corner. All Multigas 4900 analyzers share common features, but each will have features detailed in this manual, based upon the configuration of transducers, options purchased and setup preferences.



Figure 4-2: Home screen for a 4-transducer analyzer

*Note: If there are no menu interactions for 60 seconds, the display reverts back to this Home screen. This timer can be adjusted in the Settings section.*

If there are two or three transducers the home screen will show two or three horizontal bars respectively, one for each analyte measured. A dual transducer unit is shown in Figure 4-3. If there is only one transducer or if transducer specific user interactions are taking place there will be one window for the selected transducer.



**Figure 4-3: The user interface Home screen for a two-transducer configuration where (A) is the Screen and (B) indicates an Icon.**

The user interface comprises the following as shown in Figure 4-3:

- A Touchscreen display Screens, horizontal bars and icons are displayed on the touchscreen depending on the information and operation being engaged.
- B Touchscreen icons The icons displayed depend on the current screen capabilities / function. When touched the icons will produce a new screen or icon list on the right side.

To interact with a specific gas transducer, touch on the horizontal bar on the home screen display for that gas transducer when more than one gas stream is displayed or touch the single gas screen. A single screen display will show the gas transducer specific user interactions that are available for the selected item.



*Note: The remainder of the software descriptions will show a single transducer window when appropriate.*

### 4.3 General techniques

While the user interface is intuitive, there are some general rules and processes that if followed will allow easier navigation of the menus. The general navigation route through the user interface screens is described by a sequence of icons that you must touch to get to the desired screen. A shortened visual description of the sequence of icons that must be touched is used within this manual to efficiently guide you to the desired icon / operation.

For example, to reach the Alarms screen (a sub-screen of the Measurement branch) you must press the following sequence of icons:











1. Touch the  icon to display the Main Menu screen.
2. Next, touch the  icon to display the Measurement screen.
3. Finally, touch the  icon to display the Alarms screen.

This sequence is shortened in the manual and will appear above the full description as:





There are also a few basic icons to remember that are the foundation of the GUI:

Icon	Meaning	Function
	Home	Returns to the Home screen.
	Main Menu	Displays the Main Menu screen that contains the four main branch icons: Measurement, Diagnostics, Maintenance, and Settings.
	Next	Displays the next set of functions onto the screen. The new list will always appear in a new column to the right of the arrow.
	Return	Returns to the prior screen.
	Accept	Touch this icon to accept any changes made.
	Cancel or Exit	Touch this icon to cancel, reject changes or exit screen.
	Not Active	This icon is used to deactivate the selection.
	Active	This icon is used to activate the selection.



## 4.4 Touchscreen and Navigation overview

Each screen displays active icons that are relevant to that screen's operation. To select an icon, it is best to use the erasure end of a pencil or a stylus to touch the icon on the screen graphic.

*Note: Do not press too hard or you will damage the screen; do not use the point of a pen or pencil to touch the screen.*

For example, the sequence used to arrive at the screen shown in Figure 4-4 was accessed by touching the Main Menu icon  on the Home page then pressing the Measurement icon  to activate the first set of the Measurement choices.



The Measurement choices available are shown in Figure 4-4 and show up as icons in the column to the right of the Main Menu list. The  icon background now turns blue  indicating it is the active Main Menu choice as you navigate forward through the various choices.

*Note: The Main Menu branch stays visible all the time unless you are in a special screen or the Home page. This allows you to access the other Main Menu choices easily.*

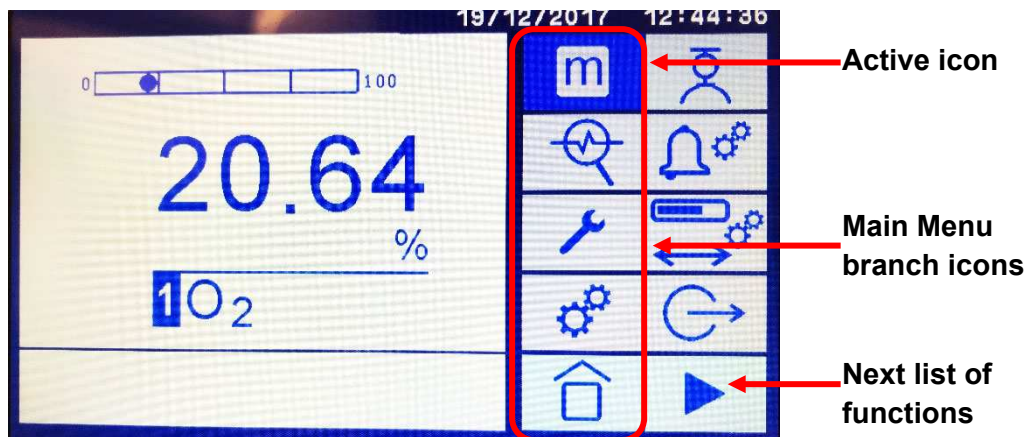

**Figure 4-4: The user interface of the Main Menu screen with the Measurement branch active.**

When a Main Menu icon is selected more icons associated with that function are displayed as seen in Figure 4-4. An icon function is activated by touching the icon on the screen; new icons associated with that function will appear to the right of the icon just pressed or it may transfer you to a new screen.

In the case of the Main Menu Branch icons, if there are more functions associated with the main function activated and they do not all fit onto one screen then the  Next List key will be present in the lower right corner or the bottom of the list. When touched, more functions will appear in a new list to the right of the old list for selection.



The Main Menu Branch will not disappear and remains the farthest column on the left. Details are shown later in this section.

Figure 4-5 shows a Step Series of Screens that were launched when the Settings Main Menu icon  was touched:



- The first series of functional icons that belong to the Settings section are displayed in the column of icons to the right of the Main Menu icons (Figure 4-5 A).



- To display the next set of functions touch  which brings up the second set of Setting functions (Figure 4-5 C) to the right of the first set (Figure 4-5 A). Note that  is activated as the background color is now blue (Figure 4-5 B).



- To get the third and final set of functions touch  at the bottom of the list of the last column (Figure 4-5 C) and the third set of icons will replace the second set in the final column position (Figure 4-5 D).



- To return the second set of features touch the Return icon  at the top of the last column and the middle screen in Figure 4-5 will be returned.

*Note: When the Return icon is touched the Main Menu icon no longer has a blue “activated” background. The icons displayed are still associated with the original main menu icon selected, but the Return button removes the Main Menu background on some of the icons.*

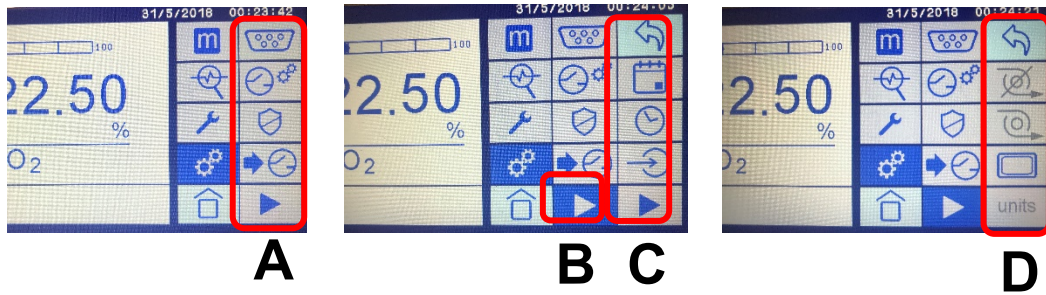

**Figure 4-5: The User Interface Menu screen with the Settings branch activated**

*Note: The Main Menu branch stays visible all the time even while navigating through the three sets of functional icons of the Settings branch. In this case, the first set of icons also remain visible and only the third column of icons is replaced when the Next List icon is touched.*

## 4.1 Home screen

The Home screen (Figure 4-6) displays the current measurement and system status.

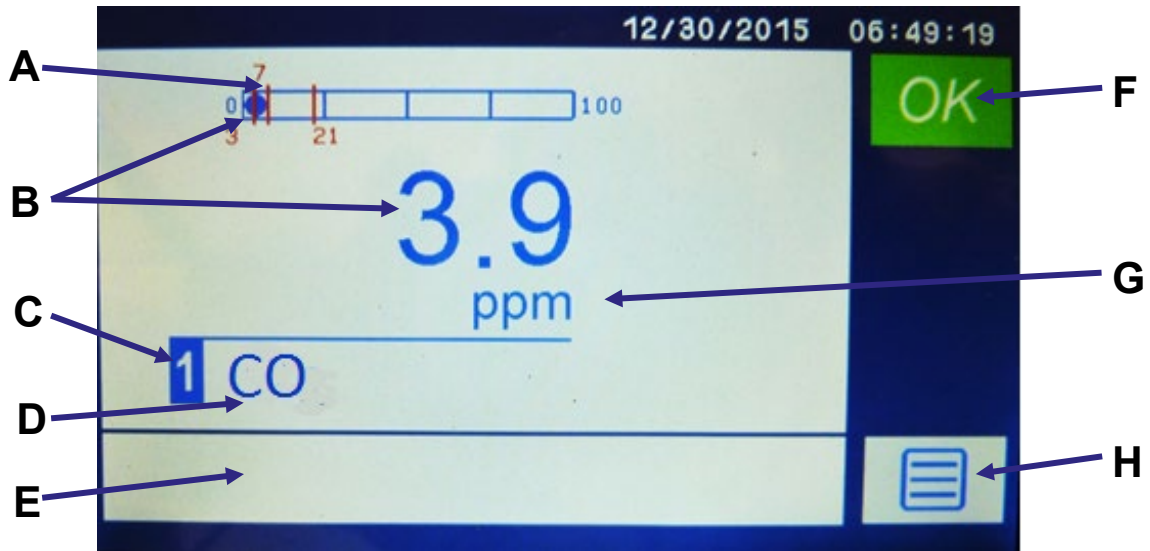
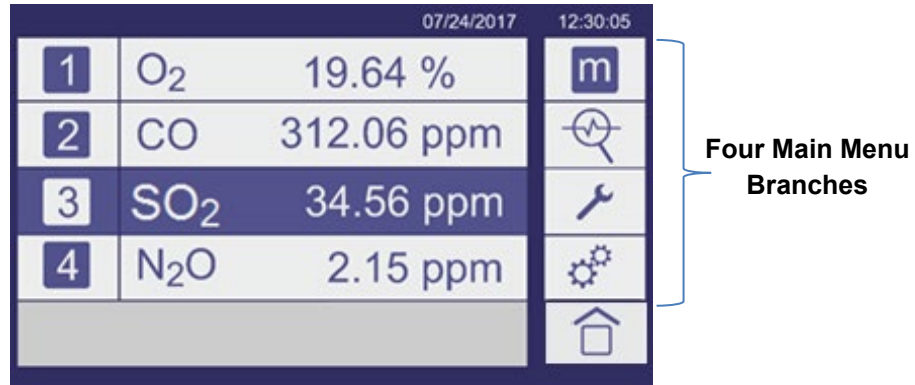

Figure 4-6: Single Gas Home screen components

- |   |  |   |   |
|---|--|---|---|
| A | Bar graph showing the operable measurement range boundaries, current measurement and relative to alarm set points in red | E | Information area where messages such as error codes, IP address, and diagnostic information are displayed |
| B | Current measurement concentration  | F | System status   |
| C | Transducer number  | G | Measurement units   |
| D | Analyte of interest  | H | Menu icon   |

**Hint:** If no icon is pressed for 1 minute in anywhere in the GUI the system reverts back to the Home screen. You will also then have to re-enter your password to access any password-protected screens. The "Home screen return time out" value can be modified in the Settings Menu to 1, 3 or 5 minutes.

## 4.2 Main Menu screen icons



**Figure 5-11: Menu screen**













The Main Menu icons are listed below:

Icon	Meaning	Function
	Measurement	Displays the Measurement screen where measurement, alarm and relay settings can be adjusted for each transducer.
	Diagnostics	Displays the Diagnostics screen where system-wide diagnostic tools can be found.
	Maintenance	Displays the Maintenance screen where system-wide maintenance actions can be initiated. Auto-calibrations are also located here.
	Settings	Displays the Settings screen where system-wide parameters can be defined.
	Home	Touch this icon to return to the Home screen.

## 4.3 Frequently Used Touchscreen icons

The following table shows touchscreen icons that frequently appear on different screens.

**Table 4-1: Frequently Used Touchscreen icons**

Icon	Meaning	Function
	Menu	Located on the Home screen (Figure 4-2 and Figure 4-3) displays the Menu screen of the four main menu branches when touched.
	<b>Measurement</b>	Displays the first set of functional icons associated with the Measurement operations (Figure 4-4).
	<b>Diagnostics</b>	Displays the first set of functional icons associated with the system-wide Diagnostics tools.
	<b>Maintenance</b>	Displays the first set of functional icons associated with the system-wide Maintenance operations.
	<b>Settings</b>	Displays the first set of functional icons associated with the system-wide parameters Settings including the Relay testing.
	Calibrate	Displays the first set of functional icons associated with configuring the various Calibrate functions and activities.
	Alarm settings	Displays the first set of functional icons associated with configuring the system-wide Alarm parameters.
	Home	This icon is used to return back to the Home screen showing the gas transducer concentration values.
	Accept	Touch this icon to accept any changes made.
	Cancel or Exit	Touch this icon to cancel, reject changes made or exit a screen.
	Next List	Touch this icon to display the next set of icons.
	Return	Touch this icon to return to the prior screen.

*Note: The four main menu branches are shown in **bold** in Table 4-1.*

## 4.4 System and measurement status icons and notices

The Status icon is located at the top right corner of the Home screen. If the system is healthy and happy, the green OK icon is displayed (Figure 4-7).



Figure 4-7: Home screen (three gas transducers)

*Note: If you touch the green OK icon it will display the date and time when the analyzer was last started.*

If a problem occurs with the system, the Status icon changes to one of the symbols below.



Icon	Meaning	Meaning
	Alarm	Indicates that there is a user set alarm active on the system. Touch the icon to display the Alarm Selection screen (Figure 4-8).
	Faults	Indicates a system fault with a transducer or analyzer (e.g. a communication failure with the transducer). Touch the icon to display a message in the text bar describing the fault (see Figure 4-9).



Figure 4-8: Home screen (3 transducer analyzer), showing O<sub>2</sub> alarm



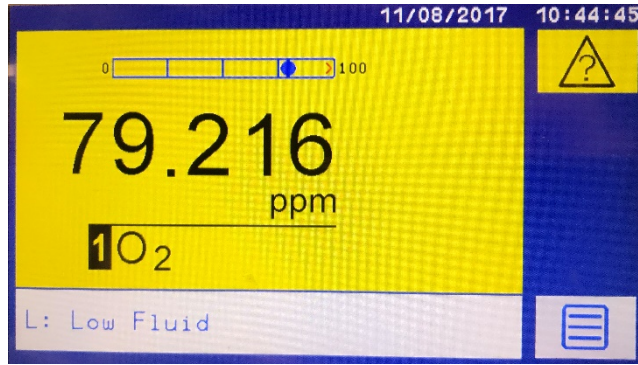

Figure 4-9: Home screen (3 transducer analyzer), showing warning screen with a “Low Fluid” fault description

## 5 Technical specification



The protection, accuracy, operation and condition of the equipment may be impaired if the analyzer is not installed in accordance with the requirements of this and other sections of the manual.

### 5.1 Mechanical specification

Dimensions: *(Width x Height x Length)*

**Rack mountable analyzer:**

Bench top: 430 x 141.2 x 544.2 mm  
16.9 x 5.5 x 21.4 inches

Bench top with expansion chassis: 430 x 273.7 x 544.2 mm  
16.9 x 10.7 x 21.4 inches

Rack mount: 481.6 x 132.5 x 544.2 mm  
19 x 5.2 x 21.4 inches

Rack mount with expansion chassis: 481.6 x 265.5 x 544.2 mm  
19 x 10.5 x 21.4 inches

**Weight:** Main unit: 14kg (30.9 lb) approx.  
Expansion chassis: 13.7 kg (30.2 lb) approx.



## 5.2 Electrical specification

### Electrical supply:

Voltage: 100 to 240 Vac, 50 to 60 Hz  
(± 10% maximum fluctuation)

Supply fuse rating / type: 6.3 AH / 250V. Size 20 x 5 mm

**Maximum power consumption:** 500 VA

**Interface signal relay ratings** 30 V (dc or ac) / 1A

*Note: The relay output signals are volt-free signals*

### mA output (active):

Maximum load resistance: 1 kΩ

Isolation voltage (to earth): 500 V (dc or ac)

Output range:

Normal sample measurement: 4 to 20 mA

Fault condition: 0 mA, 2 mA, 21.5 and none. User selectable

### Voltage output (active):

Minimum load resistance: 100 kΩ

Isolation voltage (to earth): 250 V (dc or ac)

Output range:

Normal sample measurement: 0 to 10 V

Fault condition: Fault condition selected as an option at the time of purchase.

Under range: Not applicable

### Signal / voltage / mA / RS485 output terminals suitable for:

Flexible conductors: 0.5 to 1.5 mm<sup>2</sup> (20 to 16 AWG)

Solid conductors: 0.5 to 1.0 mm<sup>2</sup> (20 to 18 AWG)

## 5.3 Maximum voltage ratings

### Common mode compared to chassis ground reference:

Signals:	Maximum voltage rating:
I1+, I1-, I2+, I2-, I3+, I3-, I4+, I4- V1+, V1-, V2+, V2-, V3+, V3-, V4+, V4- IIN1+, IIN1-, IIN2+, IIN2- IIN3+, IIN3-, IIN4+, IIN4- DIN3A, DIN3B, DIN4A, DIN4B J17(ALL)	250 Vac
All relays C, NC, NO	40 Vac
J6 (ALL)	15 Vdc
J8(ALL)	
J18 (ALL)	

### Differential mode between pairs:

Signals:	Maximum voltage rating:
All relays C, NC, NO	30 Vac, dc
IIN1+, IIN- or IIN2+, IIN2- or IIN3+, IIN3- or IIN4+, IIN4-	40 Vdc wrt V1-, V2-, V3-, V4-
DIN3A, DIN3B or DIN4A, DIN4B	24 Vdc
RS485TX+, RS485TX-	15 Vdc
RS485RX+, RS485RX-	15 Vdc
RS232TX, RS232RX	15 Vdc
J17 pin to pin	9 Vdc

## 5.4 Environmental limits

The equipment is suitable for indoor use only.

### Ambient temperature range:

Operation: 5 to 45 °C

Storage: 0 to 50 °C

**Operating ambient pressure range:** 101.3 kPa ± 10% (1.013 bar ± 10%)

**Operating ambient humidity range:** 10 to 90% RH, non-condensing

**Operating altitude range:** -500 metres (below sea level) to 2000 metres (above sea level)

**Ingress protection:** IP20

## 6 Storage and disposal

---

### 6.1 Storage

Refit any protective plastic covers and place the analyzer and any associated equipment in its original packaging before storage. Alternatively, seal it inside a waterproof plastic bag, sack, or storage box.

Store the analyzer and any associated equipment in a clean, dry area. Do not subject it to excessively hot, cold, or humid conditions.

### 6.2 Disposal

Dispose of the analyzer and any associated equipment safely, and in accordance with all of your local and national safety and environmental requirements.

**Hint:** *If you send the analyzer to Servomex or your local Servomex agent for disposal, it must be accompanied by a correctly completed decontamination certificate and a Return Product Authorization (RPA) number (section 7.2).*

#### 6.2.1 Disposal in accordance with the Waste Electrical and Electronic Equipment (WEEE) Directive

The label shown in Figure 6-1 is fitted to the analyzer.



**Figure 6-1: The WEEE label**

This label identifies that:

- The analyzer is considered to be within the scope of the Waste Electrical and Electronic Equipment (WEEE).
- The analyzer is not intended for disposal in a municipal waste stream (such as landfill sites, domestic recycling centers and so on), but must be submitted for material recovery and recycling in accordance with the local regulations which implement the WEEE Directive.

For additional information and advice on the disposal of the analyzer in accordance with the requirements of the WEEE Directive, contact Servomex or your local Servomex agent.

## 7 Warranty

---

Servomex instruments are warranted to be free from defects in workmanship and materials. Liability under this warranty is limited to servicing, calibrating, and replacing any defective parts of the instrument returned to an authorized Servomex Service Center for that purpose. Fuses are specifically excluded from any liability.

This warranty is effective from the date of delivery to the original purchaser. The equipment must be determined by Servomex to have been defective for the warranty to be valid.

This warranty applies as follows:

- one year for electronics
- one year for mechanical failures to the transducer

If damage is determined to have been caused by misuse or abnormal conditions of operation, the owner will be notified, and repairs will be billed at standard rates after approval.

Servomex Group Limited warrants each instrument manufactured by them to be free from defects in material and workmanship at the F.O.B. point specified in the order, its liability under this warranty being limited to repairing or replacing, at the Seller's option, items which are returned to it prepaid within one year from delivery to the carrier and found, to the Seller's satisfaction, to have been so defective.

In no event shall the Seller be liable for consequential damages. NO PRODUCT IS WARRANTED AS BEING FIT FOR A PARTICULAR PURPOSE AND THERE IS NO WARRANTY OF MERCHANTABILITY.

Additionally, this warranty applies only if: (i) the items are used solely under the operating conditions and in the manner recommended in the Seller's instruction manual, specifications, or other literature; (ii) the items have not been misused or abused in any manner or repairs attempted thereon; (iii) written notice of the failure within the warranty period is forwarded to the Seller and the directions received for properly identifying items returned under warranty are followed; and (iv) with return, notice authorizes the Seller to examine and disassemble returned products to the extent the Seller deems necessary to ascertain the cause of failure. The warranties stated herein are exclusive. THERE ARE NO OTHER WARRANTIES, EITHER EXPRESSED OR IMPLIED, BEYOND THOSE SET FORTH HEREIN, and the Seller does not assume any other obligation or liability in connection with the sale or use of said products.

## 7.1 Maintenance policy

In cases when equipment fault is suspected, please notify your representative of the problem and provide them with model and serial numbers.

If the problem cannot be resolved, then ask for a Return Product Authorization Number (RPA) and shipping instructions. The issue of an RPA does not automatically imply that the equipment is covered by our warranty - that will be determined after we receive the equipment.

Pack the equipment in a suitable box with sufficient padding, include the RPA number on your paperwork, and send the equipment, prepaid, to the designated address. Servomex will not accept equipment returned without a RPA, or with reversed shipping or import/export charges.

If the warranty has expired, or the damage is due to improper use or exposure of the equipment, Servomex will provide an estimate and wait for approval before commencing repairs.

## 7.2 Return Authorization Request

Servomex must approve and sign a Return Product Authorization Number (RPA) to any instrument being returned. The RPA must appear on all paperwork and packaging.

The issuance of an RPA does not automatically imply that the instrument is covered by our warranty.

In order to serve you better and to protect our employees from any potentially hazardous contaminants, Servomex must return, unopened and at the sender's expense, all items that do not have an RPA and a signed and filled out Decontamination Form.

OSHA Hazard Communication Standard 29CFR 1920.1200 mandated that we take specific steps to protect our employees from exposure to potential hazards. Therefore, a letter certifying that the equipment has been decontaminated must accompany all equipment exposed to hazardous contamination.

To obtain an RPA form, email your regional Servomex Service Center at the following addresses:

- North and South America: [americas\\_service@servomex.com](mailto:americas_service@servomex.com)
- Asia, Australia, New Zealand: [asia\\_service@servomex.com](mailto:asia_service@servomex.com)
- Europe, Middle East, Africa, India: [EMEA1\\_service@servomex.com](mailto:EMEA1_service@servomex.com)