



SERVOMEX
ANALYZERS
HIGH-PERFORMANCE GAS ANALYSIS



SERVOFLEX MiniHD 5200 OPERATOR MANUAL

Part Number: 05210001A
Revision: 5
Language: UK English



SERVOMEX.COM

SERVOMEX 
a spectris company

SERVOMEX - SPECIALISTS IN GAS ANALYSIS

Thank you for purchasing this Servomex product. Servomex has been specialising in the field of gas analysis for over half a century and our products have an excellent reputation for reliability and longevity.

When you require high performance gas analysis technology, Servomex is a market leader in terms of experience and knowledge.

Servomex supports all users of its products through a strong network of support teams. We are able to provide a wide range of services including commissioning, routine maintenance and troubleshooting. You can also call on one of our dedicated regional support teams to help you in an emergency, or to provide you with specialist advice.

Whenever people depend on high quality, reliable gas measurement to support improved plant efficiency and process control, to safeguard the safety of personnel and equipment, or to meet legislative requirements, you can expect to find Servomex.



Servomex Group Limited
Jarvis Brook, Crowborough
East Sussex, TN6 3DU
Tel: +44 (0) 1892 652181 Fax: +44 (0) 1892 662253
Global email: info@servomex.com
Website: http://www.servomex.com

EC DECLARATION OF CONFORMITY

We, Servomex Group Limited of the above address declare that the:

05210A1 PORTABLE GAS ANALYSERS

Conform to the requirements of:

EMC Directive, Council Directive 89/336/EEC (amended by Directives 92/31/EEC and 93/68/EEC) by the application of the following standard:

EN 50270:1999 Electromagnetic Compatibility - Electrical apparatus for the detection and measurement of combustible gases, toxic gases or oxygen.

Test Report References: Intertek Testing and Certification Ltd. EM 05018764(a) and EM05018764 (b)
Servomex report 05100-D-005. Servomex 5200 HD series portable gas analysers - EMC compliance rationale
Servomex report 05100-D-013. 5100 and 5200 HD EMC rationale – included IR3100 transducers

Dated: 5 January 2007

J. Hobby

Director of Technology

Registered in England No.2170458



This page intentionally blank.

LIST OF CONTENTS

Section		Page
1	DESCRIPTION AND DEFINITIONS	1
1.1	Scope of this manual	1
1.2	Safety information	1
1.3	Description	1
1.4	Sample measurement configurations	2
1.5	Other product options	2
2	SPECIFICATION	6
2.1	General	6
2.2	Environmental limits	6
2.3	Calibration gases	7
2.4	Sample gases	8
2.5	Performance: industrial oxygen sensor	9
2.6	Performance: high accuracy oxygen sensor	10
2.7	Performance: IR (infrared) sensors	11
2.8	Rechargeable battery	12
3	UNPACK THE ANALYSER	13
4	USER INTERFACE	14
4.1	Introduction	14
4.2	Start-up and measurement screens	14
4.3	Soft key legends	16
4.4	Status icon bar	17
4.5	Scroll bars	17
4.6	Menu options/screens and password protection	18
4.7	The Menu screen	20
4.8	The Settings screen	21
4.9	The Information screen	21
4.10	Editing on-screen data	22
5	BATTERY CHARGING AND SET-UP	23
5.1	Charging/recharging the battery	23
5.1.1	Charging	23
5.1.2	Recharging	24
5.2	Setting up the analyser	24
5.2.1	Switching on the analyser	24
5.2.2	Selecting the security level and changing the password(s)	25
5.2.3	Setting the clock	28
5.2.4	Changing regional settings	29
5.2.5	Selecting power save mode	30
5.2.6	Selecting pump operation (analyser with internal sample pump)	31

CONTENTS (CONTINUED)

Section		Page
6	GENERAL OPERATION	33
6.1	Locating the analyser and switching on	33
6.2	Calibrating the analyser	34
6.3	Taking sample readings	37
6.4	Correcting oxygen measurement for different background gases ..	38
6.4.1	Overview of measurement errors (oxygen only)	38
6.4.2	Entering a cross-interference compensation (oxygen only)	38
6.5	Selecting display units	39
6.6	Configuring the measurement alarms	41
6.6.1	Alarm modes and levels	41
6.6.2	Latching/non-latching alarms	41
6.6.3	Hysteresis levels	42
6.6.4	Setting the measurement alarm levels and modes	43
6.6.5	Enabling/disabling the audible measurement alarm	44
6.6.6	Silencing (muting) the audible measurement alarm	44
6.6.7	Unlatching measurement alarms	45
6.6.8	Viewing the measurement alarm status	45
6.7	Data logging	46
6.7.1	Introduction	46
6.7.2	Entering measurement data into the data log	46
6.7.3	Starting a new data log batch	47
6.7.4	Viewing the data log	47
6.7.5	Clearing the data log	48
6.8	Adjusting the display	49
6.8.1	Adjusting the backlight timer	49
6.8.2	Adjusting the contrast	49
6.9	Switching off the analyser after use	50
7	ROUTINE MAINTENANCE	51
7.1	Cleaning the analyser	51
7.2	Inspecting the inlet filter element	52
7.3	Use of the analyser for carbon monoxide or carbon dioxide measurements	53
7.4	Replacing the rechargeable battery pack	53
7.5	Preventative maintenance	54
8	FAULT FINDING	55
8.1	Introduction to faults and fault messages	55
8.2	Viewing fault messages	58
8.3	General fault finding	58
9	STORAGE AND DISPOSAL	63
9.1	Storage	63
9.2	Disposal	63
10	SPARES	64

CONTENTS (CONTINUED)

Section	Page
APPENDICES	
A1	DISPLAY UNIT CONVERSION FACTORS 65
A2	OPTIONAL GAS PROBE ACCESSORY 66
A2.1	Overview 66
A2.2	Preparing for use 66
A2.3	Using the probe 66
A2.4	Additional maintenance 66
A2.5	Additional spares 67
A3	OPTIONAL SAMPLE CONDITIONING KIT 68
A3.1	Overview 68
A3.2	Specification 68
A3.3	Using the analyser with the sample conditioning kit 70
A3.3.1	Calibrating 70
A3.3.2	Sampling gases 70
A3.4	Additional maintenance 71
A3.4.1	Draining the catchpot 71
A3.4.2	Replacing/regenerating the drying agent 71
A3.5	Additional spares 74
A4	MATERIALS IN CONTACT WITH SAMPLE AND CALIBRATION GASES 75
A5	DISPOSAL IN ACCORDANCE WITH THE WASTE ELECTRICAL AND ELECTRONIC EQUIPMENT (WEEE) DIRECTIVE 77
A6	COMPLIANCE AND STANDARDS INFORMATION 78

® Drierite is a registered trademark of W A Hammond Co.

® Viton is a registered trademark of Dupont.

® Kynar is a registered trademark of Elf Atochem North America, Inc.

© This manual is copyright, and no part of it may be reproduced without Servomex's written approval.

This page intentionally blank.

1 DESCRIPTION AND DEFINITIONS

1.1 Scope of this manual

This manual provides installation, operation and routine maintenance instructions for the Servomex 5200 HD Portable Gas Analyser, abbreviated to "analyser" in the remainder of this manual.

1.2 Safety information

Read this manual and ensure that you fully understand its content before you attempt to install, use or maintain the analyser. Important safety information is highlighted in this manual as WARNINGS and CAUTIONS, which are used as follows:

	WARNING Warnings highlight specific hazards which, if not taken into account, may result in personal injury or death.
---	---

CAUTION Cautions highlight hazards which, if not taken into account, can result in damage to the analyser or to other equipment or property.
--

This manual also incorporates 'Be aware of' information, which is used as follows:

-  This highlights useful information which you should be aware of (for example, specific operating conditions, and so on).

1.3 Description

	WARNING This analyser is not a medical device as defined in the medical devices directive 93/42/EEC and is not intended to be used on human beings for the diagnosis, prevention, monitoring, treatment or alleviation of disease, injury or replacement or modification of the anatomy.
---	--

	WARNING The analyser must not be used as personal protective equipment.
---	---

	WARNING The analyser is only suitable for use in safe areas. You must not use the analyser in hazardous areas.
---	--

The 5200 HD analyser is a heavy duty, portable gas analyser, suitable for the needs of field and laboratory analysis, and industrial users who require fast, accurate and reliable gas analysis.

The analyser uses a paramagnetic transducer to determine the oxygen content of gas samples, or uses an infrared transducer to determine the carbon dioxide (CO₂) or carbon monoxide (CO) content of gas samples.

Gas sample measurements are shown on the analyser display (see Section 4.2).

The analyser is supplied with an internal rechargeable battery, and with a power supply unit.

The analyser is simple to operate, with an intuitive user interface (see Section 4).

The analyser requires little routine maintenance (see Section 7), other than calibration (which is essential for the accuracy of sample gas measurements) and regular inspection of the inlet filter element.

1.4 Sample measurement configurations

The analyser can be supplied configured to determine one of the following gas sample measurements:

- Oxygen (using a paramagnetic transducer)
- Carbon monoxide (using an IR transducer)
- Carbon dioxide (using an IR transducer)

1.5 Other product options

The analyser can be supplied with the following options:

- With an internal sample pump, or with an AFCD (Automatic Flow Control Device)
- With a gas probe accessory
- With a sample conditioning kit
- With a carry case (black)
- With a protective transport case

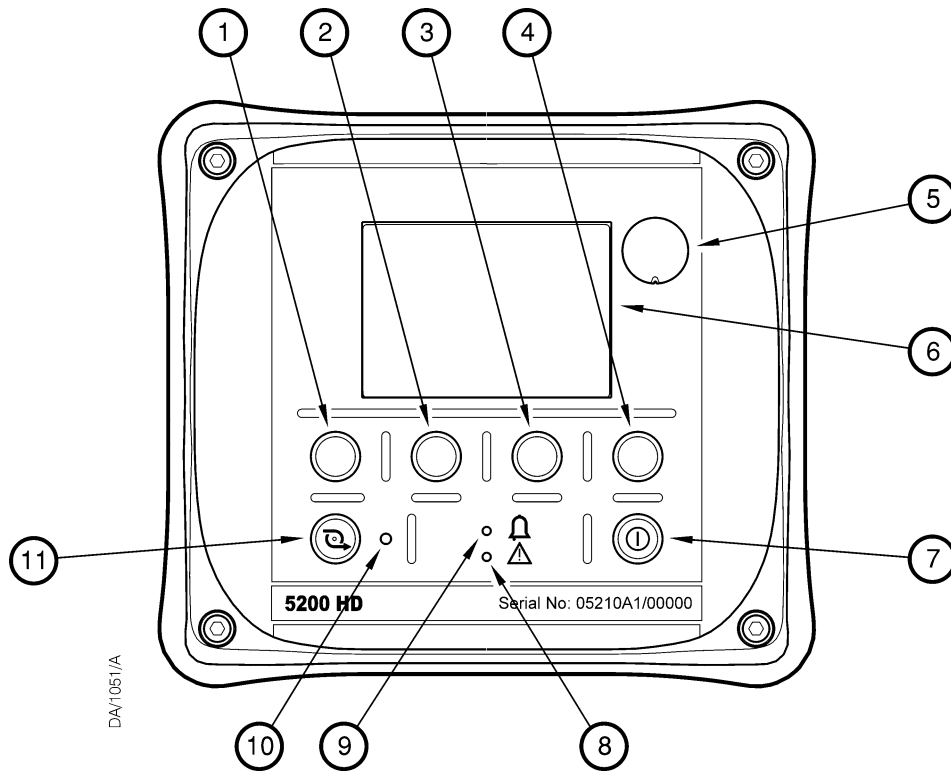

Key	Description	Key	Description
1.	Soft key 1	7.	Power On/Off key
2.	Soft key 2	8.	Fault LED (amber)
3.	Soft key 3	9.	Alarm LED (red)
4.	Soft key 4	10.	Sample pump LED (green) †
5.	Sample gas label *	11.	Sample pump key †
6.	Display		

* The legend on the label shows the sample gas for which the analyser is configured.

† Only active if the analyser has an optional internal sample pump.

Figure 1 - Top of the analyser

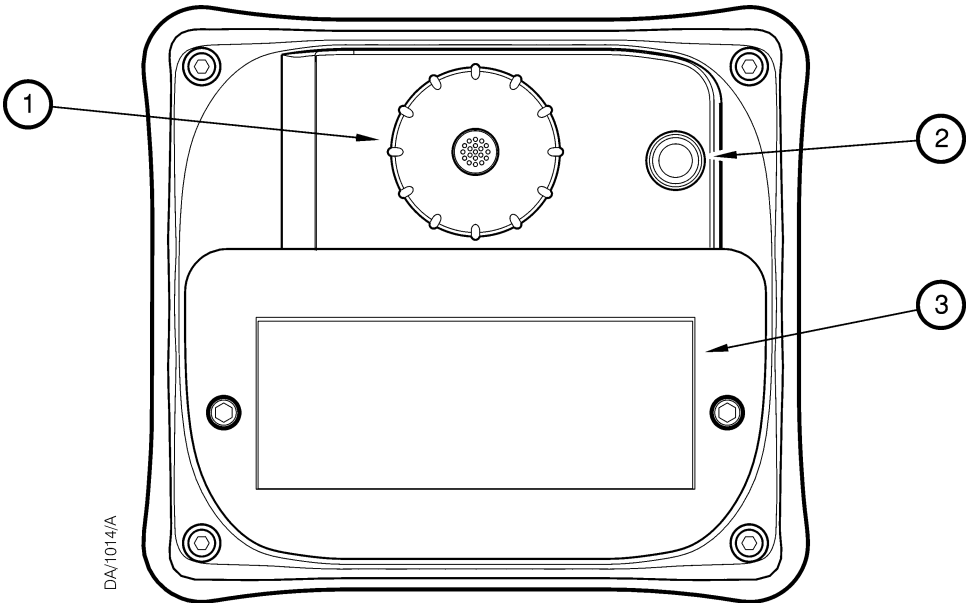

Key	Description
1.	Filter retaining cap
2.	Breather vent
3.	Rechargeable battery cover

Figure 2 - Bottom of the analyser

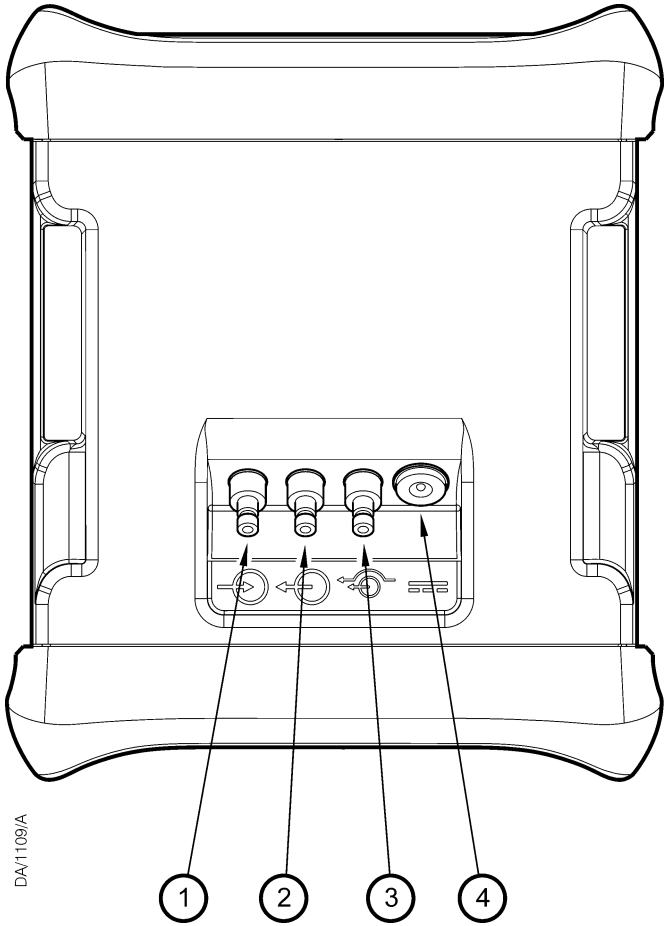

Key	Description
1.	Sample gas inlet
2.	Sample gas outlet

Key	Description
3.	Bypass gas outlet
4.	DC power inlet

Figure 3 - Back of the analyser

2 SPECIFICATION

	<p>WARNING</p> <p>You must install and use the analyser in accordance with the requirements of this section and subsequent sections of the manual. If you do not, the protection facilities incorporated into the design of the analyser may not operate as intended, sample gas measurements may not be accurate, or the analyser may be damaged.</p>
---	---

2.1 General

Dimensions (width x depth x height)	160 x 140 x 185 mm (6.3 x 5.5 x 7.3 in.)
Mass (minimum to maximum)	1.8 to 2.3 kg (4.0 to 5.1 lb)
Electrical supply requirements	
Power supply unit	100 to 240 V a.c., 47 to 63 Hz (nominal)
Analyser	12 V d.c. \pm 5%, 12 W (maximum) *

* As supplied by the power supply unit (through a centre pin +ve connector).

2.2 Environmental limits

Ambient temperature range	
Operation	-10 to +50 °C (14 to 122 °F)
Storage *	-20 to +60 °C (-4 to 140 °F)
Battery charging	+10 to +40 °C (50 to 104 °F)
Operating ambient pressure range	101.3 kPa absolute (1.013 bar absolute, 14.7 psi absolute) \pm 10%
Operating ambient humidity range	0 to 95% RH, non-condensing
Operating altitude range	-500 † to 5000 ‡ meters (-1640 † to 16404 ‡ feet)
Ingress protection	IP65

* Storage below 21 °C (70 °F) is recommended to ensure optimum battery life.

† Below sea level.

‡ Above sea level.

2.3 Calibration gases

	<p>WARNING</p> <p>If the analyser is specified for use with carbon monoxide or carbon dioxide, the concentrations of the gases used may be above their respective threshold limit values, and should therefore be considered toxic. You must therefore carry out a risk assessment before you use the analyser with such gases. The maximum inlet pressures of such gases are:</p> <ul style="list-style-type: none"> • For an analyser with an internal sample pump: 8.9 kPa gauge (0.089 bar gauge, 1.3 psi gauge). • For an analyser with an AFCD: 35 kPa gauge (0.35 bar gauge, 5 psi gauge).
---	--

	<p>WARNING</p> <p>The calibration gas must not contain or be contaminated with any substances that are incompatible with the materials in contact with the gases as specified in Appendix A4.</p>
---	--

Low calibration gas	Oxygen-free nitrogen, 99.9% pure
High calibration gas	
Industrial oxygen sensor	Certified oxygen supply * or instrument quality air †, or other supply (with > 20% oxygen)
High accuracy oxygen sensor	Certified oxygen supply * or instrument quality air †, or other supply (with > 1% oxygen)
IR (infrared) sensor	Certified gas supply with a concentration in the range 80 to 100% of the corresponding IR sensor max measurement (see Section 2.7)
Calibration gas flow rate ‡	
Minimum	1 l min ⁻¹ (0.035 ft ³ min ⁻¹)
Maximum	2.5 l min ⁻¹ (0.088 ft ³ min ⁻¹)



* > 99.2% pure oxygen, with nitrogen balance gas.

† The air supply must be clean and dry, and free from oil.

‡ Analyser with internal sample pump.

 With a high accuracy oxygen sensor, there must be at least a 1% difference in oxygen concentration between the low and high calibration gases. With the industrial oxygen sensor, there must be at least a 20% difference in oxygen concentration between the low and high calibration gases.

2.4 Sample gases

	WARNING
	The analyser must not be used with flammable sample gases. You must therefore carry out a risk assessment before you use the analyser, to ensure that the gases you will sample are not flammable.
	WARNING
	If the analyser is specified for use with carbon monoxide or carbon dioxide, the concentrations of the gases used may be above their respective threshold limit values, and should therefore be considered toxic. You must therefore carry out a risk assessment before you use the analyser with such gases. The maximum inlet pressures of such gases are:
	<ul style="list-style-type: none"> • For an analyser with an internal sample pump: 8.9 kPa gauge (0.089 bar gauge, 1.3 psi gauge). • For an analyser with an AFCD: 35 kPa gauge (0.35 bar gauge, 5 psi gauge).
	WARNING
	The sample gas must not contain or be contaminated with any substances that are incompatible with the materials in contact with the gases as specified in Appendix A4.

Pressure range: analyser with internal sample pump

Minimum	-3.4 kPa gauge (-0.03 bar gauge, -0.5 psi gauge)
Maximum	3.4 kPa gauge (0.03 bar gauge, 0.5 psi gauge)

Pressure range: analyser with AFCD

Minimum	7.0 kPa gauge (0.07 bar gauge, 1 psi gauge)
Maximum	70 kPa gauge (0.7 bar gauge, 10 psi gauge)
Dew point	Less than ambient temperature minus 10 °C (18 °F)
Particulate size	Less than 2 µm
Nominal flow rate *	700 ml min ⁻¹ (0.025 ft ³ min ⁻¹)

* Analyser with optional internal sample pump.

2.5 Performance: industrial oxygen sensor

 The display indication given below is the default indication. You can configure the analyser to provide other display indications (see Section 6.5).

Display indication (default)	Measured volume % oxygen
Full Scale Range	0 to 100% oxygen
Resolution	0.1% oxygen
Linearity	± 0.1% oxygen
Intrinsic error (accuracy)	± 0.1% oxygen [*] , or ± 0.2% oxygen [†]
Zero drift per week	± 0.4% oxygen
Output fluctuation	± 0.1% oxygen
Response time [#]	15 seconds
Flow variation effect	± 0.1% oxygen [‡]
Zero temperature coefficient	± 0.2% oxygen per 10 °C (18 °F)
Span temperature coefficient	± 0.3% oxygen per 10 °C (18 °F)
Tilt effects	± 0.15% oxygen per 15° of tilt (from calibration orientation)
Pressure effects	Directly proportional to ambient barometric pressure [§]
Power cycle offset	± 0.4% maximum

* High calibration with certified oxygen supply (see Section 2.3).

† High calibration with instrument air or other oxygen supplies (see Section 2.3).

T₉₀. Response time will increase if the analyser has a sample conditioning kit.

‡ Within sample gas supply pressure range specified in Section 2.4.

§ A 1% change in ambient barometric pressure will result in a 1% change in sample reading.

2.6 Performance: high accuracy oxygen sensor

 The display indication given below is the default indication. You can configure the analyser to provide other display indications (see Section 6.5).

Display indication (default)	Measured volume % oxygen
Full Scale Range	0 to 100% oxygen
Resolution	0.01% oxygen
Linearity	± 0.01% oxygen
Intrinsic error (accuracy)	± 0.05% oxygen
Zero drift per week	± 0.2% oxygen
Output fluctuation	± 0.01% oxygen
Response time *	15 seconds
Flow variation effect	± 0.1% oxygen ‡
Zero temperature coefficient	± 0.2% oxygen per 10 °C (18 °F)
Span temperature coefficient	± 0.3% oxygen per 10 °C (18 °F)
Tilt effects	± 0.15% oxygen per 15° of tilt (from calibration orientation)
Pressure effects	Directly proportional to ambient barometric pressure †

* T_{90} . Response time will increase if the analyser has a sample conditioning kit.

‡ Within sample gas supply pressure range specified in Section 2.4.

† A 1% change in ambient barometric pressure will result in a 1% change in sample reading.

2.7 Performance: IR (infrared) sensors

-  The display indications given below are the default indications. You can configure the analyser to provide other display indications (see Section 6.5). Allow 1 hour warm up to reach stated accuracy.

Display indication	Measured volume % carbon monoxide, carbon dioxide or methane.
Many performance parameters are dependant on the 'Full Scale Range' of the IR Sensor, such as 0 to 5%, 0 to 10%, 0 to 25% or 0 to 100% *	
Resolution	Less than 0.1% Full Scale Range
Linearity	± 1% Full Scale Range
Intrinsic error (accuracy)	± 2% Full Scale Range
Zero drift per week	± 4% Full Scale Range
Output fluctuation	± 0.3% Full Scale Range
Response time †	Less than 10 seconds
Flow variation effect	± 0.5% Full Scale Range ‡
Zero temperature coefficient #	± 1% Full Scale Range per 10 °C (18 °F)
Span temperature coefficient #	
100% CO ₂ only	± 8.5% Full Scale Range per 10 °C (18 °F)
All other IR measurements	± 5% Full Scale Range per 10 °C (18 °F)
Tilt effects	± 1% Full Scale Range per 15° of tilt (from calibration orientation)
Pressure effects	Less than 0.2% measurement per 0.1 kPa (1 mbar, 0.0145 psi) change in ambient barometric pressure

* The ranges listed identify some of the different IR sensors available.

† T₉₀. Response time will increase if the analyser has a sample conditioning kit.

‡ Within sample gas supply pressure range specified in Section 2.4.

In the range 5 to 45 °C (41 to 113 °F).

2.8 Rechargeable battery

Battery type	Lithium ion
Time to recharge (from empty)	4 to 8 hours
Operating life (from fully charged)	8 to 24 hours *
Service life	Approximately 300 to 500 discharge/recharge cycles (depending on ambient conditions)

* Battery operating life depends on the analyser configuration (that is, the options that are fitted), and how the analyser is used.

 Lithium ion batteries have no 'memory effects', so you can recharge the battery, from any charge level, for any length of time and for often as you like, without affecting the battery's service life.

To ensure the optimum service life of the battery, we recommend that:

- You recharge the battery after each session of operation.
- When it is not in use, you store the analyser (with the battery fully charged) in a cool environment (see Section 2.2), then recharge the battery every 2 months.

3 UNPACK THE ANALYSER

CAUTION

Do not use the analyser if it is damaged. If the analyser is damaged, it may not operate correctly.

1. Remove the analyser and any other equipment from its packaging.
2. Remove the protective plastic covers from the sample gas inlet and sample gas outlet on the back of the analyser (see Figure 3).
3. Remove the protective plastic cover from the bypass gas outlet on the back of the analyser (see Figure 3).
4. Inspect the analyser and the other items supplied, and check that they are not damaged. If any item is damaged, immediately contact Servomex or your local Servomex agent (refer to the caution above).
5. If you do not intend to use the analyser immediately:
 - Refit the protective plastic covers to the gas inlet, the sample gas outlet and the bypass gas outlet.
 - Place the analyser and any other equipment supplied back in its protective packaging.
 - Store the analyser as described in Section 9.1.

Otherwise, read Section 4 (User Interface), then continue at Sections 5 onwards to install, set up, and use the analyser.

-  Retain the shipping documentation and packaging for future use (for example, return of the analyser to Servomex for servicing or repair).

CAUTION

You must remove the protective plastic covers as specified in Steps 2 and 3 above before you use the analyser. If you do not, you may damage the analyser when you try to pass calibration or sample gases through it.

4 USER INTERFACE

-  Throughout this manual, reference is made to product options which must be specified at the time of purchase. Associated menus and menu options will not be available if your analyser does not have the corresponding product options.

4.1 Introduction

The analyser user interface comprises the following (shown on Figure 1):

Power On/Off key	Use this key to switch the analyser on (see Section 5.2.1) or to switch it off (see Section 6.9).
Display	Shows various screens: see Section 4.2 onwards.
Soft keys	The function of each of the soft keys depends on the screen currently being shown on the display: see Section 4.2.
Alarm LED	On when an alarm condition exists: see Section 6.6.4.
Fault LED	On when a fault condition exists: see Section 8.
Sample pump key *	Use this key to switch the sample pump on and off: see Section 5.2.6.
Sample pump LED *	Flashes when the sample pump is operating: see Section 5.2.6.

* Only available if your analyser has an internal sample pump.

The analyser also has an audible alarm which will go on (emit a tone):

- On initial switch-on: see Section 5.2.1.
- When a measurement alarm condition is detected (if the audible measurement alarm is enabled): see Section 6.6.5.
- When a fault condition is detected: see Section 8.

4.2 Start-up and measurement screens

When you first switch on the analyser, a 'start-up screen' is displayed while the analyser carries out a self-test.

The start-up screen shows the Servomex name, a 'self-test time elapsed/remaining' indicator, and messages identifying the tasks being carried out as part of the self-test:

- The screen will initially display the message "System Check".
- If your analyser is configured for use with an IR sensor, the following messages will be displayed: "Infrared Initialising" and "Infrared Warming".

The Measurement screen is then displayed, as shown in Figure 4 below.

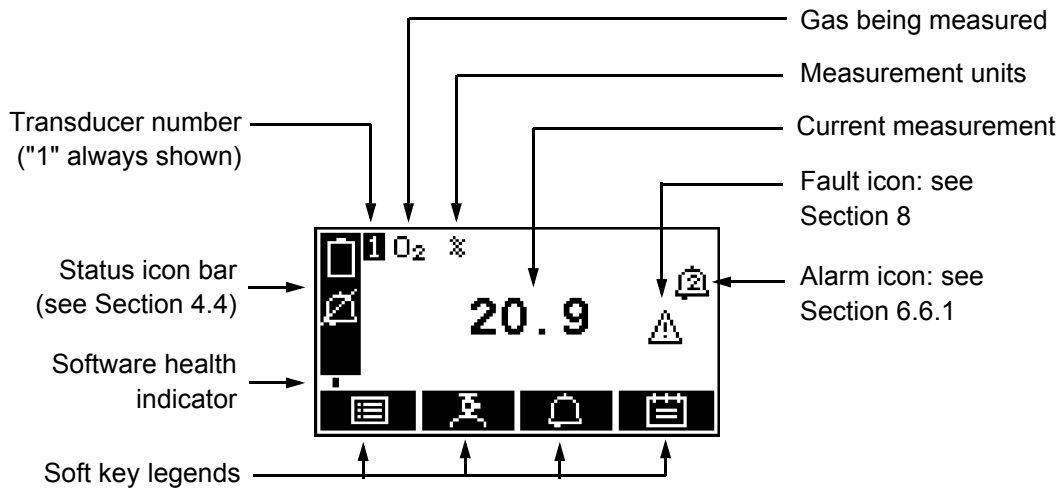







Figure 4 - The Measurement screen

-  During normal analyser operation, the software health indicator continuously moves from left to right and then back again, below the status icon bar. If the indicator stops moving, this means that the analyser is not operating correctly, and you must refer to Section 8.
-  If no soft key is pressed for 10 minutes, the Measurement screen will be automatically displayed. (You will also then have to enter the password again to access any password-protected screens: refer to Figure 5 and to Section 4.6.)

4.3 Soft key legends









The four soft key legends at the bottom of the Measurement screen (Figure 4) correspond to the four soft keys on the top of the analyser. (The first legend corresponds to the function of soft key 1, the second legend corresponds to the function of soft key 2, and so on).

On the Measurement screen, the soft key functions are as follows:

Legend	Meaning	Function (when soft key pressed)
	Menu	Displays the Menu screen: see Section 4.7.
	Calibrate *	Displays the Calibrate screen: see Section 6.2.
	Alarm *	Displays the Alarm option screen: see Section 6.6.4.
	Logging	Displays the Data logging screen: see Section 6.7.







* These soft keys are 'shortcuts' to these menus, which can also be selected by pressing the  soft key with the corresponding menu option highlighted on the Menu screen: see Section 4.7.

Other soft key legends which are used on the various screens are as follows:

Legend	Meaning	Function (when soft key pressed)
	Back	Cancels the current screen and displays the previous screen in the menu structure.
	Accept	Accepts the currently selected option or data. (A new screen may be displayed accordingly.)
	Edit	Allows the highlighted data to be edited.
	Batch	Starts a new batch (for data logging).
	Up	Moves the cursor up a list (or increases a digit during editing).
	Down	Moves the cursor down a list (or decreases a digit during editing).
	Left	Moves the cursor left.
	Right	Moves the cursor right.

4.4 Status icon bar



The status icon bar appears on all screens. The icons which can be shown and their meanings are as follows:

Icon	Meaning
	Indicates that a fault has been detected by the analyser: refer to Section 8.
	Indicates that the audible alarm is disabled: refer to Section 6.6.5.
	Battery less than 10% full.
	Battery 10% to 32% full.
	Battery 33% to 65% full.
	Battery 66% to 100% full.

 When the 'battery less than 10% full' icon starts to flash, this indicates that the rechargeable battery is virtually empty. The analyser will automatically shut down approximately 15 seconds after the icon starts to flash.

4.5 Scroll bars

On some screens (for example, see Figure 6), there may be more options available than can be shown on the screen, and you have to scroll down the screen to view all of the options: this is identified by a scroll bar at the right-hand side of the screen.

The height of the wide part of the scroll bar gives an indication of what proportion (of all the options) are currently shown on the screen. As you scroll up or down the options (using the  and  soft keys), the wide part of the scroll bar will also move on the screen, indicating approximately where the currently displayed options are, within the complete list of options. For example, compare the scroll bars in Figures 6 and 13.

4.6 Menu options/screens and password protection

The menu structure of the analyser is shown in Figure 5, which shows that some of the options/screens are password protected.

When an option/screen is password protected, this means that the correct corresponding password has to be entered before the option/screen can be accessed.

Password protection operates as follows:

- The first time you try to access a password-protected option/screen, you will be prompted for the corresponding password. You must then enter the correct password (using the editing method described in Section 4.10) before the option/screen can be displayed.
- If you have already entered the corresponding password, you will gain access to all options/screens protected by that password immediately (you do not need to enter the password again).

 Once you have entered a password, it remains active until 10 minutes after the last soft key is pressed. After this, the password becomes inactive; you must re-enter the password to access password-protected options/screens again.

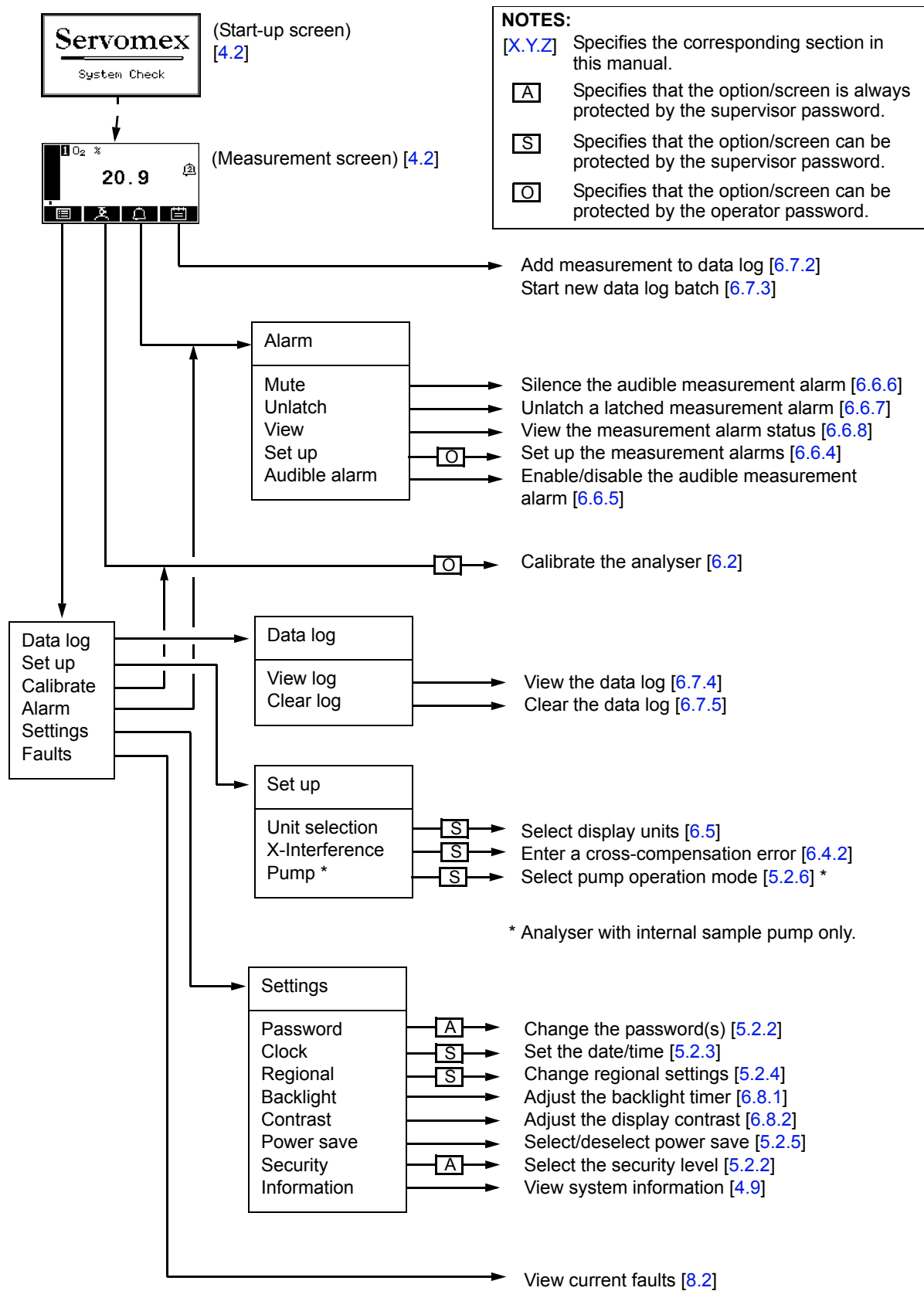



Figure 5 - The analyser menu structure

4.7 The Menu screen

 Some of the menu screens referenced below may not be available: refer to the note at the start of Section 4.

The Menu screen (see Figure 6) provides access to other screens in the menu structure, and is displayed by pressing the  soft key when the Measurement screen is displayed.

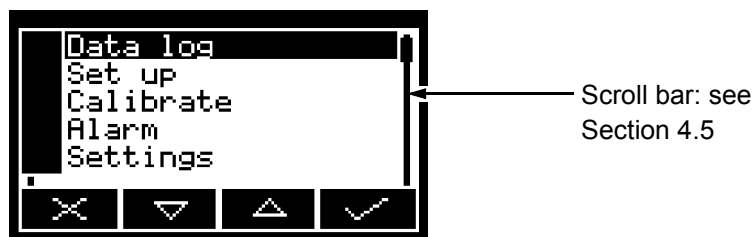





Figure 6 - The Menu screen

Use the  and  soft keys to highlight the required screen option, then press the  soft key to display the selected screen:

Screen	Use	Section
Data Log	Select this screen to view or clear the data log.	6.7.4, 6.7.5
Set up	Select this screen to configure the sample pump (if fitted), introduce a cross-interference correction, or select the display units.	5.2.6, 6.4.2, 6.5
Calibrate	Select this screen to calibrate the analyser.	6.2
Alarm	Select this screen to set up the measurement alarms, or to silence (mute) the audible measurement alarm.	6.6.4
Settings	Select this screen to change analyser settings (password, display language and so on).	4.8
Faults	Select this screen to view current faults.	8.2

Alternatively, press the  soft key to display the Measurement screen again.

4.8 The Settings screen

The Settings screen is shown in Figure 7.



Use the  and  soft keys to highlight the required screen option, then press the  soft key to display the selected screen, as shown below:



Figure 7 - The Settings screen

Screen	Use	Section
Password	Changing the password.	5.2.2
Clock	Setting the clock time and/or date.	5.2.3
Regional	Changing regional settings (language and so on).	5.2.4
Backlight	Adjusting the backlight timer duration.	6.8.1
Contrast	Adjusting the contrast of the screen.	6.8.2
Power save	Selecting/deselecting 'power save' operation.	5.2.5
Security	Selecting the security level.	5.2.2
Information	Viewing analyser system information.	4.9

Alternatively, press the  soft key to display the Menu screen again.

4.9 The Information screen

A typical Information screen is shown in Figure 8.

This screen shows information (such as the analyser serial number and the version of the operating software embedded in the analyser) which is useful to the Servomex support team.

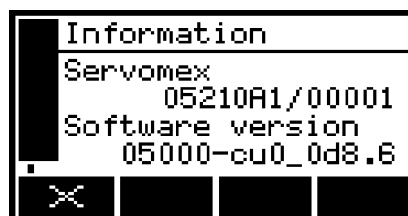





Figure 8 - Typical information screen

Note that the information shown on the screen will vary, depending on the analyser model.

After viewing (and if necessary recording) the information shown on the screen, press the  soft key to display the Settings screen again, or press and hold the  soft key to show the Measurement screen again.

-  You may be asked to provide the information from this screen to the Servomex support team; for example, as an aid to fault diagnosis.

4.10 Editing on-screen data

A common method is used for editing data shown on all of the different screens.







When you press the  soft key to edit an item of data, the screen changes to show the corresponding edit screen, with the first digit highlighted; a typical edit screen is shown in Figure 9:



Figure 9 - A typical edit screen

When the first digit is highlighted, press the  soft key to exit the menu without changing the data.

Alternatively, use the soft keys to edit the data as follows:

Soft key	Function
	Increases the highlighted digit by 1.
	Decreases the highlighted digit by 1.
	Moves the cursor left to the previous digit.
	Moves the cursor right to the next digit.

Note that the figures above and below the highlighted digit show the digits above and below the currently highlighted value.



When the last digit is highlighted, press the  soft key to enter the new data.

-  When editing numerical values, the decimal point appears between digits "9" and "0".

5 BATTERY CHARGING AND SET-UP

5.1 Charging/recharging the battery

5.1.1 Charging

	<p style="text-align: center;">WARNING</p> <p>You must only use the power supply unit supplied (or a Servomex approved replacement) to power the analyser and charge the battery. If you use another type of power supply unit, you may damage the analyser, and there may be a risk of electric shock when you use it.</p>
	<p style="text-align: center;">WARNING</p> <p>Ensure that the electrical installation of the analyser and the power supply unit conforms with all applicable local and national electrical safety requirements.</p>

Before you first use the analyser for sample gas measurements, you must charge the battery as follows:

1. Place the analyser in a suitable location, within easy reach of a suitable electrical supply outlet.
2. Fit the power outlet on the power supply unit to the DC power inlet on the back of the analyser (see Figure 3).
3. Fit the power supply unit plug to a suitable electrical supply outlet.
4. Leave the analyser connected to the electrical supply until it is fully charged (refer to the notes in Section 5.1.2). This will take a minimum of 4 hours: see Section 2.8.

When the battery is fully charged:

- You can leave the analyser connected to the electrical supply while you set up the analyser as described in Section 5.2.
- You can disconnect the analyser from the power supply unit and take it to another area, where you will install and use the analyser. You can then set up the analyser (as described in Section 5.2), while the analyser is powered by the battery.

5.1.2 Recharging

-  We recommend that you recharge the battery after each sampling session, or as soon as possible after the 'battery less than 10% full' icon is displayed.

During normal use, the battery icon on the status icon bar of the display will identify the level of charge within the battery (see Section 4.4).

When you need to recharge the battery, use the procedure in Section 5.1.1.

-  During recharging, the status icon bar will continually show the 'battery less than 10% full', 'battery 10 to 32% full', 'battery 33 to 65% full' and 'battery 66 to 100% full' icons in sequence. When the battery is fully charged, the 'battery 66 to 100% full' icon will be permanently displayed.

-  You can recharge the battery with the analyser switched on or off.

-  If you connect the power supply unit to the electrical supply and to the analyser when the battery is fully charged (that is, the battery does not need to be recharged), none of the battery icons will be shown on the status icon bar.

5.2 Setting up the analyser

5.2.1 Switching on the analyser

-  When the analyser is switched on, the Alarm LED, the Fault LED and the audible alarm will all go on for 1 second to demonstrate that they are functioning correctly, and will then go off again.

Press and hold the Power On/Off key on the top of the analyser for at least 4 seconds to switch the analyser on.

When you switch on the analyser, a 'start-up screen' is first displayed (see Section 4.2), then the Measurement screen (Figure 4) is displayed.

When the Measurement screen is displayed, you can set up the analyser as described in the following sections.

5.2.2 Selecting the security level and changing the password(s)

Introduction to security levels/passwords

You can configure the analyser to provide any of three levels of security:

Security level	Function
Low	None of the options/screens are password protected *.
Standard	Some of the options/screens are protected by a supervisor password.
High	Some of the options/screens are protected by a supervisor password and some of the options/screens are protected by an operator password †.

* Except for the 'change the password(s)' and 'select the security level' options/screens: see notes below.

† The supervisor password can also be used to access options/screens protected by the operator password: see notes below.





-  The 'change the password(s)' and 'select the security level' screens/options are always protected by the supervisor password, regardless of the security level selected. This is to ensure that unauthorised personnel cannot change the security level and password(s) and so lock out the analyser from other users.
-  The supervisor password provides access to all password protected options/screens. That is, if you have selected the 'high' security level and are prompted to enter the operator password, you can also access the option/screen by entering the supervisor password.
-  Password protection can be used to prevent adjustment of the clock by unauthorised persons, so ensuring the validity of measurement times and the 'time since last calibration' history.

Figure 5 shows the options/screens which can be password-protected within the menu structure.

Selecting the security level

-  As supplied, the security level is set to 'high', the supervisor password is set to "2000" and the operator password is set to "1000". We recommend that you select your required security level and change the password(s) as described below to provide additional protection.

Before the analyser is used for sample measurement, we recommend that you select the security level (low, standard or high: see Section 4.6) most suitable for the way in which the analyser will be used by you and/or your personnel.

Use the following procedure to select the required security level:



1. With the Settings screen displayed, use the  and  soft keys to highlight the "Security" menu option, then press the  soft key. The Security level screen will then be displayed showing the currently selected level: see Figure 10.



Figure 10 - The Security level screen





2. To change the security level, press the  soft key. You will then be prompted to enter the supervisor password.
3. Once the supervisor password has been entered correctly, the Security select screen will be displayed (see Figure 11), with the currently selected security level highlighted.



Figure 11 - The Security select screen

4. To change the security level, use the  and  soft keys to highlight the required level, then press the  soft key. The Security level screen will then be displayed again, showing the newly selected security level.
5. Press the  soft key twice to display the Menu screen again.

Changing passwords

- ☞ If you change a password, ensure that you record the new password somewhere safe. Otherwise, if you cannot recall the new password, you will have to contact Servomex or your local Servomex agent for assistance.

Use the following procedure to change the supervisor and operator passwords:

















1. With the Measurement screen displayed, press the  soft key to display the Menu screen, use the  and  soft keys to highlight the "Settings" menu option, then press the  soft key. The Settings screen will then be displayed (see Figure 7).
2. Use the  and  soft keys to highlight the "Password" menu option, then press the  soft key. The Edit supervisor password screen will then be displayed with the supervisor password shown, as shown in Figure 12.









Figure 12 - The Edit supervisor password screen

3. To change the supervisor password, press the  soft key, then enter the new password: use the editing method described in Section 4.10.
4. When you enter the last digit, the  soft key changes to the  soft key. Press the  soft key to enter the new supervisor password value.
5. To change the operator password, press the  soft key to display the edit operator password screen, press the  soft key, then enter the new password: use the editing method described in Section 4.10.
6. When you enter the last digit, the  soft key changes to the  soft key. Press the  soft key to enter the new operator password value.
7. Press the  soft key to display the Settings screen again.

5.2.3 Setting the clock

Use the following procedure to set the date and time:

1. Press the  soft key to display the Menu screen, use the  and  soft keys to highlight the "Settings" menu option, then press the  soft key. The Settings screen will then be displayed.
2. Use the  and  soft keys to highlight the "Clock" menu option, then press the  soft key. The Clock (time) screen will then be displayed, as shown in Figure 13.







 Time is always shown in 24-hour format.



Figure 13 - The Clock (time) screen

3. Press the  soft key, then edit the displayed time as described in Section 4.10. When you change the last digit, the  soft key changes to the  soft key. Press the  soft key to show the Clock (time) screen again.
4. Press the  soft key to show the Clock (date) screen, as shown in Figure 14.







 You can change this format from day/month/year to month/day/year: refer to Section 5.2.4.



Figure 14 - The Clock (date) screen

5. To change the date, press the  soft key, then edit the displayed date as described in Section 4.10. When you change the last digit, the  soft key changes to the  soft key. Press the  soft key to show the Clock (date) screen again.
6. Press the  soft key twice to display the Menu screen.

 Once set, date and time will remain set until approximately 1 week after the analyser has been disconnected from the electrical supply. If the analyser is left connected to the electrical supply, date and time will remain set indefinitely, even if the analyser is switched off.

5.2.4 Changing regional settings

You can configure the following analyser regional settings so that the information shown on the various screens is better suited to your local conventions:

Setting	Options available
Language	Various languages are supported.
Date format	Day/Month/Year * or Month/Day/Year.
Decimal format	Use of "." (full stop) or "," (comma) as the decimal point.

* Default option.

To change the regional settings:













1. With the Settings screen displayed, use the  and  soft keys to highlight the "Regional" menu option, then press the  soft key. The first Regional settings option screen will then be displayed, as shown in Figure 15.





Figure 15 - The Regional settings (language) option screen

2. This screen shows the first regional option (Language). If necessary, press the  soft key, use the  and  soft keys to highlight the required display language, then press the  soft key.
3. If required, for each of the other two selectable options (date format and decimal format):
 - Use the  and  soft keys to select the corresponding option screen.
 - Press the  soft key.
 - Use the  and  soft keys to highlight the required option, then press the  soft key.

5.2.5 Selecting power save mode

You can select the 'power save' mode of operation, to conserve battery power. When power save mode is selected, the analyser will automatically switch off after 30 minutes has elapsed during which no key has been pressed.

To select/deselect power save mode:

1. With the Settings screen displayed, use the  and  soft keys to highlight the "Power save" menu option, then press the  soft key. The Power save option screen will then be displayed, as shown in Figure 16.

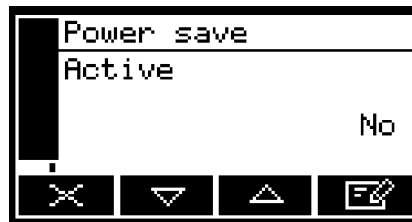





Figure 16 - The Power save option screen

2. "No" or "Yes" on this screen identifies whether power save is selected or not. If necessary, press the  soft key to select the alternative setting, then press the  soft key.



 Power save mode is automatically disabled when the analyser is connected (through the power supply unit) to the electrical supply.

5.2.6 Selecting pump operation (analyser with internal sample pump)

You must select how you want to operate the pump before you start to make sample measurements. The pump can be operated using one of two methods:

Method	Pump operation
Manual	When you press the Pump key on the top of the analyser (see Figure 1), the sample pump will start. You must then press the key again, to stop the pump.
Timed	When you press the Pump key on the top of the analyser (see Figure 1), the sample pump will start, operate for a preset time, and then stop. If you select this mode, you must also specify the time for which the pump should operate.

To select the required method of sample pump operation:

1. With the Settings screen displayed, use the  and  soft keys to highlight the "Set up" menu option, then press the  soft key. The Set up screen will then be displayed, as shown in Figure 17.

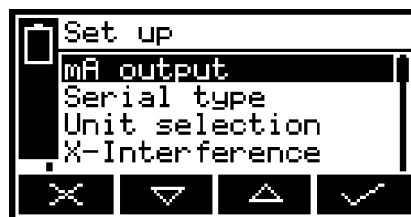

Figure 17 - The Set up screen









2. Use the  and  soft keys to highlight the "Pump" menu option, then press the  soft key. The Pump mode screen will then be displayed, as shown in Figure 18 (which shows manual pump operation selected).



Figure 18 - The Pump mode screen

3. If you want to change the method of sample pump operation, press the  soft key, use the  and  soft keys to highlight the alternative menu option, then press the  soft key.

If you have selected Timed pump operation, you must then continue at Step 4 below to set the pump operation time.

4. With the Pump mode screen displayed (as described above), and with "Timed" operation selected, press the  or  soft key so that the Pump duration screen is displayed, as shown in Figure 19.

This screen shows the currently selected duration (that is, the time for which the pump will operate when you press the Pump key).



Figure 19 - The Pump duration screen

5. If you want to change the duration, press the  soft key then edit the displayed duration as described in Section 4.10.

 Pump duration can be set in the range 1 to 999 seconds.

6 GENERAL OPERATION

CAUTION

Fit the protective cap to the sample gas inlet whenever the analyser is not in use and a sample or calibration gas supply is not connected to the inlet. If you do not, dust or debris may contaminate the restrictor in the inlet and the analyser may not operate correctly, or may be damaged.

6.1 Locating the analyser and switching on



WARNING

Ensure that the tubes that you connect to the analyser are routed so that they do not present a trip hazard to people.



WARNING

Sample and calibration gases may be toxic, asphyxiant or flammable. Before you use the analyser, ensure that the external connections are leak free at full operating pressure, and that the sample and bypass gas outlets (and the calibration 'T' piece outlet, if used) are vented to an area where they will not be a hazard to people. Use the analyser in a well-ventilated environment to prevent the build-up of such gases.

CAUTION

Do not use the analyser in an area subject to high levels of vibration or sudden jolts. If you do, sample measurements may not be accurate, or the analyser may be damaged.

1. Place the analyser in a suitable operating location, where you will calibrate it and sample gases.
2. If necessary (if sample or calibration gases are toxic, asphyxiant or flammable) or if required:
 - Use quick-connect fittings to connect a suitable sized tube to the sample gas outlet on the back of the analyser (see Figure 3).
 - Use quick-connect fittings to connect a suitable sized tube to the bypass gas outlet on the back of the analyser (see Figure 3).
3. If you have fitted tubes to the sample gas outlet and/or bypass gas outlet, route the ends of the tubes so that they can freely vent to atmosphere.
 - ☞ The two outlets can be left to vent to local atmosphere. However if you do fit a tube to one or both of the outlets, the tube(s) must be suitably sized so that the gases can vent from the analyser without over-pressurisation of the analyser or the tubes.

4. If necessary (that is, if the analyser is off), press and hold the Power On/Off key on the top of the analyser for at least 4 seconds to switch the analyser on.







When you switch on the analyser, a 'start-up screen' is first displayed (see Section 4.2), then the Measurement screen (Figure 4) is displayed.

When the Measurement screen is displayed, you can calibrate and use the analyser as described in the following sections.

6.2 Calibrating the analyser

CAUTION

Calibration gases must be as specified in Section 2.3. If your calibration gas pressures and/or flow rates are above those specified in Section 2.3, you must regulate the gases externally, before they enter the analyser

-  Do not calibrate the analyser when it is connected to the power supply unit and the external electrical supply is on. If you do, the analyser will not comply with the EMC Directive (see Appendix A6) and calibration may not be accurate.
-  The pressure of your calibration gas supply must be the same as the pressure of the gases to be sampled. If the pressures are different, sample gas measurements may not be accurate.
-  If you do not allow calibration gas to pass through the analyser for 3 to 5 minutes before you start the calibration procedure, the measurement system in the analyser may not be fully purged of other residual gases, and the calibration may not be accurate.
-  Calibrate the analyser while it is in the same orientation as you will use it for sample measurements. If you do not, sample readings may not be accurate.
-  Do not knock or move the analyser during calibration. If you do, the calibration measurements may be affected.
-  The following calibration procedure assumes that, on an analyser with an internal sample pump, you have selected manual pump operation. If you have selected timed pump operation, you must ensure that the pump operation time is set correctly to allow calibration gas to pass through the analyser for sufficient time: refer to Section 5.2.6 for more information.
-  The calibration procedure in this section is for an analyser without an optional sample conditioning kit. If your analyser has a sample conditioning kit, contact Servomex or your Servomex agent for information on calibration.

You must calibrate the analyser before you first use it to take sample readings (see Section 6.3), and whenever the analyser has been moved to a different environment.

We also recommend that you calibrate the analyser at each power up to avoid measurement errors due to changes in ambient conditions.

Calibrate the analyser as follows:

1. If you have an analyser with an AFCD:
 - Connect your calibration gas supply to the sample gas inlet on the back of the analyser (see Figure 3).
 - Allow the calibration gas to pass through the analyser for 3 to 5 minutes, then continue at Step 3.
2. If you have an analyser with an internal sample pump:
 - Connect the branch on the calibration 'T' piece to the sample gas inlet on the back of the analyser (see Figure 3)
 - Connect a suitable vent pipeline to one end of the calibration 'T' piece; alternatively, if it is safe to do so, leave the end of the 'T' piece open to vent to the local atmosphere.
 - Connect your calibration gas supply to the other end of the 'T' piece.
 - Switch on the sample pump (see Section 5.2.6), allow the calibration gas to pass through the analyser for 3 to 5 minutes, then continue at Step 3.
3. Press the  soft key on the Measurement screen (or select the "Calibrate" option from the Menu screen) to display the Calibrate screen (see Figure 20).

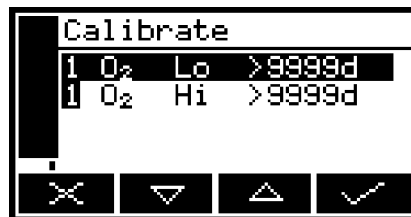





Figure 20 - The Calibrate screen

Note that the "9999d" field of the screen shown in Figure 20 will identify the period of time that has elapsed since the last calibration, and can be in any of the following forms:

- 9999d specifying days
 - 9999h specifying hours
 - 9999m specifying minutes
 - Any combination of the above.
4. Use the  and  soft keys to select the required calibration, that is:
 - 'Lo' (low calibration gas: for example, nitrogen for an oxygen sensor).
 - 'Hi' (high calibration gas: for example, oxygen for an oxygen sensor).

5. Press the  soft key. The Calibrate target value screen will then be shown (see Figure 21), identifying the target value and the current reading.

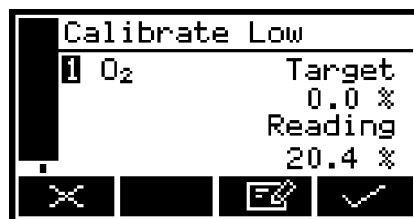







Figure 21 - The Calibrate target value screen

6. If the target value is not that for the calibration gas which you are using, change the target value to the required value: use the edit method in Section 4.10.
-  You cannot change the target value for low calibration of an IR sensor. On the Calibrate target value screen for an IR sensor, Target will be shown as "0.0000" and the  soft key will not be shown.
 -  Refer to Section 2.3 for the required pressures, flow rates (if applicable) and concentrations of the calibration gases.
7. When the current reading is stable, press the  soft key. The analyser will then carry out the specified calibration.
8. If you have an analyser with an internal sample pump, switch the sample pump off (if necessary: see Section 5.2.6).
9. Disconnect the calibration gas supply from the sample gas inlet or the calibration 'T' piece.
10. Repeat Steps 1 to 9 of this section for the second calibration for the specific sample gas.
11. If you have an analyser with an internal sample pump, disconnect your vent pipeline (if fitted) from the calibration 'T' piece, then disconnect the 'T' piece from the sample gas inlet.
12. Press the  soft key to display the Measurement screen again.





6.3 Taking sample readings

CAUTION

Sample gases must be as specified in Section 2.4. If your sample gas pressures and/or flow rates are above those specified in Section 2.4, you must regulate the gases externally, before they enter the analyser.

CAUTION

Sample gases must be dry before use with analyser.

-  Do not take sample readings when the analyser is connected to the power supply unit and the external electrical supply is on. If you do, the analyser will not comply with the EMC Directive (see Appendix A6) and the sample readings may not be accurate.
 -  Take sample readings with the analyser in the same orientation as it was when you calibrated it. If you do not, sample readings may not be accurate.
 -  Depending on how you have configured the measurement alarms, and on how you connect the sample gases to the analyser, a measurement alarm may occur when you change sample gases as described below.
 -  The procedure in this section is for an analyser without an optional gas probe or sample conditioning kit. If your analyser has a gas probe, refer to Appendix A2 for additional information on sampling. If your analyser has a sample conditioning kit, contact Servomex or your Servomex agent for additional information on sampling.
 -  If you are using the analyser to take sample measurements in ambient temperatures of 0 °C (32 °F) or below, we recommend that you switch on and leave the analyser for 5 to 10 minutes before use, and leave it switched on between measurements. This will ensure a higher internal temperature within the analyser and (on an analyser with an internal sample pump) optimise sample pump performance.
1. If necessary, calibrate the analyser: see Section 6.2.
 2. Ensure that the Measurement screen is displayed: see Section 4.
 3. Use the quick-connect fitting supplied to connect the sample gas supply to the sample gas inlet on the back of the analyser (see Figure 3).
 4. If you have an analyser with an internal sample pump, start the sample pump: see Section 5.2.6.
 5. Wait until the measurement shown on the screen has stabilised, then take note of the reading.
 6. If you have an analyser with an internal sample pump and have selected manual pump operation, stop the sample pump: see Section 5.2.6.
 7. Turn off the sample gas supply, or disconnect it from the sample gas inlet on the back of the analyser.

Repeat Steps 3 to 7 as necessary, for different gas samples to be measured.

6.4 Correcting oxygen measurement for different background gases

- ☞ If you are measuring oxygen in a background of nitrogen or air, you do not need to correct the measurements.

6.4.1 Overview of measurement errors (oxygen only)

For an oxygen sensor, the composition of any typical background gas in the gas sample will have a negligible effect on the analyser measurement. For an analyser which has been 'Lo' calibrated with nitrogen and 'Hi' calibrated with oxygen, the cross-interference errors (that is, oxygen measurement errors) in gases which contain 100% of a specific background gas will be as shown below:

Background gas	Error	Background gas	Error
Argon	-0.22%	Krypton	-0.49%
Carbon dioxide	-0.26%	Neon	-0.15%
Halothane	-1.93%	Nitrous oxide	-0.20%
Helium	-0.29%	Xenon	-0.92%





Note that the error is directly proportional to the concentration of the background gas in the sample being measured, and in most cases can be ignored.

If you cannot ignore the error, you can use the procedure in Section 6.4.2 to enter a compensation to correct for the error.

6.4.2 Entering a cross-interference compensation (oxygen only)

- ☞ You can only apply cross-interference compensation to oxygen sample measurements. You must not apply cross-interference compensation to IR gas measurements.
- ☞ Cross-interference compensation is disabled during calibration, and is not applied to the values shown in Figure 21.

Use the following procedure to enter a compensation to correct for an oxygen measurement error:

1. Press the  soft key to display the Menu screen, use the  and  soft keys to highlight the "Set up" menu option, then press the  soft key. The Set up screen will then be displayed (see Figure 17).





- Use the  and  soft keys to highlight the "X-Interference" menu option, then press the  soft key: the X-Interference offset screen is then displayed, as shown in Figure 22.



Figure 22 - The X-Interference offset screen



- The offset value shown on the X-Interference offset screen is the correction which will be applied to oxygen sample measurements before they are displayed.

If you want to change the offset value, press the  soft key, then edit the displayed offset as described in Section 4.10.





6.5 Selecting display units

You can change the measurement units shown on the display. The following display units are supported:

Units	Meaning
%	volume %
ppm	parts per million
vpm	volume parts per million
mg/m ³	mg/m ³ (milligrams per normal cubic metre)
mol/mol	mols per mol (or moles per mole)
% LEL	volume % of the Lower Explosive Limit

-  When you select display units other than the measurement default units, you must also enter the units conversion factor: refer to Appendix A1 to determine the units conversion factor for your specific application.
-  If you select the "off" option on the units selection screen, the display units revert to the measurement default units as supplied.
-  Converting from one measurement unit to a different display measurement unit may reduce the resolution of the displayed measurements.

Use the following procedure to select the displayed units, and to change the units conversion factor:

1. Press the  soft key to display the Menu screen, use the  and  soft keys to highlight the "Set up" menu option, then press the  soft key. The Set up screen will then be displayed (see Figure 17).





2. Use the  and  soft keys to highlight the "Unit selection" menu option, then press the  soft key. The Currently selected units screen will then be displayed, as shown in Figure 23.



Figure 23 - The Currently selected units screen

3. If you want to view or change the units conversion factor, continue at Step 6.

4. If you want to change the currently displayed units, press the  soft key: the Units selection screen will then be displayed, as shown in Figure 24.

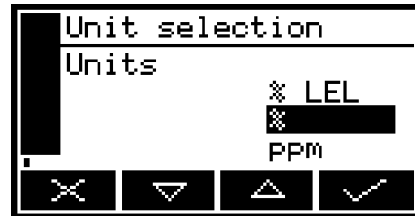





Figure 24 - The Units selection screen

5. Use the  and  soft keys to highlight the required units, then press the  soft key to select the units. The Currently selected units screen will then be displayed again, with the newly selected units shown.

6. With the Currently selected units screen (Figure 23) shown, press the  soft key. The Units conversion factor screen will then be displayed, as shown in Figure 25.

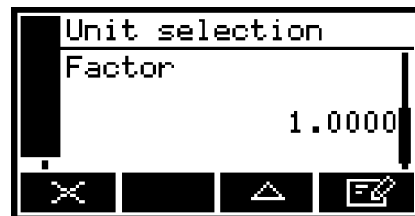



Figure 25 - The Units conversion factor screen

7. If you want to change the units conversion factor, press the  soft key, then edit the displayed offset as described in Section 4.10.

6.6 Configuring the measurement alarms

6.6.1 Alarm modes and levels

Two separate measurement alarms are available, and you can configure each alarm to operate in one of three modes:

Alarm mode	Operation
None	The alarm is not used (that is, an alarm condition will not be activated under any circumstances).
Low alarm	An alarm condition will be activated when a sample measurement is lower than the preset alarm level.
High alarm	An alarm condition will be activated when a sample measurement is higher than the preset alarm level.

While a measurement alarm condition is activated:

- An 'alarm' icon is shown on the measurement screen (see Section 4.2). The number ("1" or "2") in the icon will identify the alarm which has been triggered.
- If the audible measurement alarm is enabled (see Section 6.6.5), the audible alarm goes on.
- The alarm LED on the top of the analyser (see Figure 1) flashes on and off.
- You can view the details of the activated alarm: see Section 6.6.8.

6.6.2 Latching/non-latching alarms

You can configure each of the two measurement alarms to be either latching or not latching:

Alarm setting	Meaning
Latching	Once the alarm condition has been activated, the alarm condition remains activated (even if subsequent sample measurements would not trigger the alarm) until the alarm is manually unlatched: see Section 6.6.7.
Not latching	Once the alarm condition has been activated, the alarm condition remains activated only until a subsequent sample measurement which would not trigger the alarm is made. The alarm condition is then deactivated.

6.6.3 Hysteresis levels

The hysteresis level associated with a measurement alarm determines when an alarm condition (once activated) is deactivated, and this depends on the alarm mode, as follows:

Alarm mode	Effect of hysteresis
Low alarm	Once the low alarm condition has been activated, the alarm condition will not be deactivated until a sample measurement is above (alarm level + hysteresis level).
High alarm	Once the high alarm condition has been activated, the alarm condition will not be deactivated until a sample measurement is below (alarm level - hysteresis level).

For example:

- If a 'low' alarm has an alarm level of 18% and a hysteresis level of 1%, the alarm will be activated when a sample measurement is $< 18\%$, and the alarm will not be deactivated until a sample measurement is $> 19\%$.
- If a 'high' alarm has an alarm level of 20% and a hysteresis level of 2%, the alarm will be activated when a sample measurement is $> 20\%$, and the alarm will not be deactivated until a sample measurement is $< 18\%$.

6.6.4 Setting the measurement alarm levels and modes

- ☞ Ensure that the measurement alarm and hysteresis levels are not too close to the expected sample measurements. (If they are, minor - and acceptable - variations in your sample gas concentrations will result in spurious alarms.)
- ☞ If you configure one measurement alarm as 'low' and configure the other alarm as 'high', ensure that the 'high' alarm and hysteresis levels are higher than the 'low' alarm and hysteresis levels. (If you do not, the analyser can be permanently in an alarm condition, until you correct the levels.)
- ☞ The "Mute" menu option will only be available on the Alarm option screen if the audible alarm has been enabled (see Section 6.6.5).

Before you start to take sample readings, you must ensure that the measurement alarms are correctly configured for your sample gases.









1. On the Measurement screen, press the  soft key. The Alarm option screen will then be displayed, as shown in Figure 26.
2. Highlight the "Set up" menu option, then press the  soft key. The Alarm set up screen will then be displayed, as shown in Figure 27.
3. Use the  and  soft keys to highlight the required alarm, then press the  soft key. The Alarm mode screen will then be displayed, as shown in Figure 28.
4. If the alarm mode is not the required mode, press the  soft key, use the  and  soft keys to select the required mode (none, low or high), then press the  soft key.



Figure 26 - The Alarm option screen

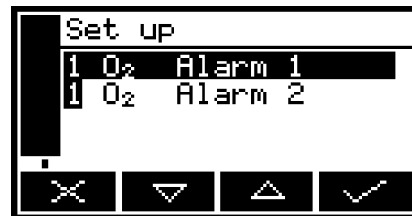



Figure 27 - The Alarm set up screen



Figure 28 - The Alarm mode screen

5. On the Alarm mode screen, use the  and  soft keys to highlight each of the following alarm options, and select the required option (using the method in Step 4 above) or enter the appropriate levels (using the method described in Section 4.10):
 - Latching
 - Level
 - Hysteresis.

6.6.5 Enabling/disabling the audible measurement alarm









-  The audible measurement alarm options are "Yes" (for enable) and "No" (for disable).
1. With the Alarms option screen displayed (see Section 6.6.4), use the  and  soft keys to highlight the "Audible alarm" option, then press the  soft key.
 2. If the displayed alarm setting is not the required setting, press the  soft key. The Audible alarm option screen will then be displayed: see Figure 29.





Figure 29 - The Audible alarm option screen

3. Use the  and  soft keys to select the required option ("Yes" or "No"), then press the  soft key.

6.6.6 Silencing (muting) the audible measurement alarm

-  The audible alarm will only go on when a measurement is made which triggers a measurement alarm condition **and** the audible measurement alarm has been enabled (see Section 6.6.5).

When the audible alarm is on because of a measurement alarm condition, you can temporarily silence (mute) the audible alarm, as follows:



1. On the Measurement screen, press the  soft key; the Alarm option screen (Figure 26) will then be displayed.
2. With the "Mute" option highlighted, press the  soft key. The audible alarm will then go off and the Measurement screen will be displayed again.

-  Once silenced, the audible alarm will go on again:
- If a new measurement alarm condition is activated.
 - If the measurement alarm condition which caused the audible alarm to go on is deactivated and is then re-activated.



You will then need to silence the audible measurement alarm again.

6.6.7 Unlatching measurement alarms

When necessary, use the following procedure to unlatch any 'latched' measurement alarm(s) (see Section 6.6.2):

1. On the Measurement screen, press the  soft key; the Alarm option screen (Figure 26) will then be displayed.
2. With the "Unlatch" option highlighted, press the  soft key. All latched alarms will then be unlatched and the Measurement screen will be displayed again.

6.6.8 Viewing the measurement alarm status

1. On the Measurement screen, press the  soft key; the Alarm option screen (see Figure 26) will then be displayed.
2. With the "View" option highlighted, press the  soft key. The Alarm status screen will then be displayed (see Figure 30).

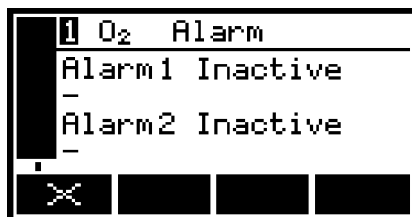

Figure 30 - The Alarm status screen

In the Alarm status screen shown in Figure 30, both measurement alarms are shown as "Inactive"; that is, either the mode of each alarm is set to 'none', or no alarm condition currently exists.

If a measurement alarm condition exists when you view this screen, the screen will show:

- The alarm number ("1" or "2").
- The alarm level.
- The alarm mode (where "<" indicates a low alarm and ">" indicates a high alarm).
- The sample reading which triggered the alarm condition.

6.7 Data logging

6.7.1 Introduction

The analyser allows you to maintain a data log of sample measurements made, within the analyser memory. The data log consists of one or more 'batches' of measurements, and a total of 200 measurements can be stored.

Each sample measurement entered in the log has:

- an associated batch number
- a sequence number of the sample measurement within the batch
- the date and time that the measurement was made
- an alarm indication (if the measurement caused a measurement alarm to be raised)
- a fault indication (if a fault existed at the time of the measurement).

You must manually transfer measurements into the data log, specify when a new batch is to start within the data log, and clear the data log when necessary.

At any time, you can view the currently stored data log on the analyser display.

- ☞ The analyser cannot be configured to automatically log data over specified periods of time.

6.7.2 Entering measurement data into the data log

When you want to enter the sample measurement(s) from the Measurement screen into the data log:

1. Press the  soft key. When you press the soft key, the current sample measurement at the time of the key press is 'captured' (stored in internal memory), and the Data logging screen will then be displayed (see Figure 31).

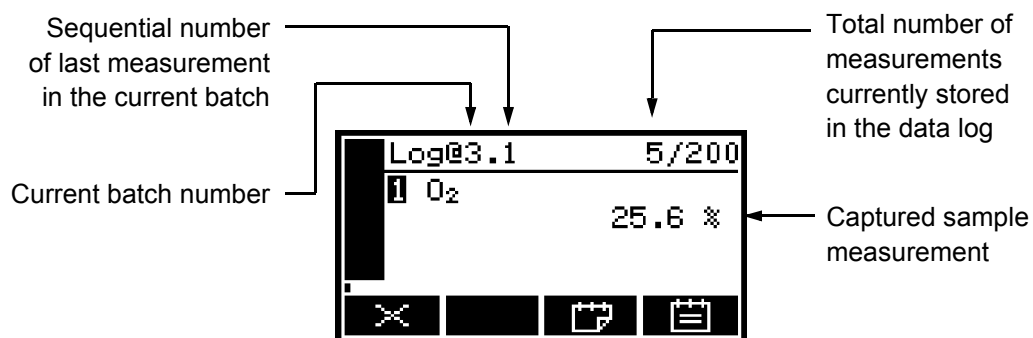



Figure 31 - The Data logging screen

- To store the measurement data in the data log, press the  soft key.





A Log taken screen (Figure 32) is then displayed for a few seconds to verify that the measurement data has been stored in the data log, then the Measurement screen is shown again.





Figure 32 - The Log taken screen

- To return to the Measurement screen without storing the captured sample measurement data in the data log, press the  soft key when the data logging screen is displayed.

6.7.3 Starting a new data log batch

- Once you have started a new data log batch, you cannot add sample measurements to a previous batch.
- With the Measurement screen displayed, press the  soft key. The Data logging screen will then be displayed (see Figure 31).
 - Press the  soft key. A new batch will then be started within the data log (and the batch sequence number of the next measurement will be reset to "1").
- No new measurement data is entered into the data log when you press the  soft key. To enter data into the new batch, you must press the  soft key again, or use the procedure given in Section 6.7.2.

6.7.4 Viewing the data log

- With the Menu screen displayed, use the  and  soft keys to highlight the "Data log" option, then press the  soft key. The Data log options screen will then be displayed, as shown in Figure 33.

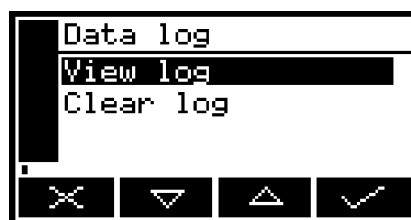









Figure 33 - The data log options screen

2. Use the  and  soft keys to highlight the "View log" option, then press the  soft key. The View log (batch) screen is then displayed, alternating with the View log (date) screen: see Figures 34 and 35.
3. Use the  and  soft keys to scroll through all of the measurements stored in the data log.
4. When you have finished viewing the data log, press the  soft key or the  soft key to display the Data log options screen again.

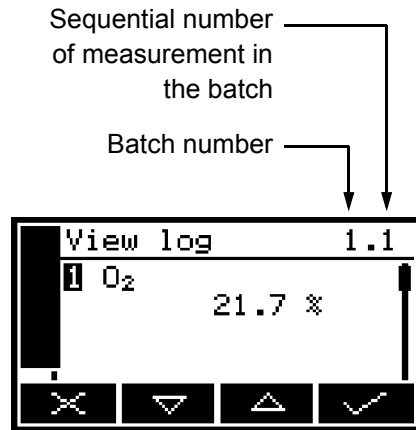

Figure 34 - The View log (batch) screen

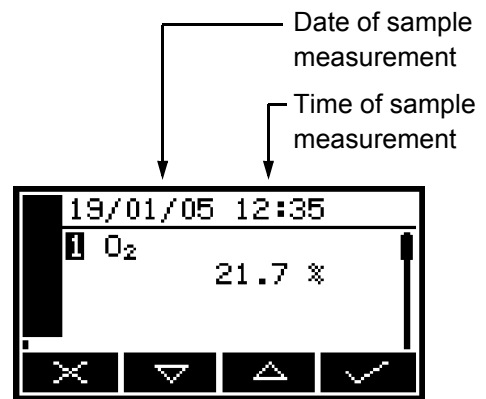











Figure 35 - The View log (date) screen

6.7.5 Clearing the data log

-  Ensure that you have viewed the data log (see Section 6.7.4) before you clear the log.
 -  You cannot clear batches or individual measurements from the data log.
1. With the Menu screen displayed, use the  and  soft keys to highlight the "Data log" option, then press the  soft key. The Data log options screen will then be displayed, as shown in Figure 33.
 2. Use the  and  soft keys to highlight the "Clear log" option, then press the  soft key. The screen will then show an "Are you sure?" message:
 - Press the  soft key to clear the data log. The Data log options screen is then displayed again.
 - Press the  soft key to display the Data log options screen again without clearing the data log.

6.8 Adjusting the display

At any time, you can adjust the screen display to suit the ambient light conditions, as described in Sections 6.8.1 and 6.8.2.

6.8.1 Adjusting the backlight timer

When the analyser is first switched on, the backlight goes on to illuminate the screen. If no soft key is pressed, the backlight will remain on for the preset 'backlight time', and will then go off. The timer associated with the backlight time is restarted whenever a soft key is pressed (that is, the backlight remains on for the backlight time after the last soft key press). To adjust the backlight time:



1. On the Settings screen, highlight the "Backlight" option, then press the  soft key. The Backlight timer screen will then be displayed, as shown in Figure 36.
2. Change the backlight time (Duration) setting as required, then press the  soft key.



Figure 36 - The Backlight timer screen

-  The backlight time (Duration) can be set between 0 and 999 seconds. Set the backlight time (Duration) to 0 seconds to leave the backlight permanently switched on.

6.8.2 Adjusting the contrast







1. On the Settings screen, highlight the "Contrast" option, then press the  soft key. The Contrast screen will then be displayed, as shown in Figure 37.
2. Use the  and  soft keys to increase or decrease the contrast to the required level, then press the  soft key.





Figure 37 - The Contrast screen



-  Hold the  or  soft key pressed in to adjust the contrast quickly.

6.9 Switching off the analyser after use

When you have finished using the analyser:

1. Switch off the analyser: press and hold the Power On/Off key for approximately 2 seconds, then release the key when the audible alarm goes on.
 2. If you will not use the analyser for several days:
 - Disconnect any tubes from the sample gas outlet and from the bypass gas outlet on the back of the analyser (see Figure 3).
 - Fit protective plastic caps to the sample gas outlet, to the bypass gas outlet and to the sample gas inlet on the back of the analyser (see Figure 3).
 3. If necessary, disconnect the analyser from the electrical supply.
-  If you have been using the analyser powered by the battery, we recommend that you fully recharge the battery (refer to Section 5.1.2) before you next use the analyser for sample measurements.
-  If required, you can leave the analyser connected to the electrical supply. This will not affect the service life of the battery.

7 ROUTINE MAINTENANCE



	<p style="text-align: center;">WARNING</p> <p>Do not attempt to carry out any maintenance operations other than those specified in this manual. If you do, you can damage the analyser.</p>
	<p style="text-align: center;">WARNING</p> <p>Sample and calibration gases may be toxic or asphyxiant, and hazardous concentrations may accumulate within the analyser during use:</p> <ul style="list-style-type: none">• Always inspect the inlet filter or remove the rechargeable battery cover in a force-ventilated enclosure (with a minimum volume of 1 m³) or another appropriate safe environment in which any hazardous gases are directed away from you.• Never inspect the inlet filter or remove the rechargeable battery cover while such gases are still connected.• Ensure that the analyser is serviced or repaired in a force-ventilated enclosure or another appropriate safe environment (see above), with such gases disconnected.

7.1 Cleaning the analyser

Regularly do the following, to prevent the entry of dust or other particulates into the gas sample inlet or the interior of the analyser.

1. Use a suitable soft-bristle brush to wipe away any dust or deposits from the breather vent on the bottom of the analyser (See Figure 2).
2. Use a damp (but not wet) cloth to wipe clean the outer surfaces of the analyser.

7.2 Inspecting the inlet filter element

-  The filter element is made of borosilicate glass, and the filter retainer cap 'O' ring is made from Viton[®] (fluoroelastomer).
-  New filter elements and filter retainer cap 'O' rings are available as spares: see Section 10.

If you only use the analyser on applications which use clean, dry cylinder gases, you will only need to inspect the inlet filter element every 3 months. On other applications, we recommend that you inspect the inlet filter element more frequently.

1. Ensure that the analyser is switched off.
2. Unscrew and remove the filter retainer cap (see Figure 2).
3. Inspect the condition of the white filter element (fitted to the spigot on the rear of the filter retainer cap). If the filter element is wet or dirty:
 - Remove the used filter element from the filter retainer cap, then dispose of the element.
 - Push a new filter element onto the spigot on the inner side of the filter retainer cap.
4. Inspect the 'O' ring on the inner side of the filter retainer cap. If the 'O' ring is twisted or damaged:
 - Remove the 'O' ring, then dispose of it.
 - Fit a new 'O' ring to the inner side the filter retainer cap.
5. Ensure that the 'O' ring is correctly located in the recess in the inner side of the filter retainer cap, then refit and tighten the filter retainer cap.

CAUTION

Do not operate the analyser with the filter element removed. If you do, particulates in the sample gas will seriously damage the analyser.

7.3 Use of the analyser for carbon monoxide or carbon dioxide measurements

	<p style="text-align: center;">WARNING</p> <p>If the analyser is specified for use with carbon monoxide or carbon dioxide, the concentrations of the gases sampled or used for calibration of the analyser may be above their respective threshold limit values, and should thus be considered to be toxic. You must therefore regularly leak test the analyser and any associated equipment.</p>
---	--

	<p style="text-align: center;">WARNING</p> <p>If any leaks are found during leak testing, do not use the analyser or associated equipment until the leaks have been sealed.</p>
---	--

<p>CAUTION</p> <p>When you carry out a leak test, do not exceed a maximum pressure of 34.5 kPa gauge (0.35 bar gauge, 5 psi gauge) and do not introduce a sudden change of pressure into the analyser. If you do, you can damage it.</p>
--

If you use the analyser for carbon monoxide or carbon dioxide sample measurements, you must regularly leak-test the analyser and the associated sample/vent lines or system.

We recommend that you leak-test the analyser at least once every 6 months. We recommend that you pressurise the analyser and sample/vent lines to 500 mm (water), and that you then check for a pressure fall rate of less than 2 mm (water) per minute.

If the pressure fall rate exceeds 2 mm (water) per minute, determine the location of the leak. Note that:

- If there are leaks within the analyser, it must be returned to Servomex for repair. Do not continue to use the analyser.
- You must seal any leaks in your sample/vent lines or system.

When you leak-test, ensure that you do not exceed the maximum pressure, and do not increase the pressure in the analyser too quickly (see the caution above): we recommend that you allow at least 30 seconds to fully pressurise the analyser to the maximum pressure.

7.4 Replacing the rechargeable battery pack

Replace the rechargeable battery pack when advised to do so by Servomex or your Servomex agent.

The rechargeable battery pack is available as a spare (see Section 10). Instructions for replacement of the pack are supplied with the spare.

7.5 Preventative maintenance

- ☞ If you send the analyser to Servomex or your local Servomex agent for preventative maintenance, the analyser must be accompanied by a correctly completed decontamination certificate.

To minimise unscheduled analyser downtime, to ensure the proper operation of the analyser, and to comply with the guidelines of applicable regulatory bodies, we recommend that you utilise the Servomex annual preventative maintenance program for your analyser.

The preventative maintenance program consists of a yearly inspection of the analyser at a Servomex service facility, and repair of any faults, to ensure that the analyser meets its original factory specification. Once inspection and repair are complete, the analyser is returned, together with a dated service certificate.

Note that:

- Loan analysers are available for your use while your analyser is undergoing preventative maintenance.
- You will always be informed in advance if any repairs or new parts are required for your analyser.

Contact Servomex or your local Servomex agent to arrange for a preventative maintenance contract.

8 FAULT FINDING

8.1 Introduction to faults and fault messages

When the analyser internal self-test facilities detect a fault:

- The audible alarm emits a single short tone.
- The amber fault LED (see Figure 1) goes on.
- A fault icon is shown on the measurement screen (see Figure 4).
- An appropriate fault message is stored.

You can view the current faults as described in Section 8.2. The fault messages which can be shown - together with the recommended actions you should take - are listed (in alphabetical order) in the table below:

Fault message	Recommended actions
Battery fault	Disconnect the power supply unit plug from the electrical supply outlet, wait 30 seconds, then reconnect the plug to the electrical supply outlet. If the fault persists, contact Servomex or your local Servomex agent for assistance.
Calibration fault	Recalibrate (both low and high) as described in Section 6.2. If the fault persists, contact Servomex or your local Servomex agent for assistance.
Charging Timeout	Check that the ambient temperature is in the correct range for recharging (see Section 2.2), and try to recharge the battery again. If the fault persists, contact Servomex or your local Servomex agent for assistance.
Code fault	Contact Servomex or your local Servomex agent for assistance.
Communication fail	Turn the analyser off, and then turn it on again. If the fault message is then displayed again, contact Servomex or your local Servomex agent for assistance.
Database fault	Contact Servomex or your local Servomex agent for assistance.

Fault messages (Sheet 1 of 3)



Fault message	Recommended actions
Date/Time invalid	<p>This usually occurs because an analyser has been left disconnected from the electrical supply for more than a week, and the rechargeable battery is empty (fully discharged).</p> <p>Recharge the battery as described in Section 5.1.2, then set the date/time as described in Section 5.2.3. If the fault persists, contact Servomex or your local Servomex agent for assistance.</p>
Fatal fault	<p>Contact Servomex or your local Servomex agent for assistance.</p>
Power Config fault	<p>Contact Servomex or your local Servomex agent for assistance.</p>
Pump fault	<p>(This fault message will only be shown on an analyser with an internal sample pump.)</p> <p>Check that the sample gas inlet, the sample gas outlet and the bypass gas outlet (see Figure 3) are not blocked or obstructed, and that any pipes or tubes connected to the inlet and outlets are not blocked or obstructed.</p> <p>After checking the inlet, outlets and pipes/tubes, restart the sample pump (see Section 5.2.6). If the fault persists, contact Servomex or your local Servomex agent for assistance.</p>
Static RAM fault	<p>Turn the analyser off, and then turn it on again. If the fault message is then displayed again, contact Servomex or your local Servomex agent for assistance.</p>
Transducer error	<p>Ensure that you are using the analyser in the specified operating conditions (refer to Section 2). If the fault persists, contact Servomex or your local Servomex agent for assistance.</p>
Tx incorrect type	<p>Contact Servomex or your local Servomex agent for assistance.</p>

Fault messages (Sheet 2 of 3)

Fault message	Recommended actions
Tx Maintenance	<p>Check that the sample gas concentration is not higher than the transducer Full Scale Range.</p> <p>Recalibrate (both low and high) as described in Section 6.2. If this does not clear the fault, turn the analyser off, and then turn it on again. If the fault message is then displayed again, contact Servomex or your local Servomex agent for assistance.</p>
Tx not detected	Contact Servomex or your local Servomex agent for assistance.

Fault messages (Sheet 3 of 3)

8.2 Viewing fault messages

If you want to view details of faults currently detected by the analyser, use the  and  soft keys to highlight the "Faults" option on the Menu screen, then press the  soft key. The Fault status screen will then be displayed as shown in Figure 38.

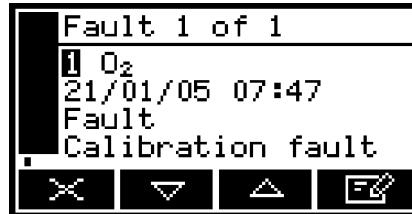



Figure 38 - The Fault status screen

If there is more than one currently detected fault, this will be indicated by the screen heading and by the scroll bar at the right of the screen. If required you can use the  and  soft keys to scroll through and view all of the current faults.

Each fault status screen shows:

- Date and time of fault
- Fault indicator
- Fault message.

Refer to Section 8.1 for the recommended actions associated with the displayed fault messages.

8.3 General fault finding

For general analyser fault finding, refer to the table on the following pages.

If you have read through the table and still cannot rectify a fault, or cannot identify the cause of a fault, contact Servomex or your local Servomex agent for assistance.

Fault symptom	Recommended actions
The Fault LED is on.	<p>Check any current fault messages (see Section 8.2), and carry out the recommended actions (see Section 8.1).</p> <p>If there are no applicable fault messages stored, or if you cannot rectify the fault after you have carried out the recommended actions:</p> <ul style="list-style-type: none"> • Switch off the analyser, then switch it on again. • If the fault persists, contact Servomex or your local Servomex agent for assistance.
The software health indicator is not moving on the display.	Carry out the recommended actions for the "The Fault LED is on" symptom above.
" - - - - " is displayed instead of a sample measurement (or appears in the data log).	<p>This indicates a possible measurement error, or a communications error between a transducer and the analyser controller.</p> <p>Check that the analyser is not being knocked, moved, or subjected to high levels of vibration during sample measurements.</p> <p>If the analyser is not being knocked, moved or subjected to vibration and the fault persists, contact Servomex or your local Servomex agent for assistance.</p>
" ↑↑↑↑↑↑ " is displayed instead of a sample measurement (or appears in the data log).	<p>This indicates that the sample gas measurement is above the analyser's upper measurement limit</p> <p>If this is displayed or appears during calibration, check that the calibration gas is as specified in Section 2.3 and recalibrate the analyser.</p> <p>If this is displayed or appears during sample measurement, check that the sample gas target range is within the specification of the analyser (see Section 2.4).</p>

General fault finding (Sheet 1 of 4)

Fault symptom	Recommended actions
<p>" ↓↓↓↓↓↓↓↓ " is displayed instead of a sample measurement (or appears in the data log).</p>	<p>This indicates that the sample gas measurement is below the analyser's lower measurement limit</p> <p>If this is displayed or appears during calibration, check that the calibration gas is as specified in Section 2.3 and recalibrate the analyser.</p> <p>If this is displayed or appears during sample measurement, check that the sample gas target range is within the specification of the analyser (see Section 2.4).</p>
<p>Analyser response is slow.</p>	<p>Check that the sample gas inlet is not blocked, and that the sample gas supply to the analyser is not restricted.</p> <p>Check that the sample gas outlet and bypass gas outlet are not blocked, and that any tubes or pipes connected to the outlets are not restricted.</p> <p>Check that you are using the analyser in the specified operating conditions: refer to Section 2.2. (If you use an analyser with an internal sample pump in ambient temperatures of 0 °C (32 °F) or below, the sample pump will take a few minutes to operate correctly and response time will increase.)</p> <p>Inspect the inlet filter element and replace it if necessary: refer to Section 7.2.</p> <p>Check that the sample gas supply pressure is correct: refer to Section 2.4.</p>
<p>Analyser measurements are not as expected.</p>	<p>Check that the correct display units have been selected, and that the units conversion factor has been correctly entered (see Section 6.5).</p> <p>Check that any cross-interference offsets that you have entered are correct (see Section 6.4.2).</p>

General fault finding (Sheet 2 of 4)

Fault symptom	Recommended actions
Analyser measurements are unstable.	<p>Check that the sample gas supply pressure is correct: refer to Section 2.4.</p> <p>Check that the analyser is not being subjected to high levels of vibration.</p> <p>Check that the sample gas inlet is not blocked, and that the sample gas supply to the analyser is not restricted.</p> <p>Check that the sample gas outlet and bypass gas outlet are not blocked, and that any tubes or pipes connected to the outlets are not restricted.</p> <p>Inspect the filter element and replace it if necessary: refer to Section 7.2.</p>
The analyser will not calibrate.	<p>Check that the correct low and high calibration gases are being used: refer to Section 2.3.</p> <p>Check that the sample gas inlet is not blocked, and that the sample gas supply to the analyser is not restricted.</p> <p>Check that the sample gas outlet and bypass gas outlet are not blocked. Check that the calibration 'T' piece is not blocked. Check that any tubes or pipes connected to the outlets (or to the calibration 'T' piece) are not restricted.</p> <p>Inspect the filter element and replace it if necessary: refer to Section 7.2.</p>

General fault finding (Sheet 3 of 4)

Fault symptom	Recommended actions
The analyser will not switch on when it is connected to the power supply unit.	<p>If the green light on the power supply unit is on:</p> <ul style="list-style-type: none"> • Check that the power supply is correctly connected to the analyser: see Section 5.1.1. • If the power supply is already correctly connected to the analyser, contact Servomex or your local Servomex agent for assistance. <p>If the green light on the power supply unit is off:</p> <ul style="list-style-type: none"> • Check that the power supply unit is correctly connected to your electrical supply outlet, and that your external electrical supply is correct: see Section 2.1. • Check the fuse in the power supply unit plug. If the fuse has failed, replace it with a new fuse of the correct rating. • If the power supply unit is correctly connected to your electrical supply outlet and your external electrical supply is correct, the power supply unit may have failed: contact Servomex or your local Servomex agent for assistance.
The analyser will not switch on when it is disconnected from the power supply unit.	The battery may be flat (fully discharged): connect the power supply unit and recharge the battery (refer to Section 5.1.2).
The analyser display is blank or is too dark.	<p>Check that the ambient temperature is within the valid analyser operating temperature range: refer to Section 2.2.</p> <p>Check that the display contrast adjustment has been correctly set (refer to Section 6.8.2), and has not been altered.</p>
The measurement alarms are activating more often than expected.	<p>Check that the analyser is not being knocked, moved, or subjected to high levels of vibration during sample measurements.</p> <p>Check that the alarm modes, alarm levels and hysteresis levels have been correctly set: refer to Section 6.6.4.</p>

General fault finding (Sheet 4 of 4)

9 STORAGE AND DISPOSAL

9.1 Storage



Refit any protective plastic covers (see Section 3) and place the analyser and any associated equipment in its original packaging before storage. Alternatively, seal it inside a waterproof plastic bag, sack, or storage box.

Store the analyser and any associated equipment in a clean, dry area. Do not subject it to excessively hot, cold, or humid conditions: see Section 2.2.

-  If the analyser is to be stored for a long time, recharge the battery every 2 months (see Section 5.1.2) to optimise the service life of the battery.

9.2 Disposal

Dispose of the analyser, the power supply unit and any other associated equipment safely, and in accordance with all of your local and national safety and environmental requirements.

-  The analyser is not suitable for disposal in municipal waste streams (such as landfill sites, domestic recycling centres and so on). Refer to Appendix A5 for disposal requirements in accordance with the WEEE Directive within the EC.
-  If you send the analyser to Servomex or your local Servomex agent for disposal, the analyser must be accompanied by a correctly completed decontamination certificate.

10 SPARES

CAUTION

Do not use spares other than those specified below, and do not attempt to replace the internal sample pump (if fitted) yourself. If you do, you can damage the analyser.

The standard spares available for the analyser are shown below. You can order these spares from Servomex or your agent.

Spare	Part Number
Inlet filter element (pack of 5)	00570982
Filter retainer cap 'O' ring	2323-7029
Inlet/outlet quick-connect fitting	202517
Power supply unit	202578
Rechargeable battery pack kit	05100931 *
Carry case (black)	05110341
Carry case strap (black)	05110342



We recommend that you maintain a stock of inlet filter elements and a filter retainer cap 'O' ring, so you can replace them when necessary: see Section 7.2.

* Kit includes battery pack part no. 05000931

APPENDIX

A1 DISPLAY UNIT CONVERSION FACTORS

When you select display units as described in Section 6.5, you must ensure that you also enter the correct units conversion factor, as shown in the table below:

To convert from *	to †	use the units conversion factor	applicable gas(es)
%	ppm	10000	any
ppm	%	0.0001	any
ppm	vpm	1	any
ppm	mg/m ³	1.2492	CO
"	"	1.9631	CO ₂
"	"	1.4277	O ₂
%	mg/m ³	12492	CO
"	"	19631	CO ₂
"	"	14277	O ₂
ppm	%LEL	0.0008	CO
%	%LEL	8	CO
%	mol/mol	0.01	any
ppm	mol/mol	#	#

* Measurement default units.

† Selected display units.

This conversion is not supported.



To return to the measurement default units, select the "off" units selection option and set the units conversion factor to "1": see Section 6.5.

APPENDIX

A2 OPTIONAL GAS PROBE ACCESSORY

A2.1 Overview

The gas probe accessory enables you to accurately pinpoint where gases will be sampled.

Refer to Figure A1. The accessory consists of the removable protective tip (1, only supplied with the 25 cm Probe accessory), the probe (2) and handle (3), an optional filter (4), and a coiled sample pipe (5) which is terminated by an outlet connector (6).

A2.2 Preparing for use

If the gas probe is not already assembled, simply push-fit the components together as shown in Figure A1.

A2.3 Using the probe

-  If your probe has a protective tip, remove the tip if the temperature of the location where you will sample gases exceeds 180 °C/356 °F.

Refer to Figure A1. When you want to use the gas probe accessory during gas sampling:

1. Fit the outlet connector (6) to one of the following:
 - The sample gas inlet on the analyser (see Figure 3)
 - The sample gas inlet on the sample conditioning kit, using the catchpot inlet adaptor (7).
2. Place the end of the probe (1) where you want to sample gases.

A2.4 Additional maintenance

If your gas probe accessory has an optional filter:

- When necessary, replace the filter element, available as a spare: see Section A2.5.
- When necessary (for example, if it is damaged), replace the filter assembly, available as a spare: see Section A2.5.

A2.5 Additional spares

CAUTION
Do not use spares other than those specified below. If you do, you can damage the analyser.

The following additional spares are available for the gas probe accessory:

Spare	Part Number
Filter assembly	203148
Filter element (pack of 5)	00570982
Probe: 25 cm (approx 10 inch), with protective tip	S5000942
Probe: 100 cm (approx 39 inch)	S5000404B

Order these spares from Servomex or your Servomex agent.

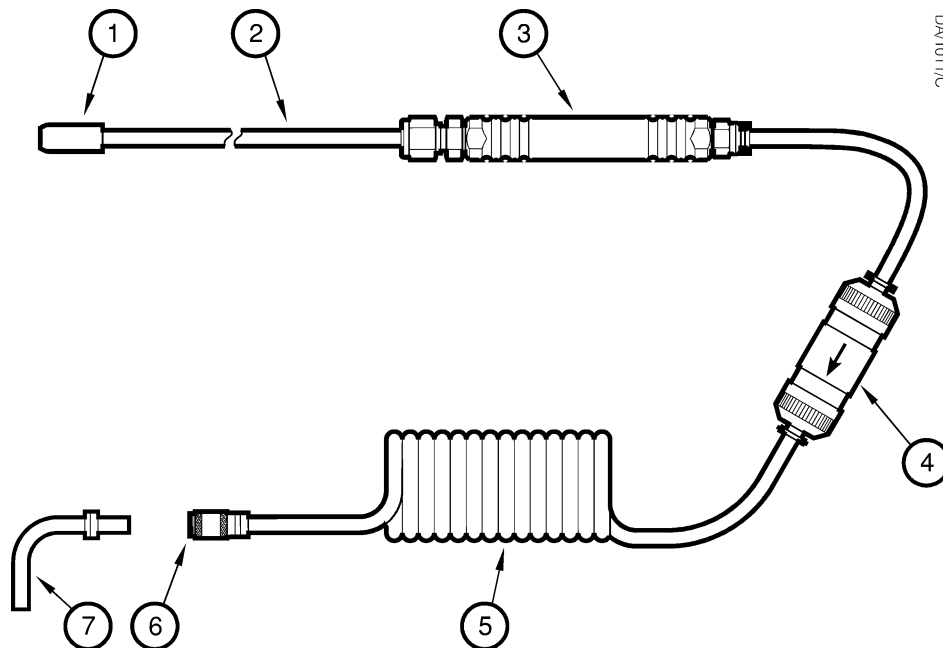

Key	Description	Key	Description
1.	Protective tip *	5.	Coiled sample pipe
2.	Probe	6.	Outlet connector
3.	Handle	7.	Catchpot inlet adaptor #
4.	Filter †		

* Removable: only supplied fitted to the 25 cm Probe.

† Optional.

Only supplied if you also have the sample conditioning kit.

Figure A1 - Optional gas probe assembly

APPENDIX

A3 OPTIONAL SAMPLE CONDITIONING KIT

CAUTION

If you have an analyser with a sample conditioning kit, always store, carry and use the analyser in the orientation shown in Figure A2 (that is, upright, with the display and controls at the top). If you turn the analyser over or tilt it too far, liquid in the catchpot may leak into the analyser gas pipes (and/or into your sample/calibration gas pipe, if connected).

A3.1 Overview

The optional sample conditioning kit allows for use of the analyser to measure wet gas samples.

Refer to Figure A2. If you order this option, the analyser is supplied in a carry case (4) with pockets which contain the catchpot and drier, and gas pipes which direct the sample/calibration gases through the sample conditioning kit to the analyser.

During sampling, sample gas passes through the catchpot (3), and then the drier (5, which contains a drying agent), before passing into the analyser.

You must drain the catchpot when necessary (see Section A3.4.1) and you must regularly regenerate or replace the drying agent (see Section A3.4.2).

A3.2 Specification

Response time *	
Industrial oxygen sensor	60 seconds
High accuracy oxygen sensor	65 seconds
IR (infrared) sensor	130 seconds
Sample gas temperature †	Ambient temperature ± 10 °C (18 °F)
Sample gas inlet #	Suitable for 4 mm inside diameter tube
Drying agent	Indicating silica gel

* The response times are approximate and are those necessary to reach 90% of final measurement, with indicating silica gel as the drying agent. If required, you can use calcium sulphate as the drying agent (see Section A3.4.2), to reduce response time to approximately 50 seconds.

† For maximum operating life and efficiency.

On the sample conditioning kit (Figure A2, item 2).

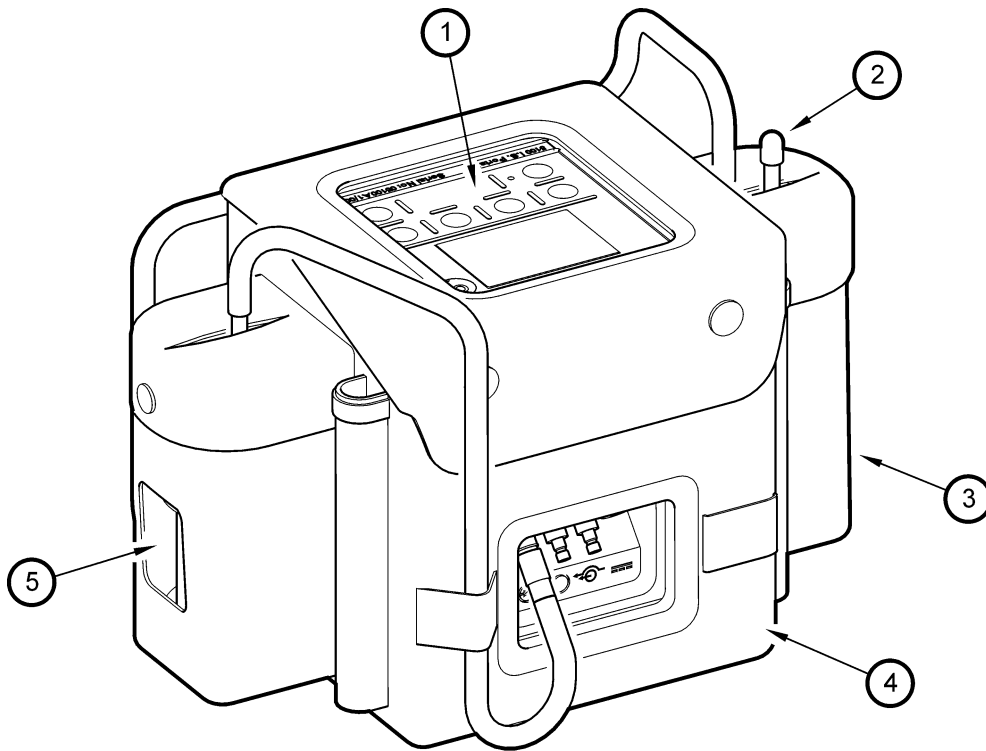

DA1107/A

Key	Description	Key	Description
1.	Analyser top panel	4.	Carry case
2.	Sample gas inlet *	5.	Drier (inside carry case)
3.	Catchpot (inside carry case)		

* Shown with blanking cap fitted.



Figure A2 - Analyser with the sample conditioning kit

A3.3 Using the analyser with the sample conditioning kit

A3.3.1 Calibrating

You must calibrate the analyser with the sample conditioning kit as described in Section 6.2, but you must connect the calibration gas supply to the sample gas inlet on the sample conditioning kit (Figure A3, item 4).

A3.3.2 Sampling gases

-  If the sample gases are very dirty (that is, contain soot or particulates), we recommend that you use the catchpot as a bubbler when you carry out sample measurements; that is: remove the top of the catchpot and fill the catchpot with clean water to a level just above the bottom of the gas inlet pipe in the catchpot.
-  Ensure that the gas pipe connections are correct. If the catchpot-to-drier pipe is incorrectly fitted to the catchpot inlet instead of the outlet, liquid can be drawn into the analyser.

Refer to the schematic of the connections shown in Figure A3. When you want to sample gases:

1. Ensure that:
 - The catchpot-to-drier pipe (2) is connected between the catchpot outlet (3) and the drier inlet (11): see the  note above.
 - The drier outlet pipe (9) is connected between the drier outlet (1) and the sample gas inlet (8) on the back of the analyser.
2. Take sample readings as described in Section 6.3, but note that:
 - You must connect a gas sample pipe/probe to the sample gas inlet (4) on the sample conditioning kit.
 - Route the end of the sample pipe/probe to a suitable sample point.
 - Allow sufficient time for the sample measurement to stabilise (see Section A3.2).

A3.4 Additional maintenance

A3.4.1 Draining the catchpot

-  A window in the carry case pocket allows you to see the catchpot. Do not allow the level of liquid in the catchpot to rise above the top of the transparent body of the catchpot.



Refer to Figure A3. During use, liquid entrained in the sampled gases will be condensed in the catchpot (5). When necessary (that is, when liquid is visible in the transparent body of the catchpot):

1. Disconnect the catchpot-to-drier gas pipe (2) from the catchpot outlet (3), then undo the press stud, lift up the pocket cover and remove the catchpot from the carry case pocket.
2. Place a suitable container under the catchpot drain plug (6, on the base of the catchpot).
3. Remove the drain plug and allow the liquid to drain from the catchpot.
4. Refit the drain plug and safely dispose of the drained liquid: refer to Section 9.2.
5. Refit the catchpot in the carry case pocket and secure the pocket cover with the press stud, then reconnect the catchpot-to-drier gas pipe (2) to the catchpot outlet (3).

-  Ensure that the gas pipe connections are correct. If the catchpot-to-drier pipe is incorrectly fitted to the catchpot inlet instead of the outlet, liquid can be drawn into the analyser.

A3.4.2 Replacing/regenerating the drying agent

	<p style="text-align: center;">WARNING</p> <p>If you replace the drying agent, ensure that you comply with any safe handling and usage requirements specified on or with the package containing the new drying agent.</p>
---	--

-  A window in the carry case pocket allows you to see the drier, and the silica gel drying agent in the drier.
-  If required, replace the silica gel drying agent supplied with calcium sulphate (for example, use Drierite[®]), to reduce the response time: see Section A3.2.

The colour of the silica gel drying agent in the drier is orange as supplied, and the column of drying agent will turn progressively green as moisture is absorbed. When the whole column of drying agent has turned green, the drying agent needs to be regenerated or replaced.

(Continued on page 73)

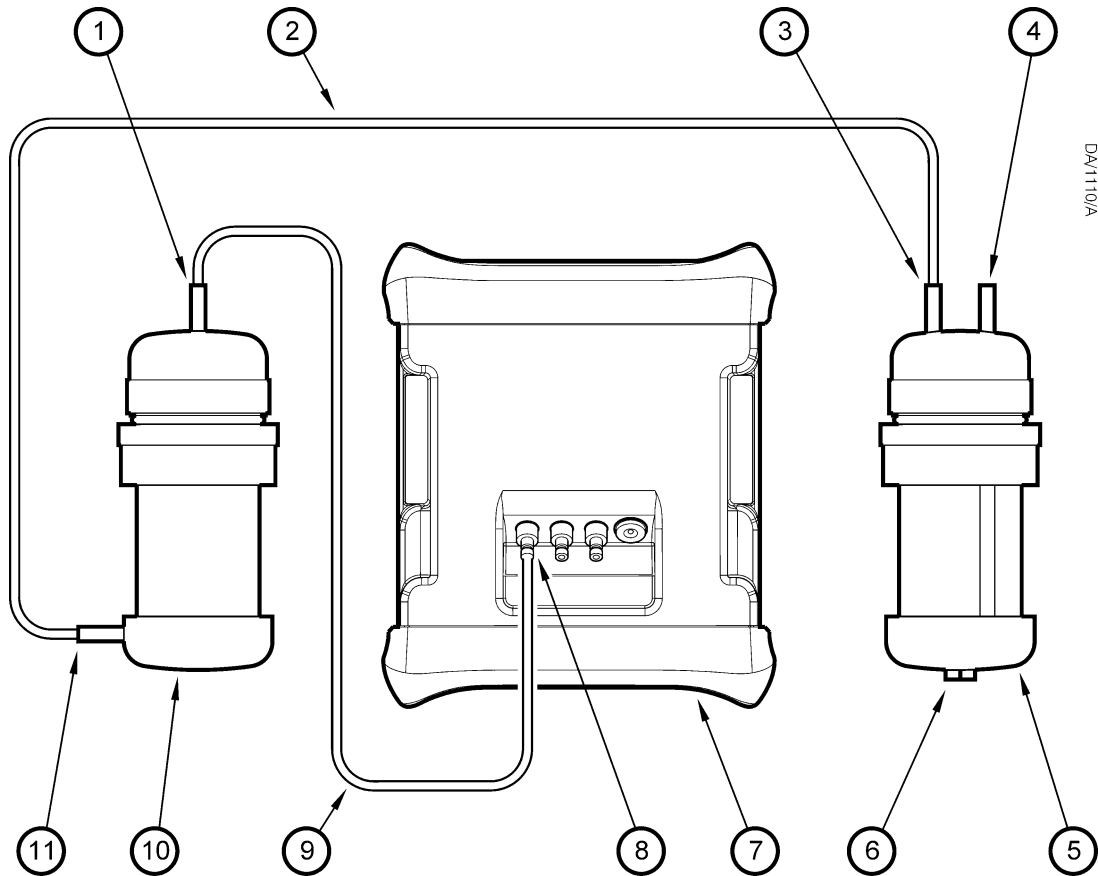

Key	Description
1.	Drier outlet
2.	Catchpot-to-drier gas pipe
3.	Catchpot outlet *
4.	Sample gas inlet *
5.	Catchpot
6.	Catchpot drain plug

Key	Description
7.	Analyser
8.	Analyser sample gas inlet
9.	Drier outlet pipe
10.	Drier
11.	Drier inlet

* The sample gas inlet on the catchpot has a tube which extends to the bottom of the body of the catchpot. The catchpot outlet does not have such a tube.

Figure A3 - Schematic of sample conditioning kit connections

You can regenerate the drying agent in one of two ways: by heating, or by passing dry gas through it.

To regenerate the drying agent by heating:

1. Refer to Figure A3. Disconnect the catchpot-to drier gas pipe (2) from the drier inlet (11), and disconnect the drier outlet pipe (9) from the drier outlet (1).
2. Undo the press stud and lift up the pocket cover, then remove the drier from the carry case pocket.
3. Unscrew the end-cap and remove the drying agent from the drier.
4. Heat the drying agent in a suitable oven at a temperature of 110 to 120 °C (230 to 248 °F) for 1 hour.
5. Place the drying agent back in the drier and refit the end-cap.
6. Refit the drier back in the carry case pocket and secure the pocket cover with the press stud.
7. Reconnect the catchpot-to-drier gas pipe (2) to the drier inlet (11), and reconnect the drier outlet pipe (9) to the drier outlet (1).

 Ensure that you correctly reconnect the gas pipes. If the gas pipes are incorrectly connected, liquid can be drawn into the analyser.

To regenerate the drying agent using dry gas:

1. Refer to Figure A3. Disconnect the catchpot-to drier gas pipe (2) from the drier inlet (11), and disconnect the drier outlet pipe (9) from the drier outlet (1).
2. Pass dry air or dry nitrogen through the drier, until the drying agent has been regenerated (see below).
3. Reconnect the catchpot-to-drier gas pipe (2) to the drier inlet (11), and reconnect the drier outlet pipe (9) to the drier outlet (1).

 Ensure that you correctly reconnect the gas pipes. If the gas pipes are incorrectly connected, liquid can be drawn into the analyser.

The drying agent will turn orange again when it has been successfully regenerated. More than 100 regenerations can be made before the drying agent becomes ineffective.

When necessary, dispose of the drying agent and replace with new drying agent, available as a spare (see Section A3.5).

A3.5 Additional spares

CAUTION

Do not use spares other than those specified below. If you do, you can damage the analyser.

The following additional spares are available for the sample conditioning kit:

Spare	Part Number
Drying agent (indicator silica gel)	203742
Drier assembly	S5000944
Catchpot assembly	S0214905
Catchpot and drier lids	S5000943
Carry case (black, with pockets)	05110343

Order these spares from Servomex or your Servomex agent.

APPENDIX

A4 MATERIALS IN CONTACT WITH SAMPLE AND CALIBRATION GASES

The materials of the parts of the analyser in contact with the sample and calibration gases are listed below. These materials have a wide range of chemical compatibility and corrosion resistance.

Common gas path in the analyser:

- Nickel
- Viton[®]
- PPS (polyphenylene sulphide) with carbon fibre filler
- PPS (polyphenylene sulphide)
- Borosilicate glass
- Kynar[®] (PVDF: polyvinylidene disulphide)
- Polysulphone

Oxygen sensor:

- 316 stainless steel
- Borosilicate glass
- Platinum
- Platinum/iridium alloy
- Electroless nickel
- Viton[®]

IR (infrared) sensor:

- 316 stainless steel
- Gold
- Nickel
- Sapphire
- Epoxy adhesive (EPO-TEK H72)
- Viton[®]

Optional Gas Probe:

- 316 stainless steel
- Nickel
- Viton[®]
- Polyurethane
- Nylon
- Borosilicate glass
- PVC (polyvinylchloride)

Optional Sample Conditioning Kit:

Perspex
PVC (polyvinylchloride)
Nitrile
316 stainless steel
Fluorocarbon elastomer (FPM)
Silica
Fibreglass
Viton®
Nickel

APPENDIX

A5 DISPOSAL IN ACCORDANCE WITH THE WASTE ELECTRICAL AND ELECTRONIC EQUIPMENT (WEEE) DIRECTIVE

The label shown in Figure A4 is fitted to the analyser.

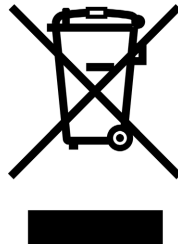

Figure A4 - The WEEE label

This label identifies that:

- The analyser is considered to be within the scope of the Waste Electrical and Electronic Equipment (WEEE) Directive 2002/96/EC.
- The analyser is not intended for disposal in a municipal waste stream, but shall be submitted for material recovery and recycling in accordance with the local regulations which implement the WEEE Directive.

For additional information and advice on the disposal of the analyser in accordance with the requirements of the WEEE Directive, contact Servomex or your local Servomex agent.

- 👉 If you send the analyser to Servomex or your local Servomex agent for disposal, the analyser must be accompanied by a correctly completed decontamination certificate.

APPENDIX

A6 COMPLIANCE AND STANDARDS INFORMATION

- The analyser complies with the European Community "Electromagnetic Compatibility Directive", 89/336/EEC (as amended by 92/31/EEC and 93/68/EEC).
- The analyser has been assessed to IEC 61010-1:2001 (+Corr 1: 2002 + Corr 2:2003) for electrical safety, assuming IEC 60664-3 Category II, Pollution Degree 2.
- The analyser has been validated and fully complies with the requirements of The Food and Drug Act - specifically, 21 CFR 211.165 (e) and 211.194 (a)(2) - for verification of the strength, identity and purity of: MEDICAL OXYGEN (USP) and OXYGEN IN NITROGEN NF 19.
- The power supply unit supplied with the analyser complies with the European Community "Low Voltage Directive", 73/23/EEC (as amended by 93/68/EEC), and is appropriately CE marked and approved for use in the EU. The power supply unit has been assessed in accordance with surge test requirements appropriate to domestic environments. This page intentionally blank.
- Servomex Group Ltd is a BS EN ISO 9001 and BS EN ISO 14001 certified organisation.
- The analyser has been FM approved as industrial instrumentation for use in non-hazardous (Unclassified) indoor (IP65) locations in USA and Canada.