

# Rosemount™ Wireless Pressure Gauge

with *WirelessHART*® Protocol



The Rosemount Wireless Pressure Gauge from Emerson™ utilizes industry-proven Rosemount pressure sensor technology to deliver accurate, reliable pressure information. It features up to 150x overpressure protection and two layers of process isolation providing a safer field environment. Rosemount sensor technology eliminates many gauge challenges by replacing mechanical parts that inhibit traditional gauges from reporting or displaying the correct pressure. The Rosemount Wireless Pressure Gauge features a large 4.5-in. (114 mm) face for easy field visibility. It has up to a 10-year installed life, reducing costs and time involved with maintenance.

# Product Benefits

## Reduce maintenance challenges

- Get up to 10 years of reliable readings through industry-proven Rosemount pressure sensor technology
- Reduce common mechanical gauge failures caused by vibration, overpressure and other environmental factors
- Have confidence in pressure gauge health with local indicator light

## Improve personnel safety

- Keep people out of hazardous areas by minimizing operator rounds
- Gain peace of mind with overpressure ratings from 1.5x to 150x and two layers of process isolation

## Access pressure data continuously

- Get accurate readings as frequently as once per minute with *WirelessHART* technology
- View pressure reading locally with large 4.5-in. (114 mm) dial

### Contents

Ordering Information .....	3	Product Certifications .....	13
Specifications .....	10	Dimensional Drawings .....	15

## Ordering Information

**Table 1. Rosemount Wireless Pressure Gauge Ordering Information**

The starred offerings (★) represent the most common options and should be selected for best delivery. The non-starred offerings are subject to additional delivery lead time.

Model	Device type		
WPG	Wireless Pressure Gauge		★
<b>Dial size</b>			
45	4.5-in. (114.3 mm)		★
<b>Gauge output</b>			
X	Wireless with user-configurable update rate, 2.4 GHz DSSS, <i>WirelessHART</i>		★
<b>Product certifications</b>			
I1	ATEX Intrinsic Safety		★
I2	INMETRO Intrinsic Safety		★
I4	TIIS Intrinsic Safety		★
I5	US Intrinsically Safe		★
I6	Canada Intrinsically Safe		★
I7	IECEX Intrinsic Safety		★
IM	Technical Regulations Customs Union (EAC) Intrinsic Safety		★
NA	No approval		★
<b>Measurement type</b>			
G	Gage		★
A	Absolute		★
C	Compound		★
V	Vacuum		★
<b>Process connection style<sup>(1)</sup></b>			
	<b>Connection style</b>	<b>Isolating diaphragm material</b>	★
11	1/2-14 NPT male	316L SST	★
12	1/2-14 NPT male	Alloy C-276	★
21	G1/2 male (EN 837)	316L SST	★
22	G1/2 male (EN 837)	Alloy C-276	★
01	Alternate process connection	316 SST	★
02	Alternate process connection	Alloy C-276	★
<b>Primary engineering unit</b>			
A	psi		★
B	kiloPascals (kPa)		★

**Table 1. Rosemount Wireless Pressure Gauge Ordering Information**

The starred offerings (★) represent the most common options and should be selected for best delivery. The non-starred offerings are subject to additional delivery lead time.

D	bar	★
E	mBar	★
F	MegaPascals (MPa)	★
G	inH <sub>2</sub> O	★
H	kg/cm <sup>2</sup>	★
I	ftH <sub>2</sub> O	
J	mmH <sub>2</sub> O	
K	inHg	★
L	cmH <sub>2</sub> O	★
M	cmHg	★
N	mmHg	★
P <sup>(2)(3)</sup>	Percent of range (% of range)	★
<b>Scale ranges</b>		
Reference tables in <a href="#">Pressure scale ranges</a> section for scale ranges by engineering unit.		★

**Options (include with selected model number)**

<b>Secondary engineering unit (dual scale)</b>		
DA <sup>(4)</sup>	psi	★
DB <sup>(4)</sup>	kiloPascals (kPa)	★
DD <sup>(4)</sup>	bar	★
DH <sup>(4)</sup>	kg/cm <sup>2</sup>	★
DC <sup>(2)(3)(5)(6)</sup>	Custom units	
<b>Manifolds assemblies<sup>(7)(8)(9)</sup></b>		
S5	Assemble to Rosemount 306 Integral Manifold	
<b>Diaphragm seal assembly<sup>(8)(9)(10)</sup></b>		
S1	Assemble to one Rosemount 1199 Diaphragm Seal	
<b>Extended product warranty</b>		
WR3	3-year limited warranty	★
WR5	5-year limited warranty	★
<b>Mounting bracket</b>		
B4	Bracket for 2-in. pipe or panel mounting, all SST	★

**Table 1. Rosemount Wireless Pressure Gauge Ordering Information**

The starred offerings (★) represent the most common options and should be selected for best delivery. The non-starred offerings are subject to additional delivery lead time.

<b>Custom configuration</b>		
C1	Custom configuration	★
<b>Calibration certification</b>		
Q4	Calibration certificate	★
<b>Material traceability certification</b>		
Q8	Material traceability certification per EN 10204 3.1	★
<b>NACE certificate</b>		
Q15	Certificate of compliance to NACE® MR0175/ISO 15156 for wetted materials	★
Q25	Certificate of compliance to NACE MR0103 for wetted materials	★
<b>Pressure testing</b>		
P1	Hydrostatic testing with certificate	★
<b>Surface finish<sup>(11)</sup></b>		
Q16	Surface finish certificate for Sanitary Remote Seals	★
<b>Normal range indication</b>		
LK	Green, yellow and red sticker kit	★
<b>Alternate process connection<sup>(12)</sup></b>		
P01	Level flange (SST), 1-in. ANSI Class 150	
P02	Level flange (SST), 1-in. ANSI Class 300	
P11	Level flange (SST), 2-in. ANSI Class 150	
P12	Level flange (SST), 2-in. ANSI Class 300	
P21	Level flange (SST), 3-in. ANSI Class 150	
P22	Level flange (SST), 3-in. ANSI Class 300	
P31	Level flange (SST), DIN-DN 50 PN 40	
P41	Level flange (SST), DIN-DN 80 PN 40	
W01	Level flange (SST), 1-in. ANSI Class 150, All welded construction	
W02	Level flange (SST), 1-in. ANSI Class 300, All welded construction	
W11	Level flange (SST), 2-in. ANSI Class 150, All welded construction	
W12	Level flange (SST), 2-in. ANSI Class 300, All welded construction	
W21	Level flange (SST), 3-in. ANSI Class 150, All welded construction	
W22	Level flange (SST), 3-in. ANSI Class 300, All welded construction	
W31	Level flange (SST), DIN-DN 50 PN 40, All welded construction	
W41	Level flange (SST), DIN-DN 80 PN 40, All welded construction	

1. Materials of Construction comply with recommendations per NACE MR0175/ISO 15156 for sour oil field production environments. Environmental limits apply to certain materials. Consult latest standard for details. Selected materials also conform to NACE MR0103 for sour refining environments.
2. Not available with Measurement Type Compound.
3. Not available with Measurement Type Vacuum.
4. Not available with Primary Engineering Unit "P" (Percent of Range).
5. Requires Primary Engineering Unit of "A" (psi) or "D" (bar).
6. Requires Custom Configuration model code "C1".
7. Requires Process Connection Style "11" or "12".
8. Integrated manifold and diaphragm seal assemblies cannot be combined.
9. "Assemble-to" items are specified separately and require a completed model number.
10. Requires Process Connection 11.
11. Requires diaphragm seal assembly "S1"
12. Requires process connection style "01" or "02"

**Figure 1. Model Number Ordering Example**

Model	Dial size	Gauge output	Product certification	Measurement type	Process connection style	Primary engineering unit	Scale range	Options
WPG	45	X	11	A	11	A	6-digit numeric value	DA, S1...
Factory defined			End-user defined					

## Pressure scale ranges

Additional scale ranges available. Contact Emerson for additional information.

Psi		
Code	Vacuum -psi to 0	
000000	-15/0	
	Gage/absolute 0 to psi	Compound <sup>(1)</sup> -30 inHg to 0 to psi
000005	5	5
000010	10	10
000015	15	15
000020	20	20
000030	30	30
000050	50	50
000060	60	60
000075	75	75
000100	100	100
000150	150	150
000160	160	160
000200	200	200
000300	300	300
000400	400	N/A
000500	500	N/A
000600	600	N/A
000800	800	N/A
001000	1000	N/A
001500	1500	N/A
002000	2000	N/A
003000	3000	N/A
004000	4000	N/A

1. Vacuum scale will be in inHg and positive pressure in psi. Only applies to psi.

Bar-kg/cm <sup>2</sup>		
Code	Vacuum -bar to 0 or -kg/cm <sup>2</sup> to 0	
000000	-1/0	
	Gage/absolute 0 to bar or 0 to kg/cm <sup>2</sup>	Compound -1 bar to 0 to bar or -1 kg/cm <sup>2</sup> to 0 to kg/cm <sup>2</sup>
000000D40	0.4	0.4
000000D60	0.6	0.6
000001	1	1
000001D50	1.5	1.5
000001D60	1.6	1.6
000002	2	2
000002D50	2.5	2.5
000003	3	3
000004	4	4
000005	5	5
000006	6	6
000009	9	9
000010	10	10
000015	15	15
000016	16	16
000020	20	20
000024	24	N/A
000025	25	N/A
000040	40	N/A
000050	50	N/A
000060	60	N/A
000070	70	N/A
000100	100	N/A
000160	160	N/A
000250	250	N/A

kiloPascals (kPa)		
Code	Vacuum -kPa to 0	
000000	-100/0	
	Gage/absolute 0 to kPa	Compound -100 kPa to 0 to kPa
000040	40	40
000060	60	60
000100	100	100
000150	150	150
000160	160	160
000200	200	200
000250	250	250
000300	300	300
000400	400	400
000500	500	500
000600	600	600
000900	900	900
001000	1000	1000
001500	1500	1500
001600	1600	1600
002000	2000	2000
002400	2400	N/A
002500	2500	N/A
004000	4000	N/A
005000	5000	N/A
006000	6000	N/A
010000	10000	N/A
025000	25000	N/A

mbar		
Code	Vacuum -mbar to 0	
000000	-1000/0	
	Gage/absolute 0 to mbar	Compound -1000 mbar to 0 to mbar
000400	400	400
000600	600	600
001000	1000	1000
001500	1500	1500
002000	2000	2000
003000	3000	3000
004000	4000	4000
005000	5000	5000
006000	6000	6000
009000	9000	9000
MegaPascals (MPa)		
Code	Vacuum -MPa to 0	
000000	-0.1/0	
	Gage/absolute 0 to MPa	Compound -0.1 MPa to 0 to MPa
000000D20	0.2	0.2
000000D50	0.5	0.5
000001	1	1
000001D50	1.5	1.5
000002	2	2
000002D50	2.5	N/A
inH <sub>2</sub> O		
Code	Vacuum -inH <sub>2</sub> O to 0	
000000	-400/0	
	Gage/absolute 0 to inH <sub>2</sub> O	Compound -400 inH <sub>2</sub> O to 0 to inH <sub>2</sub> O
000200	200	200
000300	300	300
000800	800	800



ftH <sub>2</sub> O		
Code	Vacuum -ftH <sub>2</sub> O to 0	
000000	-30/0	
	Gage/absolute 0 to ftH <sub>2</sub> O	Compound -30 ftH <sub>2</sub> O to 0 to ftH <sub>2</sub> O
000035	35	35
000060	60	60
000070	70	70
000100	100	100
000140	140	140
000240	240	240
000400	400	400
000500	500	500
000700	700	700
000900	900	N/A
mmH <sub>2</sub> O		
Code	Vacuum -mmH <sub>2</sub> O to 0	
000000	-10000/0	
	Gage/absolute 0 to mmH <sub>2</sub> O	Compound -10000 mmH <sub>2</sub> O to 0 to mmH <sub>2</sub> O
007500	7500	7500
040000	40000	40000
200000	200000	200000
inHg		
Code	Vacuum -inHg to 0	
000000	-30/0	
	Gage/absolute 0 to inHg	Compound -30 inHg to 0 to inHg
000012	12	12
000015	15	15
000016	16	16
000020	20	20
000030	30	30
000060	60	60
000300	300	300

cmH <sub>2</sub> O		
Code	Vacuum -cmH <sub>2</sub> O to 0	
000000	-1000/0	
	Gage/absolute 0 to cmH <sub>2</sub> O	Compound -1000 cmH <sub>2</sub> O to 0 to cmH <sub>2</sub> O
000500	500	500
000900	900	900
cmHg		
Code	Vacuum -cmHg to 0	
000000	-75/0	
	Gage/absolute 0 to cmHg	Compound -75 cmHg to 0 to cmHg
000150	150	150
000750	750	750
004000	4000	N/A
020000	20000	N/A
mmHg		
Code	Vacuum -mmHg to 0	
000000	-750/0	
	Gage/absolute 0 to mmHg	Compound -750 mmHg to 0 to mmHg
001500	1500	1500
007500	7500	7500
040000	40000	N/A
200000	200000	N/A
Percent of range <sup>(1)</sup>		
Code	Gage/absolute	
000030	30	
000150	150	
000800	800	
004000	4000	

1. Scale will read 0-100 percent. Code selected is representative of the desired working pressure range in psi.

# Specifications

## Physical specifications

### Material selection

Emerson provides a variety of Rosemount products with various product options and configurations including materials of construction that can be expected to perform well in a wide range of applications. The Rosemount product information presented is intended as a guide for the purchaser to make an appropriate selection for the application. It is the purchaser's sole responsibility to make a careful analysis of all process parameters (such as all chemical components, temperature, pressure, flow rate, abrasives, contaminants, etc.), when specifying product materials, options, and components for the particular application. Emerson is not in a position to evaluate or guarantee the compatibility of the process fluid or other process parameters with the product options, configuration, or materials of construction selected.

### Dial size

4.5-in. (114.3 millimeter)

### Scale ranges

From vacuum up to 4,000 psi (275 bar)

### Single scale considerations

The number of major graduations is a direct result of the specified combination of primary engineering unit and scale range.

### Dual scale considerations

The number of major graduations on the inner scale is the direct result of the combination of primary engineering unit and secondary engineering unit.

### Process connections

1/2-14 NPT male, G1/2 male (EN 837) and alternate process connections

### Field Communicator connections

Communication terminals are accessible by removing cover.

### Material of construction

#### Housing

Engineered Polymer, NEMA® 4X and IP66/67

#### Cover O-ring

Silicone rubber

#### Process-wetted parts

316L SST, Alloy C-276

## Shipping weight

1.8 lb (0.82 kg)

### Options

#### Mounting bracket (Code B4)

1.0 lb (0.5 kg)

#### Normal Range Indication (Code LK)

0.02 lb (11 g)

#### Rosemount 1199 Seal Systems

Reference the Rosemount DP Level [Product Data Sheet](#) for shipping weights.

#### Rosemount 306 Integrated Manifolds

Reference the Rosemount Manifolds [Product Data Sheet](#) for shipping weights.

## Operating specifications

### Conformance to specification ( $\pm 3\sigma$ [Sigma])

Technology leadership, advanced manufacturing techniques, and statistical process control ensure specification conformance to at least  $\pm 3\sigma$ .

### Accuracy

ASME B40.1 – Grade 2A (0.5% of span)

### Temperature limits

#### Ambient

–40 to 185 °F (–40 to 85 °C)

#### Storage

–40 to 185 °F (–40 to 85 °C)

#### Process

–40 to 250 °F (–40 to 121 °C)<sup>(1)(2)</sup>

### Options

#### Normal Range Indication (Code LK)

Ambient: –40 to 185 °F (–40 to 85 °C)

Storage: 70 °F (21 °C)

Application: Minimum of 50 °F (10 °C)

1. Process temperatures above 185 °F (85 °C) require de-rating the ambient limits by a 1.5:1 ratio.
2. 220 °F (104 °C) limit in vacuum service; 130 °F (54 °C) for pressures below 0.5 psia.

**Electrical connections/battery**

Replaceable, non-rechargeable, 3.6 V primary cell, lithium-thionyl chloride battery  
 10 year battery life at reference conditions<sup>(1)</sup>

**Overpressure limit**

Scale range	Maximum working pressure	Maximum overpressure limit
5 – 30 psi (0.35 – 2 bar)	30 psi (2 bar)	750 psi (51.7 bar)
31 – 150 psi (2.1 – 10.3 bar)	150 psi (10.3 bar)	1,500 psi (103.4 bar)
151 – 800 psi (10.4 – 55.1 bar)	800 psi (55.1 bar)	1,600 psi (110.3 bar)
801 – 4,000 psi (55.2 – 275 bar)	4,000 psi (275 bar)	6,000 psi (413.7 bar)

**Burst pressure limit**

11,000 psi (758 bar)

**Minimum span limits for percent of range engineering unit**

The maximum rangedown is 10:1. The device maintains reference accuracy specification up to 6:1 rangedown. After 6:1 rangedown the reference accuracy decreases to 1% of span.

Scale range	Span (6:1 ratio)	Minimum span (10:1 ratio)
5 – 30 psi (0.35 – 2 bar)	5 psi (0.34 bar)	3 psi (0.21 bar)
31 – 150 psi (2.1 – 10.3 bar)	25 psi (1.72 bar)	15 psi (1.03 bar)
151 – 800 psi (10.4 – 55.1 bar)	134 psi (9.24 bar)	80 psi (5.51 bar)
801 – 4,000 psi (55.2 – 275 bar)	667 psi (45.99 bar)	400 psi (27.5 bar)

**Ambient temperature effect per 18 °F (10 °C)**

Scale range	Ambient temperature effect
<b>Wireless pressure gauge</b>	
Up to 4,000 psi (275 bar)	±0.3 of span
<b>Wireless pressure gauge with remote seal</b>	
Up to 4,000 psi (275 bar)	See Instrument Toolkit™ software.

1. Reference conditions are 70 °F (21 °C), Stable operating pressure with periodic changes, transmit rate of once per minute, and routing data for three additional network devices.

**Digital zero trim**

An offset adjustment to compensate for mounting position effects, up to 5 percent of Span

**Humidity limits**

0-95% relative humidity

**Electromagnetic compatibility (EMC)**

Meets all industrial environment requirements of EN61326. Maximum deviation < 1 percent span during EMC disturbance.

**Status indication**

Device status is indicated by local LED. Reference the Rosemount Wireless Pressure Gauge [Quick Start Guide](#) for further detail.

**Output**

IEC 62591 (WirelessHART), 2.4 GHz DSSS

**Wireless radio (internal antenna)**

- Frequency: 2.400 – 2.480 GHz
- Channels: 15
- Modulation: IEEE 802.15.4 compliant DSSS
- Transmission: Maximum of 10 dBm EIRP
- Integrated omni-directional antenna

**Wireless update rate**

Wireless update rate is user-selectable from one minute to 60 minutes and is separate from local display. When wireless is activated, the update rate defaults to once a minute.

**Vibration effect**

No significant effect when tested per IEC60770-1 or ASME B40.1 requirements

IEC60770-1 high vibration level - field or pipeline: 10–60 Hz 0.21 mm displacement peak amplitude/60–2000 Hz 3 g

Table 2. Wireless Connectivity Out of the Box

Products in order	Network ID and Join Key are generated	Wireless connectivity out of the box
Rosemount Wireless Pressure Gauge	Automatically	Manual activation required
Rosemount Wireless Pressure Gauge	Customer specified	Activated
Rosemount Wireless Pressure Gauge and Emerson Wireless Gateway	Automatically (matching)	Manual activation required

# Product Certifications

Rev: 2.0

## European Union Directive Information

A copy of the EU Declaration of Conformity can be found at the end of the Quick Start Guide. The most recent revision of the EU Declaration of Conformity can be found at [Emerson.com/Rosemount](http://Emerson.com/Rosemount).

## Telecommunication compliance

All wireless devices require certification to ensure that they adhere to regulations regarding the use of the RF spectrum. Nearly every country requires this type of product certification. Emerson is working with governmental agencies around the world to supply fully compliant products and remove the risk of violating country directives or laws governing wireless device usage.

## FCC and IC (WPG Only)

This device complies with Part 15 of the FCC Rules. Operation is subject to the following conditions: This devices may not cause harmful interference, this devices must accept any interference received, including interference that may cause undesired operation. This device must be installed to ensure a minimum antenna separation distance of 20 cm from all persons. This device complies with Industry Canada license-exempt RSS-247. Operation is subject to the following two conditions: (1) this device may not cause interference, and (2) this device must accept any interference, including interference that may cause undesired operation of the device.

Changes or modification to the equipment not expressly approved by Emerson could void the user's authority to operate the equipment.

Cet appareil est conforme à la Partie 15 de la réglementation FCC. Son fonctionnement est soumis aux conditions suivantes: Cet appareil ne doit pas causer d'interférences nuisibles. Cet appareil doit accepter toute interférence reçue, incluant toute interférence pouvant causer un fonctionnement indésirable. Cet appareil doit être installé pour assurer une distance minimum de l'antenne de séparation de 20 cm de toute personne. Cet appareil est conforme à la norme RSS-247 Industrie Canada exempt de licence. Son fonctionnement est soumis aux deux conditions suivantes: (1) cet appareil ne doit pas provoquer d'interférences et (2) cet appareil doit accepter toute interférence, y compris les interférences pouvant causer un mauvais fonctionnement du dispositif. Les changements ou les modifications apportés à l'équipement qui n'est pas expressément approuvé par Rosemount Inc pourraient annuler l'autorité de l'utilisateur à utiliser cet équipement.

## Ordinary location certification from CSA

The product has been examined and tested to determine that the design meets the basic electrical, mechanical, and fire protection requirements by CSA, a nationally recognized test laboratory (NRTL) as accredited by the Federal Occupational Safety and Health Administration (OSHA).

## Installing in North America

The US National Electrical Code (NEC) and the Canadian Electrical Code (CEC) permit the use of Division marked equipment in Zones and Zone marked equipment in Divisions. The markings must be suitable for the area classification, gas, and temperature class. This information is clearly defined in the respective codes.

### USA

- I5** U.S.A. Intrinsically Safe (IS)  
 Certificate: [CSA] 70047656  
 Standards: FM 3600 – 2011, FM 3610 – 2010, UL Standard 50 – Eleventh Edition, UL 61010-1 – 3rd Edition, ANSI/ISA-60079-0 (12.00.01) – 2013, ANSI/ISA-60079-11 (12.02.01) – 2013, ANSI/IEC 60529 – 2004  
 Markings: IS CL I, DIV 1, GP A, B, C, D T4; Class 1, Zone 0, AEx ia IIC T4 Ga; T4 (-40 °C ≤ T<sub>a</sub> ≤ +70 °C) when installed per Rosemount drawing 00G45-1020; Type 4X; IP66/67

### Special Conditions for Safe Use (X):

1. Do not replace battery when explosive atmosphere is present.
2. Use only 00G45-9000-0001 batteries.
3. The surface resistivity of the housing is greater than 1GΩ. To avoid electrostatic charge build-up, it must not be rubbed or cleaned with solvents or a dry cloth.
4. Substitution of components may impair intrinsic safety.

### Canada

- I6** Canada Intrinsically Safe (IS)  
 Certificate: [CSA] 70047656  
 Standards: CAN/CSA C22.2 No. 0-10, CAN/CSA C22.2 No. 94-M1991 (R2011), CAN/CSA-60079-0-11, CAN/CSA-60079-11-14, CSA Std C22.2 No. 60529-05, CAN/CSA-C22.2 No. 61010-1-12  
 Markings: Intrinsically Safe for Class I, Division 1, Groups A, B, C, D T4; Ex ia IIC T4 Ga T4 (-40 °C ≤ T<sub>a</sub> ≤ +70 °C) when installed per Rosemount drawing 00G45-1020; Type 4X; IP66/67

**Special Conditions for Safe Use (X):**

1. Do not replace battery when explosive atmosphere is present.  
Ne pas remplacer les accumulateurs si une atmosphère explosive peut être présente.
2. Use only 00G45-9000-0001 batteries.  
Utiliser uniquement des accumulateurs 00G45-9000-0001.
3. The surface resistivity of the housing is greater than 1 GΩ. To avoid electrostatic charge build-up, it must not be rubbed or cleaned with solvents or a dry cloth.  
La résistivité de surface du boîtier est supérieure à un gigaohm. Pour éviter l'accumulation de charge électrostatique, ne pas frotter ou nettoyer avec des produits solvants ou un chiffon sec.
4. Substitution of components may impair intrinsic safety.  
La substitution de composants peut compromettre la sécurité intrinsèque.

**Europe**

- I1** ATEX Intrinsic Safety  
Certificate: Baseefa16ATEX0005X  
Standards: EN 60079-0: 2012 + A11: 2013, EN 60079-11: 2012  
Markings:  II 1 G Ex ia IIC T4 Ga, T4 (-40 °C ≤ T<sub>a</sub> ≤ +70 °C) IP66/67

**Special Conditions for Safe Use (X):**

1. The plastic enclosure may constitute a potential electrostatic ignition risk and must not be rubbed or cleaned with a dry cloth.
2. The measured capacitance between the equipment enclosure and metallic inline sensor module is 4.7pF. This must be considered only when the WPG is integrated into a system where the process connection is not grounded.
3. Do not change the battery when an explosive atmosphere is present.
4. Only replace battery with Rosemount Part No. 00G45-9000-0001.

**International**

- I7** IECEx Intrinsic Safety  
Certificate: IECEx BAS 16.0012X  
Standards: IEC 60079-0: 2011, IEC 60079-11: 2011  
Markings: Ex ia IIC T4 Ga, T4 (-40 °C ≤ T<sub>a</sub> ≤ +70 °C) IP66/67

**Special Conditions for Safe Use (X):**

1. The plastic may constitute a potential electrostatic ignition risk and must not be rubbed or cleaned with a dry cloth.
2. The measured capacitance between the equipment enclosure and metallic inline sensor module is 4.7pF. This must be considered only when the WPG is integrated into a system where the process connection is not grounded.
3. Do not change the battery when an explosive atmosphere is present.
4. Only replace battery with Rosemount Part No. 00G45-9000-0001.

**Brazil**

- I2** INMETRO Intrinsic Safety (Only available with the WPG)  
Certificate: UL-BR 16.0826X  
Standards: ABNT NBR IEC 60079-0:2008 + Errata 1:2011, ABNT NBR IEC 60079-11:2009  
Markings: Ex ia IIC T4 Ga, T4 (-40 °C ≤ T<sub>a</sub> ≤ +70 °C)

**Special Conditions for Safe Use (X):**

1. See certificate for special conditions.

**Japan**

- I4** TIIS Intrinsic Safety (Only available with the WPG)  
Certificate: TC22068X  
Markings: Ex ia IIC T4 Ga, T4 (-40 °C ≤ T<sub>a</sub> ≤ +70 °C)

**Special Conditions for Safe Use (X):**

1. See certificate for special conditions.

**EAC - Belarus, Kazakhstan, Russia**

- IM** Technical Regulation Customs Union (EAC) Intrinsic Safety (Only available with the WPG)  
Certificate: TC RU C-US.AA87.B.00372  
Markings: 0Ex ia IIC T4 Ga X, T4 (-40 °C ≤ T<sub>a</sub> ≤ +70 °C) IP66/67

**Special Conditions for Safe Use (X):**

1. See certificate for special conditions.

# Dimensional Drawings

Figure 2. Rosemount Wireless Pressure Gauge

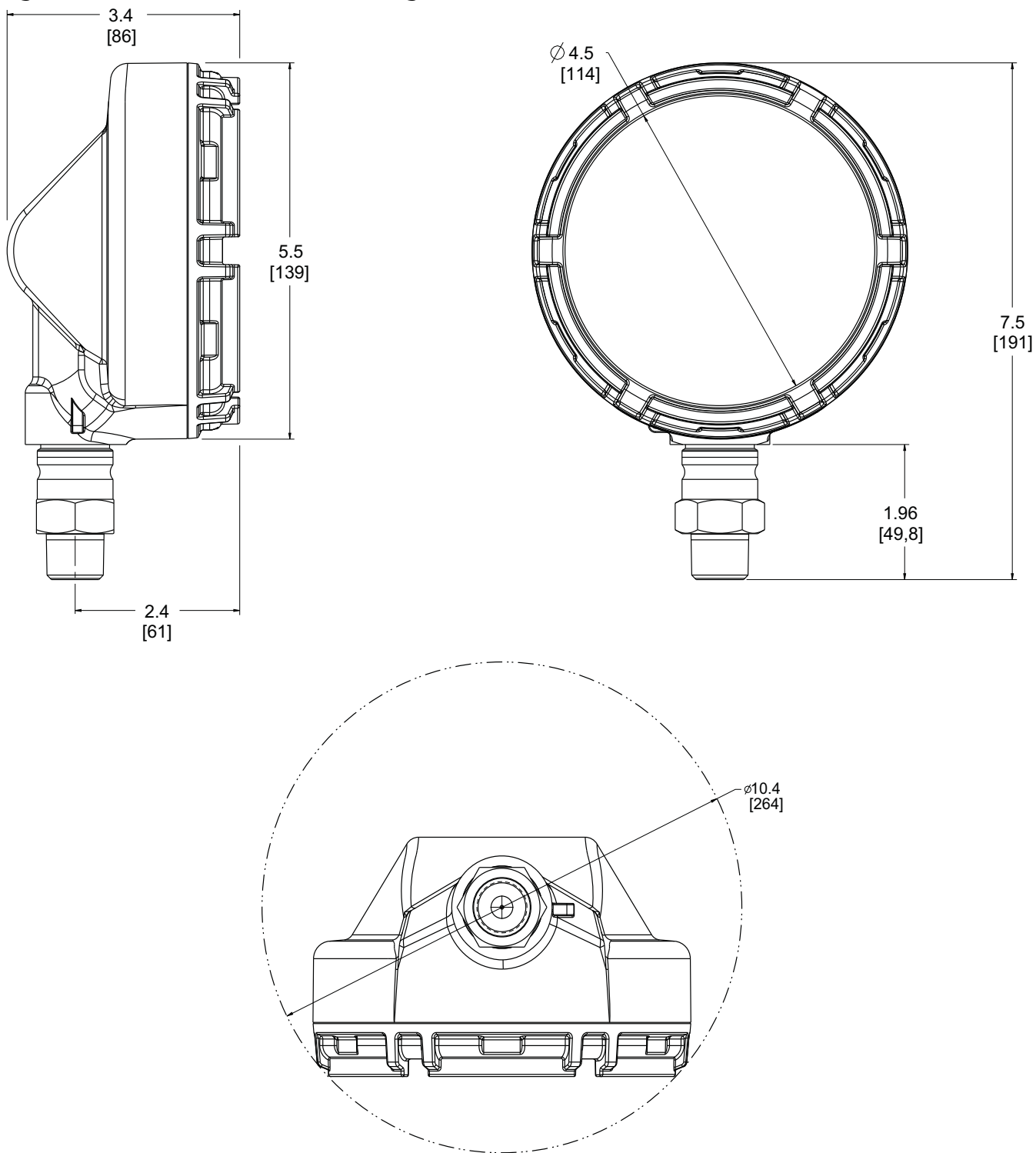

Dimensions are in inches (millimeters).



### Global Headquarters

#### Emerson Automation Solutions

6021 Innovation Blvd.  
Shakopee, MN 55379, USA  
 +1 800 999 9307 or +1 952 906 8888  
 +1 952 949 7001  
 RFQ.RMD-RCC@Emerson.com

### North America Regional Office

#### Emerson Automation Solutions

8200 Market Blvd.  
Chanhassen, MN 55317, USA  
 +1 800 999 9307 or +1 952 906 8888  
 +1 952 949 7001  
 RMT-NA.RCCRFQ@Emerson.com



### Latin America Regional Office

#### Emerson Automation Solutions

1300 Concord Terrace, Suite 400  
Sunrise, FL 33323, USA  
 +1 954 846 5030  
 +1 954 846 5121  
 RFQ.RMD-RCC@Emerson.com

### Europe Regional Office

#### Emerson Automation Solutions Europe GmbH

Neuhofstrasse 19a P.O. Box 1046  
CH 6340 Baar  
Switzerland  
 +41 (0) 41 768 6111  
 +41 (0) 41 768 6300  
 RFQ.RMD-RCC@Emerson.com

### Asia Pacific Regional Office

#### Emerson Automation Solutions

1 Pandan Crescent  
Singapore 128461  
 +65 6777 8211  
 +65 6777 0947  
 Enquiries@AP.Emerson.com

### Middle East and Africa Regional Office

#### Emerson Automation Solutions

Emerson FZE P.O. Box 17033  
Jebel Ali Free Zone - South 2  
Dubai, United Arab Emirates  
 +971 4 8118100  
 +971 4 8865465  
 RFQ.RMTMEA@Emerson.com

 [Linkedin.com/company/Emerson-Automation-Solutions](https://www.linkedin.com/company/Emerson-Automation-Solutions)

 [Twitter.com/Rosemount\\_News](https://twitter.com/Rosemount_News)

 [Facebook.com/Rosemount](https://www.facebook.com/Rosemount)

 [Youtube.com/user/RosemountMeasurement](https://www.youtube.com/user/RosemountMeasurement)

 [Google.com/+RosemountMeasurement](https://www.google.com/+RosemountMeasurement)

Emerson Terms and Conditions of Sale are available upon request.  
The Emerson logo is a trademark and service mark of Emerson Electric Co.  
Instrument Toolkit, Rosemount and Rosemount logotype are trademarks of Emerson.  
All other marks are the property of their respective owners.  
© 2018 Emerson. All rights reserved.