



**INSTRUMENTS**

# **GX-3R**

## **Operator's Manual**

*Part Number: 71-0477*

*Revision: P1*

*Released: 5/15/19*

# **WARNING**

Read and understand this instruction manual before operating instrument. Improper use of the gas monitor could result in bodily harm or death.

Periodic calibration and maintenance of the gas monitor is essential for proper operation and correct readings. Please calibrate and maintain this instrument regularly! Frequency of calibration depends upon the type of use you have and the sensor types. Typical calibration frequencies for most applications are between 1 and 3 months, but can be required more often or less often based on your usage.

---

# Table of Contents

<b>Chapter 1: Introduction</b> .....	<b>6</b>
Overview .....	6
About the GX-3R .....	6
Specifications .....	7
About this Manual .....	8
<b>Chapter 2: Description</b> .....	<b>9</b>
Overview .....	9
Instrument Description .....	9
<i>Case</i> .....	9
<i>LCD</i> .....	9
<i>Control Buttons</i> .....	10
<i>Alarm LEDs</i> .....	10
<i>Buzzer</i> .....	10
<i>Vibrator</i> .....	10
<i>Sensors</i> .....	10
<i>Filters</i> .....	11
<i>Infrared Communications Port</i> .....	12
<i>Charging Socket and Battery Pack</i> .....	12
Included Accessories .....	13
<i>Alligator Clip</i> .....	13
<i>Rubber Boot</i> .....	13
<i>Wrist Strap</i> .....	13
<i>Single-Unit Charging Cable</i> .....	13
<i>Calibration Cup</i> .....	14
Other Accessories .....	14
<i>Multi-Unit Charger</i> .....	14
<i>Belt Clip</i> .....	14
<i>SDM-3R</i> .....	14
<i>RP-3R</i> .....	14
<i>IrDA Cable</i> .....	14
<b>Chapter 3: Measuring Mode</b> .....	<b>15</b>
Overview .....	15
Start Up .....	15
<i>Turning On the GX-3R</i> .....	15
<i>Performing a Demand Zero</i> .....	20
<i>Turning Off the GX-3R</i> .....	20
Measuring Mode Operation .....	21
<i>Monitoring an Area</i> .....	21
<i>Combustible Gas Detection</i> .....	22
Alarms .....	23
<i>Alarm Indications</i> .....	23
<i>Responding to Alarms</i> .....	25
Data Logging .....	27

<b>Chapter 4: Display Mode</b> .....	<b>29</b>
Tips for Using Display Mode .....	30
Peak Screen (PEAK).....	30
STEL Screen (STEL) .....	31
TWA Screen (TWA) .....	31
Changing the Combustible Gas Sensor's Gas (LIST) .....	32
Changing the User ID (USER ID) .....	33
Changing the Station ID (STN ID).....	34
Last Successful Calibration Date (CAL DATA).....	35
Last Successful Bump Test Date (BUMP DATA) .....	36
Date, Time, and Temperature Screen (TEMP) .....	37
Viewing Alarm Settings Screen (ALARM--PT).....	37
<b>Chapter 5: User Mode and Calibration</b> .....	<b>39</b>
Overview.....	39
Entering User Mode .....	42
Tips for Using User Mode .....	43
Performing a Bump Test (BUMP) .....	43
Performing a Calibration (GAS CAL) .....	47
Setting Calibration Parameters (CAL SET) .....	56
Setting Bump Test Parameters (BUMP SET).....	58
Alarm Settings (ALARM--PT).....	62
Updating the Lunch Break Setting (LUNCH) .....	65
Setting the Confirmation Beep and Non-Compliance Indicator (BEEP).....	66
Updating the Backlight Time (BL TIME).....	68
Turning the Key Tone On/Off (KEY TONE) .....	68
Display Mode Items (DISP SET) .....	69
Zero Suppression (ZERO SUP) .....	69
Zero Follower (ZERO.FLWR) .....	69
Setting the Date/Time (DATE) .....	70
Turning the Password On/Off (PASSWORD) .....	70
Viewing the ROM/SUM (ROM/SUM).....	71
Entering Measuring Mode (START) .....	72
<b>Chapter 6: Maintenance</b> .....	<b>73</b>
Overview .....	73
Troubleshooting .....	73
Recharging the Batteries .....	74
Replacing the Buzzer Cover.....	75
Replacing the Filters .....	75
Replacing the Hydrophobic Dust Filter .....	77
Replacing a Sensor .....	78
<b>Chapter 7: General Parts List</b> .....	<b>80</b>

**Appendix A: Maintenance Mode ..... 82**

Overview ..... 82  
Entering Maintenance Mode ..... 83  
Tips for Using Maintenance Mode ..... 84  
Performing a Calibration (GAS CAL) ..... 85  
Performing a Gas Test (GAS TEST). ..... 85  
Sensor/Battery Replacement Date (SEN DATE) ..... 87  
Performing a Bump Test (BUMP) ..... 88  
Setting Alarms to Latching or Self-Resetting (LATCHING) ..... 89  
Turning the Demand Zero Function On/Off (DEM ZERO)..... 89  
Turning the Auto Zero Function On/Off (AUTOZERO) ..... 90  
Turning the ID Display Function On/Off (ID DISP) ..... 90  
Turning the Zero Suppression On/Off (ZERO SUP) ..... 91  
Turning the Zero Follower On/Off (ZERO.FLWR) ..... 91  
User Mode Zero Suppression (ZSUP.DISP)..... 91  
User Mode Zero Follower (ZFLW.DISP)..... 91  
Setting the Date/Time (DATE) ..... 91  
Turning the Password On/Off (PASSWORD) ..... 92  
Viewing the ROM/SUM (ROM/SUM)..... 93  
Performing a Default (M.DEFAULT)..... 94  
Entering Measuring Mode (START) ..... 95

**Appendix B: Gas Select Mode..... 96**

Overview..... 96  
Entering Gas Select Mode ..... 97  
Tips for Using Gas Select Mode..... 97  
Changing the Gas Combination (GAS COMB) ..... 98  
Saving the Alarm Points (SET R AP) ..... 100  
Turning Calibration Max Span On/Off (MAX SPAN)..... 102  
Stealth and Vibrator Settings (STEALTH) ..... 102  
LEL Definition (CHG LEL) ..... 103  
Exiting Gas Select Mode (START)..... 105

**WARNING:**     *Understand manual before operating. Substitution of components may impair intrinsic safety. To prevent ignition of a hazardous atmosphere, batteries must only be changed or charged in an area known to be nonhazardous. Not tested in oxygen enriched atmospheres (above 21%).*

# Chapter 1: Introduction

---

## Overview

This chapter briefly describes the GX-3R gas monitor. This chapter also describes the *GX-3R Operator's Manual* (this document). Table 1 at the end of this chapter lists the specifications for the GX-3R.

---

## About the GX-3R

Using an advanced detection system consisting of up to three gas sensors, the GX-3R personal four-gas monitor detects the presence of combustible gas, oxygen (O<sub>2</sub>), carbon monoxide (CO), and hydrogen sulfide (H<sub>2</sub>S) simultaneously. The GX-3R's compact size and easy-to-use design makes it ideally suited for a wide range of applications, including sewage treatment plants, utility manholes, tunnels, hazardous waste sites, power stations, petrochemical refineries, mines, paper mills, drilling rigs, and fire fighting stations. The GX-3R offers a full range of features, including:

- Simultaneous monitoring of one to four gases
- Liquid crystal display (LCD) for complete and understandable information at a glance
- Ultrabright alarm LEDs
- Distinctive audible/vibrating alarms for dangerous gas conditions and audible alarms for unit malfunction
- Microprocessor control for reliability, ease of use, and advanced capabilities
- Data logging functions
- Alarm trend data
- STEL, TWA, and over range alarms
- Peak readings
- Built-in time function
- Lunch break feature
- CSA "C/US" classification for Class I, Division I, Groups A, B, C, and D hazardous atmosphere (pending)

**WARNING:** *The Model GX-3R detects oxygen deficiency, elevated levels of oxygen, combustible gases, carbon monoxide, and hydrogen sulfide, all of which can be dangerous or life threatening. When using the GX-3R, you must follow the instructions and warnings in this manual to assure proper and safe operation of the unit and to minimize the risk of personal injury. Be sure to maintain and periodically calibrate the GX-3R as described in this manual.*

# Specifications


**Table 1: Standard Sensor Specifications/Alarm Points**

	<b>Combustible Gas, Methane (CH<sub>4</sub>) Calibration Standard*</b>	<b>Oxygen (O<sub>2</sub>)</b>	<b>Hydrogen Sulfide (H<sub>2</sub>S)</b>	<b>Carbon Monoxide (CO)</b>
<b>Detection Range</b>	0 - 100% LEL	0 - 25% volume	0 - 100.0 ppm	0 - 500 ppm
<b>Service Range</b>	n/a	25.1 - 40% volume	100.1 - 200.0 ppm	501 - 2,000 ppm
<b>Reading Increment</b>	1% LEL	0.1% volume	0.1 ppm	1 ppm
<b>Warning Factory Setting</b>	10% LEL**	19.5% volume, decreasing**	5.0 ppm**	25 ppm**
<b>Alarm Factory Setting</b>	25% LEL	18.0% volume, decreasing	30.0 ppm	50 ppm
<b>Alarm H Factory Setting</b>	50% LEL	23.5% volume, increasing	100.0 ppm	1200 ppm
<b>STEL Alarm</b>	n/a	n/a	5.0 ppm	200 ppm
<b>TWA Alarm</b>	n/a	n/a	1.0 ppm	25 ppm

\* The GX-3R is also available set up for general hydrocarbons and calibrated to a combustible gas other than methane, such as isobutane. Consult RKI Instruments, Inc. for further information.

**Table 2: GX-3R Specifications**

Sampling Method	Diffusion
Response Time	T90 within 30 seconds
Display	Graphics LCD Display
Operating Temperature & Humidity	<b>Continuous environment:</b> -20°C to 50°C/Below 90% RH <b>Temporary environment (up to 15 minutes):</b> -40°C to 60°C/Below 95% RH
Indication Accuracy for Detection Range	<b>Combustible Gas, Catalytic Type Sensor</b> <ul style="list-style-type: none"> <li>• ± 5% of reading or ± 2% LEL (whichever is greater)</li> </ul> <b>Oxygen</b> <ul style="list-style-type: none"> <li>• ± 0.5% O<sub>2</sub></li> </ul> <b>Hydrogen Sulfide</b> <ul style="list-style-type: none"> <li>• ± 5% of reading or ± 2 ppm H<sub>2</sub>S (whichever is greater)</li> </ul> <b>Carbon Monoxide</b> <ul style="list-style-type: none"> <li>• ± 5% of reading or ± 5 ppm CO (whichever is greater)</li> </ul>
Indication Accuracy for Service Range	<b>Oxygen</b> <ul style="list-style-type: none"> <li>• ± 3.0% O<sub>2</sub></li> </ul> <b>Hydrogen Sulfide and Carbon Monoxide</b> <ul style="list-style-type: none"> <li>• ± 20% of reading</li> </ul>

Safety/ Regulatory	<ul style="list-style-type: none"> <li>• ATEX: II 1 G Ex da ia IIC T4 Ga Certificate Number: DEKRA 17ATEX0103 X</li> <li>• IECEx: Ex da ia IIC T4 Ga Certificate Number: IECEx DEK 17.0050X</li> <li>• CSA classified, “C/US”, as Intrinsically Safe. Exia. Class I, Groups A, B, C, &amp; D. Temperature Code T3A. (pending)</li> </ul>  <p>C US 186718</p>
Power Supply	Lithium ion battery pack
Continuous Operating Hours @ 25 °C	25 hours in Measuring Mode (Non Alarm Operation, Fully Charged)
Case	High-impact Plastic, RF Shielded, Dust and Weather Proof (IP66/68)
Included Accessories	<ul style="list-style-type: none"> <li>• Alligator clip</li> <li>• Rubber boot</li> <li>• Wrist strap</li> <li>• Calibration cup</li> <li>• Single-unit charger cable</li> </ul>
Other Accessories	<ul style="list-style-type: none"> <li>• Multi-unit charger cable</li> <li>• Belt clip</li> <li>• SDM-3R</li> <li>• RP-3R</li> <li>• IrDA/USB Cable for connecting to a computer when using the Data Logger Management Program (not needed if computer has an infrared port)</li> </ul>
Dimensions and Weight	<p>Approximately 65(H) x 58(W) x 26(D) mm (2.6”H x 2.3”W x 1.0”D) Approximately 100 g (3.5 oz.)</p>

---

## About this Manual

The *GX-3R Operator’s Manual* uses the following conventions for notes, cautions, and warnings.

---

**NOTE:** Describes additional or critical information.

---

**CAUTION:** Describes potential damage to equipment.

**WARNING:** Describes potential danger that can result in injury or death.

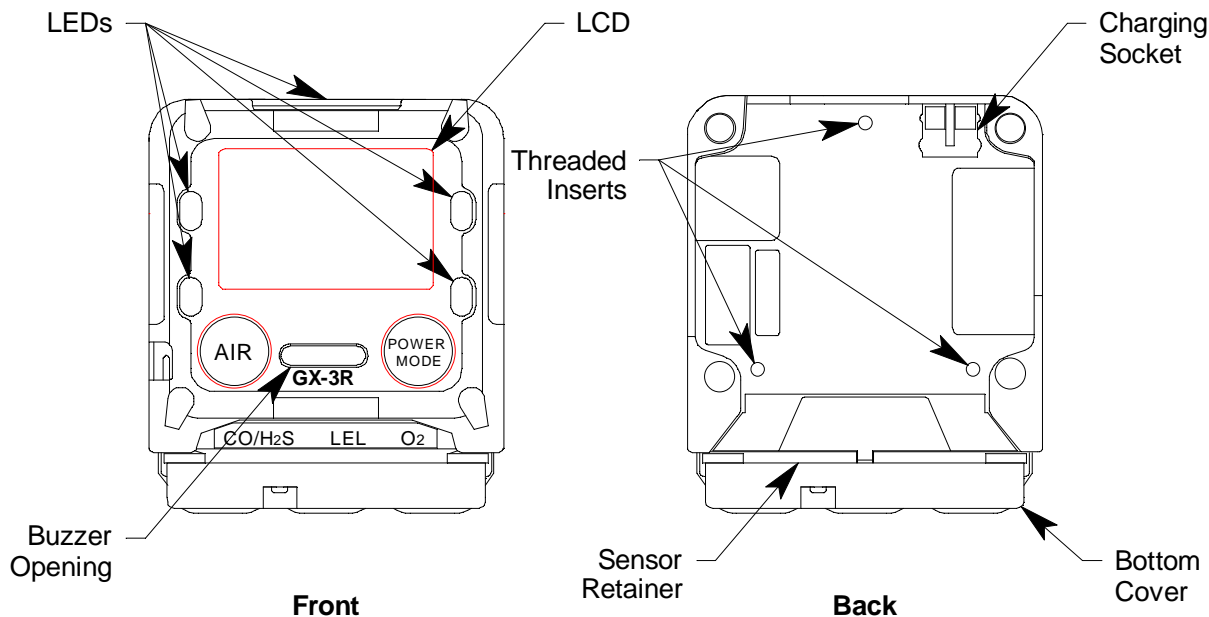


# Chapter 2: Description

## Overview

This chapter describes the GX-3R instrument and its accessories.

## Instrument Description



**Figure 1: Component Location**

### Case

The GX-3R's sturdy, high-impact plastic case is radio frequency (RF) resistant and is suitable for use in many environmental conditions, indoors and out. The case is dust proof and water resistant. A clear plastic window is located on the front of the case for viewing the LCD. The black bottom cover is located on the bottom of the case and allows access to the filters and sensors. A sensor retainer and filter gasket help orient and retain the sensor and filters.

Three threaded inserts on the back of the case allow for installation of an alligator clip or belt clip.

### LCD

The digital LCD (liquid crystal display) simultaneously shows the gas reading for all installed sensors. The LCD also shows information for each of the GX-3R's operating modes.

## Control Buttons

Two control buttons, AIR and POWER MODE, are located below the LCD.

**Table 3: GX-3R Control Button Functions**

Button	Function(s)
AIR	<ul style="list-style-type: none"><li>• turns on LCD backlight</li><li>• resets alarm condition if <b>LATCHING</b> is set to <b>ON</b> in Maintenance Mode</li><li>• enters User Mode, Maintenance Mode, and Gas Select Mode when used with POWER MODE button</li><li>• activates the demand zero function (adjusts the GX-3R's fresh air reading)</li><li>• changes the value of a parameter available for adjustment</li><li>• scrolls through parameter options</li></ul>
POWER MODE	<ul style="list-style-type: none"><li>• turns the GX-3R on and off</li><li>• turns on LCD backlight</li><li>• enters and scrolls through Display Mode</li><li>• enters instructions into the GX-3R's microprocessor</li><li>• resets alarm condition if <b>LATCHING</b> is set to <b>ON</b> in Maintenance Mode</li><li>• enters User Mode, Maintenance Mode, and Gas Select Mode when used with AIR button</li></ul>

## Alarm LEDs

The six alarm LEDs around the edge of the case alert you to gas, low battery, and failure alarms.

## Buzzer

One solid-state electronic buzzer is located inside the case. A hole in the middle front of the case allow the sound to exit the case. The buzzer sounds for gas alarms, malfunctions, low battery voltage, and as an indicator during use of the GX-3R's many display and adjustment options.

## Vibrator

A vibrating motor inside the GX-3R case vibrates for gas alarms, unit malfunctions, and as an indicator during normal use of the various modes of the GX-3R.

---

**NOTE:** If **STEALTH** is set to **ON**, the vibrator only functions when **VIB** in the **STEALTH** Gas Select Mode item is set to **ON**. See "Stealth and Vibrator Settings (STEALTH)" on page 102.

---

## Sensors

The GX-3R uses three sensors to monitor combustible gas, oxygen (O<sub>2</sub>), carbon monoxide (CO), and hydrogen sulfide (H<sub>2</sub>S) simultaneously. The sensors are located inside the GX-3R and are held in their sockets by the sensor retainer and bottom cover. The sensors use different detection principles, as described below.

### **Combustible Gas Sensor**

The combustible gas sensor detects combustible gas in the %LEL range. It uses a catalytic element for detection. The reaction of gas with oxygen on the catalyst causes a change in the resistance of the element which affects the current flowing through it. The current is amplified by the GX-3R's circuitry, converted to a measurement of combustible gas concentration, and displayed on the LCD.

The standard calibration for the combustible gas sensor is to methane but the sensor will still detect and respond to a variety of combustible gases.

### ***O<sub>2</sub>/CO/H<sub>2</sub>S Sensors***

The O<sub>2</sub>, CO, and H<sub>2</sub>S sensors are electrochemical cells that consist of two precious metal electrodes in a dilute acid electrolyte. A gas permeable membrane covers the sensor face and allows gas to diffuse into the electrolyte. The gas reacts in the sensor and produces a current proportional to the concentration of the target gas. The current is amplified by the GX-3R's circuitry, converted to a measurement of gas concentration, and displayed on the LCD.

There are 4 different types of CO and H<sub>2</sub>S sensors available:

- CO only (ESR-A13P): A single electrochemical cell that detects CO. Instruments with this sensor cannot detect H<sub>2</sub>S.
- H<sub>2</sub> compensated CO (ESR-A1CP): A single electrochemical cell that detects CO. This sensor does not respond to or responds minimally to hydrogen. Instruments with this sensor cannot detect H<sub>2</sub>S.
- H<sub>2</sub>S only (ESR-A13i): A single electrochemical cell that detects H<sub>2</sub>S. Instruments with this sensor cannot detect CO.
- CO/H<sub>2</sub>S (ESR-A1DR): A combination electrochemical cell that detects both CO and H<sub>2</sub>S.

### ***Dummy Sensors***

Any unit that has less than 3 sensors will have a dummy sensor installed in one or more unused sensor positions. Dummy sensors are factory installed. The flat side of the dummy sensor should face away from the GX-3R and the hollow side should face toward the GX-3R.

### **Filters**

#### ***H<sub>2</sub>S Removal Filter Disk (Dark Red)***

An H<sub>2</sub>S removal filter disk is placed into a recess in the filter gasket over the combustible gas sensor. It prolongs the life of the sensor by preventing H<sub>2</sub>S in the ambient air from reaching the combustible gas sensor. The H<sub>2</sub>S filter disk is dark red in color and although it may darken over time, its color is not indicative of remaining filter life.

The H<sub>2</sub>S filter disk can absorb H<sub>2</sub>S for 33 ppm hours and should be replaced after that much exposure. With this many ppm hours of absorption, the H<sub>2</sub>S filter disk should be replaced after 80 minutes of exposure to 25 ppm H<sub>2</sub>S. This equates to replacing the H<sub>2</sub>S filter disk after 40 2-minute calibrations with a cylinder containing 25 ppm H<sub>2</sub>S. If H<sub>2</sub>S exists in the monitoring environment, the H<sub>2</sub>S filter disk will have to be replaced more frequently.

#### ***Charcoal Filter (Black)***

A black charcoal filter is placed into a recess in the filter gasket over the CO sensor. The charcoal filter disk scrubs H<sub>2</sub>S and certain hydrocarbons out of the sample to avoid false CO readings. If false or elevated CO readings are noticed, especially in the presence of H<sub>2</sub>S, change the charcoal filter.

If your instrument has a combo CO/H<sub>2</sub>S sensor, it will have a filter installed that is half

black charcoal filter and half white humidity filter.

### ***Humidity Filter (White)***

A white humidity filter covers the H<sub>2</sub>S sensor.

If your instrument has a combo CO/H<sub>2</sub>S sensor, it will have a filter installed that is half black charcoal filter and half white humidity filter.

### ***Hydrophobic Dust Filter***

The oval-shaped hydrophobic dust filter sits on the filter gasket, covering the sensor ports and the filters.

### **Infrared Communications Port**

An infrared (IR) communications port is located on the top of the case, near the top LEDs. The data transmitted through the port is in standard IrDA protocol. A computer's infrared port or an IrDA/USB cable connected to a USB port can be used to download data saved by the GX-3R to a computer using the GX-3R Data Logger Management Program. See the GX-3R Data Logger Management Program operator's manual for data logging and downloading instructions.

### **Charging Socket and Battery Pack**

A charging socket on the back of the instrument allows for charging cable connection.

A lithium ion (Li-ion) battery pack powers the GX-3R. At 25°C the battery lasts at least 25 hours. The battery icon in the upper right of the LCD shows remaining battery life.

When the GX-3R detects a low battery voltage, a low battery warning is activated. When battery voltage is too low for Measuring Mode, the GX-3R sounds a dead battery alarm.

The battery pack can be recharged by using the GX-3R charging cable. The battery pack is not user-replaceable.

---

**NOTE:** Use of batteries or battery chargers not specified by RKI Instruments, Inc. will compromise the CSA classification and may void the warranty. See "Recharging the Batteries" on page 74.

---

**WARNING:** *To prevent ignition of a hazardous atmosphere, batteries must only be changed or charged in an area known to be nonhazardous.*

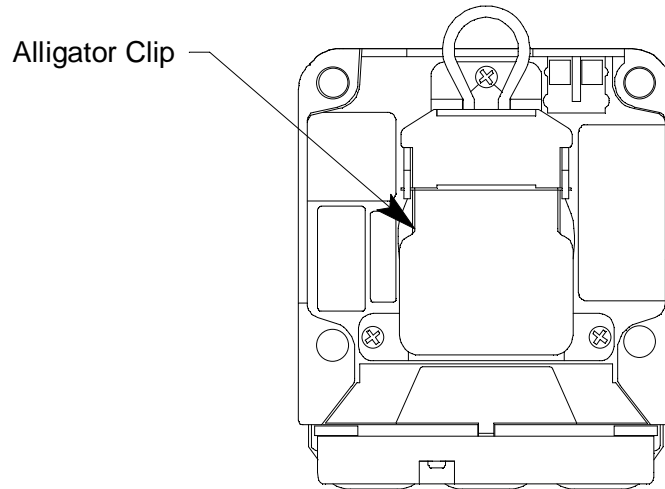
**AVERTISSEMENT:** *Pour éviter l'inflammation d'une atmosphère dangereuse, les batteries doivent uniquement être modifiés ou facturés dans une zone connue comme non dangereuse.*

---

## Included Accessories

### Alligator Clip

An alligator clip is installed on the back of the GX-3R. The alligator clip can be used to attach the GX-3R to clothing or a belt. Teeth in the alligator clip's jaws prevent the unit from slipping off. The alligator clip can be rotated to change how the instrument is oriented when worn.



**Figure 2: Alligator Clip**

### Rubber Boot

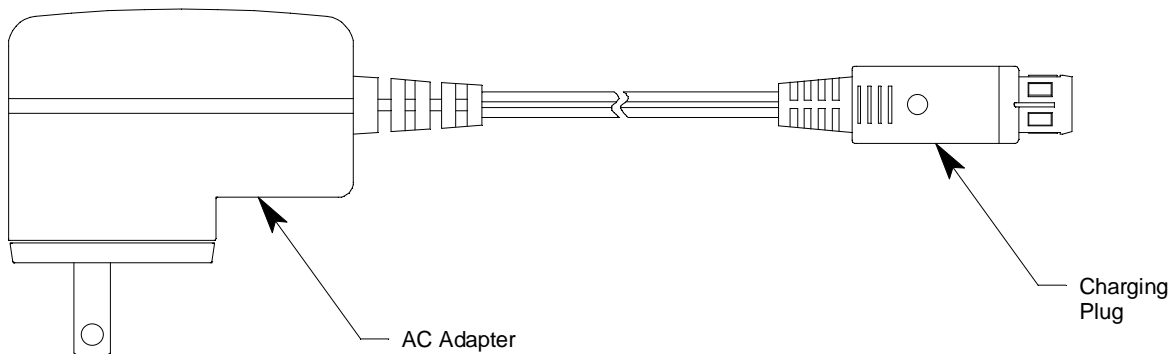
A black rubber boot is installed on the GX-3R.

### Wrist Strap

A wrist strap is included with the GX-3R and can be attached to the wrist strap installation feature on the left side of the GX-3R's case.

### Single-Unit Charging Cable

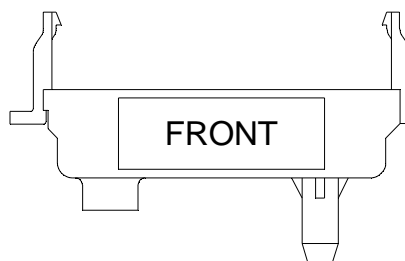
The charging cable has an AC adapter on one end and a charging plug that connects to the GX-3R on the other end.



**Figure 3: Charging Cable**

## Calibration Cup

Use the calibration cup to apply gas during a bump test, calibration, or gas test. The calibration cup has an installation orientation to observe. “Front” and “rear” imprinting on the bottom of the cup correspond to the front and rear of the GX-3R Pro when the calibration cup is installed. In addition, a “front” label on the front of the calibration cup should be visible when viewing the LCD with the calibration cup installed.



**Figure 4: Calibration Cup**

---

## Other Accessories

### Multi-Unit Charger

The multi-unit charger is a wall plug style adapter that plugs into a bar. The bar has five 4-foot cables coming out one side. The end of each of the five cables has a plug that connects to the GX-3R's power jack. The AC adapter is rated 100 - 240 VAC input, 5.99 VDC output.

### Belt Clip

A belt clip makes it easy to hook the GX-3R to a utility belt.

### SDM-3R

The SDM-3R is a calibration station for the GX-3R and GX-3R Pro. The station's buttons can be used for operations (Standalone Mode) or a computer can be used to control the docking station (PC Controlled Mode). See the appropriate SDM-3R manual for more information.

### RP-3R

The RP-3R is a pump that allows sample to be drawn to the GX-3R.

### IrDA Cable

Unless your computer has a built-in IrDA port, an IrDA cable is needed to establish communication between the GX-3R and the Datalogging Program or the User Setup Program.

# Chapter 3: Measuring Mode

---

## Overview

This chapter explains how to use the GX-3R to perform confined space entry monitoring or general area monitoring in Measuring Mode. Display Mode is accessed from Measuring Mode by pressing POWER MODE and is described in “Chapter 4: Display Mode” on page 29.

---

## Start Up

This section explains how to start up the GX-3R, get it ready for operation, and turn it off.

---

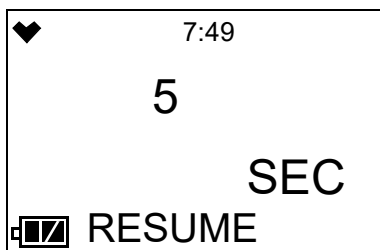
**NOTE:** The screens illustrated in this section are for a standard 4-gas unit. The screens displayed by your GX-3R may be slightly different.

---

### Turning On the GX-3R

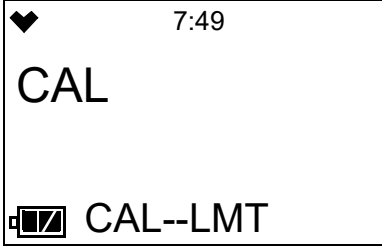
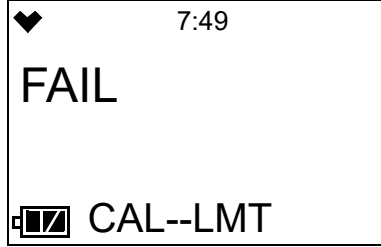
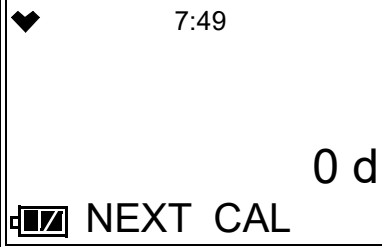
To illustrate certain functions, the following description of the GX-3R start up sequence assumes that the following menu items in User Mode are turned on: **LUNCH**, **CAL RMDR**, and **BUMP.RMDR** in User Mode, and **ID DISP** and **AUTOZERO** in Maintenance Mode. If any of these items are turned off, then the corresponding screens will not appear.

1. Press and briefly hold down POWER MODE. Release the button when you hear a beep.
2. If **LUNCH** is set to **ON** (factory setting if **OFF**, see “Updating the Lunch Break Setting (LUNCH)” on page 65), the Lunch Break Screen appears. The unit counts down from 5 seconds.



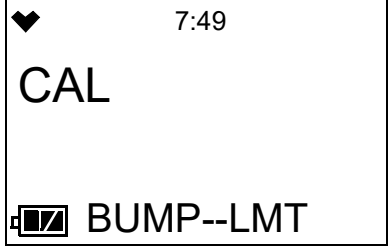
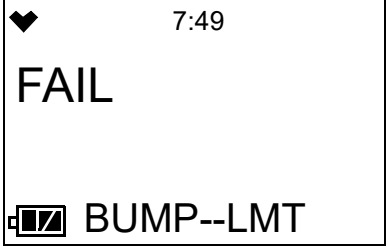
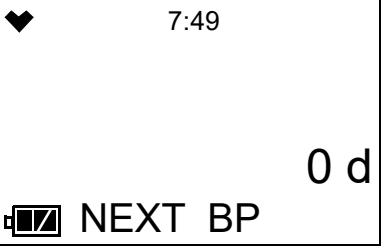
- a. Continue Accumulating: To continue accumulating peak and time-weighted average (TWA) readings from the last time the GX-3R was used, press and release POWER MODE or allow the countdown to reach 0. The short-term exposure limit (STEL) reading is reset each time the GX-3R is turned on.
- b. Reset Accumulation: To reset the accumulation of peak and time-weighted average (TWA) readings, press and release AIR before the countdown reaches 0.

3. If **CAL RMDR** is set to **ON** (factory setting) and a calibration is due, the screen that appears next depends on how **CAL EXPD** is set in User Mode (see “**CAL EXPD**” on page 57). The three possible screens are described below. If a calibration is not due, the instrument will tell you how many days are left until a calibration is due.

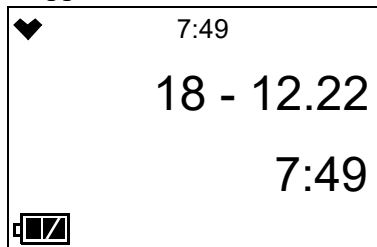
	<b>CAL EXPD</b> set to <b>CONFIRM</b> (factory setting)	<b>CAL EXPD</b> set to <b>CANT USE</b>	<b>CAL EXPD</b> set to <b>NONE</b>
<b>LCD</b>			
<b>Sound</b>	Buzzer sounds double pulsing tone	Buzzer sounds double pulsing tone	None
<b>Action</b>	<ul style="list-style-type: none"> <li>• <b>Option A, Perform calibration:</b> Press and release POWER MODE to enter User Mode to perform a calibration. See “Performing a Calibration (GAS CAL)” on page 47 for calibration instructions. If the calibration was successful, the screen above will not appear again until the unit is due for calibration. If the calibration was not successful, the screen above will again appear in the startup sequence.</li> <li>• <b>Option B, Bypass message:</b> To continue without performing a calibration, press and release AIR.</li> </ul>	<p>The GX-3R cannot be used until a successful calibration has been performed. Press and release POWER MODE to enter User Mode and perform a calibration. See “Performing a Calibration (GAS CAL)” on page 47 for calibration instructions.</p> <p>If the calibration was successful, the screen above will not appear again until the unit is due for calibration. If the calibration was not successful, the screen above will again appear in the startup sequence.</p>	<ul style="list-style-type: none"> <li>• <b>Option A, Perform calibration:</b> If you want to enter User Mode to perform a calibration, press and release POWER MODE.</li> <li>• <b>Option B, Bypass message:</b> To continue without performing a calibration, wait a few seconds for the instrument to continue with its startup sequence.</li> </ul>



4. If **BUMP.RMDR** is set to **ON** (factory setting is **OFF**) and a bump test is due, the screen that appears next depends on how **BUMP.EXPD** is set in User Mode (see “**BUMP.EXPD**” on page 61). The three possible screens are described below. If a bump test is not due, the instrument will tell you how many days are left until a bump test is due.

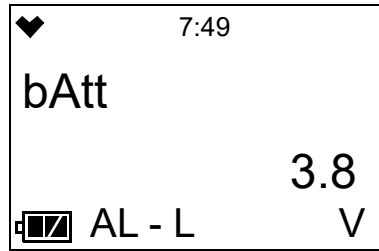
	<b>BUMP.EXPD</b> set to <b>CONFIRM</b> (factory setting)	<b>BUMP.EXPD</b> set to <b>CANT USE</b>	<b>BUMP.EXPD</b> set to <b>NONE</b>
<b>LCD</b>			
<b>Sound</b>	Buzzer sounds double pulsing tone	Buzzer sounds double pulsing tone	None
<b>Action</b>	<ul style="list-style-type: none"> <li>• <b>Option A, Perform bump test:</b> Press and release <b>POWER MODE</b> to enter User Mode to perform a bump test. See “Performing a Bump Test (BUMP)” on page 43 for bump test instructions. If the bump test was successful, the screen above will not appear again until the unit is due for bump testing. If the bump test was not successful, the screen above will again appear in the startup sequence.</li> <li>• <b>Option B, Bypass message:</b> To continue without performing a bump test, press and release <b>AIR</b>.</li> </ul>	<p>The GX-3R cannot be used until a successful bump test has been performed. Press and release <b>POWER MODE</b> to enter User Mode and perform a bump test. See “Performing a Bump Test (BUMP)” on page 43 for bump test instructions.</p> <p>If the bump test was successful, the screen above will not appear again until the unit is due for bump testing. If the bump test was not successful, the screen above will again appear in the startup sequence.</p>	<ul style="list-style-type: none"> <li>• <b>Option A, Perform bump test:</b> If you want to enter User Mode to perform a bump test, press and release <b>POWER MODE</b>.</li> <li>• <b>Option B, Bypass message:</b> To continue without performing a bump test, wait a few seconds for the instrument to continue with its startup sequence.</li> </ul>

5. The Date/Time Screen appears for a few seconds.



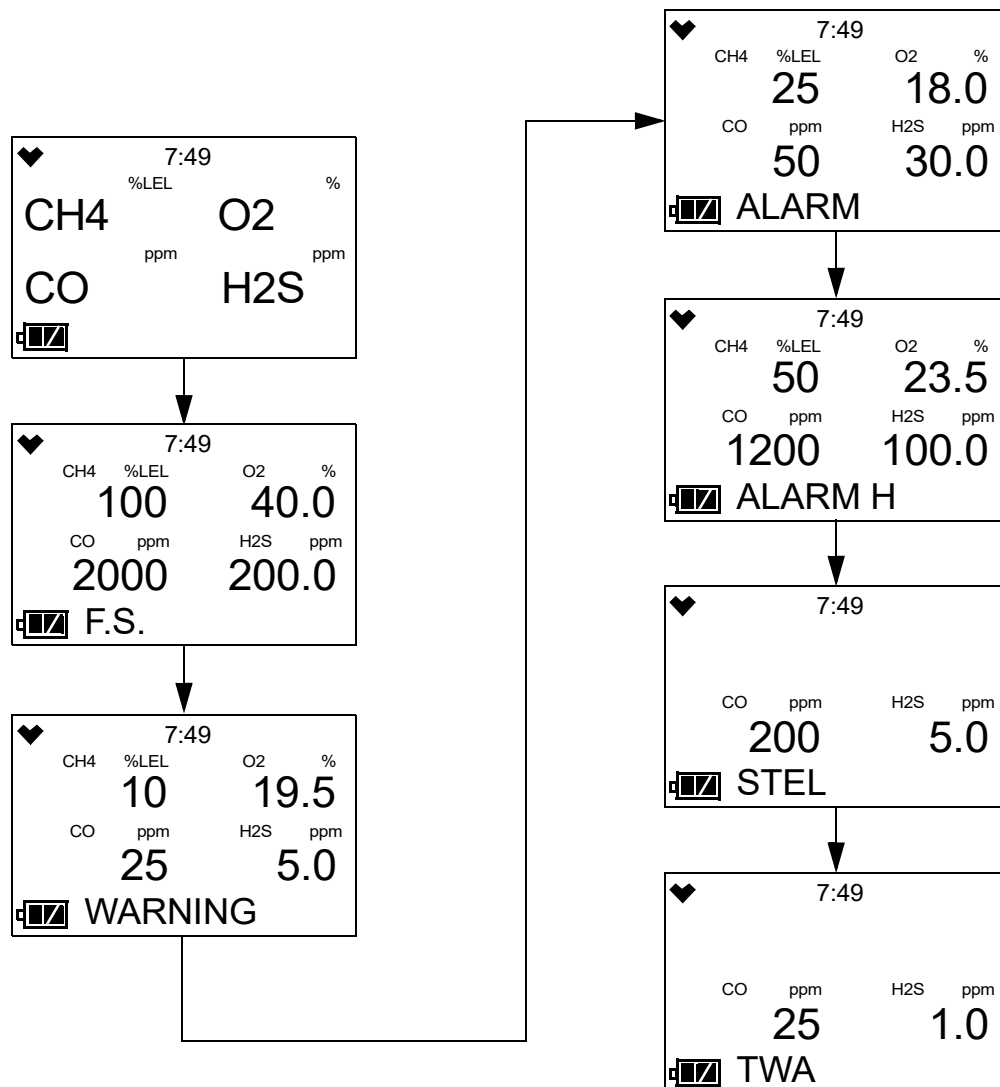
6. The Battery Voltage Screen appears for a few seconds.

An “AL-L” at the bottom of the screen indicates that the alarms are set to latching.  
 An “AL-A” at the bottom of the screen indicates that the alarms are set to auto reset.  
 See “Setting Alarms to Latching or Self-Resetting (LATCHING)” on page 89 for a description of how to change this parameter.

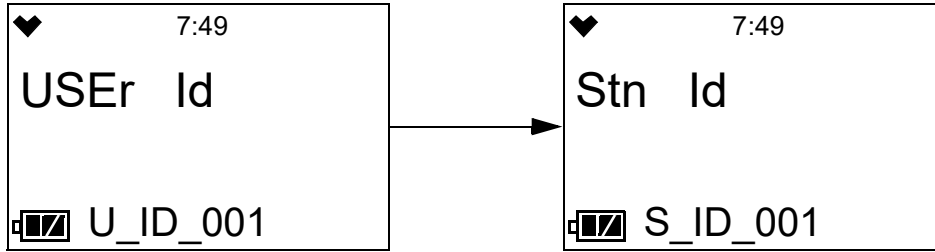


7. The following screens display for 3 seconds each: the Gas Name Screen, the Full Scale Screen, the Warning Setpoint Screen, the Alarm Setpoint Screen, the Alarm H Setpoint Screen, the STEL Alarm Screen, and TWA Alarm Screen.

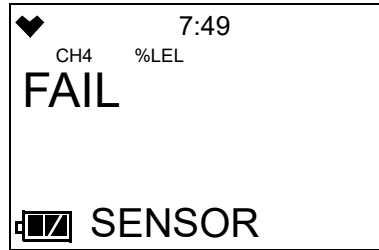
**NOTE:** If the combustible gas is set to something other than CH<sub>4</sub> or H<sub>2</sub> in Gas Select Mode, the combustible channel is displayed as “HC” and the gas formula for the combustible gas sensor’s target gas appears during startup.



8. If **ID DISP** is set to **ON** (factory setting is **OFF**, see “Turning the ID Display Function On/Off (ID DISP)” on page 90), the User ID Screen appears for a few seconds, followed by the Station ID Screen.



9. If the GX-3R experiences a sensor failure during start up, a screen indicating which sensor failed appears and the buzzer sounds a double pulsing tone once per second. In the example below, the combustible gas sensor has failed.

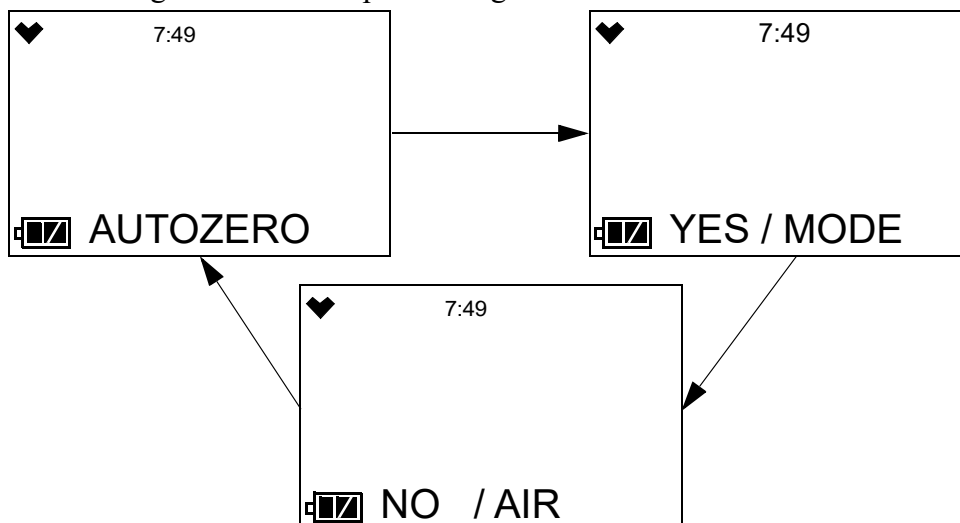


Press and release **POWER MODE** to acknowledge the failure and continue. The gas reading for the failed sensor will be replaced by “- - - -”. Replace the failed sensor as soon as possible.

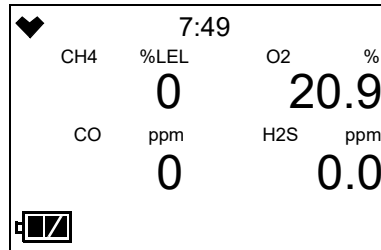
10. If **AUTOZERO** is set to **ON** (factory setting is **OFF**, see “Turning the Auto Zero Function On/Off (AUTOZERO)” on page 90), the instrument prompts you to do an auto zero. An auto zero operation sets the combustible gas, H<sub>2</sub>S, and CO channels to zero and the OXY channel to 20.9%.

**WARNING:** *Make sure that the instrument is in a known fresh air environment (an environment free of combustible or toxic gases and of normal oxygen content, 20.9%) before performing an auto zero operation. If you perform an auto zero operation in an area with gases present, the adjustment will not be accurate.*

You must press and release the **POWER MODE** button to perform an auto zero function. If you do not press any key, after 15 seconds, the instrument will enter Measuring Mode without performing an auto zero.



- 11 . The GX-3R is now monitoring for gas in Measuring Mode. The Measuring Mode Screen appears displaying the current gas reading for each target gas.



## Performing a Demand Zero

Before using the GX-3R, it is recommended to set the fresh air readings for the target gases by performing a demand zero. This will set the combustible gas, H<sub>2</sub>S, and CO channels to zero and the OXY channel to 20.9%.

- 1 . Find a fresh-air environment. This is an environment free of toxic or combustible gases and of normal oxygen content (20.9%).
- 2 . Turn on the unit as described above in “Turning On the GX-3R”.
- 3 . Press and hold AIR. The LCD prompts you to continue holding AIR and the buzzer will pulse while you hold the button (if **KEY TONE** is set to **ON** in User Mode).
- 4 . Continue to hold AIR until the LCD prompts you to release it. The GX-3R will set the fresh air reading for all channels. Start up is complete and the unit is now ready for monitoring.

## Turning Off the GX-3R

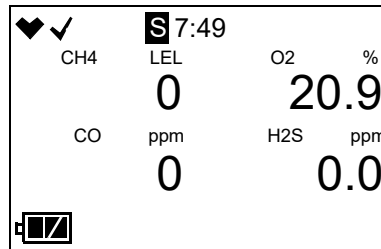
- 1 . Press and hold POWER MODE.
- 2 . TURN OFF will appear on the display and the buzzer will pulse for about five seconds (if **KEY TONE** is set to **ON** in User Mode).
- 3 . Release the button when TURN OFF disappears from the display.

## Measuring Mode Operation

When the GX-3R completes its startup sequence, it is in Measuring Mode. In Measuring Mode the GX-3R continuously monitors the sampled atmosphere and displays the gas concentrations present for its target gases. The GX-3R is considered to be in Normal Operation if there are no alarm indications.

If **BUMP.RMDR** is set to **ON** and if a bump test is not due, a check mark will appear in the upper left corner of the LCD.

If the instrument is operating in Stealth Mode, an “S” will appear at the top of the LCD.

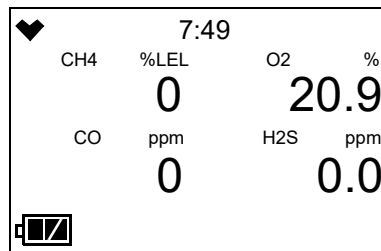


In a low-light environment, press and release either button to turn on the display backlight. See “Updating the Backlight Time (BL TIME)” on page 68 to program backlight duration.

If the **BEEP** menu item in User Mode is set to anything other than **OFF**, the GX-3R will give periodic indications to confirm that it’s operating or to indicate a non-compliance (see “Setting the Confirmation Beep and Non-Compliance Indicator (BEEP)” on page 66).

### Monitoring an Area

1. Start up the GX-3R as described above in “Start Up” on page 15. It is now in Measuring Mode.



2. Take the GX-3R to the monitoring area.
3. Wait at least 15 seconds and observe the display for gas readings. If a reading is observed, allow the reading to stabilize to determine the gas concentrations present.
4. If a gas alarm occurs, take appropriate action. See “Responding to Alarms” on page 25.

## Combustible Gas Detection

There are three issues to keep in mind when monitoring for combustible gas.

- The combustible gas sensor will respond to any combustible gas. The standard calibration gas for the combustible gas channel is methane (CH<sub>4</sub>). If the instrument is setup for and calibrated to a different combustible gas, such as hexane or propane, the the gas name right above the readings displays as “HC”.

The table below lists the conversion factors for several hydrocarbon gases **if the GX-3R is calibrated to methane**. To use this table, multiply the display reading on the combustible gas channel by the factor in the appropriate row to obtain the actual gas concentration. For example, if you are detecting ethylene and the display reads 10% LEL for the combustible gas channel, you actually have 10% LEL x 1.20 = 12.0% LEL ethylene present.

**Table 4: LEL Hydrocarbon Conversions**

Gas	LEL Conversion Factor (from CH <sub>4</sub> Cal.)
Acetone	0.45
Acetylene	0.70
Benzene	0.40
Butadiene	0.66
Cyclopentane	0.69
DME	0.86
Ethane	1.06
Ethanol	0.51
Ethyl Acetate	0.35
Ethylene	1.20
Heptane	0.32
Hexane	0.53
Hydrogen	1.05

Gas	LEL Conversion Factor (from CH <sub>4</sub> Cal.)
IPA	0.61
Isobutane	0.91
MEK	0.38
Methane-	1.00
Methanol	0.55
MIBK	0.25
MMA	0.30
Nonane	0.11
Propane	0.89
Propylene	1.03
THF	0.43
Toluene	0.22
Xylene	0.13

- The GX-3R provides the combustible gas sensor with some protection against exposure to high levels of combustible gas which can damage the sensor. It does this by turning off the combustible gas sensor power temporarily when it determines that an over scale (more than 100 %LEL) concentration of combustible gas is present that may damage the sensor. Nevertheless, concentrations of combustible gas of more than 100 %LEL can still affect the zero level or calibration of the combustible gas sensor if the concentration is high enough.

**CAUTION:** *Do not expose the combustible gas sensor to high concentrations of combustible gas such as that from a butane lighter. Exposure to high concentrations of combustible gas may adversely affect the performance of the sensor.*

**CAUTION:** Any rapid increase in the combustible gas reading on the combustible gas channel followed by a declining or erratic reading may indicate a gas concentration above the LEL which may be hazardous.

- Some gases such as silicone vapors, chlorinated hydrocarbons, and sulphur compounds can contaminate the detection elements inside the combustible gas sensor damaging the sensor and result in reduced response to combustible gas. Make every effort to avoid these gases.

The H<sub>2</sub>S scrubber disks protect the combustible sensor from H<sub>2</sub>S, but you should avoid other sulphur compounds.

## Alarms

This section covers alarm indications in Measuring Mode. It also describes how to reset the GX-3R after an alarm has occurred and how to respond to an alarm condition.

**NOTE:** False alarms may be caused by radio frequency (RF) or electromagnetic (EMI) interference. Keep the GX-3R away from RF and EMI sources such as radio transmitters or large motors.

### Alarm Indications

The GX-3R buzzer will sound an alarm, the LEDs will flash, and the vibrator will pulse when any sort of alarm condition or failure is encountered. If the GX-3R is operating in Stealth Mode, the buzzer will not sound and the vibrator's operation will depend on the **VIB** setting in Gas Select Mode's **STEALTH** menu item. See pg.102 for more information.

**NOTE:** If an alarm condition occurs while you are in Display Mode, the GX-3R will automatically bring up the alarm screen instead.

The table below summarizes the types of alarms produced by the GX-3R and their indications.

**Table 5: Alarm Types and Indications**

Alarm Type	Visual Indications	Other Indications
<p><b>Warning</b> Concentration of gas rises above the Warning setting or falls below the Warning setting for O<sub>2</sub>.</p>	<ul style="list-style-type: none"> <li>• Affected channel's gas reading, gas name, and units flash</li> <li>• <b>WARNING</b> appears at the bottom of the LCD</li> <li>• Alarm LEDs flash in circle sequence once per second</li> <li>• Backlight turns on</li> </ul>	<ul style="list-style-type: none"> <li>• High-low tone sounding once per second</li> <li>• Vibrator pulses once per second</li> </ul>
<p><b>Alarm</b> Concentration of gas rises above the Alarm setting.</p>	<ul style="list-style-type: none"> <li>• Affected channel's gas reading, gas name, and units flash</li> <li>• <b>ALARM</b> appears at the bottom of the LCD</li> <li>• Alarm LEDs flash in circle sequence twice per second</li> <li>• Backlight turns on</li> </ul>	<ul style="list-style-type: none"> <li>• High-low tone sounding twice per second</li> <li>• Vibrator pulses twice per second</li> </ul>

**Table 5: Alarm Types and Indications**

Alarm Type	Visual Indications	Other Indications
<p><b>Alarm H</b> Concentration of gas rises above the Alarm H setting or falls below the Alarm H setting for O<sub>2</sub>.</p>	<ul style="list-style-type: none"> <li>Affected channel's gas reading, gas name, and units flash</li> <li><b>ALARM H</b> appears at the bottom of the LCD</li> <li>Alarm LEDs flash in circle sequence twice per second</li> <li>Backlight turns on</li> </ul>	<ul style="list-style-type: none"> <li>High-low tone sounding twice per second</li> <li>Vibrator pulses twice per second</li> </ul>
<p><b>TWA or STEL</b> Concentration of CO or H<sub>2</sub>S rises above the TWA or STEL alarm setting.</p>	<ul style="list-style-type: none"> <li>Affected channel's gas reading, gas name, and units flash</li> <li><b>TWA</b> or <b>STEL</b> appears at the bottom of the LCD</li> <li>Alarm LEDs flash in circle sequence once per second</li> <li>Backlight turns on</li> </ul>	<ul style="list-style-type: none"> <li>High-low tone sounding once per second</li> <li>Vibrator pulses once per second</li> </ul>
<p><b>Over Range</b></p>	<ul style="list-style-type: none"> <li>Affected channel's gas reading is replaced with a flashing □□□</li> <li>Gas name and units flash</li> <li><b>OVER</b> appears at the bottom of the LCD</li> <li>Alarm LEDs flash in circle sequence twice per second</li> <li>Backlight turns on</li> </ul>	<ul style="list-style-type: none"> <li>High-low tone sounding twice per second</li> <li>Vibrator pulses twice per second</li> </ul>
<p><b>Minus Over Range</b></p>	<ul style="list-style-type: none"> <li>Affected channel's gas reading is replaced with a flashing □□□</li> <li>Gas name and units flash</li> <li><b>MOVER</b> appears at the bottom of the LCD</li> <li>Alarm LEDs flash in circle sequence twice per second</li> <li>Backlight turns on</li> </ul>	<ul style="list-style-type: none"> <li>High-low tone sounding twice per second</li> <li>Vibrator pulses twice per second</li> </ul>
<p><b>Low Battery Warning</b></p>	<ul style="list-style-type: none"> <li>The last bar in the battery icon disappears and the battery icon starts flashing</li> </ul>	<p>None</p>
<p><b>Dead Battery Alarm</b></p>	<ul style="list-style-type: none"> <li>Gas readings disappear. <b>FAIL</b> appears in the middle of the screen and <b>BATTERY</b> appears at the bottom of the screen.</li> <li>Alarm LEDs flash once per second</li> </ul>	<p>Double pulsing tone once per second</p>
<p><b>Sensor Failure</b></p>	<ul style="list-style-type: none"> <li><b>SENSOR</b> appears at the bottom of the screen and the failed sensor(s) are indicated with <b>FAIL</b> under the gas name.</li> <li>Alarm LEDs flash once per second</li> </ul>	<p>Double pulsing tone once per second</p>
<p><b>Clock Failure</b></p>	<ul style="list-style-type: none"> <li><b>FAIL</b> appears in the middle of the screen and <b>CLOCK</b> appears at the bottom of the screen.</li> <li>Alarm LEDs flash once per second</li> </ul>	<p>Double pulsing tone once per second</p>



**Table 5: Alarm Types and Indications**

Alarm Type	Visual Indications	Other Indications
System Failure	<ul style="list-style-type: none"> <li>• <b>FAIL SYSTEM</b> appears at the bottom of the screen and an error code displays in the middle</li> <li>• Alarm LEDs flash once per second</li> </ul>	Double pulsing tone once per second

## Responding to Alarms

This section describes response to gas, over range, battery, sensor failure, clock failure, and system failure alarms.

### **Responding to Gas Alarms**

1. Determine which gas alarm has been activated.
2. Follow your established procedure for an increasing gas condition or a decreasing oxygen condition.
3. Reset the alarm as necessary or allowed.
  - a. If **LATCHING** is set to **ON** (factory setting) in Maintenance Mode, the gas reading must fall below (or rise above for an oxygen low alarm) an alarm setting before you can reset the alarm condition using **POWER MODE** or **AIR**.
  - b. If **LATCHING** is set to **OFF** in Maintenance Mode, the alarm condition will automatically reset when gas reading falls below (or rises above for an oxygen low alarm) an alarm setpoint.

### **Responding to Over Range Alarms**

**WARNING:** *An over range condition may indicate an extreme combustible gas, toxic gas, or oxygen concentration. Confirm the gas concentration with a different GX-3R or with another gas detecting device.*

**CAUTION:** *High off-scale readings may indicate an explosive concentration.*

**PRUDENCE:** *Des lectures élevées hors échelle peuvent indiquer une concentration explosive.*

1. Determine which channel is in alarm.
2. Follow your established procedure for an extreme gas condition.
3. Reset the alarm using **POWER MODE** or **AIR** once the alarm condition has cleared if **LATCHING** is set to **ON** (factory setting) in Maintenance Mode.
4. Calibrate the GX-3R as described in “Chapter 5: User Mode and Calibration” on page 39.
5. If the over range condition continues or if you are not able to successfully calibrate the unit, you may need to replace the sensor that has triggered the over range alarm.
6. If the over range condition continues after you have replaced the sensor, contact RKI Instruments, Inc. for further instructions.

## Responding to Battery Alarms

**WARNING:** *The GX-3R is not operational as a gas monitoring device during a dead battery alarm. Take the Model GX-3R to a non-hazardous area and replace or recharge the batteries as described in “Recharging the Batteries” on page 74.*

The GX-3R is fully functional during a low battery warning. However, only a limited amount of operating time remains, approximately 1 - 2 hours. The amount of time depends on how often the LCD backlight is used and how often the unit is responding to alarm conditions. Recharge the battery as soon as possible as described in “Recharging the Batteries” on page 74.

---

**NOTE:** Alarms and the LCD back light consume battery power and reduce the amount of operating time remaining.

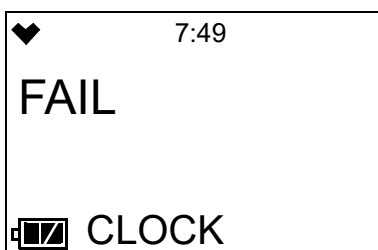
---

## Responding to Sensor Failure Alarms

1. Determine which sensor has triggered the sensor failure alarm.
2. Try calibrating the failed sensor, as described in “Chapter 5: User Mode and Calibration” on page 39 before replacing it.
3. If the sensor failure continues, replace the sensor as described in “Replacing a Sensor” on page 78.
4. If the sensor failure condition continues after you have replaced the sensor, contact RKI Instruments, Inc. for further instructions.

## Responding to Clock Failure Alarms

A clock failure alarm occurs if the unit’s internal clock malfunctions.



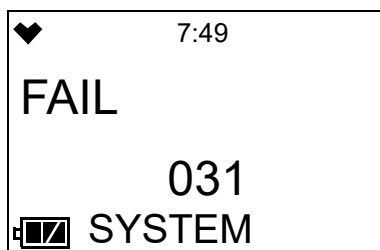
1. Press and release POWER MODE to continue into Measuring Mode.

**CAUTION:** *There will be no datalogging function if you operate the instrument after a clock failure.*

2. Attempt to set the date using the **DATE** menu item in User Mode. See “Setting the Date/Time (DATE)” on page 70.
3. If the date cannot be set correctly, contact RKI Instruments, Inc. as soon as possible.

## Responding to System Failure Alarms

1. If a system failure occurs, the system failure screen will display an error code as shown below:



2. The error code meanings are shown in the table below:

**Table 6: Error Code Explanation**

Error Code	Explanation
000	ROM failure
010	RAM failure
021	FRAM failure
031	FLASH memory failure
080	Acceleration sensor failure
081	PCB failure
082	Temperature sensor failure

3. If the error code is anything but 031 as shown above, the instrument cannot be used. Contact RKI Instruments, Inc. as soon as possible.

If the error code is 031, you may press and release POWER MODE to continue into Measuring Mode if the instrument must be used temporarily.

**CAUTION:** *There will be no datalogging function if you operate the instrument after a 031 system failure. Contact RKI Instruments, Inc. as soon as possible.*

---

## Data Logging

The GX-3R features the ability to log data to its internal memory and download it to a computer via the infrared communications port on the front of the unit. It logs gas readings in Measuring Mode, alarm data, and calibration data.

To utilize the GX-3R's downloading capability, you will need the GX-3R Data Logger Management Program and a computer with an infrared port or a USB port that runs one of the following operating systems: Windows 7, Windows 8, or Windows 10. If your computer has an infrared port, then no additional accessories are needed to download data from the GX-3R. If your computer does not have an infrared port but does have a USB port, a USB/IrDA adapter cable can be used to download data from the GX-3R using the USB port. The GX-3R Data Logger Management Program is available at [www.rkiinstruments.com/gx3r](http://www.rkiinstruments.com/gx3r). The USB/IrDA adapter cable is available from RKI Instruments, Inc.

The data logging capacity depends on how often the GX-3R stores data, how many channels are active, and how often the GX-3R is turned on and off. The table below illustrates how much data logging time is available for the various interval times. It assumes that the unit has the standard four sensors, is only turned on once, and there are no alarm occurrences. The data logging interval time must be set using the GX-3R Data Logger Management Program.

**Table 7: Data Logging Capacity**

<b>Interval Time</b>	<b>Data Logging Time</b>
10 seconds	10 hours
20 seconds	20 hours
30 seconds	30 hours
1 minute	60 hours
3 minutes	180 hours
5 minutes	300 hours
10 minutes	600 hours

For a complete description of the Data Logger Management Program and procedures for downloading data to a computer, see the GX-3R Data Logger Management Program Operator's Manual.

# Chapter 4: Display Mode

This section describes Display Mode which is accessible from Measuring Mode. See Table 8 below for a list of Display Mode's menu items, a short description of each item, and the page number for further description.

**Table 8: Display Mode Menu Items**

Display Mode Menu Item	Description
PEAK (pg.30)	Displays the Peak readings for each sensor.
STEL (pg.31)	Displays the STEL readings (CO and H <sub>2</sub> S only).
TWA (pg.31)	Displays the TWA readings (CO and H <sub>2</sub> S only).
LIST (pg.32) <sup>A</sup>	Change the target gas for the catalytic sensor. <ul style="list-style-type: none"> <li>• CH<sub>4</sub> (methane)</li> <li>• i-C<sub>4</sub>H<sub>10</sub> (isobutane)</li> <li>• H<sub>2</sub> (hydrogen)</li> <li>• CH<sub>3</sub>OH (methanol)</li> <li>• C<sub>2</sub>H<sub>2</sub> (acetylene)</li> <li>• C<sub>2</sub>H<sub>4</sub> (ethylene)</li> <li>• C<sub>2</sub>H<sub>6</sub> (ethane)</li> <li>• C<sub>2</sub>H<sub>5</sub>OH (ethanol)</li> <li>• C<sub>3</sub>H<sub>6</sub> (propylene)</li> <li>• C<sub>3</sub>H<sub>6</sub>O (acetone)</li> <li>• C<sub>3</sub>H<sub>8</sub> (propane)</li> <li>• C<sub>4</sub>H<sub>6</sub> (butyne)</li> <li>• C<sub>5</sub>H<sub>10</sub> (cyclopentane)</li> <li>• C<sub>6</sub>H<sub>6</sub> (benzene)</li> <li>• n-C<sub>6</sub>H<sub>14</sub> (hexane)</li> <li>• C<sub>7</sub>H<sub>8</sub> (toluene)</li> <li>• n-C<sub>7</sub>H<sub>16</sub> (heptane)</li> <li>• C<sub>8</sub>H<sub>10</sub> (xylene)</li> <li>• n-C<sub>9</sub>H<sub>20</sub> (nonane)</li> <li>• EtAc (ethyl acetate)</li> <li>• IPA (isopropyl alcohol)</li> <li>• MEK (methyl ethyl ketone)</li> <li>• MMA (methyl methacrylate)</li> <li>• DME (dimethyl ether)</li> <li>• MIBK (methyl isobutyl ketone)</li> <li>• THF (tetrahydrofuran)</li> </ul>
USER ID (pg.33) <sup>B</sup>	View and/or change the User ID.
STN ID (pg.34) <sup>B</sup>	View and/or change the Station ID.
CAL DATA (pg.35) <sup>C</sup>	Displays the last calibration date for each sensor.
BUMP DATA (pg.36) <sup>D</sup>	Displays the last bump test date for each sensor.
TEMP (pg.37)	Displays the current date, time, and temperature.
ALARM--PT (pg.37)	View alarm points
<p><sup>A</sup> Only appears if <b>DISP SET</b> is set to <b>ON</b> in User Mode (factory setting) and if CH<sub>4</sub> or i-C<sub>4</sub>H<sub>10</sub> is selected for the combustible gas in Gas Select Mode.</p> <p><sup>B</sup> Only appears if <b>DISP SET</b> is set to <b>ON</b> in User Mode (factory setting) <u>and</u> if <b>ID DISP</b> is set to <b>ON</b> in Maintenance Mode (factory setting is <b>OFF</b>).</p> <p><sup>C</sup> Only appears if <b>CAL RMDR</b> is set to <b>ON</b> in User Mode (factory setting).</p> <p><sup>D</sup> Only appears if <b>BUMP.RMDR</b> is set to <b>ON</b> in User Mode (factory setting is <b>OFF</b>).</p>	

---

## Tips for Using Display Mode

- To enter Display Mode and scroll from one menu item to the next or skip an item when a question is asked, press and release POWER MODE.
- To enter an item, press and release AIR.
- To change a flashing parameter, use AIR. To reverse the direction of movement in a list (ie. from down to up or vice versa):
  - a. Press and hold AIR.
  - b. Immediately press POWER MODE and then release both buttons.
- To exit from an entered-information screen and go back to the main menu, press and release POWER MODE.

---

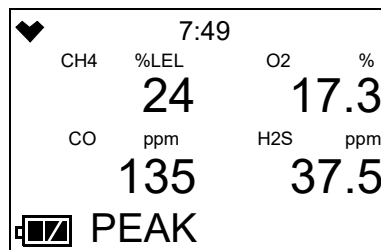
**NOTE:** Each screen displays for 20 seconds. If you do not press a button within 20 seconds, the GX-3R automatically returns to Measuring Mode.

---

## Peak Screen (PEAK)

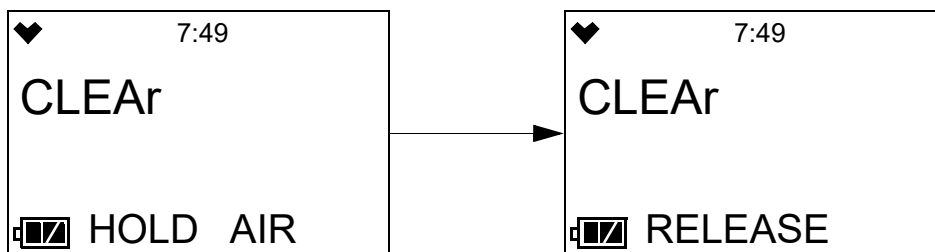
The peak screen displays the highest (lowest for oxygen) concentrations detected since the GX-3R was turned on. Peak readings are stored in the GX-3R's memory until a higher level is detected (lower for oxygen), the peak reading is cleared, or the GX-3R is turned off.

The lunch break feature enables the GX-3R to save peak readings when it is turned off so it can continue with the same peaks when it is turned on again. See "Turning On the GX-3R" on page 15.



To clear the peak readings, do the following:

1. After entering Display Mode, press and release POWER MODE until **PEAK** appears.
2. Press and hold AIR until the screen prompts you to release it.



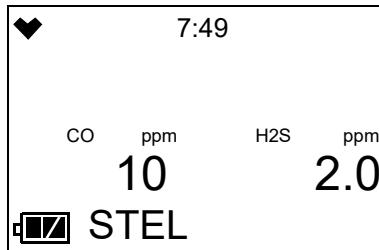
3. The peak readings will be reset and the unit will return to the Peak Screen.

If you do not want to clear the peak readings, release AIR before the above screen sequence occurs. The unit will return to the Peak Screen.

---

## STEL Screen (STEL)

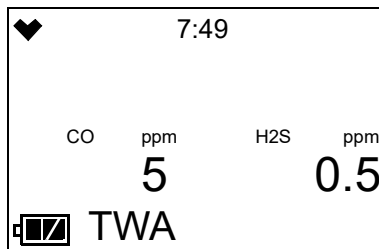
The STEL Screen displays the short term exposure limit (STEL) readings *for H<sub>2</sub>S and CO only*. The STEL reading is the average reading *over the last 15 minutes*.



---

## TWA Screen (TWA)

The TWA Screen displays the time weighted average (TWA) readings *for H<sub>2</sub>S and CO only*.



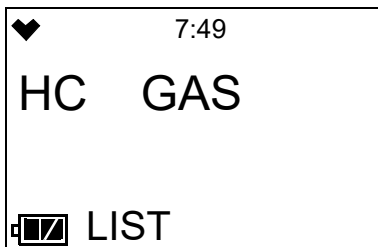
The TWA reading is the average reading *over the last 8 hours*. If 8 hours have not elapsed since the last time the TWA reading was cleared, the average is still calculated over 8 hours. The missing time is assigned a 0 value for readings. If **LUNCH** is set to **OFF** (factory setting), the TWA is cleared when the GX-3R is turned off.

If **LUNCH** is set to **ON**, the GX-3R will remember TWA readings when it is turned off so it can continue them when it is turned on again. See “Turning On the GX-3R” on page 15.

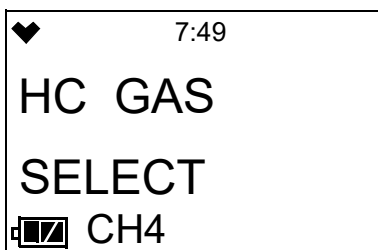
## Changing the Combustible Gas Sensor's Gas (LIST)

The **LIST** screen allows you to select the target gas for the combustible gas sensor. This screen only appears if **DISP SET** in User Mode is set to **ON** (factory setting) and if CH4 or iC4H10 is selected for the combustible channel in Gas Select Mode.

If you select a new target gas, the change is saved if you turn the instrument off and on.



1. After entering Display Mode, press and release POWER MODE until **LIST** appears.
2. Press and release AIR to enter the screen. The current gas will flash at the bottom of the screen.



3. Use AIR to scroll through the list of gases.

• CH4 (methane)	• C6H6 (benzene)
• i-C4H10 (isobutane)	• n-C6H14 (hexane)
• H2 (hydrogen)	• C7H8 (toluene)
• CH3OH (methanol)	• n-C7H16 (heptane)
• C2H2 (acetylene)	• C8H10 (xylene)
• C2H4 (ethylene)	• n-C9H20 (nonane)
• C2H6 (ethane)	• EtAc (ethyl acetate)
• C2H5OH (ethanol)	• IPA (isopropyl alcohol)
• C3H6 (propylene)	• MEK (methyl ethyl ketone)
• C3H6O (acetone)	• MMA (methyl methacrylate)
• C3H8 (propane)	• DME (dimethyl ether)
• C4H6 (butyne)	• MIBK (methyl isobutyl ketone)
• C5H10 (cyclopentane)	• THF (tetrahydrofuran)

4. When the desired gas is displayed, press and release POWER MODE. The changes are saved and the instrument returns to the **LIST** screen.
5. The gas formula displays at the bottom of the Measuring Mode screen. The gas selection remains selected if you turn the instrument off and on again.



## Changing the User ID (USER ID)

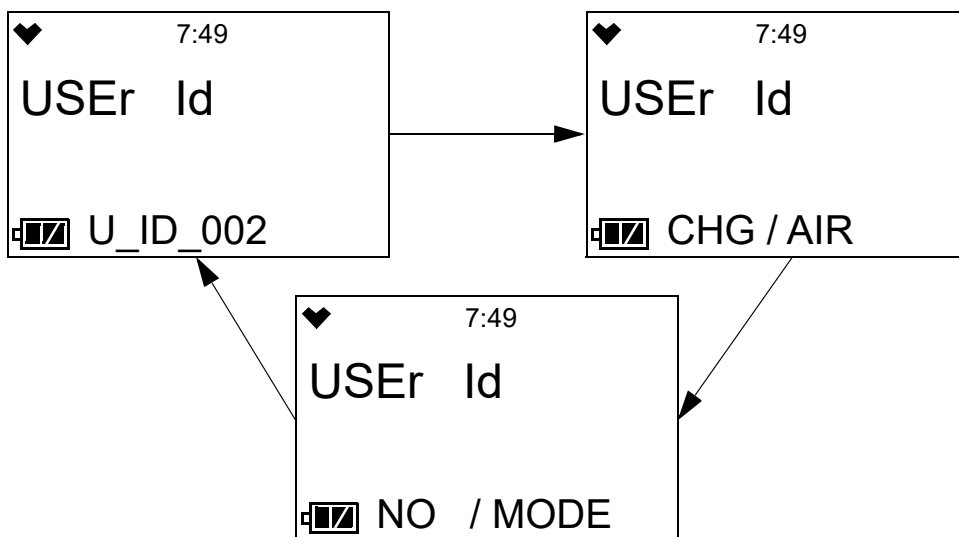
This screen only appears if **DISP SET** in User Mode is set to **ON** (factory setting) and if **ID DISP** in Maintenance Mode is set to **ON** (factory setting is **OFF**).

Use this screen to select a user ID from the 128 user IDs that are stored in the GX-3R's memory. Before a user ID is selected on a brand new instrument, the user ID is "-----". The factory-installed user IDs have a "U\_ID\_XXX" format.

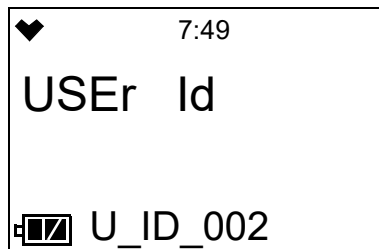
The user ID provides a way to identify the GX-3R user during a data logging session. If the user ID is changed during an operating session, a new data session is initiated with the new user ID attached to it.

User IDs can only be selected in this menu item. In order to edit the 128 user IDs, you must use the GX-3R Datalogging Program.

1. After entering Display Mode, press and release **POWER MODE** until the **USER ID** screen sequence appears.



2. To change the User ID, press and release **AIR**. The current User ID will flash.



3. Use **AIR** to scroll to the desired User ID. To reverse the scrolling direction:
  - a. Press and hold **AIR**.
  - b. Immediately press **POWER MODE** and then release both buttons.
4. Press and release **POWER MODE** to save the User ID and return to the **USER ID** screen in Display Mode.

## Changing the Station ID (STN ID)

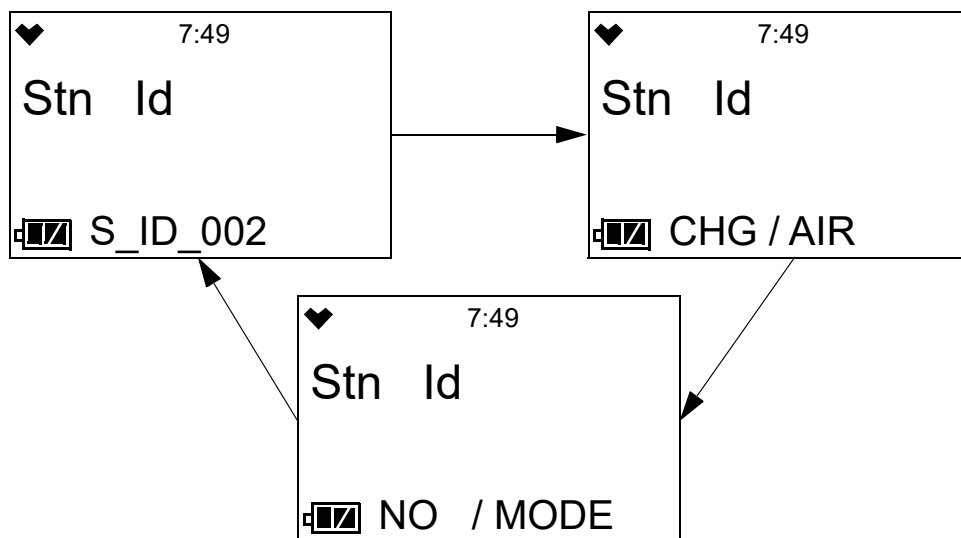
This screen only appears if **DISP.SET** in User Mode is set to **ON** (factory setting) and if **ID DISP** in Maintenance Mode is set to **ON** (factory setting is **OFF**).

Use this screen to select a station ID from the 128 station IDs that are stored in the GX-3R's memory. Before a station ID is selected on a brand new instrument, the station ID is "-----". The factory-installed station IDs have a "S\_ID\_XXX" format.

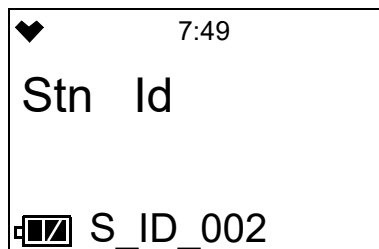
The station ID provides a way to identify the GX-3R location during a data logging session. If the station ID is changed during an operating session, a new data session is initiated with the new station ID attached to it.

User IDs can only be selected in this menu item. In order to edit the 128 user IDs, you must use the GX-3R Datalogging Program.

1. After entering Display Mode, press and release **POWER MODE** until the **STN ID** screen sequence appears.



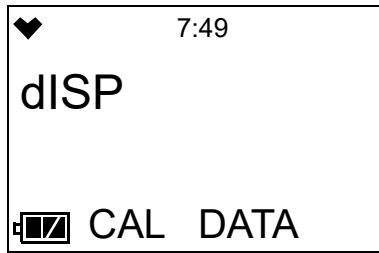
2. To change the Station ID, press and release **AIR**. The current Station ID will flash.



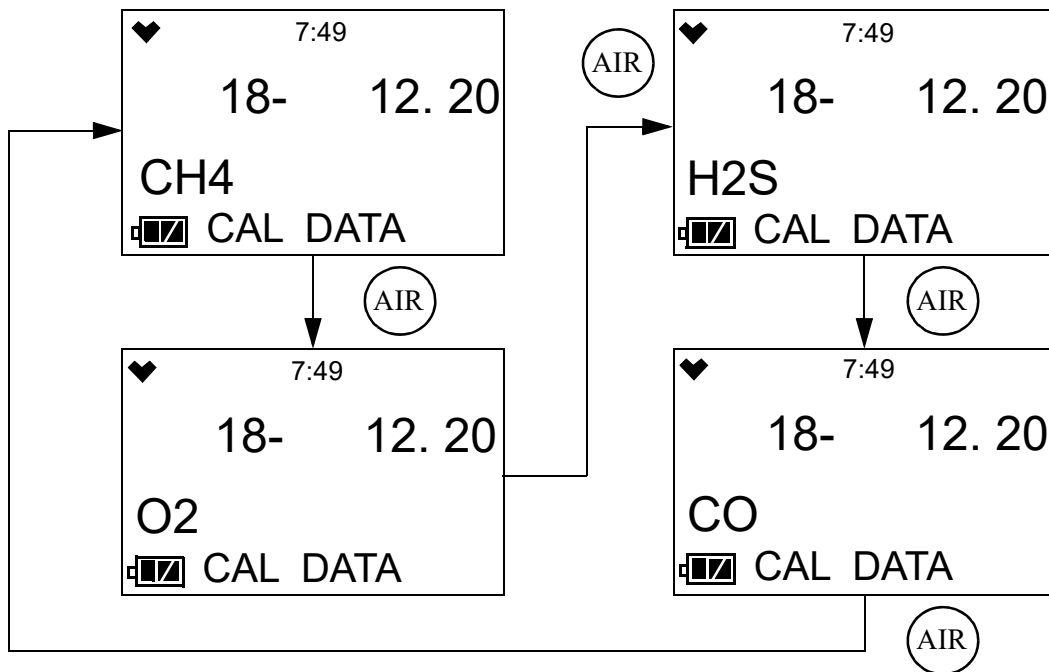
3. Use **AIR** to scroll to the desired Station ID. To reverse the scrolling direction:
  - a. Press and hold **AIR**.
  - b. Immediately press **POWER MODE** and then release both buttons.
4. Press and release **POWER MODE** to save the Station ID and return to the **STN ID** screen in Display Mode.

## Last Successful Calibration Date (CAL DATA)

The **CAL DATA** screen shows the date of the last successful calibration for each of the installed sensors. This screen only appears if **CAL.RMDR** is set to **ON**.



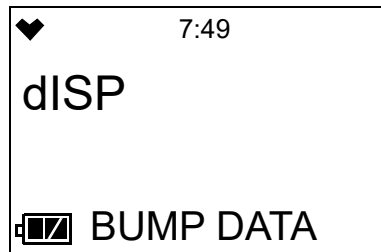
1. After entering Display Mode, press and release **POWER MODE** until **CAL DATA** appears.
2. Press **AIR** to enter the **CAL DATA** screen and to scroll through the installed sensors.



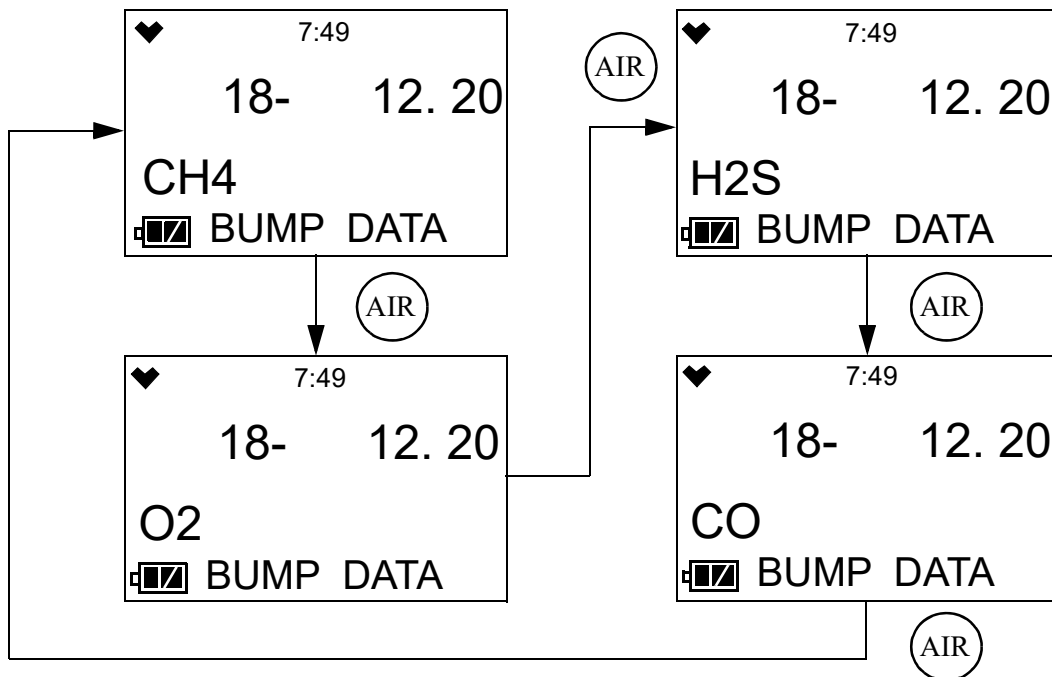
3. When you are done viewing the last calibration date for the sensors, press and release **POWER MODE** to return to the **CAL DATA** screen in Display Mode.

## Last Successful Bump Test Date (BUMP DATA)

The **BUMP DATA** screen shows the date of the last successful bump test for each of the installed sensors. This screen only appears if **BUMP.RMDR** is set to **ON**.



1. After entering Display Mode, press and release **POWER MODE** until **BUMP DATA** appears.
2. Press **AIR** to enter the **BUMP DATA** screen and to scroll through the installed sensors.

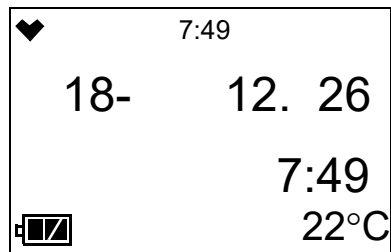


3. When you are done viewing the last bump test date for the sensors, press and release **POWER MODE** to return to the **BUMP DATA** screen in Display Mode.

---

## Date, Time, Temperature Screen (TEMP)

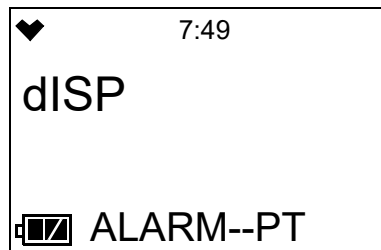
The **TEMP** screen shows the date and time of the instrument and the temperature of the surrounding area.



---

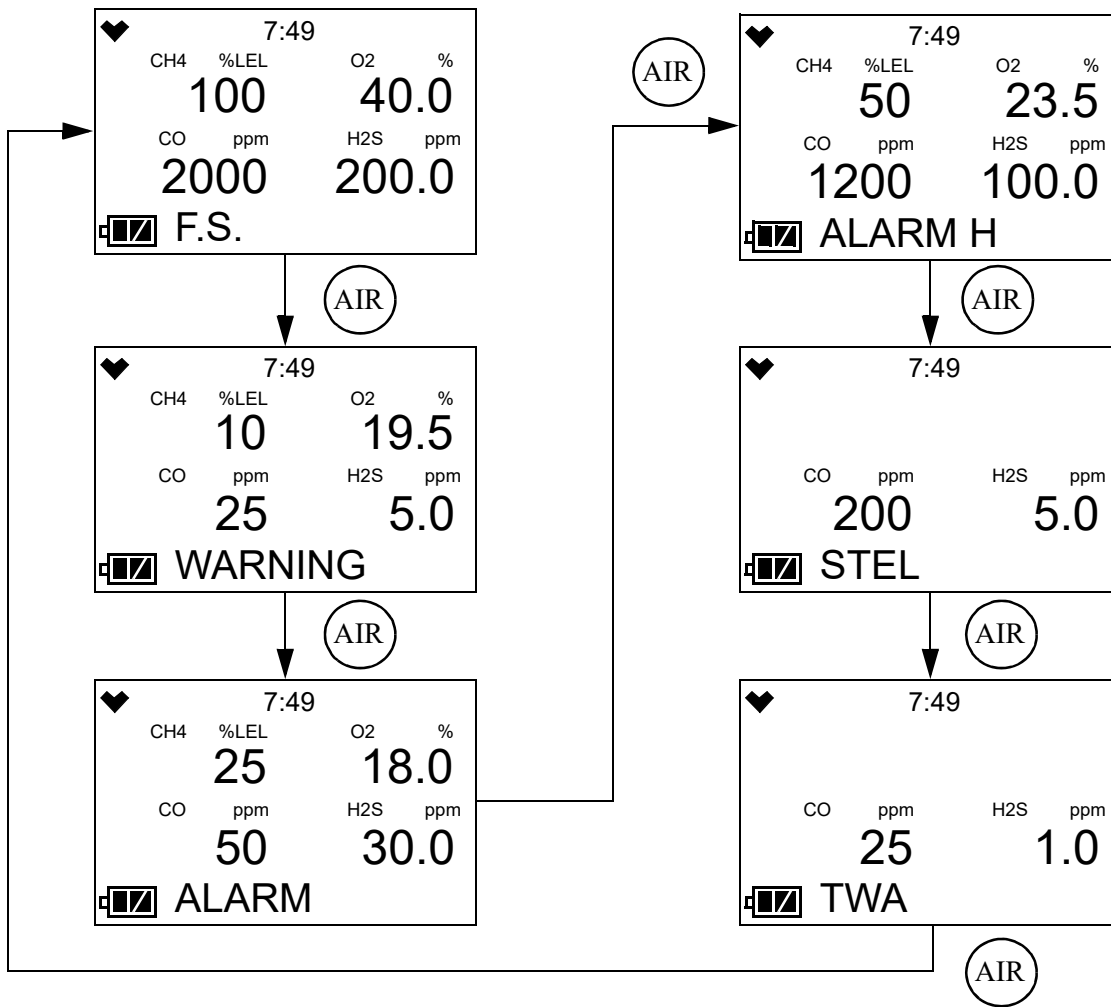
## Alarm Points Screen (ALARM--PT)

The Alarm Points Screen allows you to view the gas alarm settings for all active channels.



- 1 . After entering Display Mode, press and release **POWER MODE** until **ALARM--PT** appears.
- 2 . Press and release **AIR**. The Full Scale Settings screen will appear showing full scale settings for each channel.

3. Use AIR to scroll through the Warning, Alarm, Alarm H, STEL, and TWA settings.



4. Press and release POWER MODE to return to the Alarm Points Screen.

# Chapter 5: User Mode and Calibration

## Overview

This section describes the GX-3R in User Mode. See Table 9 below for a list of the items found in User Mode, the page that the menu item's instructions can be found on, and a short description of the menu item.

**Table 9: User Mode Menu Items**

User Mode Menu Item	Description			
BUMP (pg.43)	Perform a bump test.			
GAS CAL (pg.47)	Perform a fresh air adjustment, perform a span adjustment, change the calibration gas concentration, set the cylinder group.			
	AIR CAL (pg.47)	Perform a fresh air adjustment.		
	AUTO CAL (pg.48)	AUTO CAL CYL X	Perform an automatic span adjustment on the gases selected for Cylinder X (A-E cylinders available).	
		CAL-P	Set the calibration gas concentration for each gas.	
		CYL SEL	Assign a cylinder (A-E) to each gas (all 4 gases set to Cylinder A is the default). For single cal operation, you would assign each gas its own cylinder.	
	ESCAPE	Return to the <b>AUTO CAL</b> menu item.		
ESCAPE	Return to the <b>GAS CAL</b> menu item.			
CAL SET (pg.56)	Change parameters related to calibration.			
	CAL RMDR (pg.57)	<b>ON (factory setting):</b> The instrument will notify the user upon startup when a calibration is due. Notification type depends on <b>CAL EXPD</b> setting below. <b>OFF:</b> No notification upon startup when a calibration is due.		
	CAL INT (pg.57)	How often the instrument needs to be calibrated. Options: <b>1 - 1000</b> days (factory setting is <b>90</b> days)		
	CAL EXPD (pg.57)	Defines what action must be taken if a calibration is due upon startup. <b>CONFIRM (factory setting):</b> Press and release POWER MODE to acknowledge that calibration is due and continue to Measuring Mode. <b>CANT USE:</b> Cannot enter Measuring Mode until a successful calibration is performed. <b>NONE:</b> A screen indicates that calibration is due but warmup sequence continues.		
	ESCAPE	Return to the <b>CAL SET</b> menu item in User Mode.		

**Table 9: User Mode Menu Items**

User Mode Menu Item	Description		
BUMP SET (pg.58)	Change parameters related to bump testing.		
	SETTINGS (pg.59)	GAS TIME	How long gas is applied during a bump test. Choices: <b>30</b> (factory setting), <b>45</b> , <b>60</b> , <b>90</b> seconds
		CHECK	Percentage of calibration gas concentration that the bump test reading must be within in order to pass bump. Options: <b>10%</b> , <b>20%</b> , <b>30%</b> , <b>40%</b> , <b>50%</b> (factory setting)
		CAL TIME	How long gas is applied during a calibration. <b>GAS TIME</b> is deducted from this time. Options: <b>90</b> (factory setting) or <b>120</b> seconds
		AUTO CAL	<b>ON</b> (factory setting): If a bump test fails, a calibration is automatically started. <b>OFF</b> : If a bump test fails, a calibration is not automatically started.
		ESCAPE	Return to the <b>SETTINGS</b> menu item in <b>BUMP SET</b> .
	BUMP.RMDR (pg.61)	<b>ON</b> : The instrument will notify the user upon startup when a bump test is due. Notification type depends on <b>BUMP.EXPD</b> setting below. <b>OFF</b> (factory setting): No notification upon startup when a bump test is due.	
	BUMP INT (pg.61)	How often the instrument needs to be bump tested. Options: <b>0</b> - <b>30</b> days (factory setting is <b>30</b> days)	
BUMP.EXPD (pg.61)	Defines what action must be taken if a bump test is due upon startup. <b>CONFIRM</b> (factory setting): Press and release POWER MODE to acknowledge that bump test is due and continue to Measuring Mode. <b>CANT USE</b> : Cannot enter Measuring Mode until a successful bump test is performed. <b>NONE</b> : A screen indicates that bump test is due but warmup sequence continues.		
ESCAPE	Return to the <b>BUMP SET</b> menu item in User Mode.		
ALARM-PT (pg.62)	Set alarm points for all channels (WARNING, ALARM, ALARM H, STEL, TWA) or reset all alarms to their default settings.		
LUNCH (pg.65)	<b>ON</b> : Lunch break feature is on. Instrument will ask if you want to resume TWA and PEAK readings at startup. <b>OFF</b> (factory setting): Lunch break feature is off. Instrument resets TWA and PEAK readings every time it's turned on.		



**Table 9: User Mode Menu Items**

User Mode Menu Item	Description
BEEP (pg.66)	Set confirmation beep parameters.
	<p><b>BEEP SEL</b> (pg.66)</p> <p><b>LED:</b> LEDs will flash and instrument will vibrate based on interval defined in <b>BEEP INT</b> to confirm instrument is still operating.</p> <p><b>BUZZER:</b> Buzzer will sound and instrument will vibrate based on interval defined in <b>BEEP INT</b> to confirm instrument is still operating.</p> <p><b>LED+BUZZ:</b> LEDs will flash, buzzer will sound, and instrument will vibrate based on interval defined in <b>BEEP INT</b> to confirm instrument is still operating.</p> <p><b>BUMP/CAL:</b> LEDs flash based on interval defined in <b>BEEP INT</b> if bump test or calibration is due.</p> <p><b>ALM ALRT:</b> LEDs flash based on interval defined in <b>BEEP INT</b> if instrument goes into a gas alarm.</p> <p><b>B/C/ALM:</b> LEDs flash based on interval defined in <b>BEEP INT</b> if a) bump test is due, b) calibration is due, or c) instrument goes into a gas alarm.</p> <p><b>OFF (factory setting):</b> No alerts to confirm instrument is still operating or that a bump test or calibration is due.</p>
	<p><b>BEEP INT</b> (pg.67)</p> <p>Confirmation alert interval. Confirmation type defined in <b>BEEP SEL</b>. Options: <b>0.5</b> minute and <b>1</b> to <b>99</b> minutes in 1 minute increments. The factory setting is <b>5</b> minutes.</p>
	<p><b>ESCAPE</b></p> <p>Return to the <b>BEEP</b> menu item in User Mode.</p>
BL TIME (pg.68)	<p>How long the back light stays on after the last button press. Options: <b>0</b> - <b>255</b> seconds or <b>OFF</b>. The factory setting is <b>30</b> seconds.</p>
KEY TONE (pg.68)	<p><b>ON (factory setting):</b> Buzzer will sound when button is pressed.</p> <p><b>OFF:</b> Buzzer will not sound when button is pressed.</p>
DISP SET (pg.69)	<p><b>OFF:</b> <b>LIST</b>, <b>USER ID</b>, and <b>STN ID</b> screens do not appear in Display Mode.</p> <p><b>ON (factory setting):</b> <b>LIST</b> item appears in Display Mode. <b>USER ID</b> and <b>STN ID</b> screens appear if <b>ID DISP</b> in Maintenance Mode is also set to <b>ON</b>.</p>
ZERO SUP (pg.69)*	<p><b>ON (factory setting):</b> Not intended for field adjustment. The suppression values are:            Combustible Gas: 2% LEL            O<sub>2</sub>: 0.5% volume            H<sub>2</sub>S: 0.3 ppm            CO: 2 ppm</p>
ZERO.FLWR (pg.69)**	<p><b>ON (factory setting):</b> Not intended for field adjustment. Oxygen channel does not support zero follower functionality.</p>
DATE (pg.70)	<p>Set the instrument's date and time.</p>
PASSWORD (pg.70)	<p><b>ON:</b> A password is needed to access User Mode. Factory-set password is <b>0405</b>.</p> <p><b>OFF (factory setting):</b> No password is needed to access User Mode.</p>
ROM/SUM (pg.71)	<p>View the firmware information for the GX-3R's sensor board and main board.</p>
START (pg.72)	<p>Press and release POWER MODE to begin the warmup sequence and enter Measuring Mode.</p>

Table 9: User Mode Menu Items

User Mode Menu Item	Description
<p>* Only appears if <b>ZSUP.DISP</b> is set to <b>ON</b> in Maintenance Mode.  ** Only appears if <b>ZFLW.DISP</b> is set to <b>ON</b> in Maintenance Mode.</p>	

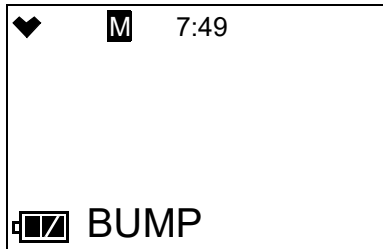
## Entering User Mode

**WARNING:** *The GX-3R is not in operation as a gas detector while in User Mode.*

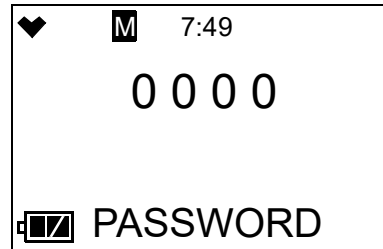
1. Take the GX-3R to a non-hazardous location and turn it off if it is on.
2. Press and hold AIR, then press and hold POWER MODE. When you hear a beep, release the buttons.
3. The screen that appears will depend on the setting of User Mode's **PASSWORD** item.

If **PASSWORD** is set to **OFF** (factory setting), continue with Step 6.

If **PASSWORD** is set to **ON**, continue with Step 4.

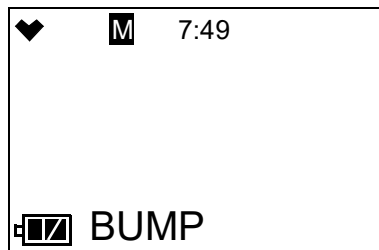


**PASSWORD** set to **OFF**



**PASSWORD** set to **ON**

4. If **PASSWORD** has been set to **ON** in User Mode, a password screen will appear. The first digit will be flashing.
5. Use AIR to select each password number then press POWER MODE to save it and move on to the next number. To go back a number, press and hold AIR and POWER MODE for a few seconds. To reverse the direction of change (ie. from increasing to decreasing or vice versa):
  - a. Press and hold AIR.
  - b. Immediately press POWER MODE and then release both buttons.
6. The **BUMP** menu item displays.



7. Use AIR to move through the User Mode menu items.

---

## Tips for Using User Mode

- To scroll from one menu item to the next, press and release AIR. To reverse the scrolling direction:
  - a. Press and hold AIR.
  - b. Immediately press POWER/MODE and then release both buttons.
  - c. The scrolling direction returns to the original direction when you exit and reenter a menu.
- To skip an item when a question is asked, press and release AIR.
- To enter an item and to save any changes, press and release POWER MODE.
- To change a flashing parameter, use AIR. To reverse the direction of change (ie. from increasing to decreasing or vice versa):
  - a. Press and hold AIR.
  - b. Immediately press POWER MODE and then release both buttons.
- To exit an entered menu item without saving a change, press and hold AIR and POWER MODE for a few seconds.

---

## Performing a Bump Test (BUMP)

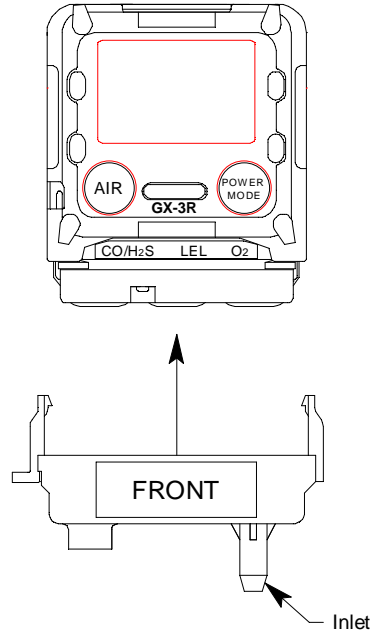
To bump test the GX-3R, you will need:

- Known calibrating samples of the gases being detected. The combustible and toxic gas samples should have concentrations between 10 and 50% of the full scale value. For example, if you are bump testing the combustible gas channel, your calibration cylinder should have a combustible gas concentration between 10% LEL and 50% LEL. An oxygen-free source, such as 100% nitrogen is recommended for setting the oxygen zero but a concentration of up to 19.5% is acceptable.

**CAUTION:** *Although the GX-3R can be bump tested with an oxygen concentration of up to 19.5%, RKI Instruments, Inc. recommends that a multi-gas cylinder have an oxygen concentration in the range of 10% - 16% oxygen.*

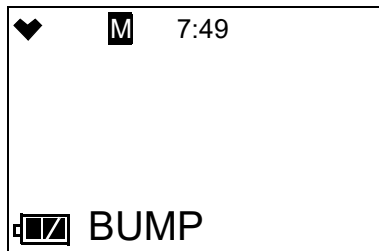
- 0.25 LPM fixed flow regulator
  - Non-absorbent tubing
  - Calibration cup
1. Confirm that the GX-3R's calibration gas values match the concentrations listed on the calibration gas cylinder(s) as described in "Setting the Calibration Values in CAL--P" on page 52.
  2. Confirm that your cylinder selections are appropriate as described in "Making Cylinder Selections in CYL SEL" on page 54.
  3. Confirm that the regulator knob is turned all the way clockwise. Screw the 0.25 LPM fixed flow regulator onto the calibration cylinder.

- Install the calibration cup onto the GX-3R. Use the label and imprinting to make sure that the calibration cup gets installed in the correct orientation relative to the GX-3R. Be sure the calibration cup is pushed on all the way.

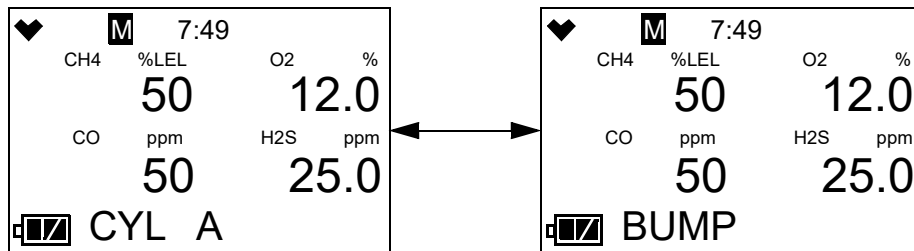


**Figure 5: Calibration Cup Installation**

- Use the tubing to connect the regulator to the inlet of the calibration cup.
- While in User Mode, press AIR to scroll to **BUMP**.



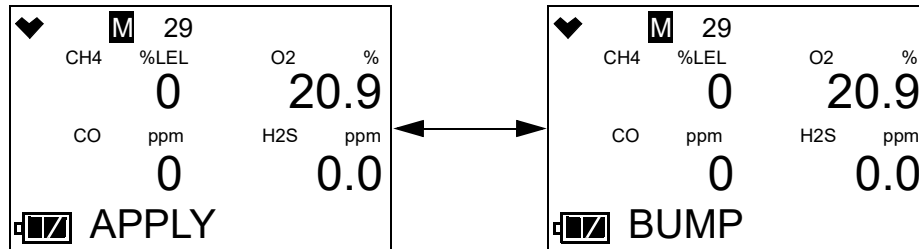
- Press and release POWER MODE. The display will show the gases assigned to Cylinder A and the assigned calibration values (see “Setting the Calibration Values in CAL--P” on page 52 if the calibration values do not match the calibration gas cylinder’s concentrations). The bottom of the screen will alternate between “CYL A” and “BUMP”.



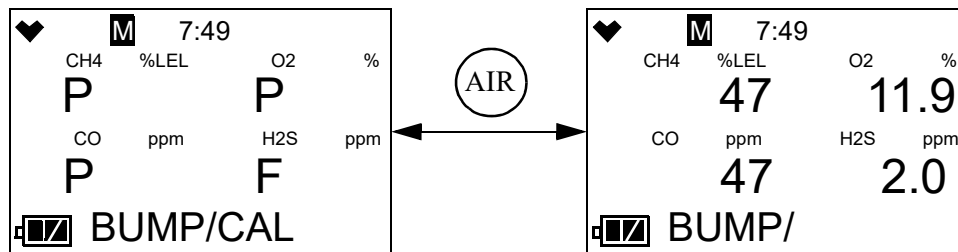
- If necessary, use AIR to scroll to the Auto Cal screen for the gas(es) you want to calibrate. As shipped from the factory, all gases are assigned to Cylinder A.

- 9 . Turn the regulator knob counterclockwise to open the regulator.
- 10 . Press and release POWER MODE.
- 11 . The gas readings will flash, the bottom of the screen will alternate between “APPLY” and “BUMP”, and the top of the screen will count down from the time set in **BUMP SET\SETTINGS\GAS TIME**.

To back out of the gas application screen without performing the bump test, press and release AIR and POWER MODE together.



- 12 . When the **BUMP SET\SETTINGS\A-CAL** User Mode item is set to:
  - a. **OFF**, continue to Step 13.
  - b. **ON**, continue to Step 14.
- 13 . When the **BUMP SET\SETTINGS\A-CAL** User Mode item is set to **OFF**:
  - a. When the countdown is done, the instrument will indicate which channels passed or failed the bump test with a P (pass) or an F (fail) underneath the gas name. You can scroll between the bump test results and the bump test gas readings by pressing and releasing AIR.

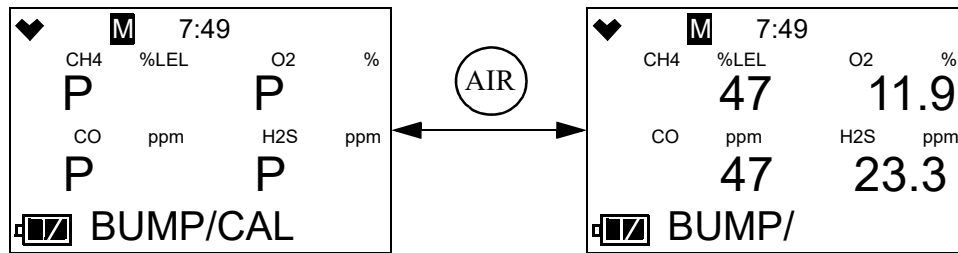


- b. To return to the **BUMP** menu item in User Mode, press and release POWER MODE.
- c. If any channel failed the bump test, the LEDs will flash and the buzzer will sound a double pulsing tone until you press and release POWER MODE to return to the **BUMP** menu item in User Mode. See “Troubleshooting” on page 73.
- d. Turn the regulator knob clockwise to close the regulator.
- e. Continue to Step 15.

14 . When the **BUMP SET\SETTINGS\A-CAL** User Mode item is set to **ON**:

**If all channels pass the bump test:**

- a. When the countdown is done, the results screen appears. You can scroll between the bump test results and the bump test gas readings by pressing and releasing AIR.

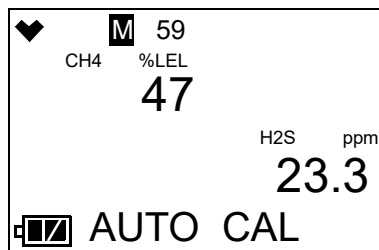


- b. To return to the **BUMP** menu item in User Mode, press and release POWER MODE.
- c. Turn the regulator knob clockwise to close the regulator.
- d. Continue to Step 15.

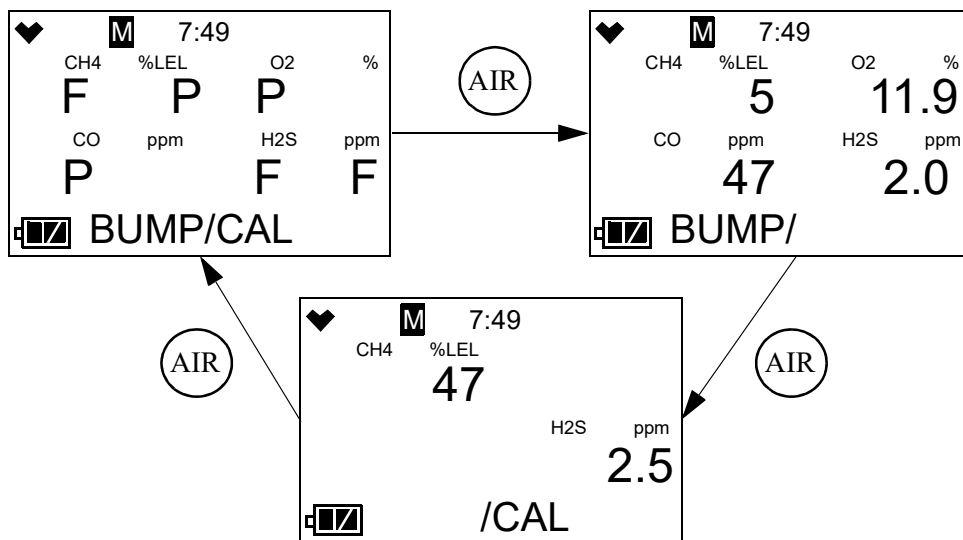
**If any channel fails the bump test:**

- a. A calibration is immediately and automatically started after the initial countdown. Continue to apply the calibration gas. **AUTO CAL** will appear at the bottom of the screen and a new countdown will appear at the top.

The calibration time counted down during a calibration initiated because of a failed bump test is the difference between the **GAS TIME** and the **CAL TIME** values defined in the **BUMP SET\SETTINGS** menu item in User Mode.



- b. At the end of the calibration, the instrument displays the results from both the bump test and the calibration. Use AIR to scroll between the calibration/bump test results, the bump test gas readings, and the calibration gas readings.



- c. To return to the **BUMP** menu item in User Mode, press and release POWER MODE.
- d. If any channel failed the calibration, the LEDs will flash and the buzzer will sound a double pulsing tone until you press and release POWER MODE to return to the **BUMP** menu item in User Mode. See “Troubleshooting” on page 73.
- e. Turn the regulator knob clockwise to close the regulator.
- f. Continue to Step 15.
- 15 . Unscrew the regulator from the calibration cylinder.
- 16 . If necessary, repeat Step 1 through Step 15 for additional cylinders.
- 17 . Remove the calibration cup from the GX-3R.
- 18 . Store the calibration kit in a safe and convenient place.

## Performing a Calibration (GAS CAL)

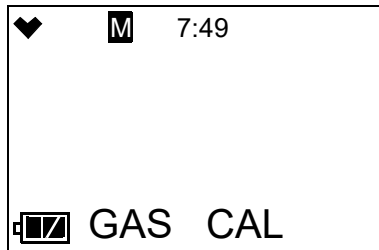
### Calibration Notes

- To fully calibrate the sensors, you must do a fresh air adjustment (**AIR CAL**) and a span adjustment (**AUTO CAL**).
- The optimum frequency of calibration depends heavily on how the GX-3R is used. Instruments used daily may need to be calibrated weekly or monthly, while instruments that are used only a few times a year may need to be calibrated before each use. Typical calibration frequencies range from monthly to quarterly.

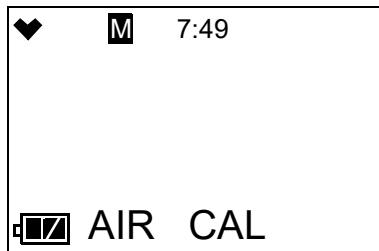
### AIR CAL

- 1 . Find a fresh air environment, an environment of normal oxygen content (20.9%) that is free of toxic and combustible gases.

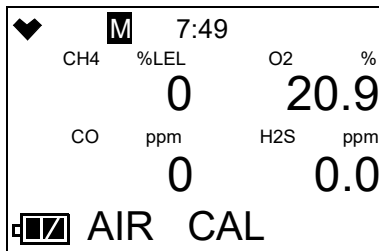
2. While in User Mode, press AIR to scroll to **GAS CAL**.



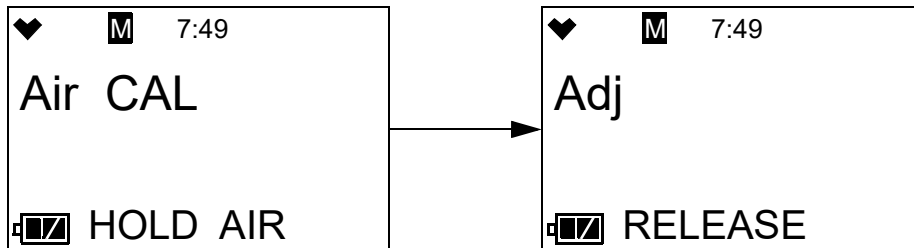
3. Press and release POWER MODE. The **AIR CAL** menu item appears.



4. Press and release POWER MODE to enter the **AIR CAL** menu.



5. Press and hold AIR until the screen prompts you to release it.



6. If the fresh air adjustment passes, the instrument returns to the **GAS CAL** menu.  
7. If the fresh air adjustment fails, “FAIL AIR” displays. Press and release POWER MODE to acknowledge the failure. See “Troubleshooting” on page 73.

## Performing a Span Adjustment in AUTO CAL

### *Preparing for a Span Adjustment*

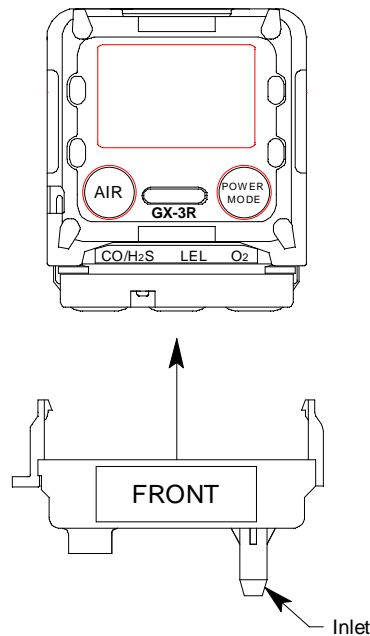
To adjust the span on the GX-3R, you will need:

- Known concentrations of the gases being detected. The combustible and toxic gas samples should have concentrations between 10 and 50% of the full scale value. For example, if you are calibrating the combustible gas channel, your calibration cylinder should have a combustible gas concentration between 10% LEL and 50% LEL. An oxygen-free source, such as 100% nitrogen is recommended for setting the oxygen zero but a concentration of up to 19.5% is acceptable.



**CAUTION:** Although the GX-3R can be calibrated with an oxygen concentration of up to 19.5%, RKI Instruments, Inc. recommends that a multi-gas cylinder have an oxygen concentration in the range of 10% - 16% oxygen.

- 0.25 LPM fixed flow regulator
  - Non-absorbent tubing
  - Calibration cup
1. Confirm that the GX-3R's calibration gas values match the concentrations listed on the calibration gas cylinder(s) as described in "Setting the Calibration Values in CAL--P" on page 52.
  2. Confirm that your cylinder selections are appropriate as described in "Making Cylinder Selections in CYL SEL" on page 54.
  3. Confirm that the regulator knob is turned all the way clockwise. Screw the 0.25 LPM fixed flow regulator onto the calibration cylinder.
  4. Install the calibration cup onto the GX-3R. Use the label and imprinting to make sure that the calibration cup gets installed in the correct orientation relative to the GX-3R. Be sure the calibration cup is pushed on all the way.

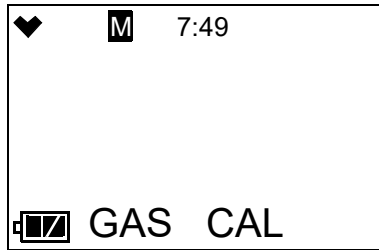


**Figure 6: Calibration Cup Installation**

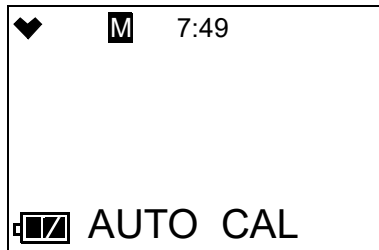
5. Use the tubing to connect the regulator to the inlet of the calibration cup.

## Performing a Span Adjustment

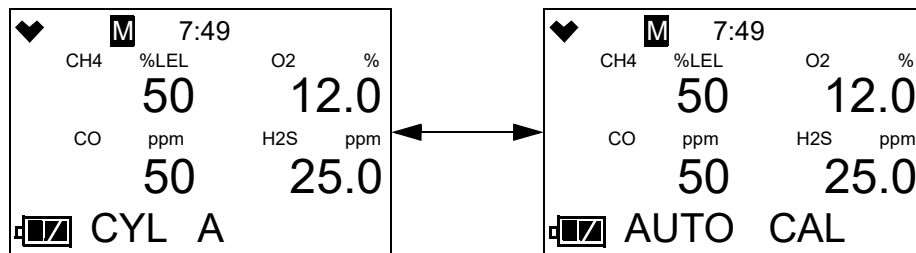
1. While in User Mode, press AIR to scroll to **GAS CAL**.



2. Press and release POWER MODE. The **AIR CAL** menu item appears.
3. Use AIR to scroll to the **AUTO CAL** menu item.

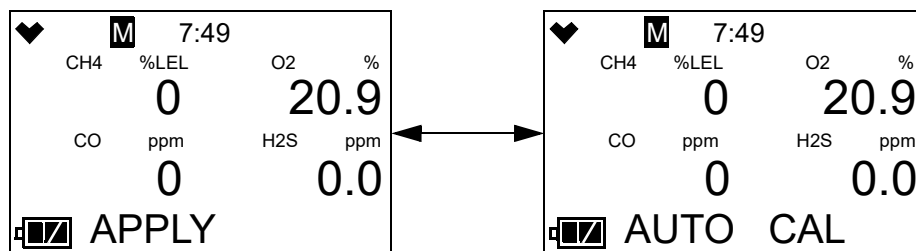


4. Press and release POWER MODE. The display will show the gases assigned to Cylinder A and the assigned calibration values (see “Setting the Calibration Values in CAL--P” on page 52 if the calibration values do not match the calibration gas cylinder’s concentrations). The bottom of the screen will alternate between “CYLA” and “AUTO CAL”.



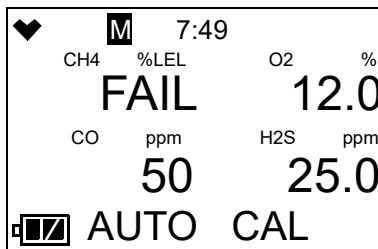
5. If necessary, use AIR to scroll to the Auto Cal screen for the gas(es) you want to calibrate. As shipped from the factory, all gases are assigned to Cylinder A.
6. Press and release POWER MODE.
7. The gas readings will flash and the bottom of the screen will alternate between “APPLY” and “AUTO CAL”.

To back out of the gas application screen without performing the bump test, press and release AIR and POWER MODE together.



8. Turn the regulator knob counterclockwise to open the regulator.
9. Allow the gas to flow for 2 minutes.

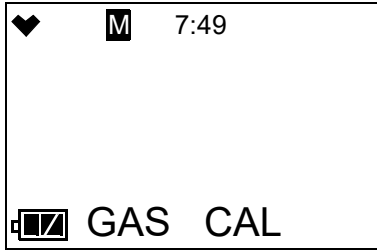
- 10 . Press and release POWER MODE.
- 11 . Turn the regulator knob clockwise to close the regulator.
- 12 . If the calibration passed:
  - a. The screen says “PASS”, shows the current gas readings, and the instrument returns to the **AUTO CAL** menu item.
  - b. If **MAX SPAN** is set to **ON** in Gas Select Mode (see “Turning Calibration Max Span On/Off (MAX SPAN)” on page 102), then before returning to the **AUTO CAL** menu item, the instrument will indicate the maximum possible adjustment it could have made to the response reading. So if the combustible gas channel was calibrated with 50% LEL gas and the maximum indicated span is 95% LEL, this means that there was enough adjustment left on that channel to set the reading to 95% LEL when the detector was exposed to 50% LEL gas. If the maximum span value is close to the calibration gas value, for example if it is 53% LEL when exposed to 50% LEL gas, the sensor should be replaced soon. The upper limit on the maximum adjustment indicated for all channels except for oxygen is either twice the calibration value or full scale, whichever is lower. The upper limit on the maximum adjustment indicated for the oxygen channel is 25.0% volume.
- 13 . If the calibration failed:
  - a. “FAIL” will replace the gas reading for the failed sensors.



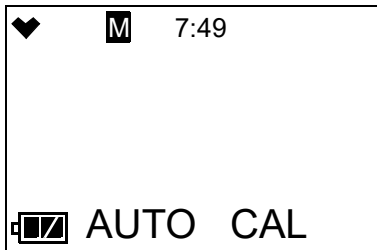
- b. The LEDs will flash and the buzzer will sound a double pulsing tone.
  - c. Press and release POWER MODE to clear the failure. The instrument returns to the **AUTO CAL** menu item in the **GAS CAL** menu.
  - d. See “Troubleshooting” on page 73.
- 14 . Unscrew the regulator from the calibration cylinder.
- 15 . If necessary, repeat Step 1 though Step 14 for additional cylinders.
- 16 . Remove the calibration cup from the GX-3R.
- 17 . Store the calibration kit in a safe and convenient place.
- 18 . See “Exiting the GAS CAL Menu” on page 56 to return to the User Mode menu.

## Setting the Calibration Values in CAL--P

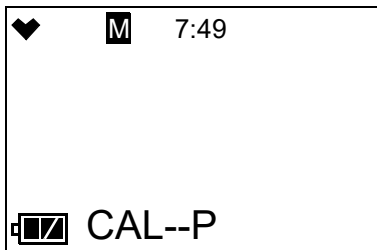
1. While in User Mode, press AIR to scroll to **GAS CAL**.



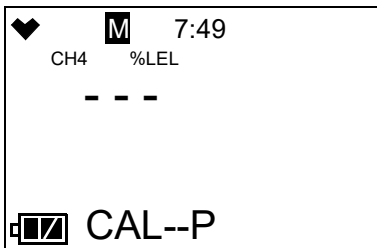
2. Press and release POWER MODE. The **AIR CAL** menu item appears.
3. Use AIR to scroll to the **AUTO CAL** menu item.



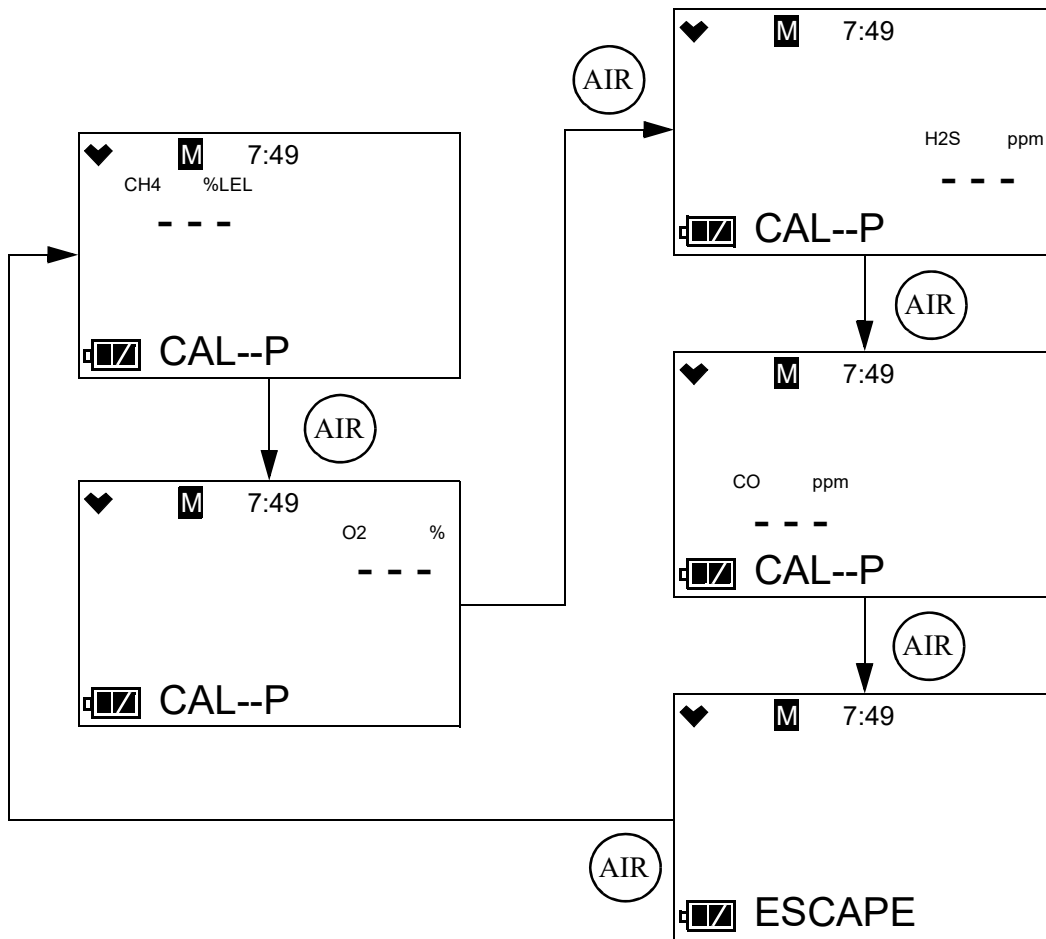
4. Press and release POWER MODE. The Auto Cal screen for gases assigned to Cylinder A will display.
5. Use AIR to scroll to **CAL--P**.



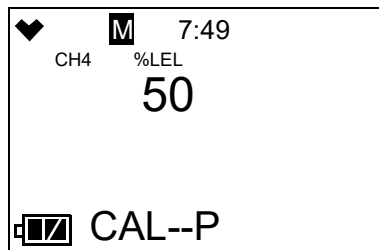
6. Press and release POWER MODE. The combustible gas channel will display.



7. Use AIR to scroll to the channel whose calibration gas value you want to change.



8. Press and release POWER MODE. The calibration value will begin to flash. In the example below, the combustible gas channel is selected.



9. Use AIR to adjust the calibration gas value. The calibration gas value in the instrument must match the value listed on the calibration gas cylinder you are using for that channel.

---

**NOTE:** If you are using an RKI 4-gas cylinder, be sure to set the O<sub>2</sub> channel to 12%, not 0%.

---

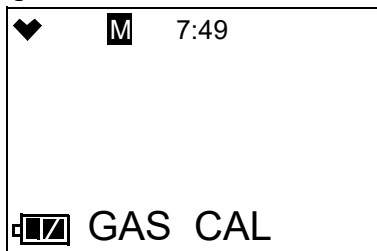
10. Press and release POWER MODE to save the change. The calibration gas value stops flashing and the unit returns to the channel selection screen.
11. Repeat Step 7 through Step 10 for any other channels that need to be changed.
12. Use AIR to scroll to **ESCAPE**.

- 13 . Press and release **POWER MODE**. The instrument will return to the **CAL--P** menu item in the Auto Cal Menu.
- 14 . Press **AIR** to scroll to **ESCAPE**.
- 15 . Press and release **POWER MODE**. The instrument will return to the **AUTO CAL** menu item in the **GAS CAL** Menu.
- 16 . See “Exiting the GAS CAL Menu” on page 56 to return to the User Mode menu.

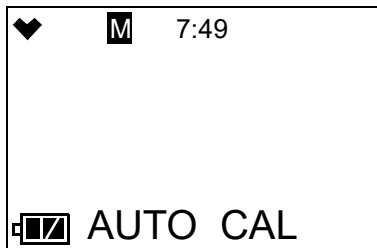
## Making Cylinder Selections in **CYL SEL**

The **CYL SEL** menu item allows you to group channels together for calibration. As shipped from the factory, all channels are assigned to Cylinder A which means all channels are calibrated at the same time. There are 5 cylinder assignments available: A, B, C, D, and E. If you wanted to calibrate each channel separately, you need to assign each channel to a different cylinder (ie. Cylinder A: combustible gas, Cylinder B: O<sub>2</sub>, Cylinder C: H<sub>2</sub>S, Cylinder D: CO).

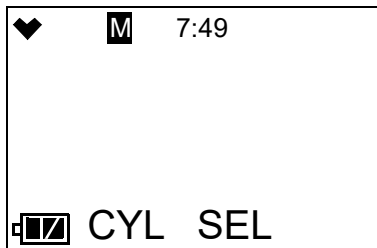
- 1 . While in User Mode, press **AIR** to scroll to **GAS CAL**.



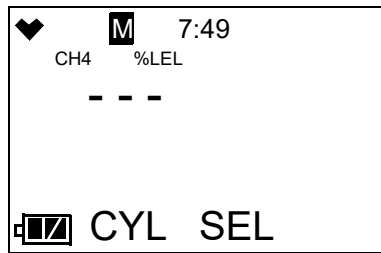
- 2 . Press and release **POWER MODE**. The **AIR CAL** menu item appears.
- 3 . Use **AIR** to scroll to the **AUTO CAL** menu item.



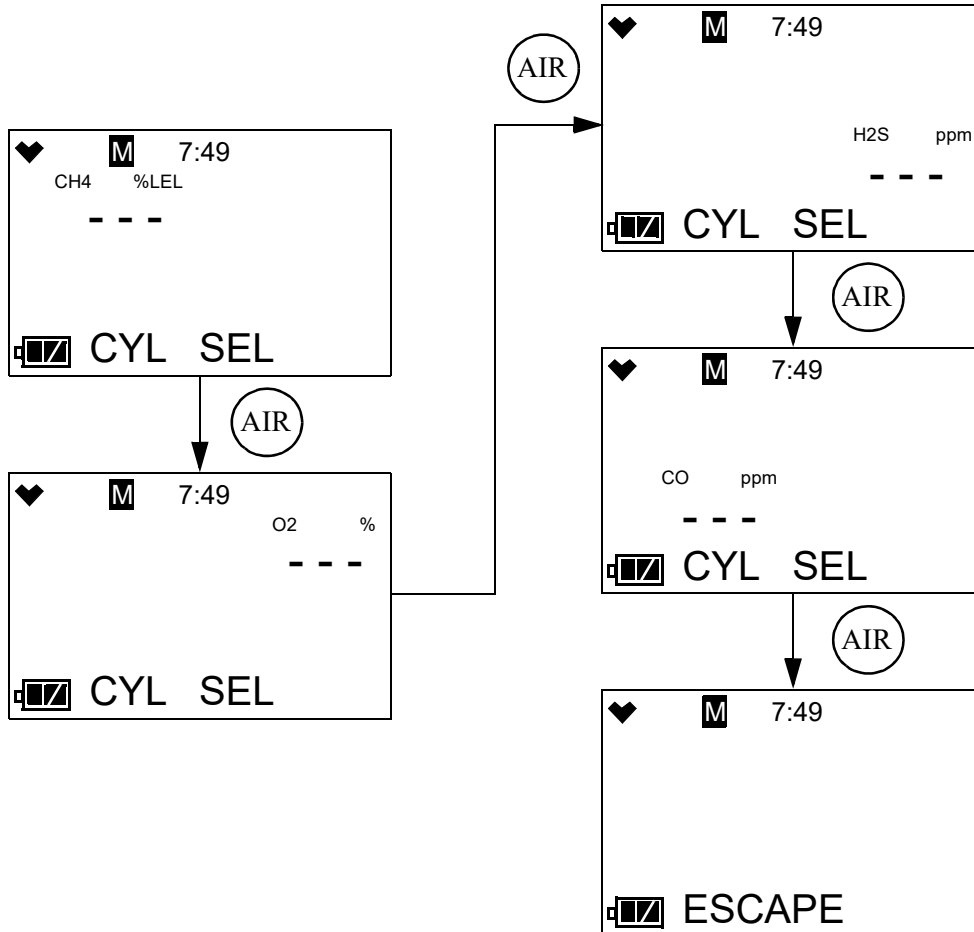
- 4 . Press and release **POWER MODE**. The Auto Cal screen for gases assigned to Cylinder A will display.
- 5 . Use **AIR** to scroll to **CYL SEL**.



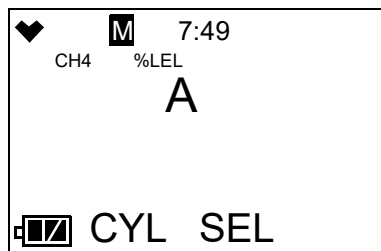
6. Press and release POWER MODE. The combustible gas channel will display.



7. Use AIR to scroll to the channel whose cylinder assignment you want to change.



8. Press and release POWER MODE. The current setting will flash. In the example below, the combustible gas channel is selected.



9. Use AIR to change the cylinder assignment. The choices are A, B, C, D, and E.

- 10 . Press and release **POWER MODE** to save the change. The cylinder assignment stops flashing and the unit returns to the channel selection screen.
- 11 . Repeat Step 7 through Step 10 for any other channels that need to be changed.
- 12 . Use **AIR** to scroll to **ESCAPE**.
- 13 . Press and release **POWER MODE**. The instrument will return to the **CYL SEL** menu item in the **Auto Cal Menu**.
- 14 . Press **AIR** to scroll to **ESCAPE**.
- 15 . Press and release **POWER MODE**. The instrument will return to the **AUTO CAL** menu item in the **GAS CAL** menu.
- 16 . See “Exiting the **GAS CAL** Menu” below to return to the **User Mode** menu.

### Exiting the **GAS CAL** Menu

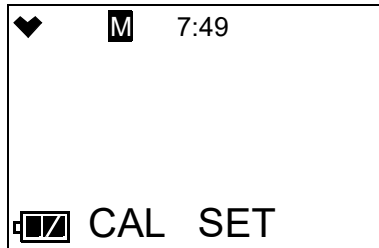
- 1 . While in the **GAS CAL** menu, press **AIR** to scroll to **ESCAPE**.
- 2 . Press and release **POWER MODE**. The instrument will return to the **GAS CAL** menu item in **User Mode**.

---

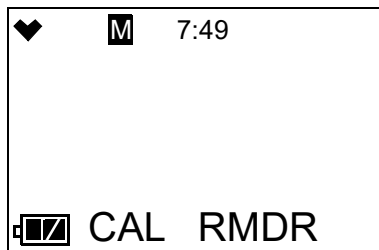
## Setting Calibration Parameters (**CAL SET**)

The **CAL SET** menu item has 4 menu items: **CAL RMDR**, **CAL INT**, **CAL EXPD**, and **ESCAPE**.

- 1 . While in **User Mode**, press **AIR** to scroll to **CAL SET**.



- 2 . Press and release **POWER MODE**. The **CAL RMDR** menu item appears.



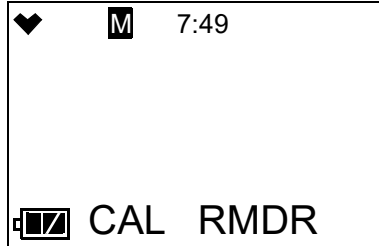


## CAL RMDR

**ON (factory setting):** The GX-3R will give an indication at start up if it is due for calibration. The type of indication will depend on the **CAL EXPD** setting (see “CAL EXPD” on page 57).

**OFF:** The GX-3R will not give an indication at start up if it is due for calibration.

1. After entering the **CAL SET** menu, press AIR to scroll to **CAL RMDR**.

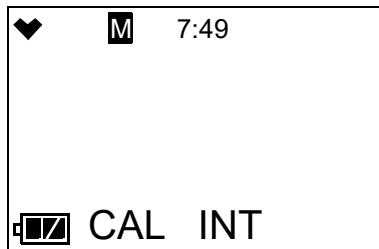


2. Press and release POWER MODE. The current setting flashes.
3. Use AIR to display the desired setting.
4. Press and release POWER MODE to save the setting. The **CAL RMDR** menu item will be displayed.

## CAL INT

This setting defines the amount of time between calibrations. The time can be set in 1 day increments. The minimum setting is 1 day and the maximum setting is 1000 days. The factory setting is 90 days.

1. After entering the **CAL SET** menu, press AIR to scroll to **CAL INT**.



2. Press and release POWER MODE. The current setting flashes.
3. Use AIR to display the desired setting.
4. Press and release POWER MODE to save the setting. The **CAL INT** menu item will be displayed.

## CAL EXPD

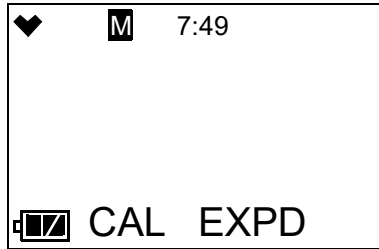
This item defines what indication is given during start up when calibration is due and **CAL RMDR** is set to **ON**.

**CONFIRM (factory setting):** The GX-3R will give an indication at start up if calibration is past due and will require the user to decide whether to perform a calibration or continue and use the GX-3R without calibrating. Press and release AIR to continue without calibrating or press and release POWER MODE to perform a calibration.

**CANT USE:** If the unit is due for calibration, the GX-3R will give an indication at start up that calibration is past due and will prompt you to press and release POWER MODE to enter User Mode and perform a calibration. Pressing AIR will have no effect. A successful calibration must be performed in order to use the instrument.

**NONE:** The GX-3R will give an indication at startup that calibration is past due. If desired, POWER MODE can be pressed to perform a calibration but it is not necessary to acknowledge the calibration due indication. The warm-up sequence will continue on its own.

1. After entering the **CAL SET** menu, press AIR to scroll to **CAL EXPD**.



2. Press and release POWER MODE. The current setting flashes.
3. Use AIR to display the desired setting.
4. Press and release POWER MODE to save the setting. The **CAL EXPD** menu item will be displayed.

### Exiting the **CAL SET** Menu

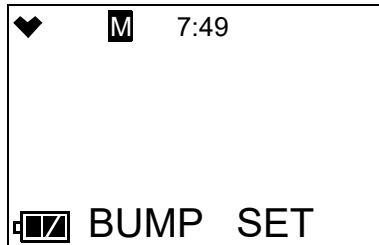
1. While in the **CAL SET** menu, press AIR to scroll to **ESCAPE**.
2. Press and release POWER MODE. The instrument will return to the **CAL SET** menu item in User Mode.

---

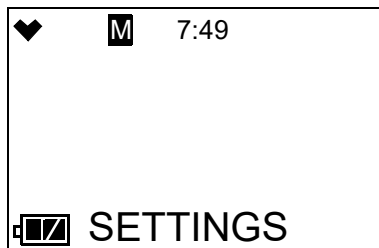
## Setting Bump Test Parameters (**BUMP SET**)

The **BUMP SET** menu item has 5 menu items: **SETTINGS**, **BUMP.RMDR**, **BUMP INT**, **BUMP.EXPD**, and **ESCAPE**.

1. While in User Mode, press AIR to scroll to **BUMP SET**.



2. Press and release POWER MODE. The **SETTINGS** menu item appears.



## SETTINGS

The **SETTINGS** menu item has 5 menu items: **GAS TIME**, **CHECK**, **CAL TIME**, **AUTO CAL**, and **ESCAPE**.

1. After entering the **BUMP SET** menu, press **AIR** to scroll to **SETTINGS**.

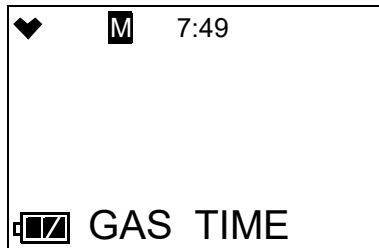


2. Press and release **POWER MODE**. The **GAS TIME** menu item appears.

### **GAS TIME**

The **GAS TIME** is the amount of time that the instrument is exposed to gas during a bump test. The available choices are **30** seconds (factory setting), **45** seconds, **60** seconds, and **90** seconds.

1. After entering the **SETTINGS** menu, press **AIR** to scroll to **GAS TIME**.

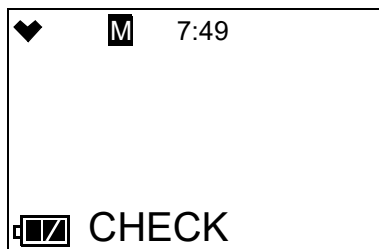


2. Press and release **POWER MODE**. The current setting flashes.
3. Use **AIR** to display the desired setting.
4. Press and release **POWER MODE** to save the setting. The **GAS TIME** menu item will be displayed.

### **CHECK**

**CHECK** is the bump test tolerance value and is represented as a percentage of the calibration gas concentration. It is the percentage that the bump test reading can differ from the actual gas concentration and still be considered a passed bump test. If the bump test reading differs more, the bump test will fail. The available values are **10%**, **20%**, **30%**, **40%**, and **50%** (factory setting).

1. After entering the **SETTINGS** menu, press **AIR** to scroll to **CHECK**.



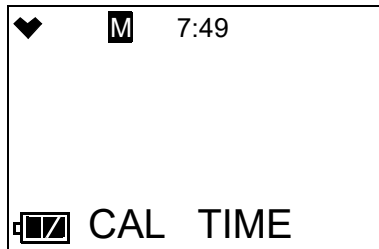
2. Press and release **POWER MODE**. The current setting flashes.
3. Use **AIR** to display the desired setting.

4. Press and release **POWER MODE** to save the setting. The **CHECK** menu item will be displayed.

### **CAL TIME**

The **CAL TIME** is the total time the instrument is exposed to calibration gas when a bump test fails if **AUTO CAL** is set to **ON**. The bump test time is deducted from the calibration time. For example, if the **CAL TIME** is set to 90 seconds and the **GAS TIME** is set to 30 seconds, if the bump test fails, the GX-3R will only be exposed to gas for an additional 60 seconds. The available values are **90** seconds (factory setting), and **120** seconds.

1. After entering the **SETTINGS** menu, press **AIR** to scroll to **CAL TIME**.



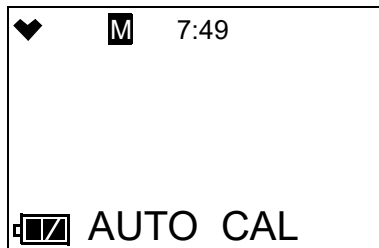
2. Press and release **POWER MODE**. The current setting flashes.
3. Use **AIR** to display the desired setting.
4. Press and release **POWER MODE** to save the setting. The **CAL TIME** menu item will be displayed.

### **AUTO CAL**

**ON** (factory setting): If a bump test fails, the unit will automatically begin a calibration.

**OFF**: If a bump test fails, the unit will not automatically begin a calibration.

1. After entering the **SETTINGS** menu, press **AIR** to scroll to **AUTO CAL**.



2. Press and release **POWER MODE**. The current setting flashes.
3. Use **AIR** to display the desired setting.
4. Press and release **POWER MODE** to save the setting. The **AUTO CAL** menu item will be displayed.

### **Exiting the SETTINGS Menu**

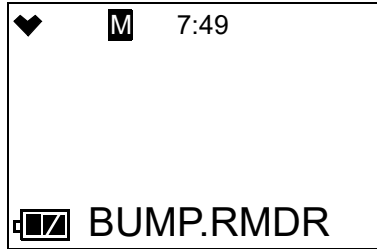
1. While in the **SETTINGS** menu, press **AIR** to scroll to **ESCAPE**.
2. Press and release **POWER MODE**. The instrument will return to the **SETTINGS** menu item of the **BUMP SET** menu.

## BUMP.RMDR

**ON:** The GX-3R will give an indication at start up if it is due for bump testing. The type of indication will depend on the **BUMP.EXPD** setting (see “BUMP.EXPD” on page 61).

**OFF (factory setting):** The GX-3R will not give an indication at start up if it is due for bump testing.

1. After entering the **BUMP SET** menu, press AIR to scroll to **BUMP.RMDR**.

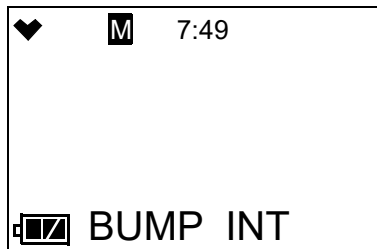


2. Press and release POWER MODE. The current setting flashes.
3. Use AIR to display the desired setting.
4. Press and release POWER MODE to save the setting. The **BUMP.RMDR** menu item will be displayed.

## BUMP INT

This setting defines the amount of time between bump tests. The time can be set in 1 day increments. The minimum setting is **0** days and the maximum setting is **30** days (factory setting).

1. After entering the **BUMP SET** menu, press AIR to scroll to **BUMP INT**.



2. Press and release POWER MODE. The current setting flashes.
3. Use AIR to display the desired setting.
4. Press and release POWER MODE to save the setting. The **BUMP INT** menu item will be displayed.

## BUMP.EXPD

This item defines what indication is given during start up when a bump test is due and **BUMP.RMDR** is set to **ON**.

**CONFIRM (factory setting):** The GX-3R will give an indication at start up if a bump test is past due and will require the user to decide whether to perform a bump test or continue and use the GX-3R without bump testing. Press and release AIR to continue without bump testing or press and release POWER MODE to perform a bump test.

**CANT USE:** If the unit is due for bump testing, the GX-3R will give an indication at start up that a bump test is past due and will prompt you to press and release POWER MODE to enter User Mode and perform a bump test. Pressing AIR will have no effect. A successful bump test must be performed in order to use the instrument.

**NONE:** The GX-3R will give an indication at startup that a bump test is past due. If desired, POWER MODE can be pressed to perform a bump test but it is not necessary to acknowledge the bump test due indication. The warm-up sequence will continue on its own.

1. After entering the **BUMP SET** menu, press AIR to scroll to **BUMP.EXPD**.



2. Press and release POWER MODE. The current setting flashes.
3. Use AIR to display the desired setting.
4. Press and release POWER MODE to save the setting. The **BUMP.EXPD** menu item will be displayed.

### Exiting the BUMP SET Menu

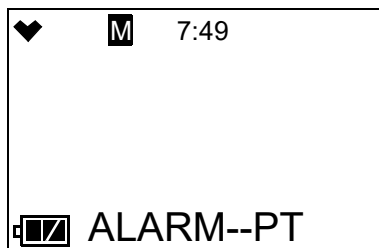
1. While in the **BUMP SET** menu, press AIR to scroll to **ESCAPE**.
2. Press and release POWER MODE. The instrument will return to the **BUMP SET** menu item in User Mode.

---

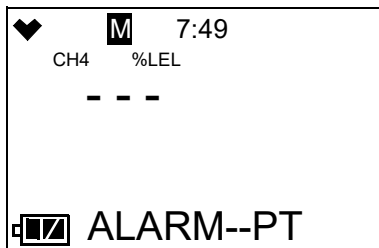
## Alarm Settings (ALARM--PT)

The **ALARM--PT** menu item has 3 menu items: **ALARM--PT**, **DEF--ALMP**, and **ESCAPE**.

1. While in User Mode, press AIR to scroll to **ALARM--PT**.

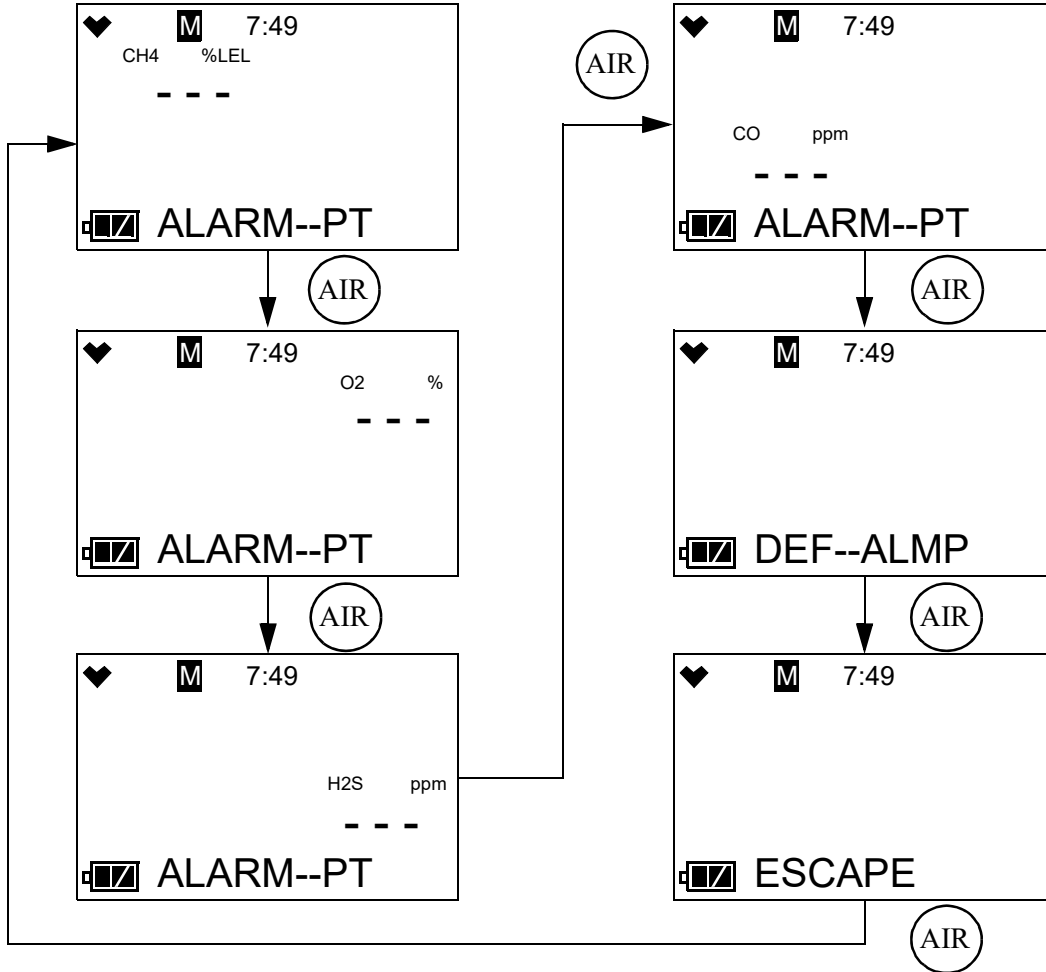


2. Press and release POWER MODE. The first channel is displayed.



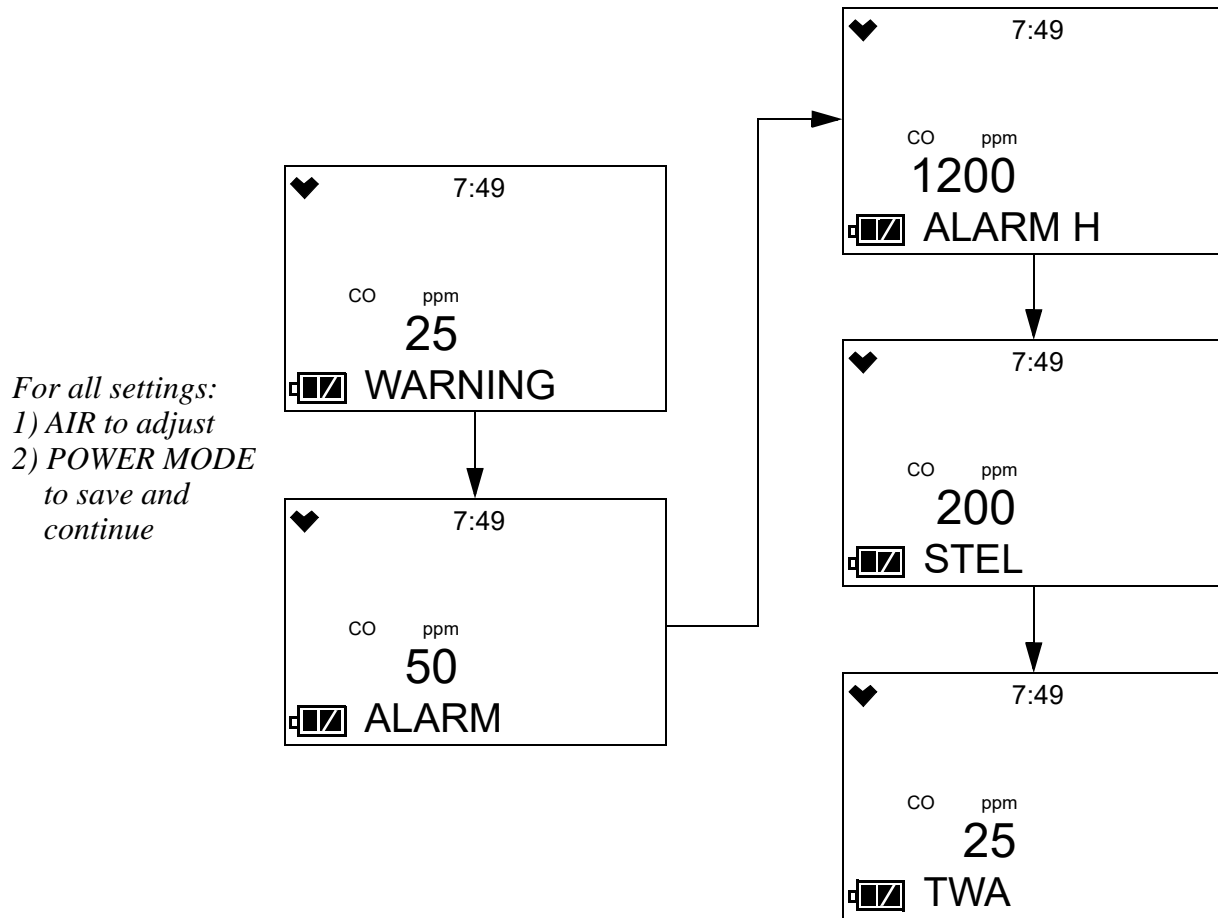
## Setting the Alarm Points

1. After entering the Alarm Points menu item, press AIR to scroll through to the instrument channel whose alarm points you want to change.



2. Press and release POWER MODE.

3. The Warning setpoint for the channel will display and it will be flashing. In the example below, the CO channel is selected.



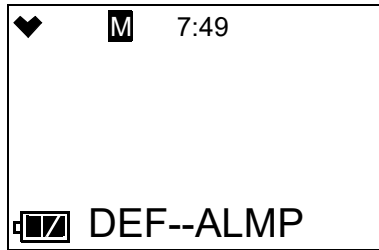
4. Use AIR to adjust the Warning setpoint.
5. Press and release POWER MODE to save the setting.
6. Repeat Step 4 and Step 5 for the Alarm, Alarm H, STEL (CO and H<sub>2</sub>S only) and TWA (CO and H<sub>2</sub>S only) settings.
7. The instrument will return to the channel selection screen.
8. Repeat Step 1 - Step 7 to change the alarm points for other channels.



## Defaulting the Alarm Points

Defaulting the alarm points defaults them back to factory settings as outlined in Table 1 on page 7 or to the settings saved in the **SET RAP** menu item in Gas Select Mode if you have performed a **SET RAP** operation.

1. After entering the Alarm Points menu item, press AIR to scroll to **DEF-ALMP**.



2. Press POWER MODE to enter the **DEF-ALMP** menu item.
3. Press POWER MODE to perform an alarm default. Press AIR to return to the **DEF-ALMP** menu item.
4. The instrument will ask if you're sure you want to default the alarm points. Press POWER MODE to default the alarm points. Press AIR to return to the **DEF-ALMP** menu item.

## ESCAPE

1. While in the **ALARM-P** menu, press AIR to scroll to **ESCAPE**.
2. Press and release POWER MODE. The instrument will return to the **ALARM--PT** menu item.

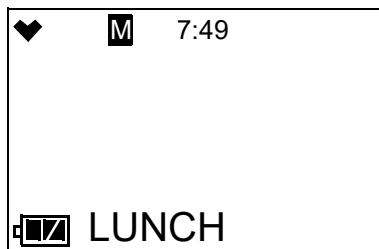
---

## Updating the Lunch Break Setting (LUNCH)

**OFF** (factory setting): The GX-3R automatically starts new TWA and PEAK reading collection and resets the time in operation at startup.

**ON**: The Lunch Break Screen displays during startup. From this screen, you can choose to continue accumulating TWA and PEAK readings and the time in operation from the last time the GX-3R was used or start collecting new readings and reset the time in operation.

1. While in User Mode, press AIR to scroll to **LUNCH**.



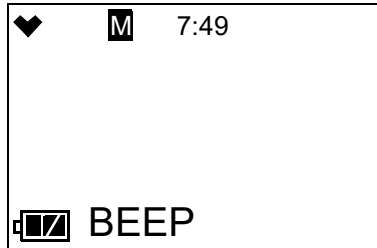
2. Press and release POWER MODE. The current setting flashes.
3. Use AIR to display the desired setting.
4. Press and release POWER MODE to save the setting. The **LUNCH** menu item will be displayed.

---

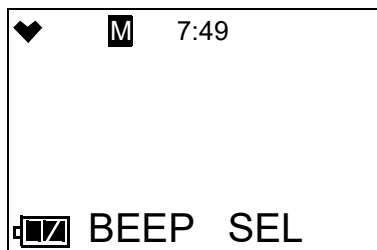
## Setting the Confirmation Beep and Non-Compliance Indicator (BEEP)

The **BEEP** menu item has a sub menu with 3 menu items: **BEEP SEL**, **BEEP INT**, and **ESCAPE**.

1. While in User Mode, press AIR to scroll to **BEEP**.



2. Press and release POWER MODE. The **BEEP SEL** menu item appears.



### **BEEP SEL**

**BEEP SEL** defines what kind of confirmation or non-compliance indication you want to occur in Measuring Mode. The available choices are:

**OFF** (factory setting): The GX-3R does not provide a confirmation alert or non-compliance indicator.

**LED**: The GX-3R's LEDs double flash as often as defined by the **BEEP INT** parameter to verify that the instrument is operating.

**BUZZER**: The GX-3R's buzzer double beeps as often as defined by the **BEEP INT** parameter to verify that the instrument is operating.

**LED+BUZZ**: The GX-3R's LEDs double flash and the buzzer double beeps as often as defined by the **BEEP INT** parameter to verify that the instrument is operating.

**BUMP/CAL**: If a bump test or a calibration is due and if **BUMP.EXPD** or **CAL EXPD** is set to **CONFIRM** or **NONE**, the GX-3R's LEDs double flash as often as defined by the **BEEP INT** parameter to indicate a non-compliance. Once a bump test or calibration (depending on which is due) is done, the LEDs will stop flashing.

**ALM ALRT**: If the instrument goes into any gas alarm, the LEDs double flash as often as defined by the **BEEP INT** parameter to indicate a non-compliance. Once a successful bump test or calibration is done, the LEDs will stop flashing.

---

**NOTE:** Depending on the **Need to get Bump Log** setting (only accessed via SDM-3R program), a data download may also be needed to clear the non-compliance.

---

**B/C/ALM:** The LEDs double flash to indicate a non-compliance if any of the following happens.

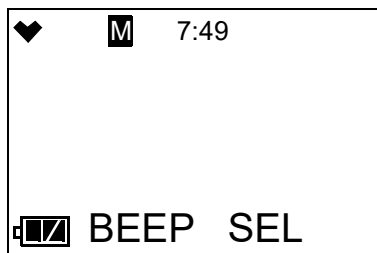
- a. **BUMP.EXPD** is set to **CONFIRM** or **NONE** and a bump test is due (cleared by successful bump test).
- b. **CAL EXPD** is set to **CONFIRM** or **NONE** and a calibration is due (cleared by successful calibration).
- c. The instrument goes into any gas alarm (cleared by successful bump test or calibration).

---

**NOTE:** Depending on the **Need to get Bump Log** setting (only accessed via SDM-3R program), a data download may also be needed to clear the gas alarm non-compliance.

---

1. While in the **BEEP** menu, press AIR to scroll to **BEEP SEL**.

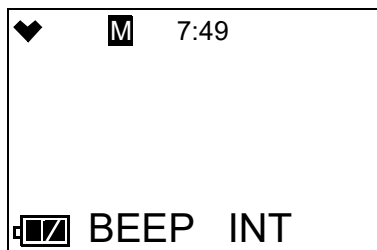


2. Press and release POWER MODE. The current setting flashes.
3. Use AIR to display the desired setting.
4. Press and release POWER MODE to save the setting. The **BEEP SEL** menu item will be displayed.

## **BEEP INT**

The **BEEP INT** parameter defines how often the confirmation alert or non-compliance indicator selected in **BEEP SEL** occurs. This setting only applies if the **BEEP SEL** parameter is set to something other than **OFF**. The available choices are **0.5** minutes and **1-99** minutes in 1 minute increments. The factory setting is **5** minutes.

1. While in the **BEEP** menu, press AIR to scroll to **BEEP INT**.



2. Press and release POWER MODE. The current setting flashes.
3. Use AIR to display the desired setting.
4. Press and release POWER MODE to save the setting. The **BEEP INT** menu item will be displayed.

## ESCAPE

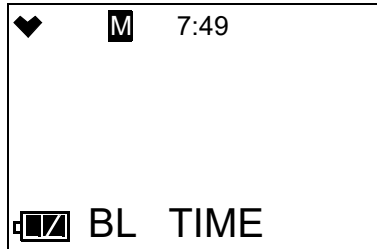
1. While in the **BEEP** menu, press AIR to scroll to **ESCAPE**.
2. Press and release POWER MODE. The instrument will return to the **BEEP** menu item.

---

## Updating the Backlight Time (BL TIME)

This setting indicates the length of time the LCD illuminates when you press any button. The minimum setting is **OFF**; the maximum setting is **255** seconds. The factory setting is **30** seconds.

1. While in User Mode, press AIR to scroll to **BL TIME**.



2. Press and release POWER MODE. The current setting flashes.
3. Use AIR to display the desired setting. To reverse the direction of change (ie. from increasing to decreasing or vice versa):
  - a. Press and hold AIR.
  - b. Immediately press POWER MODE and then release both buttons.
4. Press and release POWER MODE to save the setting. The **BL TIME** menu item will be displayed.

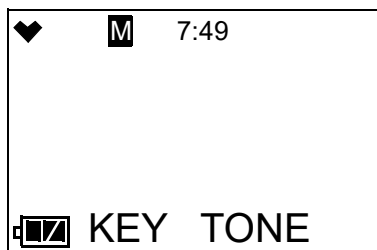
---

## Turning the Key Tone On/Off (KEY TONE)

**ON (factory setting):** The instrument will beep every time a button is pressed.

**OFF:** The instrument will not beep when a button is pressed.

1. While in User Mode, press AIR to scroll to **KEY TONE**.



2. Press and release POWER MODE. The current setting flashes.
3. Use AIR to display the desired setting.
4. Press and release POWER MODE to save the setting. The **KEY TONE** menu item will be displayed.

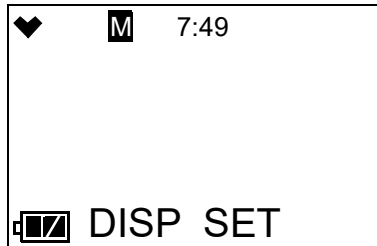
---

## Display Mode Items (DISP SET)

**OFF:** LIST, USER ID, and STN ID items do not appear in Display Mode.

**ON (factory setting):** LIST item appears in Display Mode. USER ID and STATION ID screens appear in Display Mode if ID DISP in Maintenance Mode is also set to ON (factory setting is OFF).

1. While in User Mode, press AIR to scroll to **DISP SET**.



2. Press and release POWER MODE. The current setting flashes.
3. Use AIR to display the desired setting.
4. Press and release POWER MODE to save the setting. The **DISP SET** menu item will be displayed.

---

## Zero Suppression (ZERO SUP)

This menu item only appears if ZSUP.DISP is set to ON in Maintenance Mode (factory setting is OFF).

The **ZERO SUP** setting is not intended for field adjustment. The default setting for each sensor is ON.

Sensor	Zero Suppression Value
Combustible Gas	2% LEL
O <sub>2</sub>	0.5% volume
H <sub>2</sub> S	0.3 ppm
CO	2 ppm

---

## Zero Follower (ZERO.FLWR)

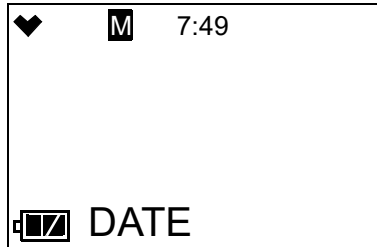
This menu item only appears if ZFLW.DISP is set to ON in Maintenance Mode (factory setting is OFF).

The **ZERO.FLWR** setting is not intended for field adjustment. The default setting is ON. The oxygen channel does not support zero follower functionality.

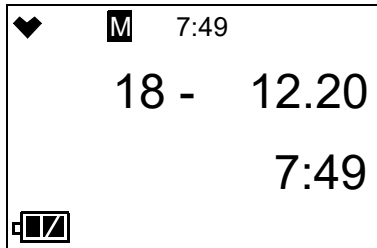
---

## Setting the Date/Time (DATE)

1. From the main menu, place the cursor next to **DATE**.



2. Press and release POWER MODE. The date and time will be displayed with the year flashing.



3. Use AIR to display the desired year.
4. Press and release POWER MODE to save the setting. The month setting flashes.
5. Repeat Step 3 and Step 4 to enter the month, day, hours, and minutes settings. The date and time will be saved and the **DATE** menu item will be displayed.

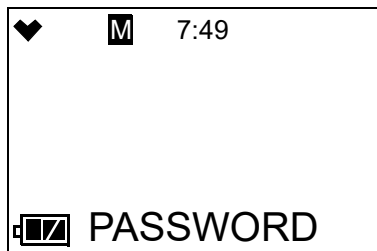
---

## Turning the Password On/Off (PASSWORD)

**ON:** The GX-3R prompts you for a password when you enter User Mode. The factory-set password is **0405** but it can be changed as desired.

**OFF (factory setting):** No password is required to enter User Mode.

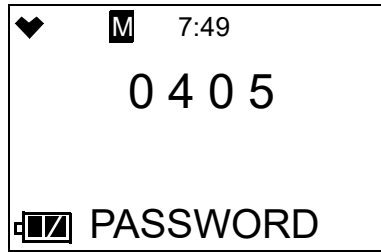
1. While in User Mode, press AIR to scroll to **PASSWORD**.



2. Press and release POWER MODE. The current setting flashes.
3. Use AIR to display the desired setting.
4. If you selected **OFF**, press and release POWER MODE to save the setting and return to the **PASSWORD** item in User Mode.

If you selected **ON**, continue with Step 5.

5. Press and release POWER MODE. The Set Password Screen appears. The current password is at the top of the screen with the first digit flashing.



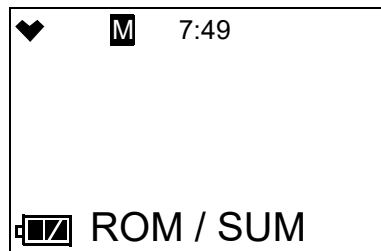
6. Use AIR to display a number from 0 to 9.
7. Press and release POWER MODE to enter the selection and advance to the next number. To go back a number, press and hold AIR and POWER MODE for a few seconds.
8. Repeat Step 6 and Step 7 to select the remaining numbers. When you press and release POWER MODE to enter the last number, the password is saved and you return to the **PASSWORD** item in User Mode.

---

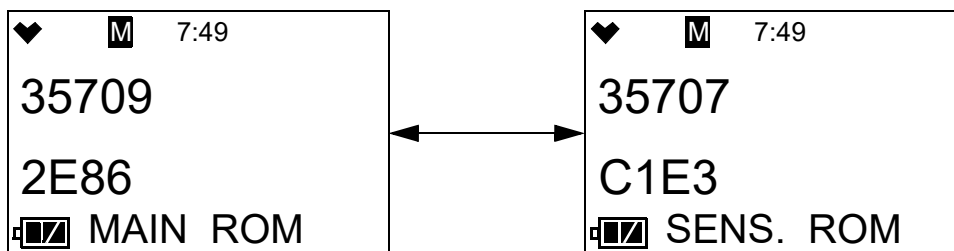
## Viewing the ROM/SUM (ROM/SUM)

The **ROM/SUM** screen shows the firmware version that is loaded in the instrument and the firmware checksum.

1. While in User Mode, press AIR to scroll to **ROM/SUM**.



2. Press and release POWER MODE. The screen will cycle through the ROM/SUM of the main board and the ROM/SUM of the sensor board. The ROM is the top value and the SUM is the bottom value.

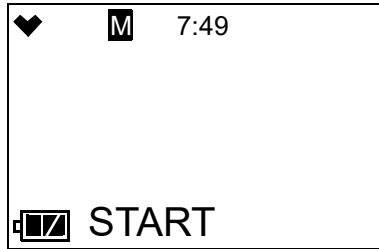


3. Press and release POWER MODE to return to the **ROM/SUM** menu item in User Mode.

---

## Entering Measuring Mode (START)

1. While in User Mode, press AIR to scroll to **START**.



2. Press and release POWER MODE. The instrument will begin its warmup sequence.



# Chapter 6: Maintenance

## Overview

This chapter describes troubleshooting procedures for the GX-3R. It also includes procedures for replacing and recharging the batteries and replacing various consumable parts.

**WARNING:** *RKI Instruments, Inc. recommends that service, calibration, and repair of RKI Instruments be performed by personnel properly trained for this work. Replacing sensors and other parts with original equipment does not affect the intrinsic safety of the instrument.*

## Troubleshooting

The troubleshooting table describes error messages, symptoms, probable causes, and recommended action for problems you may encounter with the GX-3R.

**Table 10: Troubleshooting the GX-3R**

Symptoms	Probable Causes	Recommended Action
<ul style="list-style-type: none"><li>The LCD is blank.</li></ul>	<ul style="list-style-type: none"><li>The unit may have been turned off.</li><li>The batteries may need to be recharged.</li></ul>	<ol style="list-style-type: none"><li>To turn on the unit, press and briefly hold POWER MODE.</li><li>If the unit does not turn on, recharge the batteries.</li><li>If the difficulties continue, contact RKI Instruments, Inc. for further instruction.</li></ol>
<ul style="list-style-type: none"><li>The LCD shows abnormally high or low readings but other gas detection instruments do not.</li></ul>	<ul style="list-style-type: none"><li>The filters may need to be replaced.</li><li>The GX-3R may need to be recalibrated.</li><li>The sensor for the affected channel(s) may need replacement.</li></ul>	<ol style="list-style-type: none"><li>Replace the filters.</li><li>Recalibrate the unit.</li><li>If the difficulties continue, replace the sensor for the affected channel(s) and calibrate the affected channel(s).</li><li>If the difficulties continue, contact RKI Instruments, Inc. for further instruction.</li></ol>
<ul style="list-style-type: none"><li>Calibration fails.</li></ul>	<ul style="list-style-type: none"><li>The calibration values may not match the cylinder gas concentrations.</li><li>The charcoal filter or charcoal half of the dual filter is saturated causing an elevated CO reading.</li><li>The sample gas is not reaching the sensors because of a bad connection.</li><li>The calibration cylinder may be out of gas or is outdated.</li><li>The sensor for the affected channel(s) may need replacement.</li></ul>	<ol style="list-style-type: none"><li>Make sure the GX-3R has been properly set up for calibration.</li><li>Change the charcoal filter or the dual filter.</li><li>Check all calibration tubing for leaks or for any bad connections.</li><li>Verify that the calibration cylinder contains an adequate supply of fresh test sample.</li><li>If the fail condition continues, replace the sensor(s).</li><li>If the difficulties continue, contact RKI Instruments, Inc. for further instruction.</li></ol>

**Table 10: Troubleshooting the GX-3R**

Symptoms	Probable Causes	Recommended Action
<ul style="list-style-type: none"><li>Heart symbol at the top of the screen becomes steadily on or disappears</li></ul>	<ul style="list-style-type: none"><li>A microprocessor error has occurred.</li></ul>	<ul style="list-style-type: none"><li>Contact RKI Instruments, Inc. for further instruction.</li></ul>
<ul style="list-style-type: none"><li>Charge LED alternates between green and orange</li></ul>	<ul style="list-style-type: none"><li>Charging environment is outside the allowed 0 - 40°C charging temperature range.</li></ul>	<ul style="list-style-type: none"><li>Move the charger to a location that is within the allowed 0 - 40°C charging temperature range.</li></ul>

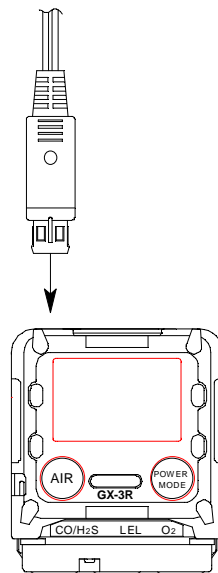
## Recharging the Batteries

**WARNING:** *To prevent ignition of a hazardous atmosphere, batteries must only be charged in an area known to be nonhazardous.*

**AVERTISSEMENT:** *Pour éviter l'inflammation d'une atmosphère dangereuse, les batteries doivent uniquement être modifiés ou facturés dans une zone connue comme non dangereuse.*

Recharge the batteries when the battery icon indicates that the unit is in low battery warning. When in low battery warning, the lowest battery level indication bar disappears and the battery icon will be flashing.

1. Make sure the GX-3R is off.
2. Plug the AC adapter into an electrical outlet.
3. Connect the charging jack on the charging cable to the charging socket on the GX-3R. When properly connected, a green LED will turn on at the top of the GX-3R.



**Figure 7: Connecting the Charging Cable**

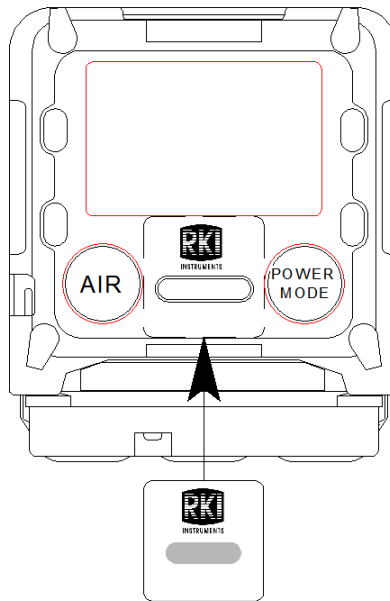
4. The LED at the top of the GX-3R turns orange while charging. When a full charge has been reached, approximately 3 hours, the LED turns green. Remove the charging cable from the GX-3R.

---

## Replacing the Buzzer Cover

The buzzer cover may need to be replaced if it becomes saturated or clogged with particles.

1. Remove the rubber boot from the GX-3R.
2. Peel off the old buzzer cover located between the AIR and POWER MODE buttons.
3. If necessary, clean any remaining residue from the case.
4. Peel the backing off of the new buzzer cover.
5. Install the new buzzer cover between the AIR and POWER MODE buttons as shown below.



**Figure 8: Buzzer Cover Replacement**

6. Reinstall the rubber boot.

---

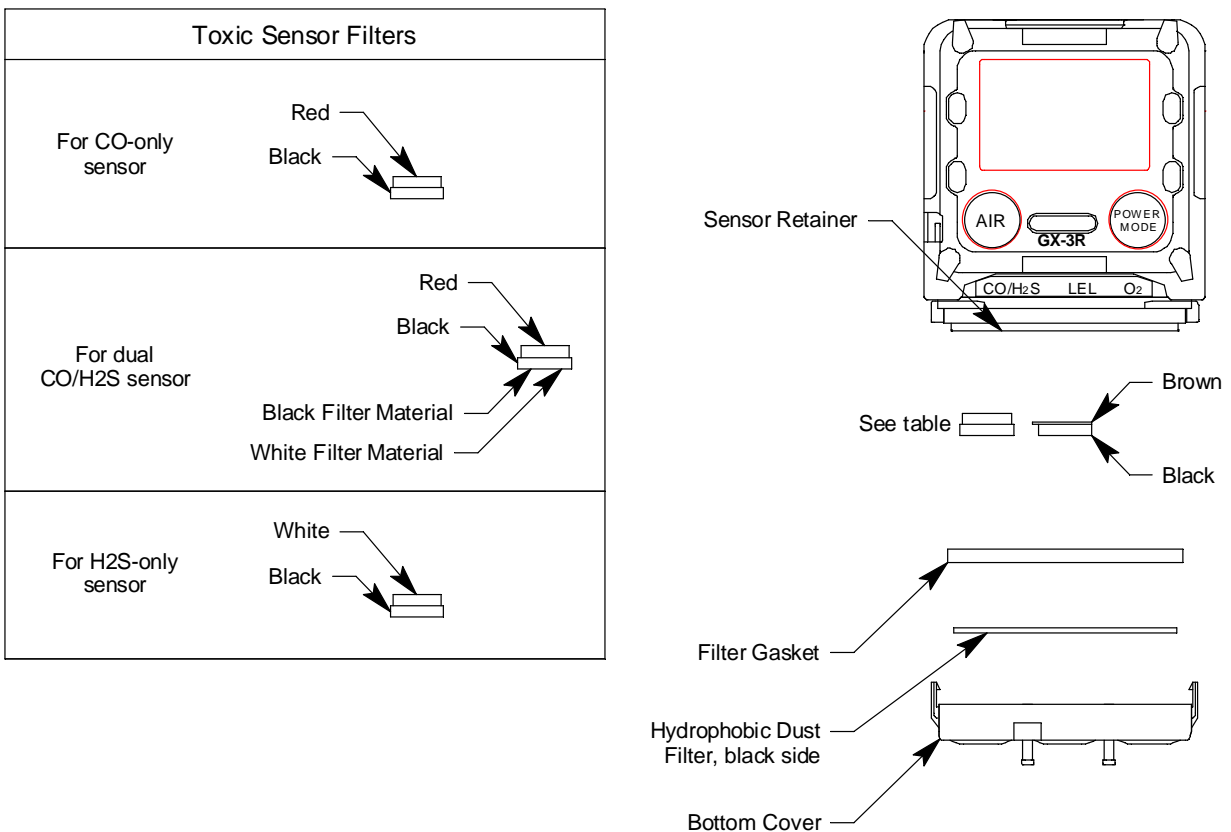
## Replacing the Filters

Combustible Gas Sensor Filter: The H<sub>2</sub>S filter disk is dark red in color and although it may darken over time, its color is not indicative of remaining filter life. The H<sub>2</sub>S filter disk can absorb H<sub>2</sub>S for 33 ppm hours and should be replaced after that much exposure. With this many ppm hours of absorption, the H<sub>2</sub>S filter disk should be replaced after 80 minutes of exposure to 25 ppm H<sub>2</sub>S. This equates to replacing the H<sub>2</sub>S filter disk after 40 2-minute calibrations with a cylinder containing 25 ppm H<sub>2</sub>S. If H<sub>2</sub>S exists in the monitoring environment, the H<sub>2</sub>S filter disk will have to be replaced more frequently.

CO and H<sub>2</sub>S Sensors' Filters: The dual CO/H<sub>2</sub>S sensor has a half black/half white filter installed over it. CO-only sensors have a black charcoal filter. H<sub>2</sub>S-only sensors have a white humidity filter. The filter should be replaced if you notice unexplained CO and/or H<sub>2</sub>S readings.

1. Verify that the GX-3R is off.

2. Turn the GX-3R upside down.
3. Use a small Phillips screwdriver to unscrew the two screws holding the bottom cover to the rest of the GX-3R's case. Only unscrew them until the heads are flush with the edge of the bottom cover.
4. Using a small flat blade screwdriver, gently pry each side of the bottom cover away from the rest of the GX-3R's case.
5. Remove the bottom cover from the rest of the GX-3R's case.
6. Remove the filter gasket/sensor retainer assembly.
7. Remove the filter gasket and the hydrophobic dust filter.
8. Gently pry out the filter you want to replace.
9. Install the new filters.
  - a. Dark red H<sub>2</sub>S scrubber disk for combustible gas sensor: The brown side of the filter case should face toward the GX-3R.
  - b. Black and white combo filter for CO/H<sub>2</sub>S dual sensor: The red side of the filter case should face toward the GX-3R. The black filter material should face the edge of the GX-3R while the white filter material should face the H<sub>2</sub>S scrubber disk.
  - c. Black filter for CO-only sensor: The red side of the filter case should face toward the GX-3R Pro.
  - d. White filter for H<sub>2</sub>S-only sensor: The white side of the filter case should face toward the GX-3R Pro.



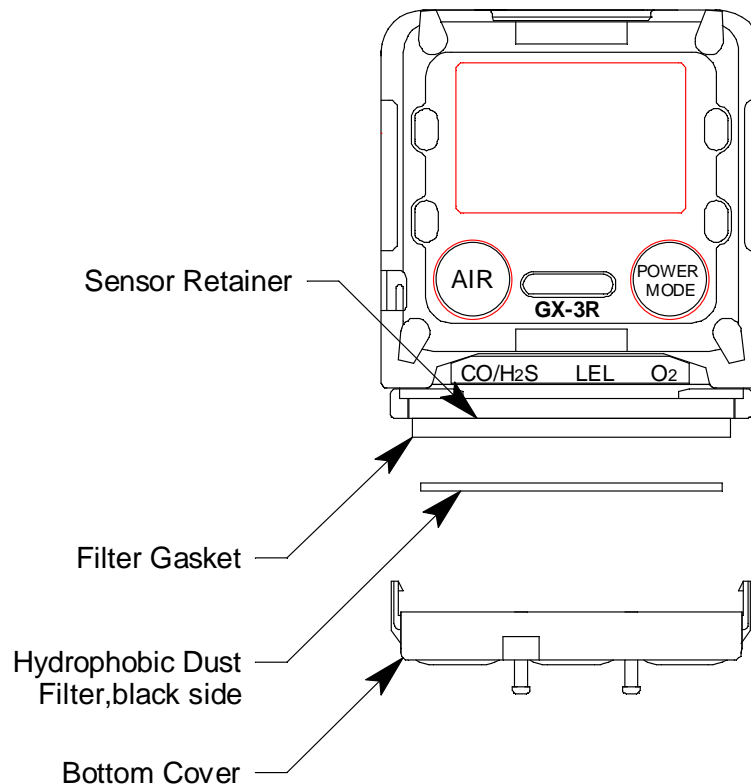
**Figure 9: Replacing the H<sub>2</sub>S Scrubber Disk and Charcoal Filter**

- 10 . Reinstall the filter gasket and hydrophobic dust filter onto the sensor retainer. The tabs on the gasket should face toward the GX-3R. The black side of the hydrophobic dust filter should be facing up.
- 11 . Reattach the bottom cover to the GX-3R. Push it onto the GX-3R until it snaps into place.
- 12 . Reinstall the two screws that were loosened in Step 3.

---

## Replacing the Hydrophobic Filter

- 1 . Verify that the GX-3R is off.
- 2 . Turn the GX-3R upside down.
- 3 . Use a small Phillips screwdriver to unscrew the two screws holding the bottom cover to the rest of the GX-3R's case. Only unscrew them until the heads are flush with the edge of the bottom cover.
- 4 . Using a small flat blade screwdriver, gently pry each side of the bottom cover away from the rest of the GX-3R's case.
- 5 . Remove the bottom cover from the rest of the GX-3R's case. The filter gasket/sensor retainer assembly may come out.
- 6 . Remove the white hydrophobic filter from the filter gasket. The hydrophobic dust filter may be stuck on the bottom cover.
- 7 . Install the new hydrophobic dust filter. Place the filter on top of the filter gasket with the black side facing up.



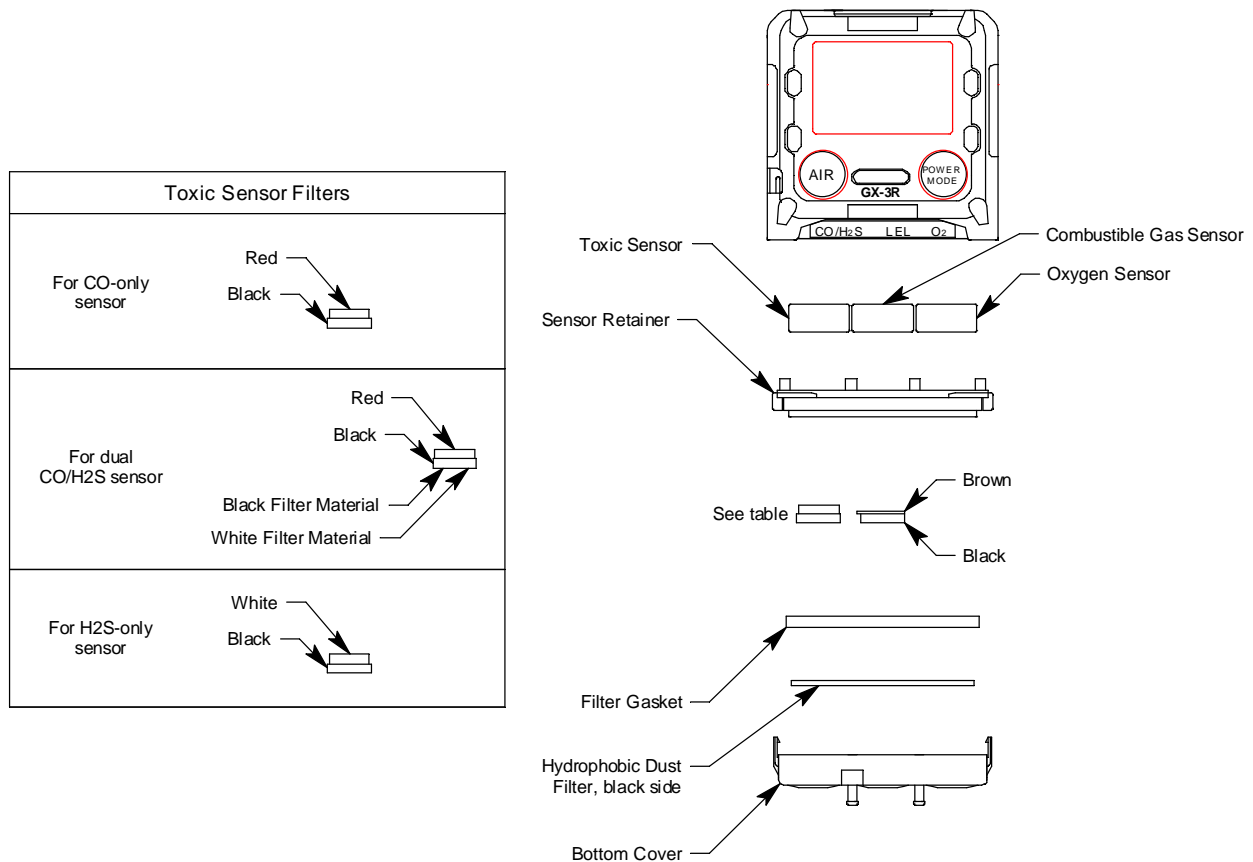
**Figure 10: Replacing the Hydrophobic Dust Filter**

- 8 . Reattach the bottom cover to the GX-3R. Push it onto the GX-3R until it snaps into place.

9. Reinstall the two screws that were loosened in Step 3.

## Replacing a Sensor

1. Verify that the GX-3R is off.
2. Turn the GX-3R upside down.
3. Use a small Phillips screwdriver to unscrew the two screws holding the bottom cover to the rest of the GX-3R's case. Only unscrew them until the heads are flush with the edge of the bottom cover.
4. Using a small flat blade screwdriver, gently pry each side of the bottom cover away from the rest of the GX-3R's case.
5. Remove the filter gasket/sensor retainer assembly from the GX-3R Pro. The sensors will be exposed.
6. Locate the sensor you want to replace and remove it from its socket.
7. Carefully insert the replacement sensor in the correct socket. Be sure that the new sensor is installed in the same position as the old sensor and that it is aligned correctly. The toxic and oxygen sensors have slots to orient the sensor. The combustible gas sensor has tabs to orient the sensor. Do not force a sensor into its slot.



**Figure 11: Replacing a Sensor**

8. If your instrument has a factory installed dummy sensor, ensure that it is still installed correctly. Make sure that the flat side is facing away from the GX-3R.

- 9 . Reinstall the filter gasket/sensor retainer assembly. The black and white filter goes over the CO/H<sub>2</sub>S sensor with the black half of the filter facing the edge of the GX-3R. Be sure the filter gasket/sensor retainer is oriented correctly.
- 10 . If the hydrophobic dust filter came out, place the filter on top of the filter gasket with the black side facing up.
- 11 . Reattach the bottom cover to the GX-3R. Push it onto the GX-3R until it snaps into place.
- 12 . Reinstall the two screws that were loosened in Step 3.
- 13 . Calibrate the new sensors as described in “Performing a Calibration (GAS CAL)” on page 47.

# Chapter 7: General Parts List

Table 11 lists part numbers for the GX-3R's replacement parts and accessories.

**Table 11: General Parts List**

Part Number	Description
06-1248RK-03	Calibration kit tubing, 3 foot length
13-0112RK	Wrist strap
13-0124	Alligator clip
13-0125	Belt clip
20-0332	Rubber boot, black
20-0333	Leather case
20-0334	Heat-resistant case
21-1950	Screen protector
33-0181	Hydrophobic dust filter
33-0553	Buzzer cover
33-7130	Charcoal filter/humidity filter disk (black and white), for dual CO/H <sub>2</sub> S sensor, 5 pack
33-7131	H <sub>2</sub> S scrubber disk (dark red), for combustible gas sensor, 5 pack
33-7132	Charcoal filter disk (black), for CO and H <sub>2</sub> -compensated CO sensors, 5 pack
33-7133	Humidity filter (white), for H <sub>2</sub> S sensor, 5 pack
47-5093	USB/IrDA adapter with cable and CD (not for use with Eagle 2)
49-0133	AC adapter
65-7004	Dummy sensor
71-0477	Operator's Manual, GX-3R (this document)
71-0491	Operator's Manual, GX-3R Datalogging Program
81-0090RK-01	Calibration cylinder, 3-gas (CH <sub>4</sub> /O <sub>2</sub> /CO), 34 liter steel
81-0090RK-03	Calibration cylinder, 3-gas (CH <sub>4</sub> /O <sub>2</sub> /CO), 103 liter
81-0154RK-02	Calibration cylinder, 4-gas (CH <sub>4</sub> /O <sub>2</sub> / H <sub>2</sub> S/CO), 58 liter
81-0154RK-04	Calibration cylinder, 4-gas (CH <sub>4</sub> /O <sub>2</sub> / H <sub>2</sub> S/CO), 34 liter aluminum
81-1050RK-25	Regulator, fixed flow, 0.25 LPM, with gauge and knob, for 17 liter and 34 liter steel cylinders (cylinders with external threads)
81-1051RK-25	Regulator, fixed flow, 0.25 LPM, with gauge and knob, for 34 liter aluminum, 58 liter, and 103 liter cylinders (cylinders with internal threads)
81-1193	Calibration cup



**Table 11: General Parts List (cont.)**

<b>Part Number</b>	<b>Description</b>
81-GX3RCO	Calibration kit: 103 liter 3-gas (CH <sub>4</sub> /O <sub>2</sub> /CO) cylinder, 0.25 LPM regulator, calibration tubing, and case
81-GX3RCO-LV	Calibration kit: 34 liter steel 3-gas (CH <sub>4</sub> /O <sub>2</sub> / CO) cylinder, 0.25 LPM regulator, calibration tubing, and case
81-GX3RHSCO	Calibration kit: 58 liter 4-gas (CH <sub>4</sub> /O <sub>2</sub> / H <sub>2</sub> S/CO) cylinder, 0.25 LPM regulator, calibration tubing, and case
81-GX3RHSCO-LV	Calibration kit: 34 liter aluminum 4-gas (CH <sub>4</sub> /O <sub>2</sub> / H <sub>2</sub> S/CO) cylinder, 0.25 LPM regulator, calibration tubing, and case
81-GX3RHSCO-116	Calibration kit: 116 liter aluminum 4-gas (CH <sub>4</sub> /O <sub>2</sub> / H <sub>2</sub> S/CO), 0.25 LPM regulator, calibration tubing, and case
ESR-A13i	Hydrogen sulfide (H <sub>2</sub> S) sensor
ESR-A13P	Carbon monoxide (CO) sensor
ESR-A1CP	Hydrogen-compensated carbon monoxide (CO) sensor
ESR-A1DP	Dual carbon monoxide (CO) and hydrogen sulfide (H <sub>2</sub> S) sensor
ESR-X13P	Oxygen sensor
NCR-6309	Combustible gas sensor, catalytic

# Appendix A: Maintenance Mode

## Overview

This appendix describes the GX-3R in Maintenance Mode. The GX-3R is factory-set to suit most applications. Update settings in Maintenance Mode only if required for your specific application. Maintenance Mode items and their factory settings are listed in Table 12 below.

**Table 12: Maintenance Mode Menu Items**

Maintenance Mode Menu Item	Description	
GAS CAL (pg.85)	Perform an air adjust, perform a span adjustment, change the calibration values, set the cylinder group.	
	AIR CAL      Perform a fresh air adjustment.	
	AUTO CAL	Perform a span adjustment, set the calibration gas concentration, and set the cylinder for each gas.
		AUTO CAL CYL X      Perform an automatic span adjustment on the gases selected for Cylinder X (A-E cylinders available).
		CAL-P      Set the calibration concentration for each gas.
		CYL SEL      Assign a cylinder (A-E) to each gas (all 4 gases set to Cylinder A is the default). For single cal operation, you would assign each gas its own cylinder.
	ESCAPE      Return to the <b>AUTO CAL</b> menu item.	
ESCAPE      Return to the <b>GAS CAL</b> menu item.		
GAS TEST (pg.85)	Apply gas to test sensor response and observe alarm indications without an alarm event being recorded.	
SEN DATE (pg.87)	View the replacement date for each sensor and the battery and/or set the replacement date for each sensor or the battery to the current date.	
BUMP (pg.88)	Perform a bump test.	
LATCHING (pg.89)	<b>ON (factory setting):</b> The GX-3R remains in alarm until the alarm condition passes <i>and</i> POWER MODE is pressed. <b>OFF:</b> The GX-3R automatically resets an alarm when the alarm condition passes.	
DEM ZERO (pg.89)	<b>ON (factory setting):</b> You can manually perform a fresh air adjust in Measuring Mode by pressing AIR. <b>OFF:</b> You cannot manually perform a fresh air adjust in Measuring Mode by pressing AIR.	
AUTOZERO (pg.90)	<b>ON:</b> The GX-3R will ask if you want to perform a fresh air adjustment at the end of the startup sequence. <b>OFF (factory setting):</b> The GX-3R does not ask if you want to perform a fresh air adjustment at the end of the startup sequence.	

**Table 12: Maintenance Mode Menu Items**

<b>Maintenance Mode Menu Item</b>	<b>Description</b>
ID DISP (pg.90)	<b>ON:</b> User ID and Station ID screens appear in startup sequence. IDs can be changed in Display Mode if <b>DISP.SET</b> in User Mode is also set to <b>ON</b> . <b>OFF (factory setting):</b> User ID and Station ID screens do not appear in startup sequence. IDs cannot be changed in Display Mode.
ZERO SUP (pg.91)	<b>ON (factory setting):</b> Not intended for field adjustment. The suppression values are: Combustible Gas: 2% LEL O <sub>2</sub> : 0.5% volume H <sub>2</sub> S: 0.3 ppm CO: 2 ppm
ZERO.FLWR (pg.91)	<b>ON (factory setting):</b> Not intended for field adjustment. Oxygen channel does not support zero follower functionality.
ZSUP.DISP (pg.91)	<b>ON:</b> Zero suppression menu item appears in User Mode. <b>OFF (factory setting):</b> Zero suppression menu item does not appear in User Mode. (Zero suppression menu item is always available in Maintenance Mode)
ZFLW.DISP (pg.91)	<b>ON:</b> Zero follower menu item appears in User Mode. <b>OFF (factory setting):</b> Zero follower menu item does not appear in User Mode. (Zero follower menu item is always available in Maintenance Mode)
DATE (pg.91)	Set the current date and time.
PASSWORD (pg.92)	<b>ON (factory setting):</b> A password is needed to access Maintenance Mode. Factory-set password is <b>8102</b> . <b>OFF:</b> No password is needed to access Maintenance Mode.
ROM/SUM (pg.93)	View the firmware information for the GX-3R's sensor board and main board.
M.DEFAULT (pg.94)	Set all parameters back to their RKI factory settings.
START (pg.95)	Press and release POWER MODE to begin the warmup sequence and enter Measuring Mode.

## Entering Maintenance Mode

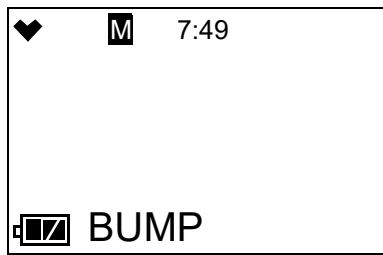
**WARNING:** *The GX-3R is not in operation as a gas detector while in Maintenance Mode.*

- 1 . Take the GX-3R to a non-hazardous location and turn it off if it is on.
- 2 . Press and hold AIR, then press and hold POWER MODE. You will hear a beep after one second. Continue to hold the buttons down.
- 3 . When you hear a second beep, release the buttons.

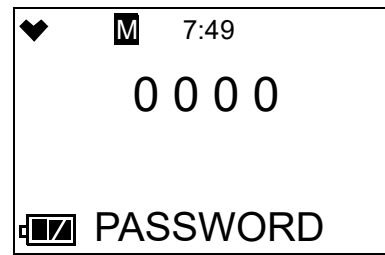
- The screen that appears will depend on the setting of Maintenance Mode's **PASSWORD** item.

If **PASSWORD** is set to **OFF**, continue with Step 8.

If **PASSWORD** is set to **ON** (factory setting), continue with Step 5.

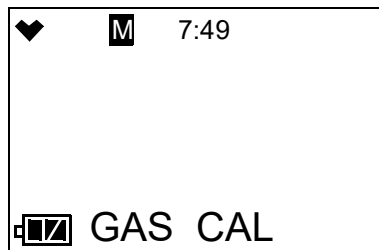


**PASSWORD** set to **OFF**



**PASSWORD** set to **ON**

- If **PASSWORD** has been set to **ON** in Maintenance Mode, a password screen will appear. The first digit will be flashing. The factory-set password is **8102** but it can be changed as desired.
- Use **AIR** to select each password number then press **POWER MODE** to save it and move on to the next number. To go back a number, press and hold **AIR** and **POWER MODE** for a few seconds. To reverse the direction of change (ie. from increasing to decreasing or vice versa):
  - Press and hold **AIR**.
  - Immediately press **POWER MODE** and then release both buttons.
- Continue to Step 6.
- The **GAS CAL** menu item displays.



- Use **AIR** to move through the Maintenance Mode menu items.

---

## Tips for Using Maintenance Mode

- To scroll from one menu item to the next, press and release **AIR**. To reverse the scrolling direction:
  - Press and hold **AIR**.
  - Immediately press **POWER/MODE** and then release both buttons.
  - The scrolling direction returns to the original direction when you exit and reenter a menu.
- To skip an item when a question is asked, press and release **AIR**.

- To enter an item and to save any changes, press and release POWER MODE.
- To change a flashing parameter, use AIR. To reverse the direction of change (ie. from increasing to decreasing or vice versa):
  - a. Press and hold AIR.
  - b. Immediately press POWER MODE and then release both buttons.
- To exit an entered menu item without saving a change, press and hold AIR and POWER MODE for a few seconds.

---

## Performing a Calibration (GAS CAL)

See “Performing a Calibration (GAS CAL)” on page 47 for a description of the GAS CAL menu item.

---

## Performing a Gas Test (GAS TEST)

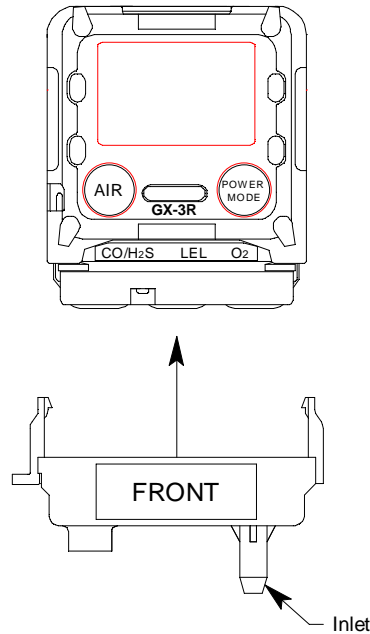
The GAS TEST menu item allows you to apply gas to the instrument and see all alarm indications except for the buzzer indication. There is no buzzer indication in the GAS TEST menu even though the buzzer will sound in the event of a real gas alarm condition while in Measuring Mode.

### ***Preparing for a Gas Test***

To perform a gas test on the GX-3R, you will need:

- A calibration cylinder. The concentrations should be above the alarm condition you want to check. Standard alarm points are listed on pg.7.
  - 0.25 LPM fixed flow regulator
  - Non-absorbent tubing
  - Calibration cup
1. Confirm that the regulator knob is turned all the way clockwise. Screw the 0.25 LPM fixed flow regulator onto the calibration cylinder.

2. Install the calibration cup onto the GX-3R. Use the label and imprinting to make sure that the calibration cup gets installed in the correct orientation relative to the GX-3R. Be sure the calibration cup is pushed on all the way.

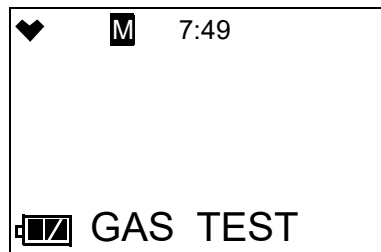


**Figure 12: Calibration Cup Installation**

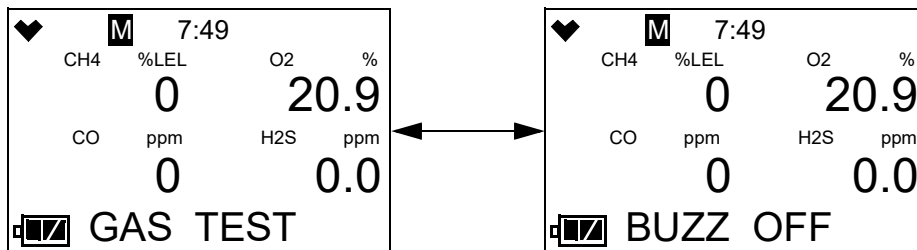
3. Use the tubing to connect the regulator to the inlet of the calibration cup.

### ***Performing a Gas Test***

1. While in Maintenance Mode, press AIR to scroll to **GAS TEST**.



2. Press and release POWER MODE. The current gas readings display. The bottom of the LCD alternates between “GAS TEST” and “BUZZ OFF”.



3. Turn the regulator knob counterclockwise to open the regulator.
4. The instrument will initiate alarm indications except for the buzzer. There is no buzzer indication in the **GAS TEST** menu even though the buzzer will sound in the event of a real gas alarm condition.

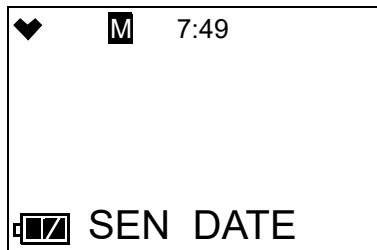
5. Turn the regulator knob clockwise to close the regulator.
6. Unscrew the regulator from the calibration cylinder.
7. Remove the calibration cup from the GX-3R.
8. Store the calibration kit in a safe and convenient place.
9. Press and release POWER MODE to return to the **GAS TEST** menu item in Maintenance Mode.

---

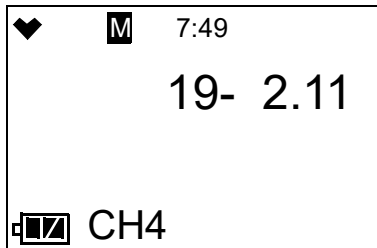
## Sensor/Battery Replacement Date (SEN DATE)

The **SEN DATE** menu item allows you to keep track of when the sensors and the battery were replaced.

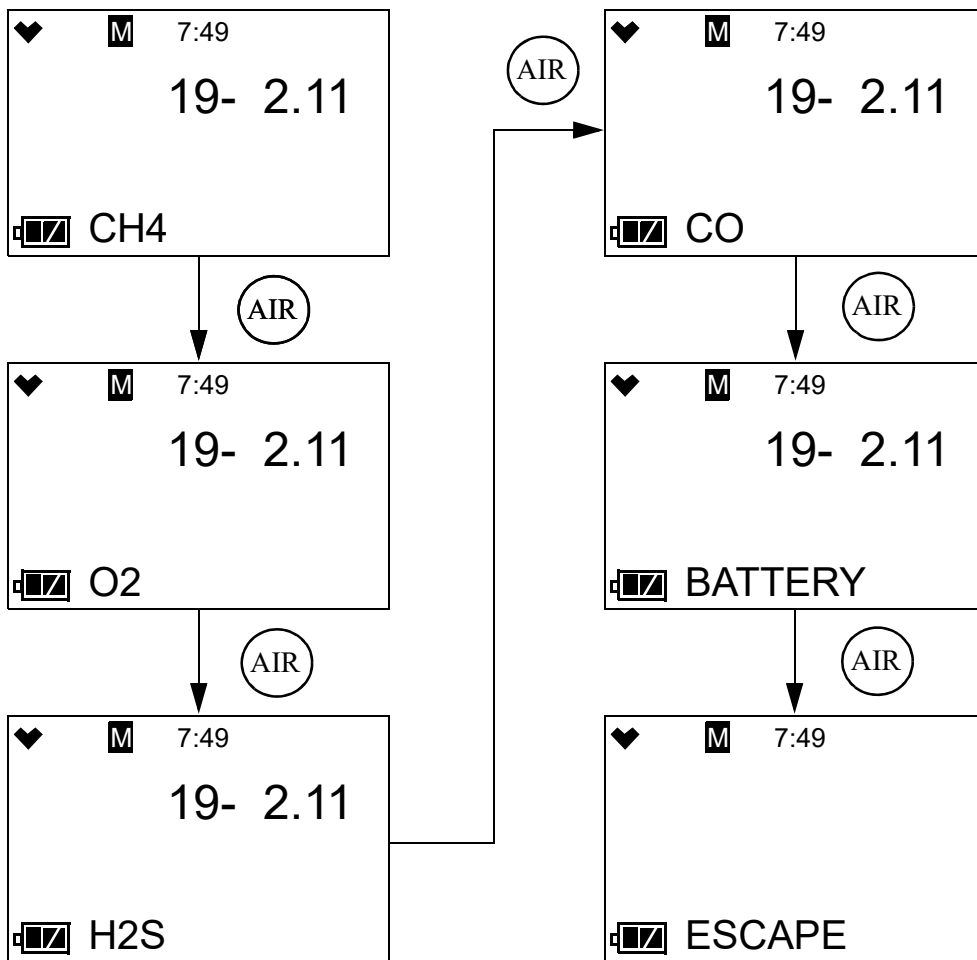
1. While in Maintenance Mode, press AIR to scroll to **SEN DATE**.



2. Press and release POWER MODE. The combustible gas sensor's replacement date will display.



- Use AIR to scroll to the item whose replacement date you want to view or change.



- To change the replacement date:
  - With the desired item displayed, press and release POWER MODE.
  - Press and release POWER MODE again to set the replacement date to the current date.
- Use the AIR button to scroll to the **ESCAPE** menu item.
- Press and release POWER MODE to return to the **SEN DATE** menu item in Maintenance Mode.

---

## Performing a Bump Test (BUMP)

See “Performing a Bump Test (BUMP)” on page 43 for a description of the **BUMP** menu item.



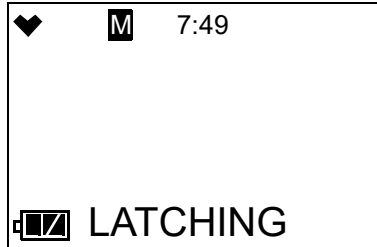
---

## Setting Alarms to Latching or Self-Resetting (LATCHING)

**ON (factory setting):** The GX-3R remains in alarm until the alarm condition passes *and* POWER MODE is pressed.

**OFF:** The GX-3R automatically resets an alarm when the alarm condition passes.

1. While in Maintenance Mode, press AIR to scroll to **LATCHING**.



2. Press and release POWER MODE. The current setting flashes.
3. Use AIR to display the desired setting.
4. Press and release POWER MODE to save the setting. The **LATCHING** menu item will be displayed.

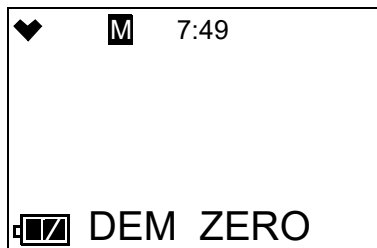
---

## Turning the Demand Zero Function On/Off (DEM ZERO)

**ON (factory setting):** You can manually perform a fresh air adjust in Measuring Mode by pressing AIR.

**OFF:** You cannot manually perform a fresh air adjust in Measuring Mode.

1. While in Maintenance Mode, press AIR to scroll to **DEM ZERO**.



2. Press and release POWER MODE. The current setting flashes.
3. Use AIR to display the desired setting.
4. Press and release POWER MODE to save the setting. The **DEM ZERO** menu item will be displayed.

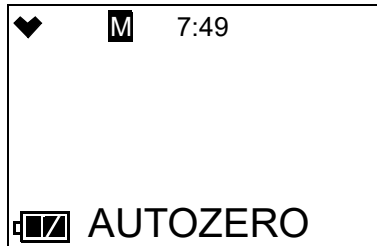
---

## Turning the Auto Zero Function On/Off (AUTOZERO)

**ON:** The GX-3R will ask if you want to perform a fresh air adjustment at the end of the startup sequence.

**OFF (factory setting):** The GX-3R does not ask if you want to perform a fresh air adjustment at the end of the startup sequence.

1. While in Maintenance Mode, press AIR to scroll to **AUTOZERO**.



2. Press and release POWER MODE. The current setting flashes.
3. Use AIR to display the desired setting.
4. Press and release POWER MODE to save the setting. The **AUTOZERO** menu item will be displayed.

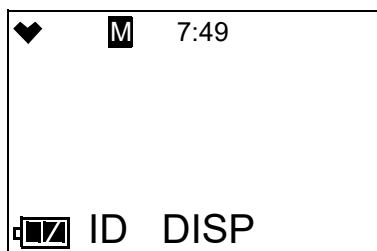
---

## Turning the ID Display Function On/Off (ID DISP)

**ON:** The User ID and Station ID screens appear in startup sequence. If **DISP.SET** in User Mode is also set to **ON**, then the IDs can be changed in Display Mode.

**OFF (factory setting):** The User ID and Station ID screens do not appear in startup sequence and the IDs cannot be changed in Display Mode.

1. While in Maintenance Mode, press AIR to scroll to **ID DISP**.



2. Press and release POWER MODE. The current setting flashes.
3. Use AIR to display the desired setting.
4. Press and release POWER MODE to save the setting. The **ID DISP** menu item will be displayed.

---

## Turning the Zero Suppression On/Off (ZERO SUP)

The **ZERO SUP** setting is not intended for field adjustment. The default setting for each sensor is **ON**.

Sensor	Zero Suppression Value
Combustible Gas	2% LEL
O <sub>2</sub>	0.5% volume
H <sub>2</sub> S	0.3 ppm
CO	2 ppm

---

## Turning the Zero Follower On/Off (ZERO.FLWR)

The **ZERO.FLWR** setting is not intended for field adjustment. The default setting is **ON**. The oxygen channel does not support zero follower functionality.

---

## User Mode Zero Suppression (ZSUP.DISP)

**ON**: Zero suppression menu item appears in User Mode.

**OFF (factory setting)**: Zero suppression menu item does not appear in User Mode. The zero suppression menu item is always available in Maintenance Mode.

It is not normally necessary to have the zero suppression menu item appear in User Mode. Contact RKI Instruments before turning this setting on.

---

## User Mode Zero Follower (ZFLW.DISP)

**ON**: Zero follower menu item appears in User Mode.

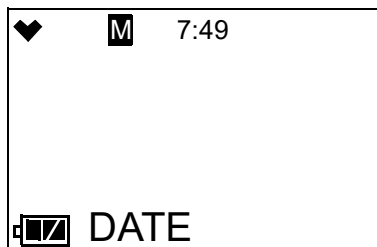
**OFF (factory setting)**: Zero follower menu item does not appear in User Mode. The zero follower menu item is always available in Maintenance Mode.

It is not normally necessary to have the zero follower menu item appear in User Mode. Contact RKI Instruments before turning this setting on.

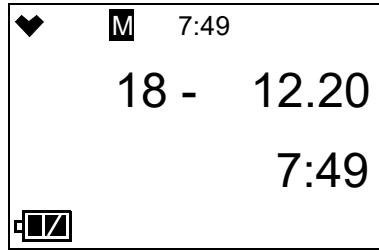
---

## Setting the Date/Time (DATE)

1. From the main menu, place the cursor next to **DATE**.



2. Press and release POWER MODE. The date and time will be displayed with the year flashing.



3. Use AIR to display the desired year.
4. Press and release POWER MODE to save the setting. The month setting flashes.
5. Repeat Step 3 and Step 4 to enter the month, day, hours, and minutes settings. The date and time will be saved and the **DATE** menu item will be displayed.

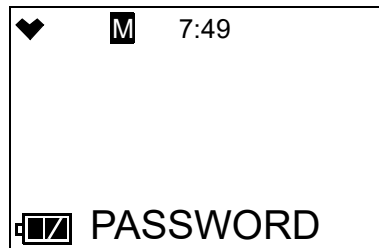
---

## Turning the Password On/Off (PASSWORD)

**ON (factory setting):** The GX-3R prompts you for a password when you enter Maintenance Mode. The factory-set password is **8102** but it can be changed as desired.

**OFF:** No password is required to enter Maintenance Mode.

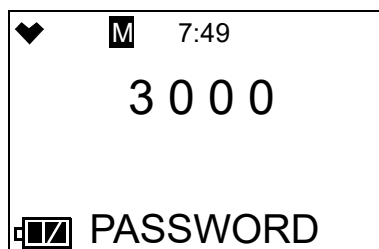
1. While in Maintenance Mode, press AIR to scroll to **PASSWORD**.



2. Press and release POWER MODE. The current setting flashes.
3. Use AIR to display the desired setting.
4. If you selected **OFF**, press and release POWER MODE to save the setting and return to the **PASSWORD** item in User Mode.

If you selected **ON**, continue with Step 5.

5. Press and release POWER MODE. The Set Password Screen appears. The current password is at the top of the screen with the first digit flashing.



6. Use AIR to display a number from 0 to 9.

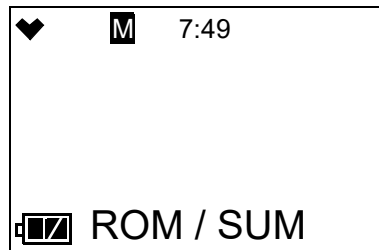
7. Press and release **POWER MODE** to enter the selection and advance to the next number. To go back a number, press and hold **AIR** and **POWER MODE** for a few seconds.
8. Repeat Step 6 and Step 7 to select the remaining numbers. When you press and release **POWER MODE** to enter the last number, the password is saved and you return to the **PASSWORD** item in Maintenance Mode.

---

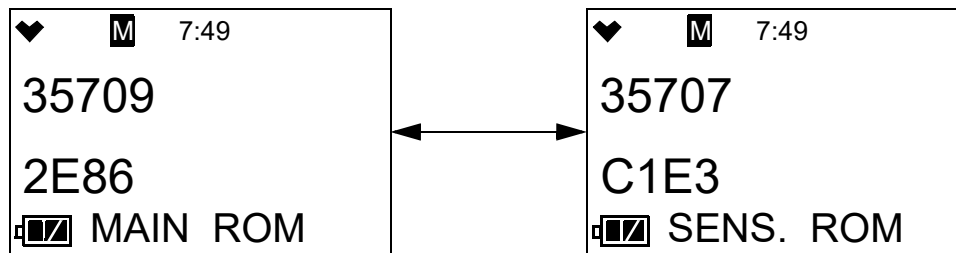
## Viewing the ROM/SUM (ROM/SUM)

The **ROM/SUM** screen shows the firmware version that is loaded in the instrument and the firmware checksum.

1. While in Maintenance Mode, press **AIR** to scroll to **ROM/SUM**.



2. Press and release **POWER MODE**. The screen will cycle through the ROM/SUM of the main board and the ROM/SUM of the sensor board. The ROM is the top value and the SUM is the bottom value.

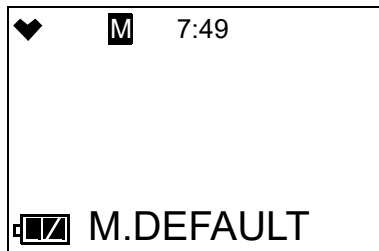


3. Press and release **POWER MODE** to return to the **ROM/SUM** menu item in Maintenance Mode.

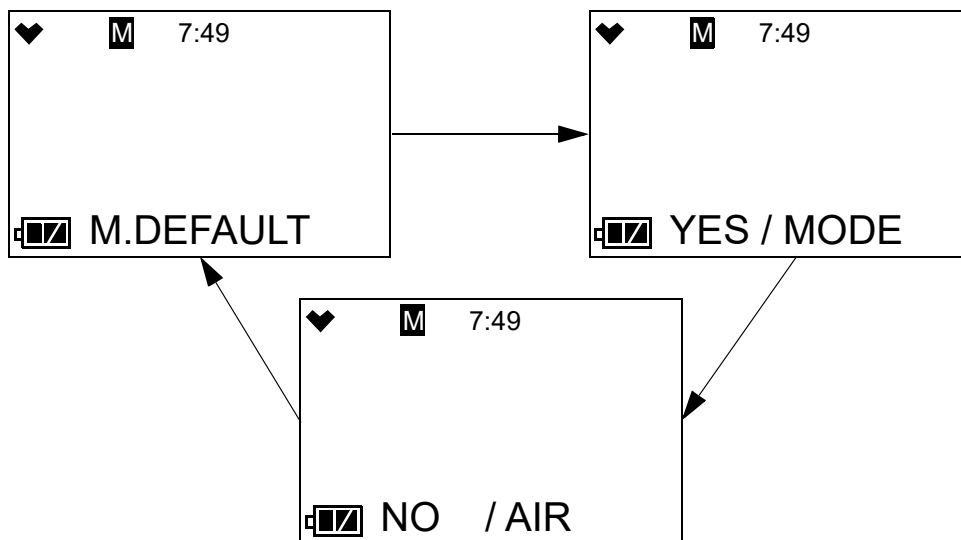
## Performing a Default (M.DEFAULT)

Performing a default operation in Maintenance Mode returns all parameters to their RKI factory settings.

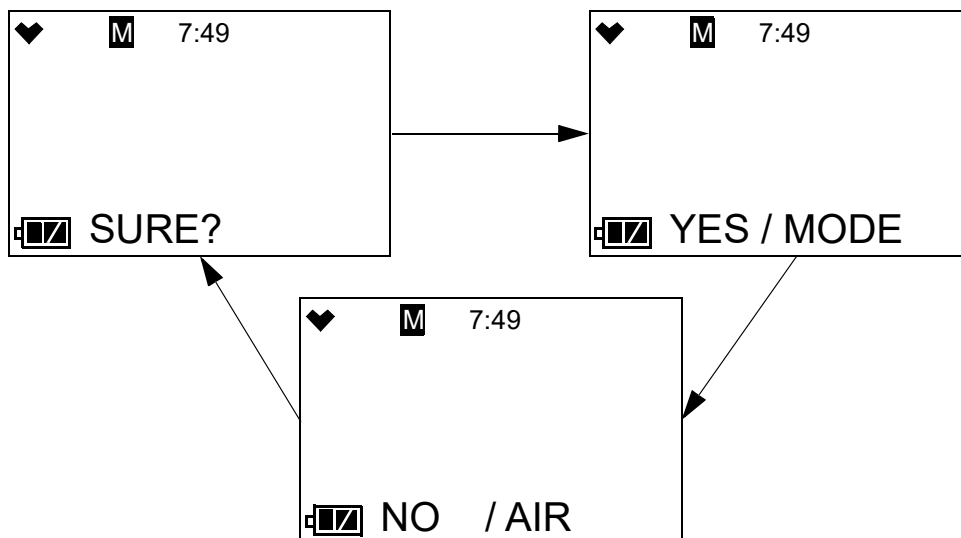
1. While in Maintenance Mode, press AIR to scroll to **M.DEFAULT**.



2. Press and release POWER MODE.



3. Press and release POWER MODE to perform a default operation. The instrument will ask if you are sure you want to perform a default operation.

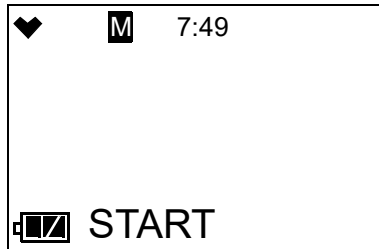


- 4 . Press and release POWER MODE to perform a default operation. The instrument will beep twice and return to the **M.DEFAULT** menu item in Maintenance Mode.

---

## Entering Measuring Mode (START)

- 1 . While in Maintenance Mode, press AIR to scroll to **START**.



- 2 . Press and release POWER MODE. The instrument will begin its warmup sequence.

## Appendix B: Gas Select Mode

### Overview

This appendix describes the GX-3R in Gas Select Mode. The GX-3R is factory-set to suit most applications. Update settings in Gas Select Mode only if required for your specific application. A description of the Gas Select Mode items is shown in Table 13 below.

**Table 13: Gas Select Mode Menu Items**

Menu Item (Page # of Description)	Description
GAS COMB (pg.98)	Turn channels on or off and changes target gas for each channel.
SET R AP (pg.100)	Allows you to set the current alarm points as the default alarm points.
MAX SPAN (pg.102)	<b>ON:</b> Maximum span screen appears after a successful calibration. <b>OFF (factory setting):</b> No maximum span screen appears.
STEALTH (pg.102)	<b>STEALTH ON:</b> No backlight, LED, or buzzer operation. <b>STEALTH OFF (factory setting):</b> Backlight, LED, and buzzer operate normally. <i>This setting has no effect unless STEALTH is set to ON.</i> <b>VIB ON:</b> Vibrator activates for alarm conditions. <b>VIB OFF (factory setting):</b> Vibrator does not activate in any situation.
CHG LEL (pg.103)	<b>STANDARD (factory setting):</b> Apply standard settings for lower explosive limit's ppm level. <b>IEC:</b> Apply IEC standards for the lower explosive limit's ppm level. <b>ISO:</b> Apply ISO standards for the lower explosive limit's ppm level.
START (pg.105)	Enter Measuring Mode

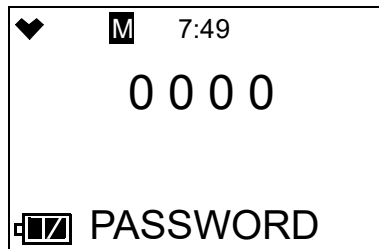


---

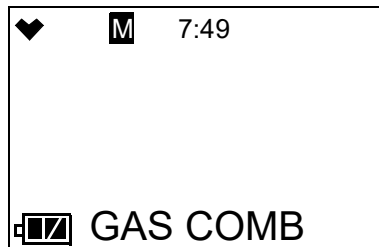
## Entering Gas Select Mode

**WARNING:** *The GX-3R is not in operation as a gas detector while in Gas Select Mode.*

1. Take the GX-3R to a non-hazardous location and turn it off if it is on.
2. Press and hold AIR, then press and hold POWER MODE. You will hear a beep after one second. Continue to hold the buttons down.
3. You will hear a second beep. Continue to hold the buttons down.
4. When you hear a third beep, release the buttons.
5. A password screen will appear. The first digit will be flashing. The password is **2014**.



6. Use AIR to select each password number then press POWER MODE to save it and move on to the next number. To go back a number, press and hold AIR and POWER MODE for a few seconds. To reverse the direction of change (ie. from increasing to decreasing or vice versa):
  - a. Press and hold AIR.
  - b. Immediately press POWER MODE and then release both buttons.
7. The **GAS COMB** menu item displays.



8. Use AIR to move through the Gas Select Mode menu items.

---

## Tips for Using Gas Select Mode

- To scroll from one menu item to the next, press and release AIR. To reverse the scrolling direction:
  - a. Press and hold AIR.
  - b. Immediately press POWER/MODE and then release both buttons.
  - c. The scrolling direction returns to the original direction when you exit and reenter a menu.
- To skip an item when a question is asked, press and release AIR.

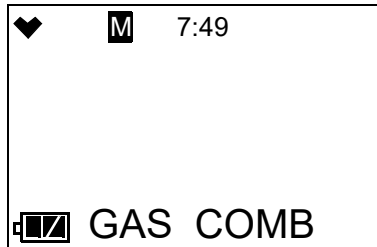
- To enter an item and to save any changes, press and release POWER MODE.
- To change a flashing parameter, use AIR. To reverse the direction of change (ie. from increasing to decreasing or vice versa):
  - a. Press and hold AIR.
  - b. Immediately press POWER MODE and then release both buttons.
- To exit an entered menu item without saving a change, press and hold AIR and POWER MODE for a few seconds.

---

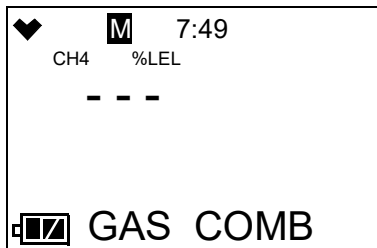
## Changing the Gas Combination (GAS COMB)

The **GAS COMB** menu item allows you to turn channels on and off.

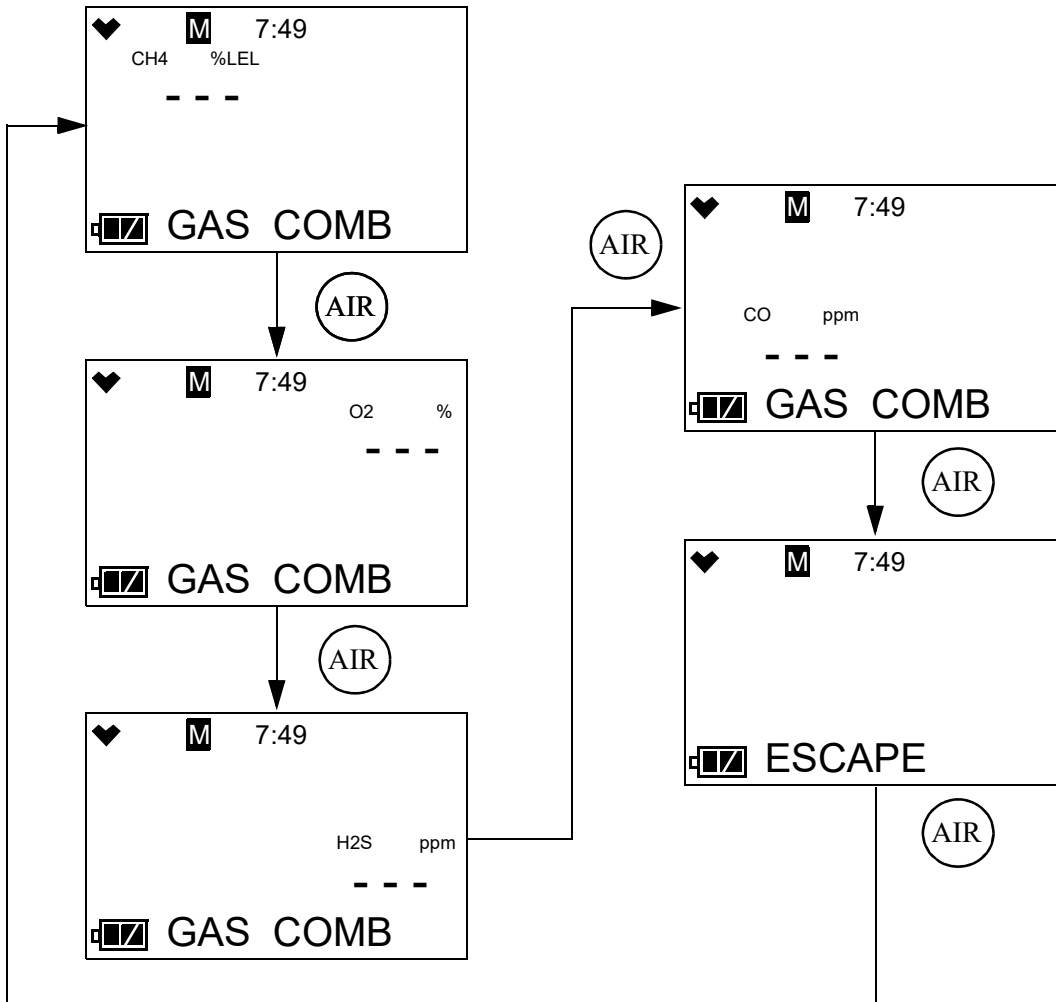
1. While in Gas Select Mode, press AIR to scroll to **GAS COMB**.



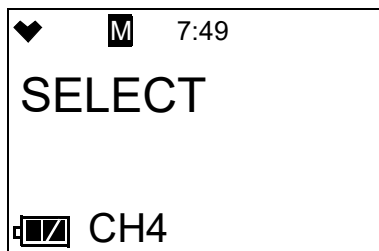
2. Press and release POWER MODE. The first channel is displayed.



- Press AIR to scroll through to the instrument channel whose target gas you want to change.



- Press and release POWER MODE.
- The target gas for the channel will display and it will be flashing. In the example below, the combustible gas channel is selected.



- 6 . Use AIR to change the target gas or turn the channel off.

**Table 14: Target Gas Options for Each Channel**

Channel	Target Gas Options
Combustible Gas	<ul style="list-style-type: none"> <li>• CH4 (methane)</li> <li>• i-C4H10 (isobutane)</li> <li>• H2 (hydrogen)</li> <li>• CH3OH (methanol)</li> <li>• C2H2 (acetylene)</li> <li>• C2H4 (ethylene)</li> <li>• C2H6 (ethane)</li> <li>• C2H5OH (ethanol)</li> <li>• C3H6 (propylene)</li> <li>• C3H6O (acetone)</li> <li>• C3H8 (propane)</li> <li>• C4H6 (butyne)</li> <li>• C5H10 (cyclopentane)</li> <li>• C6H6 (benzene)</li> <li>• n-C6H14 (hexane)</li> <li>• C7H8 (toluene)</li> <li>• n-C7H16 (heptane)</li> <li>• C8H10 (xylene)</li> <li>• n-C9H20 (nonane)</li> <li>• EtAc (ethyl acetate)</li> <li>• IPA (isopropyl alcohol)</li> <li>• MEK (methyl ethyl ketone)</li> <li>• MMA (methyl methacrylate)</li> <li>• DME (dimethyl ether)</li> <li>• MIBK (methyl isobutyl ketone)</li> <li>• THF (tetrahydrofuran)</li> <li>• CH4_VOL (methane %volume)*</li> <li>• ----- (off)</li> </ul>
O2	<ul style="list-style-type: none"> <li>• O2 (oxygen)</li> <li>• ----- (off)</li> </ul>
H2S	<ul style="list-style-type: none"> <li>• H2S (hydrogen sulfide for dual CO/H<sub>2</sub>S sensor)</li> <li>• H2S SING (hydrogen sulfide for single-gas H<sub>2</sub>S sensor)</li> <li>• H2_CO-H2 (hydrogen compensated CO)</li> <li>• ----- (off)</li> </ul>
CO	<ul style="list-style-type: none"> <li>• CO (carbon dioxide for dual CO/H<sub>2</sub>S sensor or single-gas CO sensor)</li> <li>• CO_CO-H2 (hydrogen compensated CO)</li> <li>• ----- (off)</li> </ul>
* If CH4_VOL is selected, the CHG LEL item in Gas Select Mode has no effect on operation.	

- 7 . Press and release POWER MODE to save the setting.
- 8 . The instrument will return to the channel selection screen.
- 9 . Repeat Step 3 - Step 8 to change the target gas for other channels.
- 10 . Use AIR to scroll to **ESCAPE** and press and release POWER MODE.
- 11 . The instrument will return to the **GAS COMB** menu item.

---

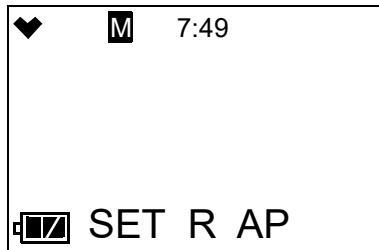
## Saving the Alarm Points (SET R AP)

Performing a **SET R AP** operation saves the current alarm setpoints.

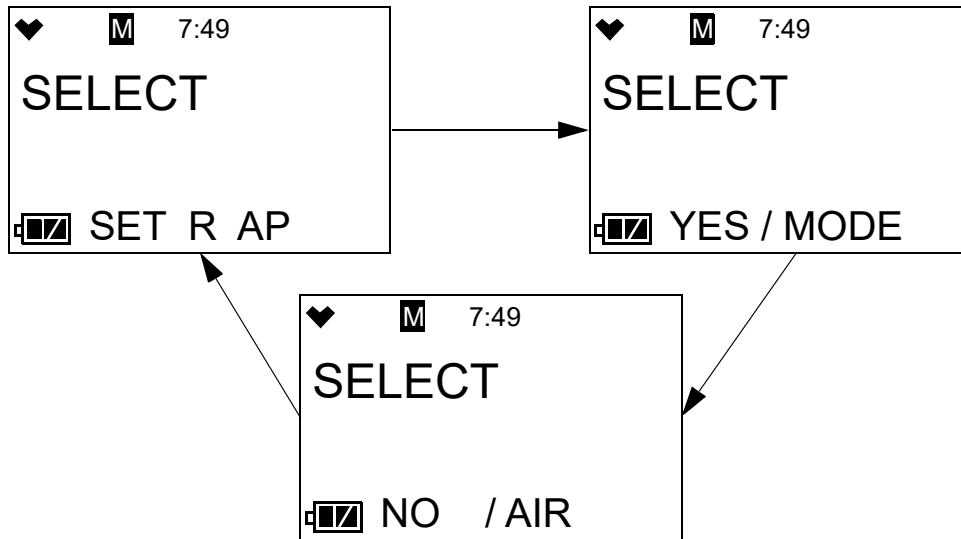
Performing a **DEF ALMP** operation in the **ALARM-PT** User Mode menu item sets the instrument's alarm points to those saved during the **SET R AP** operation (if performed).

Performing a **SET R AP** operation has no effect on an **M.DEFAULT** in Maintenance Mode. An **M.DEFAULT** operation will return all instrument settings to the RKI default regardless of if a **SET R AP** operation was performed.

1. While in Gas Select Mode, press AIR to scroll to **SET R AP**.



2. Press and release POWER MODE. The display will cycle through the following screens.



3. Press and release POWER MODE to save the current alarm point settings as the default.
4. The instrument will return to the **SET R AP** menu item.

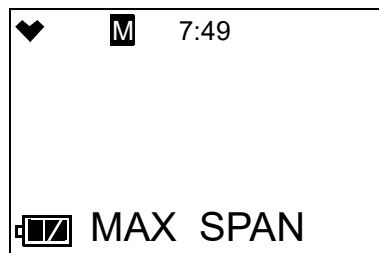
---

## Turning Calibration Max Span On/Off (MAX SPAN)

**ON:** After a passed calibration, the GX-3R displays the maximum possible adjustment it could have made to the response reading. So if the combustible gas channel was calibrated with 50% LEL gas and the maximum indicated span is 95% LEL, this means that there was enough adjustment left on that channel to set the reading to 95% LEL when the detector was exposed to 50% LEL gas. If the maximum span value is close to the calibration gas value, for example if it is 53% LEL when exposed to 50% LEL gas, the sensor should be replaced soon. The upper limit on the maximum adjustment indicated for all channels except for oxygen is either twice the calibration value or full scale, whichever is lower. The upper limit on the maximum adjustment indicated for the oxygen channel is 25.0% volume.

**OFF (factory setting):** There is no maximum span indication at the end of a calibration.

1. While in Gas Select Mode, press AIR to scroll to **MAX SPAN**.



2. Press and release POWER MODE. The current setting flashes.
3. Use AIR to display the desired setting.
4. Press and release POWER MODE to save the setting. The **MAX SPAN** menu item will be displayed.

---

## Stealth and Vibrator Settings (STEALTH)

### STEALTH

**ON:**

- The instrument's backlight does not come on, regardless of the **BL TIME** setting.
- The instrument's LEDs do not come on for any reason, even alarm conditions.
- The instrument's buzzer does not sound for any reason, even alarm conditions.
- An "S" appears at the top of the LCD.

**OFF (factory setting):** The instrument's backlight and LEDs operate normally.

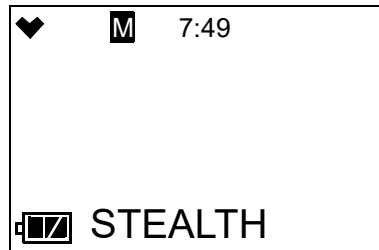
### VIB

*The **VIB** setting only affects instrument operation if **STEALTH** is set to **ON**.*

**ON:** The vibrator activates for alarm conditions. It can be useful to have this feature turned on if you have also turned **STEALTH** on.

**OFF (factory setting):** The vibrator does not activate for any reason.

1. While in Gas Select Mode, press AIR to scroll to **STEALTH**.



2. Press and release POWER MODE. The current **STEALTH** setting flashes.
3. Use AIR to display the desired setting.
4. Press and release POWER MODE. The current **VIB** setting flashes.
5. Use AIR to display the desired setting.
6. Press and release POWER MODE to save the setting. The **STEALTH** menu item will be displayed.

---

## LEL Definition (CHG LEL)

---

**NOTE:** If **CH4\_VOL** is selected for the combustible gas sensor in the **GAS COMB** menu item, the **CHG LEL** setting has no effect on operation.

---

The **CHG LEL** menu item defines what standard the instrument follows in determining the LEL (lower explosive limit) for the combustible channel's target gas.

**STANDARD:** Apply the standard settings for the lower explosive limit's ppm level.

**IEC:** Apply the IEC settings for the lower explosive limit's ppm level.

**ISO:** Apply the ISO settings for the lower explosive limit's ppm level.

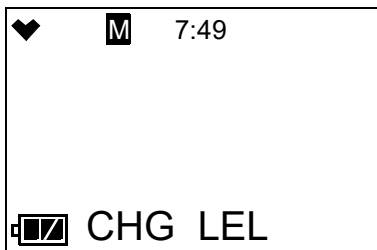
**Table 15: Lower Explosive Limit ppm Levels**

Gas	Standard (ppm)	IEC (ppm)	ISO (ppm)
Methane (CH <sub>4</sub> )	50,000	44,000	44,000
Isobutane (i-C <sub>4</sub> H <sub>10</sub> )	18,000	13,000	15,000
Hydrogen (H <sub>2</sub> )	40,000	40,000	40,000
Methanol (CH <sub>3</sub> OH)	55,000	60,000	60,000
Acetylene (C <sub>2</sub> H <sub>2</sub> )	15,000	23,000	23,000
Ethylene (C <sub>2</sub> H <sub>4</sub> )	27,000	23,000	24,000
Ethane (C <sub>2</sub> H <sub>6</sub> )	30,000	24,000	24,000
Ethanol (C <sub>2</sub> H <sub>5</sub> OH)	33,000	31,000	31,000
Propylene (C <sub>3</sub> H <sub>6</sub> )	20,000	20,000	18,000
Acetone (C <sub>3</sub> H <sub>6</sub> O)	21,500	25,000	25,000
Propane (C <sub>3</sub> H <sub>8</sub> )	20,000	17,000	17,000

**Table 15: Lower Explosive Limit ppm Levels**

Gas	Standard (ppm)	IEC (ppm)	ISO (ppm)
Butadiene (C4H6)	11,000	14,000	14,000
Cyclopentane (C5H10)	14,000	14,000	14,000
Benzene (C6H6)	12,000	12,000	12,000
N-hexane (n-C6H14)	12,000	10,000	10,000
Toluene (C7H8)	12,000	10,000	10,000
N-heptane (n-C7H16)	11,000	8,500	8,000
Xylene (C8H10)	10,000	10,000	10,000
N-nonane (n-C9H20)	7,000	7,000	7,000
Ethyl acetate (EtAc)	21,000	20,000	20,000
Isopropyl alcohol (IPA)	20,000	20,000	20,000
Methyl ethyl ketone (MEK)	18,000	15,000	15,000
Methyl methacrylate (MMA)	17,000	17,000	17,000
Dimethyl ether (DME)	30,000	27,000	27,000
Methyl isobutyl ketone (MIBK)	12,000	12,000	12,000
Tetrahydrofuran (THK)	20,000	15,000	15,000

- 1 . While in Gas Select Mode, press AIR to scroll to **CHG LEL**.



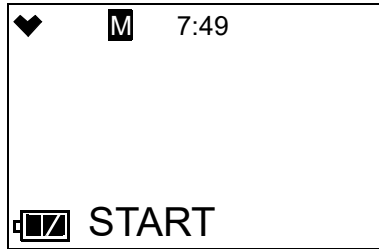
- 2 . Press and release POWER MODE. The current setting flashes.
- 3 . Use AIR to display the desired setting.
- 4 . Press and release POWER MODE to save the setting. The **CHG LEL** menu item will be displayed.



---

## Exiting Gas Select Mode (START)

1. While in Gas Select Mode, press AIR to scroll to **START**.



2. Press and release POWER MODE. The instrument will begin its warm-up sequence.

---

## Warranty

RKI Instruments, Inc. warrants the GX-3R sold by us to be free from defects in materials, workmanship, and performance for a period of three years from the date of shipment from RKI Instruments, Inc. This includes the instrument and the original sensors. Replacement parts are warranted for 1 year from the date of their shipment from RKI Instruments, Inc. except for replacement sensors which are warranted for 3 years. Any parts found defective within their warranty period will be repaired or replaced, at our option, free of charge. This warranty does not apply to those items which by their nature are subject to deterioration or consumption in normal service, and which must be cleaned, repaired, or replaced on a routine basis. Examples of such items are:

Absorbent cartridges

Filter elements, disks, or sheets

Pump diaphragms and valves

Warranty is voided by abuse including mechanical damage, alteration, rough handling, or repair procedures not in accordance with the instruction manual. This warranty indicates the full extent of our liability, and we are not responsible for removal or replacement costs, local repair costs, transportation costs, or contingent expenses incurred without our prior approval.

THIS WARRANTY IS EXPRESSLY IN LIEU OF ANY AND ALL OTHER WARRANTIES AND REPRESENTATIONS, EXPRESSED OR IMPLIED, AND ALL OTHER OBLIGATIONS OR LIABILITIES ON THE PART OF RKI INSTRUMENTS, INC. INCLUDING BUT NOT LIMITED TO THE WARRANTY OF MERCHANTABILITY OR FITNESS FOR A PARTICULAR PURPOSE. IN NO EVENT SHALL RKI INSTRUMENTS, INC. BE LIABLE FOR INDIRECT, INCIDENTAL, OR CONSEQUENTIAL LOSS OR DAMAGE OF ANY KIND CONNECTED WITH THE USE OF ITS PRODUCTS OR FAILURE OF ITS PRODUCTS TO FUNCTION OR OPERATE PROPERLY.

This warranty covers instruments and parts sold to users only by authorized distributors, dealers, and representatives as appointed by RKI Instruments, Inc.

We do not assume indemnification for any accident or damage caused by the operation of this gas monitor and our warranty is limited to replacement of parts or our complete goods.