

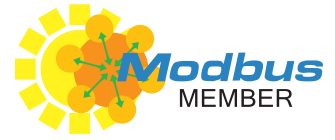

RIO-MOD-RTU

Relay I/O with Modbus/RTU

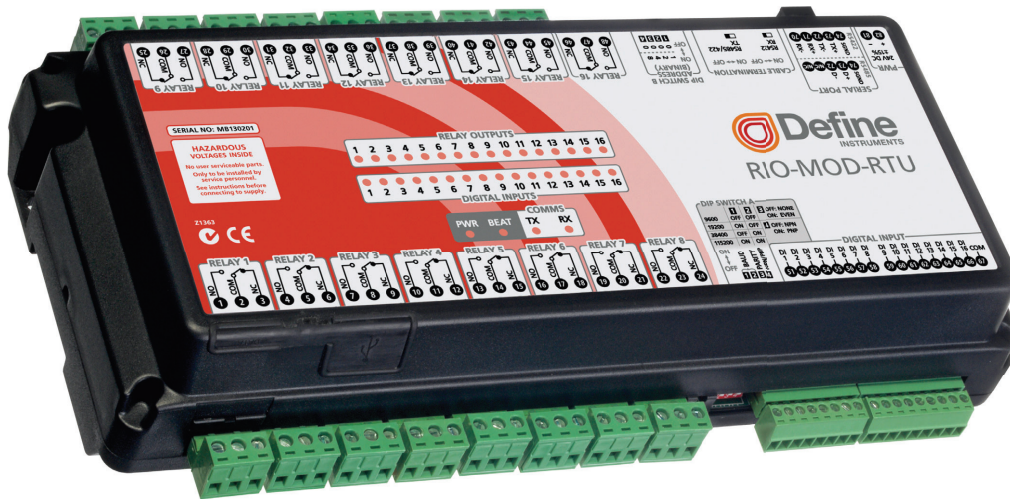

General specifications

16 isolated relay outputs Change over Form C (10A 250V AC or 10A 30V DC), 1kHz scan rate. Software selectable relay state. Relay auto shutoff feature (see 3.3).

16 selectable digital inputs Input type select NPN (sink) or PNP (source) from DIP switch A4 (see 2.5). 1kHz Input sample rate. Input voltage 5–24V.

LED indication on each relay output and digital input channel (see 2.1–2.2)

Communication Modbus/RTU (see 3.1 for more information)

DC power supply 24V DC $\pm 15\%$

Cable termination switches to switch 120 Ω termination resistors across the RS485/RS422 cables (see 2.7)

DIN rail mountable unit 35mm DIN rail.

Dimensions (H x W x D) 59 x 255 x 144mm (2.32 x 10.04 x 5.67") - with plugs in

Contents

1 - Unit Overview.....	2
2 - Wiring & DIP Switches	4
3 - Modbus Specifications & Programming.....	8
4 - Modbus Register Definitions	10

1 UNIT OVERVIEW

1.1 - Casing and terminals

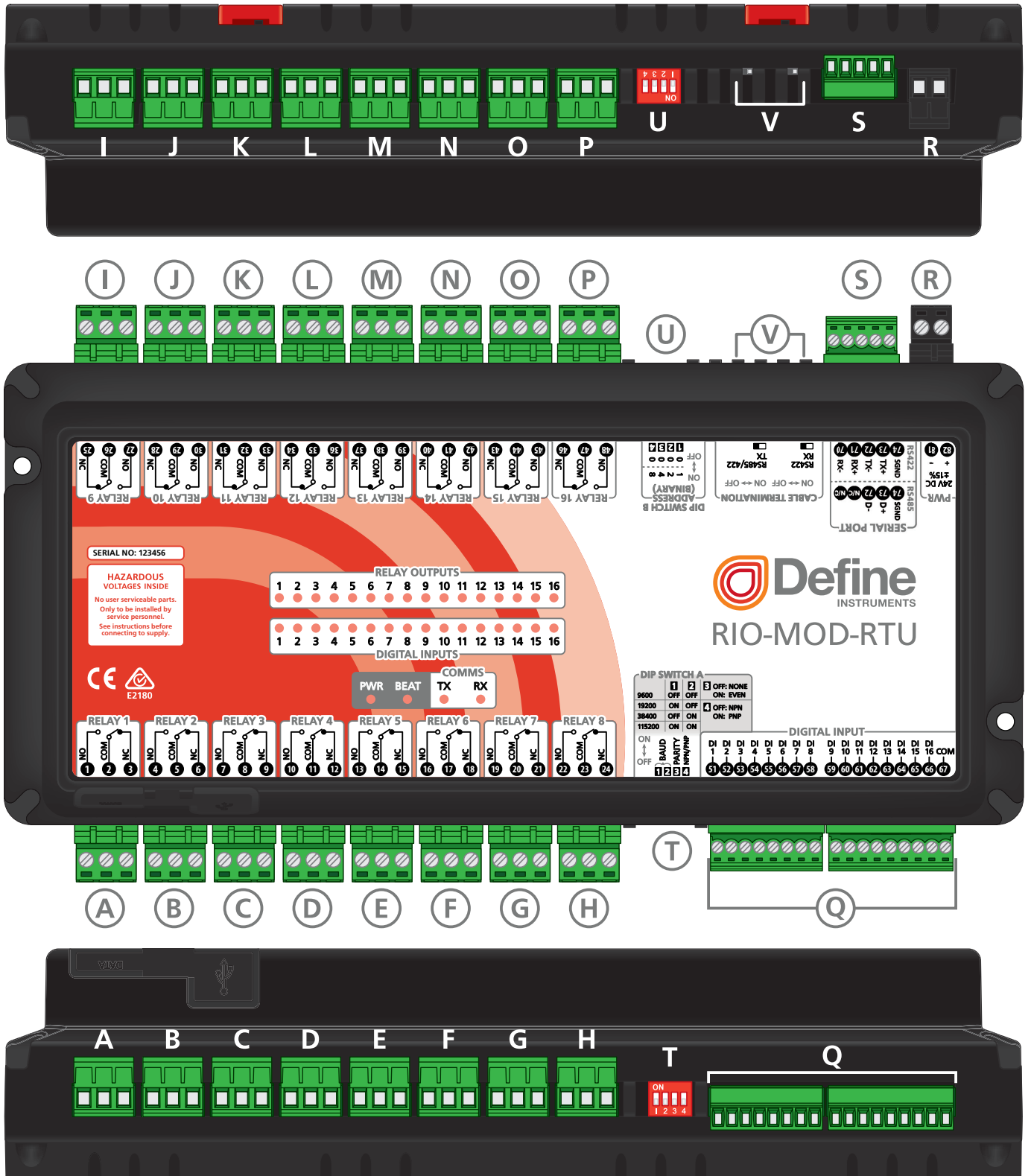

A Relay output 1	J Relay output 10	S RS485/RS422 serial port
B Relay output 2	K Relay output 11	T DIP switch A (baud rate, parity, NPN/PNP)
C Relay output 3	L Relay output 12	U DIP switch B (station address, binary)
D Relay output 4	M Relay output 13	V Cable termination switches
E Relay output 5	N Relay output 14	
F Relay output 6	O Relay output 15	
G Relay output 7	P Relay output 16	
H Relay output 8	Q Digital inputs 1–16	
I Relay output 9	R Power (24V DC $\pm 15\%$)	

1.2 - LED indicators

PWR illuminates when power is connected to the unit.

BEAT will flash every second to show that the unit is operating.

TX shows communication responses from the RIO-MOD-RTU to the Modbus master device. Under normal operating conditions, this LED should turn on with Modbus traffic.

RX shows communication requests from the Modbus master device to the RIO-MOD-RTU. Under normal operating conditions, this LED should turn on with Modbus traffic.

Relay output LEDs show the active state of relays 1–16. When the LED is off, the respective relay is de-energised, and when the LED is on, the respective relay is energised (see 2.1 for more information).

Digital input LEDs show the active state of digital inputs 1–16. If the LED is on, the respective digital input has been activated (see 2.2 for more information).

2

WIRING & DIP SWITCHES

2.1 - Relays 1–16

(see 1.1A–P)

The relay outputs are located along the upper and lower left sides of the unit (see 1.1A–P), and are wired as shown (right).

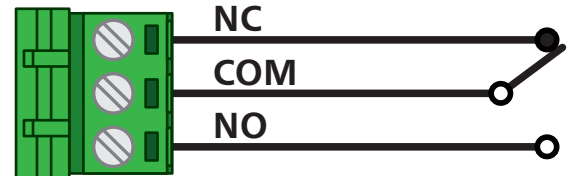

LED indicators

The **Relay Outputs** LED indi-

cators show the active state of each relay. If the LED is off, the respective relay is de-energised and the *COM* terminal is connected to the *NC* terminal. If the LED is on, the respective relay is energised and the *COM* terminal is switched to the *NO* terminal.

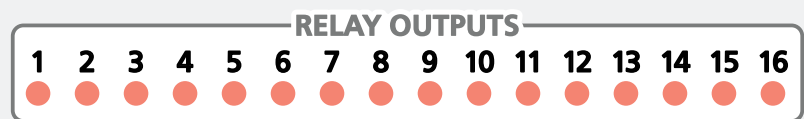

2.2 - Digital inputs 1–16

(see 1.1Q)

The digital inputs are located on the lower right side of the unit (see 1.1Q). The input type for digital inputs 1–16 must be set to either NPN or PNP using DIP switch A4 (see 2.5). Note that the 16 digital inputs must be either **all NPN** or **all PNP**, but could combine different types of sensors, as indicated below.

NPN (DIP switch A4: Off)

All digital inputs must be driven from outputs which can **sink** current (i.e. active low).

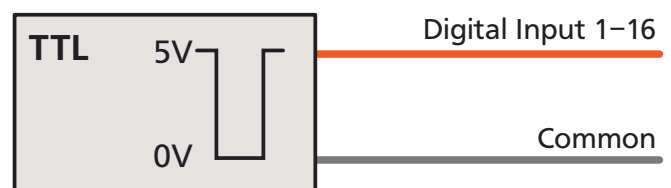
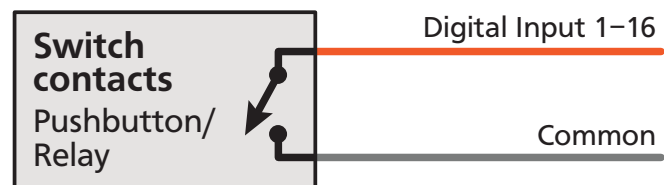
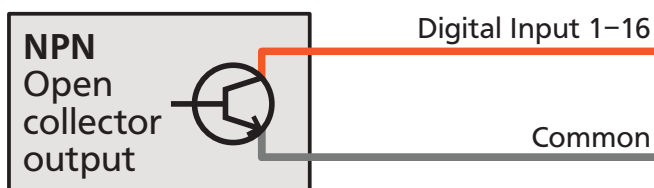

PNP (DIP switch A4: On)

All digital inputs must be driven from outputs which can **source** current (i.e. active high).

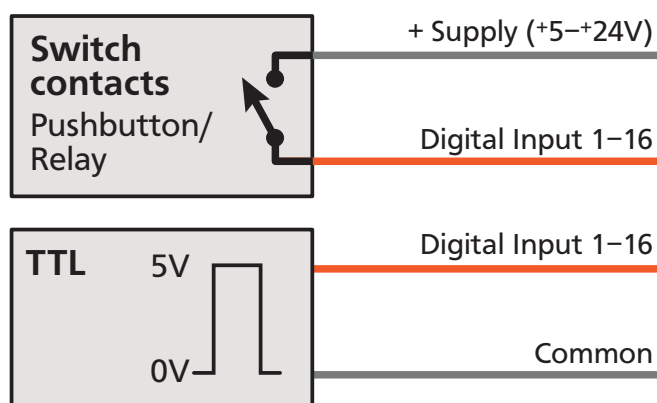
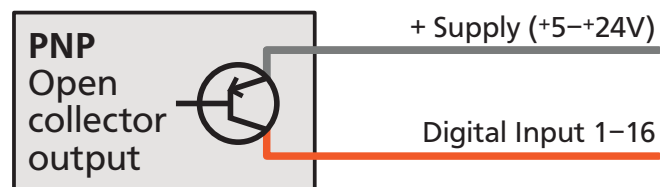

LED indicators

The **Digital Inputs** LED indi-

cators show the active state of each digital input. If the LED is on, the respective digital input has been activated. The input LED will always indicate the activated state of the input, regardless of what type of input is being used.



2.3 - Power

(see 1.1R)

The power terminal is located on the top side of the unit, in the far right corner (see 1.1R). The RIO-MOD-RTU accepts 24V DC supply ($\pm 15\%$).

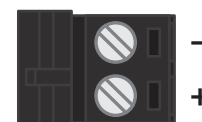

2.4 - RS485/422 serial port

(see 1.1S)

The serial port is located on the upper right side of the unit (see 1.1S), next to the power connector. It can be wired for either RS485 or RS422 serial connections, as shown (right).

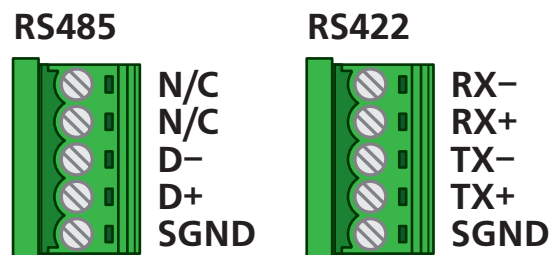

2.5 - DIP switch A

(see 1.1T)

DIP switch A is located on the lower side of the unit (see 1.1T). It is used to select the serial baud rate (**A1–2**), the serial parity (**A3**) and the digital input type (**A4**, see 2.2 for more information).



A1–2: Serial baud rate

Baud	A1	A2
9600	Off	Off
19200	On	Off
38400	Off	On
115200	On	On

A3: Serial parity

Parity	A3
None	Off
Even	On

A4: Digital input

Type	A4
NPN	Off
PNP	On

2.6 - DIP switch B, station address (binary)

(see 1.1U)

DIP switches **B1–4** form a binary code which is used to set the Modbus station address (from 1–15). Refer to the table below, OR add the On values for each switch, as indicated on the label (B1=1; B2=2; B3=4; B4=8).

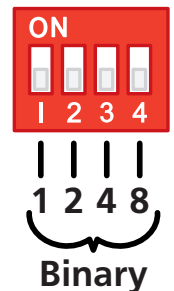

B1–4: Modbus station address

Address	B1	B2	B3	B4
Software	Off	Off	Off	Off
1	On	Off	Off	Off
2	Off	On	Off	Off
3	On	On	Off	Off
4	Off	Off	On	Off
5	On	Off	On	Off
6	Off	On	On	Off
7	On	On	On	Off
8	Off	Off	Off	On
9	On	Off	Off	On
10	Off	On	Off	On
11	On	On	Off	On
12	Off	Off	On	On
13	On	Off	On	On
14	Off	On	On	On
15	On	On	On	On

Note that if switches **B1–4** are all Off, the user programmable software station address will be used (see 3.4 to configure).

2.7 - RS485/422 termination switches (see 1.1V)

The cable termination switches are located on the upper side of the unit (see 1.1V), between the Serial Port and DIP switch B. They are used to switch 120Ω terminating resistors across the RS485/422 cable.

Note that these switches are very small, and can be moved by inserting a fine instrument (such as a small screwdriver) between the black strips. Switches are **On** when switched to the left, and **Off** when switched to the right.

For RS485 networks, only the switch labelled **RS485** is active.

For RS422 networks, the switch labelled **TX** terminates the Tx line, and the switch labelled **RX** terminates the Rx line.

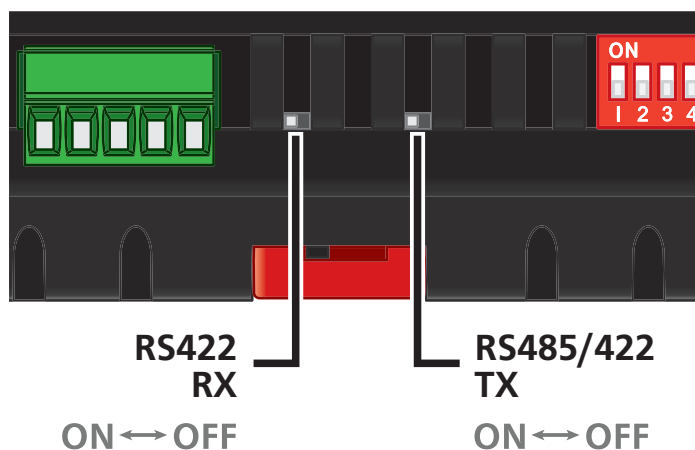

Notes:

- A** Care should be taken to ensure that there are never more than 2 sets of terminating resistors on any network. One set would normally be at the Modbus master end, and the other set at the other end of the network cable.
- B** The termination switches should only be set to **On** if the RIO-MOD-RTU module is the last module at the end of the RS485/422 network. For all other positions along the network cable these switches should be set to **Off**.

3.1 - Modbus specifications

Modbus type RTU slave device

Serial settings 8 data bits, 1 stop bit. Baud rate set by DIP switches A1–2. Parity set by DIP switch A3. See 2.5 for more information.

Slave address set by DIP switches B1–4. These switches form a binary code, selecting slave addresses 1–15. See 2.6 for more information.

Modbus frame size 256 bytes max (including function codes, address fields and CRC)

Supported Modbus function codes

- | | |
|--------------------------|-------------------------------------|
| 1: Read single coils | 2: Read single discrete inputs |
| 3: Read holding register | 4: Read input register |
| 5: Force single coil | 6: Write single holding register |
| 15: Force multiple coils | 16: Write multiple holding register |
-

Data types 1 bit registers; 16 bit unsigned registers. See Section 4 for more information.

3.2 - Addressing format

The addressing format used complies with the original Modicon* addressing scheme where registers specified in the address range of 40001–49999 are referenced as holding registers which can be read and written to with Modbus function codes 3 and 16 respectively.

The actual address sent in the Modbus frame is obtained by subtracting the value of 40001 from the register numbers shown in this document. So, for example, when accessing register 40001 this translates to a direct address in the frame of 0x0000.

*Modicon is a brand name owned by Schneider Electric.

3.3 - Relay auto shutoff feature

The auto shutoff feature will turn all relays off if the Modbus master device stops communicating with the RIO-MOD-RTU for more than a predefined time period. This could be due to a cable being pulled out or a malfunction with the Modbus master device.

The time period can be set by the user by writing a value between 0–255 to Modbus register 40023, where a count of 1 = 0.1 seconds timeout. This feature can be disabled by writing a value of 0 to register 40023. The default value for this is 20 (2.0 seconds).

3.4 - User programmable station address

In Modbus networks which have more than 15 stations, a software station address can be programmed when the unit is initially configured. This can be done as follows:

- A** Set DIP switch B (see 2.6) to station address 1 (B1=On; B2–4=Off).
- B** Remove any other units with station address=1 from the Modbus network.
- C** Connect your RIO-MOD unit to the Modbus network.
- D** Write the desired station address to Modbus register 40022.
- E** Set DIP switch B (see 2.6) to software station address (B1–4=Off).

You may now address the RIO-MOD on the new software station address. The software station address is saved in non-volatile memory, and is retained at power off.

Note: For Modbus register definitions, see Section 4.

4

MODBUS REGISTER DEFINITIONS

4.1 - Coils

Register	Name	Type	Description
01	Relay 1	Coil	Coil status for relay 1
02	Relay 2	Coil	Coil status for relay 2
03	Relay 3	Coil	Coil status for relay 3
04	Relay 4	Coil	Coil status for relay 4
05	Relay 5	Coil	Coil status for relay 5
06	Relay 6	Coil	Coil status for relay 6
07	Relay 7	Coil	Coil status for relay 7
08	Relay 8	Coil	Coil status for relay 8
09	Relay 9	Coil	Coil status for relay 9
10	Relay 10	Coil	Coil status for relay 10
11	Relay 11	Coil	Coil status for relay 11
12	Relay 12	Coil	Coil status for relay 12
13	Relay 13	Coil	Coil status for relay 13
14	Relay 14	Coil	Coil status for relay 14
15	Relay 15	Coil	Coil status for relay 15
16	Relay 16	Coil	Coil status for relay 16

4.2 - Discrete inputs

Register	Name	Type	Description
10001	Input 1	Discrete input	Input status for discrete input 1
10002	Input 2	Discrete input	Input status for discrete input 2
10003	Input 3	Discrete input	Input status for discrete input 3
10004	Input 4	Discrete input	Input status for discrete input 4
10005	Input 5	Discrete input	Input status for discrete input 5

10006	Input 6	Discrete input	Input status for discrete input 6
10007	Input 7	Discrete input	Input status for discrete input 7
10008	Input 8	Discrete input	Input status for discrete input 8
10009	Input 9	Discrete input	Input status for discrete input 9
10010	Input 10	Discrete input	Input status for discrete input 10
10011	Input 11	Discrete input	Input status for discrete input 11
10012	Input 12	Discrete input	Input status for discrete input 12
10013	Input 13	Discrete input	Input status for discrete input 13
10014	Input 14	Discrete input	Input status for discrete input 14
10015	Input 15	Discrete input	Input status for discrete input 15
10016	Input 16	Discrete input	Input status for discrete input 16

4.3 - 16 bit input registers (read only)

Register	Name	Type	Description
30001	Inputs 1-16	16 bit unsigned	16 digital inputs
30002– 30009	<i>Reserved for future development</i>		
30010	Outputs 1-16	16 bit unsigned	16 relay outputs
30011– 30019	<i>Reserved for future development</i>		
30020	Serial no LSW	16 bit unsigned	Serial number least significant word
30021	Serial no MSW	16 bit unsigned	Serial number most significant word
30022	Software address	8 bit unsigned	Software address <i>Only active when all switches in DIP switch B are set to off</i>
30023	Serial timeout	8 bit unsigned	Serial watchdog timeout <i>1 count=0.1 second. Valid range is from 1–255 (0.1–25.5 seconds).</i>

4.4 - 16 bit holding registers (read/write)

Register Name	Type	Description	
40001	Inputs 1-16	16 bit unsigned	16 digital inputs (read only)
40002– 40009	<i>Reserved for future development</i>		
40010	Outputs 1-16	16 bit unsigned	16 relay outputs (read/write)
40011– 40019	<i>Reserved for future development</i>		
40020	Serial no LSW	16 bit unsigned	Serial number least significant word (read only)
40021	Serial no MSW	16 bit unsigned	Serial number most significant word (read only)
40022	Software address	8 bit unsigned	Software address (read/write) <i>Default value = 1. Data is retained in non-volatile memory during power down**</i>
40023	Serial timeout	8 bit unsigned	Serial watchdog timeout (read/write) <i>1 count=0.1 second. Valid range is from 1–255 (0.1–25.5 seconds). Default value=2.0 seconds. Data is retained in non-volatile memory during power down**</i>

** Registers 40022 and 40023 are both stored in non-volatile memory and are retained at power down. Special care should be taken when writing to these registers so as not to exceed their maximum write cycle limit of 20,000 writes. For this reason these registers should not be written repeatedly during polling.



Define Instruments

New Zealand (Head Office)

 10B Vega Place, Mairangi Bay,
Auckland 0632, New Zealand
PO Box 245 Westpark Village,
Auckland 0661, New Zealand

Ph: +64 (9) 835-1550 | **Aus:** 1800 810-820

Fax: +64 (9) 835-1250

 sales@defineinstruments.co.nz

www.defineinstruments.co.nz

United States (Dallas, TX)

Ph: 214.926.4950

 sales@defineinstruments.com

www.defineinstruments.com

South Africa (Johannesburg)

Ph: 087 945 2700

 sales@defineinstruments.co.za

www.defineinstruments.co.za