

Instruction Manual

PN 51-Xmt-P/rev.C

February 2006

Model Solu Comp Xmt-P

pH, ORP, and Redox Transmitter



ESSENTIAL INSTRUCTIONS

READ THIS PAGE BEFORE PROCEEDING!

Rosemount Analytical designs, manufactures, and tests its products to meet many national and international standards. Because these instruments are sophisticated technical products, you must properly install, use, and maintain them to ensure they continue to operate within their normal specifications. The following instructions must be adhered to and integrated into your safety program when installing, using, and maintaining Rosemount Analytical products. Failure to follow the proper instructions may cause any one of the following situations to occur: Loss of life; personal injury; property damage; damage to this instrument; and warranty invalidation.

- Read all instructions prior to installing, operating, and servicing the product. If this Instruction Manual is not the correct manual, telephone 1-800-654-7768 and the requested manual will be provided. Save this Instruction Manual for future reference.
- If you do not understand any of the instructions, contact your Rosemount representative for clarification.
- Follow all warnings, cautions, and instructions marked on and supplied with the product.
- Inform and educate your personnel in the proper installation, operation, and maintenance of the product.
- Install your equipment as specified in the Installation Instructions of the appropriate Instruction Manual and per applicable local and national codes. Connect all products to the proper electrical and pressure sources.
- To ensure proper performance, use qualified personnel to install, operate, update, program, and maintain the product.
- When replacement parts are required, ensure that qualified people use replacement parts specified by Rosemount. Unauthorized parts and procedures can affect the product's performance and place the safe operation of your process at risk. Look alike substitutions may result in fire, electrical hazards, or improper operation.
- Ensure that all equipment doors are closed and protective covers are in place, except when maintenance is being performed by qualified persons, to prevent electrical shock and personal injury.

NOTICE

If a Model 375 Universal Hart® Communicator is used with these transmitters, the software within the Model 375 may require modification. If a software modification is required, please contact your local Emerson Process Management Service Group or National Response Center at 1-800-654-7768.

About This Document

This manual contains instructions for installation and operation of the Model Xmt-P Two-Wire pH/ORP Transmitter. The following list provides notes concerning all revisions of this document.

<u>Rev. Level</u>	<u>Date</u>	<u>Notes</u>
A	3/05	This is the initial release of the product manual. The manual has been reformatted to reflect the Emerson documentation style and updated to reflect any changes in the product offering. This manual contains information on HART Smart and FOUNDATION Fieldbus versions of Model Solu Comp Xmt-P.
B	9/05	Revise panel mount drawing. Add Foundation fieldbus agency approvals and FISCO version.
C	2/06	Revised the case specification on page 2. Added new drawings of FF and FI on section 4.0, pages 29-46.

Emerson Process Management

Liquid Division

2400 Barranca Parkway
Irvine, CA 92606 USA
Tel: (949) 757-8500
Fax: (949) 474-7250

<http://www.railhome.com>

QUICK START GUIDE

FOR MODEL SOLU COMP Xmt-P TRANSMITTER

1. Refer to page 11 for installation instructions.
2. Wire pH or ORP sensor to the transmitter. See Figure 2-3 for panel mount; Figure 2-4 or 2-5 for pipe or surface mount. Refer to the sensor instruction sheet for details.
3. Once connections are secure and verified, apply power to the transmitter.
4. When the transmitter is powered up for the first time, **Quick Start** screens appear. Using **Quick Start** is easy.
 - a. A blinking field shows the position of the cursor.
 - b. Use the ◀ or ▶ key to move the cursor left or right. Use the ▲ or ▼ key to move the cursor up or down or to increase or decrease the value of a digit. Use the ▲ or ▼ key to move the decimal point.
 - c. Press ENTER to store a setting. Press EXIT to leave without storing changes. Pressing EXIT also returns the display to the previous screen.

Measure?	pH
Redox	ORP

5. Choose measurement: **pH**, **ORP**, or **Redox**.

Use Preamplifier in?	
Xmtr	Sensor/JBox

6. Choose preamplifier location. Select **Xmtr** to use the integral preamplifier in the transmitter; select **Sensor/JBox** if your sensor has an integral preamplifier or if you are using a remote preamplifier located in a junction box.

Temperature in?	
C	F

7. Choose temperature units: **°C** or **°F**.

8. To change output settings, to scale the 4-20 mA output, to change measurement-related settings from the default values, and to set security codes, press MENU. Select Program and follow the prompts. Refer to the appropriate menu tree (page 5 or 6).

9. To return the transmitter to default settings, choose **ResetAnalyzer** in the Program menu.

MODEL XMT-P pH/ORP TWO-WIRE TRANSMITTER

TABLE OF CONTENTS

Section	Title	Page
1.0	DESCRIPTION AND SPECIFICATIONS	1
1.1	Features and Applications.....	1
1.2	Specifications	2
1.3	Hazardous Location Approval	4
1.4	Menu Tree for Model Xmt-P-HT	5
1.5	Menu Tree for Model Xmt-P-FF	6
1.6	HART Communications.....	7
1.7	FOUNDATION Fieldbus	7
1.8	Asset Management Solutions	8
1.9	Ordering Information	10
1.10	Accessories	10
2.0	INSTALLATION	11
2.1	Unpacking and Inspection.....	11
2.2	Pre-Installation Set Up	11
2.3	Installation	13
3.0	WIRING.....	17
3.1	Power Supply / Current Loop — Model Xmt-P-HT	17
3.2	Power Supply Wiring for Model Xmt-P-FF	18
3.2	Sensor Wiring	19
4.0	INTRINSICALLY SAFE INSTALLATION.....	20
5.0	DISPLAY AND OPERATION	47
5.1	Display	47
5.2	Keypad.....	47
5.3	Programming and Calibrating the Model Xmt — Tutorial.....	48
5.4	Menu Trees - pH	49
5.5	Diagnostic Messages - pH	49
5.6	Security	52
5.7	Using Hold	52
6.0	OPERATION WITH MODEL 375.....	53
6.1	Note on Model 375 HART and Foundation Fieldbus Communicator.....	53
6.2	Connecting the HART and Foundation Fieldbus Communicator	53
6.3	Operation	54
7.0	PROGRAMMING THE TRANSMITTER.....	69
7.1	General	69
7.2	Changing Start-up Settings	69
7.3	Configuring and Ranging the Output	70
7.4	Choosing and Configuring the Analytical Measurement	73
7.5	Choosing Temperature Units and Manual or Auto Temperature Compensation	75
7.6	Setting a Security Code	76
7.7	Making HART-Related Settings	77
7.8	Noise Reduction.....	77
7.9	Resetting Factory Calibration and Factory Default Settings	77
7.10	Selecting a Default Screen and Screen Contrast	78

TABLE OF CONTENTS CONT'D

8.0	CALIBRATION — TEMPERATURE	79
8.1	Introduction	79
8.2	Calibrating Temperature.....	79
9.0	CALIBRATION — pH	81
9.1	Introduction	81
9.2	Procedure — Auto Calibration	82
9.3	Procedure — Manual Two-Point Calibration	84
9.4	Procedure — Standardization	85
9.5	Procedure — Entering a Known Slope Value	86
9.6	ORP Calibration	87
10.0	TROUBLESHOOTING	88
10.1	Overview	88
10.2	Troubleshooting When a Fault or Warning Message is Showing	89
10.3	Troubleshooting When No Fault Message is Showing — Temp	92
10.4	Troubleshooting When No Fault Message is Showing — HART	92
10.5	Troubleshooting When No Fault Message is Showing — pH	92
10.6	Troubleshooting Not Related to Measurement Problems	95
10.7	Simulating Inputs — pH	95
10.8	Simulating Temperature	96
10.9	Measuring Reference Voltage.....	97
11.0	MAINTENANCE	98
11.1	Overview	98
11.2	Replacement Parts	98
12.0	pH MEASUREMENTS	99
12.1	General	99
12.2	Measuring Electrode	100
12.3	Reference Electrode	100
12.4	Liquid Junction Potential	101
12.5	Converting Voltage to pH	101
12.6	Glass Electrode Slope	102
12.7	Buffers and Calibration	102
12.8	Isopotential pH.....	103
12.9	Junction Potential Mismatch	103
12.10	Sensor Diagnostics	104
12.11	Shields, Insulation, and Preamplifiers.....	104

continued on following page

TABLE OF CONTENTS CONT'D

13.0	ORP MEASUREMENTS.....	105
13.1	General	105
13.2	Measuring Electrode	106
13.3	Reference Electrode	106
13.4	Liquid Junction Potential	106
13.5	Relating Cell Voltage to ORP	107
13.6	ORP, Concentration, and pH.....	107
13.7	Interpreting ORP Measurements	108
13.8	Calibration	109
14.0	THEORY — REMOTE COMMUNICATIONS.....	111
14.1	Overview of HART Communications.....	111
14.2	HART Interface Devices.....	111
14.3	Asset Management Solutions	112
15.0	RETURN OF MATERIAL.....	113

LIST OF TABLES

Number	Title	Page
11-1	Replacement Parts for Model Xmt-P — Panel Mount Version	98
11-2	Replacement Parts for Model Xmt-P — Pipe/Surface Mount Version	98

LIST OF FIGURES

Number	Title	Page
1-1	Menu Tree — Xmt-P-HT.....	5
1-2	Menu Tree — Xmt-P-FF.....	6
1-3	Configuring Model XMT Transmitter with FOUNDATION Fieldbus.....	7
1-4	HART Communicators.....	8
1-5	AMS Main Menu Tools.....	9
2-1	Removing the Knockouts.....	13
2-2	Power Supply / Current Loop Wiring.....	13
2-3	Panel Mount Installation.....	14
2-4	Pipe Mount Installation.....	15
2-5	Surface Mount Installation.....	16
3-1	Load/Power Supply Requirements.....	17
3-2	Power Supply / Current Loop Wiring.....	17
3-3	Typical Fieldbus Network Electrical Wiring Configuration.....	18
3-4	Loop Power and Sensor Wiring.....	18
3-5	Wiring and Preamplifier Configurations for pH and ORP Sensors.....	19
4-1	FM Intrinsically Safe Label for Model XMT-P-HT.....	20
4-2	FM Intrinsically Safe Installation for Model XMT-P-HT (1 of 2).....	21
4-3	FM Intrinsically Safe Installation for Model XMT-P-HT (2 of 2).....	22
4-4	CSA Intrinsically Safe Label for Model XMT-P-HT.....	23
4-5	CSA Intrinsically Safe Installation for Model XMT-P-HT (1 of 2).....	24
4-6	CSA Intrinsically Safe Installation for Model XMT-P-HT (2 of 2).....	25
4-7	ATEX Intrinsically Safe Label for Model XMT-P-HT.....	26
4-8	ATEX Intrinsically Safe Installation for Model XMT-P-HT (1 of 2).....	27
4-9	ATEX Intrinsically Safe Installation for Model XMT-P-HT (2 of 2).....	28
4-10	FM Intrinsically Safe Label for Model XMT-P-FF.....	29
4-11	FM Intrinsically Safe Installation for Model XMT-P-FF (1 of 2).....	30
4-12	FM Intrinsically Safe Installation for Model XMT-P-FF (2 of 2).....	31
4-13	CSA Intrinsically Safe Label for Model XMT-P-FF.....	32
4-14	CSA Intrinsically Safe Installation for Model XMT-P-FF (1 of 2).....	33
4-15	CSA Intrinsically Safe Installation for Model XMT-P-FF (2 of 2).....	34
4-16	ATEX Intrinsically Safe Label for Model XMT-P-FF.....	35
4-17	ATEX Intrinsically Safe Installation for Model XMT-P-FF (1 of 2).....	36
4-18	ATEX Intrinsically Safe Installation for Model XMT-P-FF (2 of 2).....	37
4-19	FM Intrinsically Safe Label for Model XMT-P-FI.....	38
4-20	FM Intrinsically Safe Installation for Model XMT-P-FI (1 of 2).....	39
4-21	FM Intrinsically Safe Installation for Model XMT-P-FI (2 of 2).....	40
4-22	CSA Intrinsically Safe Label for Model XMT-P-FI.....	41
4-23	CSA Intrinsically Safe Installation for Model XMT-P-FI (1 of 2).....	42
4-24	CSA Intrinsically Safe Installation for Model XMT-P-FI (2 of 2).....	43
4-25	ATEX Intrinsically Safe Label for Model XMT-P-FI.....	44
4-26	ATEX Intrinsically Safe Installation for Model XMT-P-FI (1 of 2).....	45
4-27	ATEX Intrinsically Safe Installation for Model XMT-P-FI (2 of 2).....	46
5-1	Displays During Normal Operation.....	29
5-2	Solu Comp Xmt Keypad.....	29
5-3	Menu Tree for Model Xmt-P-HT.....	32
5-4	Menu Tree for Model Xmt-P-FF.....	33
6-1	Connecting the Model 375 Communicator.....	35
6-2	XMT-P-HT HART / Model 375 Menu Tree.....	37
6-3	XMT-P-HT Foundation Fieldbus / Model 375 Menu Tree.....	39

LIST OF FIGURES CONT'D

Number	Title	Page
9-1	Calibration Slope and Offset	63
10-1	Simulate pH.....	77
10-2	Three-Wire RTD Configuration.....	78
10-3	Simulating RTD Inputs	78
10-4	Checking for a Poisoned Reference Electrode	79
12-1	pH Measurement Cell.....	81
12-2	Measuring Electrode (pH)	82
12-3	Cross-Section Through the pH Glass.....	82
12-4	Reference Electrode.....	83
12-5	The Origin of Liquid Junction Potential.....	83
12-6	Glass Electrode Slope.....	84
12-7	Two-Point Buffer Calibration.....	85
12-8	Liquid Junction Potential Mismatch	86
13-1	ORP Measurement Cell	87
13-2	Measuring Electrode (ORP)	88
13-3	Reference Electrode.....	88
13-4	The Origin of Liquid Junction Potential.....	89
13-5	Electrode Potential	89
13-6	ORP Measurement Interpretation.....	90
14-1	HART Communicators.....	93
14-2	AMS Main Menu Tools	94

SECTION 1.0 DESCRIPTION AND SPECIFICATIONS

Model Xmt Family of Two-wire Transmitters

- CHOICE OF COMMUNICATION PROTOCOLS: HART® or FOUNDATION® Fieldbus
- CLEAR, EASY-TO-READ two-line display shows commissioning menus and process measurement displays in English
- SIMPLE TO USE MENU STRUCTURE
- CHOICE OF PANEL OR PIPE/SURFACE MOUNTING
- NON-VOLATILE MEMORY retains program settings and calibration data during power failures
- SIX LOCAL LANGUAGES - English, French, German, Italian, Spanish and Portuguese



1.1 FEATURES AND APPLICATIONS

The Solu Comp Model Xmt family of transmitters can be used to measure pH, ORP, conductivity (using either contacting or toroidal sensors), resistivity, oxygen (ppm and ppb level), free chlorine, total chlorine, monochloramine and ozone in a variety of process liquids. The Xmt is compatible with most Rosemount Analytical sensors. See the Specification sections for details.

The transmitter has a rugged, weatherproof, corrosion-resistant enclosure (NEMA 4X and IP65). The panel mount version fits standard ½ DIN panel cutouts, and its shallow depth is ideally suited for easy mounting in cabinet-type enclosures. A panel mount gasket is included to maintain the weather rating of the panel. Surface/pipe mount enclosure includes self-tapping screws for surface mounting. A pipe mounting accessory kit is available for mounting to a 2-inch pipe.

The transmitter has a two-line 16-character display. Menu screens for calibrating and registering choices are simple and intuitive. Plain language prompts guide the user through the procedures. There are no service codes to enter before gaining access to menus.

Two digital communication protocols are available: HART (model option -HT) and FOUNDATION fieldbus (model option -FF or -FI). Digital communications allow access to AMS (Asset Management Solutions). Use AMS to set up and configure the transmitter, read process variables, and troubleshoot problems from a personal computer or host anywhere in the plant.

The seven-button membrane-type keypad allows local programming and calibrating of the transmitter. The HART Model 375 communicator can also be used for programming and calibrating the transmitter.

The Model Xmt-P Transmitter with the appropriate sensor

measures dissolved oxygen (ppm and ppb level), free chlorine, total chlorine, monochloramine, and ozone in water and aqueous solutions. The transmitter is compatible with Rosemount Analytical 499A amperometric sensors for oxygen, chlorine, monochloramine, and ozone; and with Hx438, Bx438, and Gx448 steam-sterilizable oxygen sensors.

For free chlorine measurements, both automatic and manual pH correction are available. pH correction is necessary because amperometric free chlorine sensors respond only to hypochlorous acid, not free chlorine, which is the sum of hypochlorous acid and hypochlorite ion. To measure free chlorine, most competing instruments require an acidified sample. Acid lowers the pH and converts hypochlorite ion to hypochlorous acid. The Model Xmt-P eliminates the need for messy and expensive sample conditioning by measuring the sample pH and using it to correct the chlorine sensor signal. If the pH is relatively constant, a fixed pH correction can be used, and the pH measurement is not necessary. If the pH is greater than 7.0 and fluctuates more than about 0.2 units, continuous measurement of pH and automatic pH correction is necessary. See Specifications section for recommended pH sensors. Corrections are valid to pH 9.5.

The transmitter fully compensates oxygen, ozone, free chlorine, total chlorine, and monochloramine readings for changes in membrane permeability caused by temperature changes.

For pH measurements — pH is available with free chlorine only — the Xmt-P features automatic buffer recognition and stabilization check. Buffer pH and temperature data for commonly used buffers are stored in the transmitter. Glass impedance diagnostics warn the user of an aging or failed pH sensor.

1.2 SPECIFICATIONS

1.2.1 GENERAL SPECIFICATIONS

Case: ABS (panel mount), polycarbonate (pipe/wall mount); NEMA 4X/CSA 4 (IP65)

Dimensions

Panel (code -10): 6.10 x 6.10 x 3.72 in. (155 x 155 x 94.5 mm)

Surface/Pipe (code -11): 6.23 x 6.23 x 3.23 in. (158 x 158 x 82 mm); see page 15 for dimensions of pipe mounting bracket.

Conduit openings: Accepts PG13.5 or 1/2 in. conduit fittings

Ambient Temperature: 32 to 122°F (0 to 50°C). Some degradation of display above 50°C.

Storage Temperature: -4 to 158°F (-20 to 70°C)

Relative Humidity: 10 to 90% (non-condensing)

Weight/Shipping Weight: 2 lb/3 lb (1 kg/1.5 kg)

Display: Two line, 16-character display. Character height: 4.8 mm; first line shows process variable (pH, ORP, conductivity, % concentration, oxygen, ozone, chlorine, or monochloramine), second line shows process temperature and output current. For pH/chlorine combination, pH may also be displayed. Fault and warning messages, when triggered, alternate with temperature and output readings.

During calibration and programming, messages, prompts, and editable values appear on the two-line display.

Temperature resolution: 0.1°C ($\leq 99.9^\circ\text{C}$);
1°C ($\geq 100^\circ\text{C}$)

Hazardous Location Approval: For details, see specifications for the measurement of interest.

RFI/EMI: EN-61326 

Solu Comp is a registered trademark of Rosemount Analytical.

Xmt is a trademark of Rosemount Analytical.

HART is a registered trademark of the HART Communication Foundation.

FOUNDATION is a registered trademark of Fieldbus Foundation.

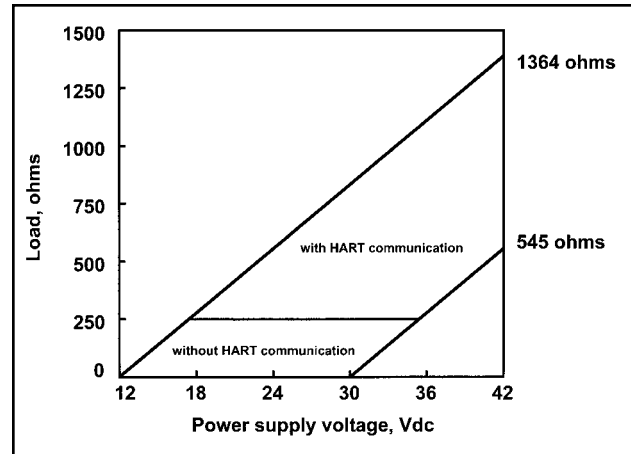

DIGITAL COMMUNICATIONS:

HART —

Power & Load Requirements: Supply voltage at the transmitter terminals should be at least 12 Vdc. Power supply voltage should cover the voltage drop on the cable plus the external load resistor required for HART communications (250 Ω minimum). Minimum power supply voltage is 12 Vdc. Maximum power supply voltage is 42.4 Vdc. The graph shows the supply voltage required to maintain 12 Vdc (upper line) and 30 Vdc (lower line) at the transmitter terminals when the current is 22 mA.

Analog Output: Two-wire, 4-20 mA output with superimposed HART digital signal. Fully scalable over the operating range of the sensor.

Output accuracy: ± 0.05 mA

FOUNDATION FIELDBUS —

Power & Load Requirements: A power supply voltage of 9-32 Vdc at 13 mA is required.

Fieldbus Intrinsically Safe **CO**ncept/FISCO-compliant versions of Model Xmt Foundation Fieldbus transmitters are available.

1.2.2 FUNCTIONAL SPECIFICATIONS

pH Range: 0 to 14

ORP Range: -1400 to +1400mV

Calibrations/standardization: The automatic buffer recognition uses stored buffer values and their temperature curves for the most common buffer standards available worldwide. The transmitter also performs a stabilization check on the sensor in each buffer.

A manual two-point calibration is made by immersing the sensor in two different buffer solutions and entering the pH values. The microprocessor automatically calculates the slope which is used for self-diagnostics. An error message will be displayed if the pH sensor is faulty. This slope can be read on the display and/or manually adjusted if desired.

An on-line one-point process standardization is accomplished by entering the pH or ORP value of a grab sample.

Preamplifier Location: A preamplifier must be used to convert the high impedance pH electrode signal to a low impedance signal for transmitter use. The integral preamplifier of the Model Xmt-P may be used when the sensor to transmitter distance is less than 15 ft (4.5 m). Locate the preamplifier in the sensor or junction box for longer distances.

Automatic Temperature Compensation: External 3-wire Pt100 RTD or Pt1000 RTD located in the sensor, compensates the pH reading for temperature fluctuations. Compensation covers the range -15 to 130°C (5 to 270°F). Manual temperature compensation is also selectable.

Accuracy: ±1.4 mV @ 25°C ±0.01 pH

Repeatability: ±1 mV @ 25°C ±0.01 pH

Diagnostics: The internal diagnostics can detect:

- | | |
|--------------------------|-------------------|
| Calibration Error | Sensor Failure |
| High Temperature Warning | CPU Failure |
| Low Temperature Warning | Input Warning |
| ROM Failure | Glass Warning |
| Glass Failure | Reference Warning |
| Reference Failure | |

Once one of the above is diagnosed, the display will show a message describing the problem.

DIGITAL COMMUNICATIONS:

HART (pH): PV assigned to pH. SV, TV, and 4V assignable to pH, temperature, mV, glass impedance, reference impedance, or RTD resistance.

HART (ORP): PV assigned to ORP. SV, TV, and 4V assignable to ORP, temperature, reference impedance, or RTD resistance.

Fieldbus (pH): Four AI blocks assigned to pH, temperature, reference impedance, and glass impedance.

Fieldbus (ORP): Three AI blocks assigned to ORP, temperature, and reference impedance.

Fieldbus (pH and ORP): Execution time 75 msec. One PID block; execution time 150 msec. Device type 4085. Device revision 1. Certified to ITK 4.5.

SENSOR COMPATIBILITY CHART	
pH/ORP SENSOR	DIAGNOSTIC CAPABILITY
320B	Glass and Reference
330B	Glass and Reference
320HP-58	Glass only
328A	Glass only
370	Glass only
371	Glass only
372	Glass only
381 pHE-31-41-52	Glass only
381+	Glass and Reference
385-08-53	Glass only
385+	Glass and Reference
389-02-54 / 389VP-54	Glass only
396-54-62 / 396VP	Glass only
396P-55 / 396PVP-55	Glass and Reference
396R / 396RVP-54	Glass and Reference
397-54-62	Glass only
398-54-62 / 398VP-54	Glass only
398R-54-62 / 398RVP-54	Glass and Reference
399-09-62 / 399VP-09	Glass only
399-10 / 399-14	Glass only
399-33	none
Hx338	Glass only
Hx348	Glass only
TF396	none

1.3 HAZARDOUS LOCATION APPROVALS**Intrinsic Safety:**

Class I, II, III, Div. 1
Groups A-G
T4 Tamb = 50°C



Class I, II, III, Div. 1
Groups A-G
T4 Tamb = 50°C

ATEX

CE 1180 II 1 G



Baseefa04ATEX0213X
EEx ia IIC T4
Tamb = 0°C to 50°C

Non-Incendive:

Class I, Div. 2, Groups A-D
Dust Ignition Proof
Class II & III, Div. 1, Groups E-G
NEMA 4/4X Enclosure



Class I, Div. 2, Groups A-D
Dust Ignition Proof
Class II & III, Div. 1, Groups E-G
NEMA 4/4X Enclosure
T4 Tamb = 50°C

1.4 MENU TREE FOR MODEL XMT-P-HT

FIGURE 1-1. MENU TREE FOR MODEL SOLU COMP Xmt-P-HT TRANSMITTER

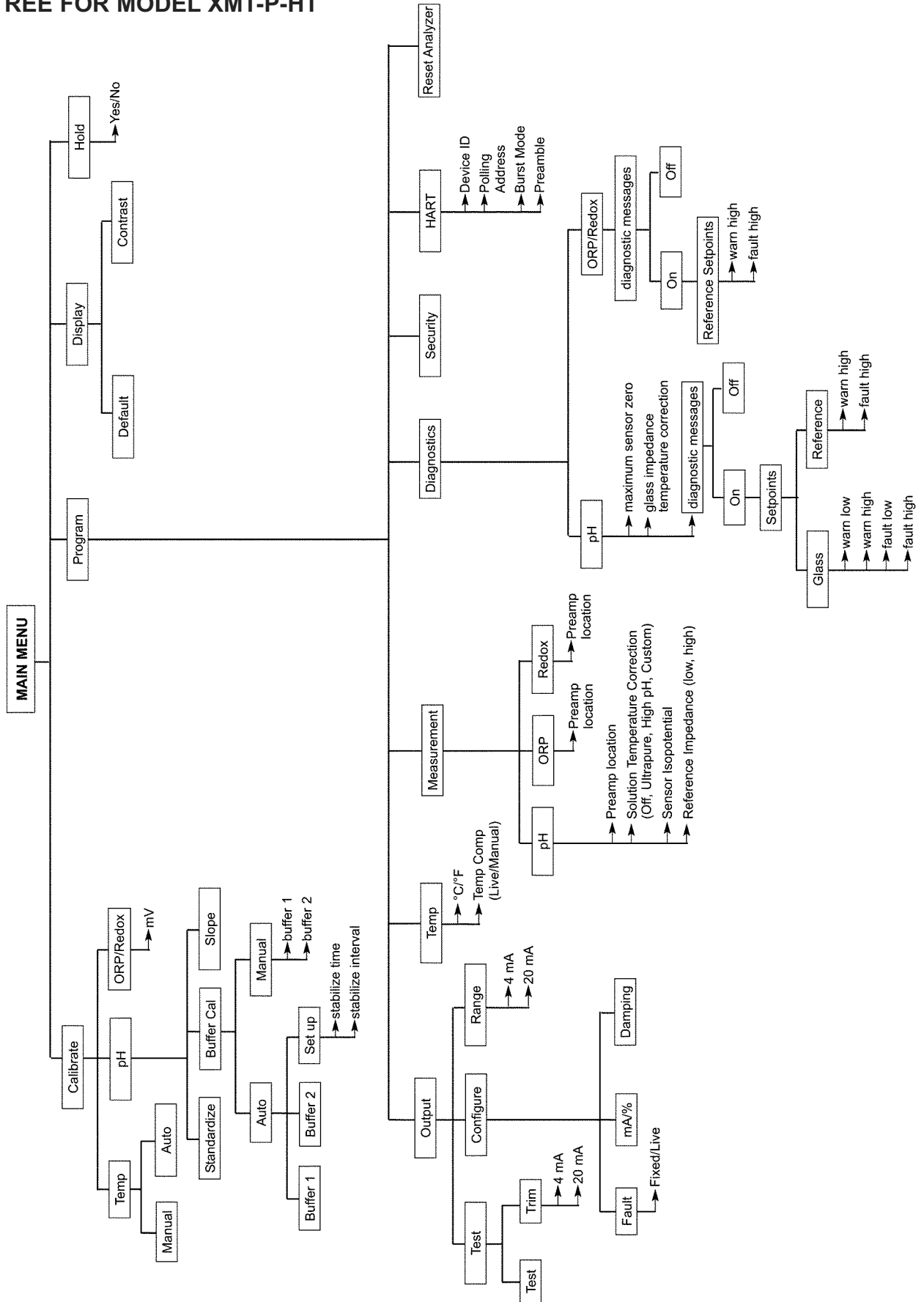

1.5 MENU TREE FOR MODEL XMT-P-FF

FIGURE 1-2. MENU TREE FOR MODEL SOLU COMP Xmt-P-FF TRANSMITTER

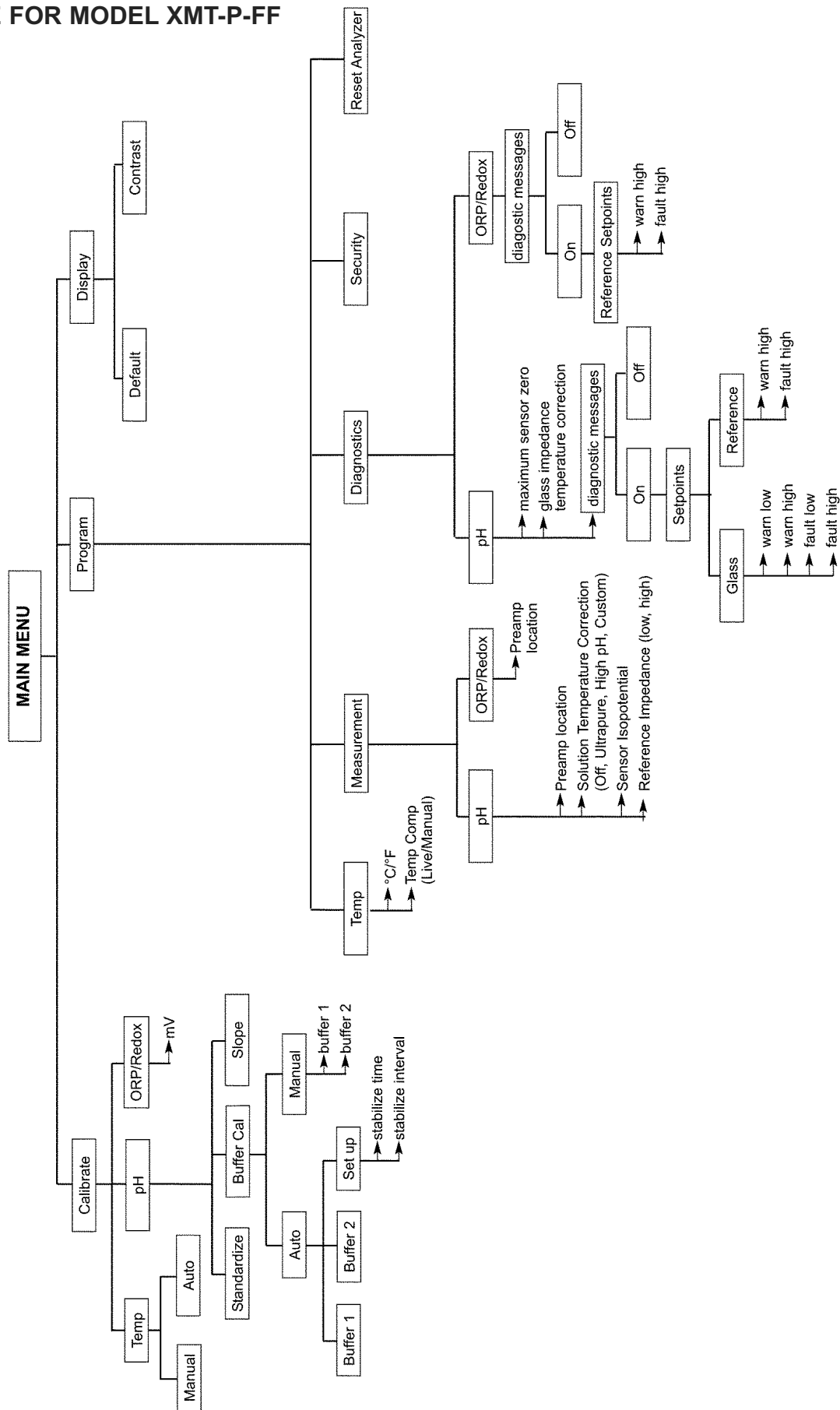

1.6 HART COMMUNICATIONS

1.6.1 OVERVIEW OF HART COMMUNICATION

HART (highway addressable remote transducer) is a digital communication system in which two frequencies are superimposed on the 4 to 20 mA output signal from the transmitter. A 1200 Hz sine wave represents the digit 1, and a 2400 Hz sine wave represents the digit 0. Because the average value of a sine wave is zero, the digital signal adds no dc component to the analog signal. HART permits digital communication while retaining the analog signal for process control.

The HART protocol, originally developed by Fisher-Rosemount, is now overseen by the independent HART Communication Foundation. The Foundation ensures that all HART devices can communicate with one another. For more information about HART communications, call the HART Communication Foundation at (512) 794-0369. The internet address is <http://www.hartcomm.org>.

1.6.2 HART INTERFACE DEVICES

The Model 375 HART Communicator is a hand-held device that provides a common link to all HART SMART instruments and allows access to AMS (Asset Management Solutions). Use the HART communicator to set up and control the Xmt-P-HT and to read measured variables. Press ON to display the on-line menu. All setup menus are available through this menu.

HART communicators allow the user to view measurement data (pH, ORP and temperature), program the transmitter, and download information from the transmitter for transfer to a computer for analysis. Downloaded information can also be sent to another HART transmitter. Either a hand-held communicator, such as the Rosemount Model 375, or a computer can be used. HART interface devices operate from any wiring termination point in the 4 - 20 mA loop. A minimum load of 250 ohms must be present between the transmitter and the power supply. See Figure 1-4.

If your communicator does not recognize the Model XMT pH/ORP transmitter, the device description library may need updating. Call the manufacturer of your HART communication device for updates.

1.7 FOUNDATION FIELDBUS

Figure 1-3 shows a Xmt-P-FF being used to measure and control pH and chlorine levels in drinking water. The figure also shows three ways in which Fieldbus communication can be used to read process variables and configure the transmitter.

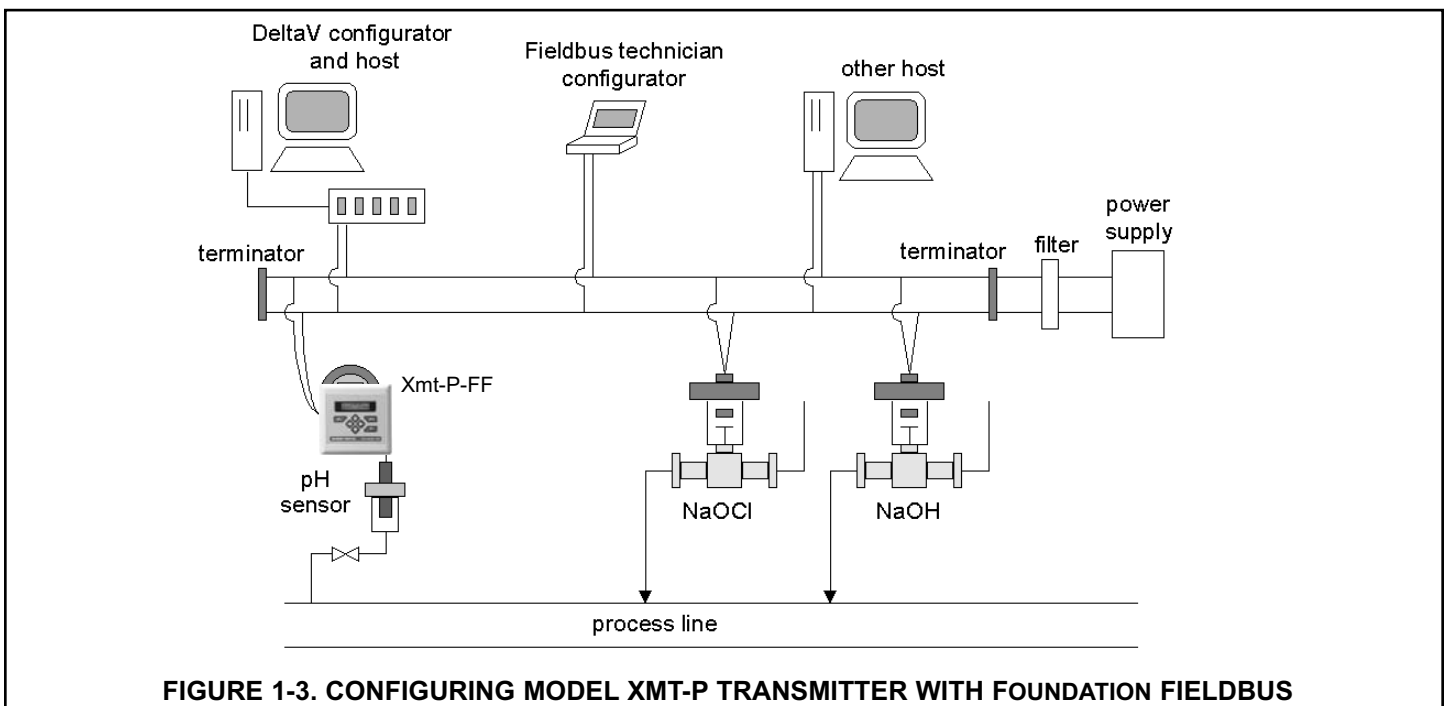

FIGURE 1-3. CONFIGURING MODEL XMT-P TRANSMITTER WITH FOUNDATION FIELDBUS

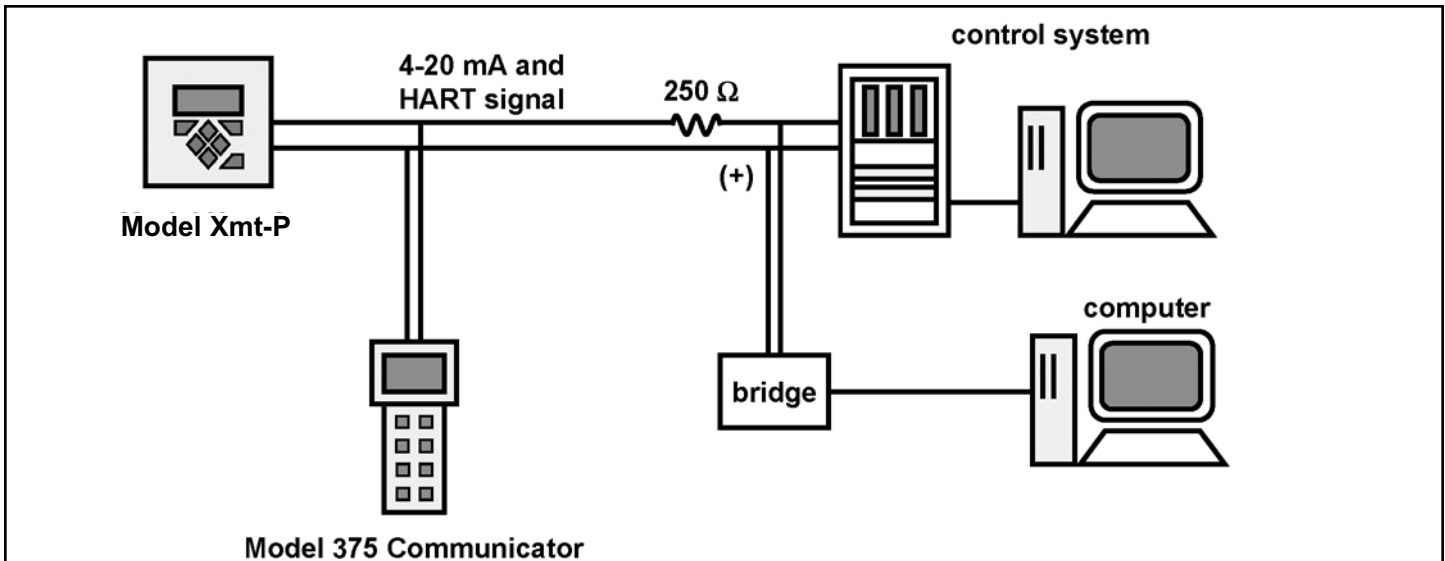

FIGURE 1-4. HART Communicators.

Both the Rosemount Model 375 (or 275) and a computer can be used to communicate with a HART transmitter. The 250 ohm load (minimum) must be present between the transmitter and the power supply.

1.8 ASSET MANAGEMENT SOLUTIONS

Asset Management Solutions (AMS) is software that helps plant personnel better monitor the performance of analytical instruments, pressure and temperature transmitters, and control valves. Continuous monitoring means maintenance personnel can anticipate equipment failures and plan preventative measures before costly breakdown maintenance is required.

AMS uses remote monitoring. The operator, sitting at a computer, can view measurement data, change program settings, read diagnostic and warning messages, and retrieve historical data from any HART-compatible device, including the Model XMT-P transmitter. Although AMS allows access to the basic functions of any HART compatible device, Rosemount Analytical has developed additional software for that allows access to all features of the Model XMT-P transmitter.

AMS can play a central role in plant quality assurance and quality control. Using AMS Audit Trail, plant operators can track calibration frequency and results as well as warnings and diagnostic messages. The information is available to Audit Trail whether calibrations were done using the infrared remote controller, the Model 375 HART communicator, or AMS software.

AMS operates in Windows 95. See Figure 1-5 for a sample screen. AMS communicates through a HART-compatible modem with any HART transmitters, including those from other manufacturers. AMS is also compatible with FOUNDATION™ Fieldbus, which allows future upgrades to Fieldbus instruments.

Rosemount Analytical AMS windows provide access to all transmitter measurement and configuration variables. The user can read raw data, final data, and program settings and can reconfigure the transmitter from anywhere in the plant.

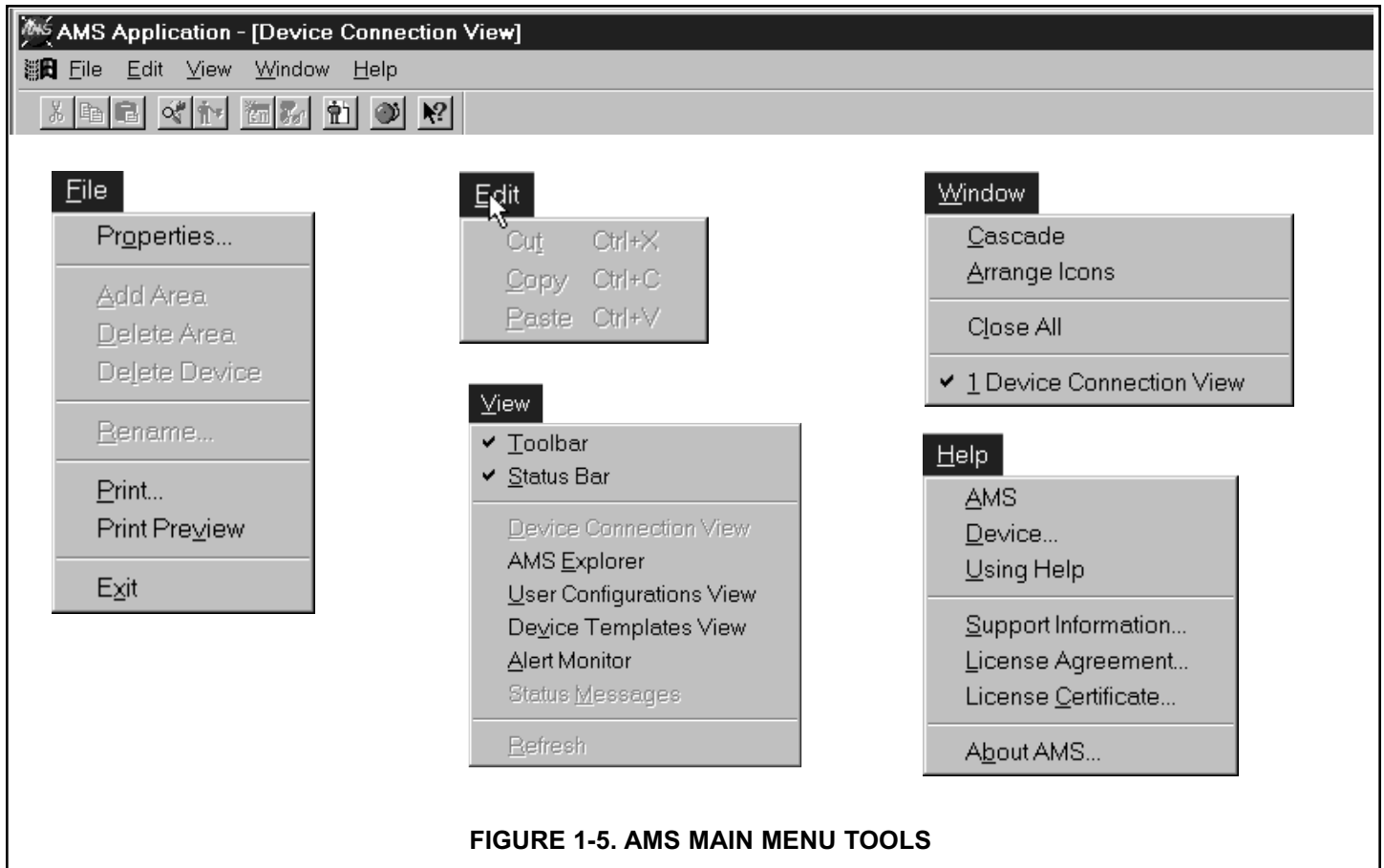

FIGURE 1-5. AMS MAIN MENU TOOLS

1.9 ORDERING INFORMATION

The Solu Comp Model Xmt Two-Wire Transmitter is intended for the determination of pH, ORP, or Redox.

MODEL	
Xmt	SMART TWO-WIRE MICROPROCESSOR TRANSMITTER
CODE	REQUIRED SELECTION
P	pH/ORP
CODE	REQUIRED SELECTION
HT	Analog 4-20 mA output with superimposed HART digital signal
FF	Foundation fieldbus digital output
FI	Foundation fieldbus digital output with FISCO
CODE	REQUIRED SELECTION
10	Panel mounting enclosure
11	Pipe/Surface mounting enclosure (pipe mounting requires accessory kit PN 23820-00)
CODE	AGENCY APPROVALS
60	No approval
67	FM approved intrinsically safe and non-incendive (when used with appropriate sensor and safety barrier)
69	CSA approved intrinsically safe and non-incendive (when used with appropriate sensor and safety barrier)
73	ATEX approved intrinsically safe (when used with appropriate sensor and safety barrier)
Xmt-P-HT-10-67 EXAMPLE	

1.10 ACCESSORIES

POWER SUPPLY: Use the Model 515 Power Supply to provide dc loop power to the transmitter. The Model 515 provides two isolated sources at 24Vdc and 200 mA each. For more information refer to product data sheet 71-515.

ALARM MODULE: The Model 230A alarm Module receives the 4-20 mA signal from the Xmt-P-HT transmitter and activates two alarm relays. High/high, low/low, and high/low are available. Hysteresis (deadband) is also adjustable. For more information, refer to product data sheet 71-230A.

HART COMMUNICATOR: The Model 375 HART communicator allows the user to view measurement values as well as to program and configure the transmitter. The Model 375 attaches to any wiring terminal across the output loop. A minimum 250 Ω load must be between the power supply and transmitter. Order the Model 375 communicator from Emerson Process Management. Call (800) 999-9307.

ACCESSORIES

MODEL/PN	DESCRIPTION
515	DC loop power supply (see product data sheet 71-515)
230A	Alarm module (see product data sheet 71-230A)
23820-00	2-in. pipe mounting kit
9240048-00	Stainless steel tag, specify marking
23554-00	Gland fittings PG 13.5, 5 per package

SECTION 2.0 INSTALLATION

- 2.1 Unpacking and Inspection**
- 2.2 Pre-Installation Set Up**
- 2.3 Installation**

2.1 UNPACKING AND INSPECTION

Inspect the shipping container. If it is damaged, contact the shipper immediately for instructions. Save the box. If there is no apparent damage, remove the transmitter. Be sure all items shown on the packing list are present. If items are missing, immediately notify Rosemount Analytical.

Save the shipping container and packaging. They can be reused if it is later necessary to return the transmitter to the factory.

2.2 PRE-INSTALLATION SETUP

2.2.1 Temperature Element

The Model XMT-P pH/ORP transmitter is compatible with sensors having Pt 100 and Pt 1000. Sensors from other manufacturers may have a Pt 1000 RTD. For Rosemount Analytical sensors, the type of temperature element in the sensor is printed on the tag attached to the sensor cable. For the majority of sensors manufactured by Rosemount Analytical, the RTD IN lead is red and the RTD RTN lead is white. The Model 328A sensor has no RTD. The Model 320HP system has a readily identifiable separate temperature element. Resistance at room temperature for common RTDs is given in the table.

If the resistance is...	the temperature element is a
about 110 ohms	Pt 100 RTD
about 1100 ohms	Pt 1000 RTD

2.2.2 Reference Electrode Impedance

The standard silver-silver chloride reference electrode used in most industrial and laboratory pH electrodes is low impedance. EVERY pH and ORP sensor manufactured by Rosemount Analytical has a low impedance reference. Certain specialized applications require a high impedance reference electrode. The transmitter must be re-programmed to recognize the high impedance reference.

2.2.3 Preamplifier Location

pH sensors produce a high impedance voltage signal that must be preamplified before use. The signal can be preamplified before it reaches the transmitter or it can be preamplified in the transmitter. To work properly, the transmitter must know where preamplification occurs. Although ORP sensors produce a low impedance signal, the voltage from an ORP sensor is amplified the same way as a pH signal.

If the sensor is wired to the transmitter through a junction box, the preamplifier is ALWAYS in either the junction box or the sensor. Junction boxes can be attached to the sensor or installed some distance away. If the junction box is not attached to the sensor, it is called a remote junction box. In most junction boxes used with the Model XMT-P pH/ORP, a flat, black plastic box attached to the same circuit board as the terminal strips houses the preamplifier. The preamplifier housing in the 381+ sensor is crescent shaped.

If the sensor is wired directly to the transmitter, the preamplifier can be in the sensor or in the transmitter. If the sensor cable has a GREEN wire, the preamplifier is in the sensor. If there is no green wire, the sensor cable will contain a coaxial cable. A coaxial cable is an insulated wire surrounded by a braided metal shield. Depending on the sensor model, the coaxial cable terminates in either a BNC connector or in a separate ORANGE wire and CLEAR shield.

2.3 INSTALLATION

1. Although the transmitter is suitable for outdoor use, do not install it in direct sunlight or in areas of extreme temperatures.
2. Install the transmitter in an area where vibrations and electromagnetic and radio frequency interference are minimized or absent.
3. Keep the transmitter and sensor wiring at least one foot from high voltage conductors. Be sure there is easy access to the transmitter.
4. The transmitter is suitable for panel (Figure 2-3), pipe (Figure 2-4), or surface (Figure 2-5) mounting.
5. The transmitter case has two 1/2-inch (PG13.5) conduit openings and either three or four 1/2-inch knockouts. The panel mount Xmt-P-HT has four knockouts. The pipe/surface mount transmitter has three knockouts*. One conduit opening is for the power/output cable; the other opening is for the sensor cable.

Figure 1 shows how to remove a knockout. The knockout grooves are on the outside of the case. Place the screwdriver blade on the inside of the case and align it approximately along the groove. Rap the screwdriver sharply with a hammer until the groove cracks. Move the screwdriver to an uncracked portion of the groove and continue the process until the knockout falls out. Use a small knife to remove the flash from the inside of the hole.

6. Use weathertight cable glands to keep moisture out to the transmitter. If conduit is used, plug and seal the connections at the transmitter housing to prevent moisture from getting inside the instrument.
7. To reduce the likelihood of stress on wiring connections, do not remove the hinged front panel (-11 models) from the base during wiring installation. Allow sufficient wire leads to avoid stress on conductors.

**NEMA plug may be supplied instead of knockout for pipe/surface version.*

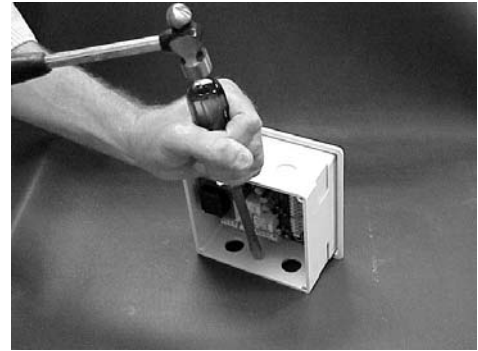

FIGURE 2-1. Removing the Knockouts

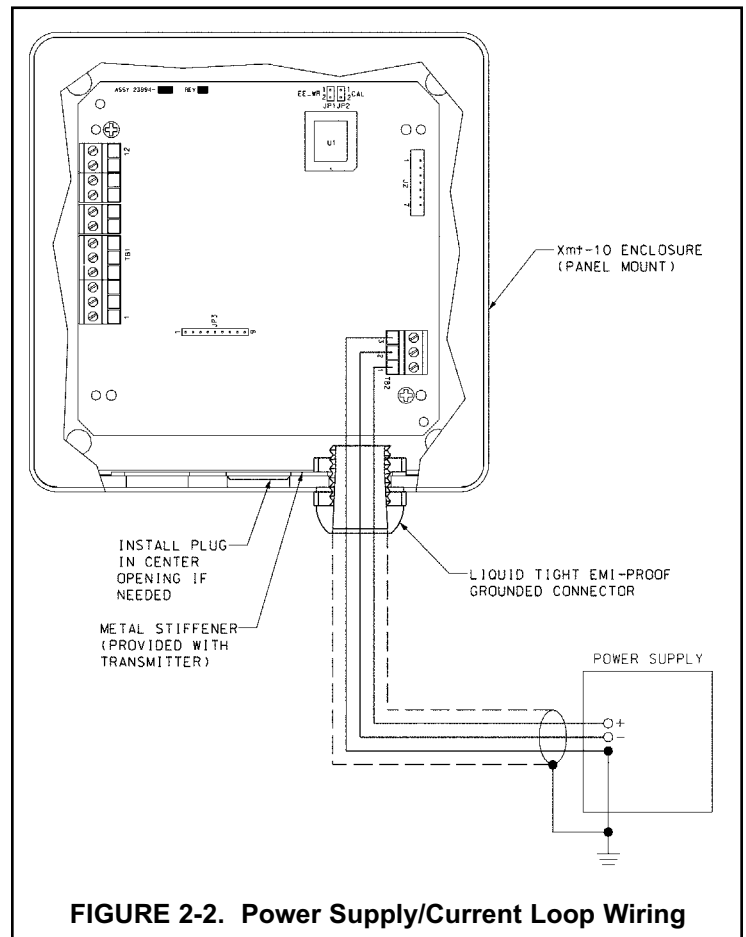
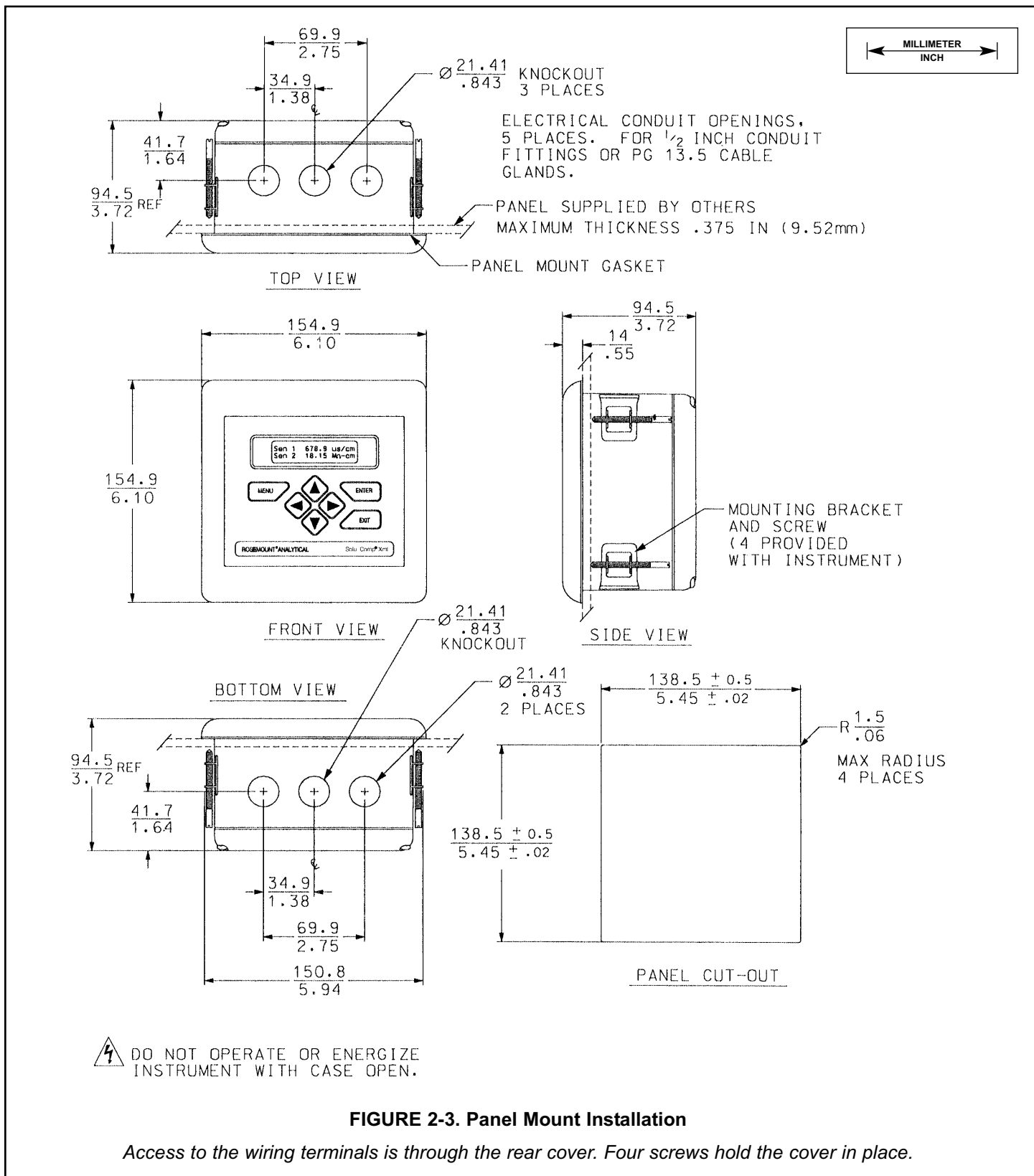
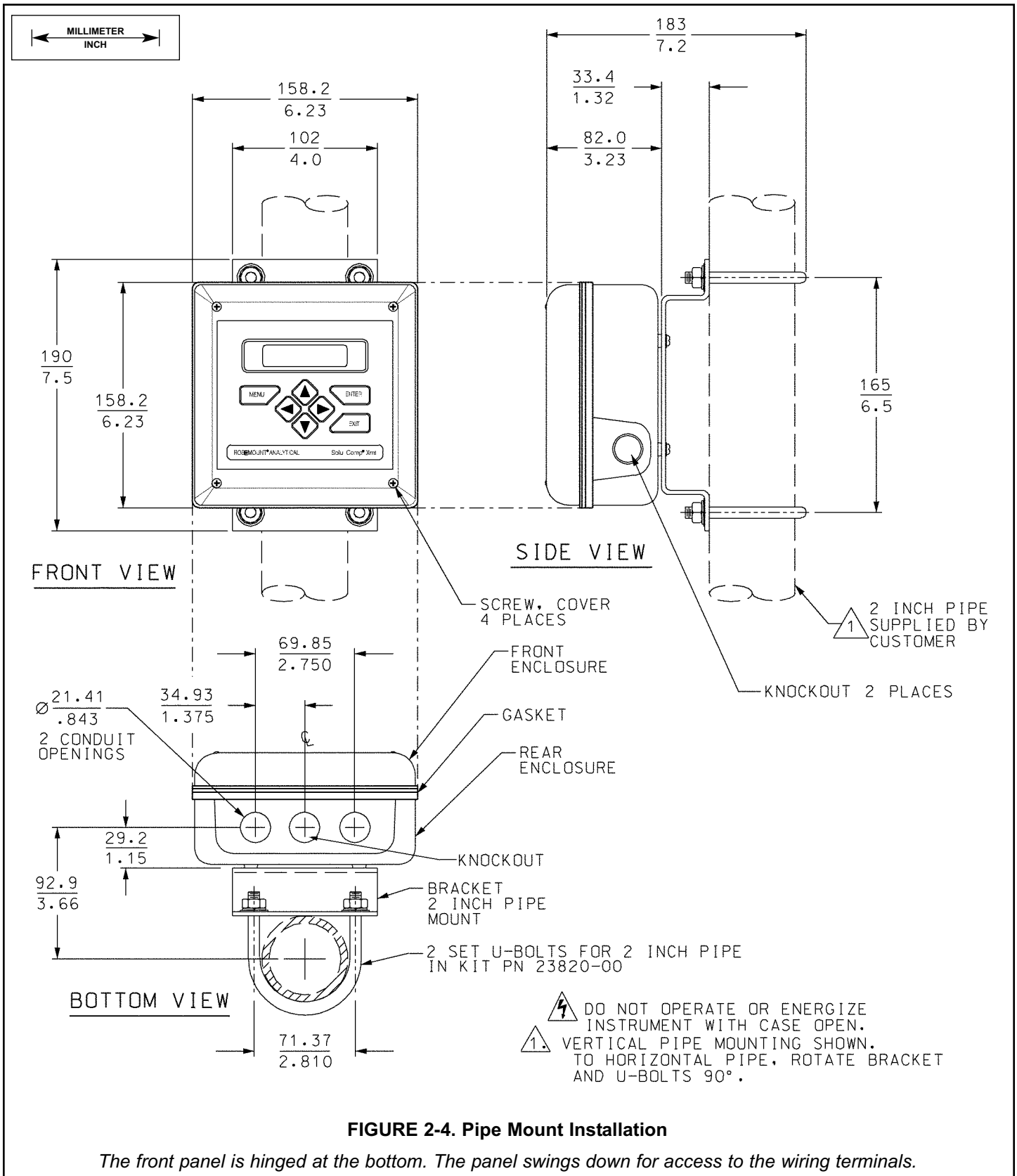

FIGURE 2-2. Power Supply/Current Loop Wiring

Panel Mounting.



Pipe Mounting.



Surface Mounting.

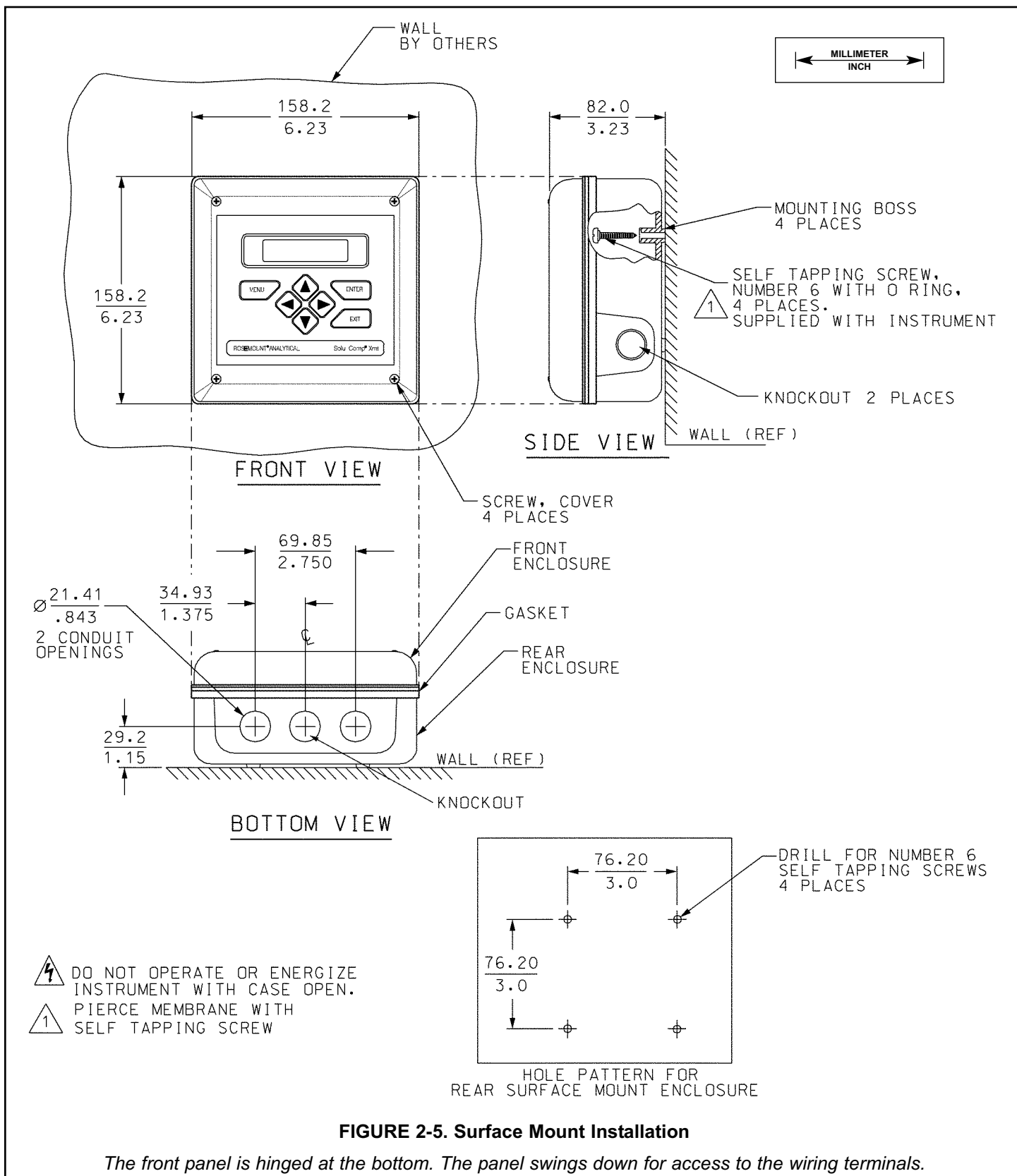

FIGURE 2-5. Surface Mount Installation

The front panel is hinged at the bottom. The panel swings down for access to the wiring terminals.

SECTION 3.0 WIRING

3.1 POWER SUPPLY/CURRENT LOOP — MODEL XMT-P-HT

3.1.1 Power Supply and Load Requirements.

Refer to Figure 3-1.

The supply voltage must be at least 12.0 Vdc at the transmitter terminals. The power supply must be able to cover the voltage drop on the cable as well as the load resistor (250 Ω minimum) required for HART communications. The maximum power supply voltage is 42.0 Vdc. For intrinsically safe installations, the maximum power supply voltage is 30.0 Vdc. The graph shows load and power supply requirements. The upper line is the power supply voltage needed to provide 12 Vdc at the transmitter terminals for a 22 mA current. The lower line is the power supply voltage needed to provide 30 Vdc for a 22 mA current.

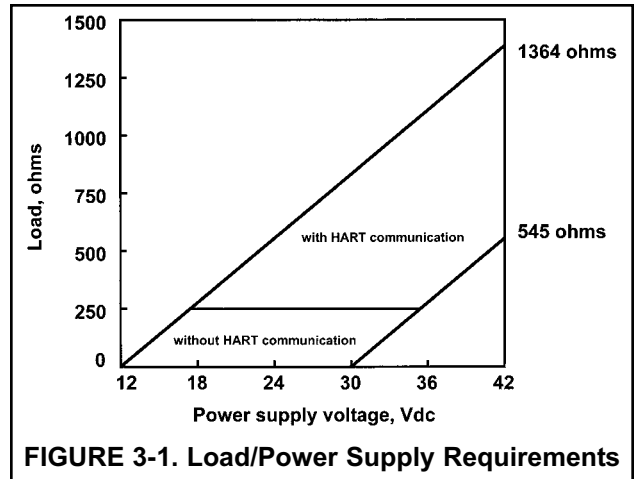

FIGURE 3-1. Load/Power Supply Requirements

The power supply must provide a surge current during the first 80 milliseconds of startup. The maximum current is about 24 mA.

For digital communications, the load must be at least 250 ohms. To supply the 12.0 Vdc lift off voltage at the transmitter, the power supply voltage must be at least 17.5 Vdc.

3.1.2 Power Supply-Current Loop Wiring.

Refer to Figure 3-2.

Run the power/signal wiring through the opening nearest TB-2.

For optimum EMI/RFI protection . . .

1. Use shielded power/signal cable and ground the shield at the power supply.
2. Use a metal cable gland and be sure the shield makes good electrical contact with the gland.
3. Use the metal backing plate (see Figure 2-6) when attaching the gland to transmitter enclosure.

The power/signal cable can also be enclosed in an earth-grounded metal conduit.

Do not run power supply/signal wiring in the same conduit or cable tray with AC power lines or with relay actuated signal cables. Keep power supply/signal wiring at least 6 ft (2 m) away from heavy electrical equipment.

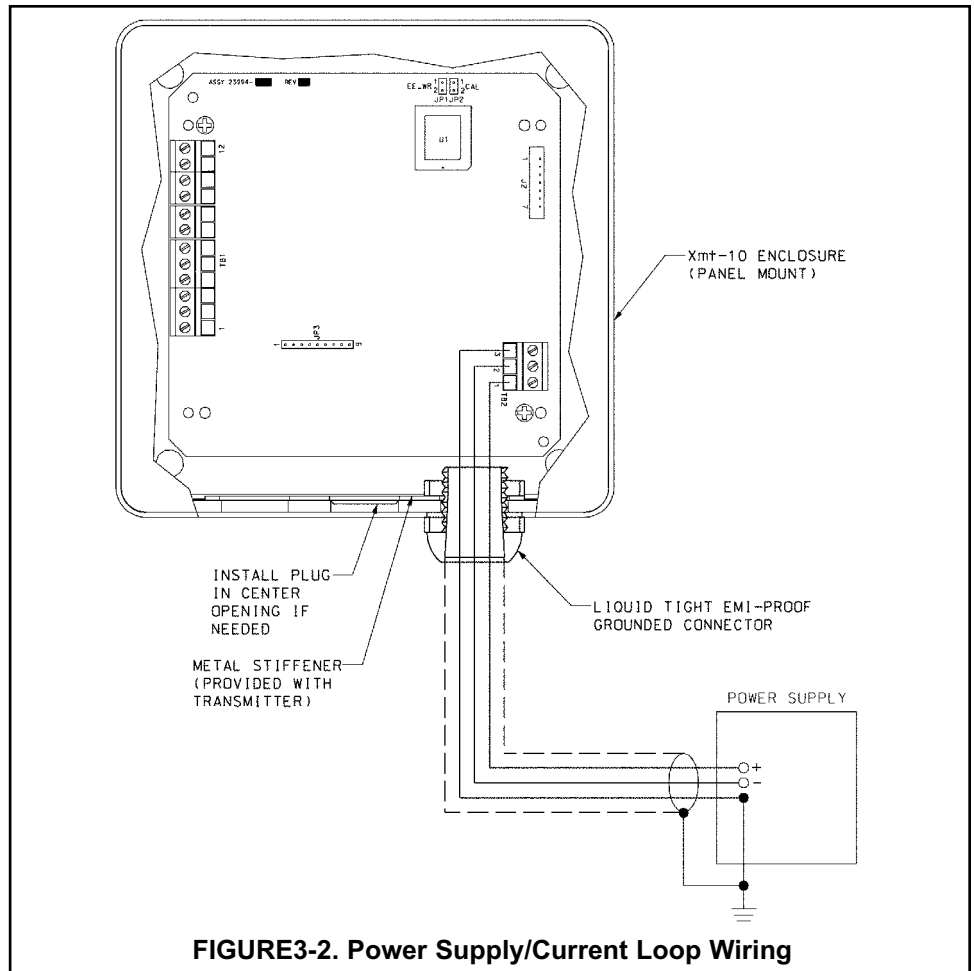

FIGURE 3-2. Power Supply/Current Loop Wiring

3.2 POWER SUPPLY WIRING FOR MODEL XMT-P-FF

3.2.1 Power Supply Wiring. Refer to Figure 3-3 and Figure 3-4.

Run the power/signal wiring through the opening nearest TB2. Use shielded cable and ground the shield at the power supply. To ground the transmitter, attach the shield to TB2-3.

NOTE

For optimum EMI/RFI immunity, the power supply/output cable should be shielded and enclosed in an earth-grounded metal conduit.

Do not run power supply/signal wiring in the same conduit or cable tray with AC power lines or with relay actuated signal cables. Keep power supply/signal wiring at least 6 ft (2 m) away from heavy electrical equipment.

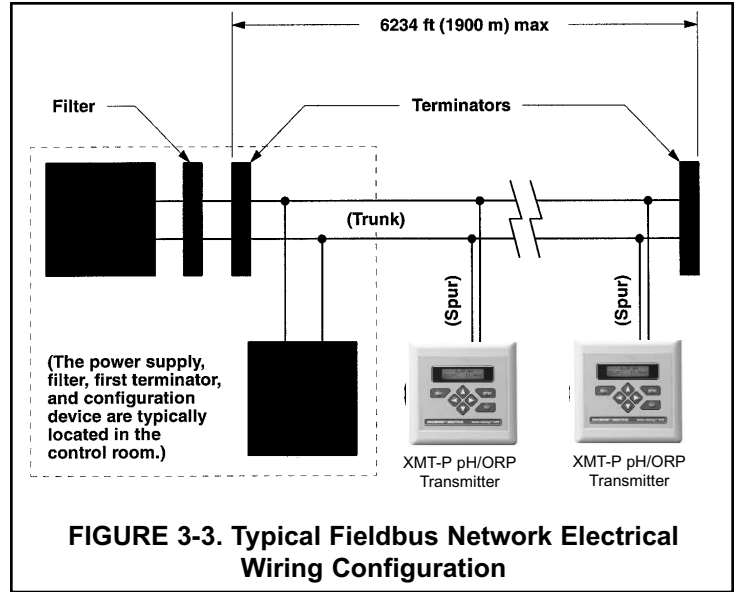

FIGURE 3-3. Typical Fieldbus Network Electrical Wiring Configuration

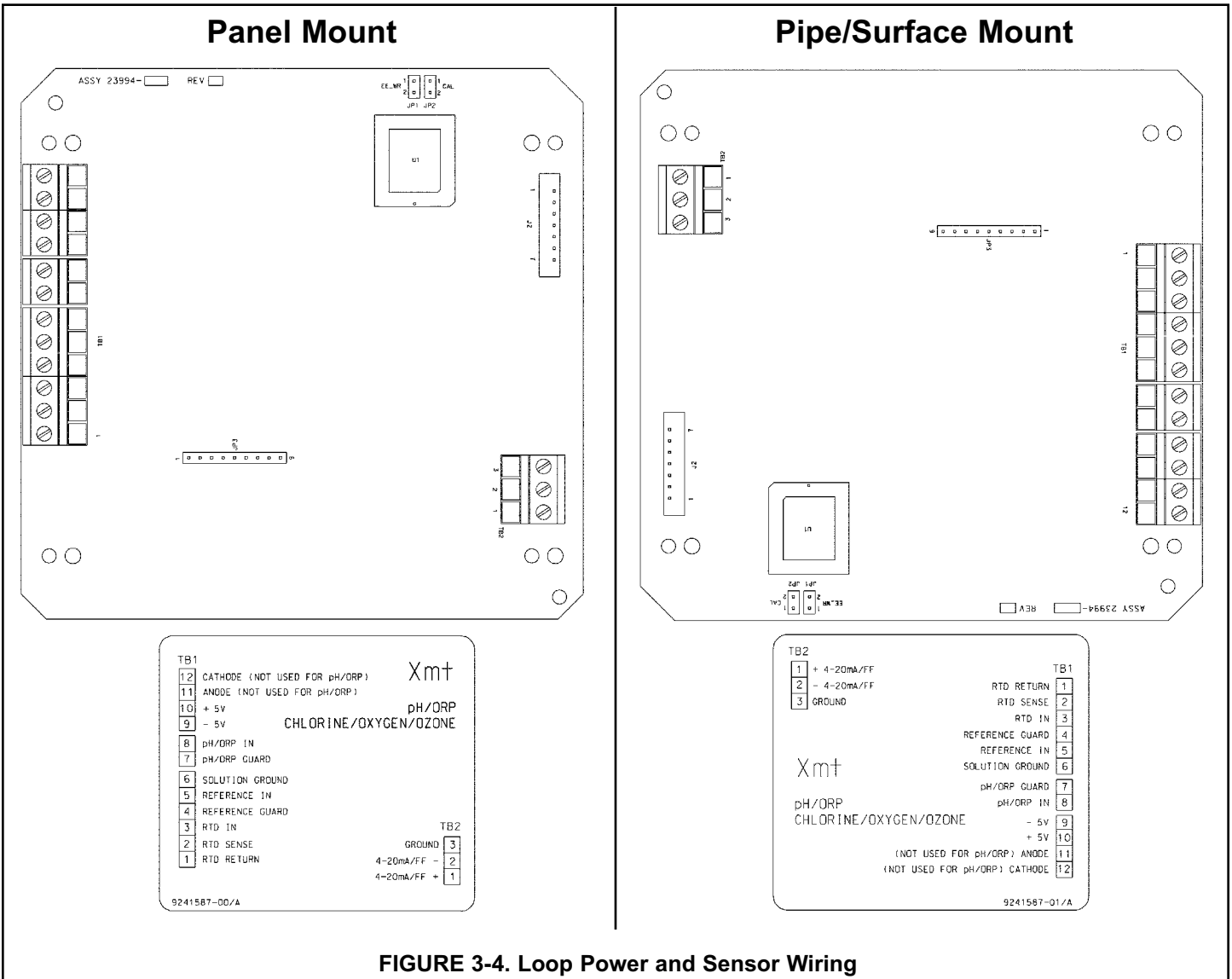

FIGURE 3-4. Loop Power and Sensor Wiring

3.3 SENSOR WIRING

3.3.1 Sensor Wiring Information

pH and ORP sensors manufactured by Rosemount Analytical can be wired to the Model XMT-P transmitter in three ways:

1. directly to the transmitter,
2. to a sensor-mounted junction box and then to the transmitter,
3. to a remote junction box and then from the remote junction box to the transmitter.

The pH (or ORP) signal can also be preamplified in one of four places. See Section 7.4.3 for set-up. The transmitter is factory configured with a preamplifier.

1. in the sensor (a, d),
2. in a junction box mounted on the sensor (c),
3. in a remote junction box (e).
4. at the transmitter (b).

NOTE: For 22K NTC RTDs, wire leads to TB1-1 and TB1-3.

3.3.2 General Wiring Configurations

Figure 3-5 illustrates the various wiring arrangements for Xmt-P.

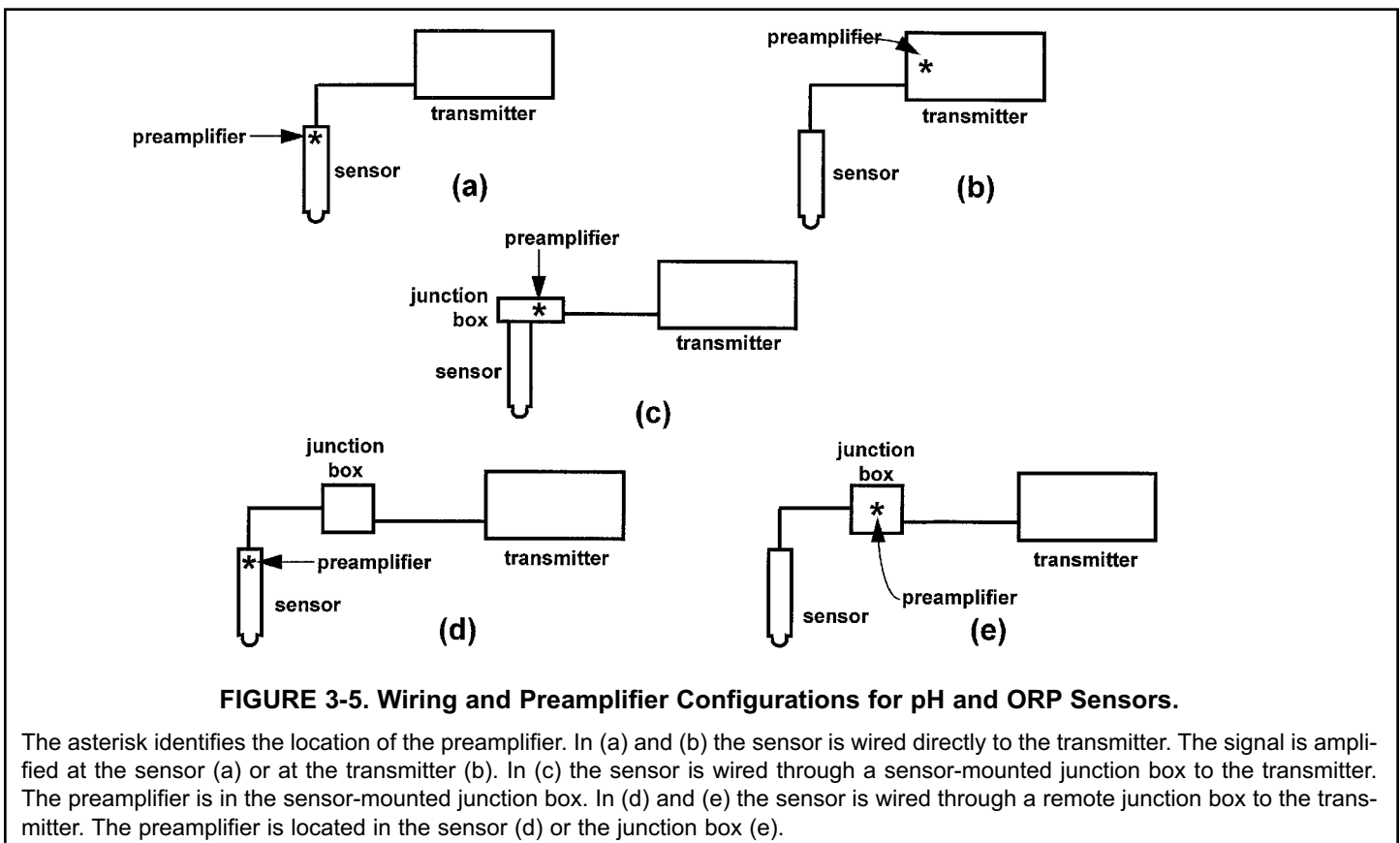

Refer to the Instruction Sheet provided with each sensor for specific wiring instructions.

SECTION 4.0 INTRINSICALLY SAFE INSTALLATION

INTRINSICALLY SAFE INSTALLATIONS FOR MODEL XMT-P-HT

For FM Intrinsically Safe Label, see Figure 4-1.
For FM Intrinsically Safe Installation, see Figure 4-2.
For CSA Intrinsically Safe Label, see Figure 4-3.

For CSA Intrinsically Safe Installation, see Figure 4-4.
For ATEX Intrinsically Safe Label, see Figure 4-5.
For ATEX Intrinsically Safe Installation, see Figure 4-6.

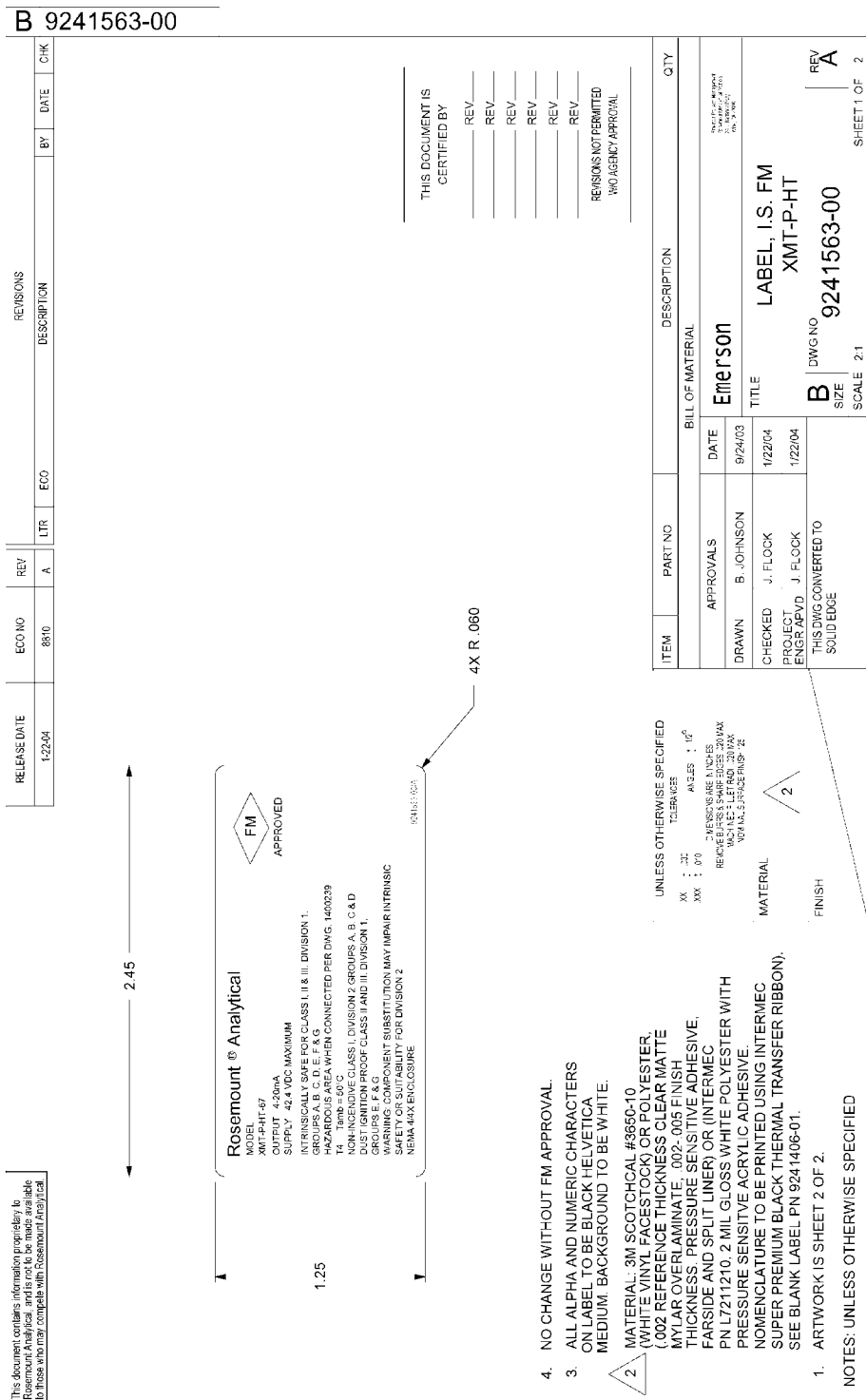

FIGURE 4-1. FM Intrinsically Safe Label for Model Xmt-P-HT

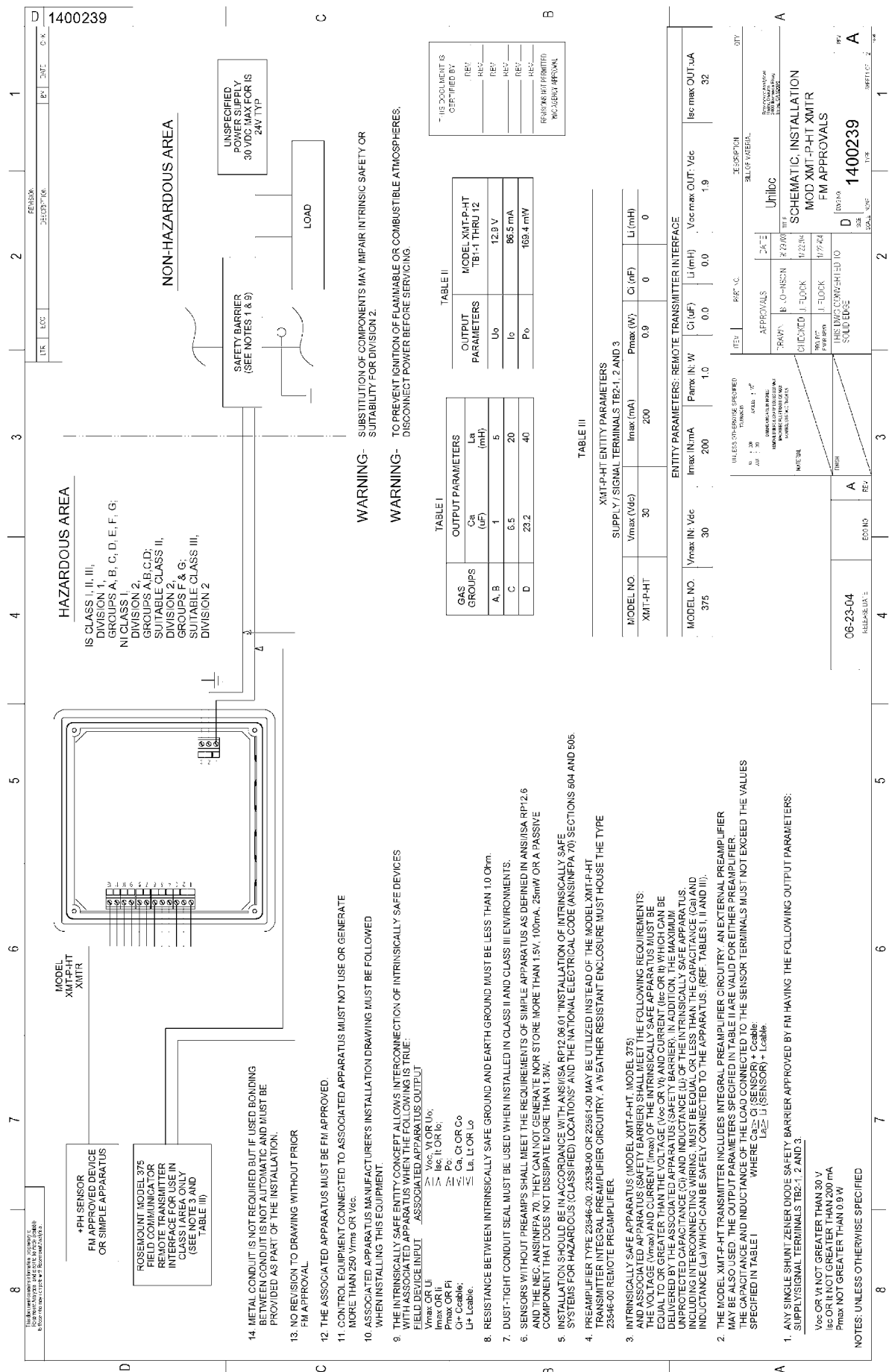

FIGURE 4-2. FM Intrinsically Safe Installation (1 of 2) for Model Xmt-P-HT

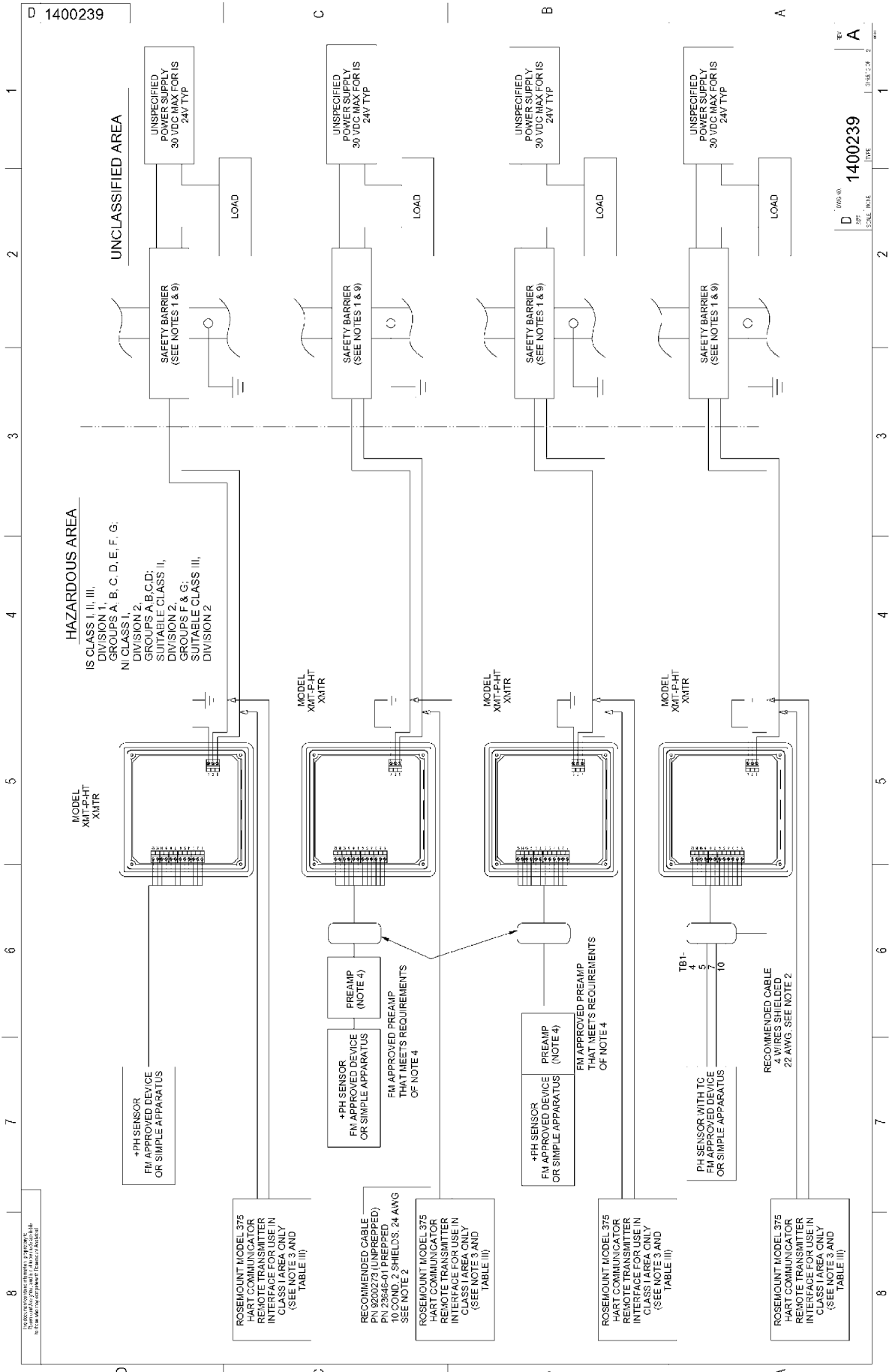
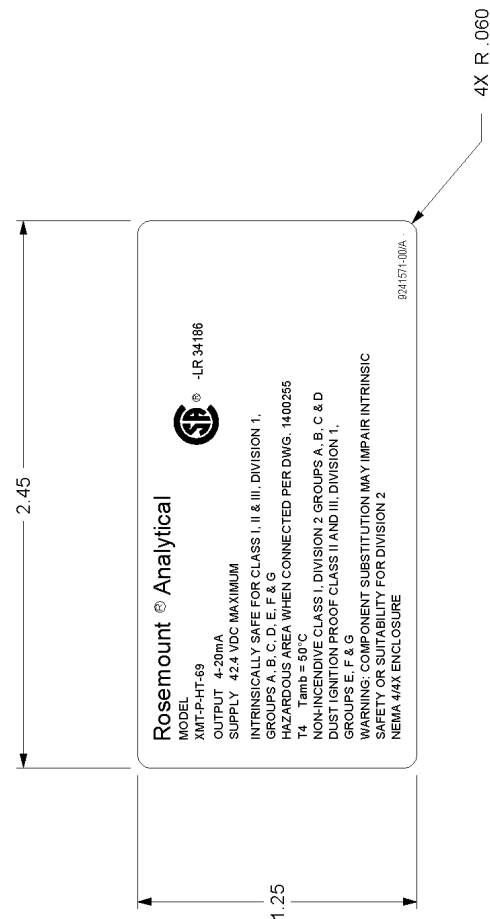

FIGURE 4-3. FM Intrinsically Safe Installation (2 of 2) for Model Xmt-P-HT

B 9241571-00

REVISIONS	BY	DATE	CHK
DESCRIPTION			
ECO NO	REV	LTR	ECO
8810	A		
RELEASE DATE			
6-23-04			

This document contains information proprietary to Rosemount Analytical, and is not to be made available to those who may compete with Rosemount Analytical.



THIS DOCUMENT IS CERTIFIED BY

____ REV _____

____ REV _____

____ REV _____

____ REV _____

____ REV _____

____ REV _____

REVISIONS NOT PERMITTED
W/O AGENCY APPROVAL

- NO CHANGE WITHOUT CSA APPROVAL.
- ALL ALPHA AND NUMERIC CHARACTERS ON LABEL TO BE BLACK HELVETICA MEDIUM. BACKGROUND TO BE WHITE.
- MATERIAL: 3M SCOTCHCAL #3650-10 (WHITE VINYL FACESTOCK) OR POLYESTER, (.002 REFERENCE THICKNESS CLEAR MATTE MYLAR OVERLAMINATE .002-.005 FINISH THICKNESS. PRESSURE SENSITIVE ADHESIVE, FAR SIDE AND SPLIT LINER) OR (INTERMEC PN L7211210, 2 MIL GLOSS WHITE POLYESTER WITH PRESSURE SENSITIVE ACRYLIC ADHESIVE. NOMENCLATURE TO BE PRINTED USING INTERMEC SUPER PREMIUM BLACK THERMAL TRANSFER RIBBON). SEE BLANK LABEL PN 9241406-01.
- ARTWORK IS SHEET 2 OF 2.

NOTES: UNLESS OTHERWISE SPECIFIED

UNLESS OTHERWISE SPECIFIED		ITEM		PART NO		DESCRIPTION		QTY	
TOLERANCES		DRAWN		APPROVALS		DATE		BILL OF MATERIAL	
XX + .000		B. JOHNSON		Emerson		10/ /03		Emerson Process Management, Rosemount Analytical Division, 10000 Rosemount Drive, New Canaan, OH 44609	
XXX + .010		J. FLOCK		CHECKED		1/22/04		TITLE	
DIMENSIONS ARE IN INCHES		ENGR APVD		PROJECT		1/22/04		LABEL, I.S. CSA	
REMOVE BURRS & SHARP EDGES .020 MAX		THIS DWG CONVERTED TO SOLID EDGE		FINISH		SCALE		XMT-P-HT	
MACHINED FILLET RADI .020 MAX						2:1		REV	
NOMINAL SURFACE FINISH 125						DWG NO		A	
MATERIAL						9241571-00		SHEET 1 OF 2	
FINISH									

FIGURE 4-4. CSA Intrinsically Safe Label for Model Xmt-P-HT

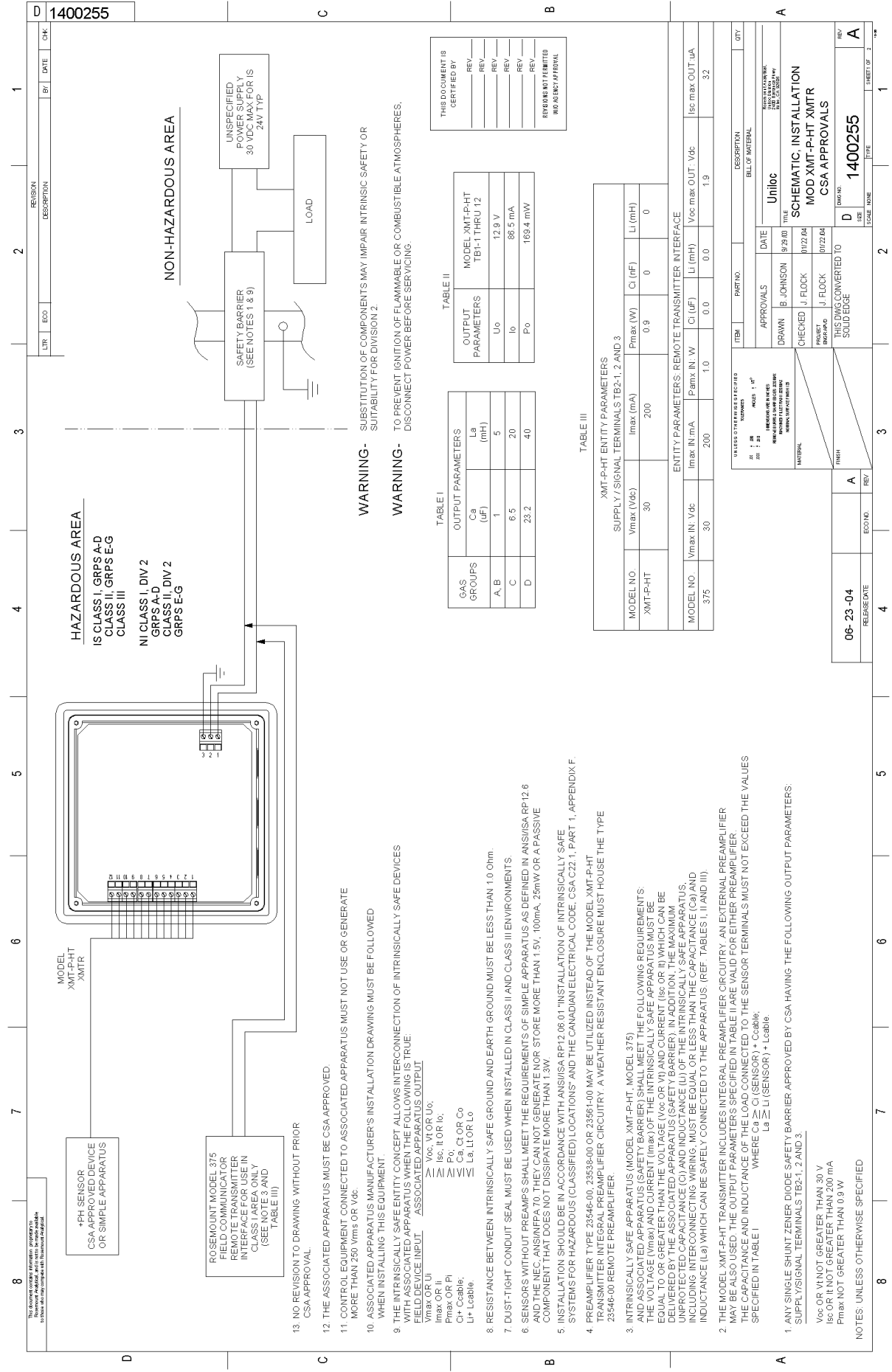

REV	DATE	CHK	DESCRIPTION
1400255			

THIS DOCUMENT IS CERTIFIED BY:

REV	
REV	
REV	
REV	
REV	
REV	
REV	
REV	

REVISED BY: FEBRUARY 2010
MID-LEVEL APPROVAL

TABLE II
OUTPUT PARAMETERS MODEL XMT-P-HT TB1-1 THRU 12

V _o	12.9 V
I _o	88.5 mA
P _o	169.4 mW

TABLE I
OUTPUT PARAMETERS

GAS GROUPS	C _a (uF)	L _a (mH)
A, B	1	5
C	6.5	20
D	23.2	40

TABLE III
XMT-P-HT ENTITY PARAMETERS

SUPPLY SIGNAL TERMINALS TB2-1, 2 AND 3

MODEL NO.	V _{max} (Vdc)	I _{max} (mA)	P _{max} (W)	C _i (nF)	L _i (mH)
XMT-P-HT	30	200	0.9	0	0

ENTITY PARAMETERS: REMOTE TRANSMITTER INTERFACE

MODEL NO.	V _{max} IN Vdc	I _{max} IN mA	P _{max} IN W	C _i (nF)	L _i (mH)	V _{oc} max OUT Vdc	I _{sc} max OUT uA
375	30	200	1.0	0.0	0.0	1.9	3.2

UNLESS OTHERWISE SPECIFIED

ITEM	PART NO.	DESCRIPTION	QUANTITY
APPROVALS			
DRAWN	B. JOHNSON	DATE	9/29/00
CHECKED	J. FLOCK	DATE	01/22/04
PRODUCT ENGINEER	J. FLOCK	DATE	01/22/04
MATERIAL			
THIS DWG CONVERTED TO SOLID EDGE			
REV	DATE	BY	DESCRIPTION
A			
D			

UNILIC
SCHEMATIC - INSTALLATION
MOD XMT-P-HT XMTIR
CSA APPROVALS

1400255

FIGURE 4-5. CSA Intrinsically Safe Installation (1 of 2) for Model Xmt-P-HT

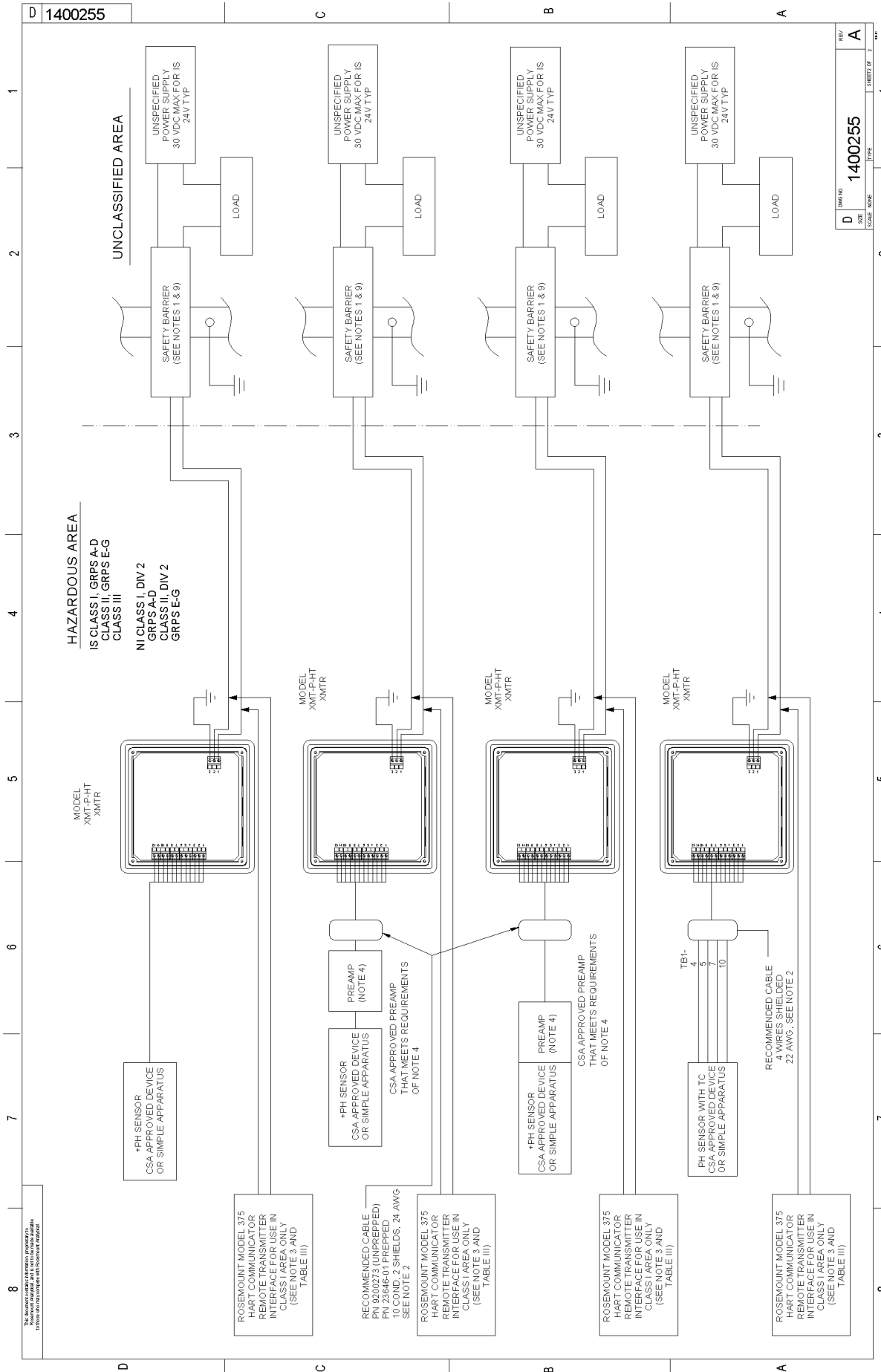
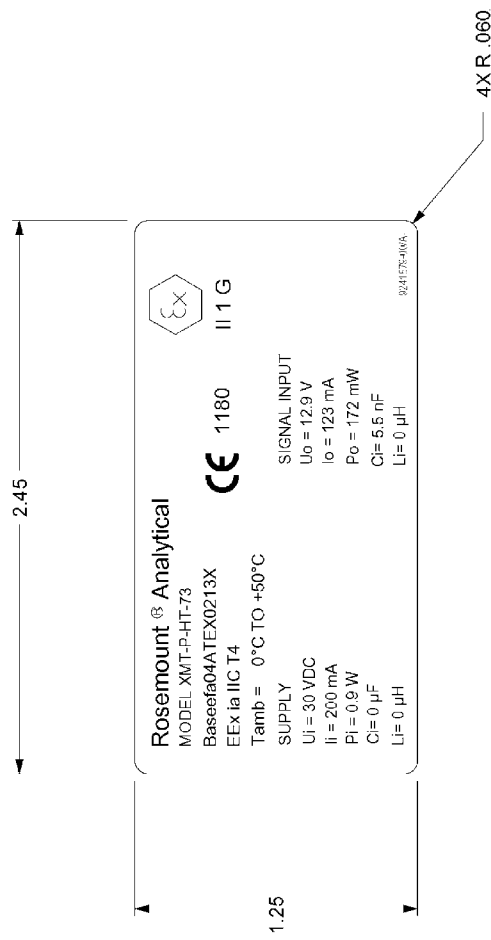

FIGURE 4-6. CSA Intrinsically Safe Installation (2 of 2) for Model Xmt-P-HT

This document contains information proprietary to Rosemount Analytical, and is not to be made available to those who may compete with Rosemount Analytical.

RELEASE DATE	ECO NO	REV	LTR	ECO	DESCRIPTION	BY	DATE	CHK
6-23-04	8810	A						

B 9241579-00



THIS DOCUMENT IS CERTIFIED BY
 BAS REV. A
 _____ REV. _____
 _____ REV. _____
 _____ REV. _____
 _____ REV. _____
 _____ REV. _____
 _____ REV. _____
 REVISIONS NOT PERMITTED
 W/O AGENCY APPROVAL

Baseefa Certified Product
 No modifications permitted
 without the approval of
 the Authorized Person
 Related Drawing

- NO CHANGE WITHOUT Baseefa APPROVAL.
- ALL ALPHA AND NUMERIC CHARACTERS ON LABEL TO BE BLACK HELVETICA MEDIUM. BACKGROUND TO BE WHITE.
- MATERIAL: 3M SCOTCHCAL #3650-10 (WHITE VINYL FACESTOCK) OR POLYESTER, MYLAR OVERLAMINATE, .002-.005 FINISH THICKNESS. PRESSURE SENSITIVE ADHESIVE, FARSIDE AND SPLIT LINER) OR (INTERMEC PN L7211210, 2 MIL GLOSS WHITE POLYESTER WITH PRESSURE SENSITIVE ACRYLIC ADHESIVE. NOMENCLATURE TO BE PRINTED USING INTERMEC SUPER PREMIUM BLACK THERMAL TRANSFER RIBBON). SEE BLANK LABEL PN 9241406-01.

1. ARTWORK IS SHEET 2 OF 2.

NOTES: UNLESS OTHERWISE SPECIFIED

ITEM	PART NO	DESCRIPTION	QTY
UNLESS OTHERWISE SPECIFIED			
TOLERANCES XX ± .03 ANGLES ± 1/2° XXX ± .00 DIMENSIONS ARE IN INCHES REMOVE BURRS & SHARP EDGES .000 MAX MACH NED FILET RADII .200 MAX NOMINAL SURFACE FINISH - 25			
MATERIAL			
FINISH			
APPROVALS		DATE	
DRAWN	B. JOHNSON	10/1/03	
CHECKED	J. FLOCK	01/22/04	
PROJECT ENGR	J. FLOCK	01/22/04	
THIS DWG. CONVERTED TO SOLIDEDGE			
BILL OF MATERIAL		Emerson	
TITLE		LABEL, I.S. Baseefa XMT-P-HT	
DWG NO	B	REV	A
SIZE	9241579-00		
SCALE	2:1		SHEET 1 OF 2

FIGURE 4-7. ATEX Intrinsically Safe Label for Model Xmt-P-HT

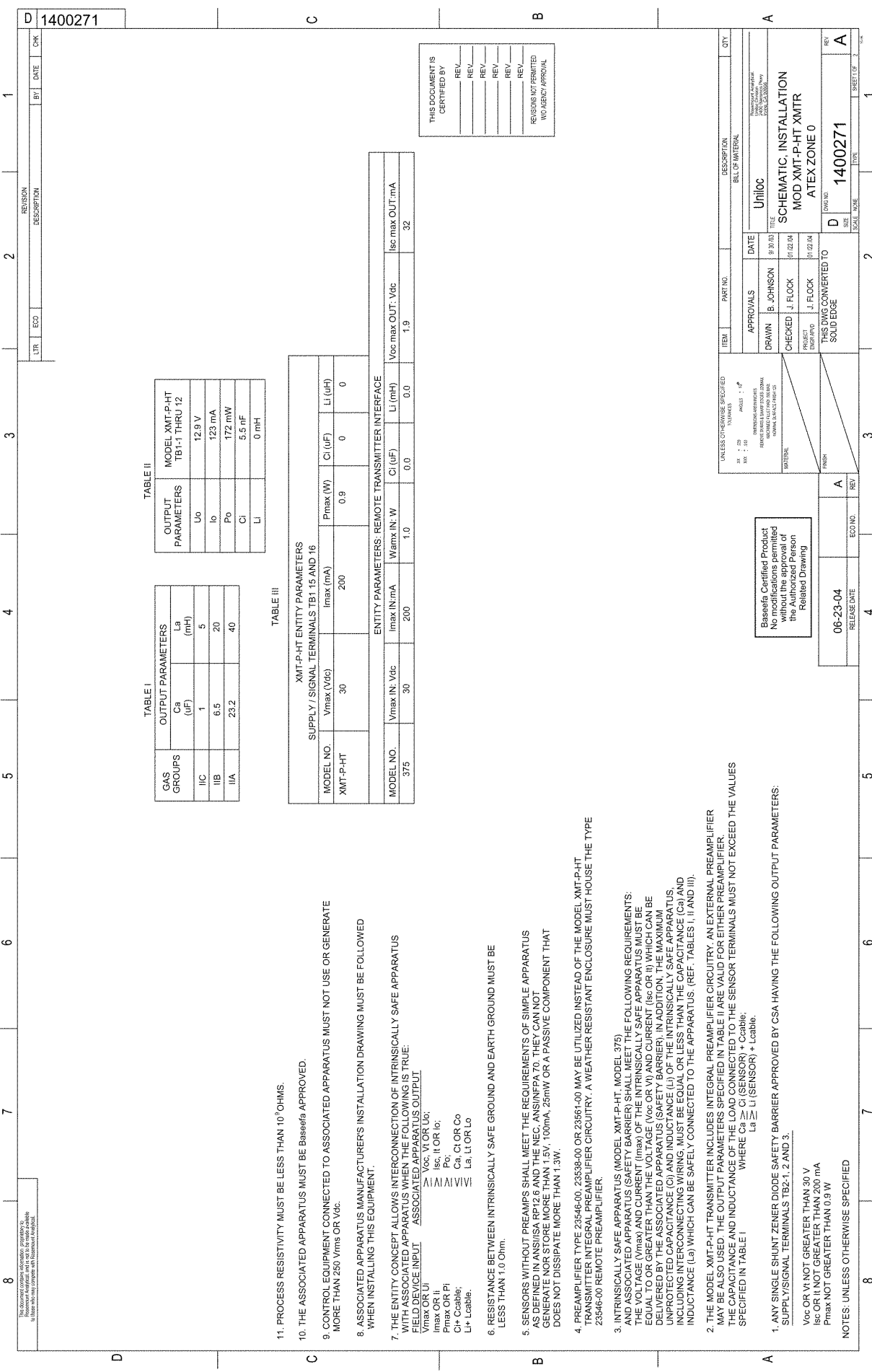

FIGURE 4-8. ATEX Intrinsically Safe Installation (1 of 2) for Model Xmt-P-HT

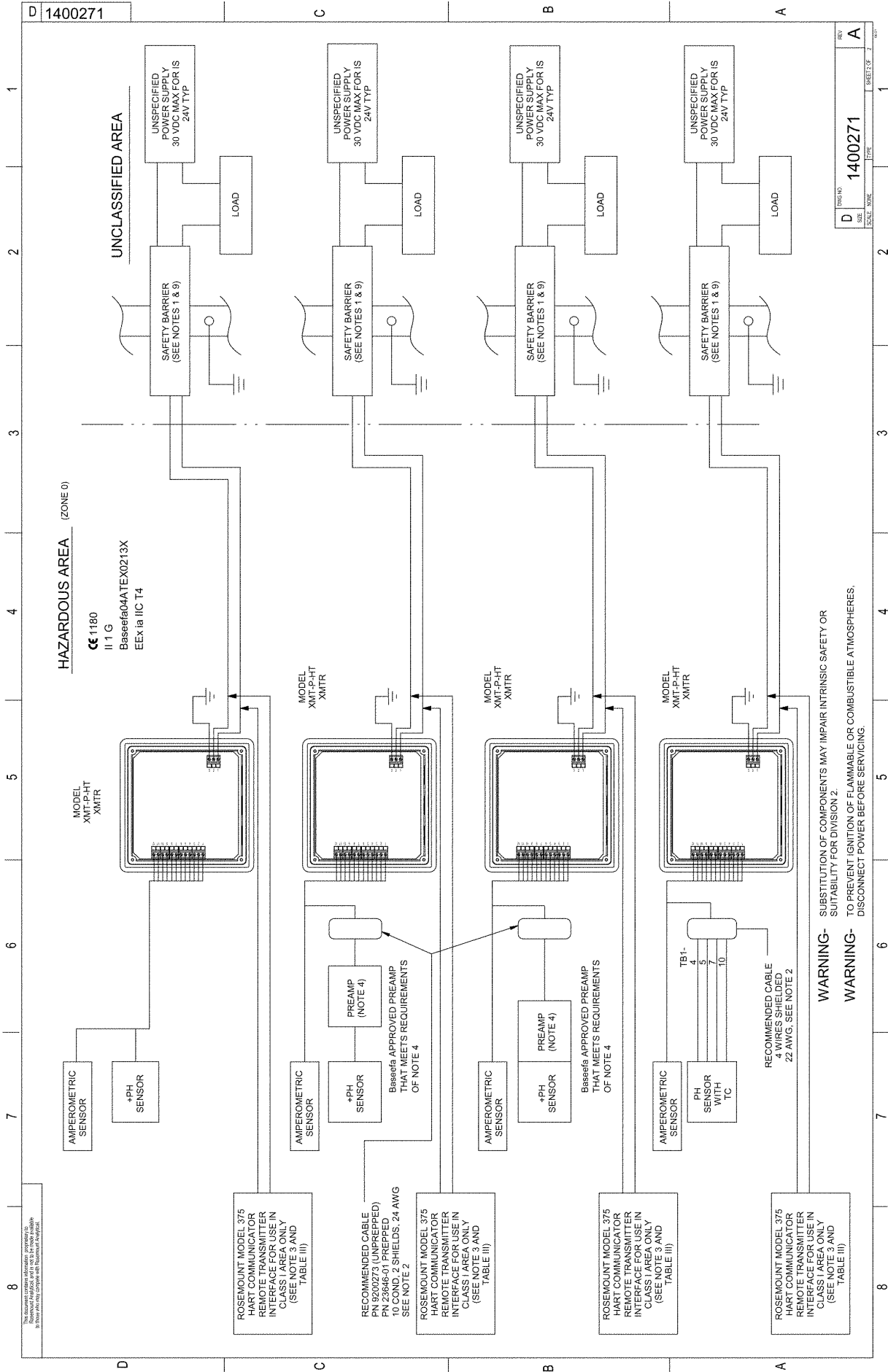
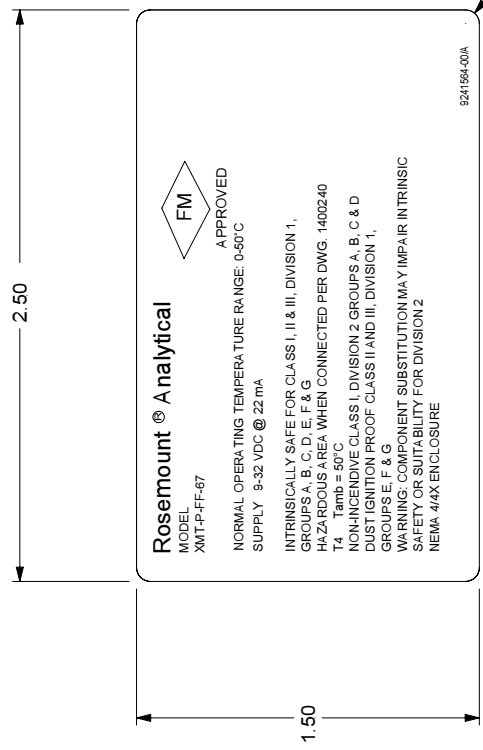

FIGURE 4-9. ATEX Intrinsically Safe Installation (2 of 2) for Model Xmt-P-HT

REV	A
DATE	
SCALE	
DESCRIPTION	1400271
TITLE	
SHEET NO.	2
TOTAL SHEETS	2

REVISIONS	DESCRIPTION	BY	DATE	CHK
ECO NO	REV	LTR	ECO	
9042	A			
RELEASE DATE				
10-6-04				

This document contains information proprietary to Rosemount Analytical and is not to be made available to those who may compete with Rosemount Analytical.



THIS DOCUMENT IS CERTIFIED BY	REV
FM	A
_____	REV
_____	REV
_____	REV
_____	REV
_____	REV
_____	REV
REVISIONS NOT PERMITTED W/O AGENCY APPROVAL	

ITEM	PART NO	DESCRIPTION	QTY
BILL OF MATERIAL			
APPROVALS		Emerson	
DRAWN	B. JOHNSON	TITLE	
CHECKED	J. FLOCK	LABEL, I.S. FM	
PROJECT ENGR	J. FLOCK	XMT-P-FF	
THIS DWG CONVERTED TO SOLID EDGE		DWG NO	
		B 9241564-00	REV A
		SCALE 2:1	SHEET 1 OF 2

UNLESS OTHERWISE SPECIFIED
TOLERANCES
XX + .030 ANGLES ± 1/2°
XXX ± .010 DIMENSIONS ARE IN INCHES
REMOVE BURRS & SHARP EDGES .020 MAX
MACHINED FILLET RADIUS .020 MAX
NOMINAL SURFACE FINISH 125

MATERIAL

FINISH

2

4. NO CHANGE WITHOUT FM APPROVAL.

3. ALL ALPHA AND NUMERIC CHARACTERS ON LABEL TO BE BLACK HELVETICA MEDIUM. BACKGROUND TO BE WHITE.

2 MATERIAL: 3M SCOTCHCAL #3650-10 (WHITE VINYL FACESTOCK) OR POLYESTER, (.002 REFERENCE THICKNESS CLEAR MATTE MYLAR OVERLAMINATE, .002-.005 FINISH THICKNESS, PRESSURE SENSITIVE ADHESIVE, FAR SIDE AND SPLIT LINER) OR (INTERMEC PN L7211210, 2 MIL GLOSS WHITE POLYESTER WITH PRESSURE SENSITIVE ACRYLIC ADHESIVE. NOMENCLATURE TO BE PRINTED USING INTERMEC SUPER PREMIUM BLACK THERMAL TRANSFER RIBBON) SEE BLANK LABEL PN 9241406-01.

1. ARTWORK IS SHEET 2 OF 2.

NOTES: UNLESS OTHERWISE SPECIFIED

FIGURE 4-10. FM Intrinsically Safe Label for Model Xmt-P-FF

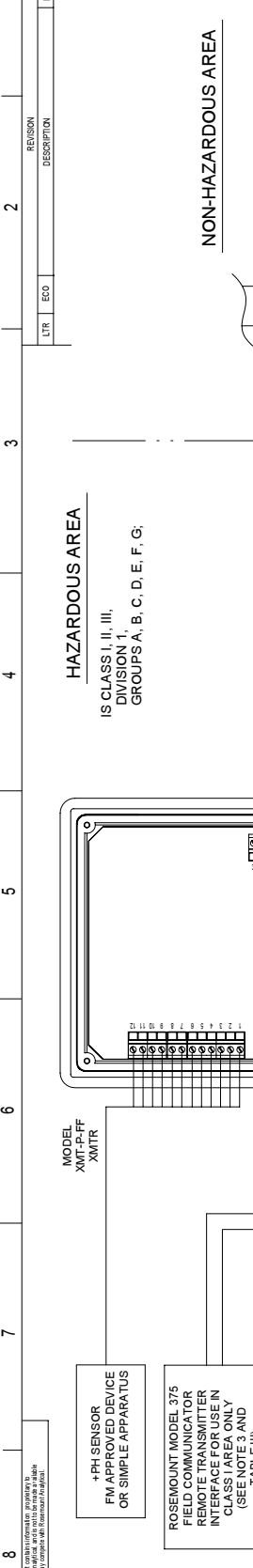

HAZARDOUS AREA
IS CLASS I, II, III,
DIVISION 1,
GROUPS A, B, C, D, E, F, G;

NON-HAZARDOUS AREA

TABLE I
OUTPUT PARAMETERS

GAS GROUPS	C _a (μF)	L _a (mH)
A, B	0.9645	0.974
C	5.99	2.974
D	21.69	7.97

TABLE II
OUTPUT PARAMETERS

MODEL XMT-P-FF	MODEL XMT-P-FF TB1-1 THRU 12
U _o	13.03V
I _o	157.17mA
P _o	511.59mW

TABLE III
XMT-P-FF ENTITY PARAMETERS

SUPPLY / SIGNAL TERMINALS TB2-1, 2 AND 3

MODEL NO.	V _{max} (Vdc)	I _{max} (mA)	P _{max} (W)	C _i (nF)	L _i (mH)
XMT-P-FF	30	300	1.3	0.4	0

ENTITY PARAMETERS - REMOTE TRANSMITTER INTERFACE

MODEL NO.	V _{max} IN: Vdc	I _{max} IN: mA	P _{max} IN: W	C _i (μF)	L _i (mH)	Voc max OUT: Vdc	Isc max OUT: I _a
375	30	200	1.0	0.0	0.0	1.9	32

UNLESS OTHERWISE SPECIFIED:
XX: ±20%
XXX: ±10%
XXX: ±5%
XXXXXXXX: TOLERANCES PER MIL-STD-203E (RESISTORS) AND PER MIL-STD-203A (CAPACITORS)

FINISH: UNLESS OTHERWISE SPECIFIED, ALL METAL SURFACES SHALL BE STAINLESS STEEL TYPE 316L, 1.4571. ALL OTHER METAL SURFACES SHALL BE ALUMINUM TYPE 6061-T6.

APPROVALS: DRAWN BY: B. JOHNSON, DATE: 08/04, CHECKED BY: J. FLOCK, DATE: 10/04, DESIGNED BY: J. FLOCK, DATE: 10/04, THIS Dwg. CONVERTED TO SOLID EDGE. Dwg. NO. 1400240, SCALE: NONE, SHEET OF 2

1. ANY SINGLE SHUNT ZENER DIODE SAFETY BARRIER APPROVED BY FM HAVING THE FOLLOWING OUTPUT PARAMETERS:
V_{oc} OR V_t NOT GREATER THAN 30 V
I_{sc} OR I_t NOT GREATER THAN 200 mA
P_{max} NOT GREATER THAN 0.9 W
NOTES: UNLESS OTHERWISE SPECIFIED

2. THE MODEL XMT-P-FF TRANSMITTER INCLUDES INTEGRAL PREAMPLIFIER CIRCUITRY. AN EXTERNAL PREAMPLIFIER MAY BE ALSO USED. THE OUTPUT PARAMETERS SPECIFIED IN TABLE II ARE VALID FOR EITHER PREAMPLIFIER. THE CAPACITANCE AND INDUCTANCE OF THE LOAD CONNECTED TO THE SENSOR TERMINALS MUST NOT EXCEED THE VALUES SPECIFIED IN TABLE I.
WHERE C_a ≥ C_i (SENSOR) + C_{able};
L_a ≥ L_i (SENSOR) + L_{able}.

3. INTRINSICALLY SAFE APPARATUS (MODEL XMT-P-FF, MODEL 375) AND ASSOCIATED APPARATUS (SAFETY BARRIER) SHALL MEET THE FOLLOWING REQUIREMENTS:
THE VOLTAGE (V_{max}) AND CURRENT (I_{max}) OF THE INTRINSICALLY SAFE APPARATUS MUST BE EQUAL TO OR GREATER THAN THE VOLTAGE (V_{oc} OR V_t) AND CURRENT (I_{sc} OR I_t) WHICH CAN BE DELIVERED BY THE ASSOCIATED APPARATUS (SAFETY BARRIER). IN ADDITION, THE MAXIMUM UNPROTECTED CAPACITANCE (C_i) AND INDUCTANCE (L_i) OF THE INTRINSICALLY SAFE APPARATUS, INCLUDING INTERCONNECTING WIRING, MUST BE EQUAL OR LESS THAN THE CAPACITANCE (C_a) AND INDUCTANCE (L_a) WHICH CAN BE SAFELY CONNECTED TO THE APPARATUS. (REF. TABLES I, II AND III).

4. PREAMPLIFIER TYPE 23546-00, 23538-00 OR 23581-00 MAY BE UTILIZED INSTEAD OF THE MODEL XMT-P-FF TRANSMITTER INTEGRAL PREAMPLIFIER CIRCUITRY. A WEATHER RESISTANT ENCLOSURE MUST HOUSE THE TYPE 23546-00 REMOTE PREAMPLIFIER.

5. INSTALLATION SHOULD BE IN ACCORDANCE WITH ANSI/ISA RP12.06-01 "INSTALLATION OF INTRINSICALLY SAFE SYSTEMS FOR HAZARDOUS (CLASSIFIED) LOCATIONS" AND THE NATIONAL ELECTRICAL CODE (ANSI/NFPA 70) SECTIONS 504 AND 505.

6. SENSORS WITHOUT PREAMPS SHALL MEET THE REQUIREMENTS OF SIMPLE APPARATUS AS DEFINED IN ANSI/ISA RP12.6 AND THE NEC, ANSI/NFPA 70. THEY CAN NOT GENERATE NOR STORE MORE THAN 1.5V, 100mA, 25mW OR A PASSIVE COMPONENT THAT DOES NOT DISSIPATE MORE THAN 1.3W.

7. RESISTANCE BETWEEN INTRINSICALLY SAFE GROUND AND EARTH GROUND MUST BE LESS THAN 1.0 Ohm.
DUST-TIGHT CONDUIT SEAL MUST BE USED WHEN INSTALLED IN CLASS II AND CLASS III ENVIRONMENTS.
AND THE NEC, ANSI/NFPA 70. THEY CAN NOT GENERATE NOR STORE MORE THAN 1.5V, 100mA, 25mW OR A PASSIVE COMPONENT THAT DOES NOT DISSIPATE MORE THAN 1.3W.

8. SENSORS WITHOUT PREAMPS SHALL MEET THE REQUIREMENTS OF SIMPLE APPARATUS AS DEFINED IN ANSI/ISA RP12.6 AND THE NEC, ANSI/NFPA 70. THEY CAN NOT GENERATE NOR STORE MORE THAN 1.5V, 100mA, 25mW OR A PASSIVE COMPONENT THAT DOES NOT DISSIPATE MORE THAN 1.3W.

9. THE INTRINSICALLY SAFE ENTITY CONCEPT ALLOWS INTERCONNECTION OF INTRINSICALLY SAFE DEVICES WITH ASSOCIATED APPARATUS WHEN THE FOLLOWING IS TRUE:
FIELD DEVICE INPUT ASSOCIATED APPARATUS OUTPUT
V_{oc} OR V_t OR I_{sc} OR I_t OR I_o;
C_a OR C_i OR L_a OR L_i OR L_o;
L_a OR L_o;
C_a OR C_i OR L_a OR L_i OR L_o;
L_a OR L_o;
C_a OR C_i OR L_a OR L_i OR L_o;
L_a OR L_o;
C_a OR C_i OR L_a OR L_i OR L_o;
L_a OR L_o;
C_a OR C_i OR L_a OR L_i OR L_o;
L_a OR L_o;
C_a OR C_i OR L_a OR L_i OR L_o;
L_a OR L_o;

10. ASSOCIATED APPARATUS MANUFACTURER'S INSTALLATION DRAWING MUST BE FOLLOWED WHEN INSTALLING THIS EQUIPMENT.

11. CONTROL EQUIPMENT CONNECTED TO ASSOCIATED APPARATUS MUST NOT USE OR GENERATE MORE THAN 250 Vrms OR Vdc.

12. THE ASSOCIATED APPARATUS MUST BE FM APPROVED.

13. NO REVISION TO DRAWING WITHOUT PRIOR FM APPROVAL.

14. METAL CONDUIT IS NOT REQUIRED BUT IF USED BONDING BETWEEN CONDUIT IS NOT AUTOMATIC AND MUST BE PROVIDED AS PART OF THE INSTALLATION.

HAZARDOUS AREA

NON-HAZARDOUS AREA

UNSPECIFIED POWER SUPPLY
30 VDC MAX FOR IS
24V TYP

SAFETY BARRIER
(SEE NOTES 1 & 9)

LOAD

THIS DOCUMENT IS
CERTIFIED BY
FM REV. A

REASON NOT PERMITTED
VOID AGENCY APPROVAL

FIGURE 4-11. FM Intrinsically Safe Installation (1 of 2) for Model Xmt-P-FF

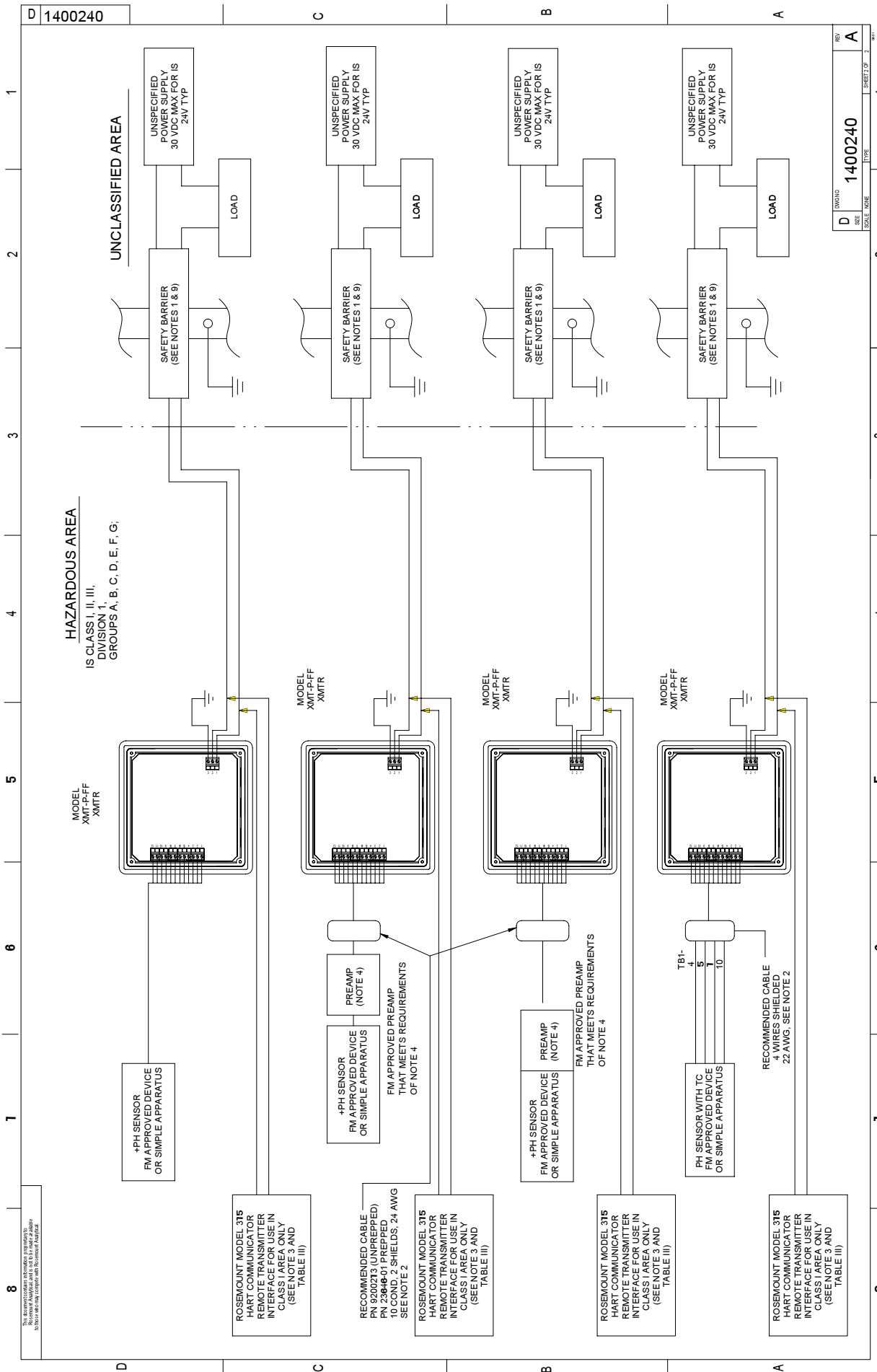
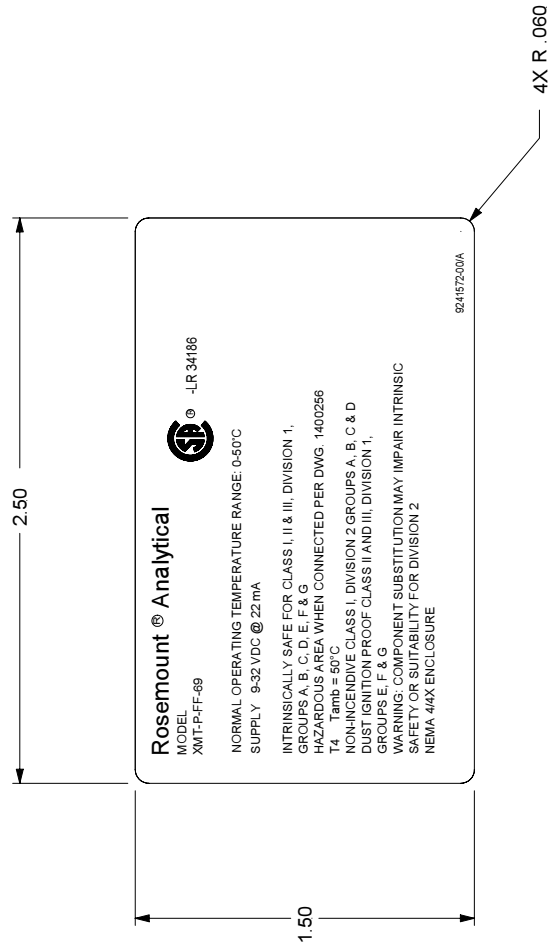

FIGURE 4-12. FM Intrinsically Safe Installation (2 of 2) for Model Xmt-P-FF

B 9241572-00

REVISIONS	DESCRIPTION	BY	DATE	CHK
ECO NO	REV	LTR	ECO	
9033	A			
RELEASE DATE				
10-6-04				

This document contains information proprietary to Rosemount Analytical, and is not to be made available to those who may compete with Rosemount Analytical.



THIS DOCUMENT IS CERTIFIED BY
 CSA REV A
 _____ REV _____
 _____ REV _____
 _____ REV _____
 _____ REV _____
 _____ REV _____
 _____ REV _____
 REVISIONS NOT PERMITTED
 W/O AGENCY APPROVAL

4. NO CHANGE WITHOUT CSA APPROVAL.
3. ALL ALPHA AND NUMERIC CHARACTERS ON LABEL TO BE BLACK HELVETICA MEDIUM. BACKGROUND TO BE WHITE.



2 MATERIAL: 3M SCOTCHCAL #3650-10 (WHITE VINYL FACESTOCK) OR POLYESTER (.002 REFERENCE THICKNESS CLEAR MATTE NYLAR OVERLAMINATE, .002-.005 FINISH THICKNESS. PRESSURE SENSITIVE ADHESIVE, FAR SIDE AND SPLIT LINER) OR (INTERMEC PN L7211210; 2 MIL GLOSS WHITE POLYESTER WITH PRESSURE SENSITIVE ACRYLIC ADHESIVE. NOMENCLATURE TO BE PRINTED USING INTERMEC SUPER PREMIUM BLACK THERMAL TRANSFER RIBBON) SEE BLANK LABEL PN 9241406-01.

1. ARTWORK IS SHEET 2 OF 2.

NOTES: UNLESS OTHERWISE SPECIFIED

UNLESS OTHERWISE SPECIFIED	ITEM	PART NO	DESCRIPTION	QTY
XX + .000 XXX + .010 TOLERANCES ANGLES + 1/2° DIMENSIONS ARE IN INCHES REMOVE BURRS & SHARP EDGES .020 MAX MACHINED FILET RADIUS .020 MAX NOMINAL SURFACE FINISH 125			BILL OF MATERIAL	
MATERIAL			Emerson	
FINISH			TITLE	
			LABEL, I.S. CSA XMT-P-FF	
			DWG NO	REV
			B 9241572-00	A
			SCALE	SHEET 1 OF 2
			2-1	2

FIGURE 4-13. CSA Intrinsically Safe Label for Model Xmt-P-FF

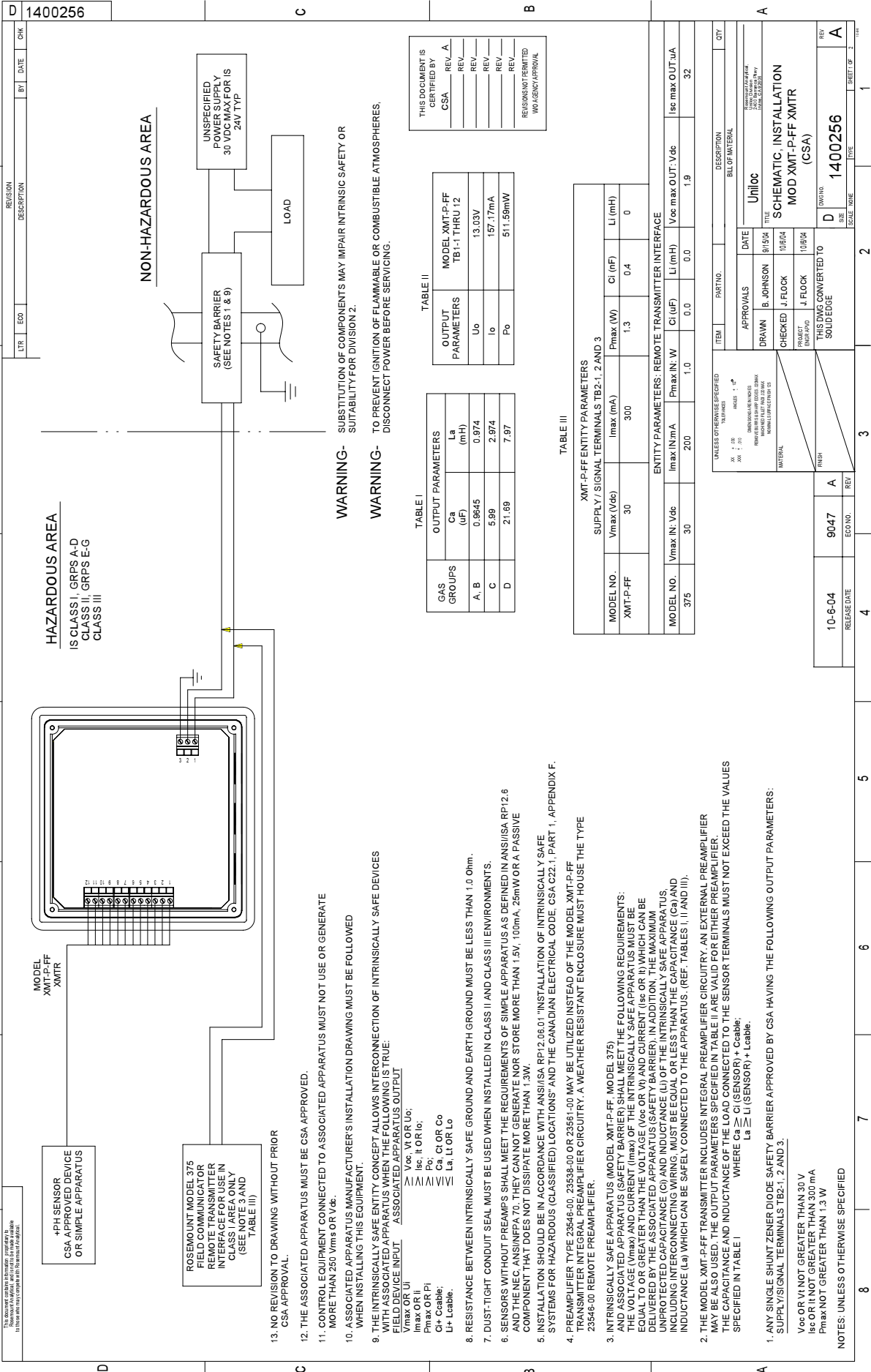

FIGURE 4-14. CSA Intrinsically Safe Installation (1 of 2) for Model Xmt-P-FF

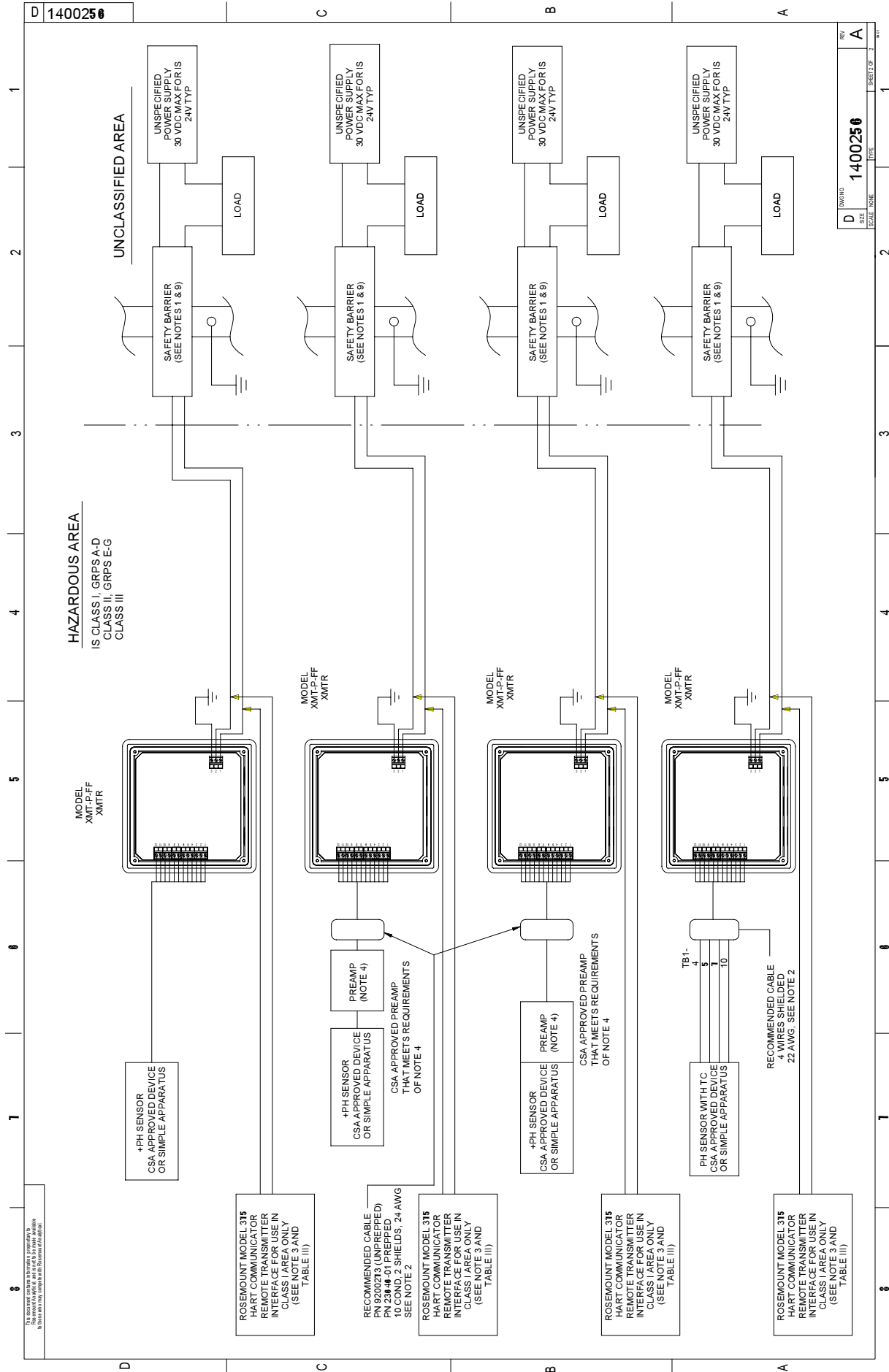

FIGURE 4-15. CSA Intrinsically Safe Installation (2 of 2) for Model Xmt-P-FF

B 9241580-00

REV	ECO NO	RELEASE DATE	ECO NO	REV	LTR	ECO	BY	DATE	CHK
A	9066	6-30-05	9066	A					

REVISIONS DESCRIPTION

THIS DOCUMENT IS CERTIFIED BY Baseefa REV. A

REVISIONS DESCRIPTION

REV A

ECO NO 9066

DATE 6-30-05

ECO NO 9066

REV A

RELEASE DATE 6-30-05

CHK

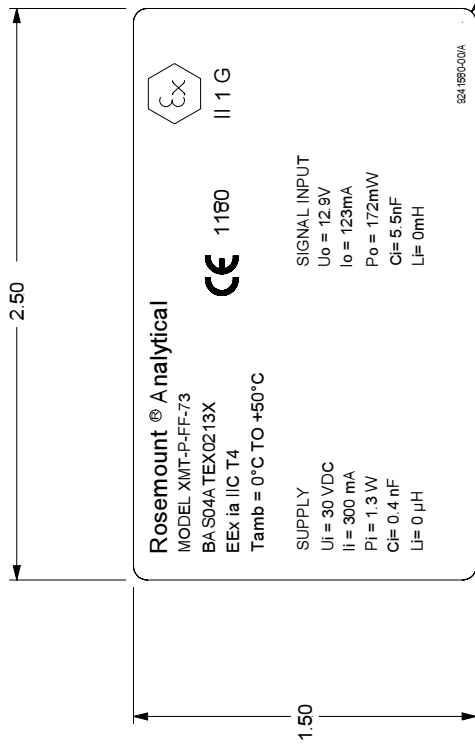

THIS DOCUMENT IS CERTIFIED BY Baseefa REV. A

REVISIONS NOT PERMITTED W/O AGENCY APPROVAL

Baseefa Certified Product No modifications permitted without the approval of the Authorized Person Related Drawing

ITEM	PART NO	DESCRIPTION	QTY
BILL OF MATERIAL			
APPROVALS		DATE	
DRAWN	B. JOHNSON	10/1/03	
CHECKED	J. FLOCK	10/6/04	
PROJECT ENGR	J. FLOCK	10/6/04	
THIS DWG CONVERTED TO SOLID EDGE			
DWG NO		9241580-00	REV A
SCALE		2:1	SHEET 1 OF 2

UNLESS OTHERWISE SPECIFIED	
TOLERANCES	ANGLES ± 1/2°
XX ± .000	
XXX ± .010	
DIMENSIONS ARE IN INCHES UNLESS OTHERWISE SPECIFIED	
REMOVE BURRS FROM ALL EDGES AND ROUNDS TO NOMINAL SURFACE FINISH 125	
MATERIAL	2
FINISH	

4. NO CHANGE WITHOUT Baseefa APPROVAL.

3. ALL ALPHA AND NUMERIC CHARACTERS ON LABEL TO BE BLACK HELVETICA MEDIUM. BACKGROUND TO BE WHITE.

2 MATERIAL: 3M SCOTCHCAL #3650-10 (WHITE VINYL FACESTOCK) OR POLYESTER, (.002 REFERENCE THICKNESS CLEAR MATTE MYLAR OVERLAMINATE, .002-.005 FINISH THICKNESS. PRESSURE SENSITIVE ADHESIVE, FARSIDE AND SPLIT LINER).

1. ARTWORK IS SHEET 2 OF 2.

NOTES: UNLESS OTHERWISE SPECIFIED

FIGURE 4-16. ATEX Intrinsically Safe Label for Model Xmt-P-FF

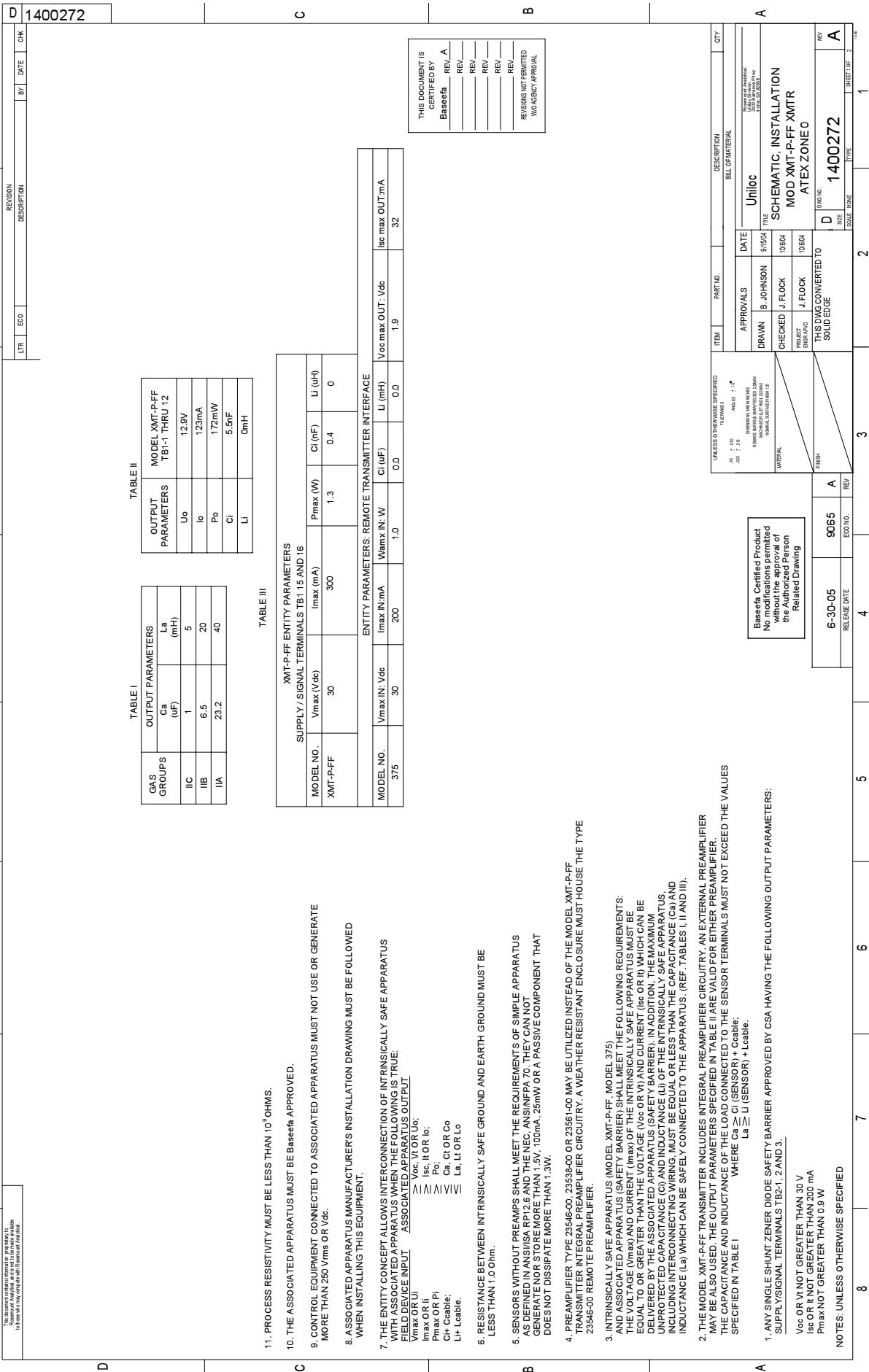
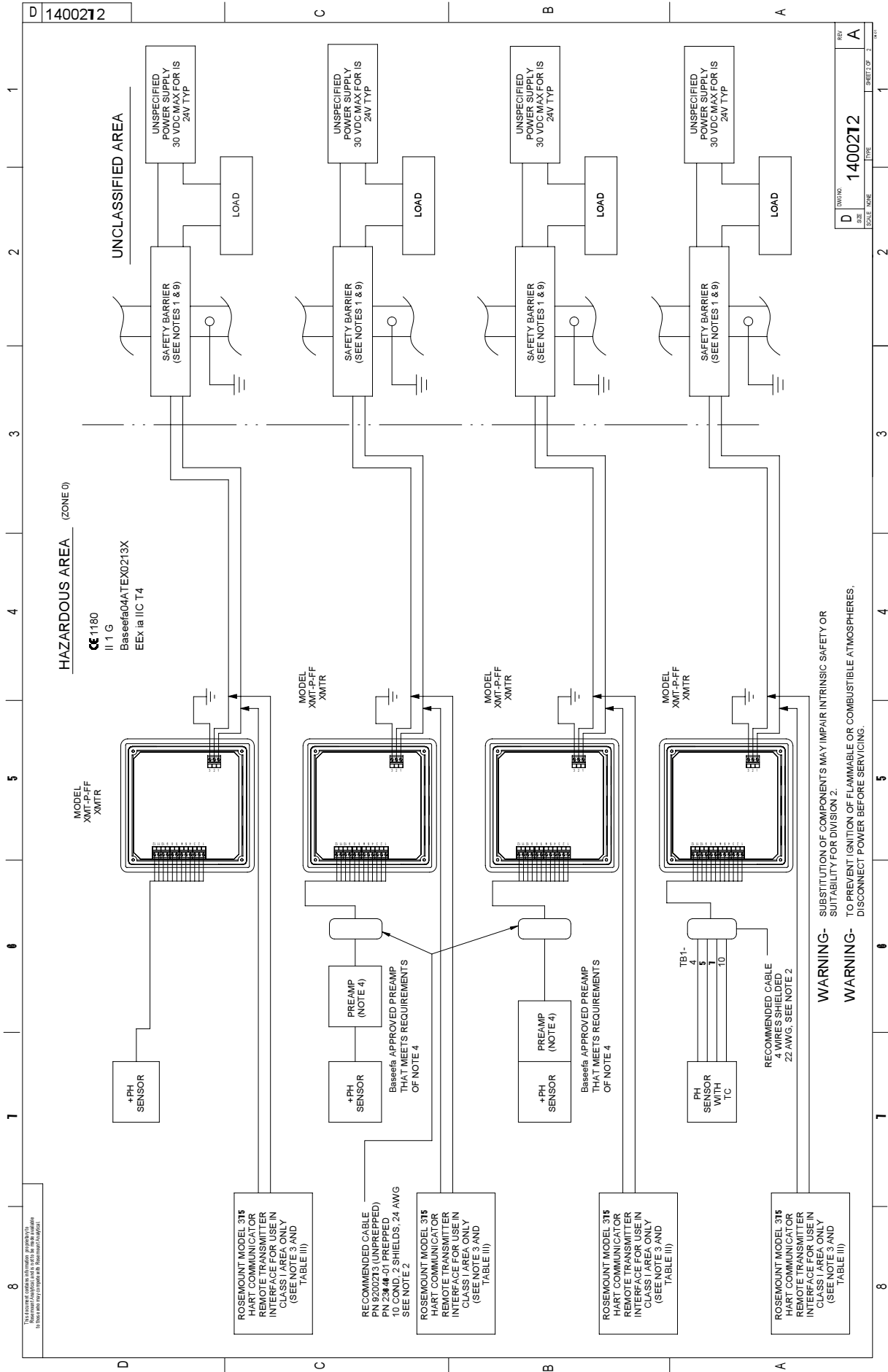

FIGURE 4-17. ATEX Intrinsically Safe Installation (1 of 2) for Model Xmt-P-FF



DATE	REV
D	A
SCALE	1400212
TYPE	SHEET 2 OF 2

FIGURE 4-18. ATEX Intrinsically Safe Installation (1 of 2) for Model Xmt-P-FF

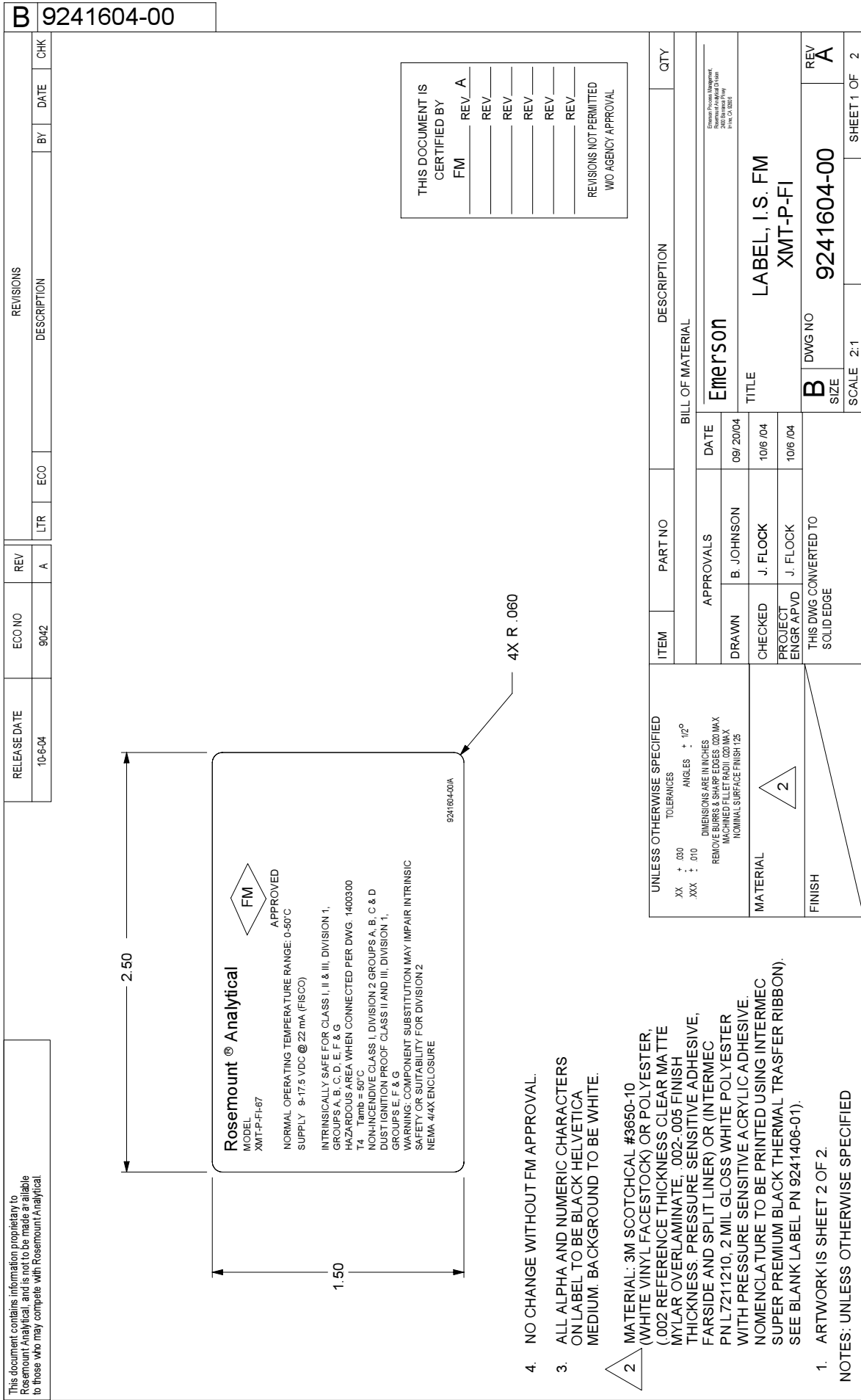

FIGURE 4-19. FM Intrinsically Safe Label for Model Xmt-P-FI

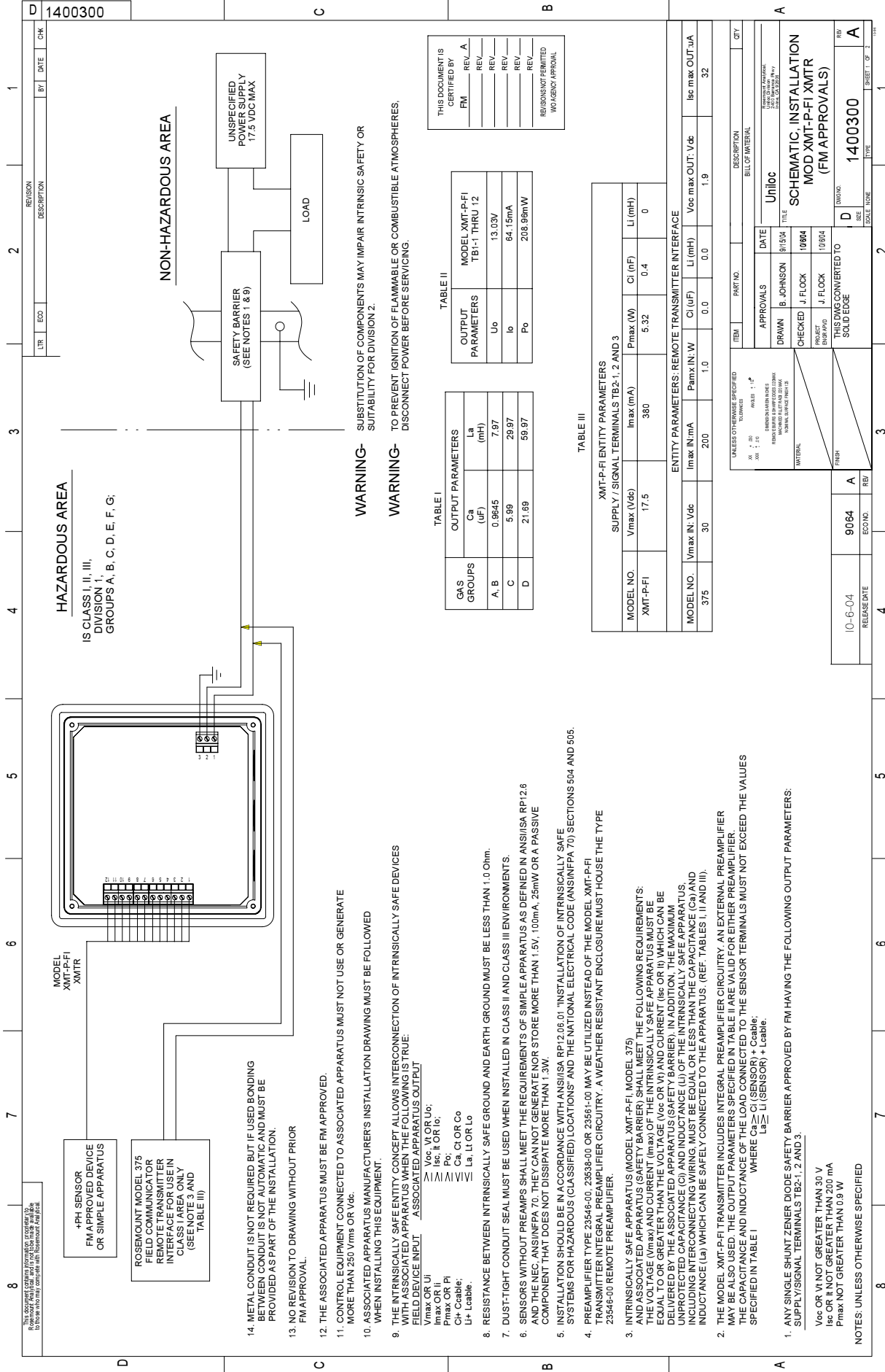

FIGURE 4-20. FM Intrinsically Safe Installation (1 of 2) for Model Xmt-P-FI

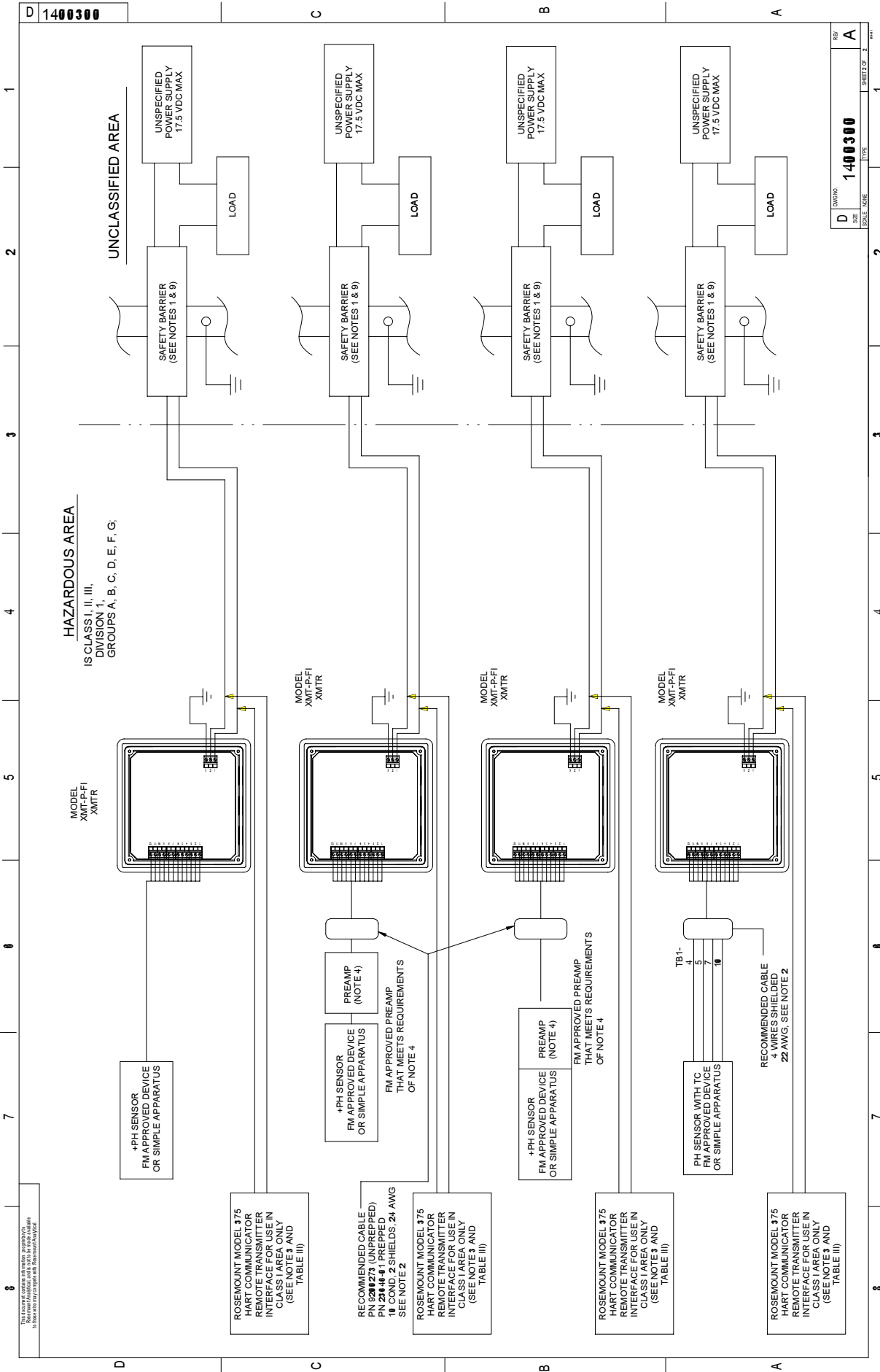

FIGURE 4-21. FM Intrinsically Safe Installation (2 of 2) for Model Xmt-P-FI

D	1400300	SCALE NONE
REV	A	SHEET 2 OF 2

B 9241608-00

REVISIONS	BY	DATE	CHK
DESCRIPTION			
ECO NO	REV	LTR	ECO
9033	A		
RELEASE DATE			
10-6-04			

This document contains information proprietary to Rosemount Analytical, and is to be made available to those who may compete with Rosemount Analytical.

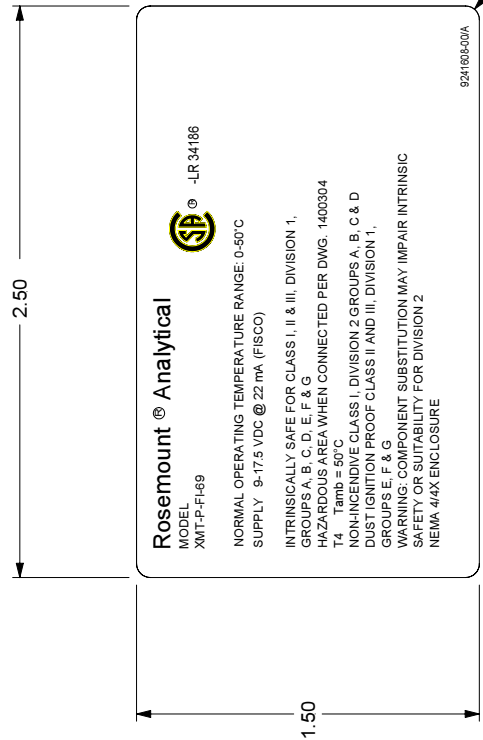

THIS DOCUMENT IS CERTIFIED BY

CSA	REV. A
_____	REV. _____
_____	REV. _____
_____	REV. _____
_____	REV. _____
_____	REV. _____
_____	REV. _____

REVISIONS NOT PERMITTED
 W/O AGENCY APPROVAL

4X R .060

4. NO CHANGE WITHOUT CSA APPROVAL.
3. ALL ALPHA AND NUMERIC CHARACTERS ON LABEL TO BE BLACK HELVETICA MEDIUM. BACKGROUND TO BE WHITE.
2. MATERIAL: 3M SCOTCHCAL #3650-10 (WHITE VINYL FACESTOCK) OR POLYESTER, (.002 REFERENCE THICKNESS CLEAR MATTE MYLAR OVERLAMINATE .002-.005 FINISH THICKNESS. PRESSURE SENSITIVE ADHESIVE, FARSIDE AND SPLIT LINER) OR (INTERMEC PN L7211210, 2 MIL GLOSS WHITE POLYESTER WITH PRESSURE SENSITIVE ACRYLIC ADHESIVE. NOMENCLATURE TO BE PRINTED USING INTERMEC SUPER PREMIUM BLACK THERMAL TRANSFER RIBBON). SEE BLANK LABEL PN 9241406-01).
1. ARTWORK IS SHEET 2 OF 2.

NOTES: UNLESS OTHERWISE SPECIFIED

UNLESS OTHERWISE SPECIFIED	ITEM	PART NO	DESCRIPTION	QTY
XX + .030 TOLERANCES			BILL OF MATERIAL	
.XXX ± .010 ANGLES ± 1/2°			Emerson	
DIMENSIONS ARE IN INCHES	APPROVALS	DATE		
REMOVE BURS & SHARP EDGES .003 MAX	B. JOHNSON	09/20/04		
MACHINED FILLET RADI .003 MAX	J. FLOCK	10/16/04	TITLE	
NOMINAL SURFACE FINISH 125	J. FLOCK	10/16/04	LABEL, I.S. CSA	
			XMT-P-FI	
MATERIAL	THIS DWG CONVERTED TO SOLIDEDGE		DWG NO	REV
FINISH			B	A
			SIZE	
			9241608-00	
			SCALE	SHEET 1 OF 2
			2:1	

FIGURE 4-22. CSA Intrinsically Safe Label for Model Xmt-P-Fi

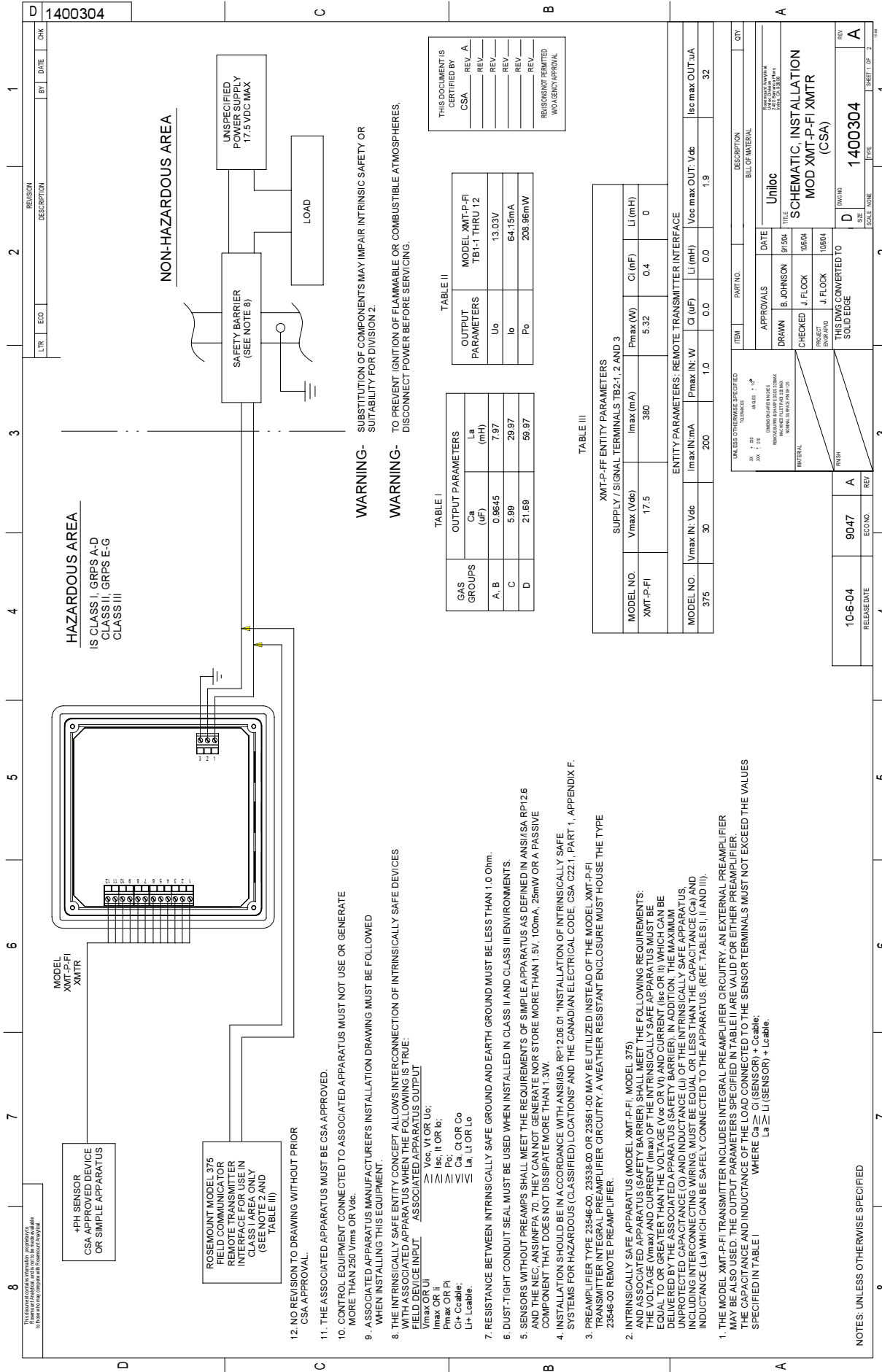

FIGURE 4-23. CSA Intrinsically Safe Installation (1 of 2) for Model Xmt-P-Fi

12. NO REVISION TO DRAWING WITHOUT PRIOR CSA APPROVAL.

11. THE A ASSOCIATED APPARATUS MUST BE CSA APPROVED.
 10. CONTROL EQUIPMENT CONNECTED TO ASSOCIATED APPARATUS MUST NOT USE OR GENERATE MORE THAN 250 Vrms OR Vdc.
 9. ASSOCIATED APPARATUS MANUFACTURERS INSTALLATION DRAWING MUST BE FOLLOWED WHEN INSTALLING THIS EQUIPMENT.
 8. THE INTRINSICALLY SAFE ENTITY CONCEPT ALLOWS INTERCONNECTION OF INTRINSICALLY SAFE DEVICES WITH AN ASSOCIATED APPARATUS WHEN THE FOLLOWING IS TRUE:
 FIELD DEVICE INPUT ASSOCIATED APPARATUS OUTPUT
 Vmax OR Uo ≥ Voc, VI OR Uo;
 Pmax OR IOR PI ≥ Isc, II OR Io;
 Cs, CI OR Co
 La, LI OR Lo

7. RESISTANCE BETWEEN INTRINSICALLY SAFE GROUND AND EARTH GROUND MUST BE LESS THAN 1.0 Ohm.
 6. DUST-TIGHT CONDUIT SEAL MUST BE USED WHEN INSTALLED IN CLASS II AND CLASS III ENVIRONMENTS.
 5. SENSORS WITHOUT PREAMPS SHALL MEET THE REQUIREMENTS OF SIMPLE APPARATUS AS DEFINED IN ANSI/ISA RP126 AND THE NEC, ANS/INFPA 70. THEY CAN NOT GENERATE NOR STORE MORE THAN 1.5V, 100mA, 25mW OR A PASSIVE COMPONENT THAT DOES NOT DISSIPATE MORE THAN 1.3W.
 4. INSTALLATION SHOULD BE IN ACCORDANCE WITH ANSI/ISA RP1206.01 "INSTALLATION OF INTRINSICALLY SAFE SYSTEMS FOR HAZARDOUS (CLASSIFIED) LOCATIONS" AND THE CANADIAN ELECTRICAL CODE, CSA C22.1, PART 1, APPENDIX F.
 3. PREAMPLIFIER TYPE 23546-00, 23559-00, OR 23561-00 MAY BE UTILIZED INSTEAD OF THE MODEL XMT-P-FI TRANSMITTER INTEGRAL PREAMPLIFIER CIRCUITRY. A WEATHER RESISTANT ENCLOSURE MUST HOUSE THE TYPE 23546-00 REMOTE PREAMPLIFIER.
 2. INTRINSICALLY SAFE APPARATUS (MODEL XMT-P-FI, MODEL 375) AND ASSOCIATED APPARATUS (SAFETY BARRIER) SHALL MEET THE FOLLOWING REQUIREMENTS:
 THE VOLTAGE (Vmax) AND CURRENT (Imax) OF THE INTRINSICALLY SAFE APPARATUS MUST BE EQUAL TO OR GREATER THAN THE VOLTAGE (Voc OR VI) AND CURRENT (Isc OR II) WHICH CAN BE DELIVERED BY THE ASSOCIATED APPARATUS (SAFETY BARRIER). IN ADDITION, THE MAXIMUM CAPACITANCE (Cs) AND INDUCTANCE (La) OF THE INTRINSICALLY SAFE APPARATUS MUST BE EQUAL TO OR LESS THAN THE CAPACITANCE (CI) AND INDUCTANCE (LI) WHICH CAN BE SAFELY CONNECTED TO THE APPARATUS. (REF. TABLES I, II AND III).
 1. THE MODEL XMT-P-FI TRANSMITTER INCLUDES INTEGRAL PREAMPLIFIER CIRCUITRY. AN EXTERNAL PREAMPLIFIER MAY BE ALSO USED. THE OUTPUT PARAMETERS SPECIFIED IN TABLE II ARE VALID FOR EITHER PREAMPLIFIER. THE CAPACITANCE AND INDUCTANCE OF THE LOAD CONNECTED TO THE SENSOR TERMINALS MUST NOT EXCEED THE VALUES SPECIFIED IN TABLE I
 WHERE $C_a \geq C_i$ (SENSOR) + C_{cable}
 $L_a \geq L_i$ (SENSOR) + L_{cable} .

NOTES: UNLESS OTHERWISE SPECIFIED

REV.	DATE	BY	CHK
1			

1400304

ITEM	PART NO.	DESCRIPTION	QTY
	Uniloc	SCHEMATIC INSTALLATION MOD XMT-P-FI XMTR (CSA)	

DATE	TIME	DATE	TIME
10-6-04	9047	1400304	

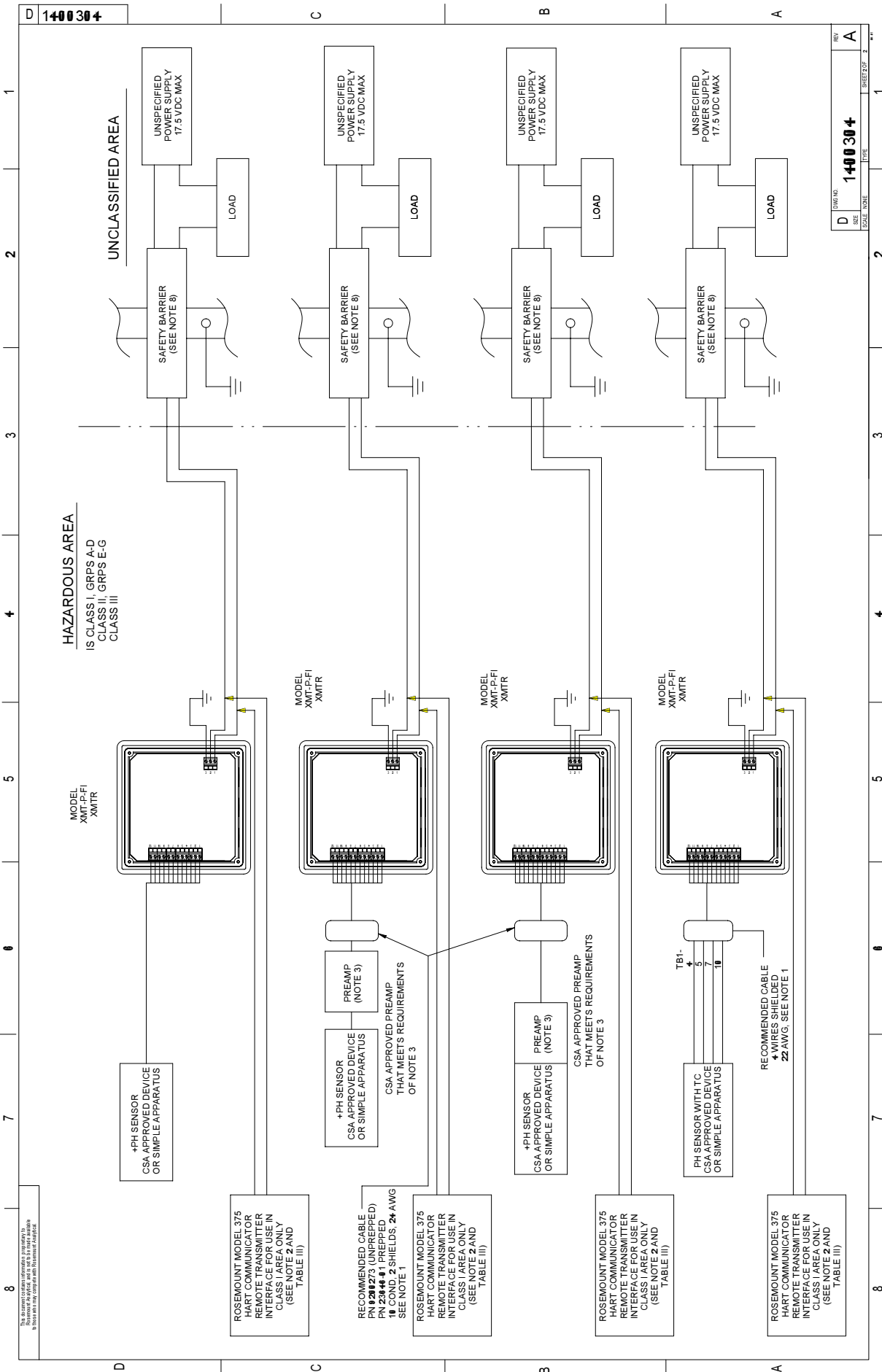
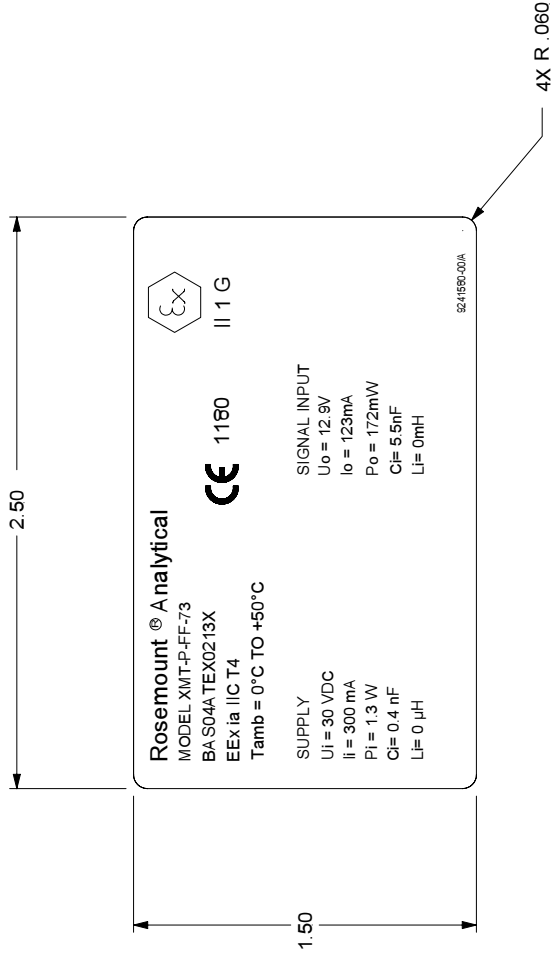

FIGURE 4-24. CSA Intrinsically Safe Installation (2 of 2) for Model Xmt-P-Fi

B 9241580-00

REV	ECO NO	RELEASE DATE	ECO NO	REV	LTR	ECO	BY	DATE	CHK
A	9086	6-30-05	9086	A					

This document contains information proprietary to Rosemount Analytical, and is not to be made available to those who may compete with Rosemount Analytical.



THIS DOCUMENT IS CERTIFIED BY
Baseefa REV. A
 REV. _____
 REV. _____
 REV. _____
 REV. _____
 REV. _____
 REVISIONS NOT PERMITTED
 W/O AGENCY APPROVAL

Baseefa Certified Product
 No modifications permitted
 without the approval of
 the Authorized Person
 Related Drawing

UNLESS OTHERWISE SPECIFIED	ITEM	PART NO	DESCRIPTION	QTY
TOLERANCES XX + .030 XXX ± .010				
ANGLES ± 1/2°				
DIMENSIONS ARE IN INCHES REMOVE BURRS & SHARP EDGES (0.02) MAX MACHINED FLLET R/D (0.02) MAX NOMINAL SURFACE FINISH 125				
MATERIAL	DRAWN	APPROVALS	DATE	
FINISH	CHECKED	B. JOHNSON	10/ /03	
	PROJECT ENGR APVD	J. FLOCK	10/16 /04	
	SOLID EDGE	J. FLOCK	10/16 /04	
	THIS DWG CONVERTED TO SOLID EDGE			
	DWG NO	TITLE		REV
	B	Emerson LABEL, I. S. Baseefa XMT-P-FF		A
	SIZE	SCALE 2:1		SHEET 1 OF 2
	9241580-00			2

- ARTWORK IS SHEET 2 OF 2.
- NO CHANGE WITHOUT Baseefa APPROVAL.
- ALL ALPHA AND NUMERIC CHARACTERS ON LABEL TO BE BLACK HELVETICA MEDIUM. BACKGROUND TO BE WHITE.
- MATERIAL: 3M SCOTCHCAL #3650-10 (WHITE VINYL FACESTOCK) OR POLYESTER, (.002 REFERENCE THICKNESS) CLEAR MATTE MYLAR OVERLAMINATE, .002-.005 FINISH THICKNESS. PRESSURE SENSITIVE ADHESIVE, FARSIDE AND SPLIT LINER.

NOTES: UNLESS OTHERWISE SPECIFIED

FIGURE 4-25. ATEX Intrinsically Safe Label for Model Xmt-P-Fi

1400308	REVISION	BY	DATE	CHK
	DESCRIPTION			

TABLE I
OUTPUT PARAMETERS

GAS GROUPS	Ca (uF)	La (mH)
IIC	1	5
IIB	6.5	20
IHA	23.2	40

TABLE II
OUTPUT PARAMETERS

MODEL XMT-PFI TB1-1 THRU 12	
Uo	12.9V
Io	123mA
Po	172mW
CI	5.5mF
LI	0mH

TABLE III
XMT-PFI ENTITY PARAMETERS

SUPPLY / SIGNAL TERMINALS TB1 15 AND 16					
MODEL NO.	Vmax (Vdc)	Imax (mA)	Pmax (W)	CI (uF)	LI (uH)
XMT-PFI	17.5	380	5.32	0.4	0

ENTITY PARAMETERS: REMOTE TRANSMITTER INTERFACE					
MODEL NO.	Vmax IN: Vdc	Imax IN: mA	Wmax IN: W	CI (uF)	LI (mH)
375	30	200	1.0	0.0	0.0

TABLE IV
ENTITY PARAMETERS: REMOTE TRANSMITTER INTERFACE

MODEL NO.	Voc max OUT: Vdc	Isc max OUT: mA
375	1.9	32

- PROCESS RESISTIVITY MUST BE LESS THAN 10⁹ OHMS.
- THE ASSOCIATED APPARATUS MUST BE Baseefa APPROVED.
- CONTROL EQUIPMENT CONNECTED TO A ASSOCIATED APPARATUS MUST NOT USE OR GENERATE MORE THAN 250 Vrms OR Vdc.
- ASSOCIATED APPARATUS MANUFACTURER'S INSTALLATION DRAWING MUST BE FOLLOWED WHEN INSTALLING THIS EQUIPMENT.
- THE ENTITY CONCEPT ALLOWS INTERCONNECTION OF INTRINSICALLY SAFE APPARATUS WITH ASSOCIATED APPARATUS WHEN THE FOLLOWING IS TRUE:
FIELD DEVICE INPUT ASSOCIATED APPARATUS OUTPUT

$$V_{max} OR U_o \leq V_{oc} \text{ OR } V_{dc}$$

$$I_{max} OR I_o \leq I_{sc} \text{ OR } I_{dc}$$

$$P_{max} OR P_o \leq P_{oc} \text{ OR } P_{dc}$$

$$C_I \leq C_{Ic}$$

$$L_I \leq L_{Ic}$$
- RESISTANCE BETWEEN INTRINSICALLY SAFE GROUND AND EARTH GROUND MUST BE LESS THAN 1.0 Ohm.
- SENSORS WITHOUT PREAMPS SHALL MEET THE REQUIREMENTS OF SIMPLE APPARATUS AS DEFINED IN ANSI/ISA RPT2.6 AND THE NEC, ANS/NFPA 70. THEY CAN NOT GENERATE NOR STORE MORE THAN 1.5V, 100mA, 25mW OR A PASSIVE COMPONENT THAT DOES NOT DISSIPATE MORE THAN 1.3W.
- PREAMPLIFIER TYPE 23546-00, 23538-00 OR 23561-00 MAY BE UTILIZED INSTEAD OF THE MODEL XMT-PFI TRANSMITTER INTEGRAL PREAMPLIFIER CIRCUITRY. A WEATHER RESISTANT ENCLOSURE MUST HOUSE THE TYPE 23546-00 REMOTE PREAMPLIFIER.
- INTRINSICALLY SAFE APPARATUS (MODEL XMT-PFI, MODEL 375) AND ASSOCIATED APPARATUS (SAFETY BARRIER) SHALL MEET THE FOLLOWING REQUIREMENTS: THE VOLTAGE (Vmax) AND CURRENT (Imax) OF THE INTRINSICALLY SAFE APPARATUS MUST BE EQUAL TO OR GREATER THAN THE VOLTAGE (Voc OR Vd) AND CURRENT (Isc OR Io) WHICH CAN BE DELIVERED BY THE ASSOCIATED APPARATUS (SAFETY BARRIER). IN ADDITION, THE MAXIMUM UNPROTECTED CAPACITANCE (CI) AND INDUCTANCE (LI) OF THE INTRINSICALLY SAFE APPARATUS, INCLUDING INTERCONNECTING WIRING, MUST BE EQUAL OR LESS THAN THE CAPACITANCE (Ca) AND INDUCTANCE (La) WHICH CAN BE SAFELY CONNECTED TO THE APPARATUS. (REF. TABLES I, II AND III).
- THE MODEL XMT-PFI TRANSMITTER INCLUDES INTEGRAL PREAMPLIFIER CIRCUITRY. AN EXTERNAL PREAMPLIFIER MAY BE ALSO USED. THE OUTPUT PARAMETERS SPECIFIED IN TABLE II ARE VALID FOR EITHER PREAMPLIFIER. THE CAPACITANCE AND INDUCTANCE OF THE LOAD CONNECTED TO THE SENSOR TERMINALS MUST NOT EXCEED THE VALUES SPECIFIED IN TABLE I

$$C_a \geq C_i \text{ (SENSOR)} + C_{cable}$$

$$L_a \geq L_i \text{ (SENSOR)} + L_{cable}$$
- ANY SINGLE SHUNT ZENER DIODE SAFETY BARRIER APPROVED BY CSA HAVING THE FOLLOWING OUTPUT PARAMETERS:
SUPPLY/SIGNAL TERMINALS TB2-1, 2 AND 3.
Voc OR Vd NOT GREATER THAN 30 V
Isc OR Id NOT GREATER THAN 200 mA
Pmax NOT GREATER THAN 0.9 W
NOTES: UNLESS OTHERWISE SPECIFIED

THIS DOCUMENT IS CERTIFIED BY
Baseefa REV. A

UNLESS OTHERWISE SPECIFIED	ITEM	PART NO.	DESCRIPTION	QTY
XX : 30 XX : 25 XX : 15 XX : 10 XX : 5 XX : 1			BELL UP MATERIAL	
UNLESS OTHERWISE SPECIFIED	APPROVALS	DATE		
XX : 30 XX : 25 XX : 15 XX : 10 XX : 5 XX : 1	DRAWN: B. JOHNSON CHECKED: J. FLOCK DESIGNED: J. FLOCK	9/20/01 10/02/04 10/02/04	Uniloc	
UNLESS OTHERWISE SPECIFIED	THIS DWG. CONVERTED TO SOLID EDGE			
UNLESS OTHERWISE SPECIFIED	6-30-05	9065	1400308	A
UNLESS OTHERWISE SPECIFIED	RELEASE DATE	ECONO. REV.	SCALE	TYPE
UNLESS OTHERWISE SPECIFIED				

BASEEFA CERTIFIED PRODUCT
No modifications permitted without the approval of the Authorized Person Related Drawing

SCHEMATIC, INSTALLATION
MOD XMT-PFI XMTR
ATEX ZONE 0

FIGURE 4-26. ATEX Intrinsically Safe Installation (1 of 2) for Model Xmt-P-FI

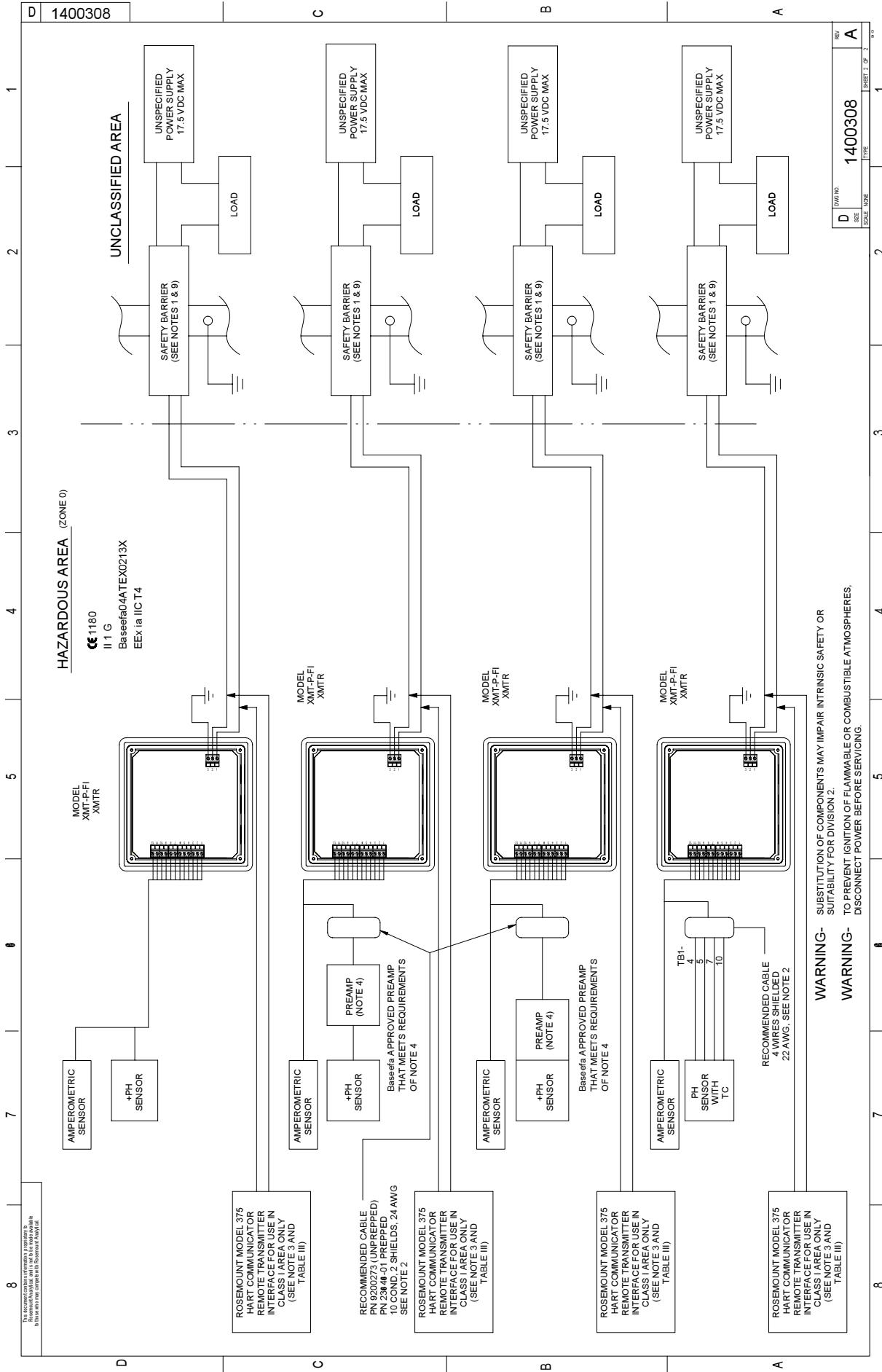

FIGURE 4-27. ATEX Intrinsically Safe Installation (2 of 2) for Model Xmt-P-Fi

WARNING- SUBSTITUTION OF COMPONENTS MAY IMPAIR INTRINSIC SAFETY OR SUITABILITY FOR DIVISION 2.

WARNING- TO PREVENT IGNITION OF FLAMMABLE OR COMBUSTIBLE ATMOSPHERES, DISCONNECT POWER BEFORE SERVICING.

SECTION 5.0 DISPLAY AND OPERATION

5.1. DISPLAY

The Model Xmt-P has a two-line display. Generally, the user can program the transmitter to show one of three displays. If the transmitter has been configured to measure ORP or Redox, similar displays are available. Figure 5-1 shows the displays available for pH.

The transmitter has information screens that supplement the data in the main display. Press ▼ to view the information screens. The first information screen shows the type of measurement being made (pH, ORP, Redox). **The last information screen is the software version number.**

During calibration and programming, key presses cause different displays to appear. The displays are self-explanatory and guide the user step-by-step through the procedure.

5.2 KEYPAD

Figure 5-2 shows the Solu Comp Xmt keypad.

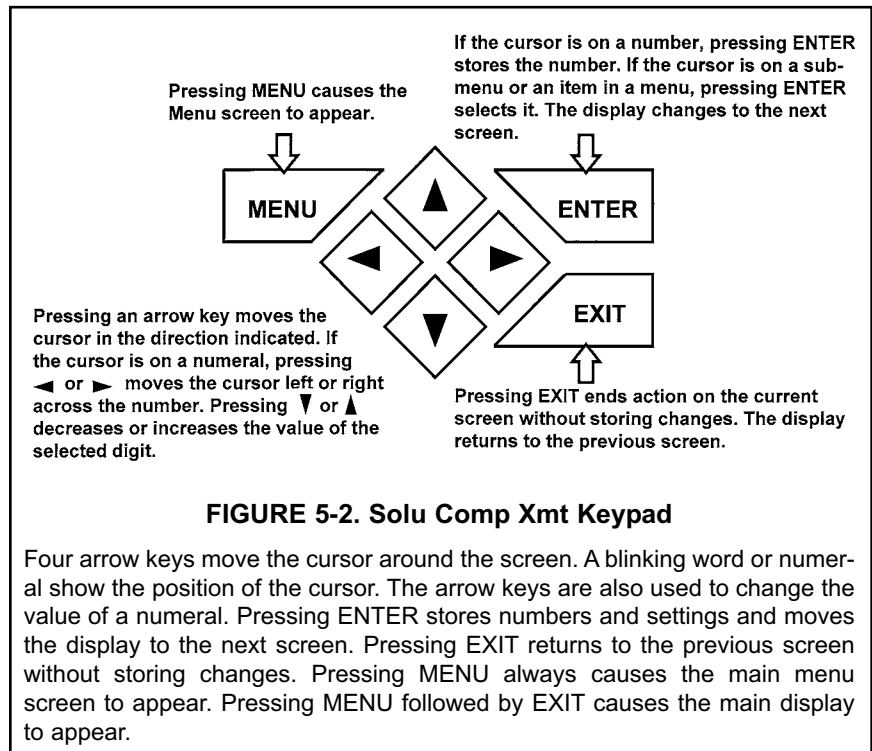
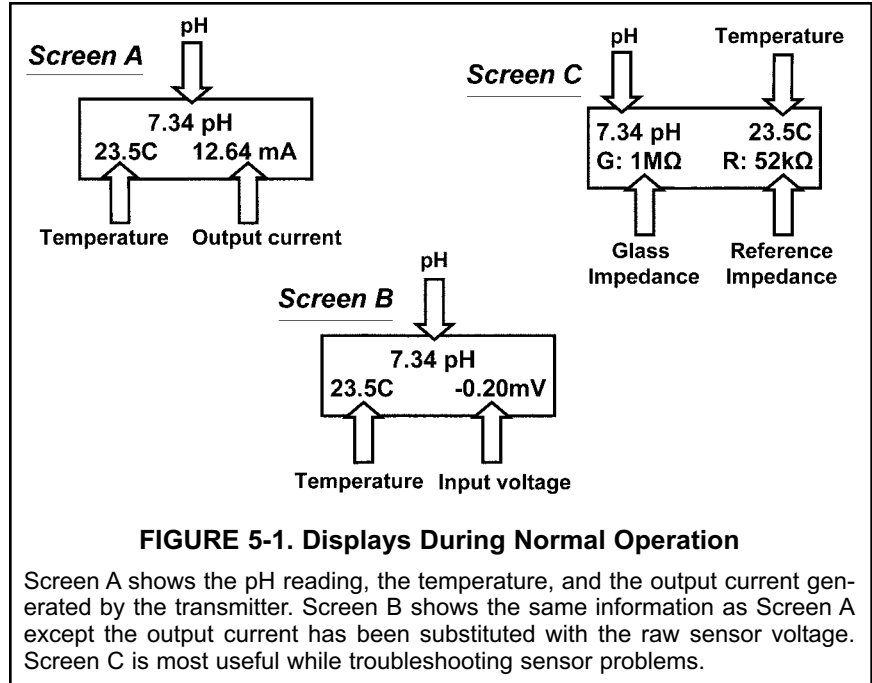

5.3 PROGRAMMING AND CALIBRATING THE MODEL XMT - TUTORIAL

Setting up and calibrating the Model Xmt is easy. The following tutorial describes how to move around in the programming menus. For practice, the tutorial also describes how to assign values to the 4 and 20 mA output.

Calibrate	Hold
Program	Display

Calibrate	Hold
Program	Display

Output	Temp
Measurement	>>

Security	HART
	>>

Noise Rejection	
ResetAnalyzer	>>

Output?	Test
Configure	Range

Output Range?	
4mA	+0.000PPM

Output Range?	
20mA	+10.00PPM

Output?	Test
Configure	Range

1. If the menu screen (shown at the left) is not already showing, press MENU. **Calibrate** is blinking, which means the cursor is on **Calibrate**.
2. To assign values to the current output, the **Program** sub-menu must be open. Press ▼. The cursor moves to **Program** (**Program** blinking.) Press ENTER. Pressing ENTER opens the **Program** sub-menu.
3. The **Program** sub-menu permits the user to configure and assign values to the 4-20 mA output, to test and trim the output, to change the type of measurement from what was selected during Quick Start, to set manual or automatic temperature correction for membrane permeability, and to set security codes. When the sub-menu opens, **Output** is blinking, which means the cursor is on **Output**. Press ▼ or ► (or any arrow key) to move the cursor around the display. Move the cursor to >> and press ENTER to cause a second screen with more program items to appear. There are three screens in the **Program** sub-menu. Pressing >> and ENTER in the third screen cause the display to return to the first screen (**Output, Temp, Measurement**).
4. For practice, assign values to the 4 and 20 mA output. Move the cursor to **Output** and press ENTER.
5. The screen shown at left appears. **Test** is blinking. Move the cursor to **Range** and press ENTER.
6. The screen shown at left appears. + is blinking, which means the cursor is on +.
 - a. To toggle between + and - press ▲ or ▼.
 - b. To move from one digit to the next, press ◀ or ▶.
 - c. To increase or decrease the value of a digit, press ▲ or ▼.
 - d. To move the decimal point, press ◀ or ▶ until the cursor is on the decimal point. Press ▲ to move the decimal to the right. Press ▼ to move the decimal point to the left.
 - e. Press ENTER to store the number.
7. The screen shown at left appears. Use this screen to assign a full scale value to the 20 mA output. Use the arrow keys to change the number to the desired value. Press ENTER to store the setting.
8. The screen shown at left appears. To configure the output or to test the output, move the cursor to the appropriate place and press ENTER.
9. To return to the main menu, press MENU. To return to the main display, press MENU then EXIT, or press EXIT repeatedly until the main display appears. To return to the previous display, press EXIT.

NOTE

To store values or settings, press ENTER before pressing EXIT.

5.4 MENU TREES - pH

The Model Xmt-P pH transmitter has four menus: CALIBRATE, PROGRAM, HOLD, and DISPLAY. Under the Calibrate and Program menus are several sub-menus. For example, under CALIBRATE, the sub-menus are **Temperature** and **pH or ORP/Redox**. Under each sub-menu are prompts. Under PROGRAM, the sub-menus for Xmt-P-HT are **Output, Temp, Measurement, Security, HART, Diagnostics, Noise Rejection, and Reset Analyzer**. The HOLD menu (HART only) enables or disables the 4-20 mA outputs. The DISPLAY menu allows the user to configure the main display information fields and to adjust the LCD display contrast. Figure 5-5 shows the complete menu tree for Model Xmt-P-HT. Figure 5-6 shows the complete menu tree for Model Xmt-P-FF.

5.5 DIAGNOSTIC MESSAGES - pH

Whenever a warning or fault limit has been exceeded, the transmitter displays diagnostic messages to aid in troubleshooting. "Fault" or "Warn" appears in the main display to alert the user of an adverse condition. The display alternates between the regular display and the Fault or Warning message. If more than one warning or fault message has been generated, the messages appear alternately.

See Section 10.0, Troubleshooting, for the meanings of the fault and warning messages.

FIGURE 5-3. MENU TREE FOR MODEL SOLU COMP Xmt-P-HT TRANSMITTER

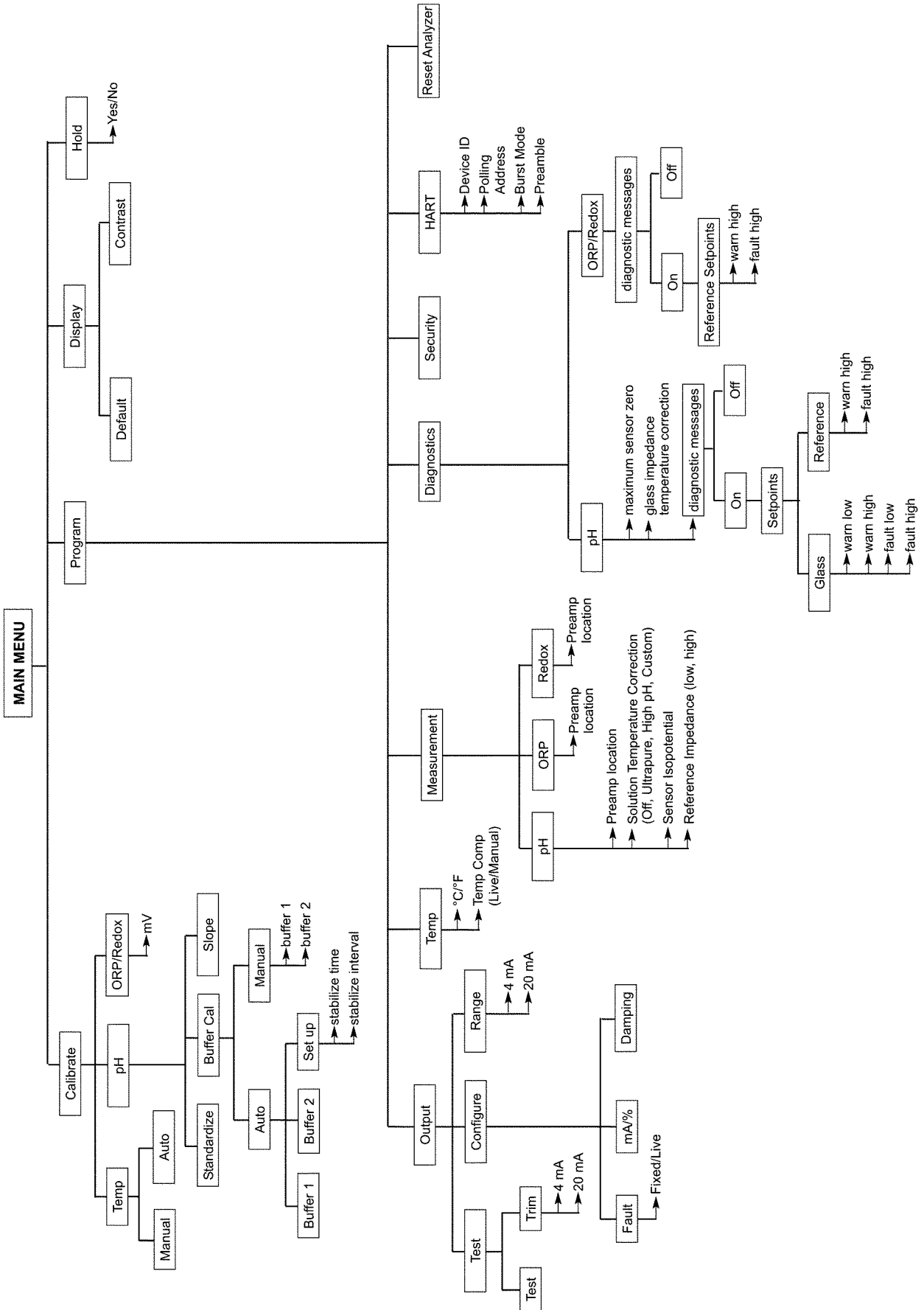
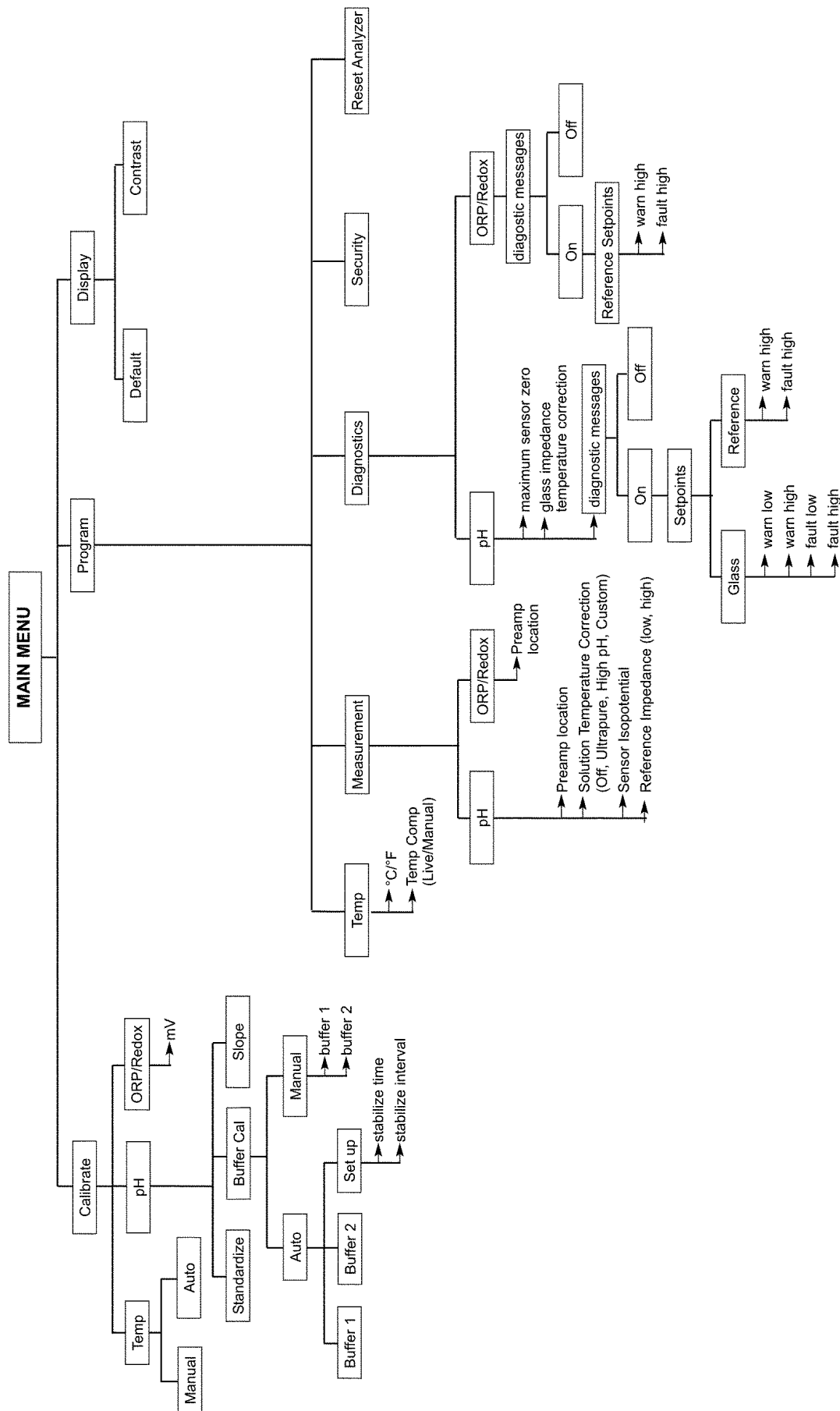

FIGURE 5-4. MENU TREE FOR MODEL SOLU COMP Xmt-P-FF TRANSMITTER



5.6 SECURITY

5.6.1 How the Security Code Works

Use security codes to prevent accidental or unwanted changes to program settings, displays, and calibration. Two three-digit security codes can be used to do the following...

- a. Allow a user to view the default display and information screens only.
- b. Allow a user access to the calibration and hold menus only.
- c. Allow a user access to all the menus.

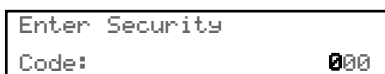

1. If a security code has been programmed, pressing MENU causes the security screen to appear.
2. Enter the three-digit security code.
 - a. If a security code has been assigned to **configure** only, entering it will unlock all the menus.
 - b. If separate security codes have been assigned to **calibrate** and **configure**, entering the calibrate code will allow the user access to only the calibrate and hold menus; entering the configuration code will allow the user access to all menus.
3. If the entered code is correct, the main menu screen appears. If the code is incorrect, the **Invalid Code** screen appears. The **Enter Security Code** screen reappears after two seconds.

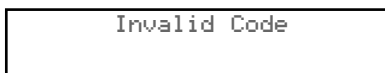

5.6.2 Bypassing the Security Code

Enter 555. The main menu will open.

5.6.3 Setting a Security Code

See Section 7.6.

5.7 USING HOLD

5.7.1 Purpose

The transmitter output is always proportional to the process variable (oxygen, free chlorine, total chlorine, monochloramine, or ozone). To prevent improper operation of control systems or dosing pumps, place the transmitter in hold before removing the sensor for maintenance. Be sure to remove the transmitter from hold once the work is complete and the sensor has been returned to the process liquid. During hold the transmitter current goes to the value programmed by the user. Once in hold, the transmitter remains there indefinitely. While in hold, the word "hold" appears periodically in the display.

5.7.2 Using the Hold Function

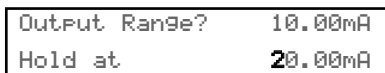
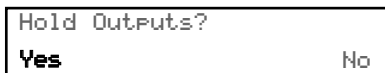

1. Press MENU. The main menu screen appears. Choose **Hold**.
2. The **Hold Output** screen appears. Choose **Yes** to put the transmitter in hold.
3. The top line in the display is the present current output. Use the arrow keys to change the number in the second line to the desired current during hold.
4. The main display screen appears.
5. To take the transmitter out of hold, repeat steps 1 and 2 and choose **No** in step 2.

SECTION 6.0 OPERATION WITH MODEL 375

6.1 Note on Model 375 HART and Foundation Fieldbus Communicator

The Model 375 HART Communicator is a product of Emerson Process Management, Rosemount Inc. This section contains selected information on using the Model 375 with the Rosemount Analytical Model Xmt-P-HT Transmitter and Model Xmt-P-FF Transmitter. For complete information on the Model 375 Communicator, see the Model 375 instruction manual. For technical support on the Model 375 Communicator, call Rosemount Inc. at (800) 999-9307 within the United States. Support is available worldwide on the internet at <http://rosemount.com>.

6.2 Connecting the HART and Foundation Fieldbus Communicator

Figure 6-1 shows how the Model 275 or 375 Communicator connects to the output lines from the Model Xmt-P-HT Transmitter.

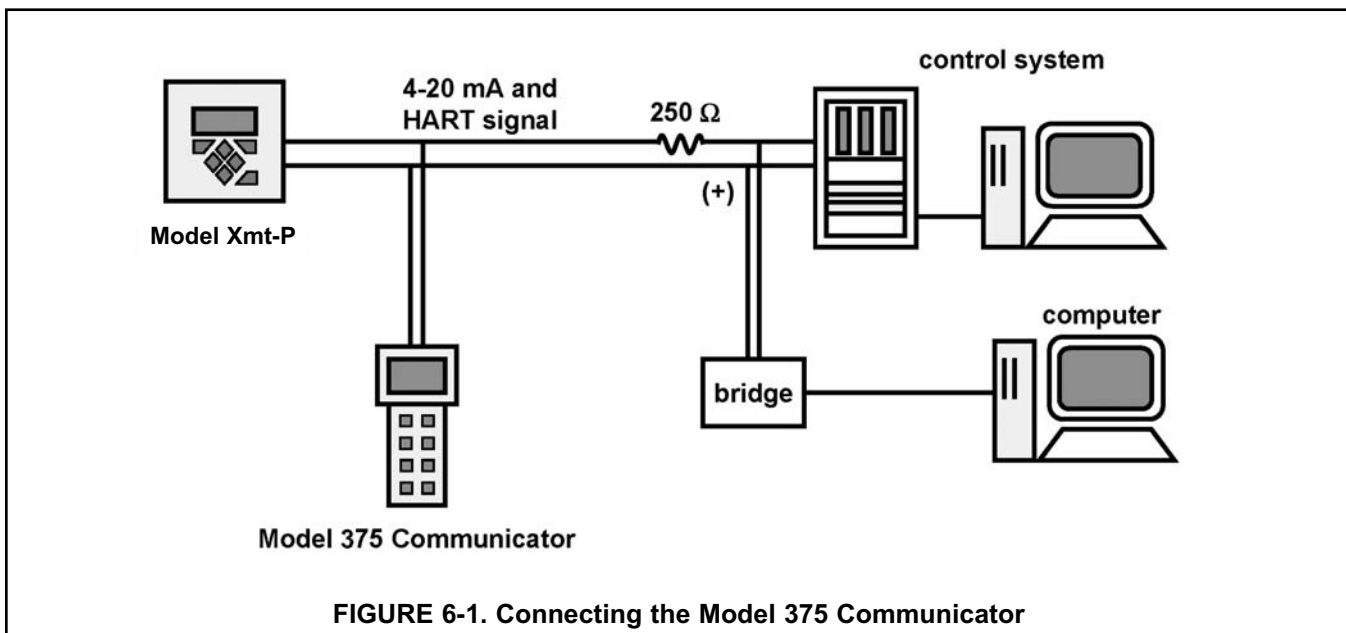
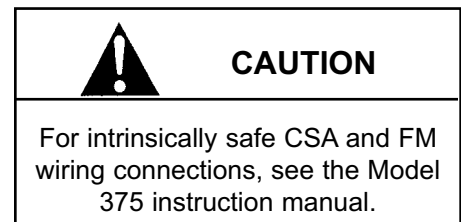

FIGURE 6-1. Connecting the Model 375 Communicator

6.3 Operation

6.3.1 Off-line and On-line Operation

The Model 375 Communicator features off-line and on-line communications. On-line means the communicator is connected to the transmitter in the usual fashion. While the communicator is on line, the operator can view measurement data, change program settings, and read diagnostic messages. Off-line means the communicator is not connected to the transmitter. When the communicator is off line, the operator can still program settings into the communicator. Later, after the communicator has been connected to a transmitter, the operator can transfer the programmed settings to the transmitter. Off-line operation permits settings common to several transmitters to be easily stored in all of them.

6.3.2 Making HART related settings from the keypad

Calibrate	Hold
Program	Display

1. Press MENU. The main menu screen appears. Choose **Program**.

Output	Temp
Measurement	>>

2. Choose >>.

Security	HART
	>>

3. Choose **HART**.

DevID	PollAddr
Burst	Preamble

4. To display the device ID, choose **DevID**. To change the polling address, choose **PollAddr**. To make burst mode settings, choose **Burst**. To change the preamble count, choose **Preamble**.

6.3.3 Menu Tree

The menu trees for the Model 275 and Model 375 HART and Foundation Fieldbus communicators are on the following pages

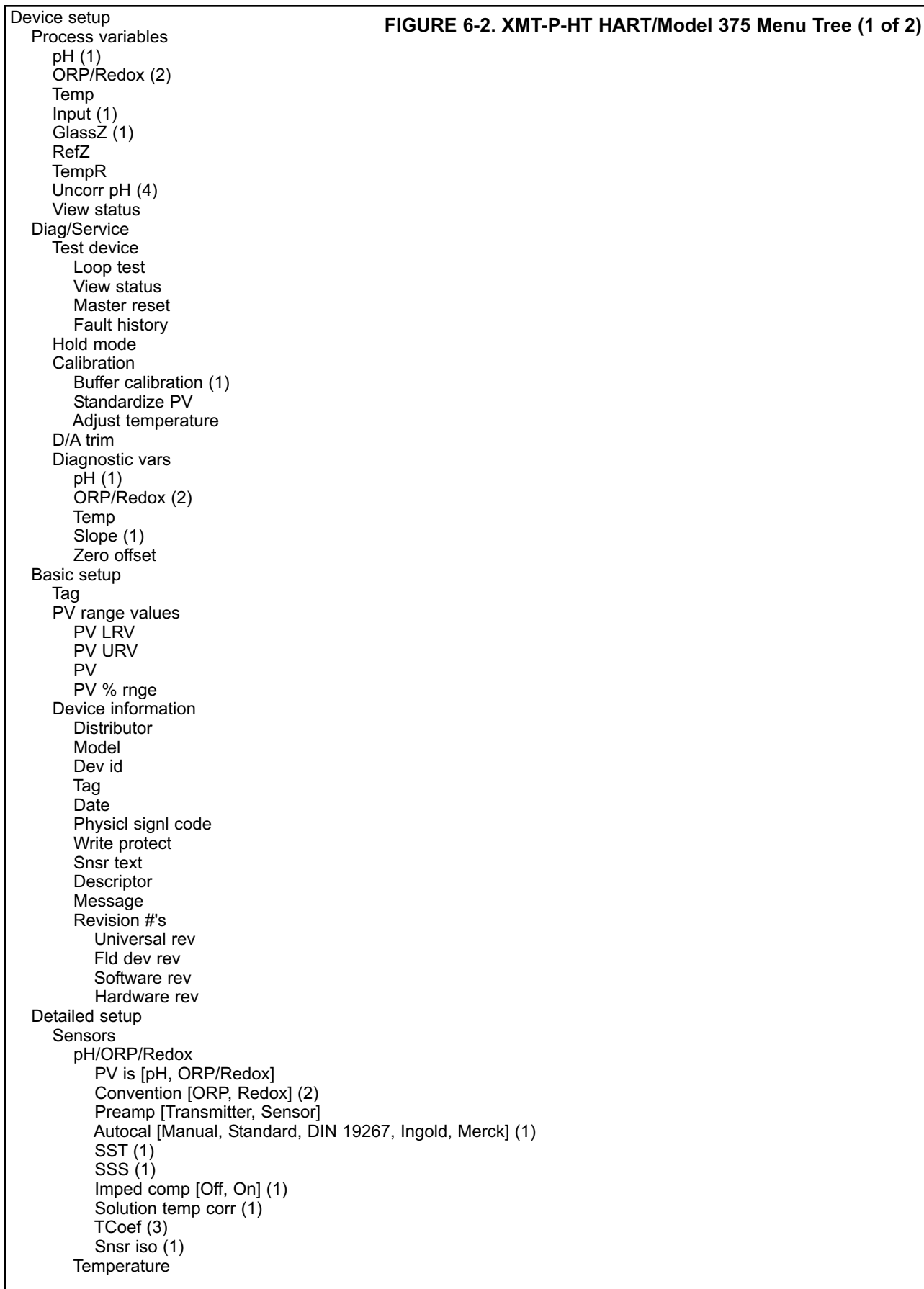

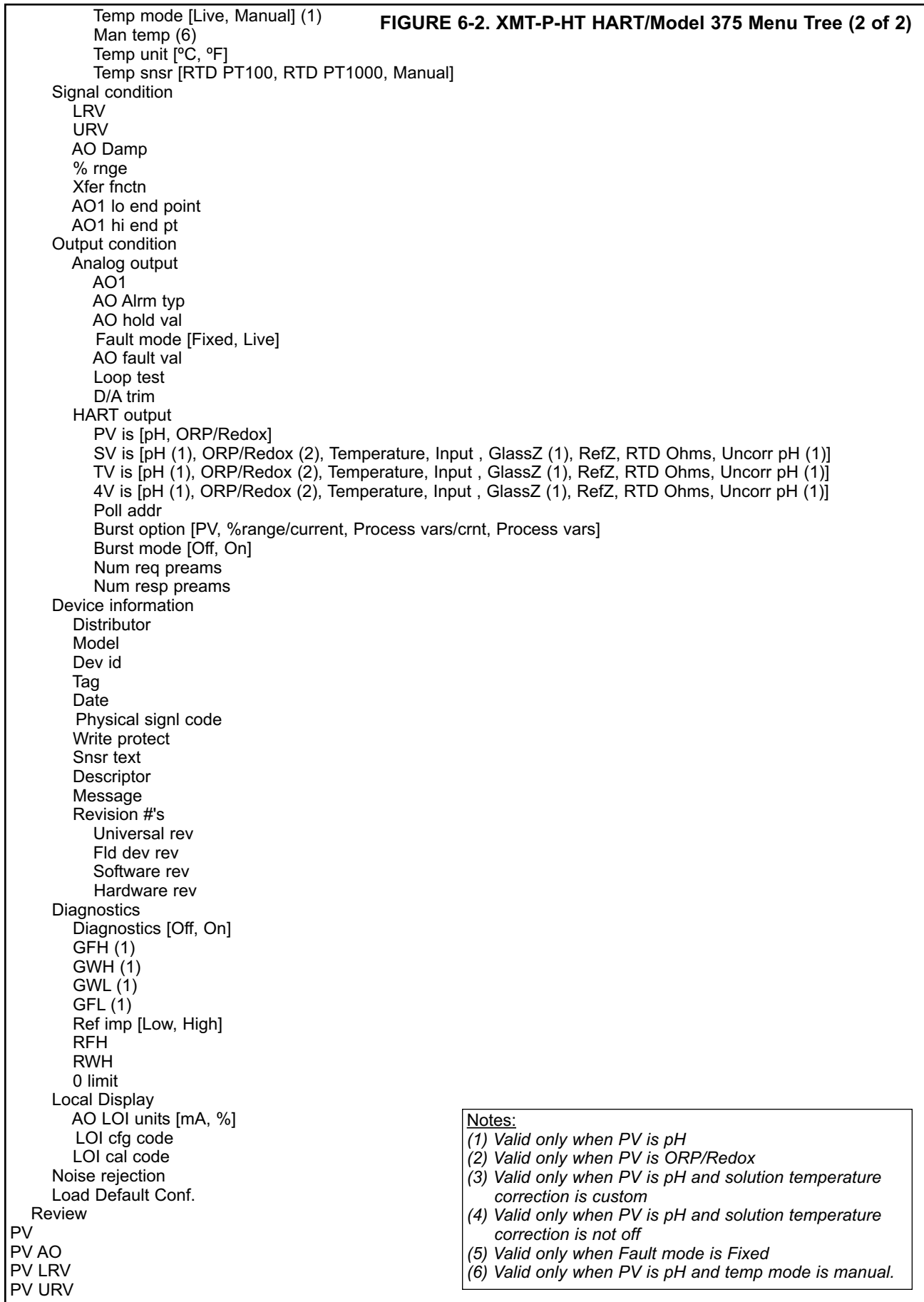

RESOURCE

FIGURE 6-3. XMT-P-FF Foundation Fieldbus/Model 375 Menu Tree (1 of 12)

- Identification
 - MANUFACT_ID
 - DEV_TYPE
 - DEV_REV
 - DD_REV
 - Characteristics Block Tag
 - TAG_DESC
 - Hardware Revision
 - Software Revision String
 - Private Label Distributor
 - Final Assembly Number
 - Output Board Serial Number
 - ITK_VER
- Status
 - BLOCK_ERR
 - RS_STATE
 - FAULT_STATE
 - Summary Status
 - MODE_BLK: Actual
 - MODE_BLK: Target
 - ALARM_SUM: Current
 - ALARM_SUM: Unacknowledged
 - ALARM_SUM: Unreported
 - Detailed Status
 - Plantweb alerts
 - Simulation
- Process
 - MODE_BLK.Actual
 - MODE_BLK.Target
 - MODE_BLK.Permitted
 - STRATEGY
 - Plant unit
 - SHED_RCAS
 - SHED_ROUT
 - GRANT_DENY: Grant
 - GRANT_DENY: Deny
- Alarms
 - WRITE_PRI
 - CONFIRM_TIME
 - LIM_NOTIFY
 - MAX_NOTIFY
 - FAULT_STATE
 - SET_FSTATE [Uninitialized, OFF, SET]
 - CLR_FSTATE [Uninitialized, Off, Clear]
 - ALARM_SUM: Disabled
 - ACK_OPTION
- Hardware
 - MEMORY_SIZE
 - FREE_TIME
 - MIN_CYCLE_T
 - HARD_TYPES
 - NV_CYCLE_T
 - FREE_SPACE
- Options
 - CYCLE_SEL
 - CYCLE_TYPE
 - FEATURE_SEL
 - FEATURES
 - Download Mode
 - WRITE_LOCK
 - Start With Defaults
 - Write Lock Definition
- Methods
 - Master reset
 - Self test
 - DD Version Info

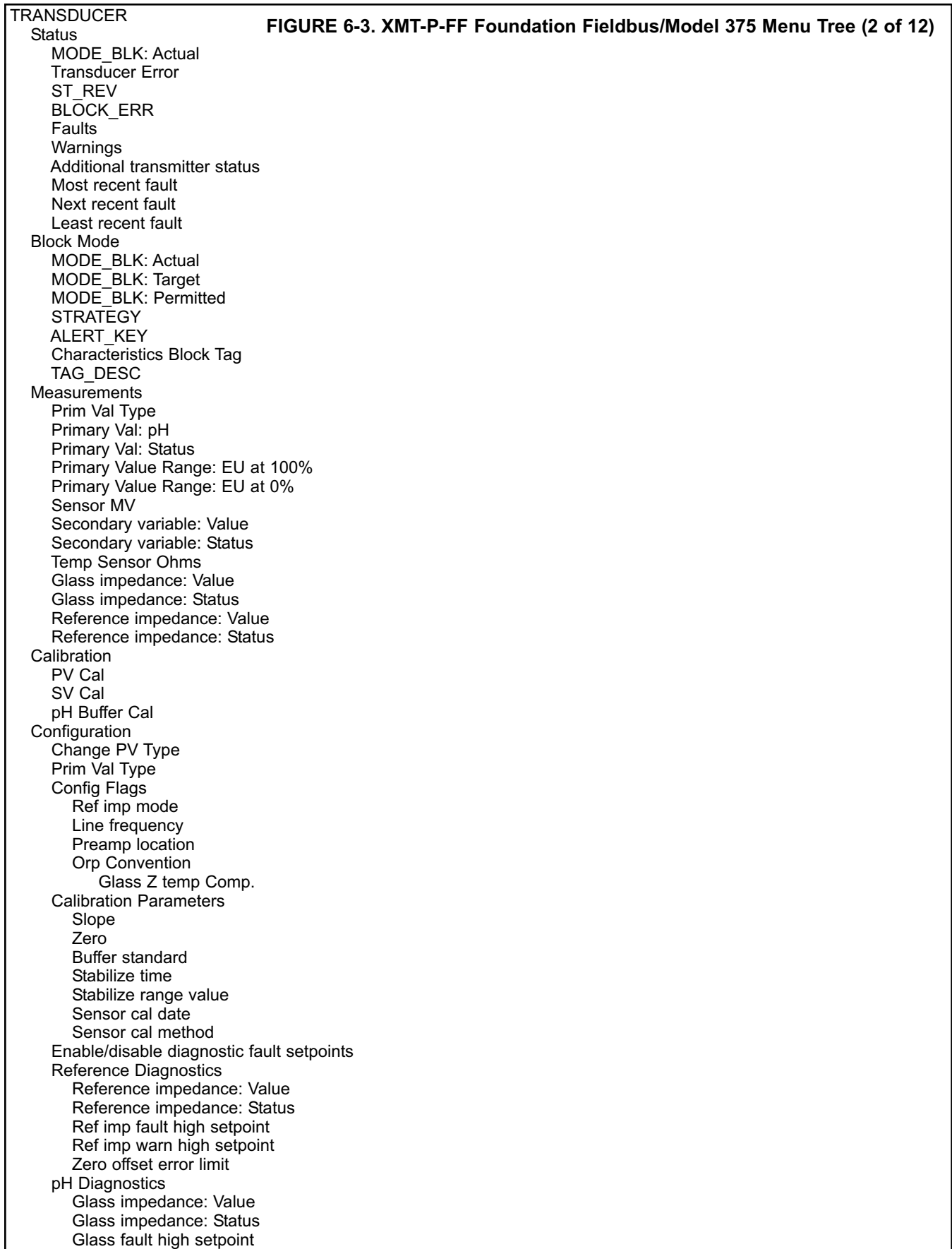

**FIGURE 6-3. XMT-P-FF Foundation Fieldbus/Model 375
Menu Tree (3 of 12)**

- Glass fault low setpoint
- Glass warn high setpoint
- Glass warn low setpoint
- Temperature Compensation
- Secondary value units
- Sensor temp comp
- Sensor temp manual
- Temp Sensor Ohms
- Sensor type temp
- Sensor connection
- Operating isopot ph
- Isopotential pH
- Temperature coeff
- Reset transducer/Load factory defaults
- Identification
 - Software version
 - Hardware version
 - LOI config code
 - LOI calibration code
 - Sensor S/N
 - Final assembly number
- SIMULATION
 - PV Simulate value
 - PV Simulation
 - Faults
 - Warnings
 - Additional Transmitter Status
- AI1
- AI2
- AI3
- AI4
- Quick Config
 - AI Channel
 - L_TYPE
 - XD_SCALE: EU at 100%
 - XD_SCALE: EU at 0%
 - XD_SCALE: Units Index
 - XD_SCALE: Decimal
 - OUT_SCALE: EU at 100%
 - OUT_SCALE: EU at 0%
 - OUT_SCALE: Units Index
 - OUT_SCALE: Decimal
- Common Config
 - ACK_OPTION
 - ALARM_HYS
 - ALERT_KEY
 - HI_HI_LIM
 - HI_HI_PRI
 - HI_LIM
 - HI_PRI
 - IO_OPTS
 - L_TYPE
 - LO_LO_LIM
 - LO_LO_PRI
 - LO_LIM
 - LO_PRI
 - MODE_BLK: Target
 - MODE_BLK: Actual
 - MODE_BLK: Permitted
 - MODE_BLK: Normal
 - OUT_SCALE: EU at 100%
 - OUT_SCALE: EU at 0%
 - OUT_SCALE: Units Index
 - OUT_SCALE: Decimal
 - PV_FTIME
- Advanced Config

**FIGURE 6-3. XMT-P-FF Foundation Fieldbus/Model 375
Menu Tree (4 of 12)**

LOW_CUT
 SIMULATE: Simulate Status
 SIMULATE: Simulate Value
 SIMULATE: Transducer Status
 SIMULATE: Transducer Value
 SIMULATE: Simulate En/Disable
 ST_REV
 STATUS_OPTS
 STRATEGY
 XD_SCALE: EU at 100%
 XD_SCALE: EU at 0%
 XD_SCALE: Units Index
 XD_SCALE: Decimal
 I/O References
 AI Channel
 Connectors
 Out: Status
 Out: Value
 Online
 BLOCK_ERR
 FIELD_VAL: Status
 FIELD_VAL: Value
 MODE_BLK: Target
 MODE_BLK: Actual
 MODE_BLK: Permitted
 MODE_BLK: Normal
 Out: Status
 Out: Value
 PV: Status
 PV: Value
 Status
 BLOCK_ERR
 Other
 TAG_DESC
 GRANT_DENY: Grant
 GRANT_DENY: Deny
 UPDATE_EVT: Unacknowledged
 UPDATE_EVT: Update State
 UPDATE_EVT: Time Stamp
 UPDATE_EVT: Static Rev
 BLOCK_ALM: Unacknowledged
 BLOCK_ALM: Alarm State
 All
 Characteristics: Block Tag
 ST_REV
 TAG_DESC
 STRATEGY
 ALERT_KEY
 MODE_BLK: Target
 MODE_BLK: Actual
 MODE_BLK: Permitted
 MODE_BLK: Normal
 BLOCK_ERR
 PV: Status
 PV: Value
 Out: Status
 Out: Value
 SIMULATE: Simulate Status
 SIMULATE: Simulate Value
 SIMULATE: Transducer Status
 SIMULATE: Transducer Value
 SIMULATE: Simulate En/Disable
 XD_SCALE: EU at 100%
 XD_SCALE: EU at 0%
 XD_SCALE: Units Index
 XD_SCALE: Decimal

**FIGURE 6-3. XMT-P-FF Foundation Fieldbus/Model 375
Menu Tree (5 of 12)**

OUT_SCALE: EU at 100%
 OUT_SCALE: EU at 0%
 OUT_SCALE: Units Index
 OUT_SCALE: Decimal
 GRANT_DENY: Grant
 GRANT_DENY: Deny
 IO_OPTS
 STATUS_OPTS
 AI Channel
 LOW_CUT
 PV_FTIME
 FIELD_VAL: Status
 FIELD_VAL: Value
 UPDATE_EVT: Unacknowledged
 UPDATE_EVT: Update State
 UPDATE_EVT: Time Stamp
 UPDATE_EVT: Static Rev
 UPDATE_EVT: Relative Index
 BLOCK_ALM: Unacknowledged
 BLOCK_ALM: Alarm State
 BLOCK_ALM: Time Stamp
 BLOCK_ALM: Subcode
 BLOCK_ALM: Value
 ALARM_SUM: Unacknowledged
 ALARM_SUM: Unreported
 ALARM_SUM: Disabled
 ACK_OPTION
 ALARM_HYS
 HI_HI_PRI
 HI_HI_LIM
 HI_PRI
 HI_LIM
 LO_PRI
 LO_LIM
 LO_LO_PRI
 LO_LO_LIM
 HI_HI_ALM: Unacknowledged
 HI_HI_ALM: Alarm State
 HI_HI_ALM: Time Stamp
 HI_HI_ALM: Subcode
 HI_HI_ALM: Value
 HI_ALM: Unacknowledged
 HI_ALM: Alarm State
 HI_ALM: Time Stamp
 HI_ALM: Subcode
 HI_ALM: Float Value
 LO_ALM: Unacknowledged
 LO_ALM: Alarm State
 LO_ALM: Time Stamp
 LO_ALM: Subcode
 LO_ALM: Float Value
 LO_LO_ALM: Unacknowledged
 LO_LO_ALM: Alarm State
 LO_LO_ALM: Time Stamp
 LO_LO_ALM: Subcode
 LO_LO_ALM: Float Value
 Alarm output: Status
 Alarm output: Value
 Alarm select
 StdDev
 Cap StdDev
 PID1
 Quick Config
 ALERT_KEY
 CONTROL_OP
 DV_HI_LIM

DV_LO_LIM
 GAIN
 HI_HI_LIM
 HI_LIM
 LO_LIM
 LO_LO_LIM
 OUT_SCALE: EU at 100%
 OUT_SCALE: EU at 0%
 OUT_SCALE: Units Index
 OUT_SCALE: Decimal
 PV_SCALE: EU at 100%
 PV_SCALE: EU at 0%
 PV_SCALE: Units Index
 PV_SCALE: Decimal
 RESET
 SP: Status
 SP: Value
 SP_HI_LIM
 SP_LO_LIM
 Common Config
 ALARM_HYS
 ALERT_KEY
 CONTROL_OPTS
 DV_HI_LIM
 DV_LO_LIM
 GAIN
 HI_HI_LIM
 HI_LIM
 LO_LIM
 LO_LO_LIM
 MODE_BLK: Target
 MODE_BLK: Actual
 MODE_BLK: Permitted
 MODE_BLK: Normal
 OUT_HI_LIM
 OUT_LO_LIM
 OUT_SCALE: EU at 100%
 OUT_SCALE: EU at 0%
 OUT_SCALE: Units Index
 OUT_SCALE: Decimal
 PV_FTIME
 PV_SCALE: EU at 100%
 PV_SCALE: EU at 0%
 PV_SCALE: Units Index
 PV_SCALE: Decimal
 RATE
 RESET
 SP: Status
 SP: Value
 SP_HI_LIM
 SP_LO_LIM
 Advanced Config
 BK_CAL_HYS
 FF_GAIN
 FF_SCALE: EU at 100%
 FF_SCALE: EU at 0%
 FF_SCALE: Units Index
 FF_SCALE: Decimal
 SHED_OPT
 SP_RATE_DN
 SP_RATE_UP
 ST_REV
 STATUS_OPTS
 STRATEGY
 TRK_SCALE: EU at 100%
 TRK_SCALE: EU at 0%

FIGURE 6-3. XMT-P-FF Foundation Fieldbus/Model 375 Menu Tree (6 of 12)

TRK_SCALE: Units Index
 TRK_SCALE: Decimal
 TRK_VAL: Status
 TRK_VAL: Value
 Connectors
 BK_CAL_IN: Status
 BK_CAL_IN: Value
 BK_CAL_OUT: Status
 BK_CAL_OUT: Value
 CAS_IN: Status
 CAS_IN: Value
 FF_VAL: Status
 FF_VAL: Value
 IN: Status
 IN: Value
 OUT: Status
 OUT: Value
 TRK_IN_D: Status
 TRK_IN_D: Value
 TRK_VAL: Status
 TRK_VAL: Value
 Online
 BK_CAL_IN: Status
 BK_CAL_IN: Value
 BK_CAL_OUT: Status
 BK_CAL_OUT: Value
 BLOCK_ERR
 BYPASS
 CAS_IN: Status
 CAS_IN: Value
 FF_VAL: Status
 FF_VAL: Value
 GAIN
 IN: Status
 IN: Value
 MODE_BLK: Target
 MODE_BLK: Actual
 MODE_BLK: Permitted
 MODE_BLK: Normal
 OUT: Status
 OUT: Value
 PV: Status
 PV: Value
 RCAS_IN: Status
 RCAS_IN: Value
 RCAS_OUT: Status
 RCAS_OUT: Value
 ROUT_IN: Status
 ROUT_IN: Value
 ROUT_OUT: Status
 ROUT_OUT: Value
 SP: Status
 SP: Value
 TRK_IN_D: Status
 TRK_IN_D: Value
 TRK_VAL: Status
 TRK_VAL: Value
 Status
 BLOCK_ERR
 Other
 TAG_DESC
 BAL_TIME
 GRANT_DENY: Grant
 GRANT_DENY: Deny
 UPDATE_EVT: Unacknowledged
 UPDATE_EVT: Update State

FIGURE 6-3. XMT-P-FF Foundation Fieldbus/Model 375 Menu Tree (7 of 12)

**FIGURE 6-3. XMT-P-FF Foundation Fieldbus/Model 375
Menu Tree (8 of 12)**

UPDATE_EVT: Time Stamp
 UPDATE_EVT: Static Rev
 UPDATE_EVT: Relative Index
 BLOCK_ALM: Unacknowledged
 BLOCK_ALM: Alarm State
 BLOCK_ALM: Time Stamp
 BLOCK_ALM: Subcode
 BLOCK_ALM: Value
 ALARM_SUM: Current
 ALARM_SUM: Unacknowledged
 ALARM_SUM: Unreported
 ALARM_SUM: Disabled
 ACK_OPTION
 HI_HI_ALM: Unacknowledged
 HI_HI_ALM: Alarm State
 HI_HI_ALM: Time Stamp
 HI_HI_ALM: Subcode
 HI_HI_ALM: Float Value
 HI_ALM: Unacknowledged
 HI_ALM: Alarm State
 HI_ALM: Time Stamp
 HI_ALM: Subcode
 HI_ALM: Float Value
 LO_ALM: Unacknowledged
 LO_ALM: Alarm State
 LO_ALM: Time Stamp
 LO_ALM: Subcode
 LO_ALM: Float Value
 LO_LO_ALM: Unacknowledged
 LO_LO_ALM: Alarm State
 LO_LO_ALM: Time Stamp
 LO_LO_ALM: Subcode
 LO_LO_ALM: Float Value
 DV_HI_ALM: Unacknowledged
 DV_HI_ALM: Alarm State
 DV_HI_ALM: Time Stamp
 DV_HI_ALM: Subcode
 DV_HI_ALM: Float Value
 DV_LO_ALM: Unacknowledged
 DV_LO_ALM: Alarm State
 DV_LO_ALM: Time Stamp
 DV_LO_ALM: Subcode
 DV_LO_ALM: Float Value
 Bias
 Error
 SP Work
 SP FTime
 mathform
 structreconfig
 UGamma
 UBeta
 IDeadBand
 StdDev
 Cap StdDev
 All
 Characteristics: Block Tag
 ST_REV
 TAG_DESC
 STRATEGY
 ALERT_KEY
 MODE_BLK: Target
 MODE_BLK: Actual
 MODE_BLK: Permitted
 MODE_BLK: Normal
 BLOCK_ERR
 PV: Status

FIGURE 6-3. XMT-P-FF Foundation Fieldbus/Model 375 Menu Tree (9 of 12)

PV: Value
 SP: Status
 SP: Value
 OUT: Status
 OUT: Value
 PV_SCALE: EU at 100%
 PV_SCALE: EU at 0%
 PV_SCALE: Units Index
 PV_SCALE: Decimal
 OUT_SCALE: EU at 100%
 OUT_SCALE: EU at 0%
 OUT_SCALE: Units Index
 OUT_SCALE: Decimal
 GRANT_DENY: Grant
 GRANT_DENY: Deny
 CONTROL_OPTS
 STATUS_OPTS
 IN: Status
 IN: Value
 PV_FTIME
 BYPASS
 CAS_IN: Status
 CAS_IN: Value
 SP_RATE_DN
 SP_RATE_UP
 SP_HI_LIM
 SP_LO_LIM
 GAIN
 RESET
 BAL_TIME
 RATE
 BK_CAL_IN: Status
 BK_CAL_IN: Value
 OUT_HI_LIM
 OUT_LO_LIM
 BKCAL_HYS
 BK_CAL_OUT: Status
 BK_CAL_OUT: Value
 RCAS_IN: Status
 RCAS_IN: Value
 ROUT_IN: Status
 ROUT_IN: Value
 SHED_OPT
 RCAS_OUT: Status
 RCAS_OUT: Value
 ROUT_OUT: Status
 ROUT_OUT: Value
 TRK_SCALE: EU at 100%
 TRK_SCALE: EU at 0%
 TRK_SCALE: Units Index
 TRK_SCALE: Decimal
 TRK_IN_D: Status
 TRK_IN_D: Value
 TRK_VAL: Status
 TRK_VAL: Value
 FF_VAL: Status
 FF_VAL: Value
 FF_SCALE: EU at 100%
 FF_SCALE: EU at 0%
 FF_SCALE: Units Index
 FF_SCALE: Decimal
 FF_GAIN
 UPDATE_EVT: Unacknowledged
 UPDATE_EVT: Update State
 UPDATE_EVT: Time Stamp
 UPDATE_EVT: Static Rev

**FIGURE 6-3. XMT-P-FF Foundation Fieldbus/Model 375
Menu Tree (10 of 12)**

UPDATE_EVT: Relative Index
 BLOCK_ALM: Unacknowledged
 BLOCK_ALM: Alarm State
 BLOCK_ALM: Time Stamp
 BLOCK_ALM: Sub Code
 BLOCK_ALM: Value
 ALARM_SUM: Current
 ALARM_SUM: Unacknowledged
 ALARM_SUM: Unreported
 ALARM_SUM: Disabled
 ACK_OPTION
 ALARM_HYS
 HI_HI_PRI
 HI_HI_LIM
 HI_PRI
 HI_LIM
 LO_PRI
 LO_LIM
 LO_LO_PRI
 LO_LO_LIM
 DV_HI_PRI
 DV_HI_LIM
 DV_LO_PRI
 DV_LO_LIM
 HI_HI_ALM: Unacknowledged
 HI_HI_ALM: Alarm State
 HI_HI_ALM: Time Stamp
 HI_HI_ALM: Subcode
 HI_HI_ALM: Float Value
 HI_ALM: Unacknowledged
 HI_ALM: Alarm State
 HI_ALM: Time Stamp
 HI_ALM: Subcode
 HI_ALM: Float Value
 LO_ALM: Unacknowledged
 LO_ALM: Alarm State
 LO_ALM: Time Stamp
 LO_ALM: Subcode
 LO_ALM: Float Value
 LO_LO_ALM: Unacknowledged
 LO_LO_ALM: Alarm State
 LO_LO_ALM: Time Stamp
 LO_LO_ALM: Subcode
 LO_LO_ALM: Float Value
 DV_HI_ALM: Unacknowledged
 DV_HI_ALM: Alarm State
 DV_HI_ALM: Time Stamp
 DV_HI_ALM: Subcode
 DV_HI_ALM: Float Value
 DV_LO_ALM: Unacknowledged
 DV_LO_ALM: Alarm State
 DV_LO_ALM: Time Stamp
 DV_LO_ALM: Subcode
 DV_LO_ALM: Float Value
 Bias
 Error
 SP Work
 SP FTime
 mathform
 structreconfig
 UGamma
 UBeta
 IDeadBand
 StdDev
 Cap StdDev

Scheduling	FIGURE 6-3. XMT-P-FF Foundation Fieldbus/Model 375 Menu Tree (11 of 12)
Detail	
Physical Device Tag	
Address	
Device ID	
Device Revision	
Advanced	
Stack Capabilities	
FasArTypeAndRoleSupported	
MaxDisapAddressesSupported	
MaxDlcepAddressesSupported	
DlcepDeliveryFeaturesSupported	
VersionOfNmSpecSupported	
AgentFunctionsSupported	
FmsFeaturesSupported	
Basic Characteristics	
Version	
BasicStatisticsSupportedFlag	
DIOperatFunctionalClass	
DIDeviceConformance	
Basic Info	
SlotTime	
PerDlPduPhIOverhead	
MaxResponseDelay	
ThisNode	
ThisLink	
MinInterPduDelay	
TimeSyncClass	
PreambleExtension	
PostTransGapExtension	
MaxInterChanSignalSkew	
Basic Statistics	
Not Supported!	
Finch Statistics 1	
Last Crash Description	
Last RestartReason	
Finch Rec Errors	
Finch FCS Errors	
Finch Rec Ready Errors	
Finch Rec FIFO Overrun Errors	
Finch Rec FIFO Underrun Errors	
Finch Trans FIFO Overrun Errors	
Finch Trans FIFO Underrun Errors	
Finch Count Errors	
Finch CD Errors	
Cold Start Counts	
Software Crash Counts	
Spurious Vector Counts	
Bus/Address Error Counts	
Program Exit Counts	
Finch Statistics 2	
Scheduled Events	
Missed Events	
Max Time Error	
MID Violations	
Schedule Resync	
Token Delegation Violations	
Sum Of All Time Adjustments	
Time Adjustments	
Time Updates Outside of K	
Discontinuous Time Updates	
Queue Overflow Statistics 1	
Time Available	
Normal	
Urgent	
Time Available Rcv	

**FIGURE 6-3. XMT-P-FF Foundation
Fieldbus/Model 375 Menu Tree (12 of 12)**

Normal Rcv
 Urgent Rcv
 Time Available SAP EC DC
 Normal SAP EC DC
 Urgent SAP EC DC
 Time Available Rcv SAP EC DC
 Normal Rcv SAP EC DC
 Urgent Rcv SAP EC DC
 Queue Overflow Statistics 2
 Time Available SAP SM
 Time Available Rcv SAP SM
 Normal SAP Las
 Normal Rcv SAP Las
 Time Available SAP Src Sink
 Normal SAP Src Sink
 Urgent SAP Src Sink
 Time Available Rcv SAP Src Sink
 Normal Rcv SAP Src Sink
 Urgent Rcv SAP Src Sink
 Sys Q
 Link Master Parameters
 DImeLinkMasterCapabilitiesVariable
 PrimaryLinkMasterFlagVariable
 BootOperatFunctionalClass
 NumLasRoleDeleg/Claim/DelegTokenHoldTimeout
 Link Master Info
 MaxSchedulingOverhead
 DefMinTokenDelegTime
 DefTokenHoldTime
 TargetTokenRotTime
 LinkMaintTokHoldTime
 TimeDistributionPeriod
 MaximumInactivityToClaimLasDelay
 LasDatabaseStatusSpduDistributionPeriod
 Current Link Settings
 SlotTime
 PerDlpduPhIOverhead
 MaxResponseDelay
 FirstUnpolledNodeId
 ThisLink
 MinInterPduDelay
 NumConsecUnpolledNodeId
 PreambleExtension
 PostTransGapExtension
 MaxInterChanSignalSkew
 TimeSyncClass
 Configured Link Settings
 SlotTime
 PerDlpduPhIOverhead
 MaxResponseDelay
 FirstUnpolledNodeId
 ThisLink
 MinInterPduDelay
 NumConsecUnpolledNodeId
 PreambleExtension
 PostTransGapExtension
 MaxInterChanSignalSkew
 TimeSyncClass

SECTION 7.0

PROGRAMMING THE TRANSMITTER

7.1 GENERAL

This section describes how to program the transmitter using the keypad.

1. Configure and assign values to the 4-20 mA output (-HT version only).
2. Test and trim the current output (-HT version only).
3. Select the measurement to be made (pH, ORP, or Redox).
4. Choose temperature units and automatic or manual temperature mode.
5. Set a security code.
6. Make certain settings relating to HART communication (-HT version only).
7. Program the transmitter for maximum reduction of environmental noise.
8. Resetting factory default settings.
9. Selecting a default display screen and adjusting screen contrast.

7.2 CHANGING START-UP SETTINGS

When the Solu Comp Xmt is powered up for the first time, startup screens appear. The screens prompt the user to enter the measurement being made, to identify the sensor being used, to select automatic or manual pH correction and to select temperature units. If incorrect settings were entered at startup, enter the correct settings now. To change the measurement, refer to Section 7.4.

7.3 CONFIGURING AND RANGING THE OUTPUT (-HT version only)

7.3.1 Purpose

1. Configuring an output means
 - a. displaying the output reading in units of mA or percent of full scale.
 - b. changing the time constant for output dampening.
 - c. assigning the value the output current will take if the transmitter detects a fault in itself or the sensor.
2. Ranging the output means assigning values to the 4 mA and 20 mA outputs.
3. Testing an output means entering a test value from the keypad to check the operation of recorders or controllers.
4. Trimming an output means calibrating the 4 and 20 mA current outputs against a referee milliammeter.

7.3.2 Definitions

1. CURRENT OUTPUT. The transmitter provides a continuous 4-20 mA output current directly proportional to the pH of the sample.
2. FAULT. The transmitter continuously monitors itself and the sensor for faults. If the transmitter detects a fault, the 4-20 mA output can be programmed to go to a fixed value or it can be programmed to continue to display the live current reading. In any event Fault appears intermittently in the second line of the display.
3. DAMPEN. Output dampening smoothes out noisy readings. But it also increases the response time of the output. To estimate the time (in minutes) required for the output to reach 95% of the final reading following a step change, divide the setting by 20. Thus, a setting of 140 means that, following a step change, the output takes about seven minutes to reach 95% of final reading. The output dampen setting does not affect the response time of the process display. The maximum setting is 255.
4. TEST. The transmitter can be programmed to generate a test current.

7.3.3 Procedure: Configuring the Output

Calibrate	Hold
Program	Display

1. Press MENU. The menu screen appears. Choose **Program**.

Output	Temp
Measurement	>>

2. Choose **Output**.

Output?	Test
Configure	Range

3. Choose **Configure**.

Configure?	Fault
mA/%	Damping

4. Choose **Fault**.

Set to value?	
Fixed	Live

5. Choose **Fixed** or **Live**.

Current Output	
if Fault:	22.00mA

6. If you chose **Fixed**, the screen at left appears. Use the arrow keys to change the fault current to the desired value. The limits are 4.00 to 22.00 mA. If you chose **Live**, there are no settings to make.

Configure?	Fault
mA/%	Damping

7. The screen at left appears. Choose **mA/%**.

Display Output?	
mA	percent

8. Choose **mA** or **percent**. Percent means the display will show percent of full scale reading.

Configure?	Fault
mA/%	Damping

9. The screen at left appears. Choose **Damping**.

Damping?	000 255
	000 sec

10. Use the arrow keys to change the blinking display to the desired time constant.

7.3.4 Procedure: Ranging the output

Calibrate	Hold
Program	Display

1. Press MENU. The menu screen appears. Choose **Program**.

Output	Temp
Measurement	>>

2. Choose **Output**.

Output?	Test
Configure	Range

3. Choose **Range**.

Output range?	
4mA	0.000PPM

4. Assign a value to the 4 mA output and press ENTER. Then assign a value to the 20 mA output. Press ENTER. Use the arrow keys to change the flashing display to the desired value.

7.3.5 Procedure: Testing the output

Calibrate	Hold
Program	Display

1. Press MENU. The menu screen appears. Choose **Program**.

Output	Temp
Measurement	>>

2. Choose **Output**.

Output?	Test
Configure	Range

3. Choose **Test**.

Test Output
Trim Output

4. Choose **Test Output**.

Current Output
for Test: 12.00mA

5. Use the arrow keys to change the displayed current to the desired value. Press ENTER. The output will change to the value just entered.

6. To return to normal operation, press EXIT. The output will return to the value determined by the process variable.

7. To return to the main display, press MENU then EXIT.

7.3.6 Procedure: Trimming the output

1. Connect an accurate milliammeter in series with the current output.

Calibrate	Hold
Program	Display

2. Press MENU. The menu screen appears. Choose **Program**.

Output	Temp
Measurement	>>

3. Choose **Output**.

Output?	Test
Configure	Range

4. Choose **Test**.

Test Output
Trim Output

5. Choose **Trim Output**.

Meter reading:
04.00mA

6. The output goes to 4.00 mA. If the milliammeter does not read 4.00 mA, use the arrow keys to change the display to match the current measured by the milliammeter.

Meter reading:
20.00mA

7. The output goes to 20.00 mA. If the milliammeter does not read 20.00 mA, use the arrow keys to change the display to match the current measured by the milliammeter.

Trim Complete

8. To return to the main display, press MENU then EXIT.

7.4 CHOOSING AND CONFIGURING THE ANALYTICAL MEASUREMENT

7.4.1 Purpose

This section describes how to do the following:

1. Configure the transmitter to measure pH, ORP, or Redox.
2. Determine the location of the preamp.
3. If pH was selected, there are additional selections and settings to make:
 - a. choose a solution temperature correction curve or set a temperature coefficient constant
 - b. choose sensor isopotential
 - c. set reference impedance low or high
6. If total chlorine was selected, single or dual slope calibration must also be specified.

7.4.2 Definitions

1. MEASUREMENT. The transmitter can be configured to measure pH, ORP or Redox (opposite sign of ORP).
2. pH SETTINGS. If pH is selected, there are additional settings to make.
 - a. PREAMPLIFIER. The raw pH signal is a high impedance voltage. A voltage follower or preamplifier, located either in the sensor or transmitter, converts the high impedance signal into a low impedance one. Normally, high impedance signals should be sent no further than about 15 feet.
 - b. REFERENCE OFFSET. Ideally, a pH sensor in pH 7 buffer should have a voltage of 0 mV. The difference between the measured voltage in pH 7 buffer and the ideal value is the reference offset. Typically, the reference offset is less than 60 mV.
 - c. DIAGNOSTICS. The Solu Comp Xmt continuously monitors the pH sensor for faults. If it detects a fault, the transmitter displays a fault message.
 - d. GLASS IMPEDANCE. The transmitter monitors the condition of the pH-sensitive glass membrane in the sensor by continuously measuring the impedance across the membrane. Typical impedance is between 100 and 500 M Ω . Low impedance (<10 M Ω) implies the glass bulb has cracked and the sensor must be replaced. An extremely high impedance (>1000 M Ω) implies the sensor is aging and may soon need replacement. High impedance might also mean that the glass membrane is no longer immersed in the process liquid.
3. INPUT FILTER. The raw sensor current can be filtered to reduce noise. Filtering also increases the response time. The filter is the time required for the input to reach 63% of its final reading following a step change.

7.4.3 Procedure: Measurement.

To choose a menu item, move the cursor to the item and press ENTER.
To store a number or setting, press ENTER.

Calibrate	Hold
Program	Display

Outputs	TEMP
Measurement	>>

Measure?	pH
Redox	ORP

Use Preamp in?	
Xmtr	Sensor/JBox

Soln Temp Corr	
Sensor Isoptntl	

SolnTempCorr?	
Off	Ultrapure >>

Sensor Isoptntl	
S1:	07.00pH

Reference imped	
Low/High	>>

Reference imped?	
Low	High

1. Press MENU. The main menu screen appears. Choose **Program**.
2. Choose **Measurement**.
3. Choose **pH, Redox, or ORP**.
If you chose **pH**, do steps 5 through 9.
If you chose **ORP** or **Redox**, do step 10.
4. Enter the correct preamplifier location. The default setting is within the transmitter.
5. Choose **Soln Temp Corr** or **Sensor Isoptntl**.
6. For **Soln Temp Corr**, choose **Off, UltraPure, HighpH, or Custom**. For **Custom**, enter the desired temperature coefficient.
7. For **Sensor Isoptntl**, enter the desired sensor isopotential pH. Do not change the sensor isopotential pH unless the sensor is known to have an isopotential pH different from 7.00.
8. Choose Low or High Reference Impedance to match the installed sensor's reference impedance signal. The default setting is Low Impedance to match standard pH sensors. Press EXIT twice to return to the Program menu.
9. If **Redox** or **ORP** was selected, there are no further settings to make. Press EXIT to return to the Program menu..
10. To return to the main display, press MENU followed by EXIT.

7.5 CHOOSING TEMPERATURE UNITS AND MANUAL OR AUTOMATIC TEMPERATURE COMPENSATION

7.5.1 Purpose

This section describes how to do the following:

1. Choose temperature display units (°C or °F).
2. Choose automatic or manual temperature compensation.
3. Enter a temperature for manual temperature compensation

7.5.2 Definitions

1. **AUTOMATIC TEMPERATURE COMPENSATION.** The analyzer uses a temperature-dependent factor to convert measured cell voltage to pH. In automatic temperature compensation, the analyzer measures the temperature and automatically calculates the correct conversion factor. For maximum accuracy, use automatic temperature compensation.
2. **MANUAL TEMPERATURE COMPENSATION.** In manual temperature compensation, the analyzer converts measured voltage to pH using the temperature entered by the user. It does not use the actual process temperature. Do **NOT** use manual temperature compensation unless the process temperature varies no more than about $\pm 2^{\circ}\text{C}$ or the pH is between 6 and 8. Manual temperature compensation is useful if the sensor temperature element has failed and a replacement sensor is not available. If manual temperature correction is selected, the display will not show the measured temperature. It will show the manually entered value.

7.5.3 Procedure: Temperature.

To choose a menu item, move the cursor to the item and press ENTER.

To store a number or setting, press ENTER.

Calibrate	Hold
Program	Display

Outputs	Temp
Measurement	>>

Config Temp?	
°C/F	Live/Manual

1. Press MENU. The main menu screen appears. Choose **Program**.
2. Choose **Temp**.
3. Choose **°C/F** to change temperature units. Choose **Live/Manual** to turn on (Live) or turn off (Manual) automatic temperature compensation.
 - a. If **°C/F** is chosen, select **°C** or **°F** in the next screen.
 - b. If **Live/Manual** is chosen, select **Live** or **Manual** in the next screen.
 - c. If **Manual** is chosen, enter the temperature in the next screen. The temperature entered in this step will be used in all subsequent measurements, no matter what the process temperature is.

7.6 SETTING A SECURITY CODE

7.6.1 Purpose

This section describes how to set a security code. There are three levels of security:

- a. A user can view the default display and information screens only.
- b. A user has access to the calibration and hold menus only.
- c. A user has access to all menus.

The security code is a three-digit number. The table shows what happens when security codes are assigned to **Calib** (calibration) and **Config** (configure). In the table XXX and YYY are the assigned security codes. To bypass security, enter 555.

Code assignments		What happens
Calib	Config	
000	XXX	User enters XXX and has access to all menus.
XXX	YYY	User enters XXX and has access to calibration and hold menus only. User enters YYY and has access to all menus.
XXX	000	User needs no security code to have access to all menus.
000	000	User needs no security code to have access to all menus.

7.6.2 Procedure: Setting a security code

Calibrate	Hold
Program	Display

Outputs	Temp
Measurement	>>

Security	HART
	>>

Lock?	
Calib	Config

1. Press MENU. The menu screen appears. Choose **Program**.
2. Choose >>.
3. Choose **Security**.
4. Choose **Calib** or **Config**.
 - a. If you chose **Calib**, enter a three-digit security code.
 - b. If you chose **Config**, enter a three-digit security code.
5. To return to the main display, press MENU the EXIT.

7.7 MAKING HART RELATED SETTINGS

For more information refer to Section 6.0.

7.8 NOISE REDUCTION

7.8.1 Purpose

For maximum noise reduction, the frequency of the ambient AC power must be entered.

7.8.2 Procedure: Noise reduction

Calibrate	Hold
Program	Display

1. Press MENU. The menu screen appears. Choose **Program**.

Outputs	Temp
Measurement	>>

2. Choose >>.

Security	HART
	>>

3. Choose >>.

Noise Rejection	
ResetTransmitter	>>

4. Choose **Noise Rejection**.

Ambient AC Power	
60Hz	50Hz

5. Select the frequency of the ambient AC power.

6. To return to the main display, press MENU then EXIT.

7.9 RESETTING FACTORY CALIBRATION AND FACTORY DEFAULT SETTINGS

7.9.1 Purpose

This section describes how to install factory calibration and default values. The process also clears all fault messages and returns the display to the first quick start screen.

7.9.2 Procedure: Installing default settings

Calibrate	Hold
Program	Display

1. Press MENU. The menu screen appears. Choose **Program**.

Outputs	Temp
Measurement	>>

2. Choose >>.

Security	HART
	>>

3. Choose >>.

Noise Rejection	
ResetTransmitter	>>

4. Choose **ResetTransmitter**.

Load factory settings?	Yes	No
------------------------	------------	----

5. Choose **Yes** or **No**. Choosing **Yes** clears previous settings and calibrations and returns the transmitter to the first quick start screen.

7.10 SELECTING A DEFAULT SCREEN AND SCREEN CONTRAST

7.10.1 Purpose

This section describes how to do the following:

1. Set a default screen. The default screen is the screen shown during normal operation. The Solu Comp Xmt allows the user to choose from a number of screens. Which screens are available depends on the measurement the transmitter is making.
2. Change the screen contrast.

7.10.2 Procedure: Choosing a display screen.

Calibrate	Hold
Program	Display

Default Display
Display Contrast

1. Press MENU. The menu screen appears. Choose **Display**.
2. Choose **Default Display**.
3. Press ↓ until the desired screen appears. Press ENTER.
4. The display returns to the screen in step 2. Press MENU then EXIT to return to the main display.

7.10.3 Procedure: Changing screen contrast.

Calibrate	Hold
Program	Display

Default Display
Display Contrast

Display contrast
Lighter Darker

1. Press MENU. The menu screen appears. Choose **Display**.
2. Choose **Display Contrast**.
3. To increase the contrast, select **darker**. Press ENTER. Each key press increases the contrast. To reduce the contrast, select **lighter**, Press ENTER. Each key press decreases the contrast.
4. To return to the main display, press MENU then EXIT.

NOTE:

Screen contrast can also be adjusted from the main display. Press MENU and ↑ at the same time to increase contrast. Press MENU and ↓ at the same time to decrease contrast. Repeatedly pressing the arrow key increases or reduces the contrast.

SECTION 8.0

CALIBRATION — TEMPERATURE

8.1 INTRODUCTION

The Calibrate Menu allows the user to calibrate the pH, ORP (or redox), and temperature response of the sensor.

8.2 CALIBRATING TEMPERATURE

8.2.1 Purpose

Temperature affects the measurement of pH in three ways.

1. The analyzer uses a temperature dependent factor to convert measured cell voltage to pH. Normally, a slight inaccuracy in the temperature reading is unimportant unless the pH reading is significantly different from 7.00. Even then, the error is small. For example, at pH 12 and 25°C, a 1°C error produces a pH error less than ± 0.02 .
2. During auto calibration, the Solu Comp Xmt recognizes the buffer being used and calculates the actual pH of the buffer at the measured temperature. Because the pH of most buffers changes only slightly with temperature, reasonable errors in temperature do not produce large errors in the buffer pH. For example, a 1°C error causes **at most** an error of ± 0.03 in the calculated buffer pH.
3. The Solu Comp Xmt can be programmed to calculate and display pH at a reference temperature (25°C). The maximum change in solution pH with temperature is about ± 0.04 pH/°C, so a 1°C temperature error does introduce a small error. However, the major source of error in solution temperature compensation is using an incorrect temperature coefficient.

Temperature affects the measurement of ORP in a complicated fashion that is best determined empirically.

Without calibration the accuracy of the temperature measurement is about ± 0.4 °C. Calibrate the sensor/analyzer combination if

1. ± 0.4 °C accuracy is not acceptable
2. the temperature measurement is suspected of being in error. Calibrate temperature by making the analyzer reading match the temperature measured with a **standard thermometer**.

8.2.2 Procedure

1. Remove the sensor from the process. Place it in an insulated container of water along with a **calibrated thermometer**. Submerge at least the bottom two inches of the sensor. Stir continuously.
2. Allow the sensor to reach thermal equilibrium. For some sensors, the time constant for a change in temperature is 5 min., so it may take as long as 30 min. for temperature equilibration.
3. If the sensor cannot be removed from the process, measure the temperature of a flowing sample taken from a point as close to the sensor as possible. Let the sample continuously overflow an insulated container holding a **calibrated thermometer**.
4. Change the Solu Comp Xmt display to match the **calibrated thermometer** using the procedure below.

Calibrate	Hold
Program	Display

Cal?	
Measurement	Temp

Live	25.0°C
Cal	+025.0°C

Manual Temp?	
+25.0°C	

- a. Press MENU. The menu screen appears. Choose **Calibrate**.
- b. Choose **Temp**.
- c. If transmitter was programmed in Section 7.5 to use the actual process temperature, go to step 7.
If the transmitter was programmed to use a temperature entered by the user, go to step 9.
- d. To calibrate the temperature, change the number in the second line to match the temperature measured with the **standard thermometer**. Press ENTER.
- e. Press MENU then EXIT to return to the main display.
- f. If the temperature value shown in the display is not correct, use the arrow keys to change it to the desired value. The transmitter will use the temperature entered in this step in all measurements and calculations, no matter what the true temperature is.
- g. Press MENU then EXIT to return to the main display.

SECTION 9.0 CALIBRATION — pH

9.1 INTRODUCTION

For pH sensors, two-point buffer calibration is standard. Both automatic calibration and manual calibration are available. Auto calibration avoids common pitfalls and reduces errors. Its use is recommended. In auto calibration the Solu Comp Xmt calculates the actual pH of the buffer from the nominal value entered by the user and does not accept calibration data until readings are stable. In manual calibration the user enters buffer values and judges when readings are stable. The pH reading can also be standardized, that is, forced to match the reading from a referee instrument. Finally, if the user knows the electrode slope (at 25°C), he can enter it directly.

The ORP calibration is a single-point calibration against an ORP standard.

A new pH sensor must be calibrated before use. Regular recalibration is also necessary.

A pH measurement cell (pH sensor and the solution to be measured) can be pictured as a battery with an extremely high internal resistance. The voltage of the battery depends on the pH of the solution. The pH meter, which is basically a voltmeter with a very high input impedance, measures the cell voltage and calculates pH using a conversion factor. The actual value of the voltage-to-pH conversion factor depends on the sensitivity of the pH sensing element (and the temperature). The sensing element is a thin, glass membrane at the end of the sensor. As the glass membrane ages, the sensitivity drops. Regular recalibration corrects for the loss of sensitivity. pH calibration standards, also called buffers, are readily available.

In automatic calibration the transmitter recognizes the buffer and uses temperature-corrected pH values in the calibration. The table below lists the standard buffers the controller recognizes. The controller also recognizes several technical buffers: Merck, Ingold, and DIN 19267. Temperature-pH data stored in the controller are valid between at least 0 and 60°C.

pH at 25°C (nominal pH)	Standard(s)
1.68	NIST, DIN 19266, JSI 8802, BSI (see note 1)
3.56	NIST, BSI
3.78	NIST
4.01	NIST, DIN 19266, JSI 8802, BSI
6.86	NIST, DIN 19266, JSI 8802, BSI
7.00	(see note 2)
7.41	NIST
9.18	NIST, DIN 19266, JSI 8802, BSI
10.01	NIST, JSI 8802, BSI
12.45	NIST, DIN 19266

Note 1: NIST is National Institute of Standards, DIN is Deutsche Institute für Normung, JSI is Japan Standards Institute, and BSI is British Standards Institute.

Note 2: pH 7 buffer is not a standard buffer. It is a popular commercial buffer in the United States.

During automatic calibration, the transmitter also measures noise and drift and does not accept calibration data until readings are stable. Calibration data will be accepted as soon as the pH reading is constant to within the factory-set limits of 0.02 pH units for 10 seconds. The stability settings can be changed. See Section 7.10.

In manual calibration, the user judges when pH readings are stable. He also has to look up the pH of the buffer at the temperature it is being used and enter the value in the transmitter.

Once the transmitter completes the calibration, it calculates the calibration slope and offset. The slope is reported as the slope at 25°C. Figure 9-1 defines the terms.

The transmitter can also be standardized. Standardization is the process of forcing the transmitter reading to match the reading from a second pH instrument. Standardization is sometimes called a one-point calibration.

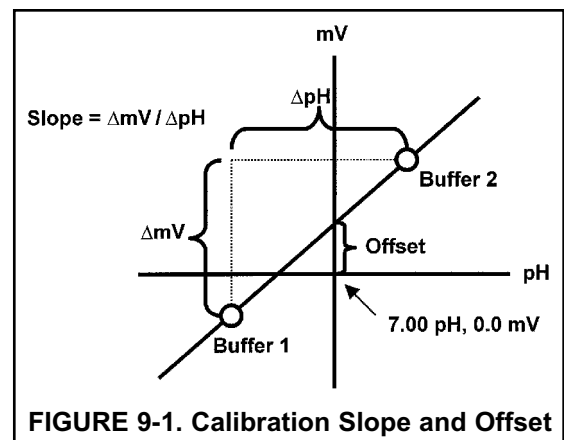

FIGURE 9-1. Calibration Slope and Offset

9.2 PROCEDURE — AUTO CALIBRATION

- Obtain two buffer solutions. Ideally, the buffer values should bracket the range of pH values to be measured.
- Remove the pH sensor from the process liquid. If the process and buffer temperatures are appreciably different, place the sensor in a container of tap water at the buffer temperature. Do not start the calibration until the sensor has reached the buffer temperature. Thirty minutes is usually adequate.

Calibrate	Hold
Program	Display

- Press MENU. The main menu appears. Choose **Calibrate**.

Cal?	
pH	Temp

- Choose **pH**.

pH	Standardize
Slope	BufferCal

- Choose **BufferCal**.

BufferCal?	
Auto	Manual

- Choose **Auto**.

AutoCal?	Setup
Buffer1	Buffer2

- To continue with the calibration, choose **Buffer1**. Then go to step 8. To change stability criteria, choose **Setup** and go to step 19.

- Rinse the sensor with water and place it in buffer 1. Be sure the glass bulb and the reference junction are completely submerged. Swirl the sensor.

Live	7.00pH
AutoBuf1	Wait

- The screen at left is displayed with “**Wait**” flashing until the reading is stable. The default stability setting is <0.02 pH change in 10 sec. To change the stability criteria, go to step 19. When the reading is stable, the screen in step 10 appears.

Live	7.00pH
AutoBuf1	7.01pH

- The top line shows the actual reading. The transmitter also identifies the buffer and displays the nominal buffer value (buffer pH at 25°C). If the displayed value is not correct, press **↑** or **↓** to display the correct value. The nominal value will change, for example from 7.01 to 6.86 pH. Press ENTER to store.

Cal in progress.	
Please wait.	

- The screen at left appears momentarily.

AutoCal?	Setup
Buffer1	Buffer2

- The screen at left appears. Remove the sensor from Buffer 1, rinse it with water, and place it in Buffer 2. Be sure the glass bulb and the reference junction are completely submerged. Swirl the sensor. Choose **Buffer2**.

Live	10.01pH
AutoBuf2	Wait

- The screen at left is displayed with “**Wait**” flashing until the reading is stable. When the reading is stable, the screen in step 14 appears.

Live	10.01pH
AutoBuf2	10.01pH

Cal in progress.	
Please wait.	

Offset	0mV
Slope	59.16 25°C

Calibration	
Error	

Buffer Stabilize	
Time:	10sec

Restart time if	
change >	0.02pH

14. The top line shows the actual reading. The transmitter also identifies the buffer and displays the nominal buffer value (buffer pH at 25°C). If the displayed value is not correct, press **↑** or **↓** to display the correct value. The nominal value will change, for example from 9.91 to 10.02 pH. Press ENTER to store.
15. The screen at the left appears momentarily.
16. If the calibration was successful, the transmitter will display the offset and slope (at 25°). The display will return to the screen in step 6.
17. If the slope is out of range (less than 45 mV/pH or greater than 60 mV/pH) or if the offset exceeds the value programmed in Section 7.4, an error screen appears. The display then returns to the screen in step 6.
18. To return to the main display, press MENU then EXIT.
19. Choosing Setup in step 7 causes the **Buffer Stabilize** screen to appear. The transmitter will not accept calibration data until the pH reading is stable. The default requirement is a pH change less than 0.02 units in 10 seconds. To change the stability criteria:
 - a. Enter the desired stabilization time
 - b. Enter the minimum amount the reading is permitted to change in the time specified in step 19a.
20. To return to the main display, press MENU then EXIT.

9.3 PROCEDURE — MANUAL TWO-POINT CALIBRATION

- Obtain two buffer solutions. Ideally, the buffer values should bracket the range of pH values to be measured.
- Remove the pH sensor from the process liquid. If the process and buffer temperatures are appreciably different, place the sensor in a container of tap water at the buffer temperature. Do not start the calibration until the sensor has reached the buffer temperature. Thirty minutes is usually adequate. Make a note of the temperature.

Calibrate	Hold
Program	Display

- Press MENU. The main menu appears. Choose **Calibrate**.

Cal?	
pH	Temp

- Choose **pH**.

pH	Standardize
Slope	BufferCal

- Choose **BufferCal**.

BufferCal?	
Auto	Manual

- Choose **Manual**.

ManualCal?	
Buffer1	Buffer2

- Choose **Buffer1**.

Live	7.00pH
Buf1	07.00pH

- Rinse the sensor with water and place it in buffer 1. Be sure the glass bulb and reference junction are completely submerged. Swirl the sensor.

- The reading in the top line is the live pH reading. Wait until the live reading is stable. Then, use the arrow keys to change the reading in the second line to match the pH value of the buffer. The pH of buffer solutions is a function of temperature. Be sure to enter the pH of the buffer at the actual temperature of the buffer.

ManualCal?	
Buffer1	Buffer2

- Remove the sensor from buffer 1 and rinse it with water. Place it in buffer 2. Be sure the glass bulb and the reference junction are completely submerged. Swirl the sensor. Choose **Buffer2**.

Live	10.01pH
Buf1	10.01pH

- The reading in the top line is the live pH reading. Wait until the live reading is stable. Then, use the arrow keys to change the reading in the second line to match the pH value of the buffer. The pH of buffer solutions is a function of temperature. Be sure to enter the pH of the buffer at the actual temperature of the buffer.

Cal in progress.	
Please wait.	

- The screen at left appears momentarily.

Offset	0mV
Slope	59.16 25°C

- If the calibration was successful, the transmitter will display the offset and slope (at 25°). The display will return to the screen in step 5.

Calibration	
Error	

- If the slope is out of range (less than 45 mV/pH or greater than 60 mV/pH) or if the offset exceeds the value programmed in Section 7.4, an error screen appears. The display then returns to the screen in step 6.

- To return to the main display, press MENU then EXIT.

9.4 PROCEDURE — STANDARDIZATION

1. The pH measured by the transmitter can be changed to match the reading from a second or referee instrument. The process of making the two readings agree is called standardization.
2. During standardization, the difference between the two values is converted to the equivalent voltage. The voltage, called the reference offset, is added to all subsequent measured cell voltages before they are converted to pH. If after standardization the sensor is placed in a buffer solution, the measured pH will differ from the buffer pH by an amount equivalent to the standardization offset.
3. Install the pH sensor in the process liquid.
4. Once readings are stable, measure the pH of the liquid using a referee instrument.
5. Because the pH of the process liquid may change if the temperature changes, measure the pH of the grab sample immediately after taking it.
6. For poorly buffered samples, it is best to determine the pH of a continuously flowing sample from a point as close as possible to the sensor.

Calibrate	Hold
Program	Display

7. Press MENU. The main menu appears. Choose **Calibrate**.

Cal?	
pH	Temp

8. Choose **pH**.

pH:	Standardize
Slope	BufferCal

9. Choose **Standardize**.

Live	7.01pH
Cal	07.01pH

10. The top line shows the present reading. Use the arrow keys to change the pH reading in the second line to match the pH reading from the referee instrument.

Calibration	
Error	

11. The screen at left appears if the entered pH was greater than 14.00 or if the mV offset calculated by the transmitter during standardization exceeds the reference offset limit programmed into the transmitter. The display then returns to step 10. Repeat the standardization. To change the reference offset from the default value (60 mV), see section 7.4.

12. If the entry was accepted the display returns to step 9.

13. To return to the main display, press MENU then EXIT.

9.5 PROCEDURE — ENTERING A KNOWN SLOPE VALUE.

1. If the electrode slope is known from other measurements, it can be entered directly into the transmitter. The slope must be entered as the slope at 25°C. To calculate the slope at 25°C from the slope at temperature t°C, use the equation:

$$\text{slope at } 25^{\circ}\text{C} = (\text{slope at } t^{\circ}\text{C}) \frac{298}{t^{\circ}\text{C} + 273}$$

Changing the slope overrides the slope determined from the previous buffer calibration.

Calibrate	Hold
Program	Display

2. Press MENU. The main menu appears. Choose **Calibrate**.

Cal?	
pH	Temp

3. Choose **pH**.

pH:	Standardize
Slope	BufferCal

4. Choose **slope**.

Changing slope
overrides bufcal.

5. The screen at left appears briefly.

pH Slope 25°C?
59.16mV/pH

6. Change the slope to the desired value. Press ENTER.

Invalid Input!
Min: 45.00mV/pH

7. The slope must be between 45 and 60 mV/pH. If the value entered is outside this range, the screen at left appears.

8. If the entry was accepted, the screen at left appears.

9. To return to the main display, press MENU then EXIT.

9.6 ORP CALIBRATION

9.6.1 Purpose

1. For process control, it is often important to make the measured ORP agree with the ORP of a standard solution.
2. During calibration, the measured ORP is made equal to the ORP of a standard solution at a single point.

9.6.2 Preparation of ORP standard solutions

ASTM D1498-93 gives procedures for the preparation of iron (II) - iron (III) and quinhydrone ORP standards. The iron (II) - iron (III) standard is recommended. It is fairly easy to make, is not particularly hazardous, and has a shelf life of about one year. In contrast, quinhydrone standards contain toxic quinhydrone and have only an eight-hour shelf life.

Iron (II) - iron (III) standard is available from Rosemount Analytical as PN R508-16OZ. The ORP of the standard solution measured against a silver-silver chloride reference electrode is 476 ± 20 mV at 25°C. The redox potential is -476 ± 20 mV at 25°C.

9.6.3 Procedure

Calibrate	Hold
Program	Display

1. Press MENU. The main menu screen appears. Choose **Calibrate**.

Cal	
ORP	Temp

2. Choose **ORP**.

Live	600mV
Cal	+0000mV

3. The top line shows the actual ORP or redox potential (**Live**). Once the reading is stable, change the number in the second line to the desired value. Press ENTER.

Cal is progress.
Please wait.

4. The screen on the left will appear briefly.

5. The display returns to the Cal Sensor screen. Press EXIT. Choose the other sensor and repeat steps 2 through 4.

SECTION 10.0 TROUBLESHOOTING

10.1 OVERVIEW

The Xmt-P transmitter continuously monitors itself and the sensor for problems. If the transmitter detects a problem, the word "**fault**" or "**warn**" appears in the main display alternating with the measurement.

A **fault** condition means the measurement is seriously in error and is not to be trusted. A fault condition might also mean that the transmitter has failed. Fault conditions must be corrected immediately. When a fault occurs the output goes to 22.00 mA or the to value programmed in Section 7.3. The output can also be programmed to reflect the live measurement.

A **warning** means that the instrument is usable, but steps should be taken as soon as possible to correct the condition causing the warning.

See Section 10.2 for an explanation of fault and warning messages and suggested corrective actions.

The Xmt-P also displays **error** and **warning messages** if a calibration is seriously in error. Refer to the section below for assistance. Each section also contains hints for correcting **other measurement and calibration problems**.

Measurement	Section
Faults and Warnings	10.2
Temperature	10.3
HART	10.4
pH	10.5
Non-measurement related	10.6
Simulating pH	10.7
Simulating Temp	10.8
Reference Voltage	10.9

NOTE

A large number of information screens provide diagnostics to aid troubleshooting. The most useful of these are sensor slope and offset and glass impedance. To view the information screens, go to the main display and press the ▼ key.

10.2 TROUBLESHOOTING WHEN A FAULT OR WARNING MESSAGE IS SHOWING

Fault message	Explanation	See Section
RTD Open	RTD measuring circuit is open	10.2.1
RTD Ω Overrange	RTD resistance is outside the range for Pt 100 or 22k NTC	10.2.1
Broken Glass	pH sensing element in pH sensor is broken	10.2.2
Glass Z Too High	pH glass impedance exceeds programmed level	10.2.2
ADC Read Error	Analog to digital converter failed	10.2.3
Ref Z Too High	Reference impedance is too high	10.2.4
EE Buffer Overflow	EEPROM buffer overflow	10.2.5
EE Chksum Error	EEPROM checksum error	10.2.6
EE Write Error	EEPROM write error	10.2.7

Warning message	Explanation	See Section
pH mV Too High	mV signal from pH sensor is too big	10.2.8
No pH Soln GND	Solution ground terminal is not connected	10.2.9
Sense Line Open	RTD sense line is not connected	10.2.10
Need Factory Cal	Transmitter needs factory calibration	10.2.11
Ground >10% Off	Bad ground	10.2.12

10.2.1 RTD Open, RTD Ω Overrange, Temperature High, Temperature Low

These messages usually mean that the RTD (or thermistor in the case of the Hx338 and Hx348 sensors) is open or shorted or there is an open or short in the connecting wiring.

1. Verify all wiring connections, including wiring in a junction box, if one is being used.
2. Disconnect the RTD IN, RTD SENSE, and RTD RETURN leads or the thermistor leads at the transmitter. Be sure to note the color of the wire and where it was attached. Measure the resistance between the RTD IN and RETURN leads. For a thermistor, measure the resistance between the two leads. The resistance should be close to the value in the table in Section 10.8. If the temperature element is open (infinite resistance) or shorted (very low resistance), replace the sensor. In the meantime, use manual temperature compensation.

10.2.2 Broken pH Glass and pH Glass Z High

These messages mean that the pH sensor glass impedance is outside the programmed limits. To read the impedance go to the main display and press **↓** until **Glass Imp** appears in the display. The default lower limit is 10 MΩ. The default upper limit is 1000 MΩ. Low glass impedance means the glass membrane — the sensing element in a pH sensor — is cracked or broken. High glass impedance means the membrane is aging and nearing the end of its useful life. High impedance can also mean the pH sensor is not completely submerged in the process liquid.

1. Check the sensor wiring, including connections in a junction box.
2. Verify that the sensor is completely submerged in the process liquid.
3. Verify that the software switch identifying the position of the preamplifier is properly set. See Section 7.4.
4. Check the sensor response in buffers. If the sensor can be calibrated, it is in satisfactory condition. To disable the fault message, reprogram the glass impedance limits to include the measured impedance. If the sensor cannot be calibrated, it has failed and must be replaced.

10.2.3 ADC Read Error

The analog to digital converter has probably failed.

1. Verify that sensor wiring is correct and connections are tight. Be sure to check connections at the junction box if one is being used. See Section 3.1 for wiring information.
2. Disconnect the sensor(s) and simulate temperature and sensor input. See Section 10.7 and 10.8.
3. If the transmitter does not respond to simulated signals, call the factory for assistance.

10.2.4 Ref Z Too High.

Ref Z Too High is an electrode fault message. **Ref Z Too High** means that the reference impedance exceeds the programmed Reference Fault Limit. A plugged or dry reference is the usual cause of a high reference impedance. High reference impedance also occurs if the sensor is not submerged in the process liquid or if inappropriate limits have been programmed into the transmitter.

The pH sensor is normally used with a high reference impedance. To disable the fault or warning diagnostic, program the reference impedance to a high value.

10.2.5 EE Buffer Overflow

EE Buffer Overflow means the software is trying to change too many background variables at once. Remove power from the transmitter for about 30 seconds. If the warning message does not disappear once power is restored, call the factory for assistance.

10.2.6 EE Chksum Error

EE Chksum Error means a software setting changed when it was not supposed to. The EEPROM may be going bad. Call the factory for assistance.

10.2.7 EE Write Error

EE Write Error usually means at least one byte in the EEPROM has gone bad. Try entering the data again. If the error message continues to appear, call the factory for assistance.

10.2.8 pH mV Too High

This message means the raw millivolt signal from the sensor is outside the range -2100 to 2100 mV.

1. Verify all wiring connections, including connections in a junction box.
2. Check that the pH sensor is completely submerged in the process liquid.
3. Check the pH sensor for cleanliness. If the sensor look fouled or dirty, clean it. Refer to the sensor instruction manual for cleaning procedures.

10.2.9 No pH Soln GND

In the transmitter, the solution ground (Soln GND) terminal is connected to instrument common. Normally, unless the pH sensor has a solution ground, the reference terminal must be jumpered to the solution ground terminal. **HOWEVER, WHEN THE pH SENSOR IS USED WITH A FREE CHLORINE SENSOR THIS CONNECTION IS NEVER MADE.**

10.2.10 Sense Line Open

Most Rosemount Analytical sensors use a Pt100 or Pt1000 RTD in a three-wire configuration (see Figure 10-3). The in and return leads connect the RTD to the measuring circuit in the transmitter. A third wire, called the sense line, is connected to the return lead. The sense line allows the transmitter to correct for the resistance of the in and return leads and to correct for changes in lead wire resistance with changes in ambient temperature.

1. Verify that all wiring connections are secure, including connections in a junction box.
2. Disconnect the RTD SENSE and RTD RETURN wires. Measure the resistance between the leads. It should be less than 5Ω.
3. The transmitter can be operated with the sense line open. The measurement will be less accurate because the transmitter can no longer compensate for lead wire resistance. However, if the sensor is to be used at approximately constant ambient temperature, the lead wire resistance error can be eliminated by calibrating the sensor at the measurement temperature. Errors caused by changes in ambient temperature cannot be eliminated. To make the warning message disappear, connect the RTD SENSE and RETURN terminals with a jumper.

10.2.11 Need Factory Cal

This warning message means the transmitter requires factory calibration. Call the factory for assistance.

10.2.12 Ground >10% Off

This warning message means there is a problem with the analog circuitry. Call the factory for assistance.

10.3 TROUBLESHOOTING WHEN NO FAULT MESSAGE IS SHOWING - TEMPERATURE**10.3.1 Temperature measured by standard was more than 1°C different from controller.**

- A. Is the standard thermometer, RTD, or thermistor accurate? General purpose liquid-in-glass thermometers, particularly ones that have been mistreated, can have surprisingly large errors.
- B. Is the temperature element in the sensor completely submerged in the liquid?
- C. Is the standard temperature sensor submerged to the correct level?

10.4 TROUBLESHOOTING WHEN NO FAULT MESSAGE IS SHOWING - HART

- A. If the Model 375 or 275 Communicator software does not recognize the Model Xmt-P transmitter, order an upgrade from Rosemount Measurement at (800) 999-9307.
- B. Be sure the HART load and voltage requirements are met.
 - 1. HART communications requires a minimum 250 ohm load in the current loop.
 - 2. Install a 250-500 ohm resistor in series with the current loop. Check the actual resistor value with an ohmmeter.
 - 3. For HART communications, the power supply voltage must be at least 18 Vdc. See Section 2.4.
- C. Be sure the HART Communicator is properly connected.
 - 1. The Communicator leads must be connected across the load.
 - 2. The Communicator can be connected across the power terminals (TB2).
- D. Verify that the Model 375 or 275 is working correctly by testing it on another HART Smart device.
 - 1. If the Communicator is working, the transmitter electronics may have failed. Call Rosemount Analytical for assistance.
 - 2. If the Communicator seems to be malfunctioning, call Rosemount Measurement at (800) 999-9307 for assistance.

10.5 TROUBLESHOOTING WHEN NO FAULT MESSAGE IS SHOWING - pH

Problem	See Section
Warning or error message during two-point calibration	10.5.1
Warning or error message during standardization	10.5.2
Controller will not accept manual slope	10.5.3
Sensor does not respond to known pH changes	10.5.4
Calibration was successful, but process pH is slightly different from expected value	10.5.5
Calibration was successful, but process pH is grossly wrong and/or noisy	10.5.6
Process reading is noisy	10.5.7

10.5.1 Warning or error message during two-point calibration.

Once the two-point (manual or automatic) calibration is complete, the transmitter automatically calculates the sensor slope (at 25°C). If the slope is less than 45 mV/pH, the transmitter displays a "Slope error low" message. If the slope is greater than 60 mV/pH, the transmitter displays a "Slope error high" message. The transmitter will not update the calibration. Check the following:

- A. Are the buffers accurate? Inspect the buffers for obvious signs of deterioration, such as turbidity or mold growth. Neutral and slightly acidic buffers are highly susceptible to molds. Alkaline buffers (pH 9 and greater), if they have been exposed to air for long periods, may also be inaccurate. Alkaline buffers absorb carbon dioxide from the atmosphere, which lowers the pH. If a high pH buffer was used in the failed calibration, repeat the calibration using a fresh buffer. If fresh buffer is not available, use a lower pH buffer. For example, use pH 4 and pH 7 buffer instead of pH 7 and pH 10 buffer.
- B. Was adequate time allowed for temperature equilibration? If the sensor was in a process liquid substantially hotter or colder than the buffer, place it in a container of water at ambient temperature for at least 20 minutes before starting the calibration.
- C. Were correct pH values entered during manual calibration? Using auto calibration eliminates error caused by improperly entered values.
- D. Is the sensor properly wired to the analyzer? Check sensor wiring including any connections in a junction box. See Section 3.3.
- E. Is the sensor dirty or coated? See the sensor instruction sheet for cleaning instructions.
- F. Is the sensor faulty? Check the glass impedance. From the main display, press the \blacktriangledown key until the "Glass impeded" screen is showing. Refer to the table for an interpretation of the glass impedance value.

less than 10 M Ω	Glass bulb is cracked or broken. Sensor has failed.
between 10 M Ω and 1000 M Ω	Normal reading
greater than 1000 M Ω	pH sensor may be nearing the end of its service life.

- G. Is the transmitter faulty? The best way to check for a faulty transmitter is to simulate pH inputs. See Section 15.13.

10.5.2 Warning or error message during standardization.

During standardization, the millivolt signal from the pH cell is increased or decreased until it agrees with the pH reading from a reference instrument. A unit change in pH requires an offset of about 59 mV. The controller limits the offset to ± 1400 mV. If the standardization causes an offset greater than ± 1400 mV, the analyzer will display the Calibration Error screen. The standardization will not be updated. Check the following:

- A. Is the referee pH meter working and properly calibrated? Check the response of the referee sensor in buffers.

Problem	Action
Incorrect current output	1. Verify that output load is within the values shown in Figure 2.5. 2. For minor errors, trim the output (see Section 7.3.6)
Display too light or too dark	Change contrast (see Section 7.10)
"Enter Security Code" shown in display	Transmitter has password protection (see Sections 5.4 and 7.6)
"Hold" showing in display	Transmitter is in hold (see Section 5.5)
"Current Output for Test:" showing in display	Transmitter is simulating outputs (see Section 7.3.5)

- B. Is the process sensor working properly? Check the process sensor in buffers.
- C. Is the sensor fully immersed in the process liquid? If the sensor is not completely submerged, it may be measuring the pH of the liquid film covering the glass bulb and reference element. The pH of this film may be different from the pH of the bulk liquid.

- D. Is the sensor fouled? The sensor measures the pH of the liquid adjacent to the glass bulb. If the sensor is heavily fouled, the pH of liquid trapped against the bulb may be different from the bulk liquid.
- E. Has the sensor been exposed to poisoning agents (sulfides or cyanides) or has it been exposed to extreme temperature? Poisoning agents and high temperature can shift the reference voltage many hundred millivolts.

10.5.3 Controller will not accept manual slope.

If the sensor slope is known from other sources, it can be entered directly into the controller. The controller will not accept a slope (at 25°) outside the range 45 to 60 mV/pH. If the user attempts to enter a slope less than 45 mV/pH, the controller will automatically change the entry to 45. If the user attempts to enter a slope greater than 60 mV/pH, the controller will change the entry to 60 mV/pH.

10.5.4 Sensor does not respond to known pH changes.

- A. Did the expected pH change really occur? If the process pH reading was not what was expected, check the performance of the sensor in buffers. Also, use a second pH meter to verify the change.
- B. Is the sensor properly wired to the analyzer?
- C. Is the glass bulb cracked or broken? Check the glass electrode impedance.
- D. Is the analyzer working properly. Check the analyzer by simulating the pH input.

10.5.5 Calibration was successful, but process pH is slightly different from expected value.

Differences between pH readings made with an on-line instrument and a laboratory or portable instrument are normal. The on-line instrument is subject to process variables, for example ground potentials, stray voltages, and orientation effects that may not affect the laboratory or portable instrument.

10.5.6 Calibration was successful, but process pH is grossly wrong and/or noisy.

Grossly wrong or noisy readings suggest a ground loop (measurement system connected to earth ground at more than one point), a floating system (no earth ground), or noise being brought into the analyzer by the sensor cable. The problem arises from the process or installation. It is not a fault of the analyzer. The problem should disappear once the sensor is taken out of the system. Check the following:

- A. Is a ground loop present?
 1. Verify that the system works properly in buffers. Be sure there is no direct electrical connection between the buffer containers and the process liquid or piping.
 2. Strip back the ends of a heavy gauge wire. Connect one end of the wire to the process piping or place it in the process liquid. Place the other end of the wire in the container of buffer with the sensor. The wire makes an electrical connection between the process and sensor.
 3. If offsets and noise appear after making the connection, a ground loop exists.
- B. Is the process grounded?
 1. The measurement system needs one path to ground: through the process liquid and piping. Plastic piping, fiber-glass tanks, and ungrounded or poorly grounded vessels do not provide a path. A floating system can pick up stray voltages from other electrical equipment.
 2. Ground the piping or tank to a local earth ground.
 3. If noise still persists, simple grounding is not the problem. Noise is probably being carried into the instrument through the sensor wiring.
- C. Simplify the sensor wiring.
 1. First, verify that pH sensor wiring is correct. Note that it is not necessary to jumper the solution ground and reference terminals.
 2. Disconnect all sensor wires at the analyzer except pH/mV IN, REFERENCE IN, RTD IN and RTD RETURN. See the wiring diagrams in Section 3.0. If the sensor is wired to the analyzer through a remote junction box containing a preamplifier, disconnect the wires at the sensor side of the junction box.
 3. Tape back the ends of the disconnected wires to keep them from making accidental connections with other wires

or terminals.

4. Connect a jumper wire between the RTD RETURN and RTD SENSE terminals (see wiring diagrams in Section 3.0).
 5. If noise and/or offsets disappear, the interference was coming into the analyzer through one of the sensor wires. The system can be operated permanently with the simplified wiring.
- D. Check for extra ground connections or induced noise.
1. If the sensor cable is run inside conduit, there may be a short between the cable and the conduit. Re-run the cable

10.6 TROUBLESHOOTING NOT RELATED TO MEASUREMENT PROBLEMS

outside the conduit. If symptoms disappear, there is a short between the cable and the conduit. Likely a shield is exposed and touching the conduit. Repair the cable and reinstall it in the conduit.

2. To avoid induced noise in the sensor cable, run it as far away as possible from power cables, relays, and electric motors. Keep sensor wiring out of crowded panels and cable trays.
3. If ground loops persist, consult the factory. A visit from a technician may be required to solve the problem.

10.5.7 Process pH readings are noisy.

- A. Is the sensor dirty or fouled? Suspended solids in the sample can coat the reference junction and interfere with the electrical connection between the sensor and the process liquid. The result is often a noisy reading.
- B. Is the sensor properly wired to the analyzer? See Section 3.0.
- C. Is a ground loop present?

10.7 SIMULATING INPUTS - pH

10.7.1 General

This section describes how to simulate a pH input into the transmitter. To simulate a pH measurement, connect a standard millivolt source to the transmitter. If the transmitter is working properly, it will accurately measure the input voltage and convert it to pH. Although the general procedure is the same, the wiring details depend on whether the preamplifier is in the sensor, a junction box, or the transmitter.

10.7.2 Simulating pH input when the preamplifier is in the analyzer.

1. Turn off automatic temperature correction (Section 7.5). Set the manual temperature to 25°C.
2. Disconnect the sensor and connect a jumper wire between the pH IN and the REFERENCE IN terminals.
3. From the Diagnostics menu scroll down until the "pH input" line is showing. The pH input is the raw voltage signal in mV. The measured voltage should be 0 mV and the pH should be 7.00. Because calibration data stored in the analyzer may be offsetting the input voltage, the displayed pH may not be exactly 7.00.
4. If a standard millivolt source is available, disconnect the jumper wire between the pH IN and the REFERENCE IN terminals and connect the voltage source as shown in Figure 10-1.
5. Calibrate the controller. Use 0.0 mV for Buffer 1 (pH 7.00) and -177.4 mV for Buffer 2 (pH 10.00). If the analyzer is working properly, it should accept the calibration. The slope should be 59.16 mV/pH and the offset should be zero.
6. To check linearity, set the voltage source to the values shown in the table and verify that the pH and millivolt readings match the values in the table.

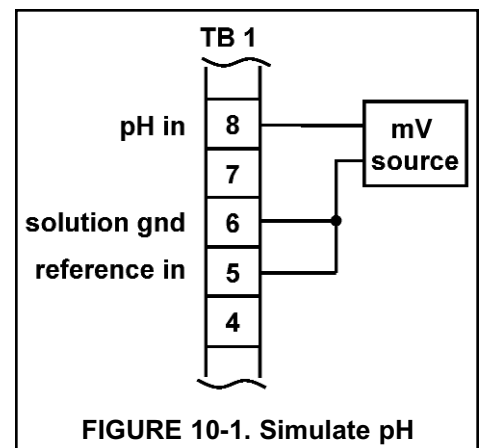

FIGURE 10-1. Simulate pH

Voltage (mV)	pH (at 25°C)
295.8	2.00
177.5	4.00
59.2	6.00
-59.2	8.00
-177.5	10.00
-295.8	12.00

10.7.3 Simulating pH input when the preamplifier is in a junction box.

The procedure is the same as described in Section 10.7.2. Keep the connections between the analyzer and the junction box in place. Disconnect the sensor at the sensor side of the junction box and connect the voltage source to the sensor side of the junction box. See Figure 10-3.

10.7.4 Simulating pH input when the preamplifier is in the sensor.

The preamplifier in the sensor converts the high impedance signal into a low impedance signal without amplifying it. To simulate pH values, follow the procedure in Section 10.7.2.

10.8 SIMULATING TEMPERATURE

10.8.1 General.

The Xmt-P transmitter accepts either a Pt100 RTD, Pt1000 RTD, or a 22k NTC thermistor (for Hx338 and Hx348 pH sensors). The Pt100 RTD is in a three-wire configuration. See Figure 10-2. The 22k thermistor has a two-wire configuration.

10.8.2 Simulating temperature

To simulate the temperature input, wire a decade box to the analyzer or junction box as shown in Figure 10-3.

To check the accuracy of the temperature measurement, set the resistor simulating the RTD to the values indicated in the table and note the temperature readings. The measured temperature might not agree with the value in the table. During sensor calibration an offset might have been applied to make the measured temperature agree with a standard thermometer. The offset is also applied to the simulated resistance. The controller is measuring temperature correctly if the difference between measured temperatures equals the difference between the values in the table to within $\pm 0.1^\circ\text{C}$.

For example, start with a simulated resistance of $103.9\ \Omega$, which corresponds to 10.0°C . Assume the offset from the sensor calibration was $-0.3\ \Omega$. Because of the offset, the analyzer calculates temperature using $103.6\ \Omega$. The result is 9.2°C . Now change the resistance to $107.8\ \Omega$, which corresponds to 20.0°C . The analyzer uses $107.5\ \Omega$ to calculate the temperature, so the display reads 19.2°C . Because the difference between the displayed temperatures (10.0°C) is the same as the difference between the simulated temperatures, the analyzer is working correctly.

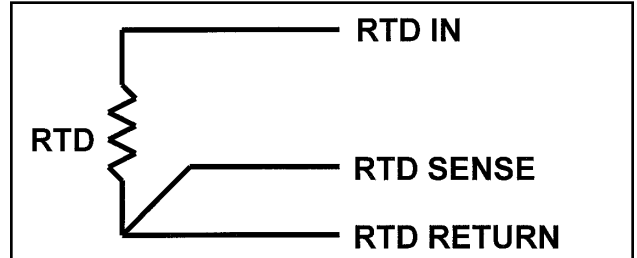

FIGURE 10-2. Three-Wire RTD Configuration.

Although only two wires are required to connect the RTD to the analyzer, using a third (and sometimes fourth) wire allows the analyzer to correct for the resistance of the lead wires and for changes in the lead wire resistance with temperature.

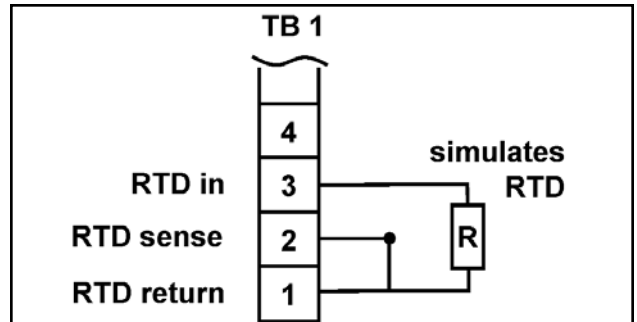

FIGURE 10-3. Simulating RTD Inputs.

The figure shows wiring connections for sensors containing a Pt100 or Pt1000 RTD.

Temp. ($^\circ\text{C}$)	Pt 100 (Ω)	22k NTC ($\text{k}\Omega$)
0	100.0	64.88
10	103.9	41.33
20	107.8	26.99
25	109.7	22.00
30	111.7	18.03
40	115.5	12.31
50	119.4	8.565
60	123.2	6.072
70	127.1	4.378
80	130.9	3.208
85	132.8	2.761
90	134.7	2.385
100	138.5	1.798

10.9 MEASURING REFERENCE VOLTAGE

Some processes contain substances that poison or shift the potential of the reference electrode. Sulfide is a good example. Prolonged exposure to sulfide converts the reference electrode from a silver/silver chloride electrode to a silver/silver sulfide electrode. The change in reference voltage is several hundred millivolts. A good way to check for poisoning is to compare the voltage of the reference electrode with a silver/silver chloride electrode known to be good. The reference electrode from a new sensor is best. See Figure 10-4. If the reference electrode is good, the voltage difference should be no more than about 20 mV. A poisoned reference electrode usually requires replacement.

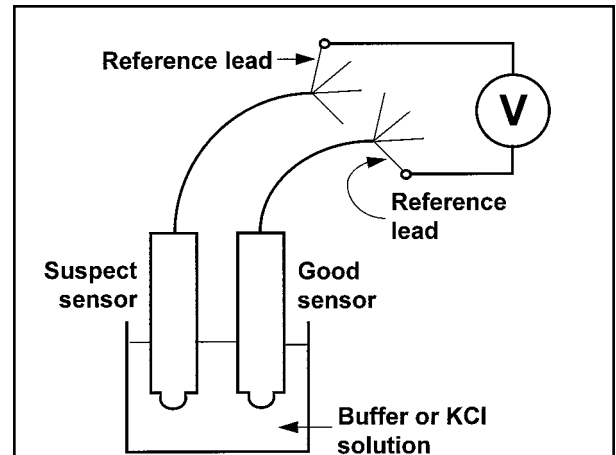

FIGURE 10-4. Checking for a Poisoned Reference Electrode.

Refer to the sensor wiring diagram to identify the reference leads. A laboratory silver/silver chloride electrode can be used in place of the second sensor.

SECTION 11.0 MAINTENANCE

11.1 OVERVIEW

The Solu Comp Xmt needs little routine maintenance. The calibration of the analyzer and sensor should be checked periodically. To recalibrate the sensor and analyzer, refer to sections 9 through 14.

11.2 REPLACEMENT PARTS

Only a few components of the analyzer are replaceable. Refer to the tables below. Circuit boards, display, and enclosure are not replaceable.

TABLE 11-1. REPLACEMENT PARTS FOR SOLU COMP XMT (PANEL MOUNT VERSION)

PART NUMBER	DESCRIPTION	SHIPPING WEIGHT
23823-00	Panel mounting kit, includes four brackets and four set screws	1 lb/0.5 kg
33654-00	Gasket, front, for panel mount version	1 lb/0.5 kg
33658-00	Gasket, rear cover, for panel mount version	1 lb/0.5 kg

TABLE 11-2. REPLACEMENT PARTS FOR SOLU COMP XMT (PIPE/SURFACE MOUNT VERSION)

PART NUMBER	DESCRIPTION	SHIPPING WEIGHT
33655-00	Gasket for pipe/surface mount version	1 lb/0.5 kg
23833-00	Surface mount kit, consists of four self tapping screws and four O-rings	1 lb/0.5 kg

SECTION 12.0

pH MEASUREMENTS

- 12.1 General
- 12.2 Measuring Electrode
- 12.3 Reference Electrode
- 12.4 Liquid Junction Potential
- 12.5 Converting Voltage to pH
- 12.6 Glass Electrode Slope
- 12.7 Buffers and Calibration
- 12.8 Isopotential pH
- 12.9 Junction Potential Mismatch
- 12.10 Sensor Diagnostics
- 12.11 Shields, Insulation, and Preamplifiers

12.1 GENERAL

In nearly every industrial and scientific application, pH is determined by measuring the voltage of an electrochemical cell. Figure 12-1 shows a simplified diagram of a pH cell. The cell consists of a measuring electrode, a reference electrode, a temperature sensing element, and the liquid being measured. The voltage of the cell is directly proportional to the pH of the liquid. The pH meter measures the voltage and uses a temperature-dependent factor to convert the voltage to pH. Because the cell has high internal resistance, the pH meter must have a very high input impedance.

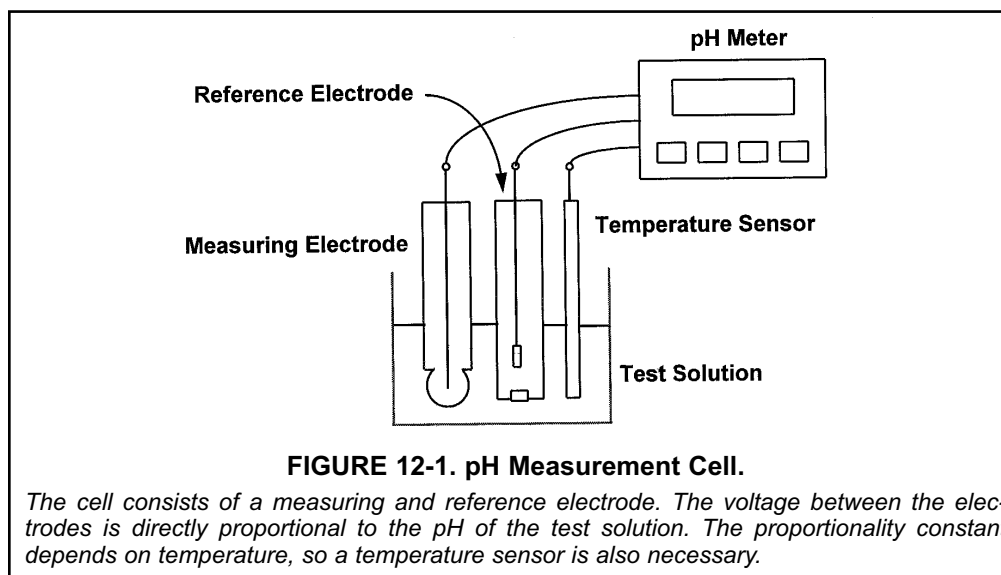

Figure 12-1 shows separate measuring and reference electrodes. In most process sensors, the electrodes and the temperature element are combined into a single body. Such sensors are often called combination electrodes.

The cell voltage is the algebraic sum of the potential of the measuring electrode, the potential of the reference electrode, and the liquid junction potential. The potential of the measuring electrode depends only on the pH of the solution. The potential of the reference electrode is unaffected by pH, so it provides a stable reference voltage. The liquid junction potential depends in a complex way on the identity and concentration of the ions in the sample. It is always present, but if the sensor is properly

designed, the liquid junction potential is usually small and relatively constant. All three potentials depend on temperature. As discussed in Sections 12.5 and 12.6, the factor relating the cell voltage to pH is also a function of temperature.

The construction of each electrode and the electrical potentials associated with it are discussed in Sections 12.2, 12.3, and 12.4.

12.2 MEASURING ELECTRODE

Figure 12-2 shows the internals of the measuring electrode. The heart of the electrode is a thin piece of pH-sensitive glass blown onto the end of a length of glass tubing. The pH-sensitive glass, usually called a glass membrane, gives the electrode its common name: glass electrode. Sealed inside the electrode is a solution of potassium chloride buffered at pH 7. A piece of silver wire plated with silver chloride contacts the solution.

The silver wire-silver chloride combination in contact with the filling solution constitutes an internal reference electrode. Its potential depends solely on the chloride concentration in the filling solution. Because the chloride concentration is fixed, the electrode potential is constant.

As Figure 12-2 shows, the outside surface of the glass membrane contacts the liquid being measured, and the inside surface contacts the filling solution. Through a complex mechanism, an electrical potential directly proportional to pH develops at each glass-liquid interface. Because the pH of the filling solution is fixed, the potential at the inside surface is constant. The potential at the outside surface, however, depends on the pH of the test solution.

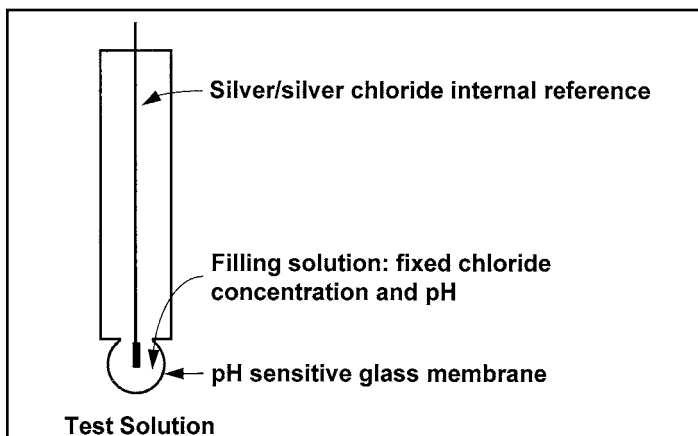

FIGURE 12-2. Measuring Electrode.

The essential element of the glass electrode is a pH-sensitive glass membrane. An electrical potential develops at glass-liquid interfaces. The potential at the outside surface depends on the pH of the test solution. The potential at the inside surface is fixed by the constant pH of the filling solution. Overall, the measuring electrode potential depends solely on the pH of the test solution.

The overall potential of the measuring electrode equals the potential of the internal reference electrode plus the potentials at the glass membrane surfaces. Because the potentials inside the electrode are constant, the overall electrode potential depends solely on the pH of the test solution. The potential of the measuring electrode also depends on temperature. If the pH of the sample remains constant but the temperature changes, the electrode potential will change. Compensating for changes in glass electrode potential with temperature is an important part of the pH measurement.

Figure 12-3 shows a cross-section through the pH glass. pH sensitive glasses absorb water. Although the water does not penetrate more than about 50 nanometers (5×10^{-8} m) into the glass, the hydrated layer must be present for the glass to respond to pH changes. The layer of glass between the two hydrated layers remains dry. The dry layer makes the glass a poor conductor of electricity and causes the high internal resistance (several hundred megohms) typical of glass electrodes.

12.3 REFERENCE ELECTRODE

As Figure 12-4 shows, the reference electrode is a piece of silver wire plated with silver chloride in contact with a concentrated solution of potassium chloride held in a glass or plastic tube. In many reference electrodes the solution is an aqueous gel, not a liquid. Like the electrode inside the glass electrode, the potential of the external reference is controlled by the concentration of chloride in the filling solution. Because the chloride level is constant, the potential of the reference electrode is fixed. The potential does change if the temperature changes.

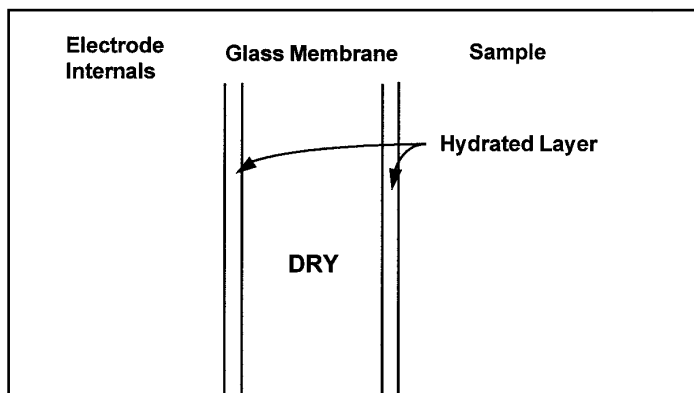

FIGURE 12-3. Cross-Section through the pH Glass.

For the glass electrode to work, the glass must be hydrated. An ion exchange mechanism involving alkali metals and hydrogen ions in the hydrated layer is responsible for the pH response of the glass.

12.4 LIQUID JUNCTION POTENTIAL

The salt bridge (see Figure 12-4) is an integral part of the reference electrode. It provides the electrical connection between the reference electrode and the liquid being measured. Salt bridges take a variety of forms, anything from a glass frit to a wooden plug. Salt bridges are highly porous, and the pores are filled with ions. The ions come from the filling solution and the sample. Some bridges permit only diffusion of ions through the junction. In other designs, a slow outflow of filling solution occurs. Migration of ions in the bridge generates a voltage, called the liquid junction potential. The liquid junction potential is in series with the measuring and reference electrode potentials and is part of the overall cell voltage.

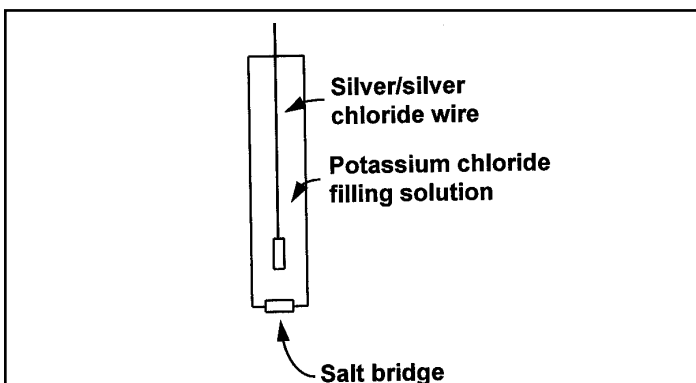

FIGURE 12-4. Reference Electrode.

The fixed concentration of chloride inside the electrode keeps the potential constant. A porous plug salt bridge at the bottom of the electrode permits electrical contact between the reference electrode and the test solution.

Figure 12-5 helps illustrate how liquid junction potentials originate. The figure shows a section through a pore in the salt bridge. For simplicity, assume the bridge connects a solution of potassium chloride and hydrochloric acid of equal molar concentration. Ions from the filling solution and ions

from the sample diffuse through the pores. Diffusion is driven by concentration differences. Each ion migrates from where its concentration is high to where its concentration is low. Because ions move at different rates, a charge separation develops. As the charge separation increases, electrostatic forces cause the faster moving ions to slow down and the slower moving ions to speed up. Eventually, the migration rates become equal, and the system reaches equilibrium. The amount of charge separation at equilibrium determines the liquid junction potential.

Liquid junction potentials exist whenever dissimilar electrolyte solutions come into contact. The magnitude of the potential depends on the difference between the mobility of the ions. Although liquid junction potentials cannot be eliminated, they can be made small and relatively constant. A small liquid junction potential exists when the ions present in greatest concentration have equal (or almost equal) mobilities. The customary way of reducing junction potentials is to fill the reference electrode with concentrated potassium chloride solution. The high concentration ensures that potassium chloride is the major contributor to the junction potential, and the nearly equal mobilities of potassium and chloride ions makes the potential small.

12.5 CONVERTING VOLTAGE TO pH

Equation 1 summarizes the relationship between measured cell voltage (in mV), pH, and temperature (in Kelvin):

$$E(T) = E^{\circ}(T) + 0.1984 T \text{ pH} \quad (1)$$

The cell voltage, $E(T)$ —the notation emphasizes the dependence of cell voltage on temperature—is the sum of five electrical potentials. Four are independent of the pH of the test solution and are combined in the first term, $E^{\circ}(T)$. These potentials are listed below:

1. the potential of the reference electrode inside the glass electrode
2. the potential at the inside surface of the glass membrane
3. the potential of the external reference electrode
4. the liquid junction potential.

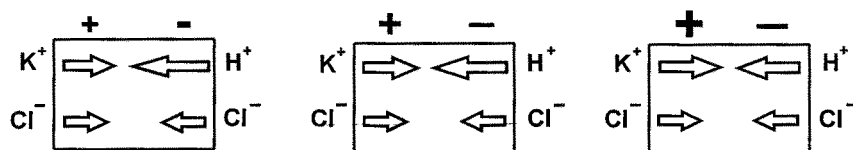

FIGURE 12-5. The Origin of Liquid Junction Potentials.

The figure shows a thin section through a pore in the junction plug. The junction separates a solution of potassium chloride on the left from a solution of hydrochloric acid on the right. The solutions have equal molar concentration. Driven by concentration differences, hydrogen ions and potassium ions diffuse in the directions shown. The length of each arrow indicates relative rates. Because hydrogen ions move faster than potassium ions, positive charge builds up on the left side of the section and negative charge builds up on the right side. The ever-increasing positive charge repels hydrogen and potassium ions. The ever-increasing negative charge attracts the ions. Therefore, the migration rate of hydrogen decreases, and the migration rate of potassium increases. Eventually the rates become equal. Because the chloride concentrations are the same, chloride does not influence the charge separation or the liquid junction potential.

The second term, $0.1984 T$ pH, is the potential (in mV) at the outside surface of the pH glass. This potential depends on temperature and on the pH of the sample. Assuming temperature remains constant, any change in cell voltage is caused solely by a change in the pH of the sample. Therefore, the cell voltage is a measure of the sample pH.

Note that a graph of equation 1, $E(T)$ plotted against pH, is a straight line having a y-intercept of $E^\circ(T)$ and a slope of $0.1984 T$.

12.6 GLASS ELECTRODE SLOPE

For reasons beyond the scope of this discussion, equation 1 is commonly rewritten to remove the temperature dependence in the intercept and to shift the origin of the axes to pH 7. The result is plotted in Figure 12-6. Two lines appear on the graph. One line shows how cell voltage changes with pH at 25°C, and the other line shows the relationship at 50°C. The lines, which are commonly called isotherms, intersect at the point (pH 7, 0 mV). An entire family of curves, each having a slope determined by the temperature and all passing through the point (pH 7, 0 mV) can be drawn on the graph.

Figure 12-6 shows why temperature is important in making pH measurements. When temperature changes, the slope of the isotherm changes. Therefore, a given cell voltage corresponds to a different pH value, depending on the temperature. For example, assume the cell voltage is -150 mV. At 25°C the pH is 9.54, and at 50°C the pH is 9.35. The process of selecting the correct isotherm for converting voltage to pH is called temperature compensation. All modern process pH meters, including the Model XMT-P pH/ORP transmitter, have automatic temperature compensation.

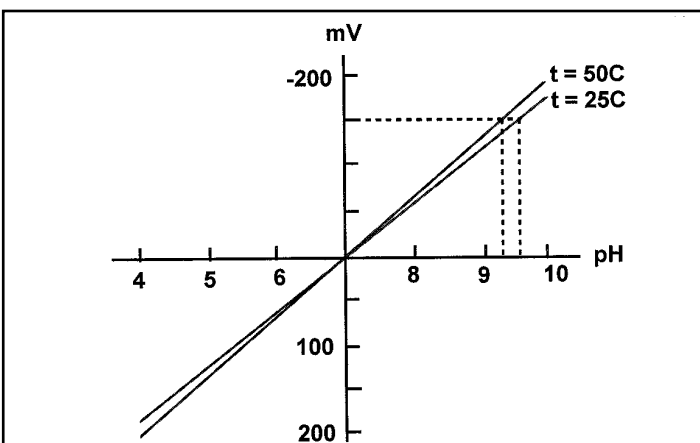

FIGURE 12-6. Glass Electrode Slope.

The voltage of a pH measurement cell depends on pH and temperature. A given pH produces different voltages depending on the temperature. The further from pH 7, the greater the influence of temperature on the relationship between pH and cell voltage.

The slope of the isotherm is often called the glass electrode or sensor slope. The slope can be calculated from the equation: slope = $0.1984 (t + 273.15)$, where t is temperature in °C. The slope has units of mV per unit change in pH. The table lists slopes for different temperatures.

Temp (°C)	Slope (mV/unit pH)
15	-57.2
20	-58.2
25	-59.2
30	-60.1
35	-61.1

As the graph in Figure 12-6 suggests, the closer the pH is to 7, the less important is temperature compensation. For example, if the pH is 8 and the temperature is 30°C, a 10°C error in temperature introduces a pH error of ± 0.03 . At pH 10, the error in the measured pH is ± 0.10 .

12.7 BUFFERS AND CALIBRATION

Figure 12-6 shows an ideal cell: one in which the voltage is zero when the pH is 7, and the slope is $0.1984 T$ over the entire pH range. In a real cell the voltage at pH 7 is rarely zero, but it is usually between -30 mV and +30 mV. The slope is also seldom $0.1984 T$ over the entire range of pH. However, over a range of two or three pH units, the slope is usually close to ideal.

Calibration compensates for non-ideal behavior. Calibration involves the use of solutions having exactly known pH, called calibration buffers or simply buffers. Assigning a pH value to a buffer is not a simple process. The laboratory work is demanding, and extensive theoretical work is needed to support certain assumptions that must be made. Normally, establishing pH scales is a task best left to national standards laboratories. pH scales developed by the United States National Institute of Standards and Technology (NIST), the British Standards Institute (BSI), the Japan Standards Institute (JSI), and the German Deutsche Institute für Normung (DIN) are in common use. Although there are some minor differences, for practical purposes the scales are identical. Commercial buffers are usually traceable to a recognized standard scale. Generally, commercial buffers are less accurate than standard buffers. Typical accuracy is ± 0.01 pH units. Commercial buffers, sometimes called technical buffers, do have greater buffer capacity. They are less susceptible to accidental contamination and dilution than standard buffers.

Figure 12-7 shows graphically what happens during calibration. The example assumes calibration is being done at pH 7.00 and pH 10.00. When the electrodes are placed in pH 7 buffer the cell voltage is V_7 , and when the electrodes

are placed in pH 10 buffer, the cell voltage is V_{10} . Note that V_7 is not 0 mV as would be expected in an ideal sensor, but is slightly different.

The microprocessor calculates the equation of the straight line connecting the points. The general form of the equation is:

$$E = A + B (t + 273.15) (\text{pH} - 7) \quad (2)$$

The slope of the line is $B (t + 273.15)$, where t is the temperature in $^{\circ}\text{C}$, and the y-intercept is A . If pH 7 buffer is used for calibration, V_7 equals A . If pH 7 buffer is not used, A is calculated from the calibration data.

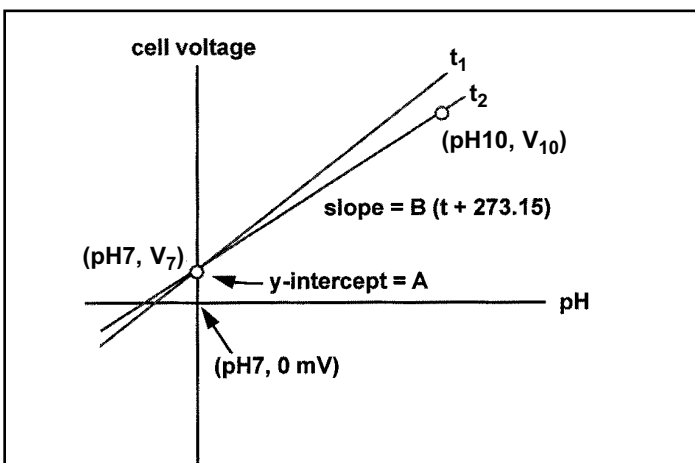

FIGURE 12-7. Two-Point Buffer Calibration.

The graph shows a calibration using pH 7 and pH 10 buffers. The calibration equation is the straight line connecting the two points. If temperature changes, the slope changes by the ratio $(t_2 + 273.15)/(t_1 + 273.15)$, where t_1 is the calibration temperature and t_2 is the process temperature in $^{\circ}\text{C}$. The calibration equations rotate about the point (pH 7, A).

The microprocessor then converts subsequent cell voltage measurements into pH using the calibration line.

12.8 ISOPOTENTIAL pH

Frequently, the calibration temperature and the process temperature are different. Therefore, the calibration slope is not appropriate for the sample. Figure 12-7 shows what the microprocessor does when buffer and sample temperatures are different. Assume the sensor was calibrated at temperature t_1 and the process temperature is t_2 . To measure the pH of the process, the microprocessor rotates the calibration line about the point (pH 7, A) until the slope equals $B (t_2 + 273.15)$. The microprocessor then uses the new isotherm to convert voltage to pH. The point (pH 7, A) is called the isopotential pH. As Figure 12-7 shows, the isopotential pH is the pH at which the cell voltage does not change when the temperature changes.

The microprocessor makes assumptions when the measurement and calibration temperatures are different. It assumes the actual measurement cell isotherms rotate about the point (pH 7, A). The assumption may not be correct, so the measurement will be in error. The size of the error depends on two things: the difference between the isopotential pH of the measurement cell and pH 7 and the difference between the calibration and measurement temperatures. For a 10°C temperature difference and a difference in isopotential pH of 2, the error is about ± 0.07 pH units. The factors that cause the isopotential pH of a real cell to differ from 7 are beyond the scope of this discussion and to a great extent are out of the control of the user as well.

Most pH cells do not have an isopotential pH point. Instead, the cell isopotential pH changes with temperature, and the cell isotherms rotate about a general area. Measuring the isopotential pH requires great care and patience.

One way to reduce the error caused by disagreement between the sensor and meter isopotential pH is to calibrate the sensor at the same temperature as the process. However, great care must be exercised when the buffer temperature is significantly greater than ambient temperature. First, the buffer solution must be protected from evaporation. Evaporation changes the concentration of the buffer and its pH. Above 50°C , a reflux condenser may be necessary. Second, the pH of buffers is defined over a limited temperature range. For example, if the buffer pH is defined only to 60°C , the buffer cannot be used for calibration at 70°C . Finally, no matter what the temperature, it is important that the entire measurement cell, sensor and solution, be at constant temperature. This requirement is critical because lack of temperature uniformity in the cell is one reason the cell isopotential point moves when the temperature changes.

12.9 JUNCTION POTENTIAL MISMATCH

Although glass electrodes are always calibrated with buffers, the use of buffers causes a fundamental error in the measurement.

When the glass and reference electrodes are placed in a buffer, a liquid junction potential, E_{lj} , develops at the interface between the buffer and the salt bridge. The liquid junction potential is part of the overall cell voltage and is included in A in equation 2. Equation 2 can be modified to

show E_{lj} as a separate term:

$$E = A' + E_{lj} + B (t + 273.15) (\text{pH} - 7) \quad (3)$$

or

$$E = E' (\text{pH}, t) + E_{lj} \quad (4)$$

where $E' (\text{pH}, t) = A' + B (t + 273.15) (\text{pH} - 7)$.

In Figure 12-8, calibration and measurement data are plotted in terms of equation 4. The cell voltage, E , is represented by the dashed vertical line. The contribution of each

term in equation 4 to the voltage is also shown. The liquid junction potentials in the buffers are assumed to be equal and are exaggerated for clarity.

If the liquid junction potential in the sample differs from the buffers, a measurement error results. Figure 12-8 illustrates how the error comes about. Assume the true pH of the sample is pH_s and the cell voltage is E_s . The point (pH_s, E_s) is shown on the graph. If the liquid junction potential in the sample were equal to the value in the buffers, the point would lie on the line. However, the liquid junction potential in the sample is greater, so the point E_s lies above the calibration line. Therefore, when the cell voltage is converted to pH, the result is greater than the true pH by the amount shown.

A typical mismatch between liquid junction potentials in buffer and sample is 2-3 mV, which is equivalent to an error of about ± 0.02 pH units. The mismatch produces a fundamental error in pH determinations using a cell with liquid junction.

12.10 SENSOR DIAGNOSTICS

Sensor diagnostics alert the user to problems with the sensor or to actual sensor failures. The two sensor diagnostics are reference impedance and glass impedance.

The major contributor to reference impedance is the resistance across the liquid junction plug. In a properly functioning electrode, the resistance of the liquid junction should be no more than several hundred kilohms. If the junction is plugged or if the filling solution or gel is depleted, the resistance increases. A high reference impedance may also mean the sensor is not immersed in the process stream.

Glass impedance refers to the impedance of the pH-sensitive glass membrane. The impedance of the glass membrane is a strong function of temperature. As temperature increases, the impedance decreases. For a change in glass impedance to have any meaning, the impedance measurement must be corrected to a reference temperature. The impedance of a typical glass electrode at 25°C is several hundred megohms. A sharp decrease in the temperature-corrected impedance implies that the glass is cracked. A cracked glass electrode produces erroneous pH readings. The electrode should be replaced immediately. A high temperature-corrected glass impedance implies the sensor is nearing the end of its life and should be replaced as soon as possible.

12.11 SHIELDS, INSULATION, AND PREAMPLIFIERS

pH measurement systems, cell and meter, have high impedance. The high impedance circuit imposes important restrictions on how pH measurement systems are designed.

The lead wire from the glass electrode connects two high resistances: about 100 MΩ at the electrode and about 1,000,000 MΩ at the meter. Therefore, electrostatic charges, which accumulate on the wire from environmental influences, cannot readily drain away. Buildup of charge results in degraded, noisy readings. Shielding the wire with metal braid connected to ground at the instrument is one way to improve the signal. It is also helpful to keep the sensor cable as far away as possible from AC power cables. The high input impedance of the pH meter requires that the lead insulation and the insulation between the meter inputs be of high quality. To provide further protection from environmental interference, the entire sensor cable can be enclosed in conduit.

To avoid the need for expensive cable and cable installations, a preamplifier built into the sensor or installed in a junction box near the sensor can be used. The preamplifier converts the high impedance signal into a low impedance signal that can be sent as far as 200 feet without special cable.

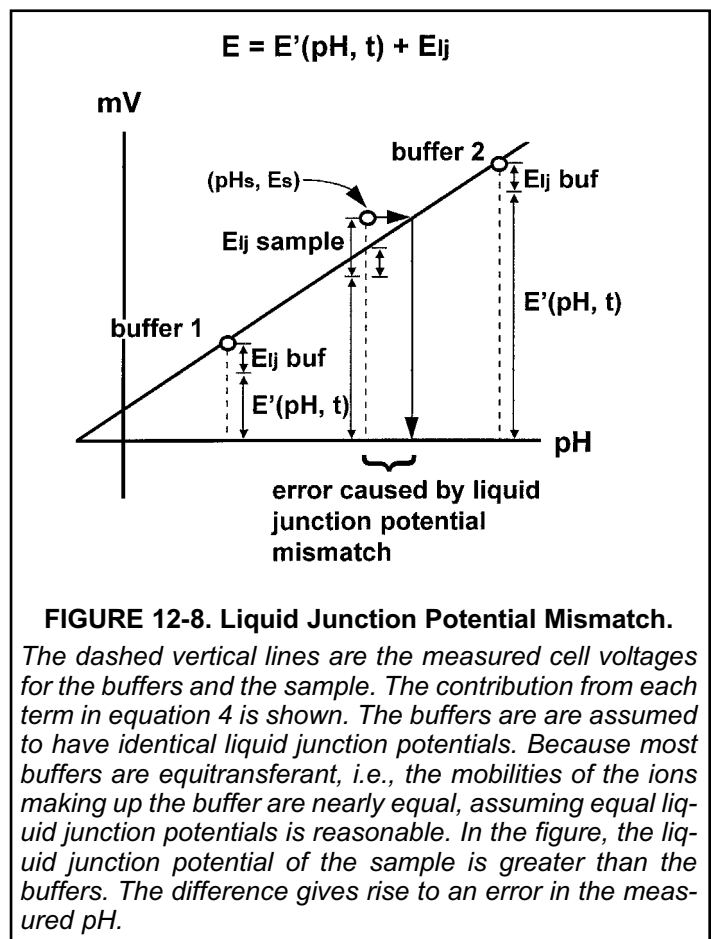

SECTION 13.0

ORP MEASUREMENTS

- 13.1 General
- 13.2 Measuring Electrode
- 13.3 Reference Electrode
- 13.4 Liquid Junction Potential
- 13.5 Relating Cell Voltage to ORP
- 13.6 ORP, Concentration, and pH
- 13.7 Interpreting ORP Measurements
- 13.8 Calibration

13.1 GENERAL

Figure 13-1 shows a simplified diagram of an electrochemical cell that can be used to determine the oxidation-reduction potential or ORP of a sample. The cell consists of a measuring electrode, a reference electrode, the liquid being measured, and a temperature-sensing element. The cell voltage is the ORP of the sample. In most industrial and scientific applications, a pH meter is used to measure the voltage. Because a pH meter is really a high impedance voltmeter, it makes an ideal ORP meter.

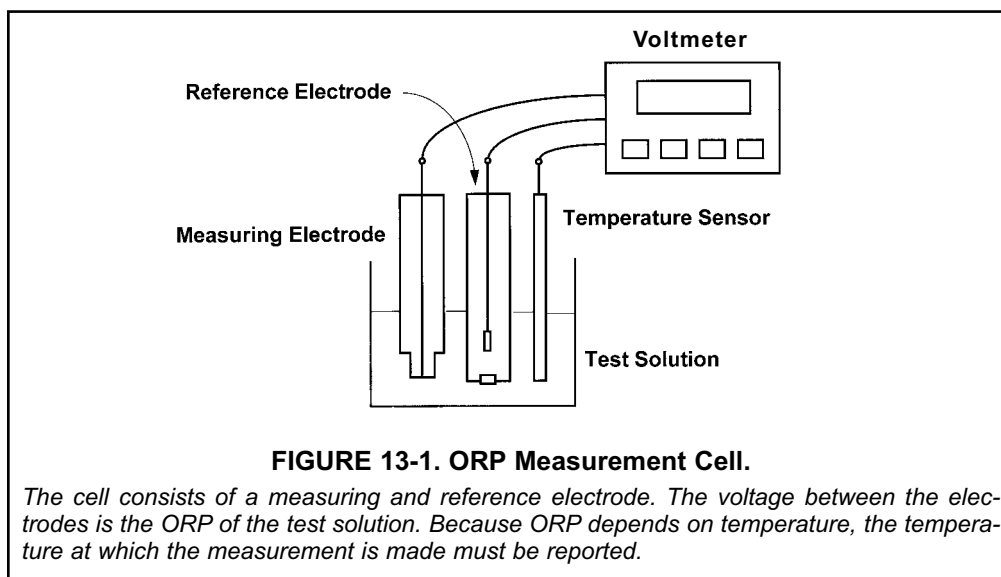

Figure 13-1 shows separate measuring and reference electrodes. In most process sensors the electrodes and the temperature element are combined into a single body. Such sensors are often called combination electrodes.

The cell voltage is the algebraic sum of the potential of the measuring electrode, the potential of the reference electrode, and the liquid junction potential. The potential of the measuring electrode depends on the ORP of the solution. The potential of the reference electrode is unaffected by ORP, so it provides a stable reference voltage. The liquid junction potential depends in a complex way on the identity and concentration of the ions in the sample. It is always present, but if the sensor is properly designed, the liquid junction potential is usually small and relatively constant. All three potentials depend on temperature.

The construction of each electrode and the electrical potential associated with the electrode are discussed in Sections 13.2, 13.3, and 13.4.

13.2 MEASURING ELECTRODE

Figure 13-2 shows a typical ORP measuring electrode. The electrode consists of a band or disc of platinum attached to the base of a sealed glass tube. A platinum wire welded to the band connects it to the lead wire.

For a noble metal electrode to develop a stable potential, a redox couple must be present. A redox couple is simply two compounds that can be converted into one another by the gain or loss of electrons. Iron (II) and iron (III) are a redox couple. The oxidized form, iron (III), can be converted into the reduced form, iron (II), by the gain of one electron. Similarly, iron (II) can be converted to iron (III) by the loss of an electron. For more details concerning the nature of redox potential, see Section 13.5.

13.3 REFERENCE ELECTRODE

As Figure 13-3 shows, the reference electrode is a piece of silver wire plated with silver chloride in contact with a concentrated solution of potassium chloride held in a glass or plastic tube. In many reference electrodes the solution is an aqueous gel, not a liquid. The potential of the reference electrode is controlled by the concentration of chloride in the filling solution. Because the chloride level is constant, the potential of the reference electrode is fixed. The potential does change if the temperature changes.

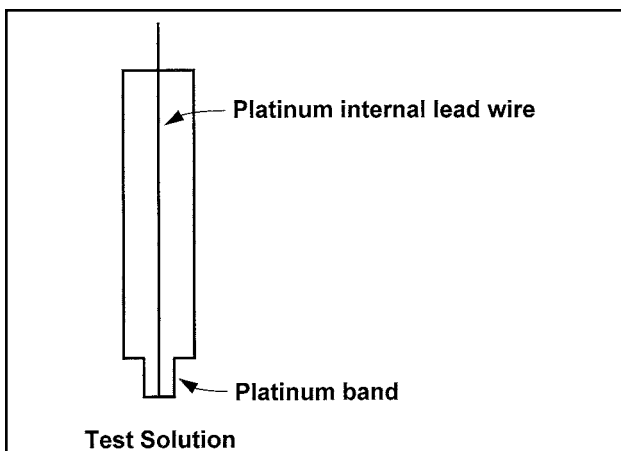

FIGURE 13-2. Measuring Electrode.

An ORP electrode is a piece of noble metal, usually platinum, but sometimes gold, attached to the end of a glass tube. The potential of the electrode is controlled by the ratio of oxidized to reduced substances in the sample. pH and other constituents in the sample may also affect ORP.

13.4 LIQUID JUNCTION POTENTIAL

A salt bridge (see Figure 13-3) is an integral part of the reference electrode. It provides the electrical connection between the reference electrode and the liquid being measured. Salt bridges take a variety of forms, anything from a glass frit to a wooden plug. Salt bridges are highly porous and the pores are filled with ions. The ions come from the filling solution and the sample. Some bridges permit only diffusion of ions through the junction. In other designs, a slow outflow of filling solution occurs. Migration of ions in the bridge generates a voltage, called the liquid junction potential. The liquid junction potential is in series with the measuring and reference electrode potentials and is part of the overall cell voltage.

Figure 13-4 helps illustrate how liquid junction potentials originate. The figure shows a section through a pore in the salt bridge. For simplicity, assume the bridge connects a solution of potassium chloride and hydrochloric acid of equal molar concentration. Ions from the filling solution and ions from the sample diffuse through the pores. Diffusion is driven by concentration differences. Each ion migrates from where its concentration is high to where its concentration is low. Because ions move at different rates, a charge separation develops. As the charge separation increases, electrostatic forces cause the faster moving ions to slow down and the slower moving ions to speed up. Eventually, the migration rates become equal, and the system reaches equilibrium. The amount of charge separation at equilibrium determines the liquid junction potential.

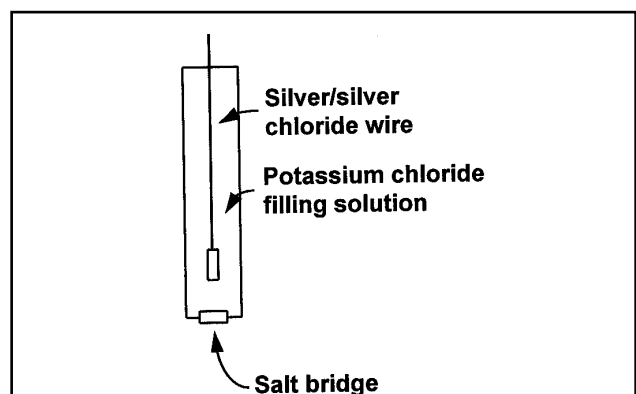

FIGURE 13-3. Reference Electrode.

The fixed concentration of chloride inside the electrode keeps the potential constant. A porous plug salt bridge at the bottom of the electrode permits electrical contact between the reference electrode and the test solution.

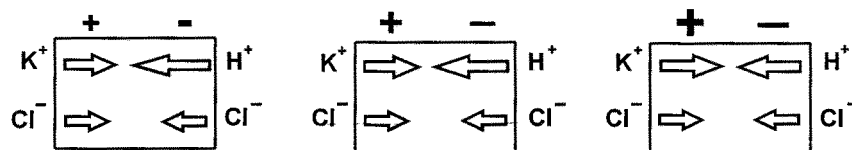

FIGURE 13-4. The Origin of Liquid Junction Potentials.

The figure shows a thin section through a pore in the junction plug. The junction separates a solution of potassium chloride on the left from a solution of hydrochloric acid on the right. The solutions have equal molar concentration. Driven by concentration differences, hydrogen ions and potassium ions diffuse in the directions shown. The length of each arrow indicates relative rates. Because hydrogen ions move faster than potassium ions, positive charge builds up on the left side of the section and negative charge builds up on the right side. The ever-increasing positive charge repels hydrogen and potassium ions. The ever-increasing negative charge attracts the ions. Therefore, the migration rate of hydrogen decreases, and the migration rate of potassium increases. Eventually the rates become equal. Because the chloride concentrations are the same, chloride does not influence the charge separation or the liquid junction potential.

Liquid junction potentials exist whenever dissimilar electrolyte solutions come into contact. The magnitude of the potential depends on the difference between the mobility of the ions. Although liquid junction potentials cannot be eliminated, they can be made small and relatively constant. A small liquid junction potential exists when the ions present in greatest concentration have equal (or almost equal) mobilities. The customary way of reducing junction potentials is to fill the reference electrode with concentrated potassium chloride solution. The high concentration ensures that potassium chloride is the major contributor to the junction potential, and the nearly equal mobilities of potassium and chloride ions makes the potential small.

13.5 RELATING CELL VOLTAGE TO ORP

The measured cell voltage, $E(T)$ —the notation emphasizes the temperature dependence—is the algebraic sum of the measuring (platinum) electrode potential, the reference electrode potential, and the liquid junction potential. Because the potential of the reference electrode is independent of ORP and the liquid junction potential is small, the measured cell voltage is controlled by the ORP of the sample. Stated another way, the cell voltage is the ORP of the sample relative to the reference electrode.

13.6 ORP, CONCENTRATION, AND pH

ORP depends on the relative concentration of oxidized and reduced substances in the sample and on the pH of the sample. An understanding of how concentration and pH influence ORP is necessary for the correct interpretation of ORP readings.

Figure 13-5 shows a platinum ORP electrode in contact with a solution of iron (II) and iron (III). As discussed earlier, iron (II) and iron (III) are a redox couple. They are related by the following half reaction:



If a redox couple is present, a stable electrical potential eventually develops at the interface between the platinum electrode and the sample. The magnitude of the potential

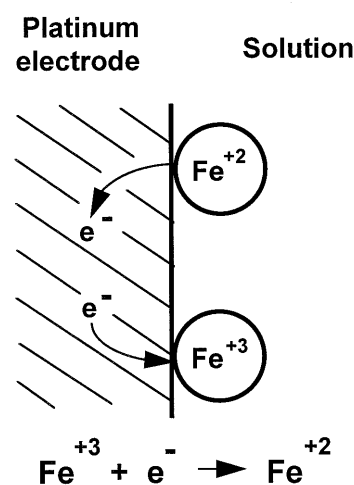

FIGURE 13-5. Electrode Potential.

The drawing shows an iron (II) and iron (III) ion at the surface of a platinum electrode. Iron (III) can take an electron from the platinum and be reduced, and iron (II) can place an electron on the metal and be oxidized. The electrode potential is the tendency of the half reaction shown in the figure to occur spontaneously. Because the voltmeter used to measure ORP draws almost no current, there is no change in the concentration of iron (II) and iron (III) at the electrode.

is described by the following equation, called the Nernst equation:

$$E = E^\circ - \frac{0.1987 (t + 273.15)}{n} \log \frac{[\text{Fe}^{+2}]}{[\text{Fe}^{+3}]} \quad (2)$$

In the Nernst equation, E is the electrode potential and E° is the standard electrode potential, both in millivolts, t is temperature in $^\circ\text{C}$, n is the number of electrons transferred ($n = 1$ in the present case), and $[\text{Fe}^{+2}]$ and $[\text{Fe}^{+3}]$ are the concentrations of iron (II) and iron (III) respectively. There are several ways of defining the standard electrode potential, E° . No matter which definition is used, the standard electrode potential is simply the electrode potential when the concentrations of iron (II) and iron (III) have defined standard values.

Equation 2 shows that the electrode potential is controlled by the logarithm of the ratio of the concentration of iron (II) to iron (III). Therefore, at 25°C if the ratio changes by a factor of ten, the electrode potential changes by

$$- \frac{0.1987 (25 + 273.15)}{1} \log 10 = - 59.2 \text{ mV}$$

As the expression above shows, the voltage change is also directly proportional to temperature and inversely proportional to the number of electrons transferred.

13.7 INTERPRETING ORP MEASUREMENTS

Interpreting ORP and changes in ORP requires great caution. There are several concepts to keep in mind concerning industrial ORP measurements.

- ORP is best used to track changes in concentration or to detect the presence or absence of certain chemicals. For example, in the treatment of wastes from metal finishing plants, chromium (VI) is converted to chromium (III) by treatment with sulfur dioxide. Because chromium (VI) and chromium (III) are a redox couple, ORP can be used to monitor the reaction. As sulfur dioxide converts chromium (VI) to chromium (III), the concentration ratio changes and the ORP drops. Once all the chromium (VI) has been converted to chromium (III) and a slight excess of sulfur dioxide is present, the chromium couple no longer determines ORP. Instead, ORP is controlled by the sulfur dioxide-sulfate couple. When sulfur dioxide reacts with chromium (VI), it is converted to sulfate. Figure 14-6 shows how ORP and the concentration of chromium (VI) change as sulfur dioxide is added. Because the change in ORP at the endpoint is large, monitoring ORP is an efficient way of tracking the process.

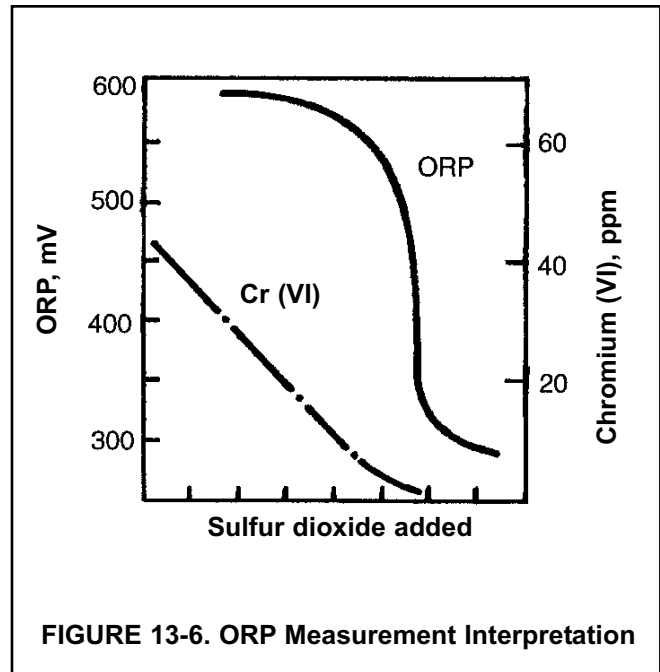
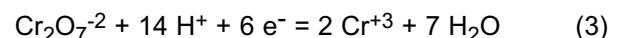

FIGURE 13-6. ORP Measurement Interpretation

- ORP measures activity, not concentration. Activity accounts for the way in which other ions in solution influence the behavior of the redox couple being measured. To be strictly correct, ORP is controlled by the the ratio of activities, not concentrations. The dependence of ORP on activity has an important consequence. Suppose a salt, like sodium sulfate, is added to a solution containing a redox couple, for example iron (II) and iron (III). The sodium sulfate does not change the concentration of either ion. But, the ORP of the solution does change because the salt alters the ratio of the activity of the ions.
- pH can have a profound influence on ORP. Referring to the earlier example where ORP was used to monitor the conversion of chromium (VI) to chromium (III). The reaction is generally carried out at about pH 2. Because the concentration ratio in the Nernst equation also includes hydrogen ions, the ORP of a mixture of chromium (VI) and chromium (III) is a function of pH.

To appreciate the extent to which pH influences ORP, consider the conversion of chromium (VI) to chromium (III). In acidic solution the half reaction is:



- Chromium (VI) exists as dichromate, $\text{Cr}_2\text{O}_7^{-2}$, in acidic solution.

The Nernst equation for reaction 3 is:

$$E = E^\circ - \frac{0.1987 (t + 273.15)}{6} \log \frac{[\text{Cr}^{+3}]^2}{[\text{Cr}_2\text{O}_7^{-2}] [\text{H}^+]^{14}} \quad (4)$$

Note that the hydrogen ion factor in the concentration ratio is raised to the fourteenth power. The table shows the expected effect of changing pH on the measured ORP at 25°C.

pH changes	ORP changes by
from 2.0 to 2.2	7 mV
from 2.0 to 2.4	35 mV
from 2.0 to 1.8	47 mV
from 2.0 to 1.6	75 mV

The Nernst equation can be written for any half reaction. However, not all half reactions behave exactly as predicted by the Nernst equation. Why real systems do not act as expected is beyond the scope of this discussion. The potential of chromium (VI) - chromium (III) couple used as an example above does not perfectly obey the Nernst equation. However, the statement that pH has a strong effect on the electrode potential of the couple is true.

- As mentioned earlier, ORP is best suited for measuring changes, not absolute concentrations. If ORP is used to determine concentration, great care should be exercised. An example is the determination of chlorine in water. When water is disinfected by treatment with chlorine gas or sodium hypochlorite, free chlorine forms. Free chlorine is a mixture of hypochlorous acid (HOCl) and hypochlorite ions (OCl⁻). The relative amount of hypochlorous acid and hypochlorite present depends on pH. For disinfection control, total free chlorine, the sum of hypochlorous acid and hypochlorite ion, is important. Equation 5 shows the half reaction for hypochlorous acid:

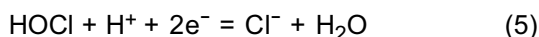

The Nernst equation is

$$E = E^\circ - \frac{0.1987 (t + 273.15)}{2} \log \frac{[\text{Cl}^-]}{[\text{HOCl}] [\text{H}^+]} \quad (6)$$

Only the concentration of hypochlorous acid appears in the Nernst equation. To use ORP to determine total free chlorine, equation 7 must be rewritten in terms of free

chlorine. Although the details are beyond the scope of this discussion, the result is shown in equation 7:

$$E = E^\circ - \frac{0.1987 (t + 273.15)}{2} \log \frac{[\text{Cl}^-] \{[\text{H}^+] + K\}}{C_a [\text{H}^+]^2} \quad (7)$$

where K is the acid dissociation constant for hypochlorous acid (2.3×10^{-8}) and C_a is the total free chlorine concentration. As equation 7 shows the measured ORP depends on the hydrogen ion concentration (i.e., pH), the chloride concentration, the free chlorine concentration, and temperature. Therefore, for ORP to be a reliable measurement of free chlorine, pH, chloride, and temperature must be reasonably constant.

Assume the free chlorine level is 1.00 ppm and the chloride concentration is 100 ppm. The table shows how slight changes in pH influence the ORP.

pH changes	ORP changes by
from 8.0 to 7.8	3.9 mV
from 8.0 to 7.6	7.1 mV
from 8.0 to 8.2	4.4 mV
from 8.0 to 8.4	9.2 mV

Around pH 8 and 1.00 ppm chlorine, a change in ORP of 1.4 mV corresponds to a change in chlorine level of about 0.1 ppm. Therefore, if pH changed only 0.2 units and the true chlorine level remained constant at 1.00 ppm, the apparent chlorine level (determined by ORP) would change about 0.3 ppm.

13.8 CALIBRATION

Although there is no internationally recognized ORP calibration standard, the iron (II) - iron (III) couple enjoys some popularity. The standard is a solution of 0.1 M iron (II) ammonium sulfate and 0.1 M iron (III) ammonium sulfate in 1 M sulfuric acid. The solution has good resistance to air oxidation. If stored in a tightly closed container, the shelf life is one year. Because the standard contains equal amounts of iron (II) and iron (III), the ORP does not change appreciably if the solution becomes slightly diluted. In addition, minor variability in actual concentration does not affect the standard ORP.

The ORP of the iron (II) - iron (III) standard when measured with a platinum electrode against a saturated silver-silver chloride reference is 476 ± 20 mV at 25°C. The range of values is caused primarily by the high and variable liquid junction potential generated in solutions containing high acid concentrations.

Quinhydrone - hydroquinone ORP standards are also used. They are prepared by dissolving excess quinhydrone in either pH 4.00 or pH 6.86 buffer. The ORP of the standards at a platinum electrode against a silver - silver chloride reference has been measured at 20°C, 25°C, and 30°C.

Temperature	ORP in pH 4.00 buffer	ORP in pH 6.86 buffer
20°C	268 mV	92 mV
25°C	263 mV	86 mV
30°C	258 mV	79 mV

There are two disadvantages to using quinhydrone standards. First, the shelf life is only about eight hours, so fresh standard must be prepared daily. Second, hydroquinone is highly toxic, so preparing, handling, and disposing of the standards requires care.

Unlike pH calibrations, which are generally done using two calibration buffers, ORP calibrations are almost always single point calibrations.

SECTION 14.0

THEORY - REMOTE COMMUNICATIONS

- 14.1 Overview of HART Communications
- 14.2 HART Interface Devices
- 14.3 AMS Communication

14.1 OVERVIEW OF HART COMMUNICATION

HART (highway addressable remote transducer) is a digital communication system in which two frequencies are superimposed on the 4 to 20 mA output signal from the transmitter. A 1200 Hz sine wave represents the digit 1, and a 2400 Hz sine wave represents the digit 0. Because the average value of a sine wave is zero, the digital signal adds no dc component to the analog signal. HART permits digital communication while retaining the analog signal for process control.

The HART protocol, originally developed by Fisher-Rosemount, is now overseen by the independent HART Communication Foundation. The Foundation ensures that all HART devices can communicate with one another. For more information about HART communications, call the HART Communication Foundation at (512) 794-0369. The internet address is <http://www.hartcomm.org>.

14.2 HART INTERFACE DEVICES

HART communicators allow the user to view measurement data (pH, ORP and temperature), program the transmitter, and download information from the transmitter for transfer to a computer for analysis. Downloaded information can also be sent to another HART transmitter. Either a hand-held communicator, such as the Rosemount Model 275, or a computer can be used. HART interface devices operate from any wiring termination point in the 4 - 20 mA loop. A minimum load of 250 ohms must be present between the transmitter and the power supply. See Figure 14-1.

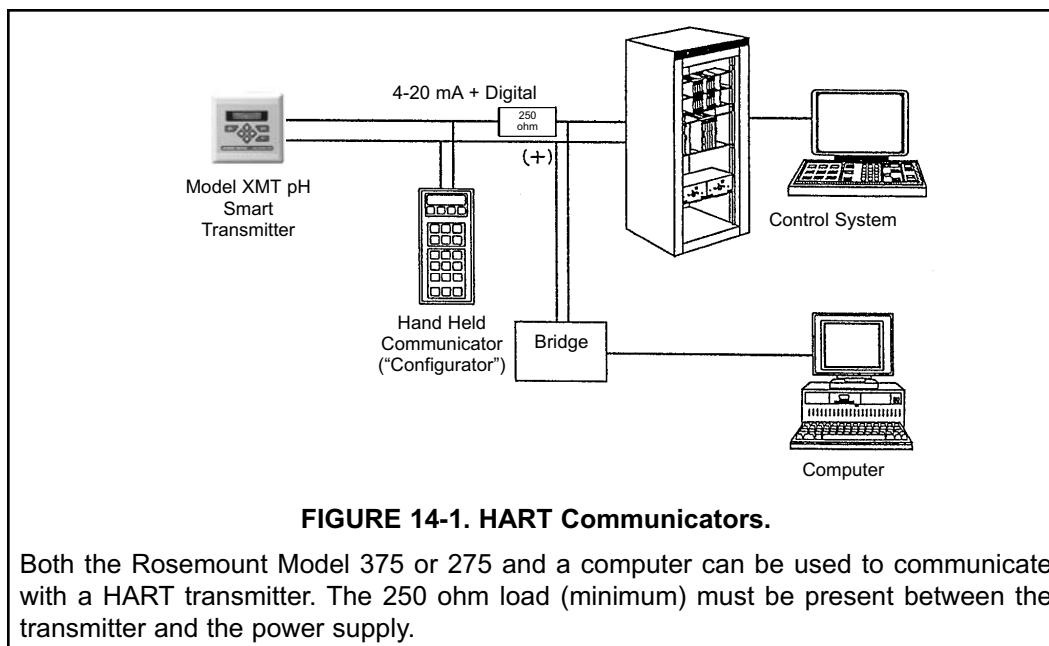

FIGURE 14-1. HART Communicators.

Both the Rosemount Model 375 or 275 and a computer can be used to communicate with a HART transmitter. The 250 ohm load (minimum) must be present between the transmitter and the power supply.

If your communicator does not recognize the Model XMT-P pH/ORP transmitter, the device description library may need updating. Call the manufacturer of your HART communication device for updates.

14.3 ASSET MANAGEMENT SOLUTIONS

Asset Management Solutions (AMS) is software that helps plant personnel better monitor the performance of analytical instruments, pressure and temperature transmitters, and control valves. Continuous monitoring means maintenance personnel can anticipate equipment failures and plan preventative measures before costly breakdown maintenance is required.

AMS uses remote monitoring. The operator, sitting at a computer, can view measurement data, change program settings, read diagnostic and warning messages, and retrieve historical data from any HART-compatible device, including the Model XMT-P pH/ORP transmitter. Although AMS allows access to the basic functions of any HART compatible device, Rosemount Analytical has developed additional software for that allows access to all features of the Model XMT-P pH/ORP transmitter.

AMS can play a central role in plant quality assurance and quality control. Using AMS Audit Trail, plant operators can track calibration frequency and results as well as warnings and diagnostic messages. The information is available to Audit Trail whether calibrations were done using the infrared remote controller, the Model 375 or 275 HART communicator, or AMS software.

AMS operates in Windows 95. See Figure 14-2 for a sample screen. AMS communicates through a HART-compatible modem with any HART transmitters, including those from other manufacturers. AMS is also compatible with FOUNDATION™ Fieldbus, which allows future upgrades to Fieldbus instruments.

For more information about AMS, including upgrades, renewals, and training, call Fisher-Rosemount Systems, Inc. at (612) 895-2000.

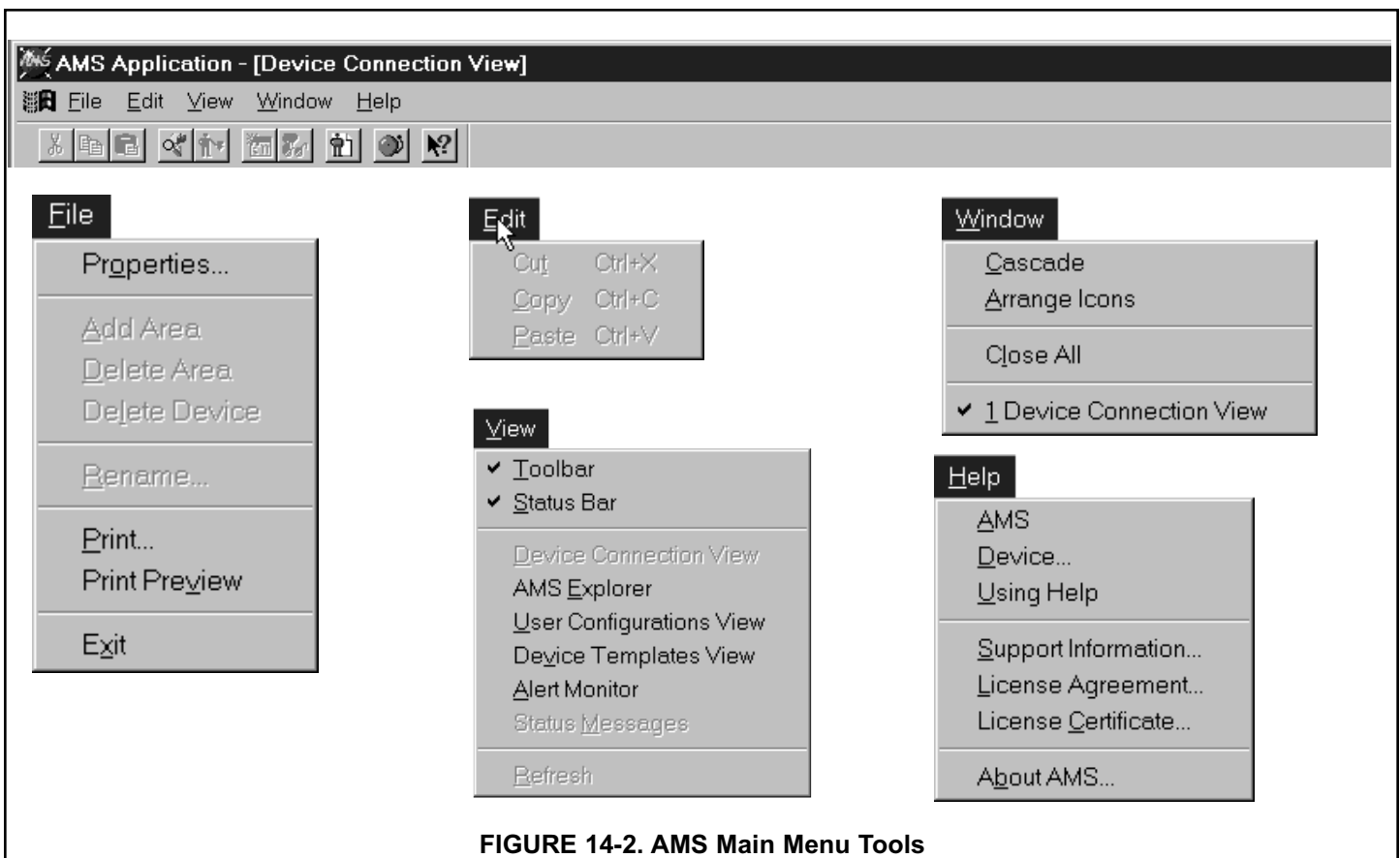

FIGURE 14-2. AMS Main Menu Tools

SECTION 15.0 RETURN OF MATERIAL

15.1 GENERAL.

To expedite the repair and return of instruments, proper communication between the customer and the factory is important. Call 1-949-757-8500 for a Return Materials Authorization (RMA) number.

15.2 WARRANTY REPAIR.

The following is the procedure for returning instruments still under warranty:

1. Call Rosemount Analytical for authorization.
2. To verify warranty, supply the factory sales order number or the original purchase order number. In the case of individual parts or sub-assemblies, the serial number on the unit must be supplied.
3. Carefully package the materials and enclose your "Letter of Transmittal" (see Warranty). If possible, pack the materials in the same manner as they were received.
4. Send the package prepaid to:

Emerson Process Management
Liquid Division
2400 Barranca Parkway
Irvine, CA 92606

Attn: Factory Repair

RMA No. _____

Mark the package: Returned for Repair

Model No. _____

15.3 NON-WARRANTY REPAIR.

The following is the procedure for returning for repair instruments that are no longer under warranty:

1. Call Rosemount Analytical for authorization.
2. Supply the purchase order number, and make sure to provide the name and telephone number of the individual to be contacted should additional information be needed.
3. Do Steps 3 and 4 of Section 15.2.

NOTE

Consult the factory for additional information regarding service or repair.

WARRANTY

Goods and part(s) (excluding consumables) manufactured by Seller are warranted to be free from defects in workmanship and material under normal use and service for a period of twelve (12) months from the date of shipment by Seller. Consumables, pH electrodes, membranes, liquid junctions, electrolyte, O-rings, etc. are warranted to be free from defects in workmanship and material under normal use and service for a period of ninety (90) days from date of shipment by Seller. Goods, part(s) and consumables proven by Seller to be defective in workmanship and / or material shall be replaced or repaired, free of charge, F.O.B. Seller's factory provided that the goods, parts(s), or consumables are returned to Seller's designated factory, transportation charges prepaid, within the twelve (12) month period of warranty in the case of goods and part(s), and in the case of consumables, within the ninety (90) day period of warranty. This warranty shall be in effect for replacement or repaired goods, part(s) and consumables for the remaining portion of the period of the twelve (12) month warranty in the case of goods and part(s) and the remaining portion of the ninety (90) day warranty in the case of consumables. A defect in goods, part(s) and consumables of the commercial unit shall not operate to condemn such commercial unit when such goods, parts(s) or consumables are capable of being renewed, repaired or replaced.

The Seller shall not be liable to the Buyer, or to any other person, for the loss or damage, directly or indirectly, arising from the use of the equipment or goods, from breach of any warranty or from any other cause. All other warranties, expressed or implied are hereby excluded.

IN CONSIDERATION OF THE STATED PURCHASE PRICE OF THE GOODS, SELLER GRANTS ONLY THE ABOVE STATED EXPRESS WARRANTY. NO OTHER WARRANTIES ARE GRANTED INCLUDING, BUT NOT LIMITED TO, EXPRESS AND IMPLIED WARRANTIES OF MERCHANTABILITY AND FITNESS FOR A PARTICULAR PURPOSE.

RETURN OF MATERIAL

Material returned for repair, whether in or out of warranty, should be shipped prepaid to:

**Emerson Process Management
Liquid Division
2400 Barranca Parkway
Irvine, CA 92606**

The shipping container should be marked:

Return for Repair

Model _____

The returned material should be accompanied by a letter of transmittal which should include the following information (make a copy of the "Return of Materials Request" found on the last page of the Manual and provide the following thereon):

1. Location type of service, and length of time of service of the device.
2. Description of the faulty operation of the device and the circumstances of the failure.
3. Name and telephone number of the person to contact if there are questions about the returned material.
4. Statement as to whether warranty or non-warranty service is requested.
5. Complete shipping instructions for return of the material.

Adherence to these procedures will expedite handling of the returned material and will prevent unnecessary additional charges for inspection and testing to determine the problem with the device.

If the material is returned for out-of-warranty repairs, a purchase order for repairs should be enclosed.



*The right people,
the right answers,
right now.*

ROSEMOUNT ANALYTICAL
CUSTOMER SUPPORT CENTER
1-800-854-8257



ON-LINE ORDERING NOW AVAILABLE ON OUR WEB SITE
<http://www.raihome.com>

Specifications subject to change without notice.

Credit Cards for U.S. Purchases Only.



Emerson Process Management

Liquid Division

2400 Barranca Parkway
Irvine, CA 92606 USA
Tel: (949) 757-8500
Fax: (949) 474-7250

<http://www.raihome.com>

