

1/16 - 1/8 - 1/4 DIN LIMIT CONTROLLERS CONCISE PRODUCT MANUAL (59333-1)

CAUTION: Installation should be only performed by technically competent personnel. Local Regulations regarding electrical installation & safety must be observed.

1. INSTALLATION

The models covered by this manual have three different DIN case sizes (refer to section 9). Some installation details vary between models. These differences have been clearly shown.

Note: The functions described in sections 2 thru 8 are common to all models.

Installing Option Modules

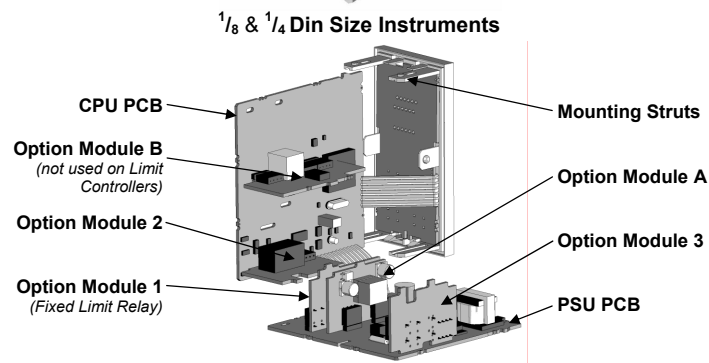
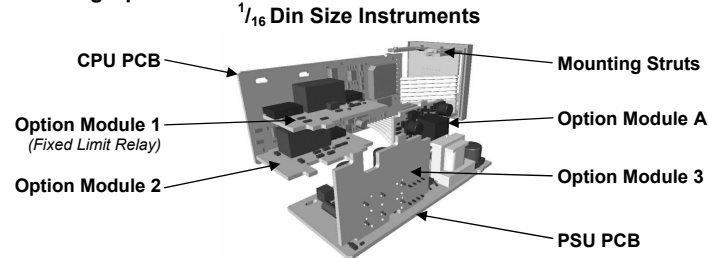

- To access module A, first detach the PSU and CPU boards from the front by lifting first the upper, and then lower mounting struts. Gently separate the boards.
- Plug the required option modules into the correct connectors, as shown below.
 - Locate the module tongues in the corresponding slot on the opposite board.
 - Hold the main boards together while relocating back on the mounting struts.
 - Replace the instrument by aligning the CPU and PSU boards with their guides in the housing, then slowly push the instrument back into position.

Note: Option modules are automatically detected at power up.

Option Module Connectors

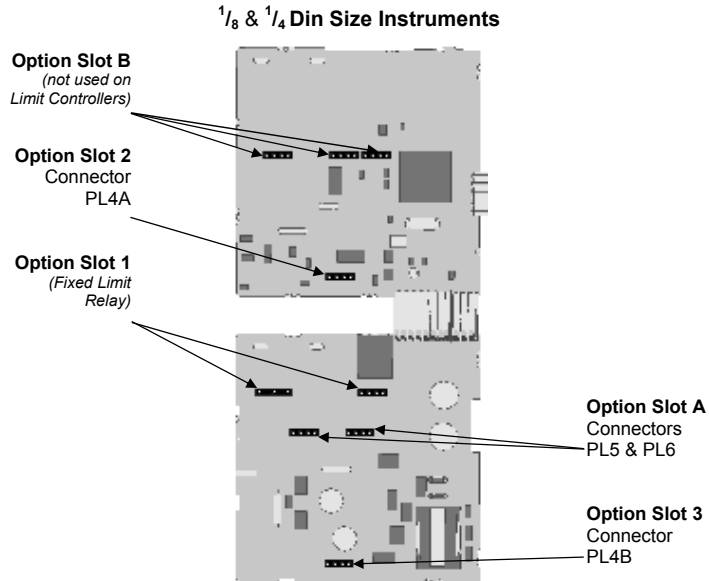
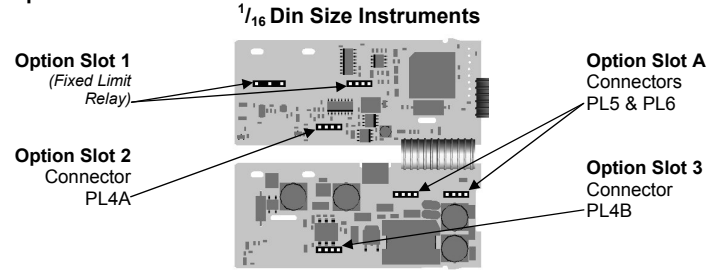

Panel-Mounting

The mounting panel must be rigid, and may be up to 6.0mm (0.25inch) thick. Cut-out sizes are:

Cut-Out Dim A
1/16 & 1/8 Din = 45mm
1/4 Din = 92mm

Cut-Out Dim B
1/16 Din = 45mm
1/8 & 1/4 Din = 92mm

For *n* multiple instruments mounted side-by-side, cut-out A is 48*n*-4mm (1/16 & 1/8 Din) or 96*n*-4mm (1/4 Din)

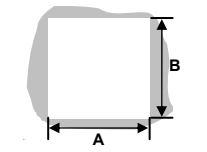

Tolerance +0.5, -0.0mm

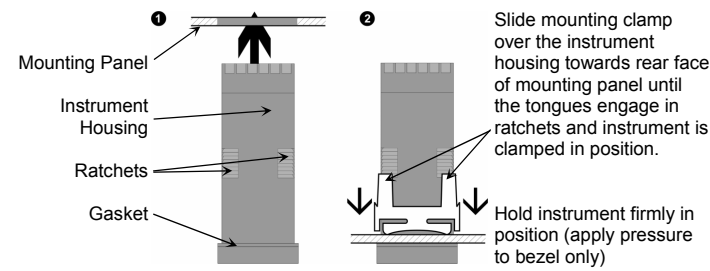

CAUTION: Do not remove the panel gasket; it is a seal against dust and moisture.

Rear Terminal Wiring

USE COPPER CONDUCTORS (EXCEPT FOR T/C INPUT)

Single Strand wire gauge: Max 1.2mm (18SWG)

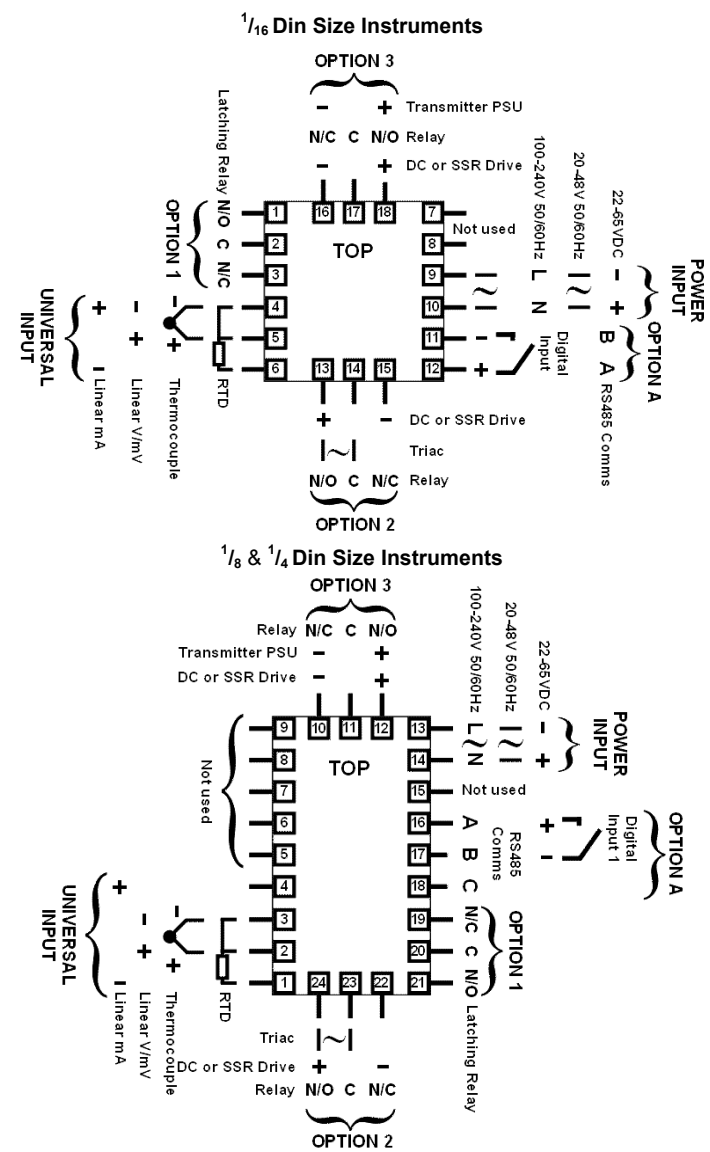

CAUTION: Check information label on housing for correct operating voltage before connecting supply to Power Input

Fuse: 100 - 240V ac - 1amp anti-surge
24/48V ac/dc - 315mA anti-surge

Note: At first power-up the message `Go to Conf` is displayed, as described in section 6 of this manual. Access to other menus is denied until configuration mode is completed

2. SELECT MODE

Select mode is used to access the configuration and operation menu functions. It can be accessed at any time by holding down `⏏` and pressing `⏏`. In select mode, press `⏏` or `⏏` to choose the required mode, press `⏏` to enter. An unlock code is required to prevent unauthorised entry to Configuration, & Setup modes. Press `⏏` or `⏏` to enter the unlock code, then press `⏏` to proceed.

Mode	Upper Display	Lower Display	Description	Default Unlock Codes
Operator	OPtr	SLct	Normal operation	None
Set Up	SEtP	SLct	Tailor settings to the application	10
Configuration	ConF	SLct	Configure the instrument for use	20
Product Info	inFo	SLct	Check manufacturing information	None

Note: The instrument will always return automatically to Operator mode if there is no key activity for 2 minutes.

3. CONFIGURATION MODE

First select Configuration mode from Select mode (refer to section 2). Press `⏏` to scroll through the parameters, then press `⏏` or `⏏` to set the required value. Press `⏏` to accept the change, otherwise parameter will revert to previous value. To exit from Configuration mode, hold down `⏏` and press `⏏` to return to Select mode.

Note: Parameters displayed depends on how instrument has been configured. Refer to user guide (available from your supplier) for further details. Parameters marked * are repeated in Setup Mode.

Parameter	Lower Display	Upper Display	Adjustment range & Description	Default Value	
Input Range/Type	inPt		See following table for possible codes	JC	
Code	Input Type & Range	Code	Input Type & Range	Code	Input Type & Range
bC	B: 100 - 1824 °C	LC	L: 0.0 - 537.7 °C	P24F	PIRh20% vs 40%: 32 - 3362 °F
bF	B: 211 - 3315 °F	LF	L: 32.0 - 999.9 °F	PtC	Pt100: -199 - 800 °C
cC	C: 0 - 2320 °C	nC	N: 0 - 1399 °C	PtF	Pt100: -328 - 1472 °F
cF	C: 32 - 4208 °F	nF	N: 32 - 2551 °F	PtC	Pt100: -128.8 - 537.7 °C
JC	J: -200 - 1200 °C	rC	R: 0 - 1759 °C	PtF	Pt100: -199.9 - 999.9 °F
JF	J: -328 - 2192 °F	rF	R: 32 - 3198 °F	0.20	0 - 20 mA DC
Jc	J: -128.8 - 537.7 °C	Sc	S: 0 - 1762 °C	4.20	4 - 20 mA DC
JF	J: -199.9 - 999.9 °F	Sf	S: 32 - 3204 °F	0.50	0 - 50 mV DC
Kc	K: -240 - 1373 °C	tC	T: -240 - 400 °C	10.50	10 - 50 mV DC
KF	K: -400 - 2503 °F	tF	T: -400 - 752 °F	0.5	0 - 5 V DC
Kc	K: -128.8 - 537.7 °C	tC	T: -128.8 - 400.0 °C	1.5	1 - 5 V DC
KF	K: -199.9 - 999.9 °F	tF	T: -199.9 - 752.0 °F	2.10	2 - 10 V DC
Lc	L: 0 - 762 °C	P24C	PIRh20% vs. 40%: 0 - 1850 °C		
Lf	L: 32 - 1403 °F				

Note: Decimal point shown in table indicates temperature resolution of 0.1°

Parameter	Lower Display	Upper Display	Adjustment range & Description	Default Value
Scale Range Upper Limit	ruL		Scale Range Lower Limit +100 to Range Maximum	Range max (Lin=1000)
Scale Range Lower Limit	rLL		Range Minimum to Scale Range Upper Limit -100	Range min (Linear=0)
Decimal point position	dPos		0=xxxx, 1=xxx.x, 2=xx.xx, 3=x.xxx (non-temperature ranges only)	1
Process Variable Offset	OFFS		±Span of controller (see CAUTION note at end of section)	0
Limit Action	Ctrl	H, Lo	High Limit. Limit relay is energised when process "safe" (PV < Limit Setpoint) Low Limit. Limit relay is energised when process "safe" (PV > Limit Setpoint)	H, Lo
Setpoint Upper Limit	SPuL		Current Setpoint to Scale Range maximum	R/max
Setpoint Lower Limit	SPLL		Scale Range minimum to Current Setpoint	R/min
Alarm 1Type	AL1	P_H, P_Lo, dE, bAnd, nonE	Process High Alarm Process Low Alarm Deviation Alarm Band Alarm No alarm	P_H, P_Lo
High Alarm 1 value*	PhA1		Scaled Range Minimum to scaled Range Maximum in display units	Range Max
Low Alarm 1 value*	PLA1			Range Min
Band Alarm 1 value*	bAL1		1 LSD to span from setpoint in display units	S
Dev. Alarm 1 value*	dAL1		+/- Span from setpoint in display units	S
Alarm 1 Hysteresis*	AHY1		1 LSD to full span in display units	1

Parameter	Lower Display	Upper Display	Adjustment range & Description	Default Value
Alarm 2 Type*	AL2			P_Lo
High Alarm 2 value*	PhA2			Range Max
Low Alarm 2 value*	PLA2			Range Min
Band Alarm 2 value*	bAL2		Options as for alarm 1	S
Dev. Alarm 2 Value*	dAL2			S
Alarm 2 Hysteresis*	AHY2			1
Output 2 Usage	USE2		Limit Output Relay Alarm 1, Direct Alarm 1, Reverse Alarm 2, Direct Alarm 2, Reverse Logical Alarm 1 OR 2, Direct Logical Alarm 1 OR 2, Reverse Logical Alarm 1 AND 2, Direct Logical Alarm 1 AND 2, Reverse Limit Annunciator, Direct Limit Annunciator, Reverse Retransmit Limit SP Output Retransmit PV Output	A_Ld, A_Lr, A2_d, A2_r, Or_d, Or_r, Ad_d, Ad_r, An_d, An_r, rEtS, rEtP
Linear Output 2 Range	tYP2		0 to 5 V DC output 1 0 to 10 V DC output 2 to 10 V DC output 0 to 20 mA DC output 4 to 20 mA DC output	0_10
Retransmit Output 2 Scale maximum	ro2H		-1999 to 9999 (display value at which output will be maximum)	Range max
Retransmit Output 2 Scale minimum	ro2L		-1999 to 9999 (display value at which output will be minimum)	Range min
Output 3 Usage	USE3		As for output 2	A_Ld
Linear Output 3 Range	tYP3		As for output 2	0_10
Retransmit Output 3 Scale maximum	ro3H		-1999 to 9999 (display value at which output will be maximum)	Range max
Retransmit Output 3 Scale minimum	ro3L		-1999 to 9999 (display value at which output will be minimum)	Range min
Display Strategy	d.SP	EnAb, d.SA	PV is visible in Operator mode PV not visible in Operator mode	EnAb
Serial Communications Protocol	Prot	r7bn, r7bE, r7bo	Modbus with no parity Modbus with Even Parity Modbus with Odd Parity	r7bn
Serial Communications Bit Rate	BRud	1.2, 2.4, 4.8, 9.6, 19.2	1.2 kbps 2.4 kbps 4.8 kbps 9.6 kbps 19.2 kbps	4.8
Comms Address	Addr		1 to 255 (Modbus), 1 to 99 (ASCII)	1
Comms Write	CoEr	r.W, r-D	Read/Write Read only	r.W
Configuration Lock Code	Loc		0 to 9999	20

Notes: Output 1 is always a Latching Limit Relay output. If Option Slot A has the Digital Input module fitted, this always functions as a Remote Reset, duplicating the function of the Reset key `⏏`.

As these functions cannot be changed, no Configuration menus are required.

CAUTION: Process Variable Offset can be used to modify the measured value to compensate for probe errors. Positive values increase the reading, negative values are subtracted. This parameter is effectively a calibration adjustment and MUST be used with care. There is no front panel indication of when this parameter is in use.

4. SETUP MODE

Note: Configuration must be completed before adjusting Setup parameters.
First select Setup mode from Select mode (refer to section 2). The Setup LED **S** will light while in Setup mode. Press **⏪** to scroll through the parameters, then press **⏩** or **⏴** to set the required value.
To exit from Setup mode, hold down **⏪** and press **⏴** to return to Select mode.
Note: Parameters displayed depends on how instrument has been configured.

Parameter	Lower Display	Upper Display Adjustment Range & Description	Default Value
Limit Setpoint value	SP	Scaled Range Minimum to scaled Range Maximum	R/max if $Ctrl=H$; R/min if $Ctrl=Lo$
Limit Hysteresis	HYS	1 LSD to full span in display units, on the safe side of the limit SP	1
Input Filter Time Constant	FIL	OFF or 0.5 to 100.0 secs (see CAUTION note below)	2.0
High Alarm 1 value	PHR1	Scaled Range Minimum to scaled Range Maximum	R/max
Low Alarm 1 value	PLR1	Scaled Range Maximum	R/min
Deviation Alarm 1 Value	dRAL1	±Span from SP in display units	5
Band Alarm 1 value	bAL1	1 LSD to span from setpoint	5
Alarm 1 Hysteresis	AHY1	1 LSD to full span in display units	1
High Alarm 2 value	PHR2	Scaled Range Minimum to scaled Range Maximum	R/max
Low Alarm 2 value	PLR2	Scaled Range Maximum	R/min
Deviation Alarm 2 Value	dRAL2	±Span from SP in display units	5
Band Alarm 2 value	bAL2	1 LSD to span from setpoint	5
Alarm 2 Hysteresis	AHY2	1 LSD to full span in display units	1
Setup Lock Code	SLoc	0 to 9999	10

Note: Operator mode screens follow, without exiting from Setup mode.

CAUTION: An excessively large filter time could significantly delay detection of a limit condition. Set this value to the minimum required to remove noise from the process variable

5. PRODUCT INFORMATION MODE

First select Product information mode from Select mode (refer to section 2). Press **⏪** to view each parameter. To exit from Product Information mode, hold down **⏪** and press **⏴** to return to Select mode.
Note: These parameters are all read only.

Parameter	Lower Display	Upper Display	Description
Input type	In_1	Un_1	Universal input
Option 1 type (fixed)	OPn1	rLY	Latching Limit Relay
Option 2 module type fitted	OPn2	nonE	No option fitted
		rLY	Relay output
		SSr	SSR drive output
		tr_1	Triac output
Option 3 module type fitted	OPn3	Lin	Linear DC voltage / current output
		nonE	No option fitted
		rLY	Relay output
		SSr	SSR drive output
Auxiliary Option A module type fitted	OPnA	Lin	Linear DC voltage / current output
		dc24	Transmitter power supply
		nonE	No option fitted
Firmware type	FLW	r485	RS485 communications
		dIG_1	Digital Input for remote reset
Firmware issue	ISS		Value displayed is firmware type number
Product Revision Level	PrL		Value displayed is firmware issue number
Date of manufacture	dDYY		Value displayed is Product Revision level
Serial number 1	Sn1		Manufacturing date code (mmyy)
Serial number 2	Sn2		First four digits of serial number
Serial number 3	Sn3		Middle four digits of serial number
			Last four digits of serial number

6. ERROR/FAULT INDICATIONS

Parameter	Upper Display	Lower Display	Description
Instrument parameters are in default conditions	GoTo	ConF	Configuration & Setup required. This screen is seen at first turn on, or if hardware configuration has been changed. Press ⏪ to enter the Configuration Mode, next press ⏩ or ⏴ to enter the unlock code number, then press ⏪ to proceed
Input Over Range	[HH]	Normal	Process variable input > 5% over-range
Input Under Range	[LL]	Normal	Process variable input > 5% under-range
Input Sensor Break	OPEN	Normal	Break detected in process variable input sensor or wiring
Option 1 Error	Err	OPn1	Option 1 module fault
Option 2 Error		OPn2	Option 2 module fault
Option 3 Error		OPn3	Option 3 module fault
Option A Error		OPnA	Option A module fault
Option B Error		OPnb	Option B not used on Limit Controllers this error is shown if any module is fitted

7. OPERATOR MODE

This mode is entered at power on, or accessed from Select mode (see section 2).
Note: All Configuration mode and Setup mode parameters must be set as required before starting normal operations.
Press **⏪** to scroll through the parameters.

Upper Display	Lower Display	Display Strategy and When Visible	Description
PV Value	Limit SP Value	d.SP = EnRb (initial screen)	PV and Limit Setpoint values Read only
Limit SP Value	(Blank)	d.SP = d.SR (initial screen)	Limit Setpoint value Read only
High Limit Hold	H.Hd	Ctrl = H	Highest PV value since this parameter was last reset. To reset, press ⏴ for 5 seconds, display = ---- when reset
Low Limit Hold	LoHd	Ctrl = Lo	Lowest PV value since this parameter was last reset. To reset, press ⏩ for 5 seconds, display = ---- when reset
Exceed Time Value	t_1	Always available Format mm.ss to 99.59 then mmm.s (10 sec increments) Shows [HH] if ≥999.9	Accumulated time of Limit SP exceed conditions since this parameter was last reset. To reset, press ⏴ for 5 seconds, display = ---- when reset
Active Alarm Status	ALSt	When one or more alarms are active, ALM indicator will also flash	Alarm 2 active Alarm 1 active Annunciator active

Exceed Condition

An Exceed Condition is when the Process Variable exceeds the Limit Setpoint value (i.e. PV > SP when set for high limit action, PV < SP for low limit action). The **EXCEED** LED is on during this condition, and is extinguished once it has passed.

Limit Output Function

Limit Output relay(s) de-energise whenever an Exceed condition occurs, causing the process to shut down. The **OUT** LED is on when the relay is de-energised. The relay remains latched off even if the Exceed condition is no longer present. Only giving a reset instruction (after the exceed condition has passed) will re-energise the relay, allowing the process to continue. The **OUT** LED then turns off.

Limit Annunciator Outputs

An Annunciator output will activate when an Exceed condition occurs, and will remain active until a reset instruction is received, or the Exceed condition has passed. Unlike the Limit Output, an Annunciator can be reset even if the Exceed condition is present. When an Annunciator is active, the **ANN** LED will flash and the Alarm Status screen is available.

Resetting Limit Outputs & Annunciators

A reset instruction can be given by pressing the **RESET** key, via the Digital Input (if fitted) or via a Comms command if an RS485 Communications module is fitted. Annunciators will deactivate. Limit Outputs will only re-energise if the Exceed condition has passed.

CAUTION: Ensure that the cause of the Exceed condition has been rectified before resetting the Limit Output.

8. SERIAL COMMUNICATIONS

Refer to the full user guide (available from your supplier) for details.

9. SPECIFICATIONS

UNIVERSAL INPUT

Thermocouple: ±0.1% of full range, ±1LSD (±1°C for Thermocouple CJC).
Calibration: BS4937, NBS125 & IEC584.
PT100 Calibration: ±0.1% of full range, ±1LSD.
BS1904 & DIN43760 (0.00385/Ω°C).

DC Calibration: ±0.1% of full range, ±1LSD.

Sampling Rate: 4 per second.

Impedance: >10MΩ resistive, except DC mA (5Ω) and V (47kΩ).

Sensor Break Detection: Thermocouple, RTD, 4 to 20 mA, 2 to 10V and 1 to 5V ranges only. Limit outputs turn off (goes into Exceed condition), high alarms activate for thermocouple/RTD sensor break, low alarms activate for mA/V DC sensor break.

Isolation: Isolated from all outputs (except SSR driver).

Universal input must not be connected to operator accessible circuits if relay outputs are connected to a hazardous voltage source. Supplementary insulation or input grounding would then be required.

DIGITAL INPUT

Volt-free(or TTL): Open(2 to 24VDC) =No Reset.
Closed(<0.8VDC) = Reset (edge triggered).

Isolation: Reinforced safety isolation from inputs and other outputs.

OUTPUTS

Limit Relay

Contact Type & Rating: Latching limit control relay. Single pole double throw (SPDT); 5A resistive at 120/240VAC. Slot 1 position fixed for this function, optional function for Slot 2 & 3 relay modules.

Lifetime: >100,000 operations at rated voltage/current.

Isolation: Basic Isolation from universal input and SSR outputs.

Alarm Relays

Contact Type & Rating: Slot 2 or 3 position non-latching alarm relay. Single pole double throw (SPDT); 2A resistive at 120/240VAC.

Lifetime: >500,000 operations at rated voltage/current.

Isolation: Basic Isolation from universal input and SSR outputs.

SSR Driver

Drive Capability: SSR drive voltage >10V into 500Ω min.

Isolation: Not isolated from universal input or other SSR driver outputs.

Triac

Operating Voltage: 20 to 280Vrms (47 to 63Hz).

Current Rating: 0.01 to 1A (full cycle rms on-state @ 25°C); derates linearly above 40°C to 0.5A @ 80°C.

Isolation: Reinforced safety isolation from inputs and other outputs.

DC

Resolution: 8 bits in 250mS (10 bits in 1s typical, >10 bits in >1s typical).

Isolation: Reinforced safety isolation from inputs and other outputs.

Transmitter PSU

Power Rating: 20 to 28V DC (24V nominal) into 910Ω minimum resistance.

Isolation: Reinforced safety isolation from inputs and other outputs.

SERIAL COMMUNICATIONS

Physical: RS485, at 1200, 2400, 4800, 9600 or 19200 bps.

Protocols: Selectable between Modbus and West ASCII.

Isolation: Reinforced safety isolation from all inputs and outputs.

OPERATING CONDITIONS (FOR INDOOR USE)

Ambient: 0°C to 55°C (Operating), -20°C to 80°C (Storage).

Temperature:

Relative Humidity: 20% to 95% non-condensing.

Supply Voltage and Power: 100 to 240VAC ±10%, 50/60Hz, 7.5VA (for mains powered versions), or 20 to 48VAC 50/60Hz 7.5VA or 22 to 65VDC 5W (for low voltage versions).

ENVIRONMENTAL

Standards: CE, UL, ULC & FM 3545, 1998

EMI: Complies with EN61326 (Susceptibility & Emissions).

Safety: Complies with EN61010-1 & UL3121.

Considerations: Pollution Degree 2, Installation Category II.

Front Panel Sealing: To IP66 (IP20 behind the panel).

PHYSICAL

Front Bezel Size: 1/16 Din = 48 x 48mm, 1/8 Din = 96 x 48mm, 1/4 Din = 96 x 96mm.

Depth Behind Panel: 1/16 Din = 110mm, 1/8 & 1/4 Din = 100mm.

Weight: 0.21kg maximum.