

PIE 525-Plus

Diagnostic Thermocouple RTD & Milliamp Calibrator

Operating Instructions



Practical Instrument Electronics

Tel: 585.872.9350 • Fax: 585.872.2638 • sales@piecal.com • www.piecal.com

Contents

General Operations

Connections	4
Accessories.....	5
Carrying Case, Boot, and Magnet Strap.....	6
Changing Batteries & Storing EZ-CHECK Outputs	7

Basic Operation

Switches & Knobs.....	8-9
MAIN Menus - Functions, Units & Ranges	10-11
Display Resolution & Troubleshooting Settings.....	12
Milliamp Display for RTD, Thermocouple, V & Ohms	13
FEATURE Menu - Stepping & Ramping / Auto Off	14
FEATURE Menu - Stepping & Ramping / Backlight	15

Functions and Hookup Diagrams

Millivolt

Source mV; Read mV	16,17
--------------------------	-------

Thermocouple

Source T/C & Read T/C Sensors.....	18,19
------------------------------------	-------

Resistance

Source Resistance, Read Resistance.....	20, 21
---	--------

RTD

Source RTD & Read RTD Sensors.....	22, 23
------------------------------------	--------

Troubleshooting

Troubleshooting RTD Instruments	24
Troubleshooting Thermocouple Sensors.....	26
Troubleshooting RTD Sensors	28

Milliamp

Source mA	30
Read mA	31
Power/Measure mA.....	32
Simulate 2-Wire Transmitters	33
Calibrate 2-Wire Temperature Transmitters.....	34
Using Ground Leak Detection.....	36

Specifications

General	38-41
Thermocouple Ranges & Accuracies.....	42-44
RTD Ranges & Accuracies	46-47

Warranty

Warranty & Additional Information	49
---	----

Calibrate all your T/C, RTD & mA Instruments

- **Easy to use**

Single calibrator that combines ALL the functions of a diagnostic milliamp calibrator with the accuracy of a laboratory thermocouple and RTD calibrator.

- **Protect instruments & technicians from (potentially dangerous) catastrophic failures due to hidden loop problems**

Quickly diagnose ground fault and current leakage often caused by water in conduits and junction boxes with patented loop diagnostic technology (US Patent# 7,248,058).

- **Calibrate T/C instruments to 0.1 & 0.01 °F & °C**

The PIE 525Plus works with the thermocouples you use including types J, K, T, E, R, S, B, N, G, C, D, L (J-DIN), U (T-DIN) and P (Platinel II). Or calibrate from -13.0000 to +80.0000 mV.

- **Calibrate RTD instruments to 0.1 & 0.01 °F & °C**

Stop carrying around a decade box and RTD resistance tables. The 525Plus works with the RTDs you use including Platinum 10, 50, 100, 200, 500 & 1000 Ohm ($\alpha = 3850$), Platinum 100 Ohm ($\alpha = 3902, 3916, 3926$), Copper 10 & 50 Ohm, and Nickel 120 Ohm. Or calibrate from 0.000 to 400.000 and 0.00 to 4000.00 Ohms.

- **Fast calibration with automatic output stepping**

Easily set any value quickly to within 0.1° or 0.01° with the adjustable digital potentiometer "DIAL" plus store any three temperatures for instant recall with the EZ-CHECK™ switch. Choose between 2, 3, 5, 11 steps and ramp to automatically increment the output in 100%, 50%, 25%, 10% or 5% of span. Select step time from 5, 6, 7, 8, 9, 10, 15, 20, 25, 30 & 60 seconds.

- **Compatible with ALL process instruments**

No competitor's calibrator is compatible with as many process instruments! Connect directly to the temperature inputs of transmitters, PLCs, DCS & multichannel recorders to verify their outputs or displays. RTD simulation works with older instruments with fixed excitation currents and newer multichannel instruments that switch the excitation current between input channels.

- **Measure thermocouple & RTD sensors**

The PIE 525Plus measures probes to 0.1 or 0.01 $^{\circ}\text{C}$ or $^{\circ}\text{F}$. For thermocouples a secondary display shows the millivolts corresponding to the sensor temperature. Also displays the cold junction temperature measured by the calibrator.

For RTDs a secondary display shows the resistance corresponding to the sensor temperature.

- **Find problems with troubleshooting tools**

Troubleshoot thermocouple probes by measuring the resistance of the cables and sensing element. Probes with high resistance should be replaced before they burn out. Open thermocouples and thermocouples that have high resistance indicating impending failure are indicated by OPEN TC and the resistance value on the display.

Troubleshoot RTD sensor connections and find broken wires with patented technology. Connect your two, three or four wire RTDs and the PIE 525Plus automatically detects the connections.

For troubleshooting RTD measuring instruments the 525Plus displays the fixed or pulsed sensor excitation current outputted by the instrument.

- **Calibration Lab Accurate & Stable**

The internal cold junction thermistor is accurate to $\pm 0.05^{\circ}\text{C}$ and is traceable to NIST. A stable voltage reference and low drift components make it more accurate than most other TC calibrators.

- **Perform Heat Treating Uniformity Surveys and System Accuracy Tests**

The PIE 525Plus is capable of meeting the requirements of an AMS 2750 Field Test Instrument when certified by an accredited laboratory.

Become a troubleshooting technician with Patented Diagnostic Technology - Available only with PIE Calibrators!

Connections

Simulating or reading thermocouples requires the use of thermocouple or extension grade thermocouple wire. Plug thermocouple wires into the miniature thermocouple jack.

The PIE 525Plus has two banana jacks (1+ & 2-) mounted in the top end of the housing. These are not temperature compensated and are to be used only for millivolt signals or thermocouple signals with the cold junction turned off. The two banana jacks (5+ and 6-) are for all milliamp signals.



Simulating or reading RTDs uses copper wire.

Plug 2, 3 or 4 wires into the corresponding jacks on the calibrator. For RTD source the PIE 525Plus simulates the (+) RTD from jacks 1 & 4 and the (-) RTD from jacks 2 & 3.

When reading an RTD sensor the PIE 525Plus uses patented circuitry to automatically detect if 2, 3 or 4 wires are connected. This is helpful to troubleshoot sensor connection (see Troubleshooting an RTD Sensor).



Accessories

INCLUDED:

Four "AA" Alkaline batteries, Certificate of Calibration	
Evolution Hands Free Carrying Case	Part No. 020-0211
Dark Blue Rubber Boot	Part No. 020-0213
Test Leads - one pair with banana plug & alligator clips	Part No. 020-0207
Evolution RTD Wire Kit	Part No. 020-0208
2 Red & 2 Black Leads with Banana Plugs & Spade Lugs	

OPTIONAL:

Ni-MH 1 Hour Charger with 4 Ni-MH AA Batteries (100-120 V AC input for North America Only)	Part No. 020-0103
T/C Wire Kit 1* for Types J, K, T & E	Part No. 020-0202
T/C Wire Kit 2* for Types B, R/S & N	Part No. 020-0203

*Three feet (1 meter) of T/C extension wire, stripped on one end with a miniature T/C male connector on the other end.

Magnet Strap	Part No. 020-0236
--------------	-------------------

Operating Instructions

FIELD & BENCH USE

PIE 525Plus comes with a carrying case designed for hands-free operation and a rubber boot with a built-in tilt stand. The PIE 525Plus is held in the case by elastic straps for use with the carrying case open. The tilt stand is easily raised by pulling the stand until it locks into place.



Deluxe Hands Free Carrying Case (Included)



Magnetic Hanging Strap (020-0236 Optional)



CHANGING BATTERIES

Low battery is indicated by a battery symbol on the display. Approximately one to four hours of typical operation remain before the PIE 525Plus will automatically turn off. To change the batteries remove the rubber boot and remove the battery door from the back of the unit by sliding the door downward. This allows access to the battery compartment. Replace with four (4) "AA" 1.5V batteries being careful to check the polarity. Replace the battery door and replace the boot. All stored configuration options (T/C Type, EZ-CHECK Memories, etc.) are reset to factory settings when the batteries are removed.

Note: Alkaline batteries are supplied and recommended for typical battery life and performance. Optional rechargeable batteries (charged externally) are available.

STORING HI and LO EZ-CHECK Source Outputs

Speed up your calibration by storing Span & Zero output setting for instant recall with the EZ-CHECK switch.

- 1) Store your high (SPAN) output temperature by moving the EZ-CHECK switch to the **HI** position and turning the EZ-Dial knob until the desired output value is on the display. Press and hold the EZ-Dial knob until **STORED** appears to store the value. Release the EZ-Dial knob.
- 2) Store your low (ZERO) output value by moving the EZ-CHECK switch to the **LO** position and turning the EZ-Dial knob until the desired output value is on the display. Press and hold the EZ-Dial knob until **STORED** appears to store the value. Release the EZ-Dial knob.
- 3) Instantly output your SPAN and ZERO output settings by moving the EZ-CHECK switch between HI and LO. You may also select any third output setting (such as mid-range) using the SET position on the EZ-CHECK switch.

Operating Instructions

Basic Operation

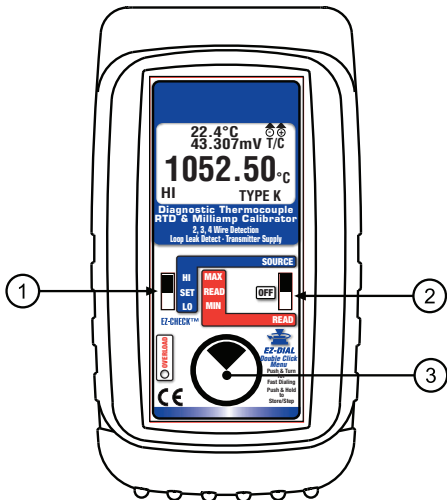

① EZ-CHECK™ SWITCH

SOURCE: Instantly output two preset settings by moving the EZ-CHECK™ switch to the “LO” position or “HI” position. For fast three point checks select the “SET” position. The PIE 525Plus will remember the last “SET” value, even with the power off. These values can easily be changed to suit the calibration requirements. The values stored in the HI and LO positions are also used for Auto Stepping.

READ: Slide the switch to the SET position. The PIE 525Plus will display the current reading from the sensor or device being measured. Slide the switch to MAX and the highest value measured since turn-on or reset will be displayed; slide the switch to MIN and the lowest value measured since turn-on or reset will be displayed.

Operating Instructions

Basic Operation

② SOURCE/OFF/READ Switch

Select “**SOURCE**” to output mV, T/C, Ω or RTD and output/2-Wire simulate mA.

Select “**READ**” to read mA, mV, T/C, Ω or RTD and read/Power-Measure mA.

Select “**OFF**” to turn off the 525Plus.

③ EZ-DIAL™ KNOB

SOURCE: Turn the knob to adjust the output level. Turn clockwise to increase the output, counter clockwise to decrease the output in one least significant digit step at a time. Push down and turn the EZ-DIAL knob for faster dialing.

Press and hold the knob for two seconds to store desired EZ-Check™ HI/LO points in SOURCE mode. Continue to press and hold the knob for two more seconds to start the automatic ramping.

READ: Press and hold to transfer the current temperature into the EZ-Check™ MIN/MAX points. This clears the MIN/MAX readings which will update as the input value changes.

SELECTING FUNCTIONS

The EZ-DIAL knob is used to setup the PIE 525Plus to match the instrument to be calibrated or signal to be measured. Each time you turn it on it displays the following screen for about 1 second followed by operating in the function used the last time it was operated.

**DOUBLE CLICK
EZ-DIAL KNOB
FOR CONFIGURATION
V ###.##**

Double Click the EZ-DIAL knob to change the function of the calibrator and to select ranges, units and other user settings. Each function (mV, T/C, Ohms, RTD) has up to three pages of menus. The first menu page has settings for the function and the last menu page has settings for STEPPING, AUTO OFF and BACKLIGHT. Settings are remembered even with the power off but are reset when the batteries are changed.

Operating Instructions

Double Click Menus - MAIN Page

Double click the EZ-DIAL knob to access the Double Click Menus. Shown are the **MAIN** menus for each function. Turn the knob to scroll thru the menus and press the knob to select. Default values are in black and available choices are shown in grey.

Source V

>EXIT	(1/4)
FUNCTION	V
RANGE	80mV

Read V

>EXIT	(1/3)
FUNCTION	V
RANGE	80mV

Source & Read Thermocouples

>EXIT	(1/4 for SOURCE, 1/3 for READ)
FUNCTION	T/C
UNITS	°C °F
T/C TYPE	J K E T R S B N L U G C D P
COLD JUNC	ON OFF

Source Ohms

>EXIT	(1/4)
FUNCTION	OHMS
RANGE	400Ω 4000Ω

Read Ohms

>EXIT	(1/3)
FUNCTION	OHMS
RANGE	400Ω 4000Ω

Source RTD

>EXIT	(1/4)
FUNCTION	RTD
UNITS	°C °F
RTD	Pt 100 $\alpha=3850$ [*RTD Types - See Read RTD]

Read RTD

>EXIT	(1/3)
FUNCTION	RTD
UNITS	°C °F
RTD	Pt 100 $\alpha=3850$, Pt 200 $\alpha=3850$, Pt 500 $\alpha=3850$, Pt 1000 $\alpha=3850$, Pt 100 $\alpha=3902$, Pt 100 $\alpha=3916$, Pt 100 $\alpha=3926$, Cu 10 $\alpha=4274$, Cu 50 $\alpha=4280$, Ni 120 $\alpha=6720$ Pt 10 $\alpha=3850$, Pt 50 $\alpha=3850$

Operating Instructions

Double Click Menus - MAIN Page

Source mA & Simulate 2 Wire Transmitters

MAIN	
> EXIT (1/2)	
FUNCTION	mA
mA MODE	SOURCE 2W SIM
UNITS	mA %
HART 250Ω	ON OFF

Read mA, Power/Measure Transmitters & Leak Detect

MAIN	
> EXIT (1/2)	
FUNCTION	mA
mA MODE	READ PWR MEAS
UNITS	mA %
HART 250Ω	ON OFF

Turn the ③ DIAL KNOB to move through the two to four pages of menus. Press the ③ DIAL KNOB to toggle between **OFF** and **ON** or to scroll through the settings.

Operating Instructions

Double Click Menu - DISPLAY Page

Double click the ③ DIAL KNOB at any time the unit is on and then turn the ③ DIAL KNOB to move to the second menu page so the word **DISPLAY** appears at the top of the menu.

Turn the ③ DIAL KNOB to move through the menu. Press the ③ DIAL KNOB to toggle between LOW and HIGH or OFF and ON.

LOW resolution is 0.001 mV, 0.01 Ω in 400 Ω Range, 0.1 Ω in 4000 Ω Range and 0.1° for T/C & RTD. HIGH resolution is 0.0001 mV, 0.001 Ω in 400 Ω Range, 0.01 Ω in 4000 Ω Range and 0.01° for T/C & RTD. Milliamp always has resolution of 0.001 mA/0.01%.

V DISPLAY

- > EXIT (2/4 SOURCE, 2/3 READ)
RESOLUTION LOW HIGH

T/C DISPLAY

- > EXIT (2/4 SOURCE, 2/3 READ)
RESOLUTION LOW HIGH
DISPLAY mV OFF ON
DISPLAY CJ OFF ON [Cold Junction Temperature]
TC PROBE Ω OFF ON [Probe Resistance - Read Only]

OHMS DISPLAY

- > EXIT (2/4 SOURCE, 2/3 READ)
RESOLUTION LOW HIGH
SENSOR mA* OFF ON

RTD DISPLAY

- > EXIT (2/4 SOURCE, 2/3 READ)
RESOLUTION LOW HIGH
DISPLAY OHMS OFF ON
SENSOR mA* OFF ON [Source Ohm & RTD Only]

EXIT MENU - exits this menu immediately and saves any changes. Menu will automatically exit after 15 seconds of inactivity. Settings are remembered even with the power off.

Operating Instructions

Double Click Menu - mA Display

mA MODE - pressing the knob will cycle through **READ**, **PWRM**, **READ%**, **PWRM%** and **OFF**.

mA DISPLAY (For RTD, T/C, V & OHMS)

> **EXIT (3/4) [SOURCE ONLY]**
mA MODE **OFF** **READ** **PWRM** **READ%** **PWRM%**
HART 250Ω **ON** **OFF**
LEAK DETECT **OFF** **ON**

READ turns on the mA display and indicates current passing through the loop proportional to the input of the transmitter which is controlled by the output of the 525Plus. Choose **READ%** to display in percent of 4-20 milliamps.

PWRM is POWER MEASURE which uses the internal loop supply of the 525Plus to power up the transmitter while indicating the current passing through the loop proportional to the input of transmitter which is controlled by the output of the 525Plus. Choose **PWRM%** to display in percent of 4-20 milliamps.

If **PWRM** or **PWRM%** is selected an additional menu selection of **LEAK DETECT** will appear. When **LEAK DETECT** is turned on the 525Plus will display **LEAK** and the amount of current that is uncontrolled in the loop. This may be due to a faulty transmitter, corrosion causing a bridge to ground or moisture present at some connection point. When **LEAK DETECT** tests a loop with leakage the loop mA signal will be affected.

HART 250Ω - turn on the 250Ω resistor if you are powering up a HART transmitter. This provides the loop load required for HART communication.

Operating Instructions

Double Click Menu - FEATURES

To change the Automatic Stepping settings

Double click the ③ DIAL KNOB at any time the unit is on and the following typical display (will be different for each FUNCTION) will appear for 15 seconds:

MAIN	
> EXIT (1/3)	
FUNCTION	T/C
UNITS	°C
T/C TYPE	J
COLD JUNC	ON

Turn the ③ DIAL KNOB to move to the third menu page for T/C, RTD, V & Ohms or the second menu page for mA so the word **FEATURES** appears at the top of the menu.

FEATURES	
> EXIT (2 or 3/2,3 or 4)	
AUTO OFF	ON
BACKLIGHT	ON
STEPS/RAMP	3 [SOURCE ONLY]
STEP/RAMP TIME	5 [SOURCE ONLY]

Turn the ③ DIAL KNOB to move through the menu. Press the ③ DIAL KNOB to toggle between OFF and ON or to change the STEPS/RAMP and the STEP/RAMP TIME settings. These settings are remembered even with the power off.

EXIT MENU - exits this menu immediately and saves any changes. Menu will automatically exit after 15 seconds of inactivity.

AUTO OFF - If AUTO OFF is ON, the unit will turn off after 30 minutes of inactivity to save battery life. If AUTO OFF is OFF the unit will stay on until the POWER SWITCH is moved to the off position.

Operating Instructions

Double Click Menu - FEATURES

STEPS/RAMP - pressing the knob will cycle through 2, 3, 5, 11 and RAMP. The endpoints of the steps or ramp are based on the values stored in the **HI** and **LO** EZ-CHECK outputs.

2 steps will automatically switch between the values stored in the HI & LO EZ-CHECK (0 & 100%).

3 steps between the HI, Midpoint and LO EZ-CHECK (0, 50 & 100%).

5 steps between the HI and LO EZ-CHECK in 25% increments (0, 25, 50, 75 & 100%).

11 steps between the HI and LO EZ-CHECK in 10% increments (0, 10, 20...80, 90 & 100%).

RAMP continuously ramps up and down between the HI and LO EZ-CHECK outputs.

STEP/RAMP TIME - pressing the knob will cycle through 5, 6, 7, 8, 9, 10, 15, 20, 25, 30 and 60 seconds.

To start the Automatic Stepping

Start automatic stepping or ramping by placing the EZ-CHECK Switch into the HI or LO position then press and hold the ③ DIAL KNOB for 6 seconds (the word STORE will appear on the display after 3 seconds and continue to press the EZ-DIAL KNOB) until the word STEPPING appears on the display. The word STEPPING will appear on the display anytime the selected automatic function is running. Stop the stepping by again pressing and holding the ③ DIAL KNOB for 6 seconds.

BACKLIGHT - If BACKLIGHT is ON the backlight will light all the time the unit is powered up. For maximum battery life turn the backlight off when using the calibrator in areas with enough ambient light to read the display.

SOURCE mV

Choose this function to provide an output from -13.000 to 80.000 mV in LOW resolution and -13.0000 to 80.0000 mV in HIGH resolution. The source current is a nominal 12 mA to provide the driving power to analog thermocouple meters.

Move the power switch ② to SOURCE then Double Click the EZ-DIAL knob to get into the Menu. Turn the knob to scroll through the settings and press the knob to make your selection. Select V for the FUNCTION.

Connect the output leads of the PIE 525Plus to the inputs of the device being calibrated, making sure to check polarity. Red lead to the plus (+) input and black lead to the minus (-) input.

Instantly output your SPAN and ZERO output settings by moving the EZ-CHECK switch between HI and LO. You may also select any third output setting (such as mid-range) using the SET position on the EZ-CHECK switch. The output is adjusted in 0.001 mV increments in LOW and 0.0001 increments in HIGH resolution by turning the knob ③. Press and turn the knob for faster dialing with 0.100 mV increments in LOW and 0.1000 mV increments in HIGH resolution.

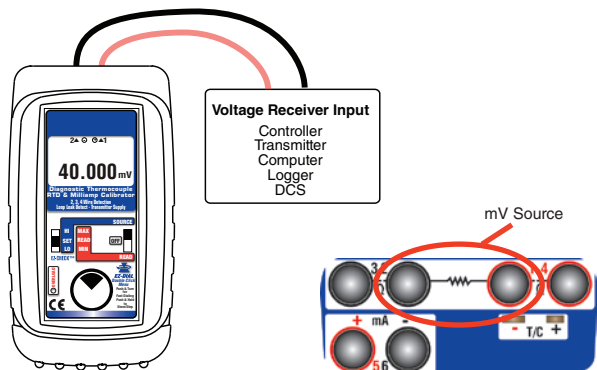

Read mV

Choose this function to measure from -13.000 to 80.000 mV in LOW resolution and -13.0000 to 80.0000 mV in HIGH resolution.

Move the power switch ② to READ then Double Click the EZ-DIAL knob to get into the Menu. Turn the knob to scroll through the settings and press the knob to make your selection. Select V for the FUNCTION.

Connect the red input lead (+) of the PIE 525Plus to the more positive point and the black input lead (-) to the more negative point.

Signals above the maximum scale are limited by protection circuitry with "OVER RANGE" flashed on the display and the red OVERLOAD LED lit.

The PIE 525Plus measures the input signal and constantly updates the display with the current reading. Move the EZ-CHECK switch ① to MAX to see the highest reading and to MIN to see the lowest reading. Press and hold the knob ③ to clear the MAX and MIN readings.

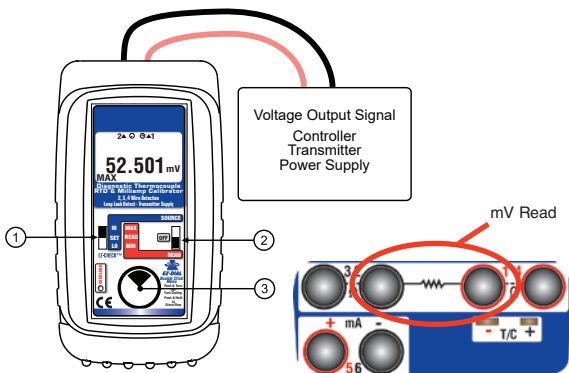

Source Thermocouple

Choose this function to provide a simulated thermocouple signal into controllers, temperature transmitters, indicators or any input devices that measure thermocouple sensors.

Move the power switch ② to SOURCE then Double Click the EZ-DIAL knob to get into the Menu. Turn the knob to scroll through the settings and press the knob to make your selection. Select T/C for the FUNCTION, °F or °C for the UNITS, T/C Type (J, K, E, T, R, S, B, N, L (J-DIN), U (T-DIN), G, C, D or P (Platinel II)) and internal COLD JUNC ON or OFF (ON is the default).

Connect the PIE 525Plus to the inputs of the device being calibrated using the proper type of thermocouple wire via the miniature thermocouple socket.

Instantly output your SPAN and ZERO output settings by moving the EZ-CHECK switch between HI and LO. You may also select any third output setting (such as mid-range) using the SET position on the EZ-CHECK switch. The output is adjusted in 0.1° increments in LOW and 0.01° increments in HIGH resolution by turning the knob ③. Press and turn the knob for faster dialing with 10.0° increments in LOW and 10.00° increments in HIGH resolution.

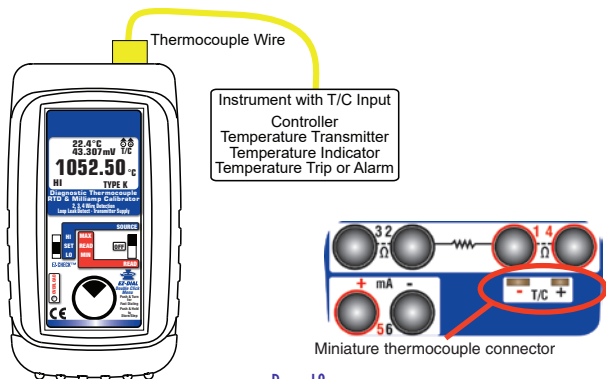

Read Thermocouple Sensors

Choose this function to measure temperatures with a thermocouple probe, sensor or any devices that output a thermocouple signal.

Move the power switch ② to READ then Double Click the EZ-DIAL knob to get into the Double Click Menu. Turn the knob to scroll through the settings and press the knob to make your selection. Select T/C for the FUNCTION, °F or °C for the UNITS, T/C Type (J, K, E, T, R, S, B, N, L (J-DIN), U (T-DIN), G, C, D or P (Platinel II)) and COLD JUNC ON or OFF (ON is the default).

Connect the PIE 525Plus to the inputs of the device being calibrated using the proper type of thermocouple wire via the miniature thermocouple socket. If no sensor is connected, a wire is broken or the sensor is burned out, OPEN TC will appear on the display. Signals above the maximum scale are limited by protection circuitry with "OVER RANGE" on the display.

The PIE 525Plus measures the input signal and constantly updates the display with the current reading. Move the EZ-CHECK switch ① to MAX to see the highest reading and to MIN to see the lowest reading. Press and hold the knob ③ to clear the MAX and MIN readings.

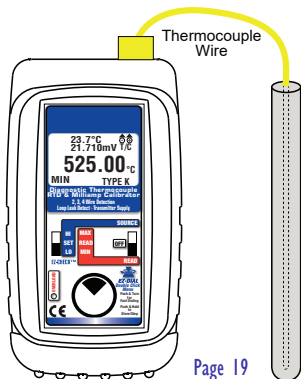

Source Resistance

Choose this function to provide a simulated resistance into any device that measures resistance.

Move the power switch ② to SOURCE then Double Click the EZ-DIAL knob to get into the Menu. Turn the knob to scroll through the settings and press the knob to make your selection. Select OHMS for the FUNCTION, 400 Ω or 4000 Ω for the RANGE. Turn on SENSOR mA to check the excitation current generated by the receiver.

Disconnect all sensor wires from the devices to be calibrated and connect the PIE 525Plus to the inputs of the device using 2, 3 or 4 wires.

Instantly output your SPAN and ZERO output settings by moving the EZ-CHECK switch between HI and LO. You may also select any third output setting (such as mid-range) using the SET position on the EZ-CHECK switch. The output is adjusted for 400 Ω /4000 Ω ranges in 0.01 Ω /0.1 Ω increments in LOW and 0.001 Ω /0.01 Ω increments in HIGH resolution by turning the knob ③. Press and turn the knob for faster dialing with 1.000 Ω /10.00 Ω increments in LOW and 1.000 Ω /10.00 Ω increments in HIGH resolution.

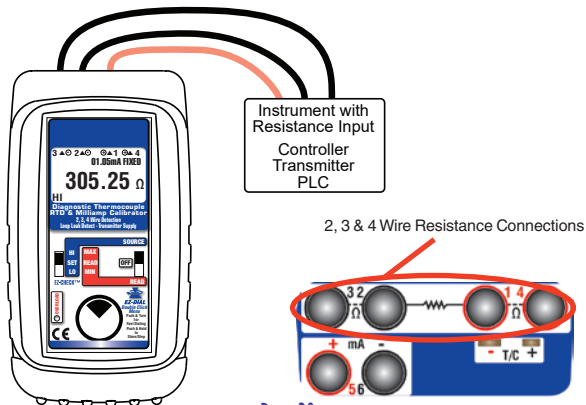

Read Resistance

Choose this function to measure resistance.

Move the power switch ② to READ then Double Click the EZ-DIAL knob to get into the Menu. Turn the knob to scroll through the settings and press the knob to make your selection. Select OHMS for the FUNCTION, 400Ω or 4000Ω for the RANGE.

Connect the PIE 525Plus to the resistor or sensor using 2, 3 or 4 wires. The PIE 525Plus automatically detects how many wires are connected using a patented circuit and indicates each wire that is connected. Any wires that are not connected or broken are indicated by the 525Plus. This is useful for troubleshooting the sensor.

Signals above the maximum scale are limited by protection circuitry with "OVER RANGE" on the display.

The PIE 525Plus measures the input signal and constantly updates the display with the current reading. Move the EZ-CHECK switch ① to MAX to see the highest reading and to MIN to see the lowest reading. Press and hold the knob ③ to clear the MAX and MIN readings.

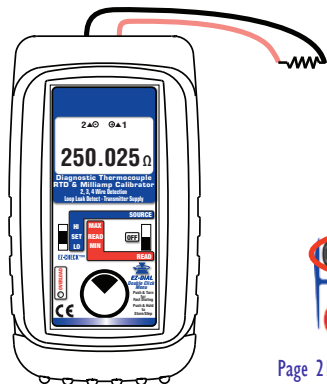

2, 3 & 4 Wire Resistance Connections

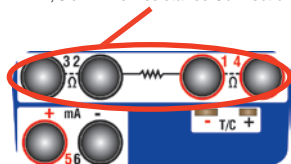

Read RTD Sensors

Choose this function to measure temperatures with an RTD probe, sensor or any devices that output an RTD signal.

Move the power switch ② to READ then Double Click the EZ-DIAL knob to get into the Menu. Turn the knob to scroll through the settings and press the knob to make your selection. Select RTD for the FUNCTION, °F or °C for the UNITS and RTD (Platinum 10, 50, 100, 200, 500 & 1000 Ohm ($\alpha = 3850$), Platinum 100 Ohm ($\alpha = 3902, 3916, 3926$), Copper 10 & 50 Ohm, and Nickel 120 Ohm).

Note: Platinum (Pt) 100 Ω 3850 is the most common RTD type.

Connect the PIE 525Plus to the RTD sensor using 2, 3 or 4 wires. The PIE 525Plus automatically detects how many wires are connected using a patented circuit and indicates each wire that is connected. Any wires that are not connected or broken are indicated by the 525Plus. This information is useful for troubleshooting the sensor.

Signals above the maximum scale are limited by protection circuitry with "OVER RANGE" on the display.

The PIE 525Plus measures the input signal and constantly updates the display with the current reading. Move the EZ-CHECK switch ① to MAX to see the highest reading and to MIN to see the lowest reading. Press and hold the knob ③ to clear the MAX & MIN readings.

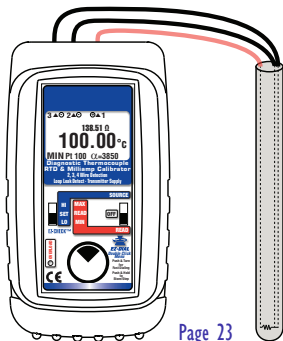

Troubleshooting RTD Instruments

When you are having an issue where an instrument won't read an RTD sensor or you don't know if the calibrator is connected properly the PIE 525Plus has a function to measure and display the fixed or pulsed sensor (excitation) current that the instrument uses to measure the resistance of the RTD sensor.

Double click the ③ DIAL KNOB at any time the unit is set to **SOURCE** RTD and then turn the ③ DIAL KNOB to move to the second menu page so the word **DISPLAY** appears at the top of the menu.

Turn the ③ DIAL KNOB to move through the menu until the cursor is pointing at SENSOR mA. Press the ③ DIAL KNOB to toggle SENSOR mA ON.

Disconnect all sensor wires from the devices to be calibrated and connect the PIE 525Plus to the inputs of the device using 2, 3 or 4 wires. The sensor current generated by the instrument will be indicated on the display followed by the word FIXED or PULSE. Older single channel RTD instruments used a constant (fixed) current source to measure an RTD sensor. Smart transmitters, multichannel recorders and PLC or DCS input cards switch the current source sequentially through the channels which is seen as an intermittent (pulsed) current.

Instrument with RTD Input
Controller
Temperature Transmitter
Temperature Indicator
Temperature Trip or Alarm

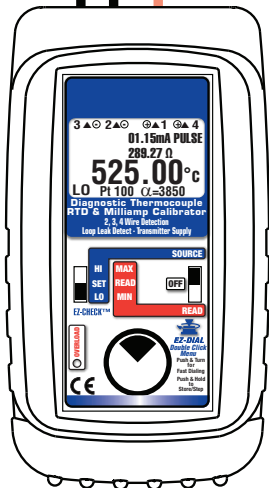

00.21mA FIXED
289.27 Ω
525.00 °C

01.15mA PULSE
289.27 Ω
525.00 °C

Troubleshooting Thermocouple Sensors or Probes

All thermocouple sensors have some resistance when they are new and the resistance increases over time as the thermocouple element ages. Contamination or corrosion of the sensor or the at the terminal block can also add resistance. Knowing the resistance of the sensor and wiring of the thermocouple may be used as a preventive maintenance tool allowing you to replace thermocouple sensors before they fail.

Double click the ③ DIAL KNOB at any time the unit is set to **READ T/C** and then turn the ③ DIAL KNOB to move to the second menu page so the word **T/C DISPLAY** appears at the top of the menu. Turn the ③ DIAL KNOB to move through the menu until the cursor is pointing at TC PROBE Ω. Press the ③ DIAL KNOB to toggle TC PROBE Ω ON.

Connect the PIE 525Plus to the inputs of the device being calibrated using the proper type of thermocouple wire via the miniature thermocouple socket or you may use copper wire plugged into jacks 1 & 2.

If no sensor is connected, a wire is broken or the sensor is burned out, OPEN TC will appear on the display. Signals above the maximum scale are limited by protection circuitry with “OVER RANGE” on the display.

Note: The measurement of thermocouple resistance is not a precise reading but is a general indication of the condition of the thermocouple sensor and connections.

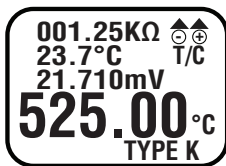
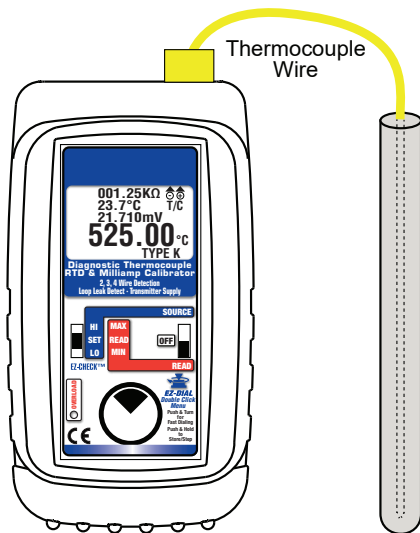

Troubleshooting RTD Sensors

When troubleshooting a problem with an RTD input it is useful to check that the sensor and the wiring to the instrument is operating properly.

The PIE 525Plus automatically detects 2, 3 and 4 wire RTD connections with a patented circuit. It will also display the connections on the display and indicate when there is a missing connection due to a loose connector, corrosion or a broken wire.

Here is an example of the 525Plus reading a sensor with all 4 wires connected.



Here is an example where connections are made to a 4 wire sensor and the PIE 525Plus indicates that only Wires 1, 2 & 4 are connected. There may be a loose connection or a break in wire 3 somewhere between the sensor and the 525Plus.





mA SOURCE/ % SOURCE (Percent of 4 to 20 mA)

Choose this function to provide an output from 0.000 to 24.000 milliamps. The compliance voltage is a nominal 24 VDC to provide the driving power to your milliamp receivers.

Move the power switch ② to SOURCE then Double Click the EZ-DIAL knob to get into the menu. Turn the knob to scroll through the settings and press the knob to make your selection. Select **mA** for the **FUNCTION** and **SOURCE** for the **MODE**. Choose either **mA** or **%** and whether you need the 250Ω HART resistor active in the loop.

Connect the output leads of the PIE 525Plus to the inputs of the device being calibrated, making sure to check polarity. Red lead to the plus (+) input and black lead to the minus (-) input.

Instantly output your SPAN and ZERO output settings by moving the EZ-CHECK switch between HI and LO (defaults to 20 & 4 mA). You may also select any third output setting (such as mid-range) using the SET position on the EZ-CHECK switch. The output is adjusted in 0.001 mA (0.01%) increments by turning the knob ③. Press and turn the knob for faster dialing with 0.100 mA (1.00%) increments.

Note: If there is a break in the loop (or no test leads are connected) **ERROR** will be displayed and the mA value will blink.

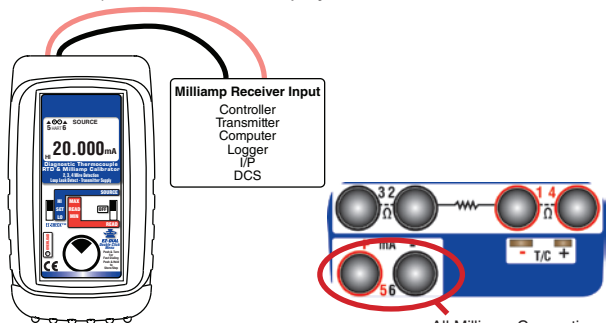

READ mA, READ % (Percent of 4 to 20 mA)

Choose this function to measure from 0.000 to 24.000 milliamps or -25.00 to 125.00%.

Move the power switch ② to READ then Double Click the EZ-DIAL knob to get into the Menu. Turn the knob to scroll through the settings and press the knob to make your selection. Select **mA** for the **FUNCTION** and **READ** for the **MODE**. Choose either **mA** or **%** and whether you need the 250Ω HART resistor active in the loop.

Connect the red input lead (+) of the PIE 525Plus to the more positive point of the break and the black input to the more negative point.

Signals below 0 mA or open circuits are indicated by 0.000 mA (-25.00%) on the display. Signals above 24 mA are current limited by protection circuitry with "OVERRANGE" flashed on the display and the red OVERLOAD LED lit.

The PIE 525Plus measures the input signal and constantly updates the display with the current reading. Move the EZ-CHECK switch ① to MAX to see the highest reading and to MIN to see the lowest reading. Press and hold the knob ③ to clear the MAX and MIN readings.

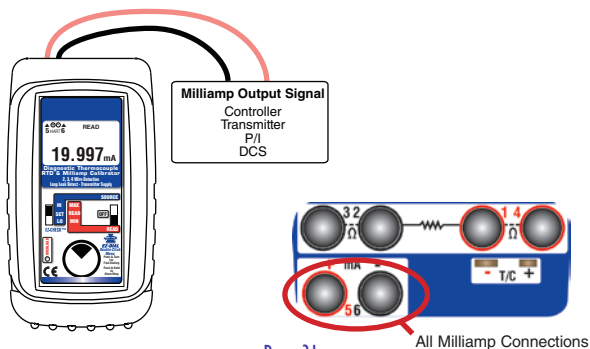

Power/Measure mA, Power/Measure % (Percent of 4 to 20 mA)

Choose this function to simultaneously supply power to a 2 Wire Transmitter while displaying the 4.000 to 20.000 mA output of the transmitter.

Move the power switch ② to READ then Double Click the EZ-DIAL knob to get into the menu. Turn the knob ③ to scroll through the settings and press the knob to make your selection. Select **mA** for the **FUNCTION** and **PWR MEAS** for the **MODE**. Choose either **mA** or **%** and whether you need the 250 Ω HART resistor active in the loop.

Disconnect one or both input wires from the device to be calibrated. Connect the red source lead of the PIE 525Plus to the plus (+) input of the device and the black source lead to the minus (-).

The PIE 525Plus supplies a nominal 24 volts DC at 24 mA to the 2 Wire Transmitter. The current passed by the transmitter will be accurately displayed by the PIE 525Plus. Calibrate the transmitter in the usual manner and disconnect the PIE 525Plus. Signals above 24 mA are current limited by protection circuitry with "OVERRANGE" flashed on the display and the red OVERLOAD LED will flash.

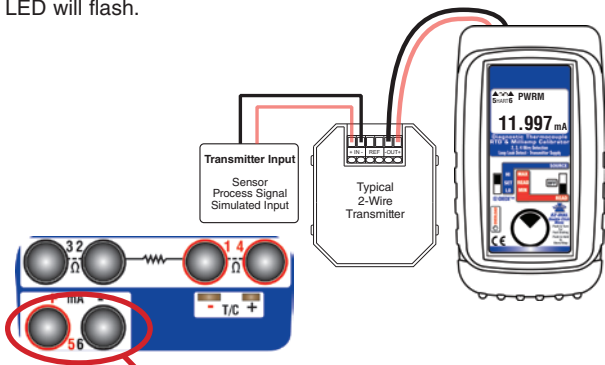

All Milliamp Connections

2 Wire SIM mA, 2 Wire SIM % (Percent of 4 to 20 mA)

Choose this function to simulate a 2 Wire Transmitter output from 0.000 to 24.000 milliamps. Operates in loops with power supply voltages from 2 to 60 VDC.

Move the power switch ② to **SOURCE** then Double Click the EZ-DIAL knob to get into the Menu. Turn the knob to scroll through the settings and press the knob to make your selection. Select **mA** for the **FUNCTION** and **2W SIM** for the **MODE**. Choose either **mA** or **%** and whether you need the 250Ω HART resistor active in the loop.

Connect the output leads of the PIE 525Plus to the inputs of the device being calibrated, making sure to check polarity. Red lead to the plus (+) input and black lead to the minus (-) input.

Instantly output your SPAN and ZERO output settings by moving the EZ-CHECK switch between HI and LO (defaults to 20 & 4 mA). You may also select any third output setting (such as mid-range) using the SET position on the EZ-CHECK switch. The output is adjusted in 0.001 mA (0.01%) increments by turning the knob ③. Press and turn the knob for faster dialing with 0.100 mA (1.00%) increments.

Note: If there is a break in the loop (or no test leads are connected) **ERROR** will be displayed and the mA value will blink.

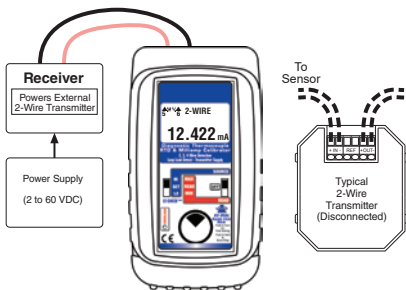

Calibrate a 2-Wire Thermocouple or RTD Transmitter by sourcing the input while monitoring the output.

Move the power switch ② to SOURCE and Double click the ③ DIAL KNOB and the MAIN menu for the function in use will appear for 15 seconds:

MAIN	
>EXIT (1/4)	
FUNCTION	RTD
UNITS	°C °F
RTD	Pt 100 $\alpha=3850$

MAIN	
>EXIT (1/4)	
FUNCTION	T/C
UNITS	°C °F
T/C TYPE	J
COLD JUNC	ON

Turn the ③ DIAL KNOB to move to **FUNCTION**. Select **T/C** or **RTD** for the **FUNCTION**, **°F** or **°C** for the **UNITS**, and the **T/C** or **RTD Type**. Turn the ③ DIAL KNOB to move to the third menu page so the word **mA DISPLAY** appears at the top of the menu.

mA DISPLAY	
> EXIT (3/4)	
mA MODE	OFF READ PWRM READ% PWRM%
HART 250 Ω	OFF ON
LEAK DETECT	OFF ON

Turn the ③ DIAL KNOB to move through the menu. Press the ③ DIAL KNOB to toggle between **OFF** and **ON** or to change the **mA MODE** setting.

mA MODE - pressing the knob will cycle through READ, PWRM, READ% ,PWRM% and OFF.

READ turns on the mA display and indicates current passing through the loop proportional to the input of the transmitter which is controlled by the output of the 525Plus. Choose **READ%** if your would like the mA display in percent of 4-20 milliamps.

PWRM is POWER MEASURE which uses the internal loop supply of the 525Plus to power up the transmitter while

indicating the current passing through the loop proportional to the input of transmitter which is controlled by the output of the 525Plus. Choose **PWRM%** if your would like the mA display in percent of 4-20 milliamps.

If **PWRM** or **PWRM%** is selected an additional menu selection of **LEAK DETECT** will appear. When **LEAK DETECT** is turned on the 311Plus will display **LEAK** and the amount of current that is uncontrolled in the loop. This may be due to a faulty transmitter, corrosion causing a bridge to ground or moisture present at some connection point. When **LEAK DETECT** tests a loop with leakage the loop mA signal will be affected.

HART 250Ω - turn on the 250Ω resistor if you are powering up a HART transmitter. This provides the loop load required for HART communication.

EXIT MENU - exits this menu immediately and saves any changes. Menu will automatically exit after 15 seconds of inactivity.

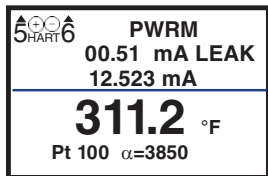

(Enlarged Display)

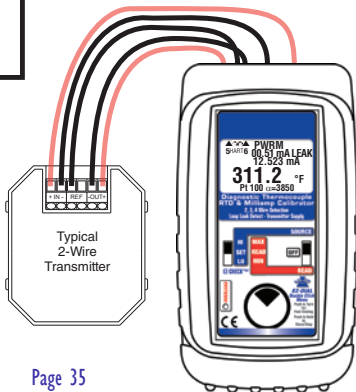

Using Ground Leak Detection mA OUT, % OUT (Percent of 4 to 20 mA)

Find current leaks in loops caused by ground faults, moisture or corrosion. The 525Plus simultaneously supplies power to a 2 Wire Transmitter (or loop with a transmitter) while displaying the 4 to 20 mA output and the amount of current leaking in the loop.

- 1) Move the power switch ② to READ then Double Click the EZ-DIAL knob to get into the Menu. Turn the knob ③ to scroll through the settings and press the knob to make your selection. Select **mA** for the **FUNCTION** and **PWR MEAS** for the **MODE**. Choose either **mA** or **%**.
- 2) Turn the knob ③ until the menu below appears.



- 3) Turn the knob ③ to scroll through the settings and press the knob to make your selection. Turn on the **LEAK DETECT**.
- 4) Connect the red source lead from the mA (+) jack of the 525Plus to the plus (+) input of the device and the black source lead from the mA (-) to the minus (-).

The PIE 525Plus supplies a nominal 24 volts DC at 24 mA to the 2 Wire Transmitter or loop. The current passed by the transmitter will be accurately displayed by the 525Plus along with an indication of leakage current at the top of the display.

If there is an uncontrolled loop caused by a transmitter with upscale burnout and a sensor that is burned out or missing, or a short in the loop wiring, the 525Plus will display "OVER RANGE"

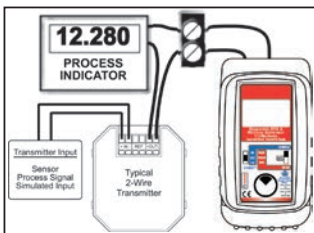

Typical Error Conditions



The PIE 525Plus is supplying the loop voltage. A calibrated transmitter is limiting the loop current to 12.00 mA. An additional 0.51 mA is not controlled by the transmitter and is leaking somewhere in the loop.

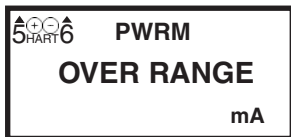

The PIE 525Plus is supplying the loop voltage. There is a control loop error. This may be a transmitter (set for upscale burnout) with a bad or missing sensor, or a short in the loop. The red ERROR LED will also flash.

Note: Many loops with installed transmitters will normally indicate 0.01 to 0.02 mA leakage without significant control problem. Unstable readings may indicate loose connections or the presence of moisture.

PIE 525Plus Specifications

Unless otherwise indicated all specifications (except Cold Junction) are rated from a nominal 23 °C, 70 % RH for 1 year from calibration

General	
Operating Temperature Range	-20 to 60 °C (-5 to 140 °F)
Storage Temp. Range	-30 to 60 °C (-22 to 140 °F)
Temperature Drift	± 0.01% of span outside of 23°C ±10 °C (73°C ±18 °F)
Relative Humidity Range	10 % ≤RH ≤90 % (0 to 35 °C), Non-condensing
	10 % ≤RH ≤ 70 % (35 to 60 °C), Non-condensing
Rejection	Normal Mode: 50/60 Hz, 50 dB Common Mode: 50/60 Hz, 120 dB
Size	5.63 x 3.00 x 1.60 in, 143 x 76 x 41mm (L x W x H)
Weight	12.1 ounces, 0.34 kg with boot & batteries
Batteries	Four "AA" Alkaline 1.5V (LR6)
Optional NiMh Rechargeable battery kit	120 VAC for North America Only; charger, four NiMh batteries, AC & DC cords [Part # 020-0103]
Battery Life	25 Hours Thermocouple/RTD, 8 hours mA
Low Battery	Low battery indication with nominal 1 hour of operation left
Protection against misconnection	Over-voltage protection to 60 vrms (rated for 30 seconds) Red LED indicates OVERLOAD or out of range conditions
Display	High contrast graphic liquid crystal display. LED backlighting for use in low lit areas.

PIE 525Plus Specifications

Read mA	
Ranges and Resolution	0.000 to 24.000 mA or -25.00 to 125.00% of 4-20 mA
Accuracy	$\leq \pm (0.02 \% \text{ of Reading} + 0.003 \text{ mA})$
Voltage burden	$\leq 2\text{V}$ at 24 mA
Overload/Current limit protection	25 mA nominal

Source mA / Power & Measure Two Wire Transmitters & PWRM LEAK	
Ranges and Resolution	0.000 to 24.000 mA or -25.00 to 125.00% of 4-20 mA
Accuracy	$\leq \pm (0.02 \% \text{ of Reading} + 0.003 \text{ mA})$
Loop compliance voltage	$\geq 24 \text{ DCV @ } 20.00\text{mA}$
Loop drive capability	1200 Ω at 20 mA 950 Ω with Hart Resistor or leak detection running
mA 2-Wire Transmitter Simulation	
Accuracy	Same as Source/Power & Measure
Voltage burden	$\leq 2\text{V}$ at 20 mA
Overload/Current limit protection	24 mA nominal
Loop voltage limits	2 to 60 VDC (fuse-less protected from reverse polarity connections)

PIE 525Plus Specifications

Voltage Source

Ranges & Resolution	-13.000 to 80.000 mV & -13.0000 to 80.0000 mV
Accuracy	$\pm(0.008\%$ of Setting + 0.006 mV)
Source Current	≥ 10 mA
Output Impedance	< 0.3 Ohm
RMS Noise	$\leq \pm 0.0005$ mV from 0.1 to 10 Hz
Short Circuit	Duration Infinite

Voltage Read

Range and Resolution	Same as Voltage Source
Accuracy	$\pm(0.008\%$ of Reading + 0.006 mV)
Input resistance	≥ 10 M Ω

Thermocouple Source

Accuracy	$\pm(0.008\%$ of Setting + 0.006 mV)
Cold Junction Compensation	$\pm 0.09^{\circ}\text{F}$ ($\pm 0.05^{\circ}\text{C}$) - Thermistor traceable to NIST for 11 years
Output Impedance	< 0.3 Ohms
Source Current	> 10 mA (drives 80 mV into 10 Ohms)
RMS Noise	$\leq \pm 0.0005$ mV from 0.1 to 10 Hz

Thermocouple Read

Accuracy	$\pm(0.008\%$ of Reading + 0.006 mV)
Cold Junction Compensation	$\pm 0.09^{\circ}\text{F}$ ($\pm 0.05^{\circ}\text{C}$) - Thermistor traceable to NIST for 11 years
Input Impedance	> 10 Megohms
Open Thermocouple	Threshold: 15,000 Ohms nominal Pulse: < 10 microamp pulse for 400 milliseconds

PIE 525Plus Specifications

RTD and Ohms Source	
3 Wire & 4 Wire Accuracy From 1 to 10.2 mA External Excitation Current Below 1 mA of External Excitation Current 2 Wire Accuracy*	$\pm(0.015\% \text{ of Setting} + 0.05 \text{ Ohms})$ Add $\left(\frac{0.025 \text{ mV}}{\text{mA Excitation Current}}\right)$ to Accuracy Add 0.1 Ohms to 3 Wire & 4 Wire Accuracy
Resistance Ranges	400 Ohm Range: 0.00 to 401.00 & 0.000 to 401.000 4000 Ohm Range: 0.0 to 4010.0 & 0.00 to 4010.00
RMS Noise	400 Ohm Range: $\leq \pm 0.005$ Ohms from 0.1 to 10 Hz 4000 Ohm Range: $\leq \pm 0.05$ Ohms from 0.1 to 10 Hz
Allowable Excitation Current Range	400 Ohm Range: 10.2 mA max; steady or pulsed/intermittent 4000 Ohms Range: 1 mA max; steady or pulsed
Pulsed Excitation Current Compatibility	DC to 0.01 second pulse width

RTD and Ohms Read	
Resistance Ranges	Same as RTD and Ohms Source
3 Wire & 4 Wire Accuracy	$\pm(0.015\% \text{ of Reading} + 0.05 \text{ Ohms})$
2 Wire Accuracy*	$\pm(0.015\% \text{ of Reading} + 0.15 \text{ Ohms})$
Excitation Current	0.9 mA to 401 Ohms, 0.4 mA to 4010 Ohms (nominal)

* 2 Wire specifications do not include resistance of the lead wires

Thermocouple Ranges & Accuracies

Table based on Accuracy:

$\leq \pm (0.008 \% \text{ of Reading} + 0.006 \text{ mV})$

Note: Doesn't include cold junction error of $\pm 0.05^\circ\text{C}$

T/C	Degrees C Range	$^\circ\text{C}$	Degrees F Range	$^\circ\text{F}$
J	-200.00 to -150.00	$\pm 0.25^\circ$	-346.00 to -238.00	$\pm 0.55^\circ$
	-150.00 to -50.00	$\pm 0.17^\circ$	-238.00 to -58.00	$\pm 0.35^\circ$
	-50.00 to 300.00	$\pm 0.13^\circ$	-58.00 to 572.00	$\pm 0.24^\circ$
	300.00 to 850.00	$\pm 0.15^\circ$	572.00 to 1562.00	$\pm 0.28^\circ$
	850.00 to 1200.00	$\pm 0.20^\circ$	1562.00 to 2192.00	$\pm 0.36^\circ$
K	-230.00 to -100.00	$\pm 0.70^\circ$	-382.00 to -148.00	$\pm 1.26^\circ$
	-100.00 to 600.00	$\pm 0.19^\circ$	-148.00 to 1112.00	$\pm 0.34^\circ$
	600.00 to 1000.00	$\pm 0.24^\circ$	1112.00 to 1832.00	$\pm 0.43^\circ$
	1000.00 to 1371.1	$\pm 0.31^\circ$	1832.00 to 2500.00	$\pm 0.55^\circ$
T	-260.00 to -240.00	$\pm 1.66^\circ$	-436.00 to -400.00	$\pm 2.98^\circ$
	-240.00 to -210.00	$\pm 0.60^\circ$	-400.00 to -346.00	$\pm 1.07^\circ$
	-210.00 to -100.00	$\pm 0.41^\circ$	-346.00 to -148.00	$\pm 0.74^\circ$
	-100.00 to 50.00	$\pm 0.18^\circ$	-148.00 to 122.00	$\pm 0.33^\circ$
	50.00 to 400.00	$\pm 0.14^\circ$	122.00 to 752.00	$\pm 0.24^\circ$
E	-240.00 to -225.00	$\pm 0.51^\circ$	-400.00 to -373.00	$\pm 0.92^\circ$
	-225.00 to -100.00	$\pm 0.27^\circ$	-373.00 to -148.00	$\pm 0.48^\circ$
	-100.00 to 750.00	$\pm 0.13^\circ$	-148.00 to 1382.00	$\pm 0.24^\circ$
	750.00 to 1000.00	$\pm 0.16^\circ$	1382.00 to 1832.00	$\pm 0.29^\circ$

Thermocouple Ranges & Accuracies

Table based on Accuracy:

$\leq \pm (0.008 \% \text{ of Reading} + 0.006 \text{ mV})$

Note: Doesn't include cold junction error of $\pm 0.05^\circ\text{C}$



T/C	Degrees C Range	°C	Degrees F Range	°F
R	-18.30 to 250.00	$\pm 1.26^\circ$	-1.00 to 482.00	$\pm 2.27^\circ$
	250.00 to 750.00	$\pm 0.64^\circ$	482.00 to 1382.00	$\pm 1.14^\circ$
	750.00 to 1600.00	$\pm 0.54^\circ$	1382.00 to 2192.00	$\pm 0.97^\circ$
	1600.00 to 1767.80	$\pm 0.63^\circ$	2192.00 to 3214.00	$\pm 1.13^\circ$
S	-18.30 to 150.00	$\pm 1.22^\circ$	-1.00 to 302.00	$\pm 2.20^\circ$
	150.00 to 500.00	$\pm 0.72^\circ$	302.00 to 932.00	$\pm 1.30^\circ$
	500.00 to 1650.00	$\pm 0.63^\circ$	932.00 to 3002.00	$\pm 1.14^\circ$
	1650.00 to 1767.80	$\pm 0.73^\circ$	3002.00 to 3214.00	$\pm 1.31^\circ$
B	315.60 to 550.00	$\pm 1.88^\circ$	600.00 to 1022.00	$\pm 3.39^\circ$
	550.00 to 900.00	$\pm 1.03^\circ$	1022.00 to 1652.00	$\pm 1.86^\circ$
	900.00 to 1150.00	$\pm 0.72^\circ$	1652.00 to 2102.00	$\pm 1.30^\circ$
	1150.00 to 1820.00	$\pm 0.63^\circ$	2102.00 to 3308.00	$\pm 1.14^\circ$
N	-230.00 to -100.00	$\pm 1.10^\circ$	-382.00 to -148.00	$\pm 1.98^\circ$
	-100.00 to 0.00	$\pm 0.30^\circ$	-148.00 to 32.00	$\pm 0.53^\circ$
	0.00 to 1100.00	$\pm 0.24^\circ$	32.00 to 2012.00	$\pm 0.44^\circ$
	1100.00 to 1300.00	$\pm 0.27^\circ$	2012.00 to 2372.00	$\pm 0.49^\circ$

Thermocouple Ranges & Accuracies

Table based on Accuracy:

$\leq \pm (0.008 \% \text{ of Reading} + 0.006 \text{ mV})$

Note: Doesn't include cold junction error of $\pm 0.05^\circ\text{C}$

T/C	Degrees C Range	$^\circ\text{C}$	Degrees F Range	$^\circ\text{F}$
G (W) 	100.00 to 450.00	$\pm 1.14^\circ$	212.00 to 842.00	$\pm 2.05^\circ$
	440.00 to 1700.00	$\pm 0.44^\circ$	842.00 to 3092.00	$\pm 0.79^\circ$
	1700.00 to 2000.00	$\pm 0.54^\circ$	3092.00 to 3632.00	$\pm 0.97^\circ$
	2000.00 to 2320.00	$\pm 0.73^\circ$	3632.00 to 4208.00	$\pm 1.32^\circ$
C (W5) 	-1.10 to 1150.00	$\pm 0.44^\circ$	30.00 to 2102.00	$\pm 0.80^\circ$
	1150.00 to 1750.00	$\pm 0.61^\circ$	2102.00 to 3182.00	$\pm 1.09^\circ$
	1750.00 to 2050.00	$\pm 0.74^\circ$	3182.00 to 3722.00	$\pm 1.33^\circ$
	2050.00 to 2320.00	$\pm 0.99^\circ$	3722.00 to 4208.00	$\pm 1.79^\circ$
D (W3) 	-1.00 to 150.00	$\pm 0.63^\circ$	30.00 to 302.00	$\pm 1.13^\circ$
	150.00 to 1200.00	$\pm 0.41^\circ$	302.00 to 2192.00	$\pm 0.73^\circ$
	1200.00 to 1700.00	$\pm 0.51^\circ$	2192.00 to 3092.00	$\pm 0.92^\circ$
	1700.00 to 2320.00	$\pm 0.97^\circ$	3092.00 to 4208.00	$\pm 1.75^\circ$
P	0.00 to 950.00	$\pm 0.23^\circ$	32.00 to 1742.00	$\pm 0.41^\circ$
	950.00 to 1395.00	$\pm 0.34^\circ$	1742.00 to 2543.00	$\pm 0.61^\circ$



Thermocouple Ranges & Accuracies

Table based on Accuracy:

$\leq \pm (0.008 \% \text{ of Reading} + 0.006 \text{ mV})$

Note: Doesn't include cold junction error of $\pm 0.05^\circ\text{C}$

DIN Wire

T/C	Degrees C Range	°C	Degrees F Range	°F
L J-DIN 	-200.00 to -100.00	$\pm 0.21^\circ$	-328.00 to -148.00	$\pm 0.38^\circ$
	-100.00 to 350.00	$\pm 0.13^\circ$	-148.00 to 662.00	$\pm 0.24^\circ$
	350.00 to 900.00	$\pm 0.15^\circ$	662.00 to 1652.00	$\pm 0.27^\circ$
U T-DIN 	-200.00 to -150.00	$\pm 0.37^\circ$	-328.00 to -238.00	$\pm 0.66^\circ$
	-150.00 to 100.00	$\pm 0.22^\circ$	-238.00 to 212.00	$\pm 0.40^\circ$
	100.00 to 600.00	$\pm 0.15^\circ$	212.00 to 1112.00	$\pm 0.28^\circ$

RTD Ranges & Accuracies

Table based on 3 & 4 Wire RTD (ITS-90) Accuracy*:
 $\leq \pm (0.015 \% \text{ of Reading} + 0.05 \text{ Ohms})$

RTD Type	Degrees C Range	°C	Degrees F Range	°F
Pt 100 Ohm DIN/IEC/JIS 1989 $\alpha=1.3850$	-200.00 to -150.00	$\pm 0.13^\circ$	-328.0 to -238.00	$\pm 0.24^\circ$
	-150.00 to 360.00	$\pm 0.24^\circ$	-238.00 to 660.00	$\pm 0.44^\circ$
	360.00 to 740.00	$\pm 0.34^\circ$	660.00 to 1364.00	$\pm 0.61^\circ$
	740.00 to 850.00	$\pm 0.37^\circ$	1364.00 to 1562.00	$\pm 0.67^\circ$
Pt 10 Ohm DIN/IEC/1989 $\alpha=1.3850$	-200.00 to -120.00	$\pm 1.24^\circ$	-328.00 to -184.00	$\pm 2.24^\circ$
	-120.0 to 210.00	$\pm 1.44^\circ$	-184.00 to 410.00	$\pm 2.59^\circ$
	210.00 to 370.00	$\pm 1.54^\circ$	410.00 to 698.00	$\pm 2.77^\circ$
	370.00 to 650.00	$\pm 1.74^\circ$	698.00 to 1202.00	$\pm 3.14^\circ$
	650.00 to 850.00	$\pm 1.91^\circ$	1202.00 to 1562.00	$\pm 3.44^\circ$
Pt 50 Ohm DIN/IEC/1989 $\alpha=1.3850$	-200.00 to 200.00	$\pm 0.34^\circ$	-328.00 to 392.00	$\pm 0.62^\circ$
	200.00 to 550.00	$\pm 0.44^\circ$	392.00 to 1022.00	$\pm 0.80^\circ$
	550.00 to 850.00	$\pm 0.54^\circ$	1022.00 to 1562.00	$\pm 0.98^\circ$
Pt 200 Ohm DIN/IEC/1989 $\alpha=1.3850$	-200.00 to -120.00	$\pm 0.08^\circ$	-328.00 to -184.00	$\pm 0.14^\circ$
	-120.00 to 180.00	$\pm 0.14^\circ$	-184.00 to 356.00	$\pm 0.24^\circ$
	180.00 to 450.00	$\pm 0.19^\circ$	356.00 to 842.00	$\pm 0.34^\circ$
	450.00 to 680.00	$\pm 0.24^\circ$	842.00 to 1256.00	$\pm 0.44^\circ$
	680.00 to 850.00	$\pm 0.29^\circ$	1256.00 to 1562.00	$\pm 0.52^\circ$
Pt 500 Ohm DIN/IEC/1989 $\alpha=1.3850$	-200.00 to -90.00	$\pm 0.08^\circ$	-328.00 to -194.00	$\pm 0.14^\circ$
	-120.00 to 180.00	$\pm 0.14^\circ$	-184.00 to 356.00	$\pm 0.24^\circ$
	180.00 to 450.00	$\pm 0.19^\circ$	356.00 to 842.00	$\pm 0.34^\circ$
	450.00 to 680.00	$\pm 0.24^\circ$	842.00 to 1256.00	$\pm 0.44^\circ$
	680.00 to 850.00	$\pm 0.29^\circ$	1256.00 to 1562.00	$\pm 0.52^\circ$
Pt 1000 Ohm DIN/IEC/1989 $\alpha=1.3850$	-200.00 to 170.00	$\pm 0.08^\circ$	-328.00 to 338.00	$\pm 0.14^\circ$
	170.00 to 470.00	$\pm 0.14^\circ$	338.00 to 878.00	$\pm 0.24^\circ$
	470.00 to 730.00	$\pm 0.19^\circ$	878.00 to 1346.00	$\pm 0.34^\circ$
	730.00 to 850.00	$\pm 0.22^\circ$	1346.00 to 1562.00	$\pm 0.39^\circ$

*Read based on 1.0 mA of fixed excitation current

RTD Ranges & Accuracies

Table based on 3 & 4 Wire RTD (ITS-90) Accuracy*:
 $\leq \pm (0.015 \% \text{ of Reading} + 0.05 \text{ Ohms})$

RTD Type	Degrees C Range	°C	Degrees F Range	°F
Pt 100 Ohm (Burns) $\alpha=1.3902$	-200.00 to -100.00	$\pm 0.14^\circ$	-328.00 to -148.00	$\pm 0.26^\circ$
	-100.00 to 370.00	$\pm 0.24^\circ$	-148.00 to 698.00	$\pm 0.44^\circ$
	370.00 to 648.90	$\pm 0.31^\circ$	698.00 to 1200.00	$\pm 0.56^\circ$
Pt 100 Ohm (Old JIS 1981) $\alpha=1.3916$	-200.00 to -140.00	$\pm 0.13^\circ$	-328.00 to -220.00	$\pm 0.24^\circ$
	-140.00 to 130.00	$\pm 0.19^\circ$	-220.00 to 266.00	$\pm 0.34^\circ$
	130.00 to 370.00	$\pm 0.24^\circ$	266.00 to 698.00	$\pm 0.44^\circ$
	370.00 to 648.90	$\pm 0.31^\circ$	698.00 to 1200.00	$\pm 0.56^\circ$
Pt 100 Ohm (US Lab) $\alpha=1.3926$	-200.00 to -140.00	$\pm 0.13^\circ$	-328.00 to -220.00	$\pm 0.24^\circ$
	-140.00 to 130.00	$\pm 0.19^\circ$	-220.00 to 266.00	$\pm 0.34^\circ$
	130.00 to 380.00	$\pm 0.24^\circ$	266.00 to 716.00	$\pm 0.44^\circ$
	380.00 to 610.00	$\pm 0.30^\circ$	716.00 to 1130.00	$\pm 0.54^\circ$
	610.00 to 850.00	$\pm 0.37^\circ$	1130.00 to 1562.00	$\pm 0.66^\circ$
Copper 10 Ohm (Minco) $\alpha=1.4274$	-200.00 to -150.00	$\pm 1.24^\circ$	-328.00 to -238.00	$\pm 2.24^\circ$
	-150.00 to 90.00	$\pm 1.34^\circ$	-238.00 to 194.00	$\pm 2.42^\circ$
	90.00 to 260.00	$\pm 1.36^\circ$	194.00 to 500.00	$\pm 2.44^\circ$
Copper 50 Ohm $\alpha=1.4280$	-50.00 to 150.00	$\pm 0.29^\circ$	-58.00 to 302.00	$\pm 0.52^\circ$
Ni 120 Ohm (Pure) $\alpha=1.6720$	-80.00 to 260.00	$\pm 0.10^\circ$	-112.00 to 500.00	$\pm 0.17^\circ$

*Read based on 1.0 mA of fixed excitation current



Guaranteed compatible with smart transmitters, multichannel recorders as well as PLC and DCS input cards.

Standard Warranty

Our equipment is warranted against defective material and workmanship (excluding batteries) for a period of three years from the date of shipment. Claims under warranty can be made by returning the equipment prepaid to our factory. The equipment will be repaired, replaced or adjusted at our option. The liability of Practical Instrument Electronics (PIE) is restricted to that given under our warranty. No responsibility is accepted for damage, loss or other expense incurred through sale or use of our equipment. Under no condition shall Practical Instrument Electronics, Inc. be liable for any special, incidental or consequential damage.

Optional Repair/Replacement Warranty

Under our Repair/Replacement Warranty (RP-WAR-B), our equipment is warranted against ANY damage or malfunction that may cause the unit to fail for a period of three (3) years from the date of shipment.

This warranty is limited to one complete replacement against any damage or malfunction during the warranty period. If replaced, the new calibrator will carry our Standard Warranty for the remainder of the three (3) years or a minimum of one (1) year from the date of shipment.

Additional Information

PIE Calibrators are designed, assembled and calibrated in the USA. This product is calibrated on equipment traceable to NIST and includes a Certificate of Calibration. Test Data is available for an additional charge.

Practical Instrument Electronics recommends a calibration interval of one year. Contact your local representative for recalibration and repair services.



Practical Instrument Electronics

Tel: 585.872.9350 • Fax: 585.872.2638
sales@piecal.com • www.piecal.com

Copyright © 2017 All rights reserved
525Plus-9002 - Rev A 21 December 2017