



OptiPEAK TDL600 Process Moisture Analyzer User's Manual



97319 Issue 4.2
November 2018

Please fill out the form(s) below for each instrument that has been purchased.

Use this information when contacting Michell Instruments for service purposes.

Analyzer	
Code	
Serial Number	
Invoice Date	
Location of Instrument	
Tag No	

Analyzer	
Code	
Serial Number	
Invoice Date	
Location of Instrument	
Tag No	

Analyzer	
Code	
Serial Number	
Invoice Date	
Location of Instrument	
Tag No	



OptiPEAK TDL600

For Michell Instruments' contact information please go to
www.michell.com

© 2018 Michell Instruments

This document is the property of Michell Instruments Ltd. and may not be copied or otherwise reproduced, communicated in any way to third parties, nor stored in any Data Processing System without the express written authorization of Michell Instruments Ltd.

Contents

Safety	vii
Electrical Safety	vii
Pressure Safety	vii
Toxic Materials	vii
Repair and Maintenance	vii
Calibration (Factory Validation).....	vii
Safety Conformity	vii
Abbreviations	viii
1 INTRODUCTION	1
1.1 Application	1
1.2 Features	1
1.3 Theory of Operation	2
1.3.1 Measurement Using a Laser	4
2 INSTALLATION	6
2.1 Unpacking the Instrument.....	6
2.2 Lifting and Handling	7
2.3 Laser Safety	7
2.4 Hazardous Area Safety.....	8
2.5 Electrical Safety	9
2.5.1 Equipment Ratings and Installation Details.....	9
2.6 Pressure Safety	11
2.7 Basic Installation Guidelines	11
2.8 Electrical Connections	15
2.8.1 Power Connection	15
2.8.2 Analog Outputs.....	16
2.8.3 Analog Inputs	16
2.8.4 Alarm Relays.....	16
2.8.5 Modbus RTU / RS485 Connection	17
2.9 Environmental Requirements.....	17
2.10 Sample Conditioning Requirements.....	18
2.10.1 Gas Connections	18
2.10.2 Sample Flow Gas Handling Components	18
2.11 Options.....	21
2.11.1 Enclosure Heater Temperature Control (Outdoor systems ONLY).....	21
2.11.2 Vortex Cooling (Outdoor systems ONLY)	21
2.11.3 Trace Heated Sample Line	21
3 OPERATION	22
3.1 Start-Up Procedure	22
3.2 Shut Down Procedure	23
3.3 User Interface	24
3.3.1 Interface Controls	24
3.3.2 'Up/Down Arrow' Keys	24
3.3.3 'ENTER' Key	25
3.3.4 'ESC' Key	25
3.4 Description of Measured Parameters	25
3.5 Default Settings.....	26
3.5.1 Advanced Menu default settings.....	26
3.6 Menu Structure	27
3.7 Main Menu Screen	28
3.7.1 Parameters Screen	29
3.7.2 Display Screen	30
3.7.3 Log Menu Screen	31
3.7.4 About Screen.....	32
3.7.5 Graph Screen.....	32

3.7.6	Advanced Settings Screen.....	33
3.7.6.1	Outputs Screen.....	34
3.7.6.2	Alarms Screen	35
3.7.6.3	Inputs Screen	38
3.7.6.4	Clock Screen.....	41
3.7.6.5	Modbus Screen	42
3.7.6.6	Region Defaults Screen.....	43
3.7.6.7	N2-Mode (Measurement Mode) Screen	44
3.7.6.8	Safe Mode (Laser Disabled) Screen	44
3.8	Enclosure Cover and User Interface	45
4	MAINTENANCE	46
4.1	Inspection of the Enclosure Cover.....	47
4.2	Replacement of the Micro SD Data Logging Card	49
4.3	Membrane and Particulate Filter Element Replacement.....	51
4.3.1	Service Intervals	51
4.3.2	Installing the Filter Element and Membrane	51
4.3.3	Field measurement verification.....	53
4.3.4	Long-term maintenance – Laser replacement.....	54

Figures

Figure 1	Beer Lambert Law	3
Figure 2	Laser Scan	4
Figure 3	System Block Schematic.....	5
Figure 4	Unpacking the TDL600.....	6
Figure 5	Earthing Stud And Nut Washer Assembly	10
Figure 6	OptiPEAK Sampling System - Typical Indoor Version.....	12
Figure 7	OptiPEAK Sampling System - Typical Indoor Version.....	12
Figure 8	OptiPEAK Sampling System - Typical Outdoor Version	13
Figure 9	OptiPEAK Sampling System - Typical Outdoor Version	14
Figure 10	User Interface	24
Figure 11	Up/Down Arrow Keys.....	24
Figure 12	'ENTER' Key	25
Figure 13	'ESC' Key	25
Figure 14	Menu Structure	27
Figure 15	Main Menu Screen	28
Figure 16	Parameters Screen	29
Figure 17	Display Setup Screen	30
Figure 18	Data Logging Screen	31
Figure 19	Contact/About Screen.....	32
Figure 20	Graph Screen	32
Figure 21	Advanced Settings Screen	33
Figure 22	Output Screens	34
Figure 23	Alarm Screens.....	35
Figure 24	Typical Alarm Status Indication on the Run-Mode Screen.....	37
Figure 25	Input Screen	38
Figure 26	Line Pressure Setup Screen	39
Figure 27	Spare Input Setup Screen	40
Figure 28	Set Date/Time Screen.....	41
Figure 29	Modbus Settings Screen.....	42
Figure 30	Region Defaults Screen.....	43
Figure 31	N2-Mode (Measurement Mode) Screen	44
Figure 32	Safe Mode (Laser Disabled) Screen.....	45
Figure 33	Dimensional Drawing - Indoor System Enclosure	58
Figure 34	Dimensional Drawing - Outdoor System Enclosure	59
Figure 35	Wiring Diagram Indoor System.....	61
Figure 36	Wiring Diagram Outdoor System.....	63

Tables

Table 1	Parameters Screen Parameters	29
Table 2	Display Setup Screen Parameters.....	30
Table 3	Data Logging Screen Parameters	31
Table 4	Output Screen Parameters	34
Table 5	Line Pressure Setup Screen Parameters.....	39
Table 6	Spare Input Setup Screen Parameters	40
Table 7	Set Date/Time Screen Parameters	41
Table 8	Modbus Screen Parameters	42
Table 9	Region Default Parameters	43
Table 10	N2-Mode Parameters	44

Appendices

Appendix A	Technical Specification	55
	A.1 Dimensional Drawings.....	56
	A.2 Dimensional Drawings.....	57
Appendix B	Indoor Sampling System Wiring Diagram	59
Appendix C	Outdoor Sampling System Wiring Diagram	61
Appendix D	Flow Diagram.....	63
Appendix E	Modbus Holding Register Map	65
Appendix F	Quality, Recycling, Compliance & Warranty Information.....	70
Appendix G	Hazardous Area Certification	71
	G.1 Product Standards	72
	G.2 Product Certification	72
	G.3 Global Certificates/Approvals	72
	G.4 Special Conditions of Use	72
	G.5 Maintenance and Installation	73
Appendix H	Return Document & Decontamination Declaration.....	75

Safety

This manual contains all the required information to install, operate and maintain the OptiPEAK TDL600 Process Moisture Analyzer. Prior to installation and use of this product, this entire manual should be read and understood. Installation and operation of this product should be carried out by suitably competent personnel only. The operation of this product must be in accordance with the terms of this manual and associated safety certificates. Incorrect installation and use of this product for other than its intended purpose will render all warranties void.

This product is intended for use in a Hazardous Area and is awarded an ATEX, IECEx and cQPSus Certificate. These certificates should be fully examined prior to installation or use of this product.



Where this hazard warning symbol appears in the following sections, it is used to indicate areas where potentially hazardous operations need to be carried out and where particular attention to personal and personnel safety must be observed.

Electrical Safety

The instrument is designed to be completely safe when used with options and accessories supplied by the manufacturer for use with the instrument. The input power supply voltage limits are 90 to 264 V AC, 50/60Hz (dependent on chosen options).

Pressure Safety

DO NOT permit pressures greater than the safe working pressure to be applied directly to the instrument's sample cell. The specified working pressure is 0.7 to 1.4 bara (10 to 20.3 psia). Refer to the Technical Specifications in Appendix A.

Toxic Materials

The use of hazardous materials in the construction of this instrument has been minimized. During normal operation it is not possible for the user to come into contact with any hazardous substance which might be employed in the construction of the instrument. Care should, however, be exercised during maintenance and the disposal of certain parts.

Repair and Maintenance

The instrument must be maintained either by the manufacturer or an accredited service agent. Refer to www.michell.com for details of Michell Instruments' worldwide offices contact information.

Calibration (Factory Validation)

Prior to shipment, the analyzer undergoes stringent factory calibration to traceable standards. Due to the inherent stability of the instrument, regular field calibration is not required under normal operating conditions. The analyzer should perform reliably for many years with just basic maintenance and housekeeping. Michell can provide a fully traceable factory calibration service for the instrument when required. Please contact your local Michell office or representative for further details (www.michell.com).

Safety Conformity

This product meets the essential protection requirements of the relevant EU directives. Further details of applied standards may be found in the product specification.

Abbreviations

The following abbreviations are used in this manual:

A	ampere
AC	alternating current
bara	pressure unit (=100 kPa or 0.987 atm)
barg	pressure unit (=100 kPa or 0.987 atm) gauge
°C	degrees Celsius
°F	degrees Fahrenheit
EU	European Union
ft	feet
hr	hour
kg	kilogram(s)
lbs	pound(s)
lb/MMscf	pounds per million standard cubic feet
LCD	liquid-crystal display
NI/min	normal liters per minute
m	meters
mA	milliampere
max	maximum
*mg/m ³	milligrams per cubic meter
mm	millimeters
nm	nanometers
NPT(F)	National pipe thread (female)
PCB	printed circuit board
ppm _v	parts per million by volume
psia	pounds per square inch absolute
psig	pounds per square inch gauge
RH	relative humidity
RS485	serial data transmission standard
scfh	standard cubic feet per hour
sec	seconds
TDL	Tuneable Diode Laser
V	Volt
W	Watts
%	percentage
"	inch(es)
∅	diameter

* mg/m³ refers to standard sm³ (i.e. 15°C at atmospheric pressure)

1 INTRODUCTION

The OptiPEAK TDL600 Tunable Diode Laser Analyzer employs the latest techniques in laser absorption spectroscopy and signal processing power to offer a robust high performance analyzer, designed specifically for the measurement of moisture in natural gas. The analyzer is fully hazardous area certified and delivers class-leading measurement performance, stability and detection sensitivity.

The complete OptiPEAK TDL600 Analyzer Sampling System can be located close to the gas sample take-off point in a potentially explosive environment - designated Zone 1 and Zone 2 hazardous area.

The indoor version Sampling System gas handling components are assembled on a 316 Stainless Steel plate suitable for wall mounting within a temperature controlled analyzer house.

The outdoor version Sampling System is housed within a stainless steel enclosure (304 or 316), with optional thermostatically controlled heating and cooling, for direct field installation in a 100% shaded location next to the process line (with overall environmental protection to IP66).

All sample gas wetted metallic parts are in AISI 316L stainless steel with Viton® soft parts that comply with the NACE standard MR-01-75 (latest edition). Tube fittings are type 316 Stainless Steel. All gas and cable entries are located in the base of the enclosure.

1.1 Application

The measurement of moisture in natural gas streams is an essential and highly critical analysis for the natural gas industry. Gas companies need to meet specific quality standards for transmission, custody transfer and delivery. High levels of water in the gas increase the cost of transportation and lower the calorific value of the gas. In addition, excessive moisture content in the gas stream can lead to internal pipe corrosion and hydrate formation, requiring expensive pipe cleaning or 'pigging'. In severe cases, pipeline blockage can occur.

Although the analyzer is designed for the measurement of water in transmission quality natural gas backgrounds it has been configured for use with almost any natural gas stream. This provides full flexibility if, for example, the analyzer is later re-deployed to a different application. (See Section 3, Operation, for further details.)

1.2 Features

- **High Measurement Sensitivity**

The OptiPEAK TDL600 features a lower detection limit (LDL) of 1 ppm_v water content. This high sensitivity, coupled with the inherent fast response of the TDL optical measurement, provides an extremely fast, accurate and reliable non-contact gas measurement.

- **D-MET – Dynamic Methane Compensation. BioGas Ready**

Moisture measurement is virtually independent* of changes in the methane composition of the natural gas feed and accuracy is not reliant on manual software correction factors being applied.

The analyzer can be used with a wide range of background gas compositions. With increasing statutory requirements in many regions for Biomethane to be added to natural gas streams, the analyzer has been future proofed by being Biomethane ready.

* Over a methane concentration range of 40 - 100% CH₄

- **Laser Lock System**

Tunable diode lasers can drift. This means that the laser wavelength may slowly change with time and, eventually, may not precisely match the absorption peak of the water. This can lead to a reduction in sensitivity and analyzer drift. This inherent property of diode lasers is overcome in the OptiPEAK TDL600 by the built-in Laser lock system. This system monitors the optical profile of the gas absorption peaks to ensure the laser remains locked to the correct water absorption peak, maintaining a high integrity measurement at all times.

- **Fast Response**

Being a non-contact optical measurement, the analyzer offers fast response times, meaning no long wet-up or dry-down times in contrast to traditional moisture sensors. None of the sensing components are exposed to the gas stream, protecting them from any aggressive components or harmful contamination.

- **HMI system**

Provides a highly intuitive menu driven interface, utilizing a capacitive touch screen system, offering stylus-free setup and operation without the need for a 'hot work' permit to adjust settings or to perform validation checks.

1.3 Theory of Operation

The OptiPEAK TDL600 uses the technique of absorption spectroscopy to measure the concentration of water vapor in the gas stream. Many gas molecules exhibit very specific resonant vibrations in the infrared region of the electromagnetic spectrum. If infrared energy, at the same resonant wavelength, is passed through these molecules, some of this energy will be absorbed. If a suitable detector is used to measure the amount of received energy, and the gas is contained within a cell of a known path length, then the gas concentration can be calculated. This can be expressed mathematically and is often referred to as the Beer-Lambert Law.

$$c = \frac{A}{\epsilon l}$$

where:

A = absorbance

ϵ = extinction coefficient (absorption strength of gas at a specific wavelength)

l = sample cell path length

c = gas concentration

This law states that, if the sample cell path length (**l**) is known, and the extinction coefficient of the water molecule (**ϵ** - a constant that describes how strongly a particular gas absorbs light at a specific wavelength) is known, then, if the absorbance of laser energy by the water molecules is measured (**A**), the water concentration (**c**) of the sample stream can be calculated. This gas law is the basis of all photometric gas absorption measurement.

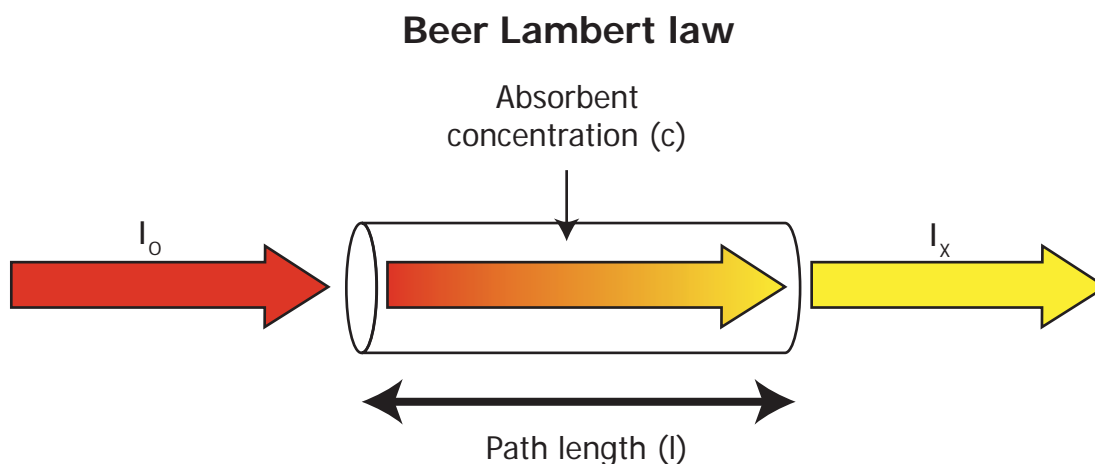

Figure 1 *Beer Lambert Law*

The Michell OptiPEAK TDL600 uses a tunable diode laser source to generate a narrow and coherent beam of near infrared (NIR) energy at the precise resonant wavelength of water vapor. Traditionally, infrared analyzers use broadband sources which generate a wide gamut of wavelengths. To make these analyzers as selective as possible to moisture only, optical filters have to be deployed to 'narrow' the range of wavelengths that are finally passed through the sample. These filters do not offer very high selectivity - they are quite broadband, which can lead to significant spectral interference, as other gas peaks close to the water absorption peaks are also detected, leading to cross interference, drift and general degradation in measurement performance.

In contrast, the laser has a bandwidth of less than 0.0001 nanometers. This means the laser is very selective in detecting only the water and not any other gases present in the gas stream.

This optical technique also has the advantage that the analyzer uses a non-contact method of measurement, i.e. there is no sensing element in contact with the gas stream. This offers a highly robust and reliable measurement, as only photons of light pass through the gas. This provides very fast response and no long wet-up or dry-down times.

1.3.1 Measurement Using a Laser

The diagram below illustrates the advantages of using a laser source, compared to a traditional broadband source.

The water absorption peak is shown in the center of the diagram (red area). The width of the laser beam is very narrow and is represented by the yellow line.

The laser wavelength is varied in order to scan across the water absorption peak (yellow area). By scanning the peak in this way, important information can be extracted, such as changes to the absorption peak caused by variation in the sample gas. This very precise scan range minimizes any overlap with nearby absorption bands, as would be the case with conventional broadband infrared sources and optical filters (blue area).

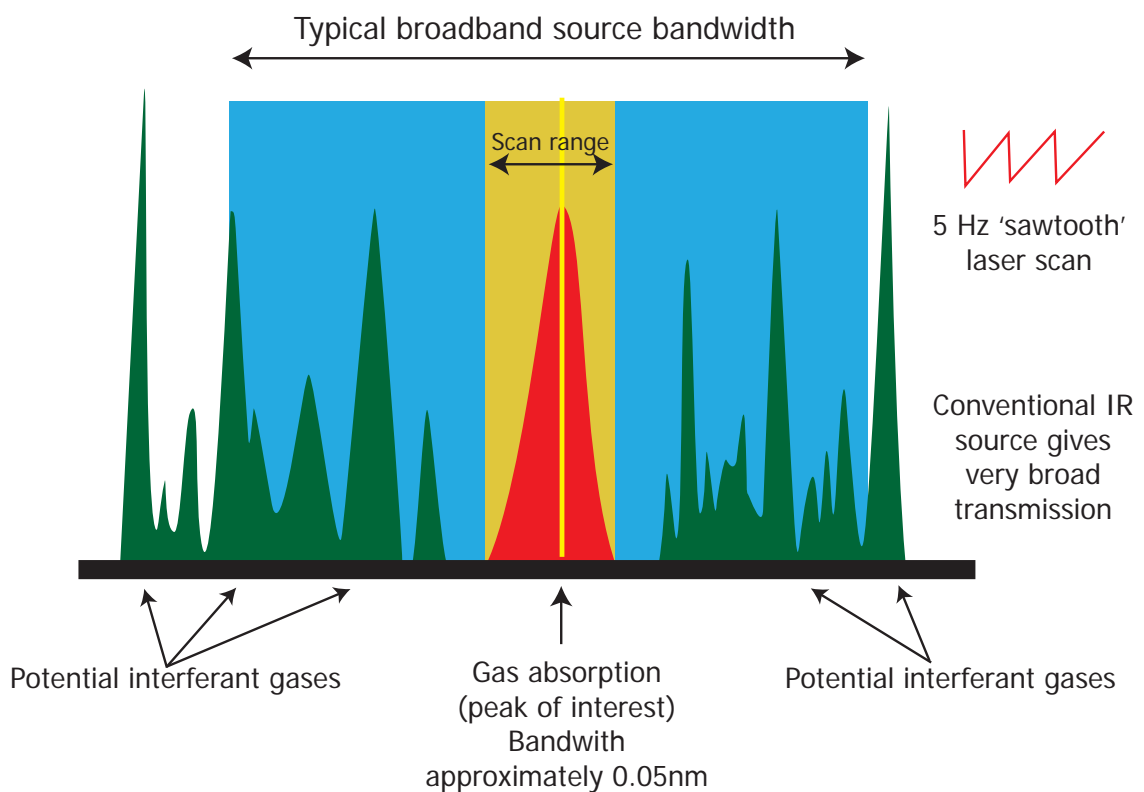

Figure 2 Laser Scan

The schematic of the laser measurement system is shown in *Figure 3* below. This highlights the major control and signal processing sections of the analyzer. The analyzer uses the WMS (Wavelength Modulation Spectroscopy) technique, in combination with proprietary signal processing algorithms to provide a selective response and high sensitivity to moisture.

Here, a single frequency, distributed feedback (DFB) laser diode is tuned by applying a current ramp to the laser. A further sinusoidal modulation is then applied. Lock-in detection is applied to the photo-detector signal obtained by passing the tuned laser radiation through the gas cell. The second harmonic signal from the lock-in detection is measured to recover the spectroscopic peak of interest. WMS offers a practical method of recovering weak signal changes from a dilute trace gas sample. WMS is becoming wide spread within the sector of natural gas monitoring and represents current state-of-the-art technology.

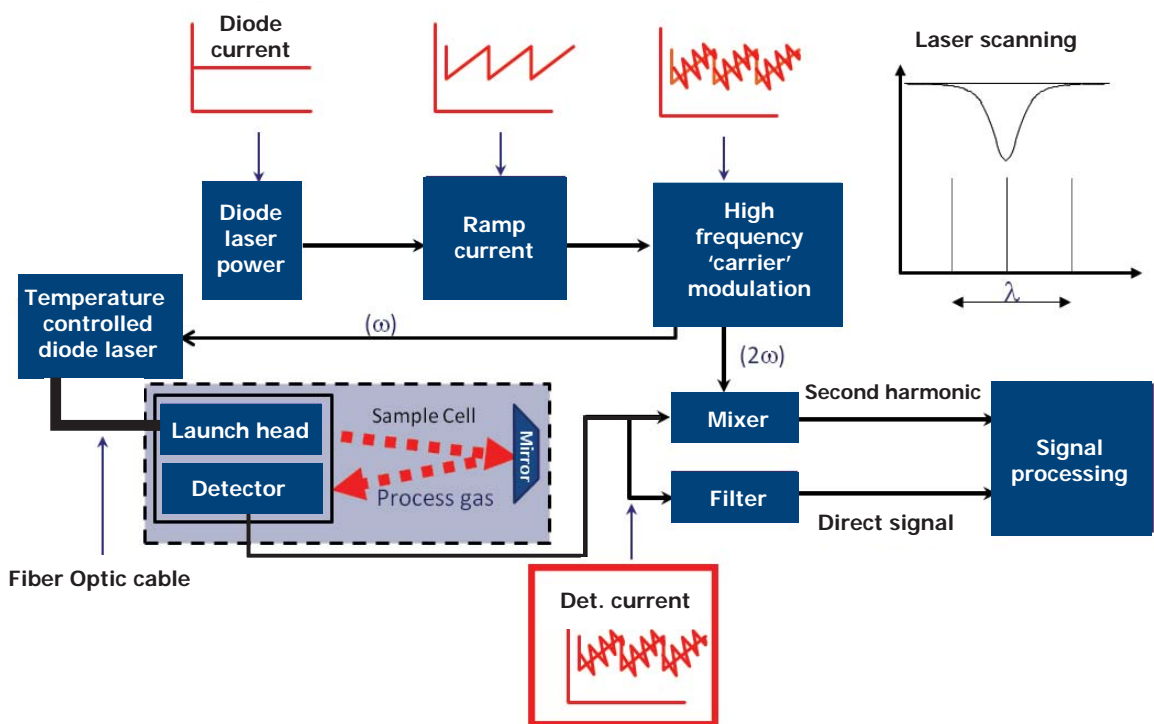

Figure 3 System Block Schematic

2 INSTALLATION

2.1 Unpacking the Instrument

Open the crate and unpack carefully as follows:



WARNING:
The instrument is heavy and should not be lifted alone.
Mechanical lifting aids may be required for larger systems.

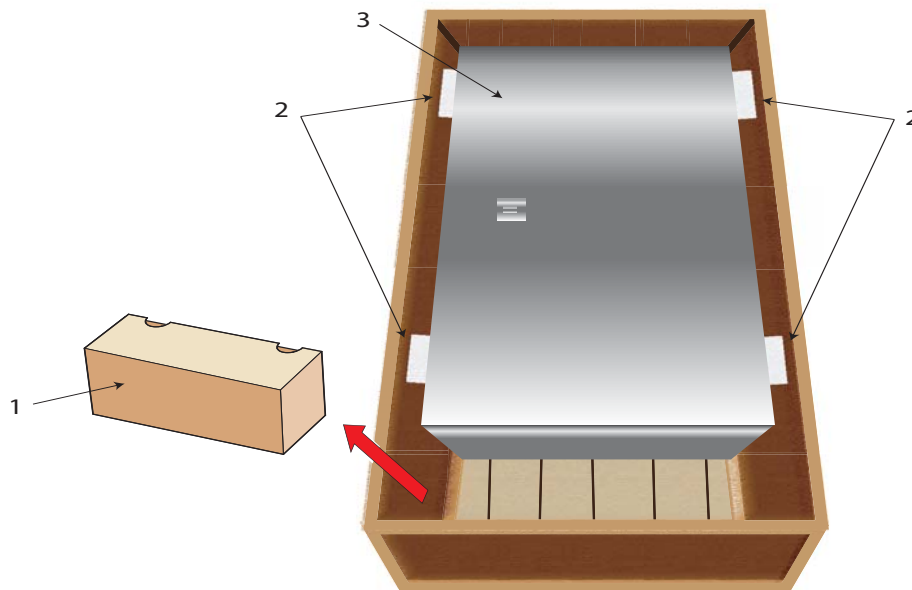

Figure 4 *Unpacking the TDL600*

1. Remove the accessories box (1).
2. Remove the spacer foam (2).
3. Remove the instrument enclosure (3) and set it down at the site of installation.

It is recommended to save all the packing materials for the purpose of returning the instrument for warranty claims.

The accessories box should contain the following items:

- Calibration Certificate
- Application Software CD
- User Manual
- CD containing System Documentation

2.2 Lifting and Handling

**WARNING:**

**This product is in excess of 75kg (165lbs).
Personnel must observe suitable lifting and handling precautions.**

The TDL600 is not designed as portable or transportable equipment. The product should be rigidly fixed in position as per the full installation instructions.

Appropriate lifting and handling techniques should be used during the installation process. Before commencing any lifting or handling ensure that its intended location is suitable and appropriately prepared. Make sure that mounting point design considerations have employed locally approved safety factors.

When handling and installing this instrument (particularly after removal from its packaging) ensure that it is not dropped, impacted or subjected to high levels of vibration or environmental conditions that may impair its operation.

2.3 Laser Safety

This product contains a Diode Laser with an invisible beam, operating in the near infrared range. The laser as used in this product classifies it as a CLASS 1 product.

For the purposes of CDRH and FDA Registration the OptiPEAK TDL600 complies with 21CFR1040 with deviations pursuant to Laser Notice 50 and with IEC/EN 60825-1:2007.

**WARNING:**

**This product is a CLASS 1 LASER PRODUCT.
Beware of Laser radiation.
Do not access the Laser.
Do not view the Laser directly.**

**WARNING:**

Use of controls or adjustments, or performance of procedures other than those specified herein, may result in hazardous radiation exposure.

2.4 Hazardous Area Safety

Refer to Appendix G for the Hazardous Area Certification of this product.

This product is fitted with a marking label that contains Hazardous Area information pertinent to the suitable location and installation.

During all installation and operation activities, local regulations and permitted working routines must be observed. Installation should only be performed by competent personnel and in accordance with IEC 60079-14:2007 and EN 60079-14:2008 or local equivalent.

Cable glands / conduit seals shall be installed in accordance with the manufacturer's instructions.

Conduit seals used should be suitable for a reference pressure of 6.1 bar (89 psi).

Repair and servicing of this equipment must only be carried out by the manufacturer.



WARNING:
This product is certified safe for use in a Zone 1 and Zone 2 area only. This product must not be installed or used within a Zone 0 area.

WARNING:
This product must not be operated within an explosive atmosphere greater than 1.1 bara (16 psia).

WARNING:
This product must not be operated within an enriched oxygen atmosphere (more than 21% oxygen content).

WARNING:
This product must not be operated outside of the temperature range of -20 to +55°C (-4 to +131°F)

WARNING:
The analyzer enclosure of this product provides Exd protection, partly through the threads used for mounting the lid, stopping plugs and cable gland. At all times effort should be made to ensure these threads are suitably protected from damage and that only appropriately rated mating parts are applied to them, in accordance with the certifying requirements.

2.5 Electrical Safety



WARNING:
During the installation of this product, ensure that all applicable national and local electrical safety regulations are observed.

WARNING:
Always ensure that power is switched off prior to accessing the product for any purpose other than normal operation, or prior to disconnecting any cables.

2.5.1 Equipment Ratings and Installation Details

The following mandatory statements refer to the Ex certified TDL600 Analyzer and sampling system.

This equipment must be supplied with a voltage in the range of 90 to 264 V AC, 50/60 Hz. Maximum power rating depends on chosen standard options, 80W to 250W.

All electrical connections to the analyzer are made through junction boxes, mounted on the panel of the sample system in accordance with Section 2.8.

Any power cable should be 3 core over sleeved, with minimum 0.5mm insulation and rated at 300 V. Cables should have Live (L), Neutral (N) and Earth [Ground] (E) conductors. Ensure suitably rated power supply cables and glands are used to ensure that electrical safety is maintained. Ensure the power supply can deliver sufficient power to meet the consumption requirements.

Any power supply terminals and voltages must be suitably separated from the other I/O requirements to this product.

Before applying power, perform a continuity test to ensure that the power supply cable and the TDL600 are effectively connected to the protective Earth.

The protective Earth terminal is mounted internally and the Earth wire connected to it should never be disconnected. The analyzer enclosure is supplied with an external earth stud at the lower right hand side. This earth stud is connected to the sampling system earth using 4mm² minimum earthing bonding.



Figure 5 *Earthing Stud And Nut Washer Assembly*

Fuse: A replacement fuse can be obtained by contacting Michell Instruments' technical support. Fuse rating = 5 x 20mm 2.5 A anti-surge to IEC 60127-2.

This measuring product is designed, where applicable and possible, to be in compliance with EN/BS/IEC61010 safety requirements or electrical equipment or measurement, control, and laboratory use. This product is designed to be safe at least under the following conditions: between a temperature range of -40 to +60°C (-40 to +148°F), in maximum 80% relative humidity for temperatures up to +31°C (+88°F) decreasing linearly to 50% RH at +50°C (+122°F). Supply voltages of ±10% and transient over voltages up to Overvoltage Category II. Pollution Degree 2. Altitudes up to 2000m. Outdoor mounting is permitted using suitably rated glands equivalent to NEMA 4 / IP66. **See Appendix A, Technical Specification, for full operating parameters.**

NOTE: Do not remove or exchange any of the cables or electrical components supplied with this product. Doing so will invalidate all warranties.

There are no additional or special electrical safety requirements other than those referred to in this manual.

For location and mounting arrangements please refer to the relevant sections of this manual.

Installation of this equipment must include the provision of a suitable and locally positioned power isolation switch or circuit breaker. Indication of the purpose of the switch or circuit breaker is strongly recommended. An over-current protection device should be rated to a maximum of 3 A.

This equipment and all power isolation devices must be installed in a location and position that allows safe and easy access to their operation and is able to rigidly support the equipment.

Do not install this equipment in a location that would expose it to impact or high levels of vibration.

Operation of this equipment, other than in a manner specified by the manufacturer, may impair the safety protections provided.

The safe installation of this equipment and any system incorporating this equipment is the responsibility of the installer. Ensure local regulations and requirements are referred to prior to any installation commencing.

2.6 Pressure Safety



WARNING:
This product is used in conjunction with pressurized gases. Observe pressurized gas handling precautions. Pressurized gas should only be handled by suitably trained personnel.

The TDL600 measurement chamber requires pressurized gas to be connected to it. Observe pressurized gas handling regulations. Only suitably trained personnel should carry out tasks that include the use of pressurized gas media.

The TDL600 measurement cell accepts a maximum sample pressure of 1.4 bara (20.3 psia).

2.7 Basic Installation Guidelines

The OptiPEAK TDL600 Moisture Analyzer Sampling System gas handling components are assembled onto a stainless steel mounting plate suitable for wall mounting.

The outdoor version Sampling System provides environmental ingress protection to IP66 and should be mounted vertically, free of any appreciable vibration, in a permanently shaded position to prevent heating effects through sun radiation. The Sampling System enclosure can be specified with optional thermostatically controlled heating (fixed set point). Optional enclosure cooling, using a compressed-air-driven vortex tube and fixed set point thermostat, is recommended for installation in hot climates (>+45°C (>+113°F)).

NOTE: Any TDL being installed within a plant where it cannot vent to open atmosphere needs a flare line connection that runs to the highest point and enters the flare system from a topside connection. This is to prevent liquids present in the flare stack from draining back into the analyzer system.

NOTE: The actual detailed configuration will be shown in the as-built drawings provided with the shipped analyzer.

For start-up instructions refer to Section 3.

1	BV1	Ball Valve
2	F2	Particulate Filter
3	PR1	Pressure Regulator
4	PG1	Pressure Gauge
5	PR2	Pressure Gauge
6	F2	Coalescing & Membrane Filter
7	PR2	Pressure Regulator
8	PG3	Pressure Gauge
9	PRV1	Pressure Relief Valve
10	FM1	Flowmeter
11	AN1	Moisture Analyzer
12	MV1	Metering Valve
13	NV1	Needle Valve
14	FM2	Flowmeter

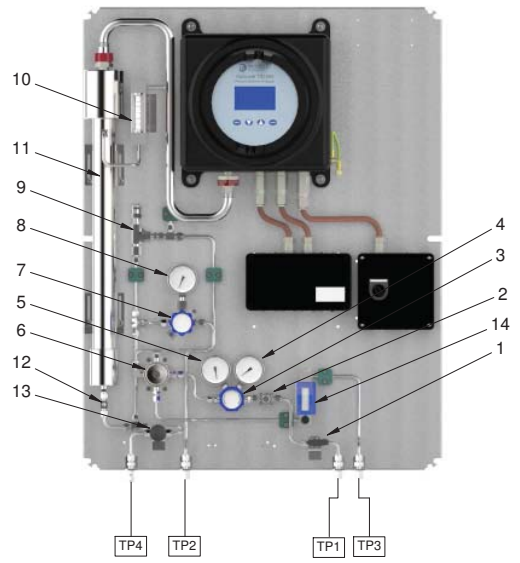

TP Connections		
TP1	Sample Gas Inlet	1/4" NPT (F)
TP2	Sample Gas Outlet	1/4" NPT (F)
TP3	Bypass Flow Gas Outlet	1/4" NPT (F)
TP4	Letdown Gas Vent/Drain	1/4" NPT (F)

Figure 6 OptiPEAK Sampling System - Typical Indoor Version

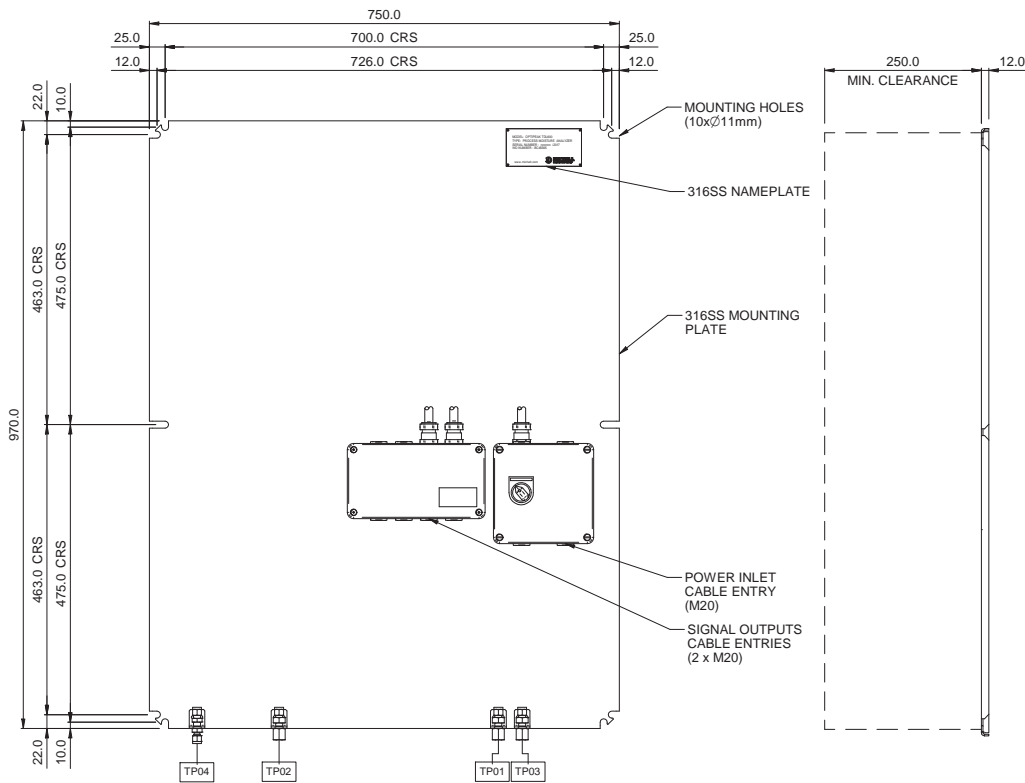
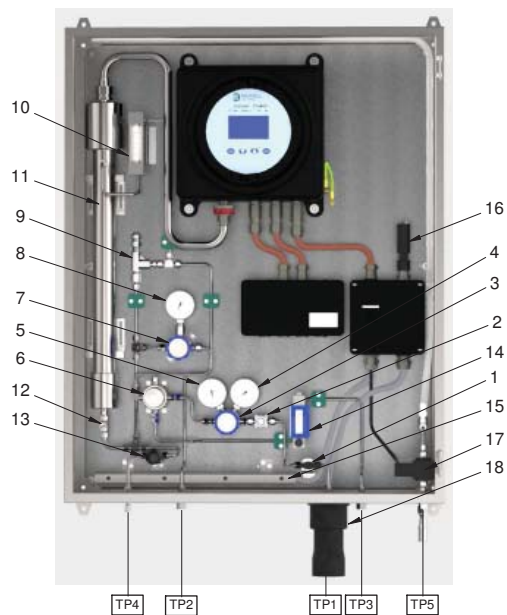

Figure 7 OptiPEAK Sampling System - Typical Indoor Version

1	BV1	Ball Valve
2	F2	Particulate Filter
3	PR1	Pressure Regulator
4	PG1	Pressure Gauge
5	PG2	Pressure Gauge
6	F2	Coalescing & Membrane Filter
7	PR2	Pressure Regulator
8	AN1	Pressure Gauge
9	FM1	Pressure Relief Valve
10	PRV1	Flowmeter
11	TS1	Moisture Analyzer
12	MV1	Metering Valve
13	FM2	Needle Valve
14	NV1	Flowmeter
15	HT	Enclosure Heater
16	TS1	Thermostat
17	SOV1	Solenoid Valve
18	TH	Trace Heating



TP Connections		
TP1	Sample Gas Inlet	1/4" NPT (F)
TP2	Sample Gas Outlet	1/4" NPT (F)
TP3	Bypass Flow Gas Outlet	1/4" NPT (F)
TP4	Letdown Gas Vent/Drain	1/4" NPT (F)
TP5	Vortex Cooler Inlet	1/4" NPT (F)

Figure 8 OptiPEAK Sampling System - Typical Outdoor Version

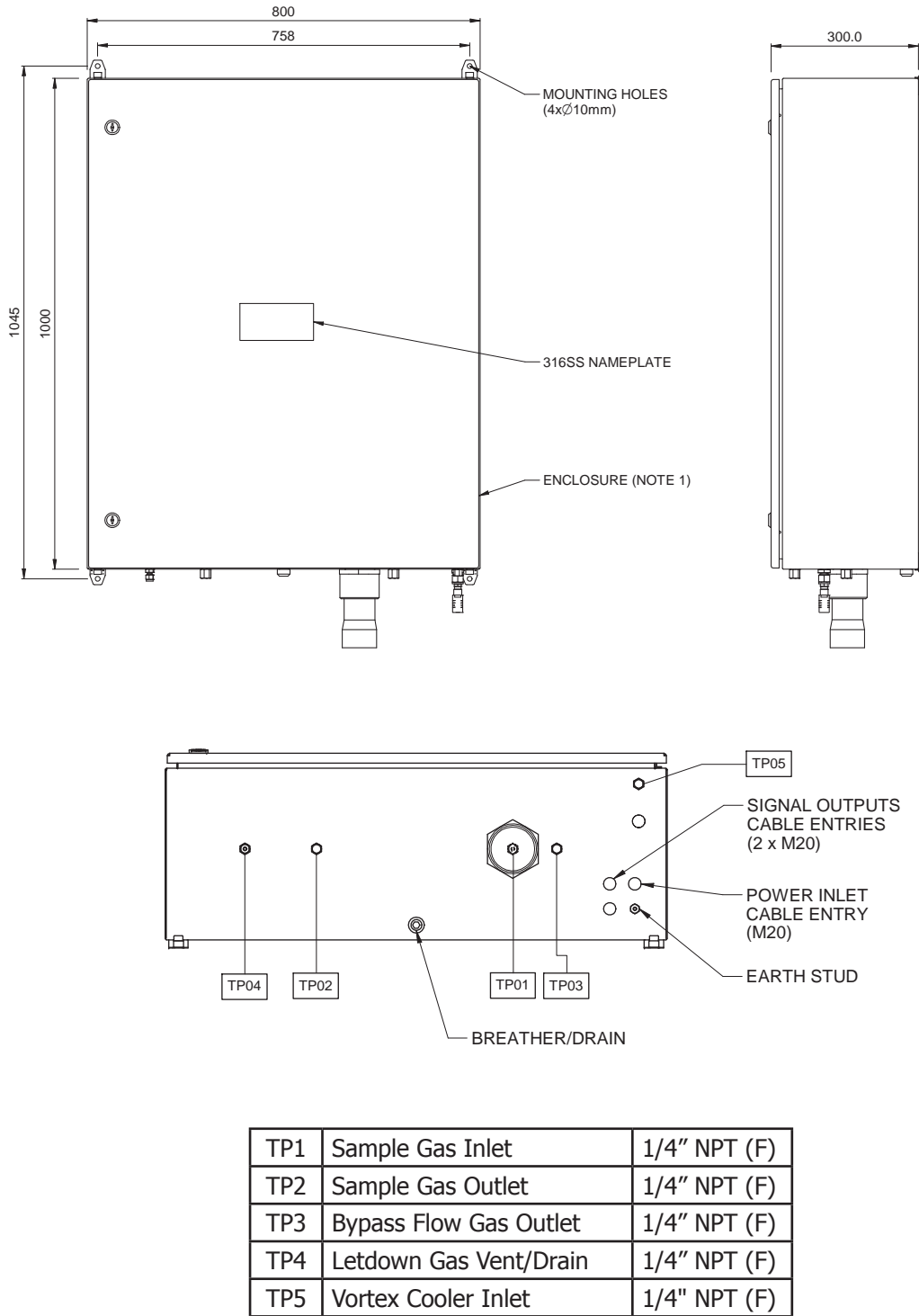

Figure 9 OptiPEAK Sampling System - Typical Outdoor Version

2.8 Electrical Connections

All electrical connections to the TDL600 are made through junction boxes JB1 & JB2 (**ATEX, IECEx and NEC500 Class I, Division 2 versions only**).



WARNING:
Once the mains power connections are made to JB1 the heaters and vortex cooling solenoid (if fitted) will be energized.

This includes:

- Power Connection
- Analog Outputs
- Analog Inputs (line pressure transmitter)
- Alarm Relays
- Modbus RTU / RS485 Connection

For the wiring diagram, consult the appropriate Appendix, depending on whether the TDL600 was supplied with the indoor sample system, or the outdoor sample system:

Indoor Sample System	Appendix B
Outdoor Sample System	Appendix C

2.8.1 Power Connection

A single-phase AC mains power supply is required to operate the Analyzer and Sampling System. The analyzer power supply can accommodate voltages from 90 to 264 V AC, 50/60 Hz. If enclosure heating or cooling options are selected, these will have defined voltage and wattage requirements.

The factory-set power supply voltage is indicated on a yellow label located on the rear panel.
NOTE: The user cannot change the specified power supply voltage.

Cable connections are made onto terminals within the Power Circuits junction box. Cable entry into the junction box is provide via M20 threaded holes (fitted with certified stopping plugs). Suitably certified cable glands should be used (not supplied).

The power connection is made through JB1 (**ATEX, IECEx and NEC500 Class I, Division 2 versions only**) – refer to the appropriate Appendix.

Terminals are marked:

Terminal No.	Power Supply
1	Live
5	Neutral
	Earth

NOTE: An earth stud is provided in the base of the enclosure. This must be used to earth bond the Sampling System.

A power isolator switch is provided on the Power Circuits junction box for local power isolation of the OptiPEAK TDL600 Moisture Analyzer (Main Unit only) for maintenance or servicing. **NOTE: This switch isolates the analyzer but does not isolate power from ancillaries such as the heating/cooling circuits where fitted.**

2.8.2 Analog Outputs

Three 2-wire analog outputs are provided that can be configured to represent any of the directly measured or calculated output parameters. These outputs are active, self-powered from the analyzer and can be set as either 0-20mA or 4-20mA.

For an overview of the analog output menu, refer to Section 3.7.6.1.

The analog output connections are made through JB2 (**ATEX, IECEx and NEC500 Class I, Division 2 versions only**) – refer to the appropriate Appendix.

2.8.3 Analog Inputs

Input 1	Connection for process line pressure transmitter (optional). Enables dynamic pressure compensation for calculation of moisture content units. 12 V DC excitation power provision for loop powered 4-20mA, 2-wire transmitter. Transmitter must be able to function from 12 V DC excitation, such as typical devices requiring 8 - 30 V DC. Internal sensing resistor 100 Ω.
Input 2	No function

2.8.4 Alarm Relays

Three alarm relays are provided that can be triggered by any of the directly measured or calculated output parameters. Each alarm relay has Common (CO), Normally Open (NO) and Normally Closed (NC) contacts.

For detailed information on the alarms refer to Section 3.7.6.2.

The alarm relay connections are made through JB2 (**ATEX, IECEx and NEC500 Class I, Division 2 versions only**) – refer to the appropriate Appendix.

2.8.5 Modbus RTU / RS485 Connection

The TDL600 features an RS485 port for digital communication, and uses a subset of the Modbus RTU protocol. The RS485 connection should be configured with the following parameters:

Parameter	Value
Baud Rate	9600bps
Data Bits	8
Parity	None
Stop	Bits 2

A full list of Modbus registers can be found in Appendix E.

The RS485 connection is made through JB2 (**ATEX, IECEx and NEC500 Class I, Division 2 versions only**) – refer to the appropriate Appendix.

2.9 Environmental Requirements

The environmental requirements of the analyzer (complete with sampling system) are as follows:

Temperature

Indoor version +10 to +45°C (+50 to +113°F)

Outdoor version -20 to +45°C (-4 to +113°F)

Outdoor version with enclosure cooling option -20 to +55°C (-4 to +131°F)

Temperature (Storage)

-30 to +60°C (-22 to +140°F)

Relative Humidity

Less than 90% RH

If installed outside, the analyzer must be in a shaded position to prevent heating effects through sun radiation.

2.10 Sample Conditioning Requirements

Sample extraction, handling and conditioning techniques are of critical importance to assure optimal performance and reliability of all gas analyzers that accurately quantify specific components within a process gas composition. Michell Instruments' recommendations and requirements in relation to the OptiPEAK TDL600 are outlined below.

Michell Instruments offers a range of sample extraction probes and sample conditioning systems that have been selected and designed to exceed these minimum requirements. For further information and advice please contact your local Michell office or distributor – refer to contact details on www.michell.com.

2.10.1 Gas Connections



Ensure that the process sample gas supply line is well flushed through to clear any liquids and debris present, prior to connection to the Sampling System.

Connections are as follows - refer to Flow Diagram in Appendix D:

- TP1 Sample Gas Inlet
- TP2 Sample Gas Outlet
- TP3 Bypass Outlet
- TP4 System Vent/Drain

TP1 to TP3 are 1/4" NPT(F), TP4 is 1/4" OD.

2.10.2 Sample Flow Gas Handling Components

The sample flow gas handling components are as follows:

- **Gas Inlet Isolation Valve (BV1):**
Allows user to manually isolate the system from the process sample gas supply line for maintenance or servicing.
- **Particulate Filter (F1):**
Provides protection to regulator from particulates
- **Line Pressure Gauge (PG1):**
Indicates the sample gas line pressure.
- **Pressure Regulator 0-35 Bar (PR1):**
Allows the user to manually set the sample gas analysis pressure for moisture measurement. 1st stage pressure regulation.
- **Regulated Pressure Gauge (PG2)**
Indicates pressure set on PR1.

- **Particulate/Coalescing Filter (F2):**
Provides system protection from contamination of entrained liquids and particulates using membrane filtration.
- **Pressure Regulator 0-4 Bar (PR2):**
2nd stage pressure regulation for moisture measurement.
- **Input Pressure Gauge (PG3):**
Indicates cell input pressure as set at PR2.
- **Insert Pressure Relief Valve (PRV1)**
Protects AN1 from over pressure
- **Metering Valve (MV1):**
Allows the user to manually set the sample gas flowrate into the TDL gas cell.
- **Moisture Analyzer (AN1):**
TDL600 Process Moisture Analyzer
- **Flowmeter (FM1):**
Provides indication of the sample gas flow rate through the TDL gas cell.
- **System Drain Needle Valve (NV1):**
Allows the user to manually letdown the sample gas pressure trapped in the system for maintenance or servicing.

The bypass flow gas handling components are as follows:

- **Bypass Flowmeter & Valve (FM2):**
Allows the user to manually set and provide indication of the bypass gas flow rate across the membrane filter.

Sample Extraction and Impulse Tubing

An insertion probe, with tip positioned within the central one-third of the cross-sectional area of the pipe, should be used to extract a sample with a composition that is representative of the majority of gas flowing within the pipeline. Attention should be given to the installation of impulse tubing connecting from the sample probe to the analyzer sample conditioning system. Analytical grade acid-etched stainless steel tubing should be used, which has a low moisture sorption capacity. Tube size should be 1/8" or 3mm diameter, or 1/4" or 6mm as a maximum, to ensure that sample transportation delay time is kept to a minimum. Likewise, to ensure the best dynamic response of the complete installed analyzer system, the positioning of the analyzer with sample conditioning system should be as close to the sample extraction probe as possible.

To avoid any risk of condensation forming during transportation to the analyzer, and so ensure that the integrity of the sample gas is maintained, the temperature of the sample impulse tubing must be maintained at a temperature above the highest envisaged water dew point. It is recommended that the sample tubing temperature is maintained at least 5°C (10°F) above the maximum water dew point at the prevailing pressure, as a suitable 'safety' margin. Self-limiting heating cable should be applied to the complete length of the impulse tube, enclosed within suitable insulation. Trace heated tube bundle is a factory fitted option for Michell-produced sample conditioning systems.

Sample Conditioning System

The Michell designed sample conditioning system addresses the needs for filtration, pressure reduction and sample flow control. To maintain cleanliness of the analyzer's optical detection system, the process sample flow is filtered to eliminate entrained liquids and particles. To provide protection against hydrocarbon condensates and compressor oils that may be present in process natural gas, we use a micro-porous membrane filtration with an oleophobic element specifically intended to reject such low-surface tension liquids. Pressure reduction and sample flow control can achieve 0.5 NI/min (1 scfh) sample flow at atmospheric pressure. Flow control is achieved by a fine metering valve operating with a low upstream pressure and located at the inlet to the analyzer optical cell. Flow indication on the outlet of the analyzer optical cell is achieved with a variable area flow meter without a flow valve so as to avoid any significant back-pressure.

The sample gas exhaust should vent freely to atmosphere to avoid any significant back pressure to the analyzer optical cell. A suitable flame arrestor can be installed at the final vent point, which should be selected in accordance with site safety requirements governing such atmospheric release of gas. The bypass flow from the membrane filter could be taken to the site flare system, as back-pressure is less critical in that case (maximum 3 barg).

The enclosure for outdoor installed systems must be located within 100% shade from direct sun, by the addition of an effective sun canopy, if necessary.

Combined Sample Extraction Probe with Integral Membrane Filter and Pressure Reduction

It is possible to simplify the sample extraction and sample conditioning requirements by use of an insertion sample probe that incorporates membrane filtration with sample pressure reduction. The design of such combination probes has both the membrane filter element and the pressure regulation control device at the tip of the probe, so within the process pipeline flow. Final filtration and sample pressure reduction should still be provided within the analyzer sampling system.

2.11 Options

2.11.1 Enclosure Heater Temperature Control (Outdoor systems ONLY)

Sampling systems fitted within enclosures are temperature controlled to maintain a constant temperature environment of at least 10°C (18°F) above the highest envisaged dew-point temperature, independent of surrounding temperature variations. The temperature control system consists of a heater controlled by a fixed preset thermostat to provide internal ambient air temperature control of +20°C (>+68°F).

2.11.2 Vortex Cooling (Outdoor systems ONLY)

A sampling system enclosure cooling kit can be fitted to the stainless steel enclosure. The cooling device is a Vortex tube driven by instrument grade (liquid and particulate free) compressed air. A fixed thermostat maintains an internal ambient <+40°C (104°F) controlling a solenoid valve permitting the flow of compressed air through the Vortex tube. A manifold (clear plastic pipe) positioned around the internal walls of the enclosure distributes the cooling air throughout.

2.11.3 Trace Heated Sample Line

As an option, a trace heated sample line can be supplied with the Sampling System. This ensures that the sample gas temperature from the process take-off point to the analyzer is maintained at a constant temperature, independent of surrounding temperature variations.

The trace heated tubing bundle consists of 6mm or ¼" OD 316L stainless steel seamless tube and BSX™ self-regulating heating cable with non-hygroscopic glass fiber insulation and polymer outer jacket.

The self-regulating heat output of BSX™ cable varies in response to the surrounding conditions along the entire length of a circuit. Whenever the heat loss increases (as the ambient temperature drops), the heat output of the cable increases. Conversely when the heat loss decreases (as the ambient temperature rises), the cable reacts by reducing its heat output.

Operation of the trace heated sample line is fully automatic. Once a mains power supply is provided then no further adjustment is required.

The trace heated sample line is connected directly onto the **Gas Inlet Isolation Valve** (via the bulkhead entry seal gland, when fitted to an enclosure) within the Sampling System and the heating cable is terminated onto terminals within the Power Circuits junction box. Cable entry into the junction box is via an EExe cable gland (supplied).

See wiring diagram for termination details (Appendix C).

3 OPERATION

Operation of the OptiPEAK TDL600 Sampling System should be carried out in conjunction with, and referring to, this manual, prior to commencing the System Start-Up Procedure (Section 3.1).

Before commencing the start-up procedure it is essential to ensure that the installation conforms to the correct hazardous area and local plant standards.

Before any gas pressure is applied, check that all gas inlet & outlet connections are fully tightened up and that all valves and regulators are in the closed position.

Additionally, for the outdoor version, the heater/thermostat circuit will need to achieve the set-point temperature.



BEFORE power is applied to the Sampling System check that the OptiPEAK TDL600 Power Isolator switch (JB1) is set to the OFF position.

Check that all customer supplied cables are according to certificated approved specifications and, as a minimum, are as described below:

Recommended Customer Cable Requirements	
Power Cable	3 core, 0.75mm ² conductor area (6A)
Communications Cable	For use with 4-20 mA only or Modbus only 1 pair individually screened 0.5mm ² (min) conductors with an overall screen (BS5308 or equivalent)
	For use with 4-20 mA and Modbus 2 pair individually screened 0.5mm ² (min) conductors with an overall screen (BS5308 or equivalent)

3.1 Start-Up Procedure

See Flow Diagram in Appendix D.



If the unit is left in storage for an extended period prior to installation, it is recommended that the system be run on the sample gas for up to 24 hours before use to allow for proper system dry down.

1. Switch on the analyzer power using the Power Isolator Switch (JB1).



WARNING:
Once the mains connections are made to JB1 the heaters and vortex cooling solenoid (if fitted) will be energized.

2. Ensure the System Drain Needle Valve (NV1) is **CLOSED**.
3. Ensure the Measurement Cell Pressure Regulators (PR1 & PR2) and Bypass Flow Metering Valve (FM2) are fully **CLOSED**.
4. Ensure the Measurement Cell Metering Valve (MV1) is fully **CLOSED**.
5. Slowly **OPEN** the Gas Inlet Isolation Valve (BV1) to allow sample gas to enter the Sampling System.
6. Perform leak tests using snoop (or equivalent leak test fluid) on any new system gas connections.
7. Set Pressure Regulator (PR1) to 20 barg, indicated on PG2 and then adjust the Measurement Cell Pressure Regulator (PR2) to show 2 barg on Pressure Gauge (PG3).
8. Adjust the Bypass Flow Metering Valve (FM2) to indicate a gas flow rate of approximately 3 NI/min (6.5 scfh).
9. Adjust the Measurement Cell Flow Metering Valve (MV1) to indicate a sample gas flow rate of approximately 0.5 NI/min (1 scfh) on the Measurement Cell Flow Meter (FM1).
10. Close the enclosure door and allow the system temperature to stabilise.

3.2 Shut Down Procedure

1. Isolate the Sampling System from the sample gas supply line by **CLOSING** the Gas Inlet Isolation Valve (BV1).
2. Allow approximately 2 minutes for the Sampling System to begin to depressurize. Fully depressurize the Sampling System by **CLOSING** the Bypass Flow Metering Valve (FM2) and **OPENING** the System Drain Needle Valve (NV1).
3. Ensure the Power Isolator switch (JB1) is in the **OFF** position.
4. After approximately 2 minutes close the System Drain Needle Valve (NV1).

3.3 User Interface

The OptiPEAK features a 4.3" color display.

3.3.1 Interface Controls

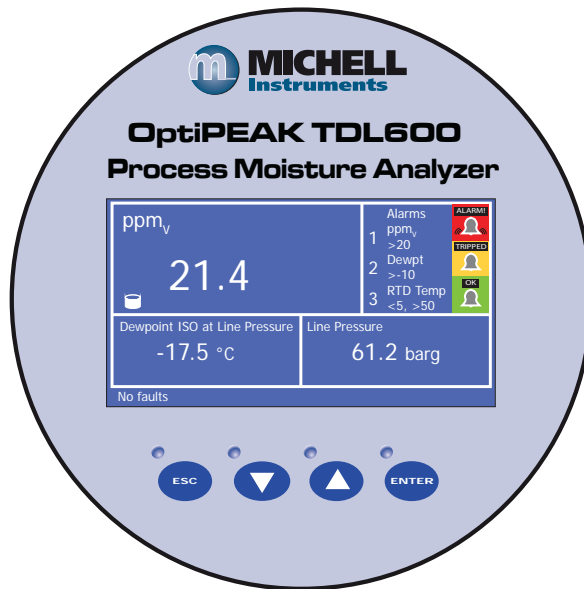

Figure 10 *User Interface*

Four capacitive touch keys are used to navigate the menu system.

Key presses are detected through the glass front panel, and are indicated by a blue LED above the key.

3.3.2 'Up/Down Arrow' Keys



Figure 11 *Up/Down Arrow Keys*

The **Up** (▲) and **Down** (▼) keys are used to change pages, scroll through lists and adjust values.

Some parameters, such as the output and alarm minimum and maximum values activate the numerical entry screen. On this screen, the **Down** (▼) key selects the next digit and the **Up** (▲) key changes the value of the currently selected digit.

3.3.3 'ENTER' Key



Figure 12 'ENTER' Key

The **ENTER** key is used to select or de-select a highlighted item in a menu list.

Some parameters, such as the output and alarm minimum and maximum values activate the numerical entry screen. On this screen, the **ENTER** key accepts the displayed value and returns to the previous screen.

3.3.4 'ESC' Key



Figure 13 'ESC' Key

The **ESC** key is used to return to the previous menu, Run-Mode Screen, Main Menu or Advanced Settings Screen.

Some parameters, such as the output and alarm minimum and maximum values activate the numerical entry screen. On this screen, the **ESC** key discards the new value and returns to the previous screen.

3.4 Description of Measured Parameters

ppm _v	parts per million of H ₂ O by volume
lb/MMscf	pounds H ₂ O per million standard cubic feet (20°C, 101.325KPa)
Pw	partial vapor pressure of H ₂ O in kilopascals
Dewpoint ISO	dew-point temperature (with respect to ice below 0°C), natural gas (ISO18453)
Dewpoint IGT	dew-point temperature (with respect to ice below 0°C), natural gas (IGT Bulletin 8)
DP Ideal	dew-point temperature
mg/m ³	milligrams H ₂ O per cubic meter (15°C, 101.325 kPa)
Line Pressure*	Line pressure from current (mA) input
Spare Input*	Spare current loop input for a user-connected device

* Available as secondary or tertiary parameter only

3.5 Default Settings

On initial start up, the TDL600 Regional Setting is set to EU and metric units (i.e. Dew Point to ISO 18453 and °C) are selected. The Regional Setting can be changed to US (see section 3.7.6.6), this applies US standard units (i.e. lb/MMscf and °F). The default settings are shown here:

Top level menu - EU region	Top level menu - US region
Parameters	
Primary: ppm _v	Primary: ppm _v
Secondary: Dew-point ISO	Secondary: lb/MMscf
Tertiary: mg/m ³	Tertiary: Dew-point ISO
Display	
Pressure units: barg	Pressure units: psig
Temperature units: °C	Temperature units: °F
Resolution (dp): 1	Resolution (dp): 1
Brightness (%): 100	Brightness (%): 100
Log menu	
Logging disabled as default	Logging disabled as default

3.5.1 Advanced Menu default settings

Outputs

Output 1

Parameter: ppm_v
 Type: 4-20 mA
 Minimum: 0
 Maximum: 1000

Output 2

Parameter: ppm_v
 Type: 4-20 mA
 Minimum: 0
 Maximum: 0

Output 3

Parameter: ppm_v
 Type: 4-20 mA
 Minimum: 0
 Maximum: 0

Alarms

All alarms disabled as default

Inputs

All inputs disabled as default

Modbus

Device Address: 1
 Baud: 9k6

3.6 Menu Structure

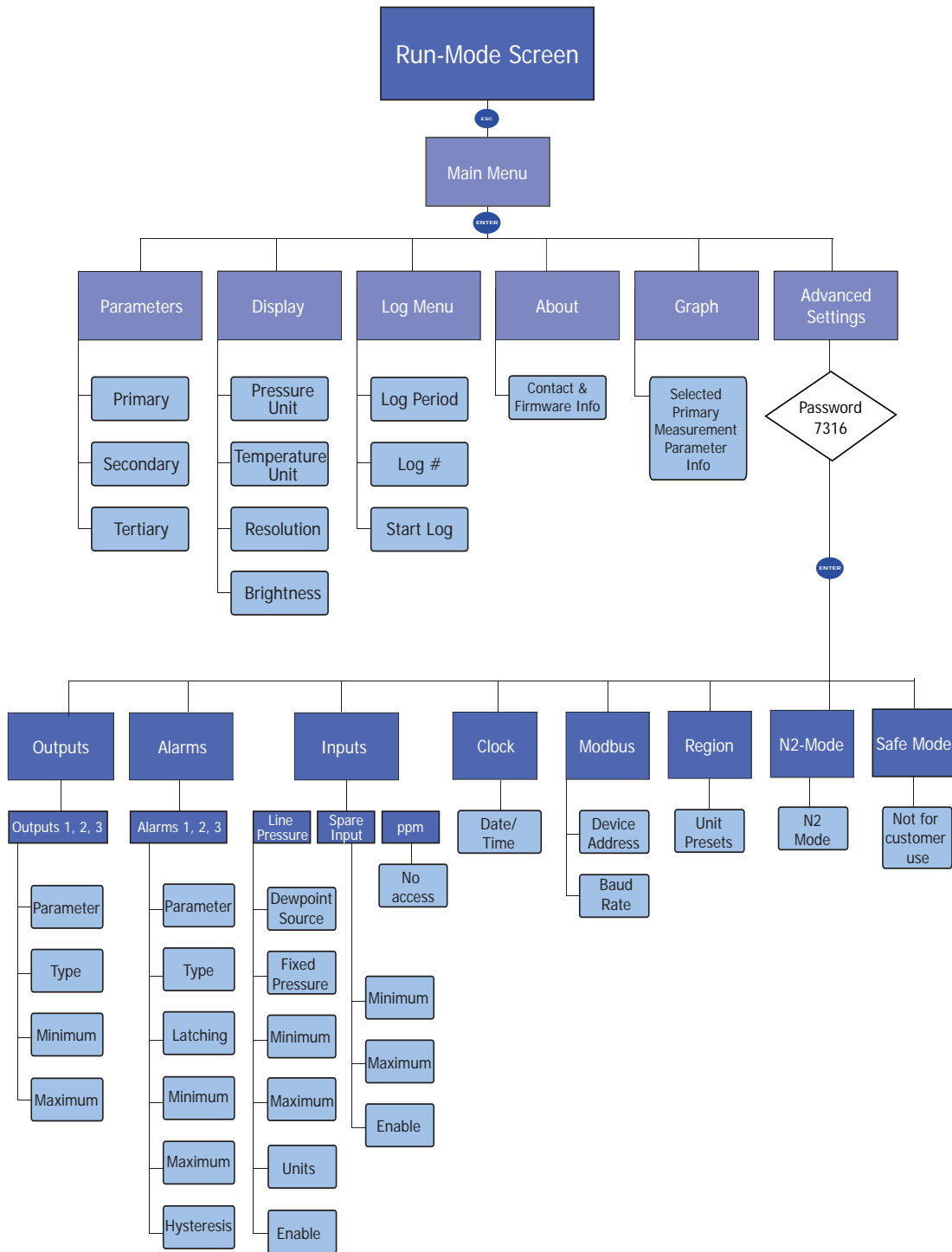



KEY		
		
Press Up/Down keys to change pages, scroll through lists & adjust values. Max/Min values activate the numerical entry screen. Press Down key to select digit & Up key to change value of selected digit.	Press ESC key to get back to Main Menu, Advanced Menu or Run Mode Screen depending on location. Max/Min values activate the numerical entry screen. Press ESC key to discard new value & return to previous screen.	Press ENTER key to select or de-select a highlighted item in a menu list. Max/Min values activate the numerical entry screen. Press ENTER key to accept the displayed value & return to previous screen.

Figure 14 Menu Structure

3.7 Main Menu Screen

All instrument operating parameters, logging information, and advanced settings for outputs, alarms and pressure are available through this screen.

This screen is accessed by pressing the **ESC** key from the Run-Mode Screen.

Use the **Up** (▲) and **Down** (▼) keys to highlight the page of interest and press the **ENTER** key to access.

Press the **ESC** key to return to the Run-Mode Screen.

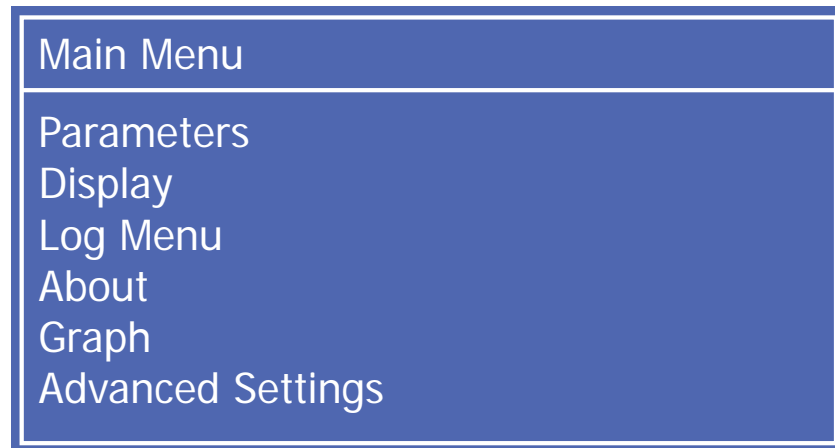

Figure 15 *Main Menu Screen*

3.7.1 Parameters Screen

The Parameters Screen controls which measured or calculated parameters are shown on the Run-Mode Screen.

This screen is accessed by pressing the **ENTER** key from the Main Menu Screen.

Use the **Up (▲)** and **Down (▼)** keys to highlight the parameter of interest and press the **ENTER** key to access. Use the **Up (▲)** and **Down (▼)** keys to choose the option required and press the **ENTER** key to accept.

Press the **ESC** key to return to the Main Menu Screen.

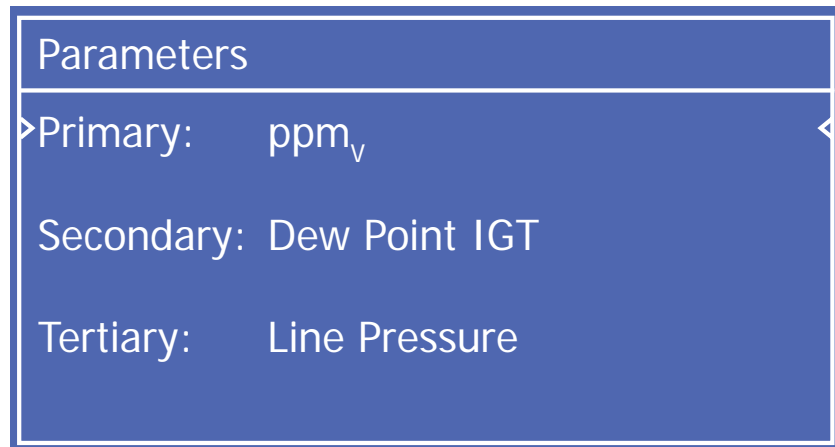

Figure 16 Parameters Screen

Parameter	Description
Primary	Parameter shown on large, top left pane of Run-Mode Screen Available Options: ppm _v , DP Ideal, Dewpoint IGT, Dewpoint ISO, Pw, mg/m3, lb/MMscf
Secondary	Parameter shown on the leftmost smaller pane of Run-Mode Screen Available Options: ppm _v , Line Pressure, Spare Input, DP Ideal, Dewpoint IGT, Dewpoint ISO, Pw, mg/m3, lb/MMscf
Tertiary	Parameter shown on the rightmost smaller panel of Run-Mode Screen Available Options: ppm _v , Line Pressure, Spare Input, DP Ideal, Dewpoint IGT, Dewpoint ISO, Pw, mg/m3, lb/MMscf

Table 1 Parameters Screen Parameters

3.7.2 Display Screen

The Display Setup Screen controls which units are used for temperature and pressure on the display, alarm, and analog output screens. It also enables the brightness and display resolution to be set.

This screen is accessed by pressing the **ENTER** key from the Main Menu Screen.

Use the **Up** (▲) and **Down** (▼) keys to highlight the parameter of interest and press the **ENTER** key to access. Use the **Up** (▲) and **Down** (▼) keys to choose the option required and press the **ENTER** key to accept.

Press the **ESC** key to return to the Main Menu Screen.

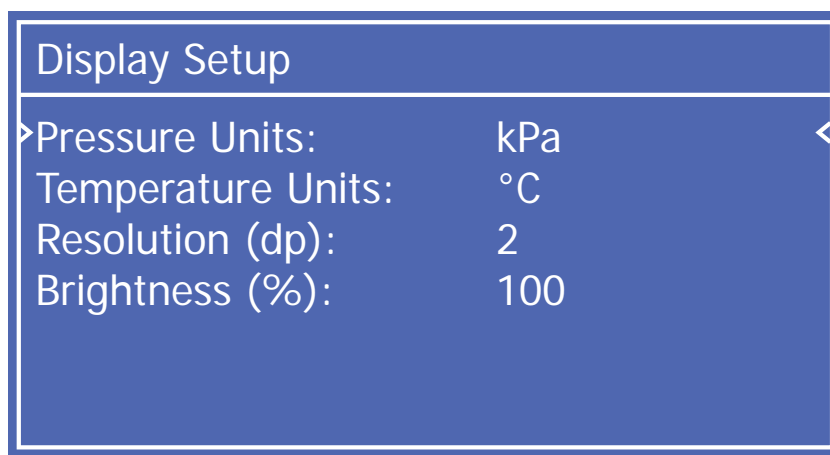

Figure 17 *Display Setup Screen*

Parameter	Description
Pressure Units	Pressure unit used for cell pressure Available Options: psig, psia, MPa, kPa, barg, bara
Temperature Units	Temperature units used for dew point and temperature Available Options: °C, °F
Resolution (dp)	Number of decimal places used for display units Available Options: 0, 1, 2
Brightness (%)	Brightness of display backlight Available Options: 20 to 100%

Table 2 *Display Setup Screen Parameters*

3.7.3 Log Menu Screen

The Data Logging Screen allows data-logging to the SD card, which is fitted to the rear of the display PCB. Refer to Section 4.2 for instructions on fitting and removing the SD card.

When logging is active it will be indicated by a disc icon  on the Run-Mode Screen.

This screen is accessed by pressing the **ENTER** key from the Main Menu Screen.

Use the **Up** (▲) and **Down** (▼) keys to highlight the parameter of interest and press the **ENTER** key to access. Use the **Up** (▲) and **Down** (▼) keys to choose the option required and press the **ENTER** key to accept.

Press the **ESC** key to return to the Run Mode Screen.

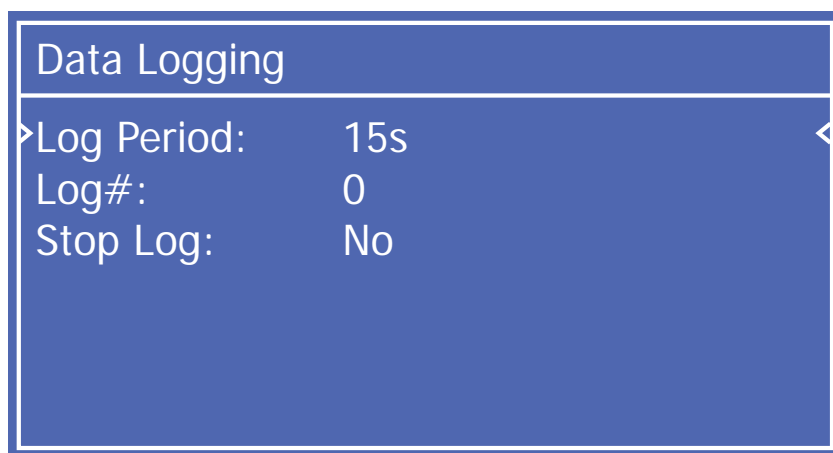

Figure 18 *Data Logging Screen*

Parameter	Description
Log Period	Sets the interval at which data is recorded in the log file Available Options: 15s, 1min, 5min, 30min, 1hr, 4hrs, 24hrs
Log #	0 - 9
Stop Log	Yes/No

Table 3 *Data Logging Screen Parameters*

3.7.4 About Screen

The Contact/About Screen shows the current firmware version and company contact information.

This screen is accessed by pressing the **ENTER** key from the Main Menu Screen.

Press the **ESC** key to return to the Run Mode Screen.



Figure 19 *Contact/About Screen*

3.7.5 Graph Screen

The Graph screen shows a graph of primary measurement parameter over time.

This screen is accessed by pressing the **ENTER** key from the Main Menu Screen.

The **Down** (▼) key changes the scale of the selected primary measurement parameter axis. The **Up** (▲) key changes the scale of the time axis.

Press the **ESC** key to return to the Run Mode Screen.

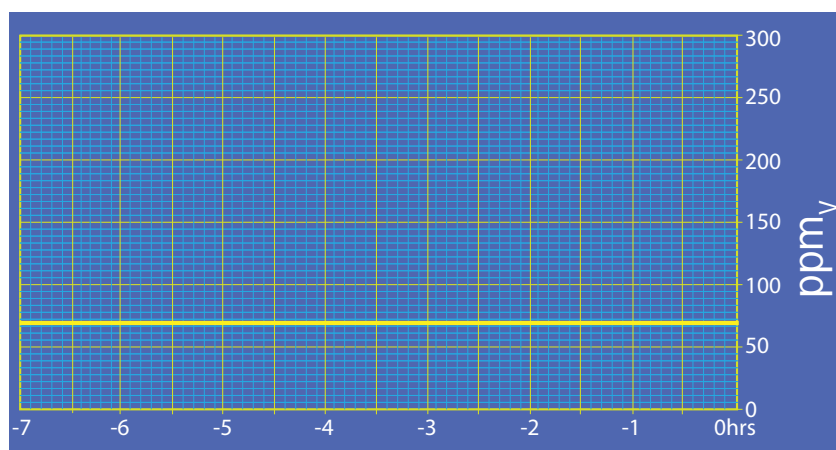

Figure 20 *Graph Screen*

3.7.6 Advanced Settings Screen

This screen is accessed by pressing the **ENTER** key from the Main Menu Screen.

Passcode

To safeguard against unauthorized adjustment of Advanced Settings options, an entry lock is provided.

The user must first input the access code **7316**.

The **Down** (▼) key selects the digit and the **Up** (▲) key changes the value of the currently selected digit. Press the **ENTER** key to access the Advanced Settings Options Screen.

After the passcode is entered use the **Up** (▲) and **Down** (▼) keys to choose the option required and press the **ENTER** key or press the **ESC** key to return to the Run-Mode Screen.

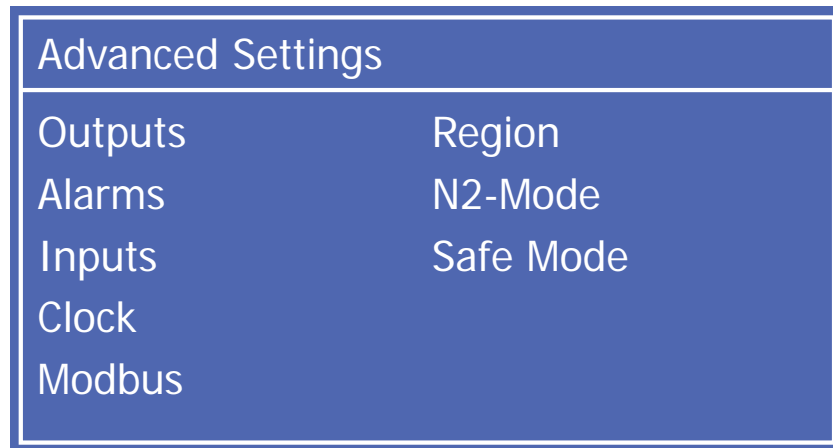

Figure 21 *Advanced Settings Screen*

Advanced Settings Screen Options

- Outputs
- Alarms
- Inputs
- Clock
- Modbus
- Region
- N2-Mode
- Safe Mode

3.7.6.1 Outputs Screen

This screen is accessed by pressing the **ENTER** key from the Advanced Settings Screen.

Use the **Up** (▲) and **Down** (▼) keys to highlight the Output required and press the **ENTER** key to access.

On the Setup Screen use the **Up** (▲) and **Down** (▼) keys to highlight the parameter of interest and press the **ENTER** key to access. Use the **Up** (▲) and **Down** (▼) keys to choose the option required and press the **ENTER** key to accept.

Some parameters, such as the output minimum and maximum values activate the numerical entry screen. On this screen, the **Down** (▼) key selects the next digit and the **Up** (▲) key changes the value of the currently selected digit. The **ENTER** key accepts the displayed value and returns to the previous screen. The **ESC** key discards the new value and returns to the previous screen.

Press the **ESC** key to return to the previous screen.

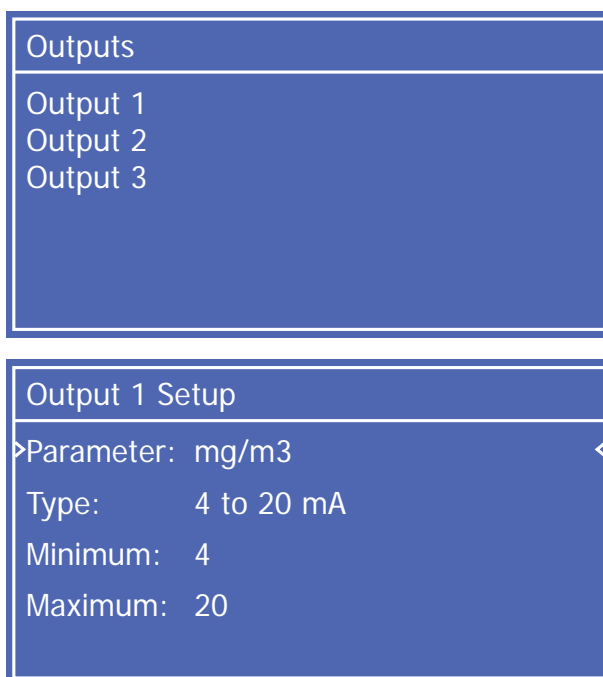

Figure 22 *Output Screens*

Parameter	Description
Parameter	The parameter used to control the selected output Available Options: ppm _v , Line Pressure, Spare Input, DP Ideal, Dewpoint IGT, Dewpoint ISO, Pw, mg/m3, lb/MMscf
Type	Type of current output Available Options: 0-20 mA, 4-20 mA
Minimum	Minimum value for current output range (0 mA or 4 mA)
Maximum	Span value for current output range (20 mA)

Table 4 *Output Screen Parameters*

3.7.6.2 Alarms Screen

The Alarm Setup Screens are accessed by pressing the **ENTER** key from the Advanced Settings Screen.

Use the **Up** (▲) and **Down** (▼) keys to highlight the Alarm required and press the **ENTER** key to access.

On the Setup Screen use the **Up** (▲) and **Down** (▼) keys to highlight the parameter of interest and press the **ENTER** key to access. Use the **Up** (▲) and **Down** (▼) keys to choose the option required and press the **ENTER** key to accept.

Some parameters, such as the output minimum and maximum values activate the numerical entry screen. On this screen, the **Down** (▼) key selects the next digit and the **Up** (▲) key changes the value of the currently selected digit. The **ENTER** key accepts the displayed value and returns to the previous screen. The **ESC** key discards the new value and returns to the previous screen.

Press the **ESC** key to return to the previous screen.

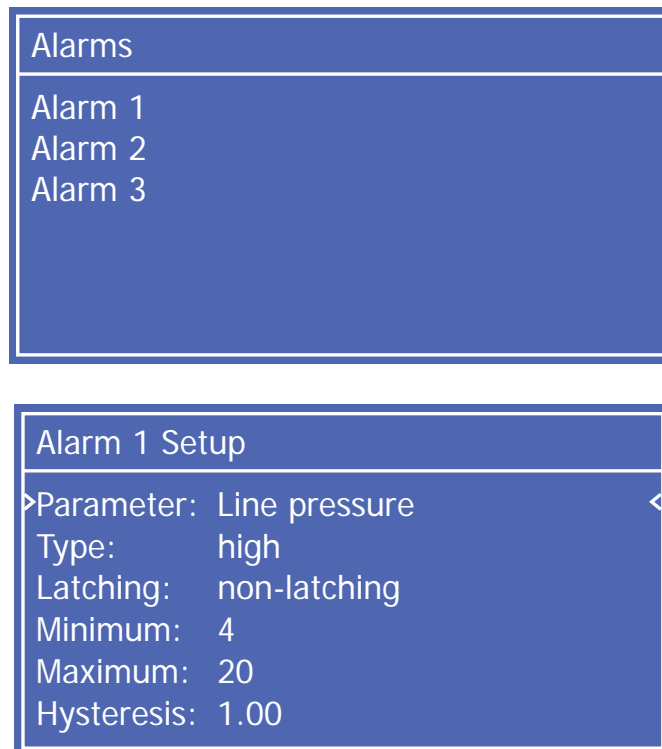

Figure 23 Alarm Screens

Alarm Parameter

When the alarm type is set to **High**, **Low**, or **Out of Band**, the parameter can be set to any of the following:

ppm_v
 Line Pressure
 Spare input
 DP ideal
 Dew Point IGT
 Dew Point ISO
 Pw
 mg/m³
 lb/MMscf

The following behaviours can be set for each alarm:

Alarm Type	Trigger Condition	Reset Condition
low Triggers when parameter is below specified minimum	Parameter < Min. – Hyst/2	Parameter > Min. + Hyst/2
high Triggers when parameter is above specified maximum	Parameter > Max. + Hyst/2	Parameter < Max. - Hyst/2
disabled Alarm is disabled	N/A	N/A
fault Triggers when fault is active, or any other alarm is triggered	Fault or any alarm triggered	Fault cleared and other alarms reset
out of band Triggers when parameter is outside of specified band	Parameter > Max. + Hyst/2 OR Parameter < Min. – Hyst/2	Parameter < Max. - Hyst/2 OR Parameter > Min. + Hyst/2

Latching

Each alarm can also be configured as Latching or Non-Latching.

With Latching alarms, the alarm relay remains energized after the alarm has been reset – the alarm will then enter the tripped state. The tripped state can be cleared by disabling the alarm and then re-enabling it.





Fault Alarm

A Fault alarm is triggered by any parameter alarm, or by any of the fault conditions below. Fault messages are displayed on the bottom line of the Run-Mode Screen. If more than one fault is active, they are displayed cyclically at two-second intervals. If no faults are active, the message **No Faults** is displayed. The Minimum, Maximum and Hysteresis settings are not used for a Fault alarm.

Bit #	Error Status (2.01 Firmware)
0	Invalid config data
1	EEPROM read failure
2	EEPROM write failure
3	Analog o/p write error
4	Line Pressure out of range
5	Spare Input out of range
6	PD signal out of range
7	SD Card not found
8	Data log to SD Fail
9	Spectrum Save to SD Fail
10	Ref Spectra not found
11	Spectrum Serial Rx Fail
12	PD signal low
13	PD signal too low
14	PCB temperature too low
15	PCB temperature too high
16	Alarm 1 active
17	Alarm 2 active
18	Alarm 3 active
19	Laser temp control fail
20	Units Changed

Alarm Status Icons

The following status icons are shown on the main screen for each alarm, depending on the alarm state:

			
Disabled	OFF	ON	Tripped

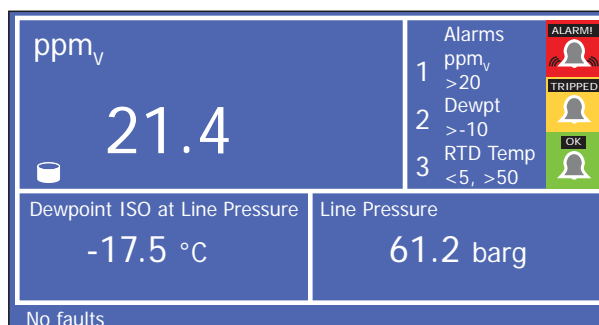

Figure 24 Typical Alarm Status Indication on the Run-Mode Screen

3.7.6.3 Inputs Screen

The Inputs Screen allows access to the Line Pressure Setup Screen, Spare Input Screen and ppm Screen (passcode required). The Line Pressure Setup Screen enables pressure compensation for dew point. A fixed value can be used, or the live value from a pressure transducer if supplied.

The Inputs Screen is accessed by pressing the **ENTER** key from the Advanced Settings Screen.

Use the **Up (▲)** and **Down (▼)** keys to highlight the Input required and press the **ENTER** key to access.

On the Setup Screens use the **Up (▲)** and **Down (▼)** keys to highlight the parameter of interest and press the **ENTER** key to access. Use the **Up (▲)** and **Down (▼)** keys to choose the option required and press the **ENTER** key to accept.

Some parameters, such as the output minimum and maximum values activate the numerical entry screen. On this screen, the **Down (▼)** key selects the next digit and the **Up (▲)** key changes the value of the currently selected digit. The **ENTER** key accepts the displayed value and returns to the previous screen. The **ESC** key discards the new value and returns to the previous screen.

Press the **ESC** key to return to the previous screen.

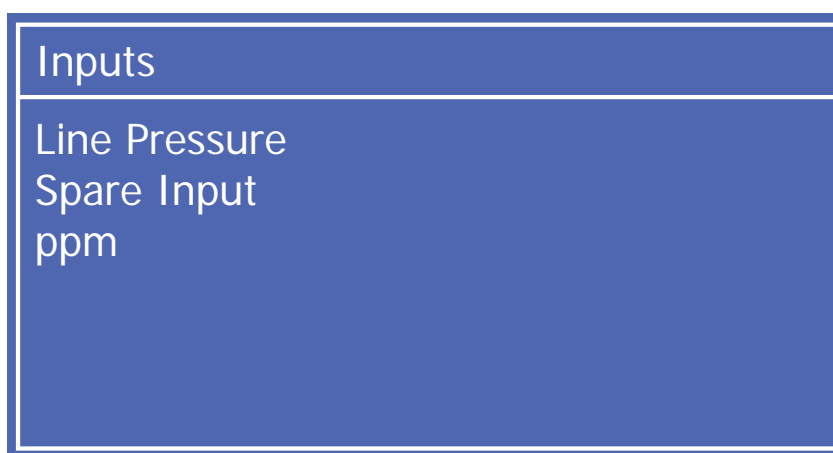

Figure 25 *Input Screen*

Line Pressure Setup

Press the **ESC** key to return to the Inputs Screen.

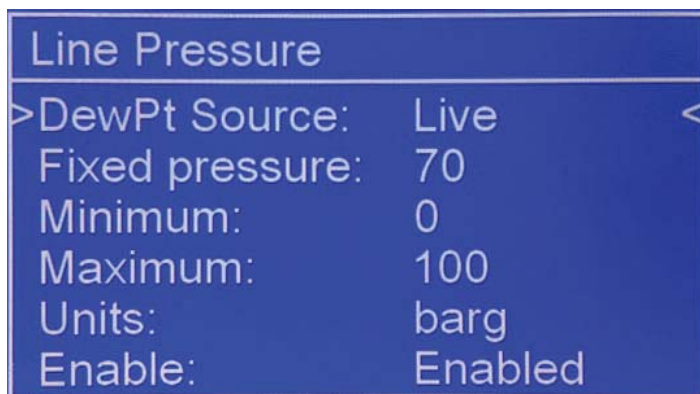

Figure 26 Line Pressure Setup Screen

Parameter	Description
Source	Switches between fixed pressure input, or live value from pressure sensor Available Options: Fixed, Live (4-20 mA)
Fixed Pressure	Pressure compensation value when source is set to fixed value
Minimum	Zero value for the pressure input
Maximum	Span value for the pressure input
Unit	Units used for selected pressure input Available Options: psig, psia, MPa, kPa, barg, bara
Enable	Available Options: disabled, enabled

Table 5 Line Pressure Setup Screen Parameters

Spare Input Setup

Press the **ESC** key to return to the Inputs Screen.

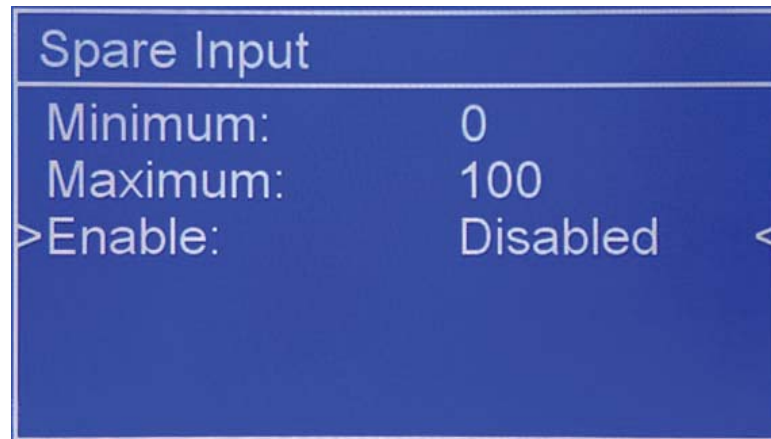

Figure 27 *Spare Input Setup Screen*

Parameter	Description
Minimum	Zero value for the pressure input (4 mA point)
Maximum	Span value for the pressure input (20 mA point)
Enable	Available Options: disabled, enabled

Table 6 Spare Input Setup Screen Parameters

ppm

This Screen has a passcode and can only be accessed by authorized Michell personnel.

3.7.6.4 Clock Screen

The Set Date/Time Screen allows the time and date to be set, which is used when logging to a file.

This screen is accessed by pressing the **ENTER** key from the Advanced Settings Screen.

The **Down (▼)** key selects the next digit and the **Up (▲)** key changes the value of the currently selected digit.

The **ENTER** key accepts the displayed value and returns to the Advanced Settings Screen. The **ESC** key discards the new value and returns to the Advanced Settings Screen.

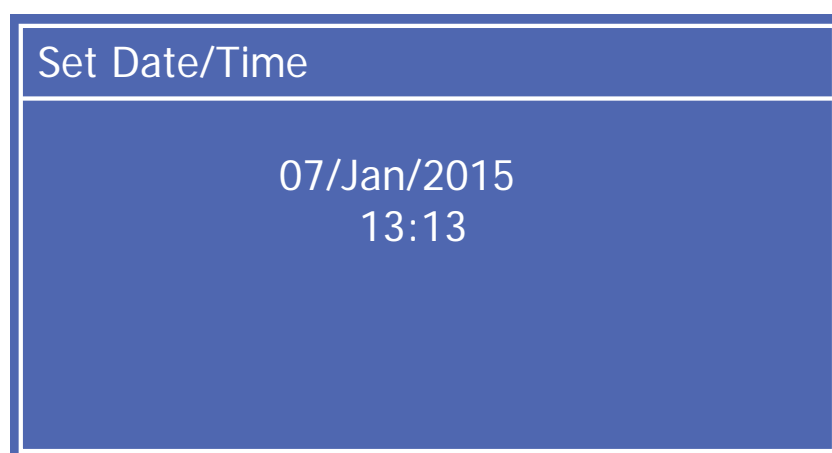

Figure 28 *Set Date/Time Screen*

Parameter	Description
Date	Adjusts the date of the internal clock
Time	Adjusts the time of the internal clock The time is in 24 hour format

Table 7 *Set Date/Time Screen Parameters*

3.7.6.5 Modbus Screen

The Modbus Settings Screen allows the Modbus address and the Baud Rate to be set.

Refer to Section 2.8.4 for information about the Modbus / RS485 connection.

Refer to Appendix E for a complete Modbus Register listing.

This screen is accessed by pressing the **ENTER** key from the Advanced Settings Screen.

Use the **Up (▲)** and **Down (▼)** keys to highlight the parameter of interest and press the **ENTER** key to access. Use the **Up (▲)** and **Down (▼)** keys to choose the option required and press the **ENTER** key to accept.

Press the **ESC** key to return to the Advanced Settings Screen.

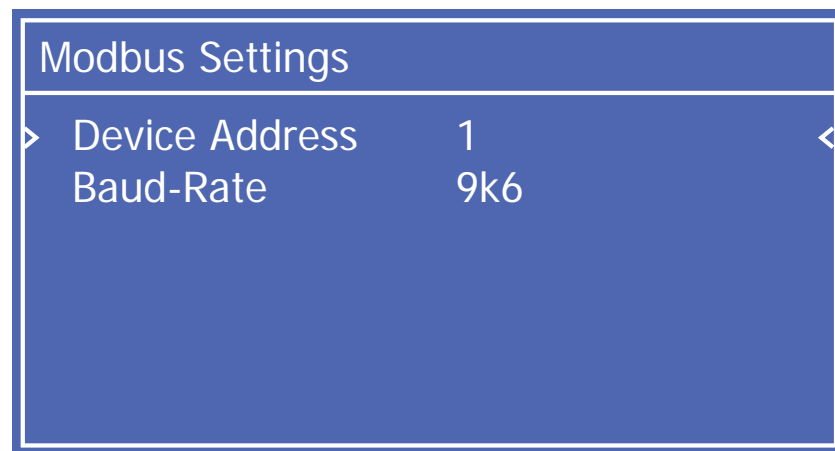

Figure 29 *Modbus Settings Screen*

Parameter	Description
Device Address	Sets the Modbus address of the TDL600
Baud-Rate	Available Options: 9k6, 4k8, 19k2, 38k4, 57k6, 115k2

Table 8 Modbus Screen Parameters

3.7.6.6 Region Defaults Screen

The Region Defaults Screen allows the user to toggle between EU (metric) and US (imperial/fractional) default parameters and unit presets.

This screen is accessed by pressing the **ENTER** key from the Advanced Settings Screen.

Press the **ENTER** key to access. Use the **Up (▲)** and **Down (▼)** keys to choose the option required and press the **ENTER** key to accept.

Press the **ESC** key to return to the Advanced Settings Screen.

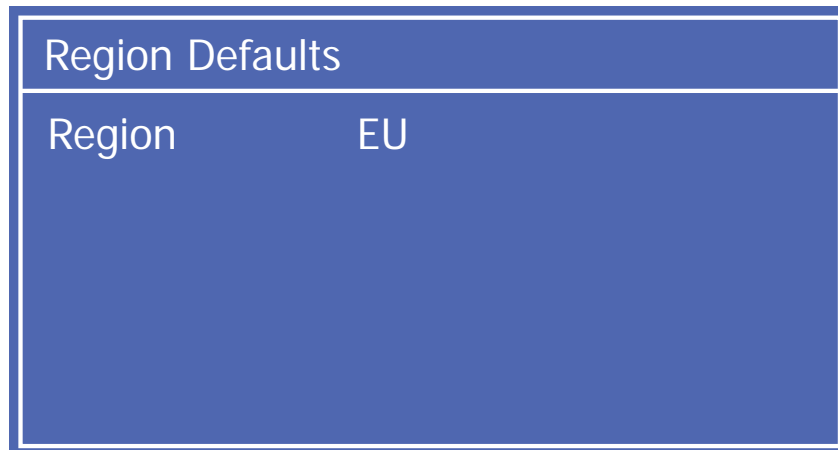

Figure 30 *Region Defaults Screen*

Parameter	Description
Region	Available Options: EU, US

Table 9 *Region Default Parameters*

3.7.6.7 N2-Mode (Measurement Mode) Screen

The N2-Mode (Measurement Mode) Screen puts the TDL600 into N2/field validation mode. The front screen will display ppm_v H₂O in N₂ as the measurement parameter. Invalid measurement parameters will change to **None** and display a **0** value (Dewpoint ISO, IGT, lbs/mmscf) and will not be selectable when in this mode. Toggle to **Off** to return/select natural gas operation.

This screen is accessed by pressing the **ENTER** key from the Advanced Settings Screen.

Press the **ENTER** key to access. Use the **Up (▲)** and **Down (▼)** keys to choose the option required and press the **ENTER** key to accept.

Press the **ESC** key to return to the Advanced Settings Screen.

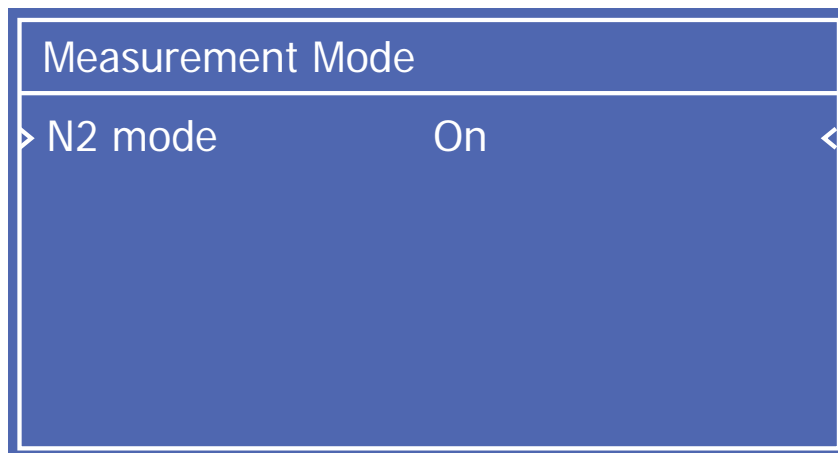

Figure 31 N2-Mode (Measurement Mode) Screen

Parameter	Description
N2 mode	Available Options: On, Off

Table 10 N2-Mode Parameters

3.7.6.8 Safe Mode (Laser Disabled) Screen

Not for customer use – for Michell approved service engineers only. This disables the unit for diagnostic/maintenance purposes.

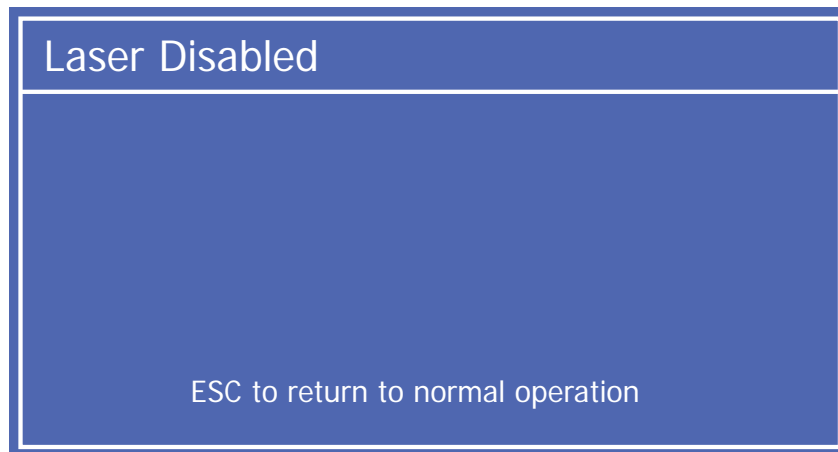

Figure 32 *Safe Mode (Laser Disabled) Screen*

3.8 Enclosure Cover and User Interface

The enclosure cover is part of the flameproof protection for the enclosure and has an IP66 rating. It should be firmly closed to ensure flameproof integrity and continued environmental protection. A grub screw is used as a locking device. This should be loosened before unscrewing the cover counter-clockwise. The enclosure lid is a safety critical part and should be inspected each time the lid is removed, to ensure the integrity of the flameproof protection. Full details are in Section 4.1.

The user interface assembly uses two $\frac{1}{4}$ turn Panex fasteners to secure it. These are finger operated and should be turned clockwise to lock and counter-clockwise to release.

4 MAINTENANCE

The power to the enclosure must be turned off before any work is carried out in the measurement system enclosure.

Observe de-energize durations.



Gas line connections to the measurement system must be isolated and de-pressurized before any work commences.

Any loose or disturbed pipework or couplings must be leak tested.

The design of the OptiPEAK TDL600 and measurement system is such that no specific routine maintenance is required. However, if a fault does occur with the system that is not covered within this manual please contact Michell Instruments (see contact information at www.michell.com) or your local representative.

The OptiPEAK TDL600 is a certificated product for use in Zone 1 and Zone 2 Hazardous Areas. Any maintenance of this product should only be conducted by suitably trained personnel and in accordance with locally applying regulations. Any unauthorized maintenance of this product, not covered by this manual, could invalidate the product warranty.

4.1 Inspection of the Enclosure Cover

Michell Instruments recommends that this procedure is carried out every 12 months, or at any other time that the enclosure lid is removed.

1. Isolate the sample gas supply to the OptiPEAK TDL600.
2. Isolate power to the OptiPEAK TDL600 using the switch on JB1 (**ATEX, IECEx and NEC500 Class I, Division 2 versions only**).

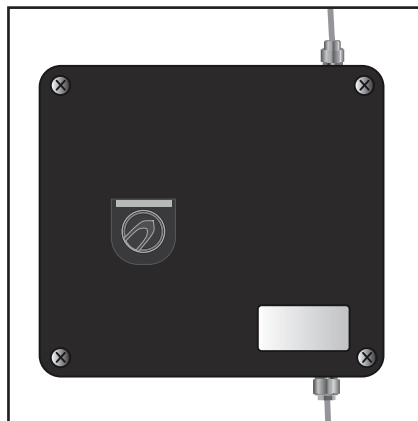

3. Remove the Exd enclosure lid by unscrewing the hex locking screw and turning the lid counter-clockwise until the threads disengage. **CARE SHOULD BE TAKEN AS THE LID WEIGHS IN EXCESS OF 2KG.**

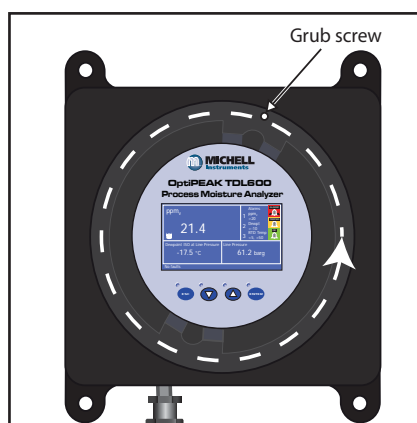

4. Inspect both the inside and outside of the window for cracks, chips or scratches.

5. Inspect the metal ring and silicon seal from the inside of the lid.

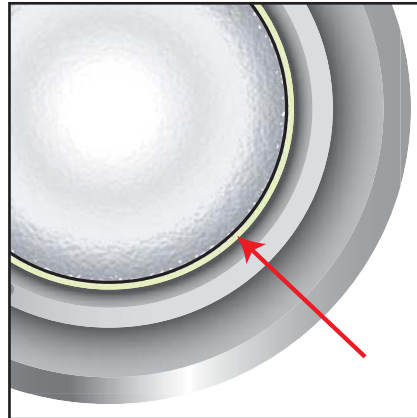

6. Inspect the flame path / threaded joint between the lid and body for damage to the threads.

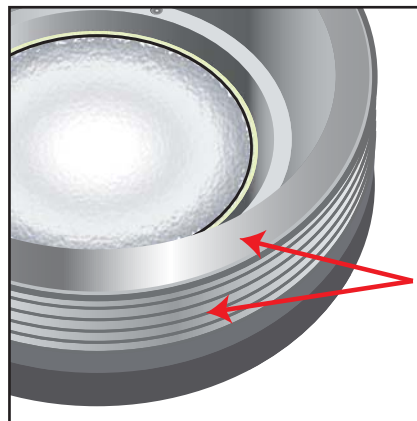

7. Inspect the gasket for pitting, damage or signs of corrosion.
8. Wipe the screw threads clean of dirt, grit or other foreign bodies.



If damage is noticed on any components, the integrity of the Exd protection may be compromised.

Contact Michell Instruments immediately.

9. Apply an ATEX approved thin film of non-setting grease to the screw threads.
10. Re-fit the enclosure lid and ensure the hex lock screw is securely tightened.
11. Power up the OptiPEAK TDL600 using the switch on JB1 (**ATEX, IECEx and NEC500 Class I, Division 2 versions only**).
12. Turn on the sample gas supply to the OptiPEAK TDL600.

4.2 Replacement of the Micro SD Data Logging Card

1. Isolate the sample gas supply to the OptiPEAK TDL600.
2. Isolate power to the OptiPEAK TDL600 using the switch on JB1 (**ATEX, IECEx and NEC500 Class I, Division 2 versions only**).

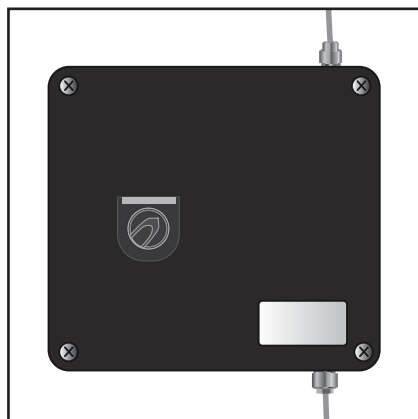

3. Remove the Exd enclosure lid by unscrewing the hex locking screw and turning the lid counter-clockwise until the threads disengage. **CARE SHOULD BE TAKEN AS THE LID WEIGHS IN EXCESS OF 2KG.**

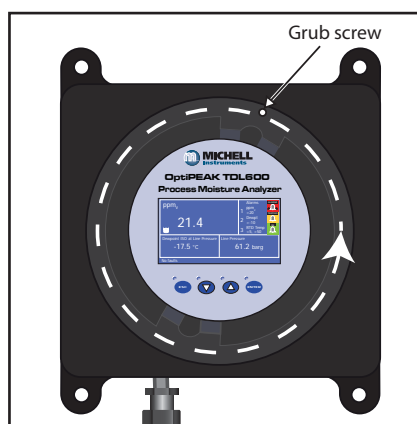

4. Remove the blue, circular display PCB by undoing the two Panax fasteners located on the display mounting brackets.



5. Disconnect the display data cable by releasing its latch.

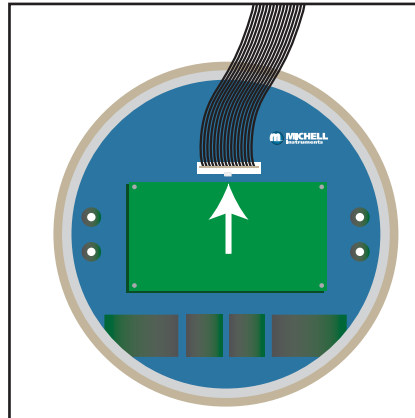

6. The micro SD card, is located on the green, rectangular display PCB, in the bottom right hand corner. It may be necessary to use tweezers or a small pair of pliers when fitting a new micro SD card.

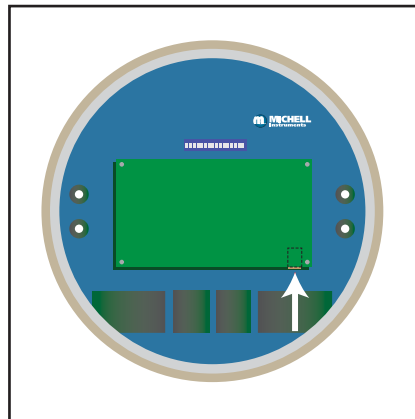

7. Reconnect the HMI Data cable and ensure it latches into the socket.
8. Replace the blue, circular display PCB onto its mounting brackets and ensure both Panex fasteners are tightened.
9. Inspect the enclosure lid gasket and screw thread as detailed in Section 4.1.
10. Re-fit the enclosure lid and ensure the hex lock screw is securely tightened.
11. Restore power to the OptiPEAK TDL600 using the switch on JB1 (**ATEX, IECEx and NEC500 Class I, Division 2 versions only**).
12. Restore the sample gas supply to the OptiPEAK TDL600.

4.3 Membrane and Particulate Filter Element Replacement

4.3.1 Service Intervals

The life expectancy of the filter elements is dependent upon operating conditions in each specific application. As a minimum it is recommended that the filter elements be changed every 12 months. If inspection of the removed element shows that it is in poor/good condition after 12 months of operation then the operating period between replacements may be reduced/increased accordingly.

The disposable microfiber filter elements cannot be cleaned as the solids are trapped within the depth of the element not on the surface. Also ensure that all O-rings are changed at regular intervals, preferably at the same time as the filter elements.

4.3.2 Installing the Filter Element and Membrane



Warning

The filter housing is a pressure vessel; it must never be used above its stated maximum allowable working pressure and must be used within its stated temperature range. Ensure that these items are used in well-designed piping systems with suitable indicators to warn users and servicing personnel of the presence of pressure and high temperatures. Wherever possible use pressure limiting or safety devices. Remember that the pressure rating is reduced at high temperatures. Consult Michell Instruments for guidance.

It is the responsibility of the user to ensure that the materials of construction of the filter housing, gasket and filter media are suitable for the intended application. During every servicing, a visual inspection must be made of the surfaces of the housing for signs of corrosion, erosion or general wear. The housing must be removed from service if any of these signs are evident as there are no corrosion allowances used in the design of these filters. It is not recommended that these filters be used on unstable fluids.

The following items have not been taken into account during the design of the filter housing:

1. Static pressure and mass of contents.
2. Traffic, wind and earthquake loading.
3. Reaction forces and moments resulting from mounting.
4. Corrosion, erosion and fatigue.
5. Decomposition of unstable fluids.
6. External fire.

Changing the Filter Element

Ensure there is no pressure in the housing. Remove the bowl, element retainer and filter element.

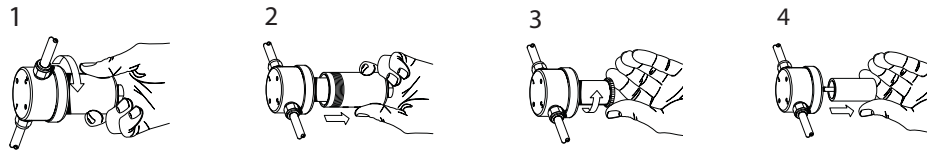

The disposable coalescing filter element is sealed by compression against a flat surface. Gaskets are not required between the filter element and components of the housing. The element is located by guides which fit the inside diameter of the tube at each end. The element is sealed by tightening a threaded element retainer.

Before replacing the housing bowl ensure that the mating threads and sealing faces are clean and damage free. It is recommended that the threads and sealing faces are lubricated with a small amount of silicone grease before assembly. In the case of 'S' type stainless steel housings fitted with a solid PTFE gasket the bowl should be tightened to a torque of between 30Nm and 40Nm.

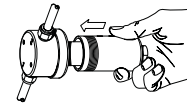

Membrane Replacement

The membrane is held in place by the O-ring. The whole membrane holder unit comes free from the housing leaving the filter housing /body still intact with the process lines with no need to loosen connections. The membrane can then be replaced on a work bench using a round nose pair of tweezers - the old O-ring is removed with the old membrane. The sintered disc should be removed and cleaned or replaced. Drag a new membrane over the sintered disc carefully as not to cause damage, until centralized over the sintered disc and O-ring groove. Place the new O-ring over/around the new membrane and gently push into the O-ring groove. Replace the coalescing filter element where applicable with a new element and screw/locate the whole membrane holder back into the filter housing/body. The inlet is stamped no.1 and the outlet is stamped no.2, the other two ports are drain ports. Both can be used or one drain may be blanked off with a plug.

Service Intervals

A disposable microfiber filter element continues to filter at its original efficiency as long as it is kept in service. The life of the element is determined by the increase in flow resistance caused by trapped solids in the element. The element should be changed when the flow falls below an acceptable level, or the pressure drop becomes too high. In any case the element should be replaced before the pressure drop across it reaches 0.7 bar. The disposable microfiber filter elements cannot be cleaned as the solids are trapped within the depth of the element, not on the surface.

Ensure that gaskets are changed at suitable intervals. The interval time will depend on service and operating conditions, but it should be at least every three months.

4.3.3 Field measurement verification

Occasionally, in order to troubleshoot a problem or check the calibration of a TDL600 analyser, it may be beneficial to use a reference gas to verify that it is reading correctly. The most representative verification check can be carried out using a certified moisture in methane cylinder. It is also possible to verify using a certified cylinder of moisture in N₂, which may be more readily available.

Requirements

Certified moisture concentration in methane or nitrogen cylinder with a moisture content close to the typical process moisture content or alarm point, most typically 25, 50 or 100 ppmV for dehydration processing and transmission pipeline applications.
Pressure regulator with stainless steel body and diaphragm. Low pressure outlet range with gauge, 0-4 barg or similar.
Stainless steel connection hose/tubing and tube fittings.

Procedure

1. If using a cylinder of H₂O in N₂, then make sure that analyser is set for N₂ operation. To place the analyser in N₂ measurement mode, enter the advanced menu (access code 7316) and toggle N₂ mode to "ON".
2. Connect the gas cylinder to the regulator and pressure gauge, then to the inlet coupling of the TDL600 sampling system.
3. Open the regulator (approximately 2 barg setting) to allow the test gas to flow through the sampling system. Using the metering valves on the sampling system, set the sample flow to 500ml/min, and the bypass flow to >1000ml/min.

4. Leave the system to purge for at least one hour.
5. Note: If the supply of certified gas is limited, the outlet of the cylinder regulator/pressure gauge can be connected directly to the inlet of the flow metering valve at the entry to the measurement cell of the analyser. This then reduces the total flow requirement to 500ml/m and will reduce the duration required for the test, typically 30 minutes.
6. At this point, the analyser reading should be in close agreement with the certified cylinder value.
7. Moisture in nitrogen: Recommended concentration 25 to 100 ppmV H₂O. Expected agreement +/-3ppmV plus stated uncertainty of the certified cylinder gas.
8. Moisture in methane: Recommended concentration 5 to 100 ppmV H₂O. Expected agreement +/-2ppmV plus stated uncertainty of the certified cylinder gas.
9. Note: Sample gas vent from the sampling system should exhaust directly to atmosphere or near atmospheric pressure vent. Any significant back-pressure (greater than 300mbar) on the sample gas vent of the sampling system may adversely affect the readings of the analyzer, resulting in measurement readings lower than the expected moisture concentration.
10. If the analyser was set to N₂ mode, return the unit to natural gas operation by entering the advanced menu (access code 7316) and toggling N₂ mode to "off".
11. If the cylinder gas was connected directly to the measurement cell metering valve, then the sampling system should be re-assembled and leak checked prior to the reintroduction of sample gas.

4.3.4 Long-term maintenance – Laser replacement

The advanced TDLAS principle applied by the OptiPEAK TDL600 provides stable measurement performance over multiple years in operation without need for annual re-calibration. Calibration maintenance is limited to periodic field measurement verification conducted at the interval chosen by the user to satisfy their own company measurement practices and quality procedures.

Long-term maintenance is restricted to replacement of the laser diode. It is the characteristic of all TDL devices that emitted light intensity will diminish over a long period of a number of years. Michell Instruments use the highest quality TDL devices for the OptiPEAK TDL600 but still it can be envisaged that the laser will require replacement after an operational duration of typically five to eight years.

OptiPEAK TDL600 provides two fault status alarm messages on the main display screen (and fault status alarm contacts) to warn the user concerning diminished laser intensity: PD SIGNAL LOW: Warning of reduced laser intensity at the photo-diode detector. Normal measurements continue without adverse effect on performance but Michell Instruments should be contacted at this stage to plan replacement of the laser.

PD SIGNAL TOO LOW: Critical warning that laser intensity has reduced such that measurement performance may be adversely effected. Contact Michell Instruments immediately.

It is normal practice for manufacturers of TDLAS analysers to require return of the analyser system their factory service departments when laser replacement is required.

Michell Instruments recognise that removal of an on-line moisture analyser is very inconvenient for a natural gas production or pipeline company. Michell Instruments have designed the OptiPEAK TDL600 to enable field replacement of the TDL package. This long-term maintenance task is carried out at the installation location by a Michell Instruments' field service engineer for a single day. The only requirement placed on the user is to provide a certified moisture in methane or nitrogen test gas for measurement verification, as described in section 4.3.3.

Note: PD SIGNAL LOW and PD SIGNAL TOO LOW may potentially be triggered due to other exceptional reasons such as gross contamination of the measurement cell mirror, mirror alignment or detection circuit fault. Expert assessment of a period of logged measurement data will enable Michell Instruments to eliminate other such possible causes, as the log created by the OptiPEAK TDL600 includes a number of 'health check' indicators concerning the spectroscopy analysis. Contact Michell Instruments for the procedure to follow to obtain the log file from within the analyser and for assessment of the data obtained.

Appendix A

Technical Specifications

Appendix A Technical Specification

Performance	
Measurement Technology	Tuneable Diode Laser Spectroscopy (TDLAS)
Measurement Range *	1 - 1000 ppm _v
Accuracy *	±1% of reading > 100 ppm _v ±1 ppm _v < 100 ppm _v
Repeatability *	< 1 ppm _v
Limit of Detection *	< 1 ppm _v
Available Units	ppm _v , lb/MMscf, mg/Nm ³ (15°C, 101.325 kPa), dew point °C or °F (ISO18453 or IGT#8)
Response Speed	Optical response 0.2s Display update 2 to 3s
Operating Temperature Range	Indoor version: +10 to +45°C (+50 to +113°F) Outdoor version: -20 to +45°C (-4 to +113°F) Outdoor version with enclosure cooling option: -20 to +55°C (-4 to +131°F)
Electrical Specifications	
Supply Voltage	90 to 264 V AC, 50/60Hz (Option dependent)
Power Requirements	Indoor system: 80 W Outdoor system: 80 W to 250W (option dependent)
Analog Signals	Input: 2 x 4-20 mA user-configurable Output: Output: 3 x 4-20 mA (or 0-20 mA), 3 alarms 250 V AC, 3A (Volt Free contacts)
Digital Communications	RS485 Modbus RTU
Data Logging	Logs all process variables with a user selectable sample period in the range of 15s to 1 day
Local Interface	4.3" color LCD with touch pad operation
Electrical Connections	3 x M20 entries for cable glands
Calibration	
Factory Method	3 point, traceable to NPL and NIST
Recommended Calibration	None required, dependant on user or quality system requirements
Physical Specifications	
Sample Flow Rate	0.5 NI/min (1 scfh) cell sample, 1 to 5 NI/min (2.1 to 10.5 scfh) sample filter bypass
Inlet Pressure	Max 130 barg (1885 psig)
Outlet Pressure	Cell vent 0.7 to 1.4 bara (10 to 20.3 psia) Filter bypass maximum 3 barg (43.5 psig)
Analyzer Enclosure	Aluminum alloy, explosion proof, polyester coated, IP66, NEMA4
Gas Connections	1/4" NPT(F)
Weight	40kg (88lbs) to 75kg (165 lbs) approximate - depending on configuration
Sample System Enclosure	304L or 316L stainless steel

The standard measurement specifications stated may be revised for background gas compositions outside of the following circuits: Methane 40-100%; Ethane 0-60%; Carbon Dioxide <3%; Hydrogen Sulphide <1000ppm.

Analyzer - Hazardous Area Certification	
Certification Codes	ATEX II 2G Ex d ib op is IIC T5 Gb (-20°C to +60°C) IECEX Ex d ib op is IIC T5 Gb (-20°C to +60°C) TC TR Ex 1Ex d ib op is IIC T5 Gb cQPSus Class I, Division 1, Groups A B C D, T5
Compliance	EMC Directive 2014/30/EU LVD Directive 2014/35/EU IEC 61010 Part 15 US FCC FDA "Laser Product" Registered (Assigned Accession No.) WEEE and RoHS compliant
Laser Class	Class 1: IEC/EN 60825-1:2007

A.1 Dimensional Drawings

Indoor System Enclosure

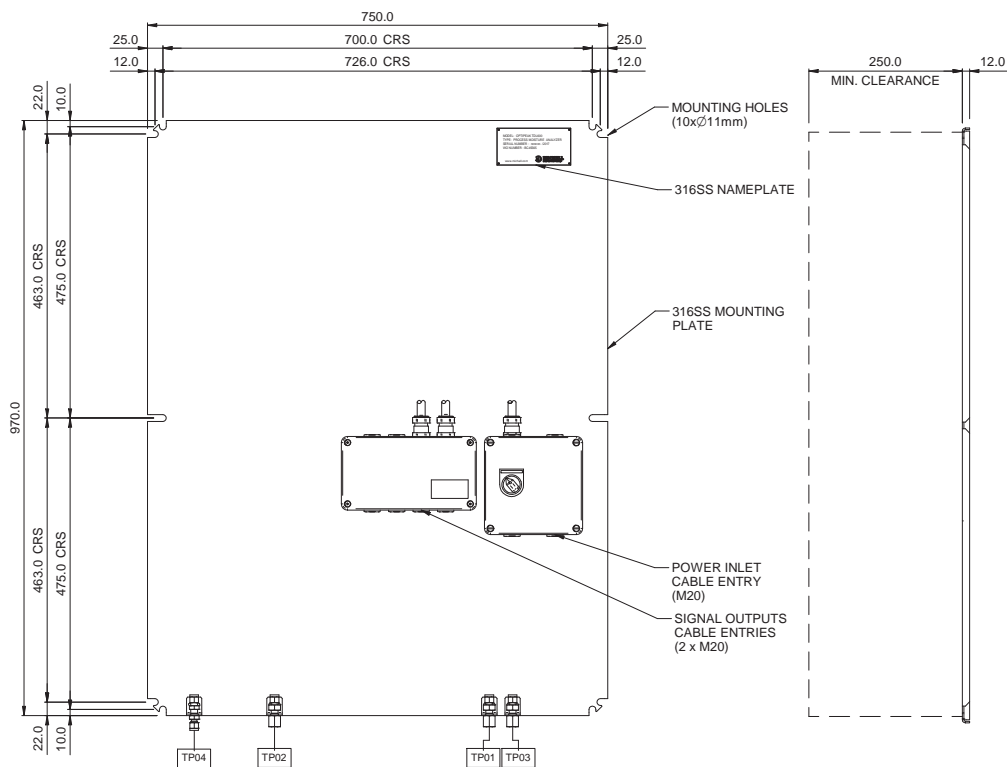

Figure 33 Dimensional Drawing - Indoor System Enclosure

A.2 Dimensional Drawings

Outdoor System Enclosure

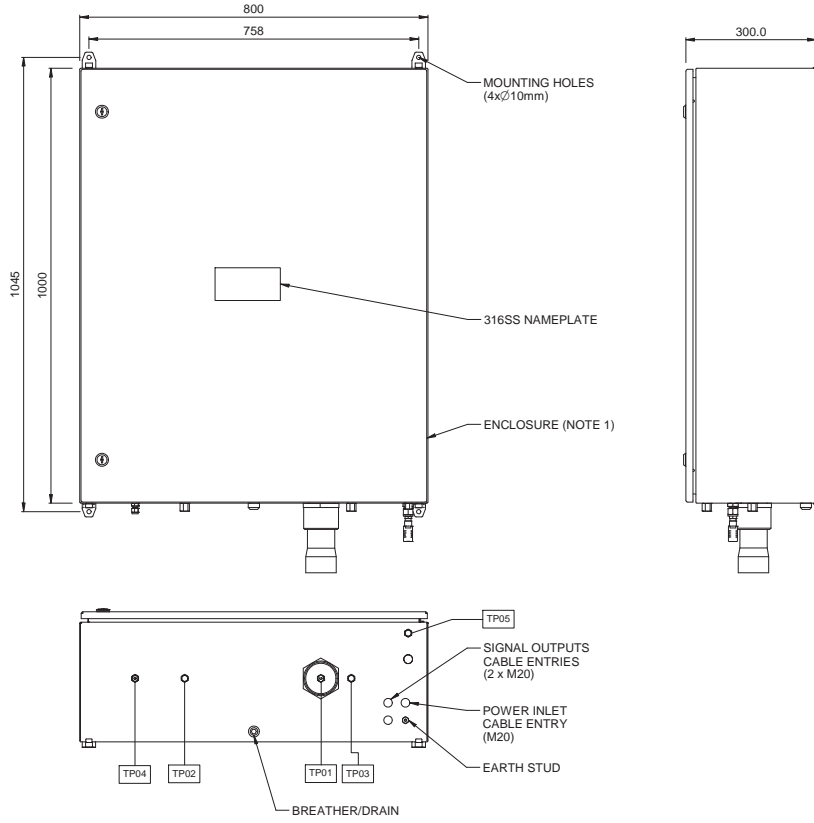

Figure 34 Dimensional Drawing - Outdoor System Enclosure

Appendix B

Indoor Sampling System Wiring Diagram

Appendix B Indoor Sampling System Wiring Diagram

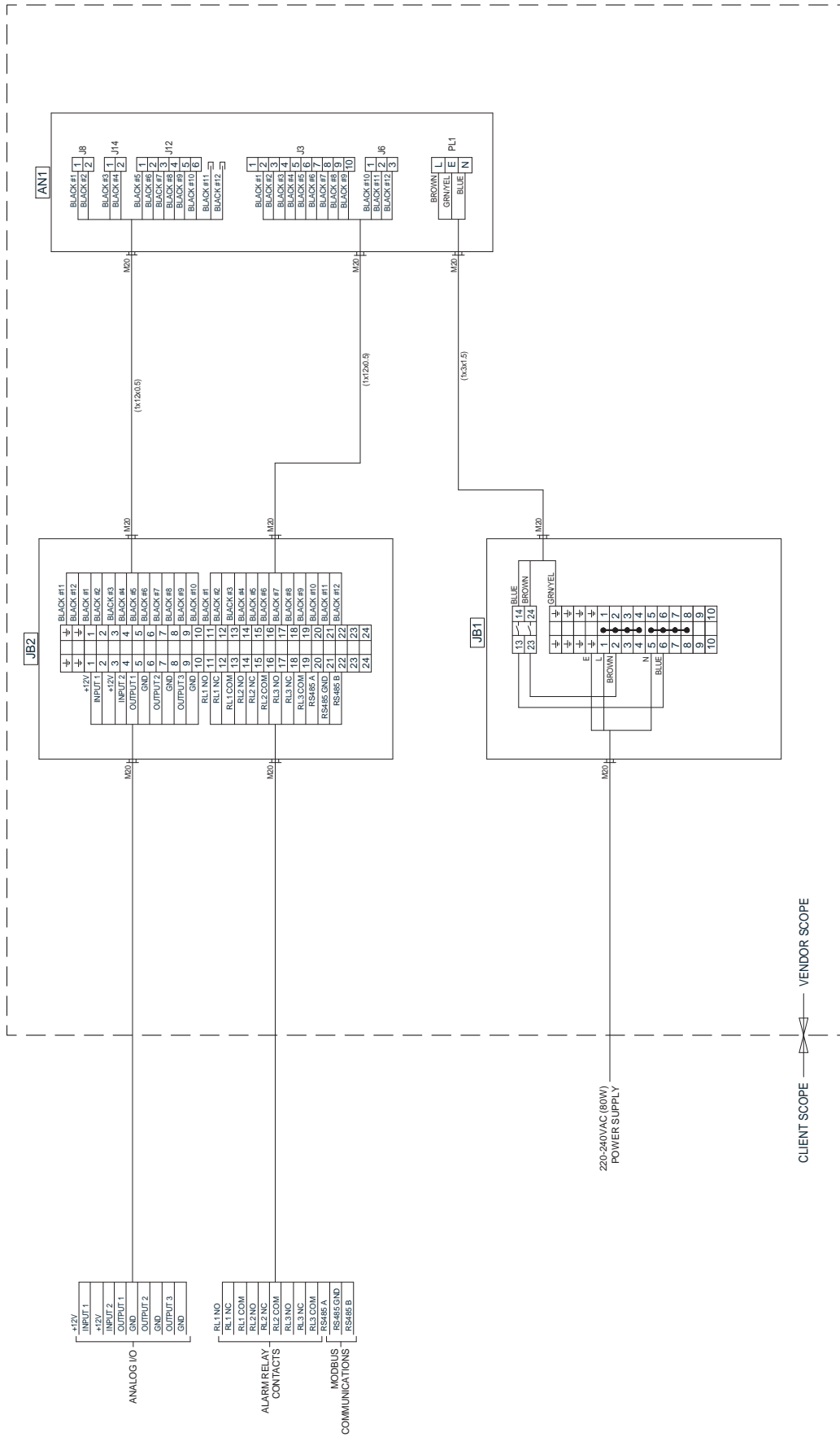

Figure 35 Wiring Diagram Indoor System

Appendix C

Outdoor Sampling System Wiring Diagram

Appendix C Outdoor Sampling System Wiring Diagram

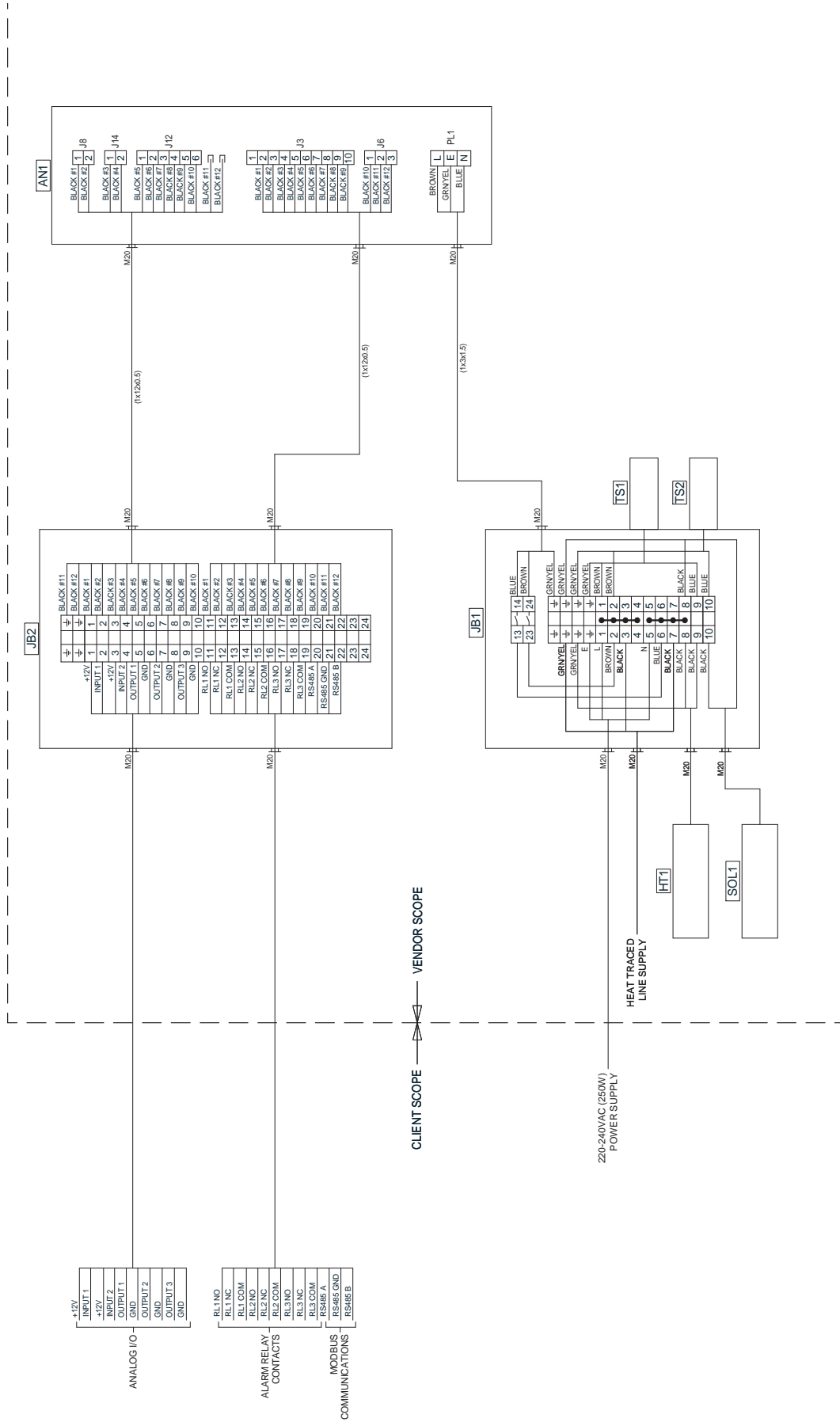
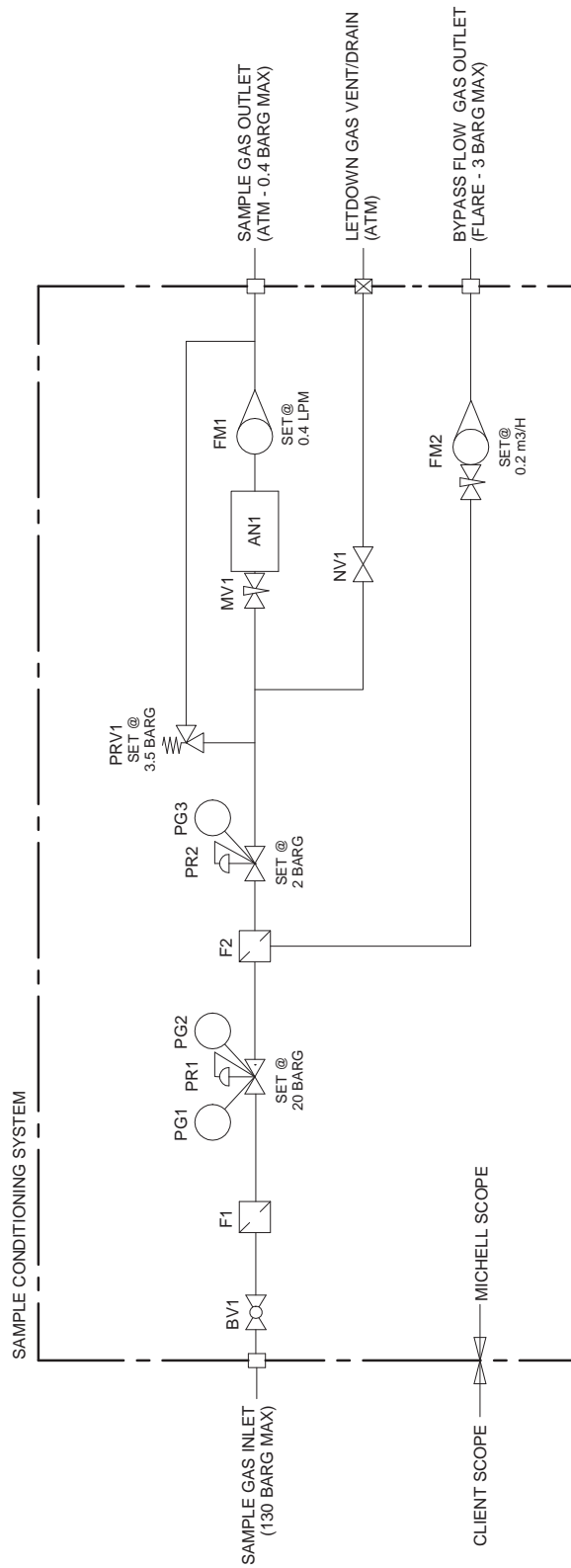

Figure 36 Wiring Diagram Outdoor System

Appendix D

Flow Diagram

Appendix D Flow Diagram



Appendix E

Modbus Holding Register Map

Appendix E Modbus Holding Register Map

All the data values relating to the TDL600 are stored in holding registers. Each of these registers is 16-bits wide. Some of these registers contain instrument specific values e.g. alarm settings etc. Other registers hold specific real time data e.g. measured ppm_v and dew-point values.

The information below describes the instruments' registers with their respective address locations, together with their numerical data types.

Access Levels

There are two access levels for Modbus Registers described below for added security:

Open These registers have read/write access without entering a code

Engineer These registers require the code **7316** to be written to register 117 before they can be accessed

Modbus RTU Implementation

This is a partial implementation of the Modbus RTU Standard with the following codes implemented:

Code	Description
3	Read Holding Register
6	Write Holding Register
16	Write Multiple Holding Registers

Register Types

Float IEE754 32 bit single precision floating point, spans 2 16-bit holding registers

UInt16 16 bit unsigned integer, spans 1 single 16-bit holding register

UInt8 8 bit unsigned integer, spans 1 single 16-bit holding register, high byte is 00

Refer to comments for registers such as Alarm Parameter, where integer values are mapped to a list.

Name	Register Number (Decimal)	Access Level	Min	Max	Type	Comments
Access Code	117	Open			UInt16	4 digit access code to unlock engineer registers
Fixed Line Pressure	308	Engineer			Float	Pressure value used for dew-point correction if line pressure source set to fixed. Units set by register 502.
Line Pressure Input Minimum	312	Engineer			Float	4 mA Lower Range Value
Line Pressure Input Maximum	316	Engineer			Float	20 mA Upper Range Value
Output 1 Minimum	320	Engineer			Float	4 mA Lower Range Channel 1
Output 2 Minimum	322	Engineer			Float	4 mA Lower Range Channel 2
Output 3 Minimum	324	Engineer			Float	4 mA Lower Range Channel 3
Output 1 Maximum	326	Engineer			Float	20 mA Upper Range Channel 1
Output 2 Maximum	328	Engineer			Float	20 mA Upper Range Channel 2
Output 3 Maximum	330	Engineer			Float	20 mA Upper Range Channel 3
Alarm 1 Minimum	336	Engineer			Float	
Alarm 2 Minimum	338	Engineer			Float	
Alarm 3 Minimum	340	Engineer			Float	
Alarm 1 Maximum	342	Engineer			Float	
Alarm 2 Maximum	344	Engineer			Float	
Alarm 3 Maximum	346	Engineer			Float	
Spare Input Minimum	348	Engineer			Float	4 mA Lower Range Value
Spare Input Maximum	350	Engineer			Float	20 mA Upper Range Value
SW VER	450	Open			UInt16	Software Revision
SW Part No	451	Open			UInt16	Software Part No.
Line Pressure Source	500	Engineer	0	1	UInt8	0 = Live, 1 = Fixed
Line Pressure Units	502	Engineer	0	5	UInt8	0 = Pa, 1 = MPa, 2 = psia, 3 = psig, 4 = bara, 5 = barg
Output 1 Parameter	504	Engineer	0	8	UInt8	0 = ppm, 1 = lb/MMscf, 2 = mg/m ³ , 3 = pw (kPa), 4 = Dew point (ISO), 5 = Dew point (IGT), 6 = Dew point (Ideal), 7 = Spare Input, 8 = Line Pressure

Output 2 Parameter	505	Engineer	0	8	UInt8	0 = ppm _v 1 = lb/MMscf, 2 = mg/m ³ , 3 = pw (kPa), 4 = Dew point (ISO), 5 = Dew point (IGT), 6 = Dew point (Ideal), 7 = Spare Input, 8 = Line Pressure
Output 3 Parameter	506	Engineer	0	8	UInt8	0 = ppm _v 1 = lb/MMscf, 2 = mg/m ³ , 3 = pw (kPa), 4 = Dew point (ISO), 5 = Dew point (IGT), 6 = Dew point (Ideal), 7 = Spare Input, 8 = Line Pressure
Output 1 Current Loop Type	507	Engineer	0	1	UInt8	0 = 0 to 20 mA, 1 = 4 to 20 mA
Output 2 Current Loop Type	508	Engineer	0	1	UInt8	0 = 0 to 20 mA, 1 = 4 to 20 mA
Output 3 Current Loop Type	509	Engineer	0	1	UInt8	0 = 0 to 20 mA, 1 = 4 to 20 mA
Displayed Temperature Unit	510	Open	0	1	UInt8	0 = °C, 1 = °F
Displayed Pressure Unit	511	Open	0	5	UInt8	0 = Pa, 1 = MPa, 2 = psia, 3 = psig, 4 = bara, 5 = barg
Displayed Decimal Places	512	Open	0	2	UInt8	Resolution, max 3 dp - all display parameters
Backlight Level	513	Open	20	100	UInt8	Backlight level %.
Displayed Parameter 1	514	Open	0	8	UInt8	0 = ppm _v 1 = lb/MMscf, 2 = mg/m ³ , 3 = pw (kPa), 4 = Dew point (ISO), 5 = Dew point (IGT), 6 = Dew point (Ideal)
Displayed Parameter 2	515	Open	0	8	UInt8	0 = ppm _v 1 = lb/MMscf, 2 = mg/m ³ , 3 = pw (kPa), 4 = Dew point (ISO), 5 = Dew point (IGT), 6 = Dew point (Ideal), 7 = Spare Input, 8 = Line Pressure
Displayed Parameter 3	516	Open	0	8	UInt8	0 = ppm _v 1 = lb/MMscf, 2 = mg/m ³ , 3 = pw (kPa), 4 = Dew point (ISO), 5 = Dew point (IGT), 6 = Dew point (Ideal), 7 = Spare Input, 8 = Line Pressure
Day Of Month	518	Engineer	1	31	UInt8	
Month	519	Engineer	1	12	UInt8	
Year	520	Engineer	12	99	UInt16	2 digit year number representing years 20xx
Hours	521	Engineer	0	23	UInt8	24 hour format
Minutes	522	Engineer	0	59	UInt8	
Alarm 1 Parameter	523	Engineer	0	8	UInt8	0 = ppm _v 1 = lb/MMscf, 2 = mg/m ³ , 3 = pw (kPa), 4 = Dew point (ISO), 5 = Dew point (IGT), 6 = Dew point (Ideal), 7 = Spare Input, 8 = Line Pressure
Alarm 2 Parameter	524	Engineer	0	8	UInt8	0 = ppm _v 1 = lb/MMscf, 2 = mg/m ³ , 3 = pw (kPa), 4 = Dew point (ISO), 5 = Dew point (IGT), 6 = Dew point (Ideal), 7 = Spare Input, 8 = Line Pressure
Alarm 3 Parameter	525	Engineer	0	8	UInt8	0 = ppm _v 1 = lb/MMscf, 2 = mg/m ³ , 3 = pw (kPa), 4 = Dew point (ISO), 5 = Dew point (IGT), 6 = Dew point (Ideal), 7 = Spare Input, 8 = Line Pressure

N2 Mode	530	Engineer	0	1	UInt8	0 = Moisture in natural gas / 1 = Moisture in nitrogen. Parameter names have "in N2" added. Note: Parameters lb/MMscf, Dew Point (ISO) and Dew Point (IGT) are not available in nitrogen mode for display, alarms and outputs
Alarm 1 Latching	536	Engineer	0	1	UInt8	0 = Disabled, 1 = Enabled
Alarm 2 Latching	537	Engineer	0	1	UInt8	0 = Disabled, 1 = Enabled
Alarm 3 Latching	538	Engineer	0	1	UInt8	0 = Disabled, 1 = Enabled
Alarm 1 Type	539	Engineer	0	4	UInt8	0 = Disabled, 1 = High, 2 = Low, 3 = Out of Bounds, 4 = Fault
Alarm 2 Type	540	Engineer	0	4	UInt8	0 = Disabled, 1 = High, 2 = Low, 3 = Out of Bounds, 4 = Fault
Alarm 3 Type	541	Engineer	0	4	UInt8	0 = Disabled, 1 = High, 2 = Low, 3 = Out of Bounds, 4 = Fault
Line Pressure Input Enable	543	Engineer	0	1	UInt8	0 = Disabled, 1 = Enabled
Spare Input Enable	544	Engineer	0	1	UInt8	0 = Disabled, 1 = Enabled
Alarm 1 State	545	Open	0	3		0 = Disabled, 1 = Safe/No Alarm, 2 = Previously Tripped, 3 = Active/Alarm Set
Alarm 2 State	546	Open	0	3		0 = Disabled, 1 = Safe/No Alarm, 2 = Previously Tripped, 3 = Active/Alarm Set
Alarm 3 State	547	Open	0	3		0 = Disabled, 1 = Safe/No Alarm, 2 = Previously Tripped, 3 = Active/Alarm Set
Error State (Low)	548	Open	0	65535	UInt16	'Refer to Section 3.7.6.2 for list of fault alarms
Error State (High)	549	Open	0	65535	UInt16	
Water ppm _v	602	Open			Float	
ppm _v Ideal Gas	604	Open			Float	
Water lb/MMscf	606	Open			Float	
Water mg/m3	608	Open			Float	
IGT Dew Point °C	610	Open			Float	
ISO Dew Point °C	612	Open			Float	
Ideal Gas Dew Point °C	614	Open			Float	
Line Pressure Barg	618	Open			Float	
Spare Input	620	Open			Float	
IGT Dew Point °F	622	Open			Float	
ISO Dew Point °F	624	Open			Float	
Ideal Gas Dew Point °F	626	Open			Float	

NOTE: All temperatures will be stored in Modbus Register as °C, regardless of display units.

Appendix F

Quality, Recycling, Compliance & Warranty Information

Appendix F Quality, Recycling, Compliance & Warranty Information

Michell Instruments is dedicated to complying to all relevant legislation and directives. Full information can be found on our website at:

www.michell.com/compliance

This page contains information on the following directives:

- ATEX Directive
- Calibration Facilities
- Conflict Minerals
- FCC Statement
- Manufacturing Quality
- Modern Slavery Statement
- Pressure Equipment Directive
- REACH
- RoHS2
- WEEE2
- Recycling Policy
- Warranty and Returns

This information is also available in PDF format.

Appendix G

Analyzer Hazardous Area Certification

The OptiPEAK TDL600 Process Moisture Analyzer is certified compliant to the ATEX Directive (2014/34/EU) and IECEx for use within Zone 1 & 2 Hazardous Areas, and has been assessed so by TRaC Compliance (Notified Body 0891).

The OptiPEAK TDL600 Process Moisture Analyzer is certified compliant to the North American Standards (USA and Canada) for use within Class I, Division 1, Groups A, B, C & D Hazardous Locations, and has been assessed so by cQPSus.

G.1 Product Standards

This product conforms to the Standards:

EN60079-0:2012	IEC60079-0:2011
EN60079-1:2007	IEC60079-1:2007
EN60079-28:2007	IEC60079-28:2006
EN60079-11:2012	IEC60079-11:2011

G.2 Product Certification

This product is attributed with the product certification codes:

ATEX & IECEx
II 2 G Ex d ib op is IIC T5 Gb (-20°C to +60°C)

North American
Class I, Division 1, Groups A, B, C, & D, T5 (-20°C to +60°C)

G.3 Global Certificates/Approvals

ATEX	TRAC12ATEX0034X
IECEX	IECEX TRC12.0015X
TC TR Ex	RU C-GB. ГБ05.B.00152
cQPSus	LR 1507-1

These certificates can be viewed or downloaded from our website at:
<http://www.michell.com>

G.4 Special Conditions of Use

1. Do not open when an explosive gas atmosphere may be present.
2. Do not open when energised.
3. External cables shall be compatible with a maximum temperature of 90°C.
4. As part of the routine maintenance schedule, the condition of the window cement shall be periodically inspected for any degradation or discoloration of the cement that may compromise the explosion protection.
5. Only suitably IECEx or ATEX certified (as appropriate to the equipment application) cable glands, conduit entry devices and blanking elements shall be used.
6. The enclosure must be earthed externally using the earth point provided.
7. Where painted or powder coated, the enclosures could present an electrostatic hazard. Clean only with a damp or anti-static cloth.

G.5 Maintenance and Installation

The OptiPEAK TDL600 must only be installed by suitably qualified personnel and in accordance with the instructions provided and the terms of the applicable product Certificates.

Maintenance and servicing of the product must only be carried out by suitably trained personnel or returned to an approved Michell Instruments' Service Center.

When considering N. American Certifications, this product has not been tested for the chemicals listed in UL 1203, 5th Ed, clause 34 and this should be considered during installation.

Appendix H

Return Document & Decontamination Declaration

Appendix H Return Document & Decontamination Declaration

Decontamination Certificate

IMPORTANT NOTE: Please complete this form prior to this instrument, or any components, leaving your site and being returned to us, or, where applicable, prior to any work being carried out by a Michell engineer at your site.

Instrument			Serial Number	
Warranty Repair?	YES	NO	Original PO #	
Company Name			Contact Name	
Address				
Telephone #			E-mail address	
Reason for Return /Description of Fault:				
Has this equipment been exposed (internally or externally) to any of the following? Please circle (YES/NO) as applicable and provide details below				
Biohazards			YES	NO
Biological agents			YES	NO
Hazardous chemicals			YES	NO
Radioactive substances			YES	NO
Other hazards			YES	NO
Please provide details of any hazardous materials used with this equipment as indicated above (use continuation sheet if necessary)				
Your method of cleaning/decontamination				
Has the equipment been cleaned and decontaminated?			YES	NOT NECESSARY
Michell Instruments will not accept instruments that have been exposed to toxins, radio-activity or bio-hazardous materials. For most applications involving solvents, acidic, basic, flammable or toxic gases a simple purge with dry gas (dew point <-30°C) over 24 hours should be sufficient to decontaminate the unit prior to return. Work will not be carried out on any unit that does not have a completed decontamination declaration.				
Decontamination Declaration				
I declare that the information above is true and complete to the best of my knowledge, and it is safe for Michell personnel to service or repair the returned instrument.				
Name (Print)			Position	
Signature			Date	



EU Declaration of Conformity



Manufacturer: Michell Instruments Limited
Address: 48 Lancaster Way Business Park
Ely, Cambridgeshire
CB6 3NW. UK.



Equipment Type: **OptiPeak TDL600 Gas Analyser:**

Directive 2014/34/EU ATEX Directive

Provisions of the Directive fulfilled by the Equipment:

Group II Category 2G Ex d ib op is IIC T5 Gb
Tamb -20°C to +60°C IP66

Notified Body for Production (QAN & QAR):

SGS Fimko OY, Helsinki, Finland. Notified Body No. 0598

EC-Type Examination Certificate:

TRAC 12ATEX0034X

Standards used:

EN 60079-1:2007

On 1st August 2017 this standard will cease to have harmonised status. **EN60079-1:2014** has now superseded.

EN 60079-11:2012

EN 60079-28:2007

On 1st July 2018 this standard will cease to have harmonised status. **EN60079-28:2015** has will superseded.

EN 60079-0:2012

On 7th October 2016 this standard will cease to have harmonised status. **EN60079-0:2012/A11:2013** has now superseded.

A technical review of these standards against the old standards showed that the equipment remains in conformance with all relevant clauses and that the State of the Art is maintained. The Essential Health & Safety Requirements of the Directive is still maintained with no changes necessary for the safe and reliable functioning and operation of the product with respect to the risks of explosion).

IECEX

Certificate of Conformity No.

IECEX TRC 12.0015X

Ex d ib op is IIC T5 Gb
Tamb -20°C to +60°C IP66

Standards used:

IEC 60079-0:2011

IEC 60079-1:2007

IEC 60079-11:2011

IEC 60079-28:2006

Other Directives

2014/30/EU EMC Directive

Is in conformity with the following Standard(s) or Normative Document(s):

EN61326-1:2006 *Electrical equipment for measurement, control and laboratory use - EMC requirements. Class A (emissions) and Industrial Locations (immunity).*

2011/65/EU Restriction of Hazardous Substances Directive (RoHS2)

RoHS2 EU Directive 2011/65/EU (Article 3, [24]) states, "industrial monitoring and control instruments means monitoring and control instruments designed exclusively for industrial or professional use".

EN61010-1:2010 Safety Requirements for Electrical Equipment for Measurement, Control, and Laboratory Use - Part 1: General Requirements.

2014/68/EU PE Directive

This product and sample systems & accessories that may be supplied with it does not bear CE marking for the Pressure Equipment Directive, and are supplied in accordance with Article 4, paragraph 3 of 2014/68/EU by using SEP (sound engineering practice) in the design and manufacturer and are provided with adequate instructions for use.

On behalf of the above named company, we the manufacturer declare under our sole responsibility that, on the date the equipment accompanied by this declaration is placed on the market, the equipment conforms with all technical and regulatory requirements of the above listed directives.

Andrew M.V. Stokes, Technical Director.

March 2019
Ely, UK

EUD TDL600 Issue 08A



<http://www.michell.com>