



Level



Pressure



Flow



Temperature



Liquid
Analysis



Registration



Systems
Components



Services



Solutions

Technical Information

Tankvision NXA820, NXA821, NXA822

Inventory Management System
with completely integrated software
for operation via standard web browser



Application

Tankvision is a dedicated tank inventory system which is operated by a standard web browser and does not require proprietary software or licensing costs.

Tankvision is based on a distributed architecture on a Local Area Network (LAN). Due to its modular structure it can be adjusted to any application. It is ideally suited for small tank farms with only a couple of tanks, but also for large refineries with hundreds of tanks.

Tankvision consists of the following components:

- **Tankvision NXA820 (Tank Scanner)**
scans parameters from tank gauges and performs tank calculations
- **Tankvision NXA821 (Data Concentrator)**
summarizes data from various Tank Scanners NXA820
- **Tankvision NXA822 (Host Link)**
provides data to host systems (such as PLC or DCS) via Modbus

Your benefits

- License-free
- Approved for custody transfer applications according to NMI and PTB (in preparation)
- Global system engineering and service support
- A robust industrial operating system with embedded software ensures high stability and availability.
- Modular design; easily adjustable to any application; can be upgraded as required
- Configuration, commissioning and operation via web browser; no proprietary software required
- Access for up to 10 users per Tankvision component from any connected PC
- Common hardware platform for all components; no hard disc or fans - no wearout
- Volume calculations and correction included according to international standards (API/ASTM/IP tables) in Tank Scanner NXA820
- Predefined or customized operator screens for typical operation of a tank farm

Table of Contents

Applications	3	Examples of operating pages	38
Inventory control	3		
Inventory calculations	3		
Remote configuration of measuring equipment	3		
Application areas	3		
Function and system design	4	Supplementary documentation	40
System design	4	Operating Instructions	40
System configuration	4	Description of Instrument Functions	40
Features	5		
Typical system configurations	6	Trademarks	40
Tankvision NXA820 (Tank Scanner)	7	MODBUS	40
Function	7	Windows	40
Number of tanks	7	Java	40
LAN connections	7	41
Input NXA820	7	42
Output NXA820	7		
Power supply NXA820	8		
Terminals NXA820	9		
Ambient conditions NXA820	15		
Mechanical construction	16		
Human interface	17		
Certificates and approvals	17		
Ordering information NXA820	18		
Tankvision NXA821 (Data Concentrator)	19		
Function	19		
Number of tanks	19		
LAN connections	19		
Output NXA821	19		
Power supply	20		
Terminals NXA821	21		
Ambient conditions	23		
Mechanical construction	23		
Human interface	24		
Certificates and approvals	24		
Ordering information NXA821	25		
Tankvision NXA822 (Host Link)	27		
Function	27		
Number of tanks	27		
LAN connections	27		
Output NXA822	27		
Power supply	28		
Terminals NXA822	28		
Ambient conditions	34		
Mechanical construction	34		
Human interface	35		
Certificates and approvals	35		
Ordering information NXA822	36		
Human interface	37		
Operating concept	37		
Languages	37		
System requirements			
of user PC	37		

Applications

Inventory control

By using Tankvision to monitor the tank level and stored volume of valuable liquids remotely, owners or operators of tank farms or terminals for petroleum products and chemicals (liquids) can visualize the volume of the stored medium in real time. The data can be used to plan the inventory and distribution. The data can also be used to manage tank farm operations like pumping or transferring products.

Tankvision has its unique concept using network technology. Without using proprietary software, the users can visualize and manage their valuable liquids stored in the tanks by a web browser.

Tankvision is a flexible and cost effective solution due to its scalable architecture. The application coverage goes from small depots with only a few tanks up to refineries.

Inventory calculations

Tankvision calculates gross, net volumes and mass, based on measured variables and tank capacity tables. Volumes and density of products like hydrocarbons, LPG's, asphalt are corrected according to international standards, including API/ASTM tables 5A, 5B/6, 53A, 53B/54, 23/24, LPG. This includes temperature corrections at 15C, 60F and alternative temperatures. Additionally, available pumpable volumes and water volume are calculated. Up to 3000 strapping points per tank are supported for vertical, spherical and bullet tanks.

Remote configuration of measuring equipment

Tankvision does not only acquire the current measured level or volume from the tanks. The configuration of device settings from the control room is also possible by using the corresponding HART operating software from Endress+Hauser (e.g. ToF Tool or FieldCare) for the connected Endress+Hauser devices. Tankvision passes on the device setting information transparently, so that all device functions for the respective operating software are available from the control room. Some on-site operations can be avoided using this feature during commissioning or maintenance. (The availability of this feature may depend on the system configuration.)

Application areas

- tank farms in refineries
- ship loading terminals
- marketing and distribution terminals
- pipeline terminals
- logistic terminals for tanks storing products like crude oils, refined white and black products, chemicals, LPGs

Function and system design

System design

Tank management visualization without proprietary software

Tankvision is the first tank management visualization system providing its functionality without the need to have proprietary software installed and maintained on a PC. The main functionality is realized by embedded web pages in the Tankvision components. Tankvision uses an industrial proven operating system and provides high availability. Tankvision is not based on a PC platform and runs independent of connected PCs. This eliminates the need to maintain a specialized PC with a Windows operating system and necessary updates and hot fixes. Tankvision web pages can be accessed from a standard PC with a web browser and the Java Runtime Environment only. Multiple users with different roles can simultaneously log in to each Tankvision component. Additional users can be added as required. There are no multi-user licence fees.

Distributed architecture and scalability

Tankvision is based on a distributed architecture on a Local Area Network (LAN). Coordinated components perform all inventory management tasks. The modular design makes it easy to enlarge the system whenever required and to add further tank areas.

Thus, Tankvision is fully scalable and is ideally suited for applications of any size - from small tank farms to large refineries.

Common hardware platform

The Tankvision components have dedicated tasks in a system, but have a common architecture, based on a 32 Bit processor. The embedded tank management software uses a multi-threaded real time operating system (RTOS), specifically designed for industrial applications. The hardware is designed without wear-out components like hard discs or fans. This guarantees high reliability.

System configuration

Configuration of the components

Each Tankvision component has its own data base and a web server. The components are connected and exchange data with time stamp and status information. Data is optionally encrypted and secured by a CRC checksum.

The Tankvision components are configured with static IP addresses, which are reserved on a DHCP network. The configuration pages are embedded in the Tankvision components and allow configuration of Tankvision via a connected web browser without configuration software. No Internet access is necessary, as all pages are loaded from the Tankvision system itself.

Configuration of the connected tank gauges/sensors (available for Windows XP SP1; in preparation for Windows XP SP2)

Tankvision supports connection of Endress+Hauser configuration tools (e.g. ToF Tool or FieldCare) via LAN. This enables configuration of the tank gauges if they support remote configuration (e.g. Tank Side Monitor NRF590 and the level radars Micropilot S FMR53x/FMR54x).

The tank gauges must be connected to the Tank Scanner NXA820 in one of the following ways:

- via a field protocol
- via HART to the Tank Side Monitor NRF590 (version 02.04) which in turn is connected via one of the following protocols to the Tank Scanner NXA820:
 - MODBUS
 - Sakura V1
 - Whessoematic WM550 (in preparation)

Features

- **Representation of tank data**
Tank data can be represented graphically or in tables. The corresponding HTML pages are predefined.
- **Definition and management of tank groups**
The total contents of static or dynamic tank groups (e.g. of tanks containing the same product) can be displayed.
- **Definition and management of products**
Product characteristics can be defined. The defined product can be attributed to a number of tanks. Links to product safety sheets can be integrated.
- **Trend display**
Real time and historical trends of the tank parameters can be displayed. The data is stored in the internal memory.
- **Archive**
Tankvision stores measured and calculated data, log files and alarms on the internal flash memory.
- **Alarms**
Limit alarms (high-high, high, low, low-low) can be defined for measured and calculated tank parameters. An alarm bar visualizes alarms in the browser window. Alarms can be reported by an optional Alarm Popup¹⁾ window.
- **Products**
A product database allows definition of 250 products per NXA or shared in the system.
- **Monitoring of transfers**
Product transfers from and to tanks can be monitored. Pre-alarms can be generated before completion of the transfer. A report is issued after the transfer.
- **Auditing**
An auditing table contains all events such as alarms or configuration changes.
- **Log-In roles**
Log-In roles with different access rights (supervisor, operator, guest) can be assigned to users and user groups.
- **Reports**
Reports are predefined as HTML pages. They can be sent to a printer connected to a computer at scheduled time intervals by an optional Printer Agent¹⁾.
- **Volume calculation and correction**
Available calculation tables according to API, ASTM and IP can be integrated.
- **Graphical User Interface (GUI)**
Tankvision uses an intuitive and optimized user interface (e.g. automatic creation of dynamic tank groups).
- **Remote access**
Any PC with the specified requirements which is connected to the Intranet can be connected with Tankvision.
- **Redundancy (in preparation)**
Two Tankvision components of the same type can be interconnected via the SyncLink interface. Only the primary NXA has to be configured. The secondary NXA takes over the task if the master fails (see diagram on page 6).

1) available for Windows on the device to upload; other operating systems in preparation

Typical system configurations Small tank farm (up to 15 tanks)

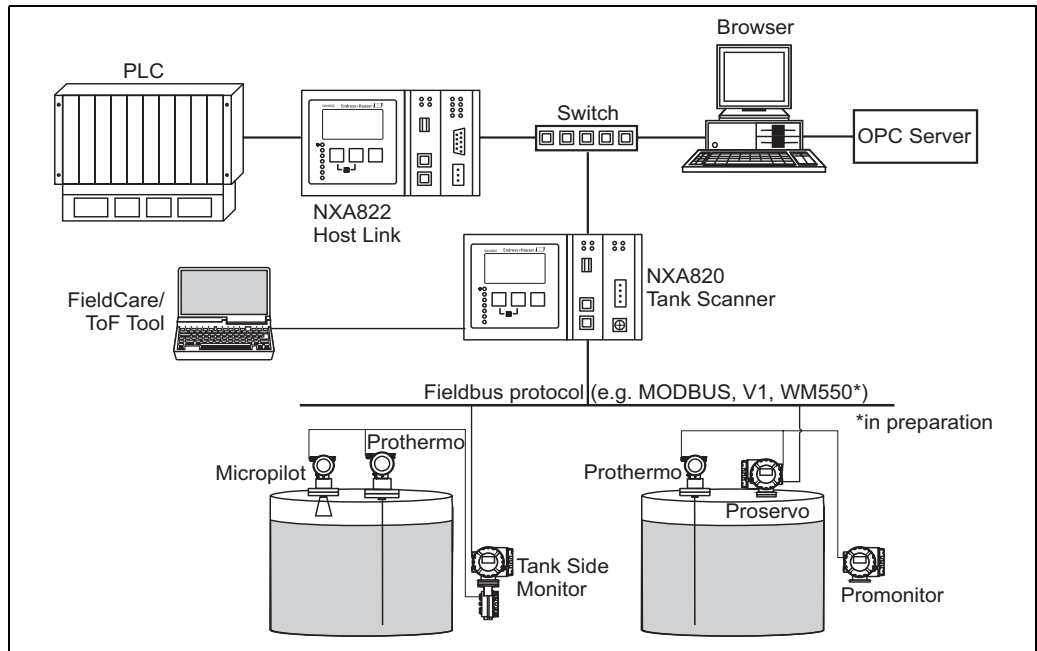

L00-NXA82xxx-02-00-00-en-001

Refinery (up to 225 tanks)

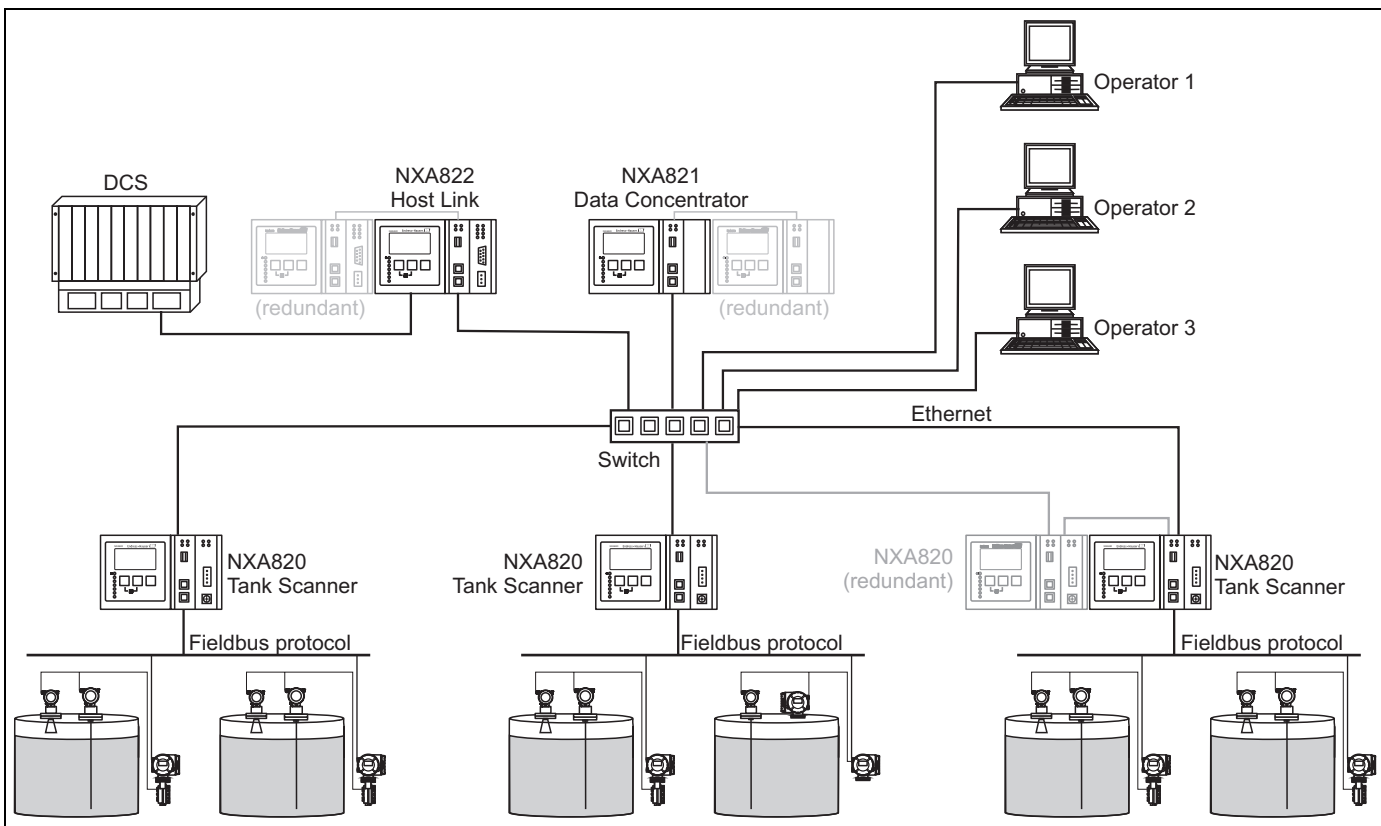

L00-NXA82xxx-02-00-00-en-002

Tankvision NXA820 (Tank Scanner)

Function

- The Tank Scanner NXA820 connects multiple tank gauges from up to 15 tanks via one field-loop. The Tank Scanner NXA820 supports different field protocols (Modbus EIA485, Sakura V1, Whessoematic WM550).
- The measured values are transmitted by the network and visualized on HTML pages.
- The Tank Scanner NXA820 can be used stand-alone for small tank farms, but also be integrated into a large system for use in refineries.
- The Tank Scanner NXA820 is equipped with a full set of tank inventory calculations. The calculations are based on various international standards such as API, ASTM, IP and many others. Measured values are used to calculate volume and mass.

Number of tanks

Protocol	max. number of tanks per NXA820
MODBUS EIA485	15
Sakura V1	10
Whessoematic WM550 (in preparation)	15

LAN connections

System LAN port

100 BASE-TX, Full/Half Duplex, 100 Mbit, Shielded RJ45 connector
Connects the NXA820 Tank Scanner to the Local Area Network (LAN)

Sync-Link LAN port (in preparation)

100 BASE-TX, Full/Half Duplex, 100 Mbit, Shielded RJ45 connector
Connects the NXA820 Tank Scanner (e.g. primary) to an optional redundant unit (e.g. secondary), to make sure the two devices remain synchronized with each other. If the primary unit fails, the secondary NXA820 Tank Scanner takes over operation without system interruption (see diagram on page 6).

Service LAN port

100 BASE-TX, Full/Half Duplex, 100 Mbit, Shielded RJ45 connector
Connects the NXA820 Tank Scanner to a local computer **only** for local commissioning and service operations. The computer does not become part of the local area network the NXA820 Tank Scanner is connected to through the System LAN port.

This port has a fixed IP address and can also provide the connected computer automatically with a compatible IP address using a DHCP server built into the NXA820 Tank Scanner. For this automatic IP function to work the computer must be set to obtain its IP address using a DHCP server



Note!

All LAN ports support Auto-MDIX. This system automatically detects the type of cable connected (either straight or crossed) and adjusts itself to match. With this feature you do not need to obtain special crossed cables to interconnect Tankvision components.

Input NXA820

Fieldbus protocols

The Tank Scanner NXA820 is available with the following field protocols:

- MODBUS EIA485 master, max. 15 gauges
- Sakura V1, max. 10 gauges
- Whessoematic 550, max. 15 gauges (in preparation)

Output NXA820

NXA Status Relay

- potential free relay, SPDT
- normally-closed when NXA is operating normally, open when NXA is powered off or in fault status
- switching power:
 - 25 V_{DC}, 100 W
 - 250 V_{AC}, 4 A, 1000VA

Power supply NXA820

Instrument version	Supply voltage	Power consumption	Current consumption	Fuse
AC voltage NXA820 - ##1#####	90 - 250 V _{AC} (50/60Hz)	max. 23 VA	max. 100 mA at 230 VAC	400 mA T
DC voltage NXA820 - ##2#####	10.5 - 32 V _{DC}	max. 14 W	max. 580 mA at 24 VDC	2 A T

Galvanic isolation

The following terminals are galvanically isolated from each other:

- Alarm relay output
- LAN interfaces
- Fieldbus interface

Terminals NXA820

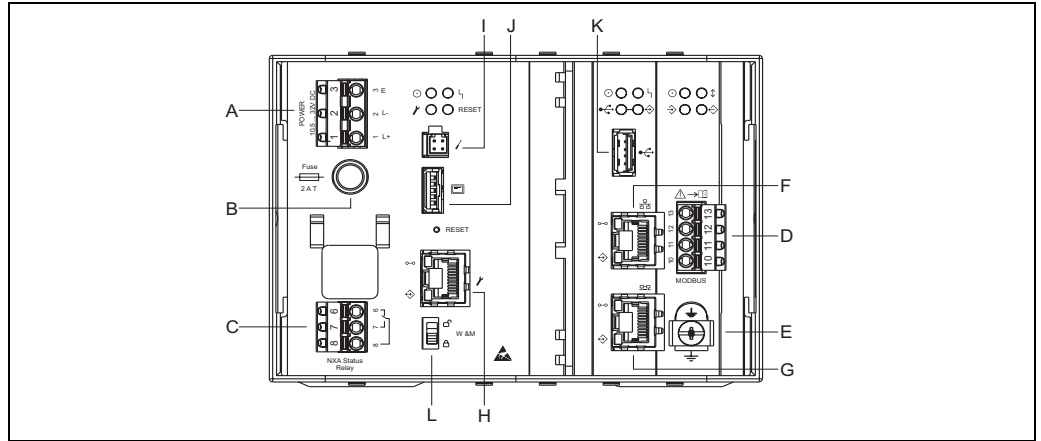

L00-NXA82xxx-04-00-00-yy-019

A: Power supply; **B:** Fuse; **C:** Status relay; **D:** Fieldbus connection; **E:** Ground; **F:** System LAN port; **G:** Sync Link LAN port; **H:** Service LAN port; **I:** Endress+Hauser CDI port; **J:** Display port; **K:** USB port; **L:** Weights & Measures locking switch

Power supply (AC version)

Terminal	Meaning	Remarks
1	L	90 - 250 V _{AC} Connector: Phoenix 7.62 GMSTB/GFKC
2	N	
3	Potential equalization	
	Fuse	400 mA T

Power supply (DC version)

Terminal	Meaning	Remarks
1	L+	10.5 - 32V _{DC} Connector: Phoenix 7.62 GMSTB/GFKC
2	L-	
3	Potential equalization	
	Fuse	2 A T

Status Relay

Terminal	Meaning	Remarks
6	normally open contact	<ul style="list-style-type: none"> ■ NXA operating normally: terminals 7 & 8 are interconnected ■ NXA powered off or fault status condition: terminals 6 & 8 are interconnected
7	normally closed contact	
8	switching contact	

Connector: Phoenix FKC 2,5HC/3-St-5,08



Note!

The depicted switching state of the relay refers to the de-energized state.

Field connection: MODBUS Serial, EIA/TIA-485 (RS485)

Terminal	EIA/TIA-485 MODBUS	Meaning	Remarks
13	S	Capacitive Shield	Connector: Phoenix FKIC 2,5/4-St-5,08
12	C	Signal Common	
11	B	+ signal	
10	A	- signal	
	Ground		Must be independently connected directly to a primary grounding point using 4 mm ² cable.

Two-Wire MODBUS Definition

As described in the “MODBUS over serial line specification and implementation guide V1.02” published by the Modbus-IDA organisation (www.modbus.org) and based upon the EIA/TIA-485-A physical layer specification. MODBUS two-wire serial requires the following four electrical connections between each of the devices on the bus:

Signal	Purpose	Remarks
A	Data signal (-)	These signals must be connected using a balanced twisted pair cable.
B	Data signal (+)	
C	Signal Common	Must interconnect all devices on the bus.
Shield	EMC Protection	Copper braided or combined foil and braided shielding.

Additional EIA/TIA-485 bus settings

- Bus biasing resistors (must be present at one point on the bus) (always enabled inside NXA820)
- Bus termination resistor (must be present at each end of the bus) (software selectable inside NXA820)

MODBUS Cable Specification

Characteristic impedance	135 to 165 Ω at measuring frequency of 3 to 20 MHz
Cable capacitance	≤ 30 pF/m
Core cross-section	≥ 0.34 mm ² , corresponds to AWG 22, multi-strand cable is preferred
Cable type	Single twisted pair + third conductor (for common) or Dual twisted pair (common uses second pair with wire joined together)
Cable resistance	≤ 110 Ω /km
Signal damping	Max. 9 dB over the entire length of the cable cross-section
Shielding	Copper braided shielding or combined foil and braided shielding

Field connection: V1

Terminal	V1	Meaning	Remarks
13	S	Capacitive Shield	Connector: Phoenix FKIC 2,5/4-St-5,08
12		Not connected	
11	A	- signal	
10	B	+ signal	
	Ground		Must be independently connected directly to a primary grounding point using 4 mm ² cable.

V1 Definition

V1 fieldbus is a voltage mode digital communication using up to $\pm 30 V_{DC}$, and requires the following three electrical connections between each of the devices on the bus:

Signal	Purpose	Remarks
A	Data signal (-)	These signals must be connected using a balanced twisted pair cable.
B	Data signal (+)	
Shield	EMC protection	Copper braided or combined foil and braided shielding

V1 Cable specification

Cable capacitance	$\leq 50 \text{ nF/m}$
Core cross-section	$\geq 0.9 \text{ mm}^2$, corresponds to AWG 17, multi-strand cable is preferred
Cable type	twisted pair
Cable resistance	$\leq 30 \text{ } \Omega/\text{km}$
Shielding	Copper braided shielding or combined foil and braided shielding
Insulation	$\geq 60 V_{DC}$

**Field connection: Whessoematic 550 (WM550)
(in preparation)**

Terminal	WM550	Meaning	Remarks
13		Not connected	Connector: Phoenix FKIC 2,5/4-St-5,08
12		Not connected	
11	+	Loop Send	
10	-	Loop Return	
	Ground		Must be independently connected directly to a primary grounding point using 4 mm ² cable.

WM550 Definition

WM550 fieldbus consists of a current loop which passes from the source device (e.g. NXA820) through all connected gauges before returning to the source device. Typically this is managed by a single multi-core cable which holds both the outgoing and returning current loop, and requires the following two electrical connections between each of the devices on the bus:

Signal	Purpose	Remarks
+	Current Loop (+)	Current always flows from positive to negative within the loop.
-	Current Loop (-)	



Caution!
WM550 loop signal voltages can be as high as 100 V_{DC}.

WM550 Cable specification

Cable capacitance	≤ 75 nF/m
Core cross-section	≥ 0.5 mm ² , corresponds to AWG 20, multi-strand cable is preferred
Cable type	twisted pair
Cable resistance	≤ 40 Ω/km (total loop resistance ≤ 250Ω)
Shielding	None
Insulation	≥ 100 V _{DC}

Shielding and Grounding

When planning the shielding and grounding for a fieldbus system, there are three important points to consider:

- Electromagnetic compatibility (EMC)
- Explosion protection
- Safety of the personnel

To ensure the optimum electromagnetic compatibility of systems, it is important that the system components and above all cables, which connect the components, are shielded and that no portion of the system is unshielded. Ideally, the cable shields are connected to the normally metal housings of the connected field devices. Since these are generally connected to the protective earth, the shield of the bus cable is grounded many times. Keep the stripped and twisted lengths of cable shield to the terminals as short as possible. This approach, which provides the best electromagnetic compatibility and personnel safety, can be used without restriction in systems with good potential equalization.

In the case of systems without potential equalization, a power supply frequency (50/60 Hz) equalizing current can flow between two grounding points which, in unfavourable cases, e.g. when it exceeds the permissible shield current, may destroy the cable.

To suppress the low frequency equalizing currents on systems without potential equalization, it is therefore recommended to connect the cable shield directly to the building ground (or protective earth) at one end only and to use capacitive coupling to connect all other grounding points.

The NXA820 provides two grounding points for the shield, close to the fieldbus interface connector:



- The “ \perp ” terminal, which should already be connected directly to ground
- The “S” terminal (13), which provides capacitive connection to the “ \perp ” terminal













Caution!

The legal EMC requirements are fulfilled **only** when the cable shield is grounded on both sides!





LAN connection

Socket	Meaning	Remarks
	System LAN port	Connects the instrument to the network.
	Sync Link LAN port (in preparation)	Used for connection to redundant unit. If the primary unit fails, its task is taken over by the redundant unit.
	Service LAN port	Connects the instrument to a computer locally for service purpose. Only this instrument can be configured. The Service LAN port does not allow access to the network.

LEDs

Symbol	Color	Meaning
	Green	Power On
	Yellow	Stand-by Indicates the box is a redundant secondary unit, and is ready to take over if the primary unit fails.
	Red	Fault Indicates a Fault when lit or "Maintenance required" when flashing
	Yellow	Communication Flashes when the NXA820 Tank Scanner completes a successful fieldbus communication cycle (e.g. Sent a request and received a reply).
	Yellow	Fieldbus Rx Flashes to indicate data bits are being received from the connected field devices.
	Yellow	Fieldbus Tx Flashes to indicate data bits are being sent to the connected field devices.
		Data Transfer
	Green	Indicates data is being transferred on the LAN interface.
	Yellow	Indicates data is being transferred on the USB interface.
	Green	Linked
	Yellow	USB active (for future enhancements) When lit the connected USB device has been detected and is in use. Do not remove the device while this LED is lit.
	Yellow	Service Indicates a Service operation is currently active (e.g. during HART tunnelling).

Additional elements in the terminal compartment

Symbol	Meaning	Remarks
	Endress+Hauser CDI port	Not used in the Tankvision instrument.
	Display port	For the connection of the local display in the housing cover. Is connected on delivery.
	USB port	Reserved for future enhancements.
W&M	Weights & Measures Switch	<ul style="list-style-type: none"> ▪  :W&M parameters are unlocked and can be changed. ▪  :W&M parameters are locked and cannot be changed.

Ambient conditions NXA820

Mounting location	Cabinet or protective housing
Ambient temperature	-40 ... +60 °C (-40 ... +140 °F)
Storage temperature	-40 ... +85 °C (-40 ... +185 °F)
Relative humidity	max. 90% at +25 °C (non-condensing)
Ingress protection	IP20

Electromagnetic compatibility (EMC)

The device complies with the requirements of the EMC Directive 89/336/EEC, "Electromagnetic Compatibility".

Installation

Tankvision NXA820 Tank Scanner is designed to be installed in a cabinet, using a standard 35 mm DIN (top-hat) rail conforming to EN50022 (BS5584) (IEC 60715).

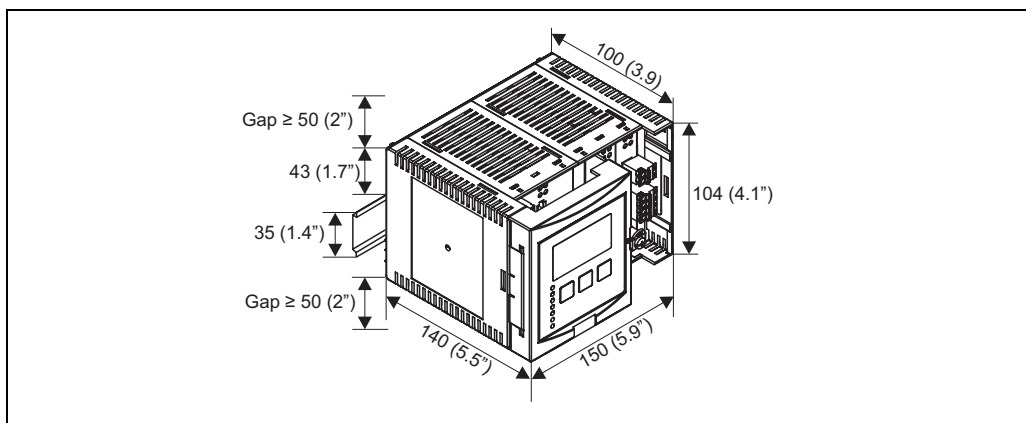
Mechanical construction**Dimensions**

Dimensions in mm (inch)

Materials*Housing*

Polycarbonate
Colour: light grey

Front cover

Polyamide PA6
Colour: grey

Fixing slide (for fastening on the top-hat rail)

Polyamide PA6
Colour: black

Human interface

Display module

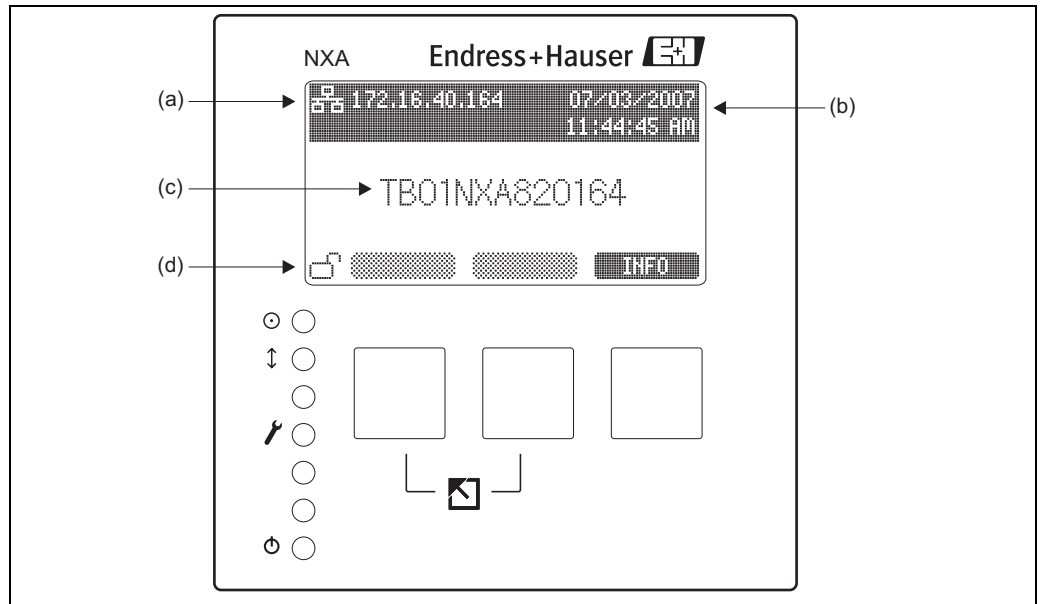

(a): IP address; **(b):** date and time; **(c):** instrument tag; **(d):** W&M switch status

L00-NXA820xx-07-00-00-yy-001

LEDs

Symbol	Color	Meaning
⊙	Green/Red	Green = Power On Red = Indicates a Fault when lit or "Maintenance required" when flashing.
↑	Yellow	Communication Flashes when the NXA820 Tank Scanner completes a successful fieldbus communication cycle (e.g. Sent a request and received a reply).
🔧	Yellow	Service Indicates a Service operation is currently active (e.g. during HART tunnelling).
⊕	Yellow	Stand-by Indicates the box is a redundant secondary unit, and is ready to take over if the primary unit fails.

Certificates and approvals

NMi

W&M approval according to OIML R 85 (in preparation)

PTB

Innerstaatliche Bauartzulassung (in preparation)

**Ordering information
NXA820**

010	Approval	
	A	Non-hazardous area
020	Field Communication; Input	
	8	Sakura V1 protocol, max. 10 instruments
	1	Whessoematic 550, max. 15 instruments (in preparation)
	4	MODBUS EIA485 master, max. 15 instruments
	Y	Special version, to be specified
030	Power supply	
	1	90-250 VAC 50/60Hz
	2	10.5-32 VDC
	9	Special version, to be specified
040	Inventory calculations	
	1	Oil+gas
	9	Special version, to be specified
050	Data Archive Memory Size	
	D	1GB; 15 parameters/min; 90 days
	Y	Special version, to be specified
060	Local Operation	
	1	status display
	9	Special version, to be specified
070	Operation language	
	A	English
	Y	Special version, to be specified
080	Housing	
	1	DIN rail mounting PBT, IP20
	9	Special version, to be specified
090	Redundancy	
	1	w/o
	2	activated (in preparation)
	9	Special version, to be specified
100	Custody Transfer Approval	
	0	not selected
	1	NMI + PTB type (in preparation)
	9	Special version, to be specified
110	Additional Option	
	A	Basic version
	Y	Special version, to be specified
NXA820 -		complete product designation

Tankvision NXA821 (Data Concentrator)

Function	<ul style="list-style-type: none"> ■ The NXA821 Tankvision Data Concentrator is the enhanced solution for large tank farms and refineries. The Data Concentrator is required if: <ul style="list-style-type: none"> – the plant contains more than one field loop (each of which has its own Tank Scanner NXA820) – tanks of more than one Tank Scanner NXA820 are to be grouped ■ The Data Concentrator collects the data of several Tank Scanner units and enables reconciliation and totalization of the tank data of many or all tanks in structured groups. ■ Alarms and events from all connected Tank Scanners NXA820 can be shown in a common screen. Any tank of the system can be assigned to any tank group, regardless of the Tank Scanner it is linked to. This ensures the highest possible flexibility for the plant or tank farm. ■ An alarm pop-up shows alarms of all connected Tank Scanners NXA820 even if the web browser is closed. ■ A central log-in allows access to all Tank Scanners NXA820 in the network without having to access each unit via its IP address. Tank details of all units can be viewed from a central location.
-----------------	-------------------------------------------------------------------------------------------------------------------------------------------------------------------------------------------------------------------------------------------------------------------------------------------------------------------------------------------------------------------------------------------------------------------------------------------------------------------------------------------------------------------------------------------------------------------------------------------------------------------------------------------------------------------------------------------------------------------------------------------------------------------------------------------------------------------------------------------------------------------------------------------------------------------------------------------------------------------------------------------------------------------------------------------------------------------------------------------------------------------------------------------------------------------------------------------------------------------------------------------------------

Number of tanks	<ul style="list-style-type: none"> ■ 225 tanks²⁾ can be allocated to each Data Concentrator NXA821. Each of these tanks must have been allocated to a Tank Scanner NXA820 beforehand. If more than 225 tanks are to be integrated in the system, multiple Data Concentrators NXA821 have to be used. ■ Tanks from up to 15 different Tank Scanners NXA820 can be integrated in this way³⁾. If more than 15 Tank Scanners NXA820 are involved, multiple Data Concentrators NXA821 have to be used.
------------------------	---------------------------------------------------------------------------------------------------------------------------------------------------------------------------------------------------------------------------------------------------------------------------------------------------------------------------------------------------------------------------------------------------------------------------------------------------------------------------------------------------------------------------------------------------------

LAN connections

System LAN port

100 BASE-TX, Full/Half Duplex, 100 Mbit, Shielded RJ45 connector
Connects the NXA821 Data Concentrator to the Local Area Network (LAN)

Sync-Link LAN port (in preparation)

100 BASE-TX, Full/Half Duplex, 100 Mbit, Shielded RJ45 connector
Connects the NXA821 Data Concentrator (e.g. primary) to an optional redundant unit (e.g. secondary), to make sure the two devices remain synchronized with each other. If the primary unit fails, the secondary NXA821 Data Concentrator takes over operation without system interruption (see diagram on page 6).

Service LAN port

100 BASE-TX, Full/Half Duplex, 100 Mbit, Shielded RJ45 connector
Connects the NXA821 Data Concentrator to a local computer only for local commissioning and service operations. The computer does not become part of the local area network the NXA821 Data Concentrator is connected to through the System LAN port.
This port has a fixed IP address and can also provide the connected computer automatically with a compatible IP address using a DHCP server built into the NXA821 Data Concentrator. For this automatic IP function to work the computer must be set to obtain its IP address using a DHCP server



Note!

All LAN ports support Auto-MDIX, this system automatically detects the type of cable connected (either straight or crossed) and adjusts itself to match. With this feature you do not need to obtain special crossed cables to interconnect Tankvision components.

Output NXA821

NXA Status relay

- potential free relay, SPDT
- normally-closed when NXA is operating normally, open when NXA is powered off or in fault status
- switching power:
 - 25 V_{DC}, 100 W
 - 250 V_{AC}, 4 A, 1000VA

2) standard: 45 tanks;
on request: more than 45 tanks, up to 225 tanks

3) standard: 4 Tank Scanners;
on request: more than 4 Tank Scanners, up to 15 Tank Scanners

Power supply

Instrument version	Supply voltage	Power consumption	Current consumption	Fuse
AC voltage NXA821 - #1#####	90 - 250 V _{AC} (50/60Hz)	max. 23 VA	max. 100 mA at 230 VAC	400 mA T
DC voltage NXA821 - #2#####	10.5 - 32 V _{DC}	max. 14 W	max. 580 mA at 24 VDC	2 A T

Galvanic isolation

The following terminals are galvanically isolated from each other:

- Alarm relay output
- LAN interfaces

Terminals NXA821

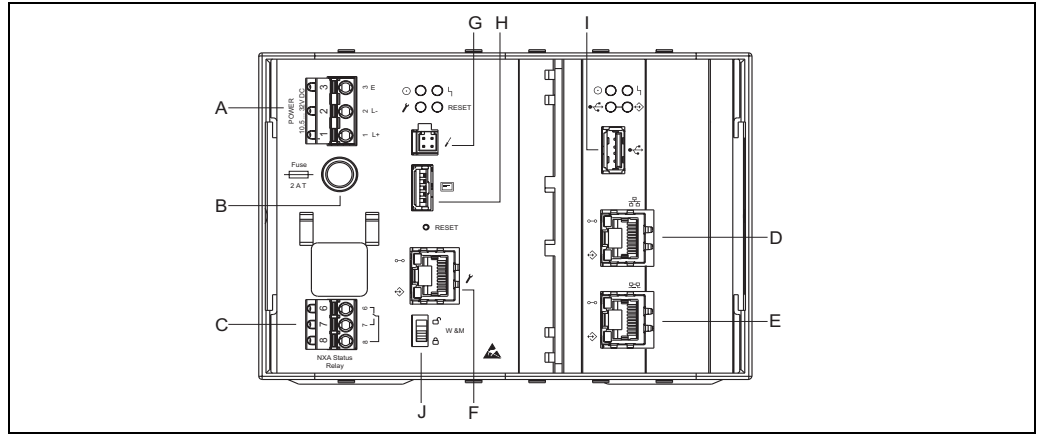

A: Power supply; **B:** Fuse; **C:** Status relay; **D:** System LAN port; **E:** Sync Link LAN port; **F:** Service LAN port; **G:** Endress+Hauser CDI port; **H:** Display port; **I:** USB port; **J:** Weights & Measures locking switch

Power supply (AC version)

Terminal	Meaning	Remarks
1	L	90 - 250 V _{AC} Connector: Phoenix 7.62 GMSTB/GFKC
2	N	
3	Potential equalization	
	Fuse	400 mA T



Power supply (DC version)

Terminal	Meaning	Remarks
1	L+	10.5 - 32V _{DC} Connector: Phoenix 7.62 GMSTB/GFKC
2	L-	
3	Potential equalization	
	Fuse	2 A T









NXA Status relay

Terminal	Meaning	Remarks
6	normally open contact	Connector: Phoenix FKC 2,5HC/3-St-5,08 <ul style="list-style-type: none"> ■ NXA operating normally: terminals 7 & 8 are interconnected ■ NXA powered off or fault status condition: terminals 6 & 8 are interconnected
7	normally closed contact	
8	switching contact	





LAN connection

Socket	Meaning	Remarks
	System LAN port	Connects the instrument to the network.
	Sync Link LAN port (in preparation)	Used for connection to redundant unit. If the primary unit fails, its task is taken over by the redundant unit.
	Service LAN port	Connects the instrument to a computer locally for service purpose. Only this instrument can be configured. The Service LAN port does not allow access to the network.

LEDs

Symbol	Color	Meaning
	Green	Power On
	Yellow	Stand-by Indicates the box is a redundant secondary unit, and is ready to take over if the primary unit fails.
	Red	Fault Indicates a Fault when lit or "Maintenance required" when flashing
	Yellow	NXA Communication Flashes when the NXA821 Data Concentrator receives a new set of tank data from a connected NXA820 Tank Scanner, through the LAN interface.
		Data Transfer
	Green	Indicates data is being transferred on the LAN interface.
	Yellow	Indicates data is being transferred on the USB interface.
	Green	Linked
	Yellow	USB active (for future enhancements) When lit the connected USB device has been detected and is in use, do not remove the device while this LED is lit.
	Yellow	Service Indicates a Service operation is currently active (e.g. during HART tunnelling).

Additional elements in the terminal compartment

Symbol	Meaning	Remarks
	Endress+Hauser CDI port	Not used in the Tankvision instrument.
	Display port	For the connection of the local display in the housing cover. Is connected on delivery.
	USB port	Reserved for future enhancements.
W&M	Weights & Measures Switch	<ul style="list-style-type: none"> ■  :W&M parameters are unlocked and can be changed. ■  :W&M parameters are locked and cannot be changed.

Ambient conditions

Mounting location	Cabinet or protective housing
Ambient temperature	-40 ... +60 °C (-40 ... +140 °F)
Storage temperature	-40 ... +85 °C (-40 ... +185 °F)
Relative humidity	max. 90% at +25 °C (non-condensing)
Ingress protection	IP20

Electromagnetic compatibility (EMC)

The device complies with the requirements of the EMC Directive 89/336/EEC, "Electromagnetic Compatibility".

Installation

Tankvision NXA821 Data Concentrator is designed to be installed in a cabinet, using a standard 35 mm DIN (top-hat) rail conforming to EN50022 (BS5584) (IEC 60715).

Mechanical construction

Dimensions

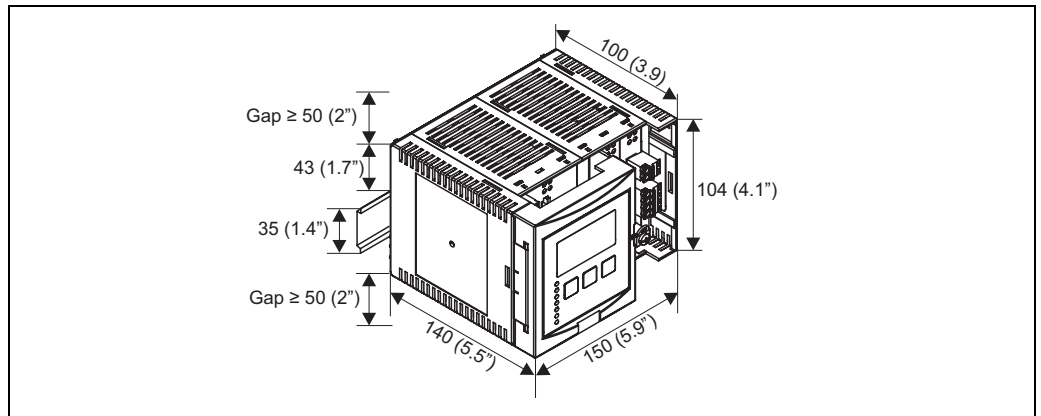

NXA82xxx-06-00-00-yy-003

Dimensions in mm (inch)

Materials

Housing

Polycarbonate
 Colour: light grey

Front cover

Polyamide PA6
 Colour: grey

Fixing slide (for fastening on the top-hat rail)

Polyamide PA6
 Colour: black

Human interface

Display module

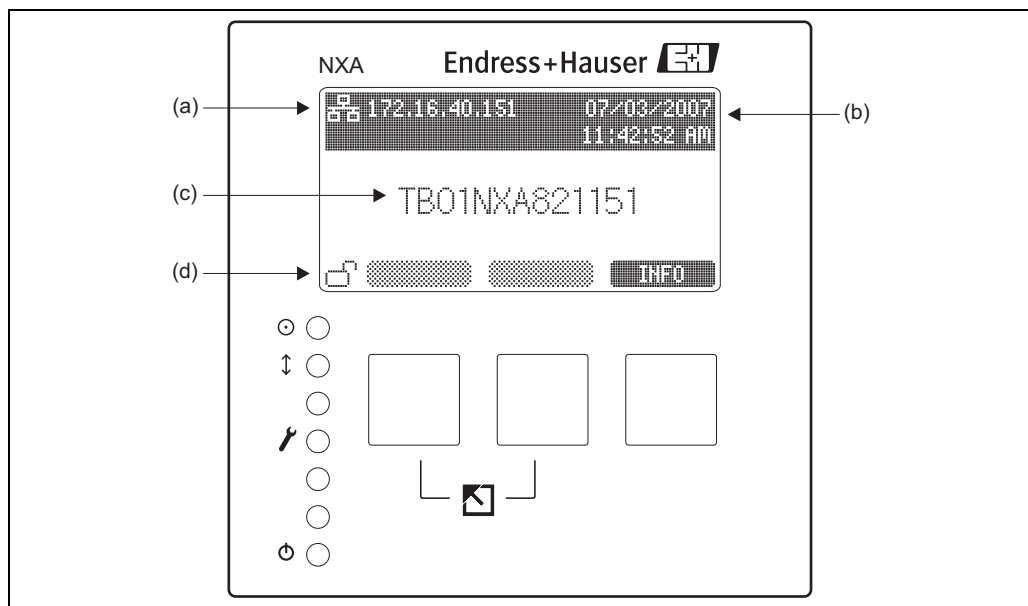

L00-NXA821xx-07-00-00-yy-001

(a): IP address; (b): date and time; (c): instrument tag; (d): W&M switch status

LEDs

Symbol	Color	Meaning
⊖	Green/Red	Green = Power On Red = Indicates a Fault when lit or "Maintenance required" when flashing.
↕	Yellow	NXA Communication Flashes when the NXA821 Data Concentrator receives a new set of tank data from a connected NXA820 Tank Scanner, through the LAN interface.
🔧	Yellow	Service Indicates a Service operation is currently active (e.g. during HART tunnelling).
⌚	Yellow	Stand-by Indicates the box is a redundant secondary unit, and is ready to take over if the primary unit fails.

Certificates and approvals

NMi

W&M approval according to OIML R 85 (in preparation)

PTB

Innerstaatliche Bauartzulassung (in preparation)

**Ordering information
NXA821**

010	Approval	
	A	Non-Hazardous area
030	Power supply	
	1	90-250 VAC 50/60Hz
	2	10.5-32 VDC
	9	Special version, to be specified
050	Data Archive Memory Size	
	D	1GB; 15 parameters/min; 90 days
	Y	Special version, to be specified
060	Local Operation	
	1	status display
	9	Special version, to be specified
070	Operation Language	
	A	English
	Y	Special version, to be specified
080	Housing	
	1	DIN rail mounting PBT, IP20
	9	Special version, to be specified
090	Redundancy	
	1	w/o
	2	activated (in preparation)
	9	Special version, to be specified
100	Custody Transfer Approval	
	0	not selected
	1	NMI + PTB type (in preparation)
	9	Special version, to be specified
110	Additional Option	
	A	Basic version
	Y	Special version, to be specified
NXA821 -		complete product designation

Tankvision NXA822 (Host Link)

Function

- The Host Link NXA822 collects data from all Tank Scanners NXA820 on a network and transfers them to the host system.
- The MODBUS option supports serial EIA-232(RS) and EIA-485(RS), as well as MODBUS TCP/IP. The NXA822 is configured as a MODBUS slave. Supported functions are:
 - Coil Status (#01)
 - Holding Registers (#03)
 - Input Registers (#04)
 - Write Modbus Values (#06)
- The MODBUS register map can be described via XML files and so easily adapted to individual MODBUS master requirements.

Number of tanks

- 225 tanks⁴⁾ can be allocated to each Host Link NXA822. Each of these tanks must have been allocated to a Tank Scanner NXA820 before.
If more than 225 tanks are to be integrated in the system, multiple Host Links NXA822 have to be used.
- Tanks from up to 15 different Tank Scanners NXA820 can be integrated in this way⁵⁾.
If more than 15 Tank Scanners NXA820 are involved, multiple Host Links NXA822 have to be used.

LAN connections

System LAN port

100 BASE-TX, Full/Half Duplex, 100 Mbit, Shielded RJ45 connector
Connects the NXA822 Host Link to the Local Area Network (LAN)

SyncLink LAN port (in preparation)

100 BASE-TX, Full/Half Duplex, 100 Mbit, Shielded RJ45 connector
Connects the NXA822 Host Link (e.g. primary) to an optional redundant unit (e.g. secondary), to make sure the two devices remain synchronized with each other. If the primary unit fails, the secondary NXA822 Host Link takes over operation without system interruption.

Service LAN port

100 BASE-TX, Full/Half Duplex, 100 Mbit, Shielded RJ45 connector
Connects the NXA822 Host Link to a local computer only for local commissioning and service operations. The computer does not become part of the local area network the NXA822 Host Link is connected to through the System LAN port.

This port has a fixed IP address and can also provide the connected computer automatically with a compatible IP address using a DHCP server built into the NXA822 Host Link. For this automatic IP function to work the computer must be set to obtain its IP address using a DHCP server.



Note!

All LAN ports support Auto-MDIX, this system automatically detects the type of cable connected (either straight or crossed) and adjusts itself to match. With this feature you do not need to obtain special crossed cables to interconnect Tankvision components.

Output NXA822

NXA Status Relay

- potential free relay, SPDT
- normally-closed when NXA is operating normally, open when NXA is powered off or fault status exists
- switching power:
 - 25 V_{DC}, 100 W
 - 250 V_{AC}, 4 A, 1000VA

Host connection

- EIA-232(RS)
- EIA-485(RS)
- TCP-IP on System LAN port

4) standard: 45 tanks;
on request: more than 45 tanks; up to 225 tanks

5) standard: 4 Tank Scanners;
on request: more than 4 Tank Scanners; up to 15 Tank Scanners

Power supply

Instrument version	Supply voltage	Power consumption	Current consumption	Fuse
AC voltage NXA822 - ##1#####	90 - 250 V _{AC} (50/60Hz)	max. 23 VA	max. 100 mA at 230 VAC	400 mA T
DC voltage NXA822 - ##2##### (in preparation)	10.5 - 32 V _{DC}	max. 14 W	max. 580 mA at 24 VDC	2 A T

Galvanic isolation

The following terminals are galvanically isolated from each other:

- Alarm relay output
- LAN interfaces
- Host connection

Terminals NXA822

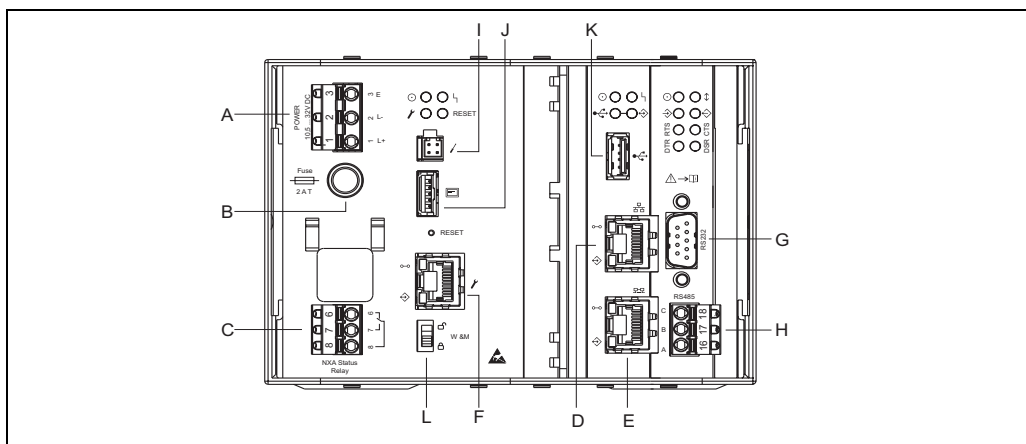

L00-NXA82xxx-04-00-00-yy-021

A: Power supply; **B:** Fuse; **C:** Status relay; **D:** System LAN port; **E:** Sync Link LAN port; **F:** Service LAN port; **G:** RS232 Host connection; **H:** RS485 Host connection; **I:** Endress+Hauser CDI port; **J:** Display port; **K:** USB port; **L:** Weights & Measures locking switch

Power supply (AC version)

Terminal	Meaning	Remarks
1	L	90 - 250 V _{AC} Connector: Phoenix 7.62 GMSTB/GFKC
2	N	
3	Potential equalization	
	Fuse	400 mA T



Power supply (DC version)

Terminal	Meaning	Remarks
1	L+	10.5 - 32V _{DC} Connector: Phoenix 7.62 GMSTB/GFKC
2	L-	
3	Potential equalization	
	Fuse	2 A T

NXA Status Relay

Terminal	Meaning	Remarks
6	normally open contact	Connector: Phoenix FKC 2,5HC/3-St-5,08 ■ NXA operating normally: terminals 7 & 8 are interconnected ■ NXA powered off or fault status condition: terminals 6 & 8 are interconnected
7	normally closed contact	
8	switching contact	

LAN connection

Socket	Meaning	Remarks
	System LAN port	Connects the instrument to the network.
	Sync Link LAN port (in preparation)	Used for connection to redundant unit. If the primary unit fails, its task is taken over by the redundant unit.
	Service LAN port	Connects the instrument to a computer locally for service purpose. Only this instrument can be configured. The Service LAN port does not allow access to the network.

Field connection: MODBUS Serial, EIA/TIA-232 (RS232)

The NXA822 Data Concentrator is defined as a Data Terminal Equipment (DTE) device, and provides EIA/TIA-232 (RS232) interface through a male DB9 connector whose pin out complies with the EIA/TIA-574 standard:

Pin	RS232	Name	Remarks
1	CD	Carrier Detect	Signal from connected device
2	RxD	Receive Data	Signal from connected device
3	TxD	Transmit Data	Signal to connected device
4	DTR	Data Terminal Ready	Signal to connected device
5	G	Signal Ground	Common connection
6	DSR	Data Set Ready	Signal from connected device
7	RTS	Request To Send	Signal to connected device
8	CTS	Clear To Send	Signal from connected device
9	RI	Ring Indicator	Signal from connected device
Case	Shield	Shield	

Definition

EIA/TIA-232 (RS232) is a voltage mode digital communication using up to $\pm 12 V_{DC}$, and requires a variety of signals depending on the operating mode (software selectable):

Signal	Basic RS232	Fully RS232 with Hardware Handshaking (in preparation)	Remarks
Shield	Required	Required	Copper braided or combined foil and braided shielding
G	Required	Required	
RxD	Required	Required	
TxD	Required	Required	
RTS		Required	Null Modem connection, these two pins can be linked together
CTS		Required	
DTR		Required	Null Modem connection, these three pins can be linked together
DSR		Required	
CD		Required	
RI		Optional	Not required

RS-232 Cable Specification

Cable capacitance	≤ 50 pF/m
Core cross-section	≥ 0.34 mm ² , corresponds to AWG 22, multi-strand cable is preferred
Cable type	Single cable or twisted pair
Cable resistance	≤ 110 Ω /km
Signal damping	Max. 9 dB over the entire length of the cable cross-section
Shielding	Copper braided shielding or combined foil and braided shielding

Field connection: MODBUS Serial, EIA/TIA-485 (RS485)

Terminal	EIA/TIA-485 MODBUS	Meaning	Remarks
18	C	Signal Common	Connector: Phoenix FKC 2,5HC/3-St-5,08
17	B	+ signal	
16	A	- signal	

Two-Wire MODBUS Definition

As described in the “MODBUS over serial line specification and implementation guide V1.02” published by the Modbus-IDA organisation (www.modbus.org) and based upon the EIA/TIA-485-A physical layer specification, MODBUS two-wire serial requires the following four electrical connections between each of the devices on the bus:

Signal	Purpose	Remarks
A	Data signal (-)	These signals must be connected using a balanced twisted pair cable.
B	Data signal (+)	
C	Signal Common	Must interconnect all devices on the bus.
Shield	EMC Protection	Copper braided or combined foil and braided shielding

Additional EIA/TIA-485 bus settings

- Bus biasing resistors (must be present at one point on the bus) (software selectable inside NXA822)
- Bus termination resistor (must be present at each end of the bus) (software selectable inside NXA822)

Cable Specification





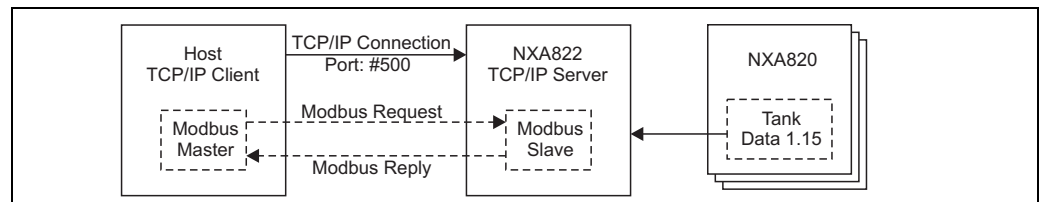





Characteristic impedance	135 to 165 Ω at measuring frequency of 3 to 20 MHz
Cable capacitance	≤ 30 pF/m
Core cross-section	≥ 0.34 mm ² , corresponds to AWG 22, multi-strand cable is preferred
Cable type	Single twisted pair + third conductor (for common) Or Dual twisted pair (common uses second pair with wire joined together)
Cable resistance	≤ 110 Ω /km
Signal damping	Max. 9 dB over the entire length of the cable cross-section
Shielding	Copper braided shielding or combined foil and braided shielding

Field connection: MODBUS TCP/IP







L00-NXA82xxx-04-00-00-yy-024

LEDs

Symbol	Color	Meaning
	Green	Power On
	Yellow	Stand-by Indicates the box is a redundant secondary unit, and is ready to take over if the primary unit fails.
	Red	Fault Indicates a Fault when lit or "Maintenance required" when flashing
	Yellow	Slave Communication (on base unit). Flashes when the NXA822 Host Link completes a successful fieldbus communication cycle (e.g. Receives a request and sends a reply).
	Yellow	NXA Communication (on local display) Flashes when the NXA822 Host Link receives a new set of tank data from a connected NXA820 Tank Scanner, through the LAN interface.
	Yellow	Fieldbus Rx Flashes to indicate data bits are being received from the connected field devices.
	Yellow	Fieldbus Tx Flashes to indicate data bits are being sent to the connected field devices.
RTS	Yellow	Request to Send Flashes to indicate the RTS signal is being sent to the connected field device, only used when Full RS-232 mode is selected, otherwise off.
CTS	Yellow	Clear to Send Flashes to indicate the CTS signal is being received from the connected field device, only used when Full RS-232 mode is selected, otherwise off.
DTR	Yellow	Data Terminal Ready Flashes to indicate the DTR signal is being sent to the connected field device, only used when Full RS-232 mode is selected, otherwise off.
DSR	Yellow	Data Set Ready Flashes to indicate the DSR signal is being received from the connected field device, only used when Full RS-232 mode is selected, otherwise off.
		Data Transfer
	Green	Indicates data is being transferred on the LAN interface.
	Yellow	Indicates data is being transferred on the USB interface.
		Linked Indicates that the LAN cable is both connected and functioning.
	Yellow	USB active (for future enhancements) When lit the connect USB device has been detected and is in use, do not remove the device while this LED is lit.
	Yellow	Service Indicates a Service operation is currently active (e.g. during HART tunnelling).

Additional elements in the terminal compartment

Symbol	Meaning	Remarks
	Endress+Hauser CDI port	Not used in the Tankvision instruments.
	Display port	For the connection of the on-site display in the housing cover. Is connected on delivery.
	USB port	Reserved for future enhancements
W&M	Weights & Measures Locking	<ul style="list-style-type: none"> ▪  :W&M parameters are unlocked and can be changed. ▪  :W&M parameters are locked and cannot be changed.

Shielding and Grounding

When planning the shielding and grounding for a fieldbus system, there are three important points to consider:

- Electromagnetic compatibility (EMC)
- Explosion protection
- Safety of the personnel

To ensure the optimum electromagnetic compatibility of systems, it is important that the system components and above all cables, which connect the components, are shielded and that no portion of the system is unshielded. Ideally, the cable shields are connected to the normally metal housings of the connected field devices. Since these are generally connected to the protective earth, the shield of the bus cable is grounded many times. Keep the stripped and twisted lengths of cable shield to the terminals as short as possible. This approach, which provides the best electromagnetic compatibility and personnel safety, can be used without restriction in systems with good potential equalization.

In the case of systems without potential equalization, a power supply frequency (50/60 Hz) equalizing current can flow between two grounding points which, in unfavourable cases, e.g. when it exceeds the permissible shield current, may destroy the cable.

To suppress the low frequency equalizing currents on systems without potential equalization, it is therefore recommended to connect the cable shield directly to the building ground (or protective earth) at one end only and to use capacitive coupling to connect all other grounding points.



Caution!

The legal EMC requirements are fulfilled **only** when the cable shield is grounded on both sides!

Ambient conditions

Mounting location	Cabinet or protective housing
Ambient temperature	-40 ... +60 °C (-40 ... +140 °F)
Storage temperature	-40 ... +85 °C (-40 ... +185 °F)
Relative humidity	max. 90% at +25 °C (non-condensing)

Electromagnetic compatibility (EMC)

The device complies with the requirements of the EMC Directive 89/336/EEC, "Electromagnetic Compatibility".

Installation

Tankvision NXA822 Host Link is designed to be installed in a cabinet, using a standard 35 mm DIN (top-hat) rail conforming to EN50022 (BS5584) (IEC 60715).

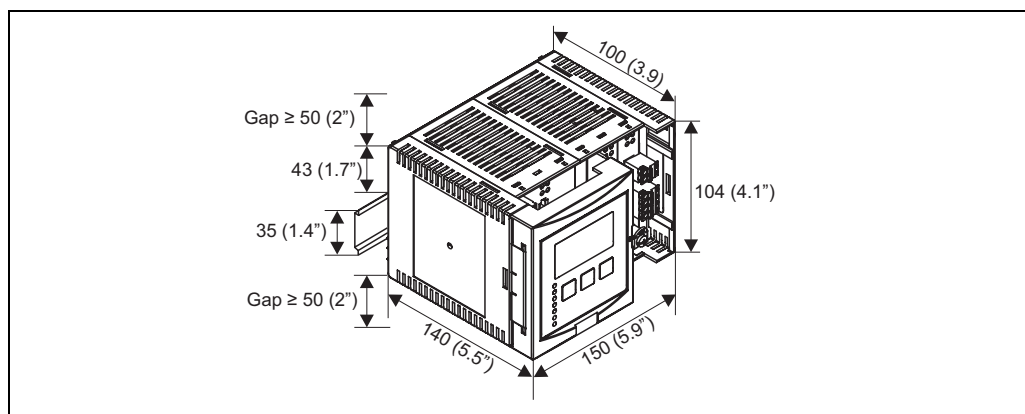
Mechanical construction**Dimensions**

NXA82xxx-06-00-00-yy-003

Dimension in mm (inch)

Materials*Housing*

Polycarbonate
Colour: light grey

Front cover

Polyamide PA6
Colour: grey

Fixing slide (for fastening on the top-hat rail)

Polyamide PA6
Colour: black

Human interface

Display module

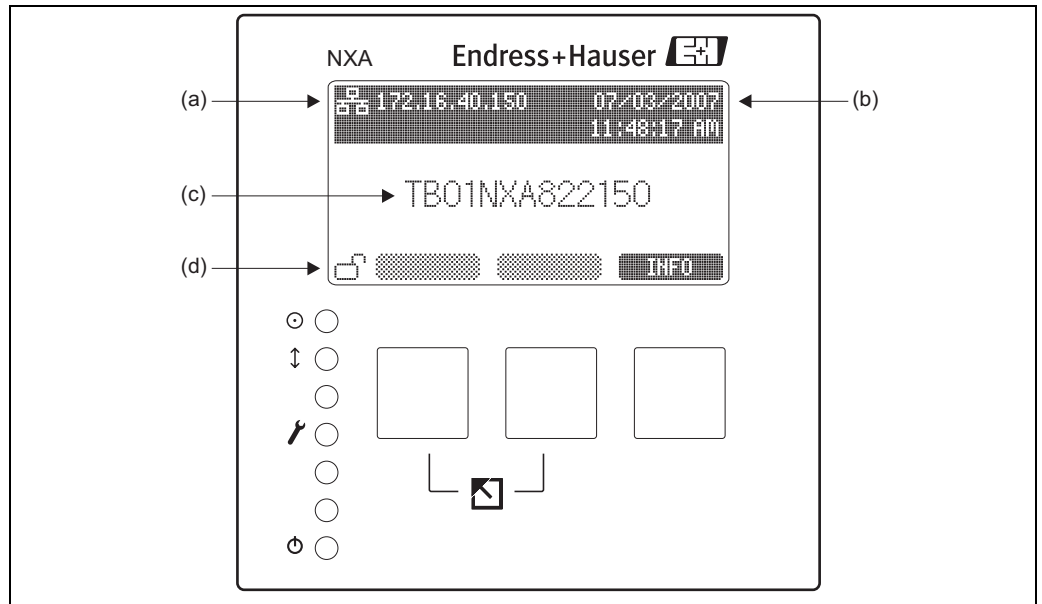

(a): IP address; **(b):** date and time; **(c):** instrument tag; **(d):** W&M switch status

L00-NXA822xx-07-00-00-yy-001

LEDs

Symbol	Color	Meaning
⊙	Green/Red	Green = Power On Red = Indicates a Fault when lit or Maintenance required when flashing
↕	Yellow	NXA Communication Flashes when the NXA822 Host Link receives a new set of tank data from a connected NXA820 Tank Scanner, through the LAN interface.
🔧	Yellow	Service Indicates a Service operation is currently active (e.g. during HART tunnelling)
⊙	Yellow	Stand-by Indicates the box is a redundant secondary unit, and is ready to take over if the primary unit fails.

Certificates and approvals

NMi

W&M approval according to OIML R 85 (in preparation)

PTB

Innerstaatliche Bauartzulassung (in preparation)

**Ordering information
NXA822**

010	Approval		
	A	Non-hazardous area	
020	Communication; Output		
	1	MODBUS serial, / TCP/IP slave interface	
	9	Special version, to be specified	
030	Power Supply		
	1	90-250 VAC 50/60Hz	
	2	10.5-32 V DC (in preparation)	
	9	Special version, to be specified	
060	Local Operation		
	1	status display	
	9	Special version, to be specified	
070	Operating language		
	A	English	
	Y	Special version, to be specified	
080	Housing		
	1	DIN rail mounting PBT, IP20	
	9	Special version, to be specified	
090	Redundancy		
	1	w/o	
	2	activated (in preparation)	
	9	Special version, to be specified	
100	Custody Transfer Approval		
	0	not selected	
	1	NMI + PTB type (in preparation)	
	9	Special version, to be specified	
110	Additional Option		
	A	Basic version	
	Y	Special version, to be specified	
NXA822 -		complete product designation	

Human interface

Operating concept Tankvision is operated by a standard web browser (e.g. Microsoft Internet Explorer). The Tankvision components contain predefined operating pages. If required, they can be adjusted by the user.

Languages The operating pages are available in the following languages:

- English
- other languages in preparation

System requirements of user PC

Hardware

CPU	min. 1 GHz, P4
RAM	512 MB
Screen resolution	min. 1024x768; recommended 1280x1024

Software

Operating System	Microsoft Windows 2000 / XP
Web Browser	Microsoft Internet Explorer 6
Java Runtime Environment	1.5.0-upt.07

Network

Network switches **must** always be used to interconnect Tankvision components (Network hubs must **never** be used).

Only use screened Category 5 (or higher) cables.



Caution!

The legal EMC requirements are fulfilled **only** when screened LAN cable is used and the cable screen is properly terminated to screened RJ45 connectors.



Caution!

Most commercial and IT infrastructure networking switches (and components) are not designed to be used within harsh environments (e.g. temperatures below +5°C, dusty or with high levels of EMC or electrical noise), it is therefore recommended that **only** networking components specifically designed for industrial control purposes be used within the control room (or control cabinet) environment as part of the Tankvision system.

Examples of operating pages Tank group

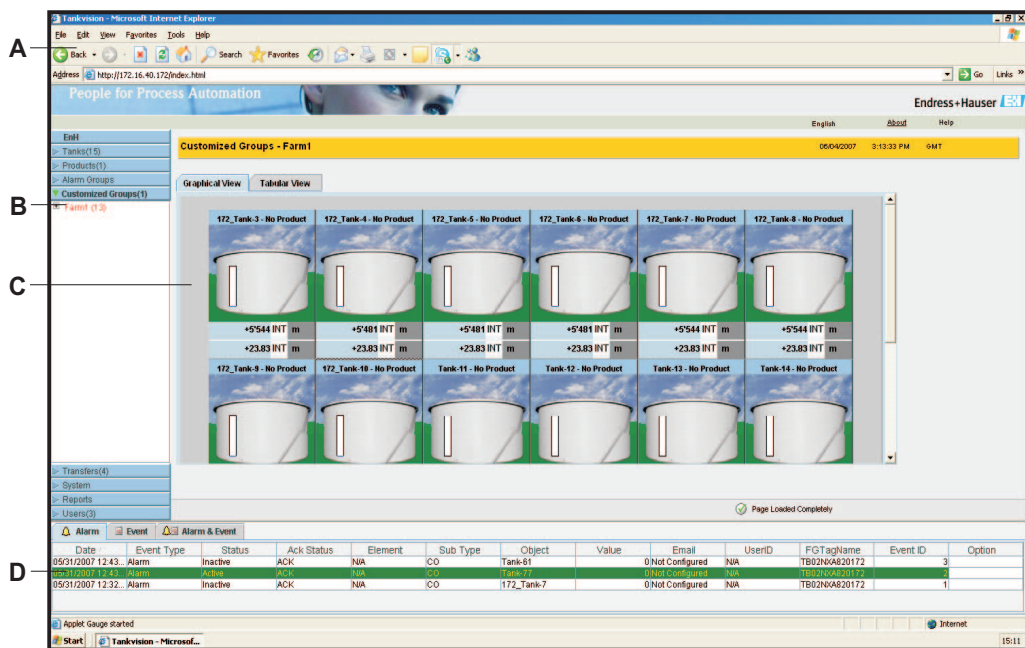

A: Internet Explorer menu and symbol bar; B: Navigation tree; C: Main window; D: Alarms and events viewer

Single tank

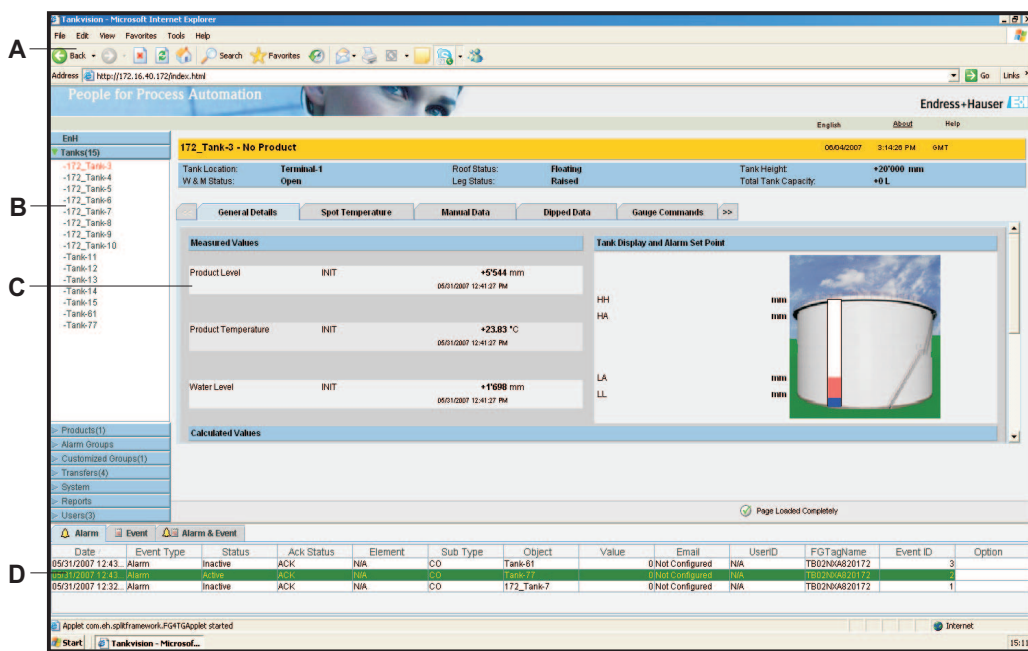

A: Internet Explorer menu and symbol bar; B: Navigation tree; C: Main window; D: Alarms and events viewer

Alarm Popup Agent

Date	Status	FGTagName	Element	Sub Type	Object	Value	Units	Event ID
06/25/2007 03:31:55 PM	Active	REV5-MODBUS	Product Level	HA	MODBUS_1	+17.500	m	60
06/25/2007 03:34:38 PM	Inactive	REV5-MODBUS	Product Level	LL	MODBUS_1	+0.000	m	63
06/25/2007 03:34:08 PM	Inactive	REV5-MODBUS	Product Level	LA	MODBUS_1	+1.000	m	62
06/25/2007 03:33:25 PM	Inactive	REV5-MODBUS	Product Level	HH	MODBUS_1	+18.100	m	61

Tank Name	MODBUS_1
Alarm Id	60
Alarm Type	HA
Alarm Status	Active
Parameter	Product Level
Value	+17.500
Timestamp	06/25/2007 03:31:55 PM

L00-NXA82xxx-20-00-00-en-005

Supplementary documentation

Operating Instructions**BA340F**

Operating Instructions for NXA820, NXA821 and NXA822
Describes installation, electrical connection and first setup.

Description of Instrument Functions**BA239F**

Description of Instrument Functions for NXA820, NXA821 and NXA822
Contains a detailed description of all instrument functions.

Trademarks

MODBUS

MODBUS is a registered trademark of the MODBUS-IDA, Hopkinton, MA, USA

Windows

Windows is a registered trademark of the Microsoft Corporation

Java

Java is a registered trademark of Sun Microsystems, Inc.

Instruments International

Endress+Hauser
Instruments International AG
Kaegenstrasse 2
4153 Reinach
Switzerland

Tel. +41 61 715 81 00
Fax +41 61 715 25 00
www.endress.com
info@ii.endress.com

Endress+Hauser 
People for Process Automation