

Operating Instructions

Proservo NMS80

Tank Gauging

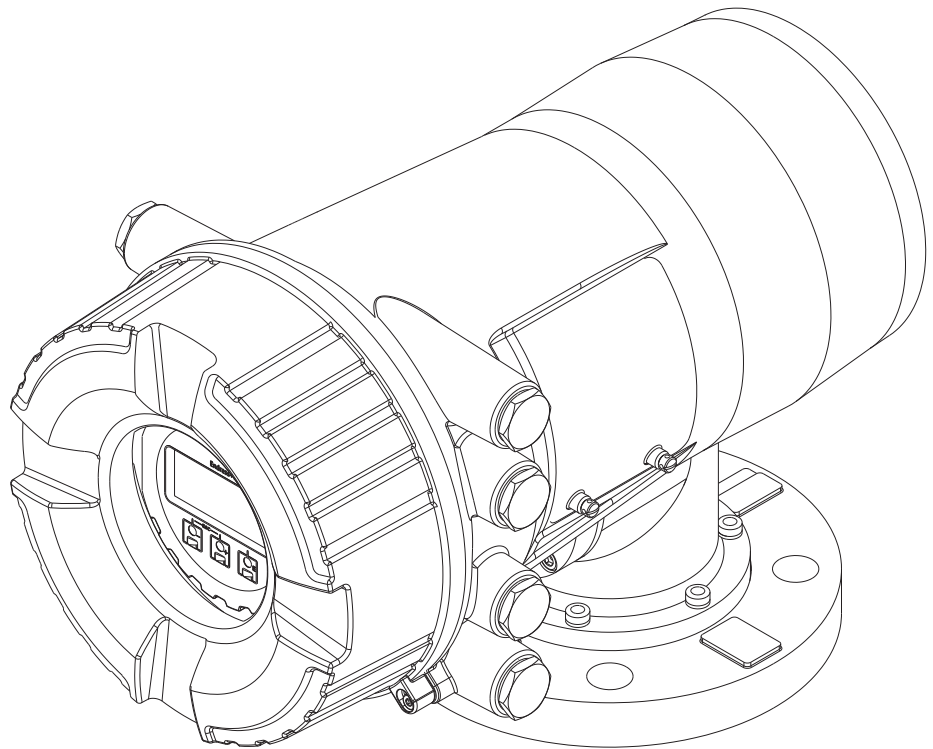

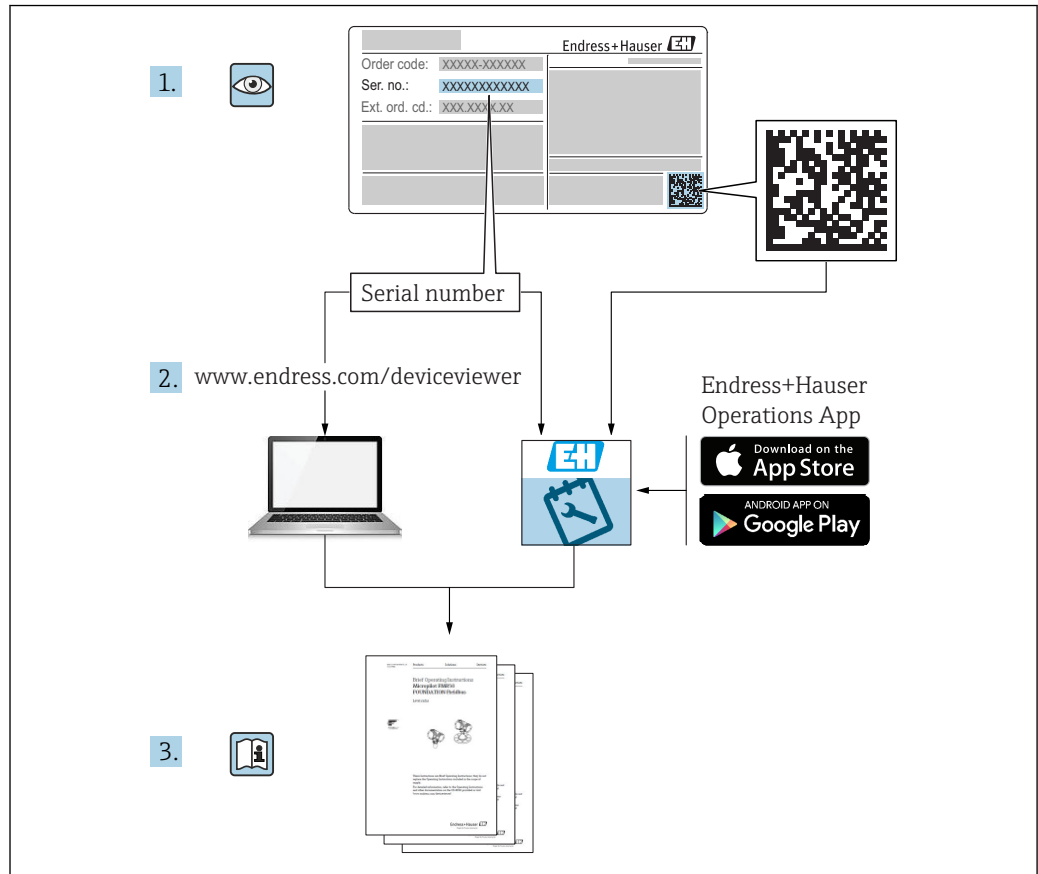

A0023555

Table of contents

1	About this document	4	9	Commissioning	84
1.1	Document function	4	9.1	Terms related to tank measurement	84
1.2	Symbols	4	9.2	Initial settings	85
1.3	Documentation	7	9.3	Calibration	87
1.4	Registered trademarks	9	9.4	Configuring the measuring device	95
2	Basic safety instructions	10	9.5	Configuring the tank gauging application ...	107
2.1	Requirements for the personnel	10	9.6	Advanced settings	129
2.2	Designated use	10	9.7	Simulation	129
2.3	Workplace safety	11	9.8	Protecting settings from unauthorized access	129
2.4	Operational safety	11	10	Operation	130
2.5	Product safety	11	10.1	Reading off the device locking status	130
3	Product description	12	10.2	Reading off measured values	130
3.1	Product design	12	10.3	Gauge commands	131
4	Incoming acceptance and product identification	13	11	Diagnostics and troubleshooting ..	137
4.1	Incoming acceptance	13	11.1	General trouble shooting	137
4.2	Product identification	13	11.2	Diagnostic information on local display	138
4.3	Storage and transport	15	11.3	Diagnostic information in FieldCare	141
5	Installation	17	11.4	Overview of the diagnostic messages	143
5.1	Requirements	17	11.5	Diagnostic list	149
5.2	Mounting of the device	35	11.6	Reset measuring device	150
5.3	Post-installation check	45	11.7	Device information	150
6	Electrical connection	46	11.8	Firmware history	150
6.1	Terminal assignment	46	12	Maintenance	151
6.2	Connecting requirements	61	12.1	Maintenance tasks	151
6.3	Ensuring the degree of protection	62	12.2	Endress+Hauser services	151
6.4	Post-connection check	62	13	Repair	152
7	Operability	63	13.1	General information on repairs	152
7.1	Overview of the operation options	63	13.2	Spare parts	152
7.2	Structure and function of the operating menu	64	13.3	Endress+Hauser services	153
7.3	Access to the operating menu via the local or remote display and operating module.	66	13.4	Return	153
7.4	Access to the operating menu via the service interface and FieldCare	79	13.5	Disposal	153
7.5	Access to the operating menu via Tankvision Tank Scanner NXA820 and FieldCare	80	14	Accessories	154
8	System integration	83	14.1	Device-specific accessories	154
8.1	Overview of the Device Description files (DTM)	83	14.2	Communication-specific accessories	157
			14.3	Service-specific accessories	157
			14.4	System components	157
			15	Operating menu	158
			15.1	Overview of the operating menu	158
			15.2	"Operation" menu	169
			15.3	"Setup" menu	185
			15.4	"Diagnostics" menu	316
			Index	328	





1 About this document

1.1 Document function







These Operating Instructions contain all the information that is required in various phases of the life cycle of the device: from product identification, incoming acceptance and storage, to mounting, connection, operation and commissioning through to troubleshooting, maintenance and disposal.

1.2 Symbols





1.2.1 Safety symbols

Symbol	Meaning
	DANGER! This symbol alerts you to a dangerous situation. Failure to avoid this situation will result in serious or fatal injury.
	WARNING! This symbol alerts you to a dangerous situation. Failure to avoid this situation can result in serious or fatal injury.
	CAUTION! This symbol alerts you to a dangerous situation. Failure to avoid this situation can result in minor or medium injury.
	NOTE! This symbol contains information on procedures and other facts which do not result in personal injury.





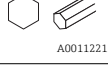







1.2.2 Electrical symbols

Symbol	Meaning
	Direct current
	Alternating current
	Direct current and alternating current
	Ground connection A grounded terminal which, as far as the operator is concerned, is grounded via a grounding system.
	Protective ground connection A terminal which must be connected to ground prior to establishing any other connections.
	Equipotential connection A connection that has to be connected to the plant grounding system: This may be a potential equalization line or a star grounding system depending on national or company codes of practice.

1.2.3 Tool symbols



Symbol	Meaning
 A0013442	Torx screwdriver
 A0011220	Flat blade screwdriver
 A0011219	Cross-head screwdriver
 A0011221	Allen key
 A0011222	Hexagon wrench

1.2.4 Symbols for certain types of information



Symbol	Meaning
	Permitted Procedures, processes or actions that are permitted.
	Preferred Procedures, processes or actions that are preferred.
	Forbidden Procedures, processes or actions that are forbidden.
	Tip Indicates additional information.
	Reference to documentation
	Reference to page
	Reference to graphic
	Notice or individual step to be observed
	Series of steps
	Result of a step
	Help in the event of a problem
	Visual inspection

1.2.5 Symbols in graphics

Symbol	Meaning
1, 2, 3 ...	Item numbers
	Series of steps
A, B, C, ...	Views
A-A, B-B, C-C, ...	Sections

Symbol	Meaning
	Hazardous area Indicates a hazardous area.
	Safe area (non-hazardous area) Indicates the non-hazardous area.

1.2.6 Symbols at the device

Symbol	Meaning
	Safety instructions Observe the safety instructions contained in the associated Operating Instructions.
	Temperature resistance of the connection cables Specifies the minimum value of the temperature resistance of the connection cables.

1.3 Documentation

 For an overview of the scope of the associated Technical Documentation, refer to the following:

- The *W@M Device Viewer* : Enter the serial number from the nameplate (www.endress.com/deviceviewer)
- The *Endress+Hauser Operations App*: Enter the serial number from the nameplate or scan the 2-D matrix code (QR code) on the nameplate.

1.3.1 Technical Information (TI)

The Technical Information contains all the technical data on the device and provides an overview of the accessories and other products that can be ordered for the device.

Device	Technical Information
Proservo NMS80	TI01248G

1.3.2 Brief Operating Instructions (KA)

The Brief Operating Instructions contain all the essential information from incoming acceptance to initial commissioning.

Device	Brief Operating Instructions
Proservo NMS80	KA01200G

1.3.3 Operating Instructions (BA)

The Operating Instructions contain all the information that is required in various phases of the life cycle of the device: from product identification, incoming acceptance and storage, to mounting, connection, operation and commissioning through to troubleshooting, maintenance and disposal.

It also contains a detailed explanation of each individual parameter in the operating menu (except the **Expert** menu). The description is aimed at those who work with the device over the entire life cycle and perform specific configurations.

Device	Operating Instructions
Proservo NMS80	BA01456G

1.3.4 Description of Device Parameters (GP)

The Description of Device Parameters provides a detailed explanation of each individual parameter in the 2nd part of the operating menu: the **Expert** menu. It contains all the device parameters and allows direct access to the parameters by entering a specific code. The description is aimed at those who work with the device over the entire life cycle and perform specific configurations.

Device	Description of Device Parameters
Proservo NMS80	GP01074G

1.3.5 Safety instructions (XA)

Ordering feature 010 "Approval"	Meaning	XA
BC	ATEX II 1/2G Ex db [ia Ga] IIC T6 Ga/Gb	XA01495G
FD	FM C/US XP-AIS CLI Div.1 Gr.BCD T6 AEx db [ia Ga] IIC T6 Ga/Gb	XA01496G
GC	EAC Ga/Gb Ex db [ia Ga] IIC T6...T1 X	XA01711G
IC	IEC Ex db [ia Ga] IIC T6 Ga/Gb	XA01495G
KC ¹⁾	KC Ex d[ia] IIC T6 Ga/Gb	XA01495G
MC	INMETRO Ex d[ia] IIC T6 Ga/Gb	XA01705G
NC	NEPSI Ex d[ia] IIC T6 Ga/Gb	XA01704G
TC	TIIS Ex d[ia] IIC T4 Ga/Gb	XA01600G

1) KC approval is covered with IEC Ex approval.

1.4 Registered trademarks

FieldCare®

Registered trademark of the Endress+Hauser Process Solutions AG, Reinach, Switzerland

MODBUS®

Registered trademark of the MODBUS-IDA, Hopkinton, MA, USA

2 Basic safety instructions

2.1 Requirements for the personnel

The personnel for installation, commissioning, diagnostics and maintenance must fulfill the following requirements:

- ▶ Trained, qualified specialists must have a relevant qualification for this specific function and task.
- ▶ Are authorized by the plant owner/operator.
- ▶ Are familiar with federal/national regulations.
- ▶ Before starting work, read and understand the instructions in the manual and supplementary documentation as well as the certificates (depending on the application).
- ▶ Follow instructions and comply with basic conditions.

The operating personnel must fulfill the following requirements:

- ▶ Are instructed and authorized according to the requirements of the task by the facility's owner-operator.
- ▶ Follow the instructions in this manual.

2.2 Designated use

Application and measured materials

Depending on the version ordered, the measuring device can also measure potentially explosive, flammable, poisonous and oxidizing media.

Measuring devices for use in hazardous areas, in hygienic applications or in applications where there is an increased risk due to process pressure, are labeled accordingly on the nameplate.

To ensure that the measuring device remains in proper condition for the operation time:

- ▶ Only use the measuring device in full compliance with the data on the nameplate and the general conditions listed in the Operating Instructions and supplementary documentation.
- ▶ Check the nameplate to verify if the device ordered can be put to its intended use in the approval-related area (e.g. explosion protection, pressure vessel safety).
- ▶ Use the measuring device only for media against which the process-wetted materials are adequately resistant.
- ▶ If the measuring device is not operated at atmospheric temperature, compliance with the relevant basic conditions specified in the associated device documentation is absolutely essential.
- ▶ Protect the measuring device permanently against corrosion from environmental influences.
- ▶ Observe the limit values in the "Technical Information".

The manufacturer is not liable for damage caused by improper or non-designated use.

Residual risk

During operation the sensor may assume a temperature near the temperature of the measured material.

Danger of burns due to heated surfaces!

- ▶ For high process temperatures: Install protection against contact in order to prevent burns.

2.3 Workplace safety

For work on and with the device:

- ▶ Wear the required personal protective equipment according to federal/national regulations.

2.4 Operational safety

Risk of injury.

- ▶ Operate the device in proper technical condition and fail-safe condition only.
- ▶ The operator is responsible for interference-free operation of the device.

Conversions to the device

Unauthorized modifications to the device are not permitted and can lead to unforeseeable dangers.

- ▶ If, despite this, modifications are required, consult with the manufacturer.

Repair

To ensure continued operational safety and reliability,

- ▶ Carry out repairs on the device only if they are expressly permitted.
- ▶ Observe federal/national regulations pertaining to repair of an electrical device.
- ▶ Use original spare parts and accessories from the manufacturer only.

Hazardous area

To eliminate a danger for persons or for the facility when the device is used in the hazardous area (e.g. explosion protection, pressure vessel safety):

- ▶ Based on the nameplate, check whether the ordered device is permitted for the intended use in the hazardous area.
- ▶ Observe the specifications in the separate supplementary documentation that is an integral part of these Instructions.

2.5 Product safety

This measuring device is designed in accordance with good engineering practice to meet state-of-the-art safety requirements, has been tested, and left the factory in a condition in which it is safe to operate. It meets general safety standards and legal requirements.

2.5.1 CE mark

The measuring system meets the legal requirements of the applicable EC guidelines. These are listed in the corresponding EC Declaration of Conformity together with the standards applied.

Endress+Hauser confirms successful testing of the device by affixing to it the CE mark.

3 Product description

3.1 Product design

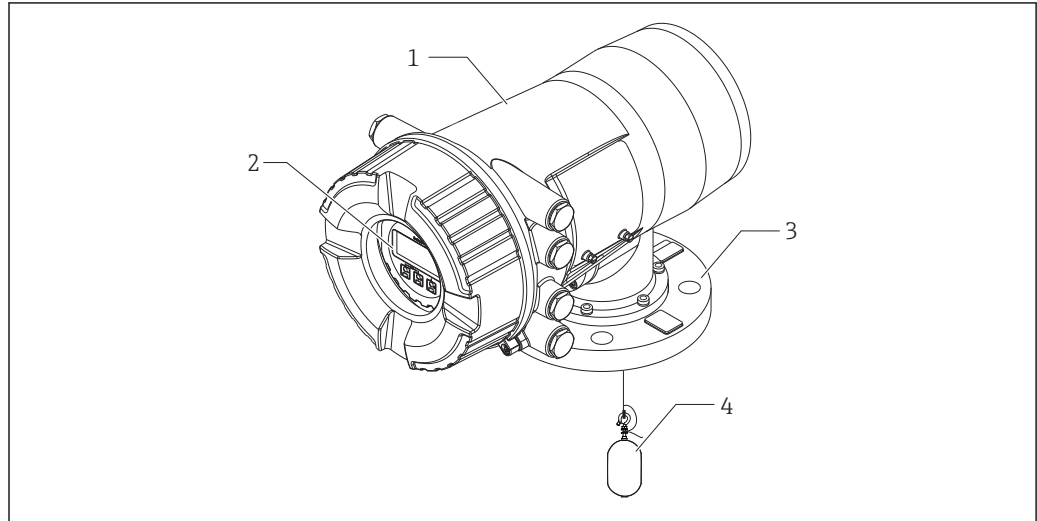

A0030104

1 Design of Proservo NMS80

- 1 Housing
- 2 Display and operating module (can be operated without opening the cover)
- 3 Process connection (Flange)
- 4 Displacer

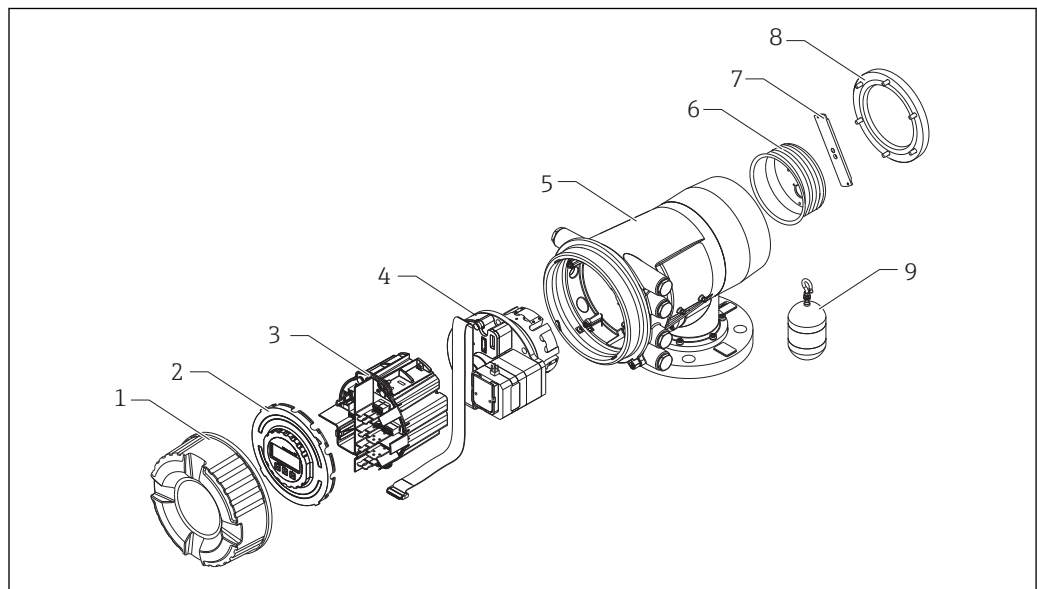

A0030105

2 Configuration of NMS80

- 1 Front cover
- 2 Display
- 3 Modules
- 4 Sensor unit
- 5 Housing
- 6 Wire drum
- 7 Bracket
- 8 Housing cover
- 9 Displacer

4 Incoming acceptance and product identification

4.1 Incoming acceptance

Upon receipt of the goods check the following:

- Are the order codes on the delivery note and the product sticker identical?
- Are the goods undamaged?
- Do the nameplate data match the ordering information on the delivery note?
- If required (see nameplate): Are the Safety Instructions (XA) enclosed?



If one of these conditions is not satisfied, contact your Endress+Hauser Sales Center.

4.2 Product identification

The following options are available for identification of the measuring device:

- Nameplate specifications
- Extended order code with breakdown of the device features on the delivery note
- Enter serial numbers from nameplates in *W@M Device Viewer* (www.endress.com/deviceviewer): All information about the measuring device is displayed.
- Enter the serial number from the nameplates into the *Endress+Hauser Operations App* or scan the 2-D matrix code (QR code) on the nameplate with the *Endress+Hauser Operations App*: all the information for the measuring device is displayed.

For an overview of the scope of the associated Technical Documentation, refer to the following:

- The *W@M Device Viewer*: Enter the serial number from the nameplate (www.endress.com/deviceviewer)
- The *Endress+Hauser Operations App*: Enter the serial number from the nameplate or scan the 2-D matrix code (QR code) on the nameplate.

4.2.1 Nameplate

The nameplate layout includes the following fields:

- 1: Manufacturer address
- 2: Device name
- 3: Order code
- 4: Serial number
- 5: Extended order code
- 6: Supply voltage
- 7: Maximum process pressure
- 8: Maximum process temperature
- 9: Permitted ambient temperature (T_a)
- 10: Temperature resistance of cable
- 11: Thread for cable entry
- 12: Material in contact with process
- 13: Device ID
- 14: Firmware version
- 15: Device revision
- 16: Metrology certification numbers
- 17: Customized parametrization data
- 18: Ambient temperature range
- 19: CE mark / C-tick mark
- 20: Additional information on the device version
- 21: Ingress protection
- 22: Certificate symbol
- 23: Data concerning the Ex approval
- 24: General certificate of approval
- 25: Associated Safety Instructions (XA)
- 26: Manufacturing date
- 27: RoHS mark
- 28: QR code for the Endress+Hauser Operations App

A0027791

3 Nameplate

- 1 *Manufacturer address*
- 2 *Device name*
- 3 *Order code*
- 4 *Serial number*
- 5 *Extended order code*
- 6 *Supply voltage*
- 7 *Maximum process pressure*
- 8 *Maximum process temperature*
- 9 *Permitted ambient temperature (T_a)*
- 10 *Temperature resistance of cable*
- 11 *Thread for cable entry*
- 12 *Material in contact with process*
- 13 *Device ID*
- 14 *Firmware version*
- 15 *Device revision*
- 16 *Metrology certification numbers*
- 17 *Customized parametrization data*
- 18 *Ambient temperature range*
- 19 *CE mark / C-tick mark*
- 20 *Additional information on the device version*
- 21 *Ingress protection*
- 22 *Certificate symbol*
- 23 *Data concerning the Ex approval*
- 24 *General certificate of approval*
- 25 *Associated Safety Instructions (XA)*
- 26 *Manufacturing date*
- 27 *RoHS mark*
- 28 *QR code for the Endress+Hauser Operations App*

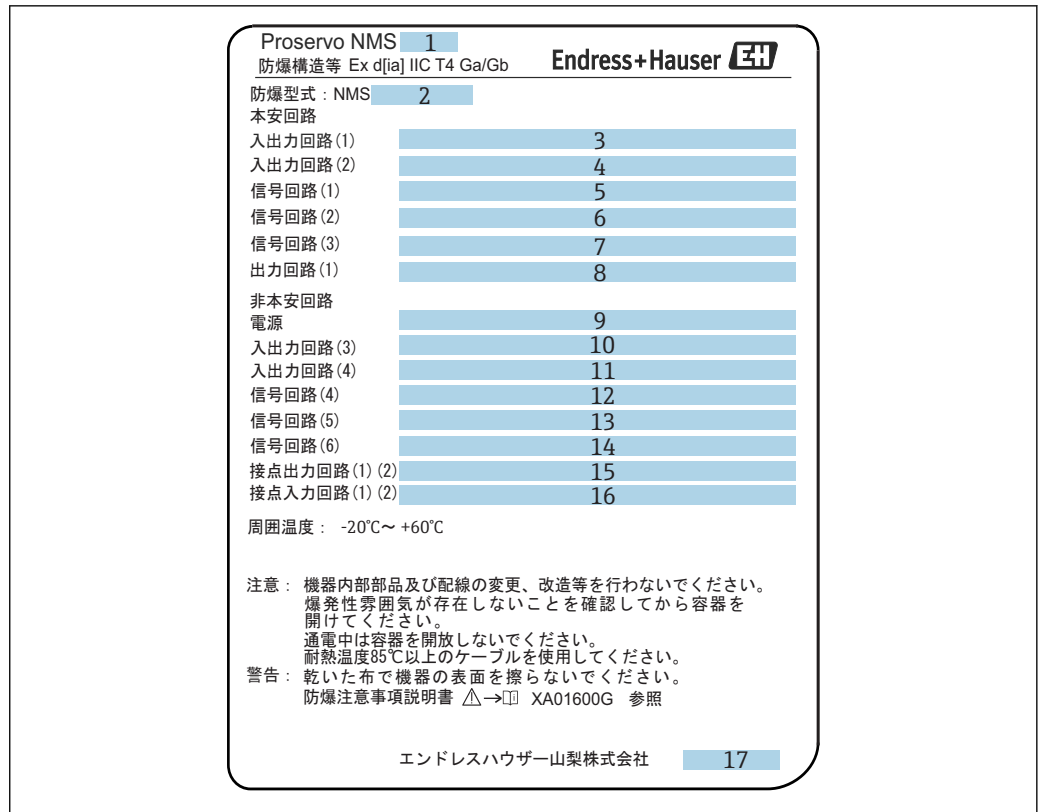

A0032435

4 Nameplate Proservo NMS8x for TIIS

- 1 Product type
- 2 Ex type
- 3 Input/Output circuit (1)
- 4 Input/Output circuit (2)
- 5 Signal circuit (1)
- 6 Signal circuit (2)
- 7 Signal circuit (3)
- 8 Output circuit (1)
- 9 Power supply
- 10 Input/output circuit (3)
- 11 Input/output circuit (4)
- 12 Signal circuit (4)
- 13 Signal circuit (5)
- 14 Signal circuit (6)
- 15 Contact output circuit (1) (2)
- 16 Contact input circuit (1) (2)
- 17 Drawing number

4.2.2 Manufacturer address

Endress+Hauser SE+Co. KG
 Hauptstraße 1
 79689 Maulburg, Germany

Address of the manufacturing plant: See nameplate.

4.3 Storage and transport

4.3.1 Storage conditions

- Storage temperature: -50 to +80 °C (-58 to +176 °F)
- Store the device in its original packaging.

4.3.2 Transport

NOTICE**Risk of injury**

- ▶ Transport the measuring device to the measuring point in its original packaging.
- ▶ Take into account the mass center of the device in order to avoid unintended tilting.
- ▶ Comply with the safety instructions, transport conditions for devices over 18kg (39.6lbs) (IEC61010).

5 Installation

5.1 Requirements

5.1.1 Type of tanks

Depending on the type of tank and application, different installation procedures are recommended for NMS8x.

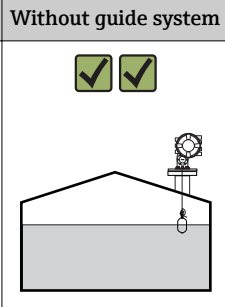
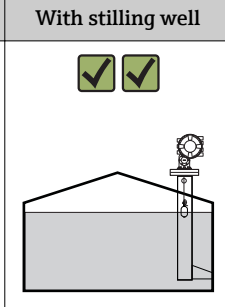
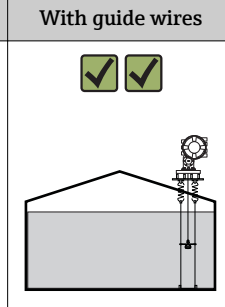
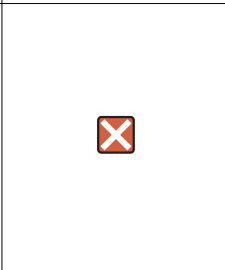
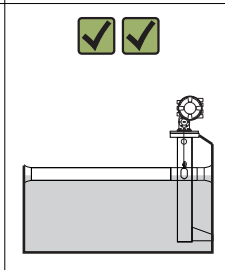
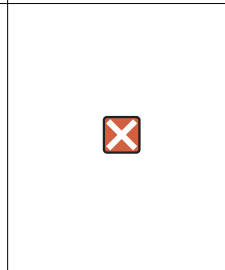
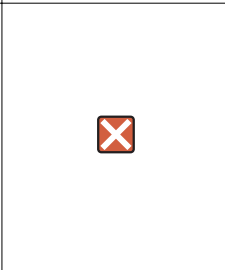
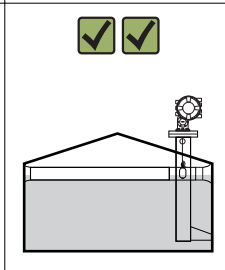
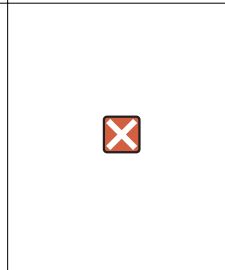
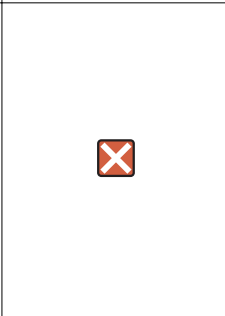
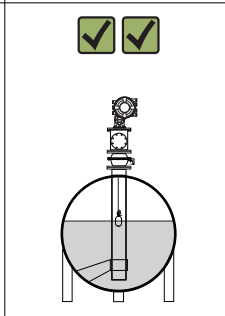
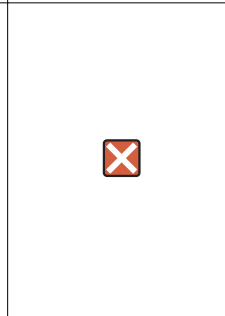
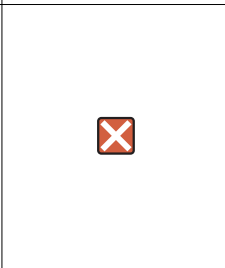
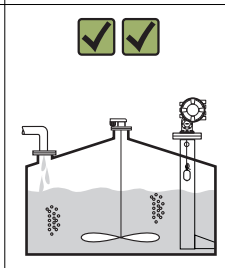
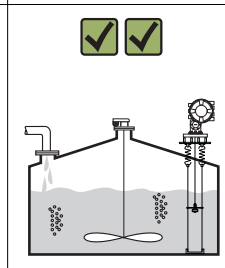
Type of tanks	Without guide system	With stilling well	With guide wires
Fixed roof tank			
Floating roof tank			
Covered floating roof tank			
Pressurized or bullet tank			
Tank with agitator or heavy turbulence			

 A stilling well is required in a floating roof tank and a covered floating roof tank.

- Guide wires cannot be installed in a floating roof tank. When the measuring wire is exposed to free space, it may break due to an external shock.
- Installing guide wires is not allowed in pressurized tanks because the wires would prevent closing the valve for replacing the wire, wire drum, or displacer. NMS8x installation position is important for applications without the guide wire system in order to prevent the measuring wire from being broken (refer to Operating Instructions for details).

Typical tank installation

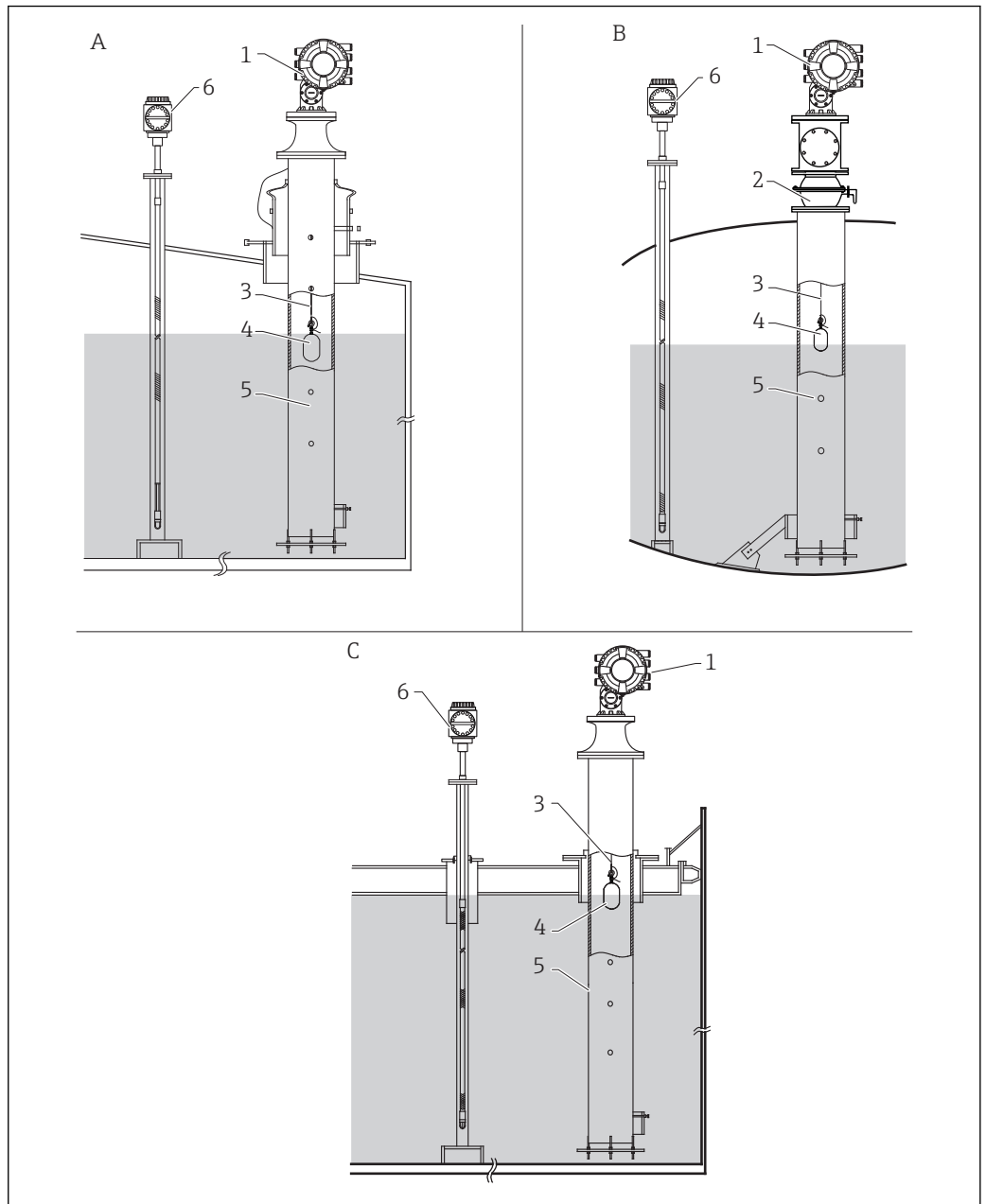

- 5 Typical tank installation
- A Fixed roof tank
 - B High pressure tank
 - C Floating roof tank with stilling well
 - 1 NMS8x
 - 2 Ball valve
 - 3 Measuring wire
 - 4 Displacer
 - 5 Stilling well
 - 6 Prothermo NMT53x

A0026725

5.1.2 Displacer selection guide

A wide variety of displacers are available to suit different application. Proper displacer selection ensures optimal performance and longevity. The following guidelines will assist you in selecting the most suitable displacer for your application.

Displacer types

The following NMS8x displacers are available.

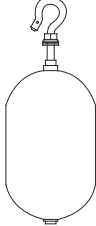
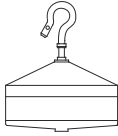
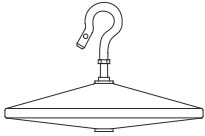
30 mm (1.18 in)	50 mm (1.97 in)	70 mm (2.76 in)	110 mm (4.33 in)
316L/PTFE	316L/Alloy C/PTFE	316L	316L
 <small>A0026729</small>	 <small>A0026730</small>	 <small>A0026731</small>	 <small>A0026732</small>

Displacer dimensions

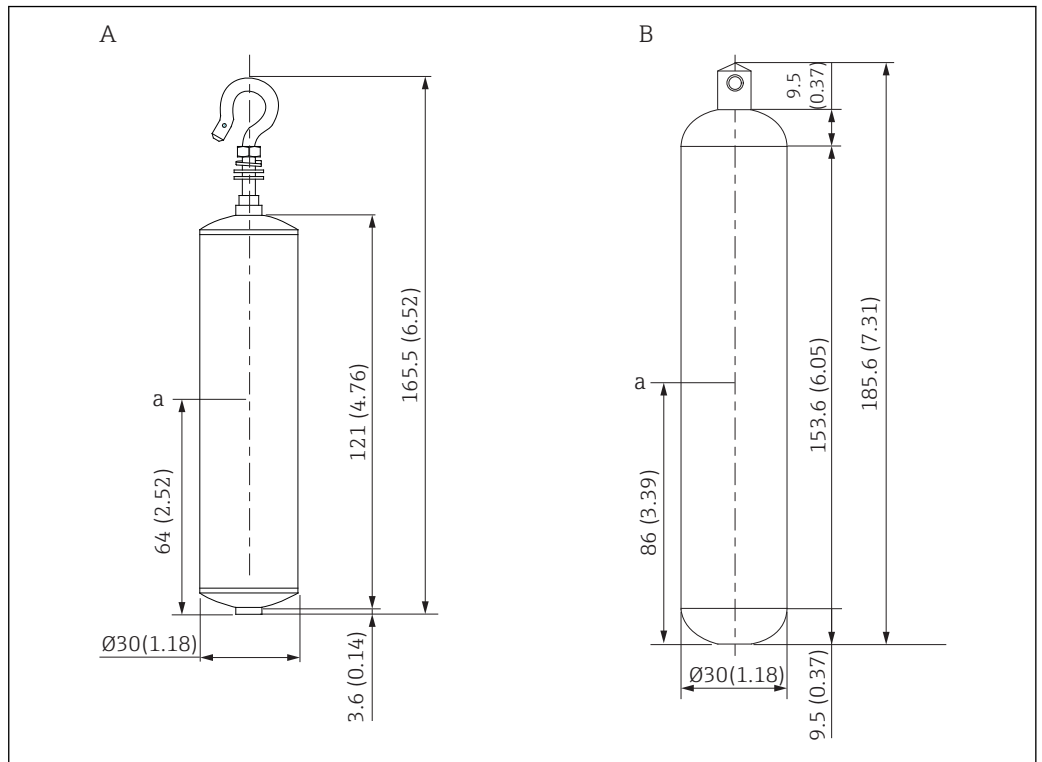

A0029579

- A Ø30 mm (1.18 in) 316L cylindrical displacer
- B Ø30 mm (1.18 in) PTFE cylindrical displacer
- a Immersion point

Item	Ø30 mm (1.18 in) 316L cylindrical displacer	Ø30 mm (1.18 in) PTFE cylindrical displacer
Weight (g)	261	250
Volume (ml)	84.3	118
Balance volume (ml)	41.7	59

i The weight, volume, and balance volume are individually determined by each displacer and also might vary depending on the values stated above.

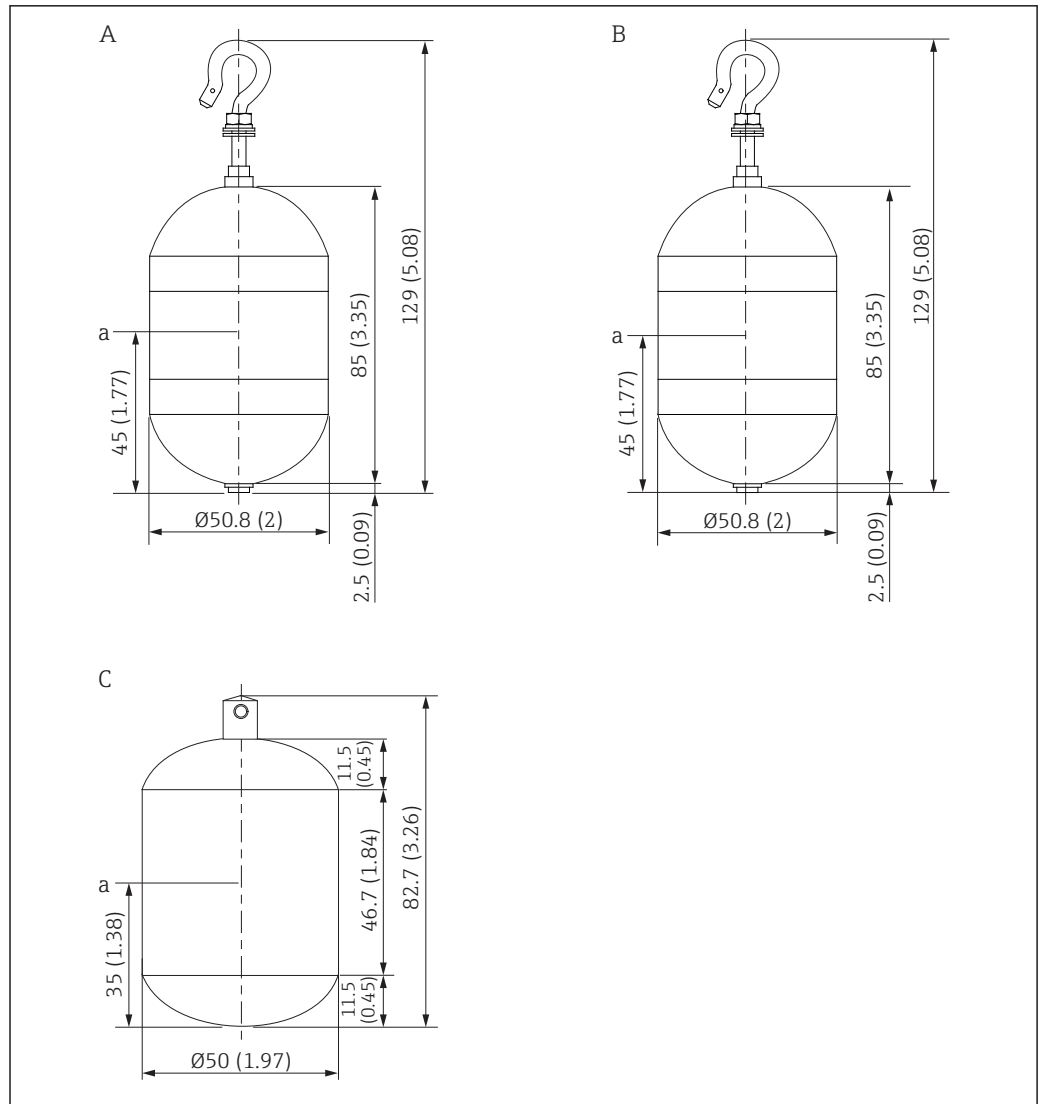

A0029580

- A Ø50 mm (1.97 in) 316L cylindrical displacer
- B Ø50 mm (1.97 in) AlloyC cylindrical displacer
- C Ø50 mm (1.97 in) PTFE cylindrical displacer
- a Immersion point

Item	Ø50 mm (1.97 in) 316L cylindrical displacer	Ø50 mm (1.97 in) AlloyC cylindrical displacer	Ø50 mm (1.97 in) PTFE cylindrical displacer
Weight (g)	253	253	250
Volume (ml)	143	143	118
Balance volume (ml)	70.7	70.7	59

i The weight, volume, and balance volume are individually determined by each displacer and also might vary depending on the values stated above.

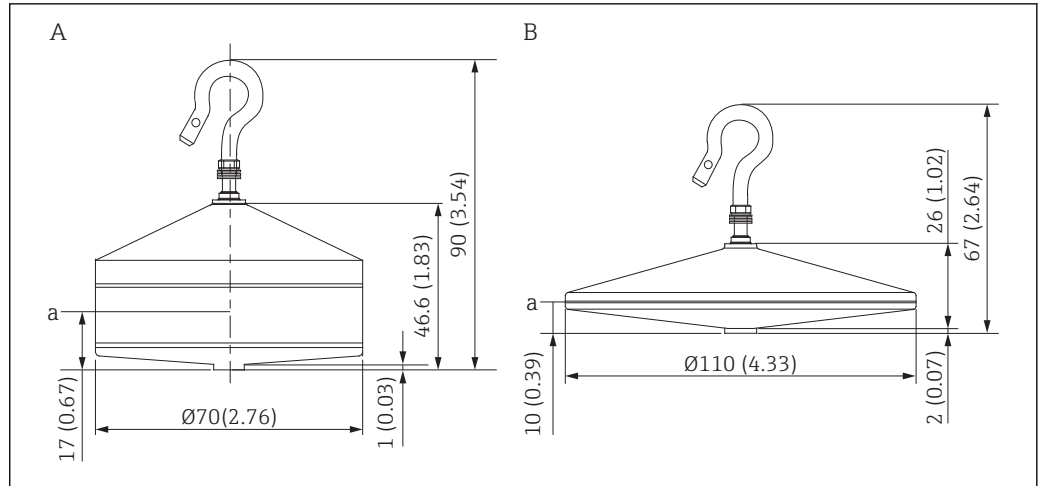

A0029582

- A $\varnothing 70$ mm (2.76 in) 316L conical displacer
- B $\varnothing 110$ mm (4.33 in) 316L conical displacer
- a Immersion point

Item	$\varnothing 70$ mm (2.76 in) 316L conical displacer	$\varnothing 110$ mm (4.33 in) 316L conical displacer
Weight (g)	245	223
Volume (ml)	124	108
Balance volume (ml)	52.8	36.3

i The weight, volume, and balance volume are individually determined by each displacer and also might vary depending on the values stated above.

Recommended displacer by application

Application	Product level	Interface level	Density
Viscous liquid	50 mm (1.97 in) PTFE	Not Recommended	Not Recommended
Crude oil	50 mm (1.97 in) 316L 50 mm (1.97 in) PTFE	50 mm (1.97 in) 316L 50 mm (1.97 in) PTFE	50 mm (1.97 in) 316L 50 mm (1.97 in) PTFE
Black oil	50 mm (1.97 in) 316L	50 mm (1.97 in) 316L	50 mm (1.97 in) 316L
White oil	70 mm (2.76 in) 316L	70 mm (2.76 in) 316L	70 mm (2.76 in) 316L
Liquefied gas, LPG/LNG	70 mm (2.76 in) 316L	70 mm (2.76 in) 316L	70 mm (2.76 in) 316L
Corrosive liquid	50 mm (1.97 in) Alloy C 50 mm (1.97 in) PTFE	50 mm (1.97 in) Alloy C 50 mm (1.97 in) PTFE	50 mm (1.97 in) Alloy C 50 mm (1.97 in) PTFE

5.1.3 Mounting without a guide system

NMS8x is mounted on a nozzle of the tank roof without a guide system. Sufficient clearance inside the nozzle is necessary to allow the displacer to move without hitting the inner walls (for details of D , →  25).

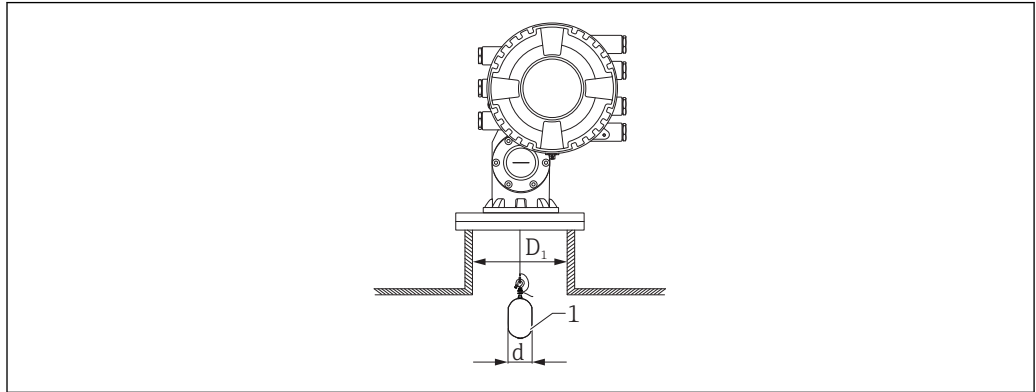

A0026734

 6 No guide system

D_1 Inner diameter of the tank nozzle

d Diameter of the displacer

1 Displacer

5.1.4 Mounting with a stilling well

The stilling well diameter that is required to protect the measuring wire without disturbing its operation varies depending on the tank height. The stilling well could either be of constant diameter, or narrower at its upper part and wider at its lower part. The following figure shows two examples of the latter case, namely a concentric stilling well and an asymmetric stilling well.

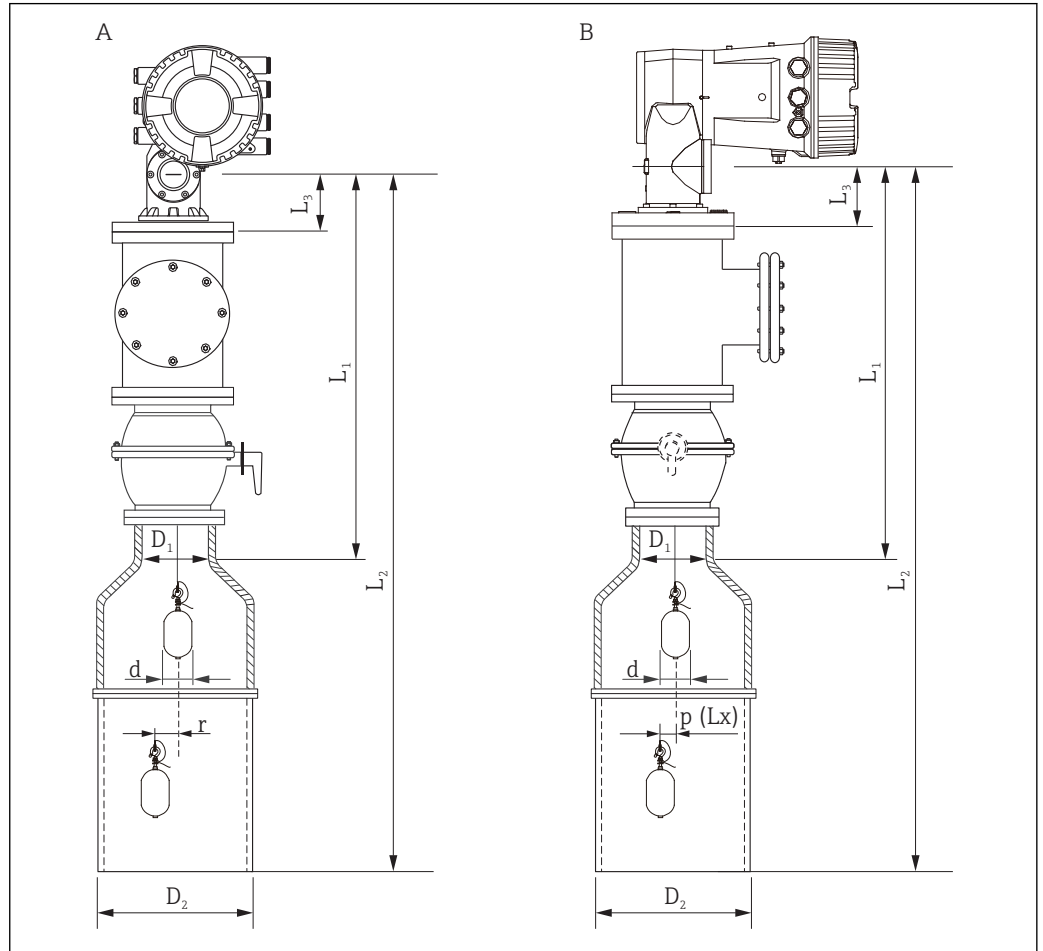

7 Mounting with concentric stilling well

- A Front view
- B Side view
- L_1 Length from the center of the calibration window to the upper part of the stilling well
- L_2 Length from the center of the calibration window to the bottom of the stilling well
- L_3 Length from the center of the calibration window to the bottom of the flange
- D_1 Diameter of upper part of stilling well
- D_2 Diameter of stilling well
- d Diameter of displacer
- p Longitudinal wire position from the center of the flange
- (Lx)
- r Radial direction offset

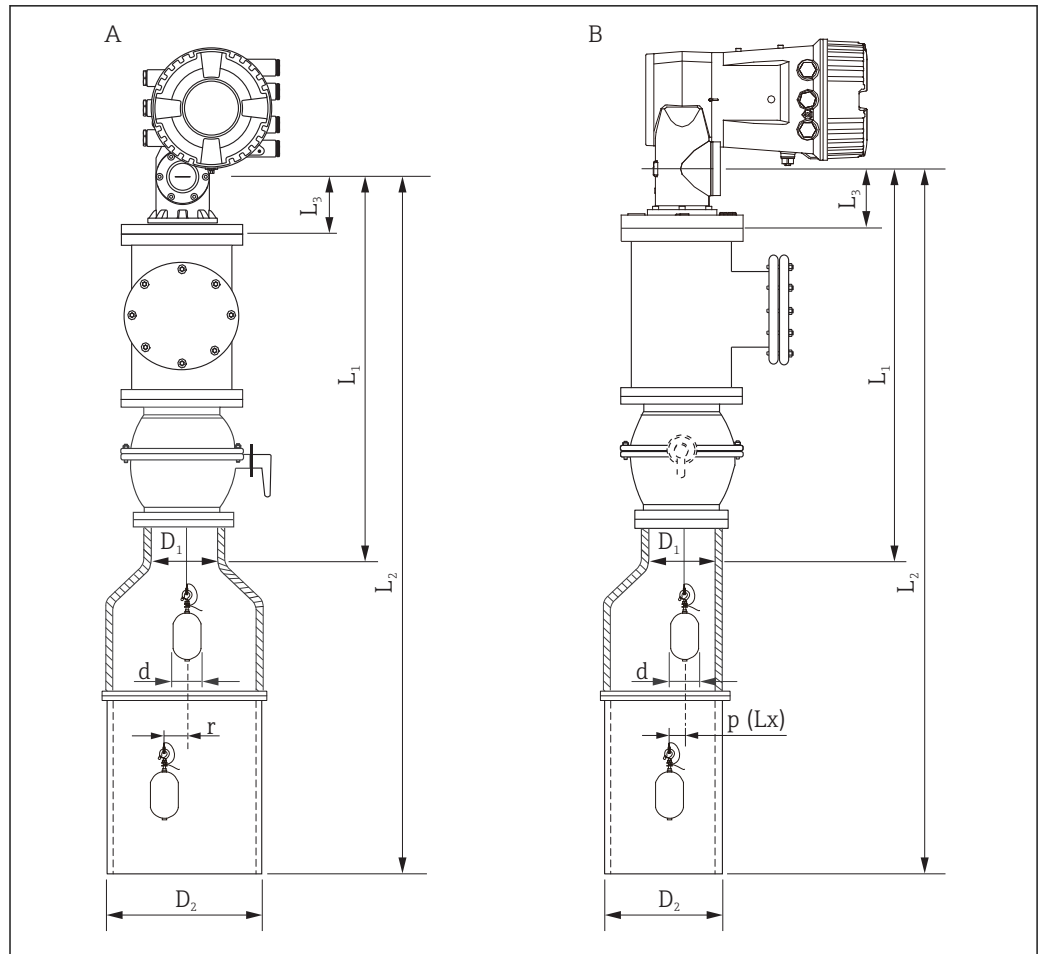

A0029576

8 Mounting with asymmetric stilling well

A Front view

B Side view

L_1 Length from the center of the calibration window to the upper part of the stilling well

L_2 Length from the center of the calibration window to the bottom of the stilling well

L_3 Length from the center of the calibration window to the bottom of the flange

D_1 Diameter of upper part of stilling well

D_2 Diameter of stilling well

d Diameter of displacer

p Longitudinal wire position from the center of the flange

(Lx)

r Radial direction offset

- i** L_3 : length from center of the calibration window to the bottom of the flange (77 mm (3.03 in) + flange thickness).
For JIS 10K 150A RF, the flange thickness is 22 mm (0.87 in).
- When using an asymmetric stilling well, take into account the lateral shift of the displacer and follow the NMS8x mounting direction as shown in the figure.
- To calculate the required stilling well diameters, the formula below should be used. The following tables contain the necessary parameters in order to calculate the dimensions of the stilling well. Be sure to have appropriate dimensions of the stilling well according to each dimension in the table.
- The radial direction offset (r) is required for only the 47 m (154.20 ft) and 55 m (180.45 ft) wire drum. For all other drums, the offset is 0 mm/in.

Feature: 110	Description (Measuring range; Wire; Diameter)	NMS80	NMS81	NMS83	r
G1	47 m (154.20 ft); 316L; 0.15 mm (0.00591 in)		<input checked="" type="checkbox"/>		6 mm (0.24 in)
H1	55 m (180.45 ft); 316L 0.15 mm (0.00591 in)		<input checked="" type="checkbox"/>		6 mm (0.24 in)

Feature: 120	Description (Displacer material; Type)	NMS80	NMS81	NMS83	d
1AA	316L; 30 mm (1.18 in) cylindrical	<input checked="" type="checkbox"/>	<input checked="" type="checkbox"/>		30 mm (1.18 in)
1AC	316L; 50 mm (1.97 in) cylindrical	<input checked="" type="checkbox"/>	<input checked="" type="checkbox"/>		50 mm (1.97 in)
1BE	316L; 70 mm (2.76 in) conical	<input checked="" type="checkbox"/>	<input checked="" type="checkbox"/>		70 mm (2.76 in)
1BJ	316L; 110 mm (4.33 in) conical	<input checked="" type="checkbox"/>	<input checked="" type="checkbox"/>		110 mm (4.33 in)
2AA	PTFE; 30 mm (1.18 in) cylindrical	<input checked="" type="checkbox"/>	<input checked="" type="checkbox"/>		30 mm (1.18 in)
2AC	PTFE; 50 mm (1.97 in) cylindrical	<input checked="" type="checkbox"/>	<input checked="" type="checkbox"/>		50 mm (1.97 in)
3AC	AlloyC276; 50 mm (1.97 in) cylindrical	<input checked="" type="checkbox"/>	<input checked="" type="checkbox"/>		50 mm (1.97 in)
4AC	316L polished; 50 mm (1.97 in) cylindrical			<input checked="" type="checkbox"/>	50 mm (1.97 in)
4AE	316L polished; 70 mm (2.76 in) conical			<input checked="" type="checkbox"/>	70 mm (2.76 in)
5AC	PTFE; 50 mm (1.97 in) cylindrical, hygienic white			<input checked="" type="checkbox"/>	50 mm (1.97 in)

Parameter	Description
d	Diameter of displacer
p(Lx)	Longitudinal wire position from the center of the flange The value can be determined by using following graph.
r	Radial direction offset
s	Safety factor recommended: 5 mm (0.197 in)

The following graph shows the lateral shift of the displacer depending on the measured distance for the different wire drums.

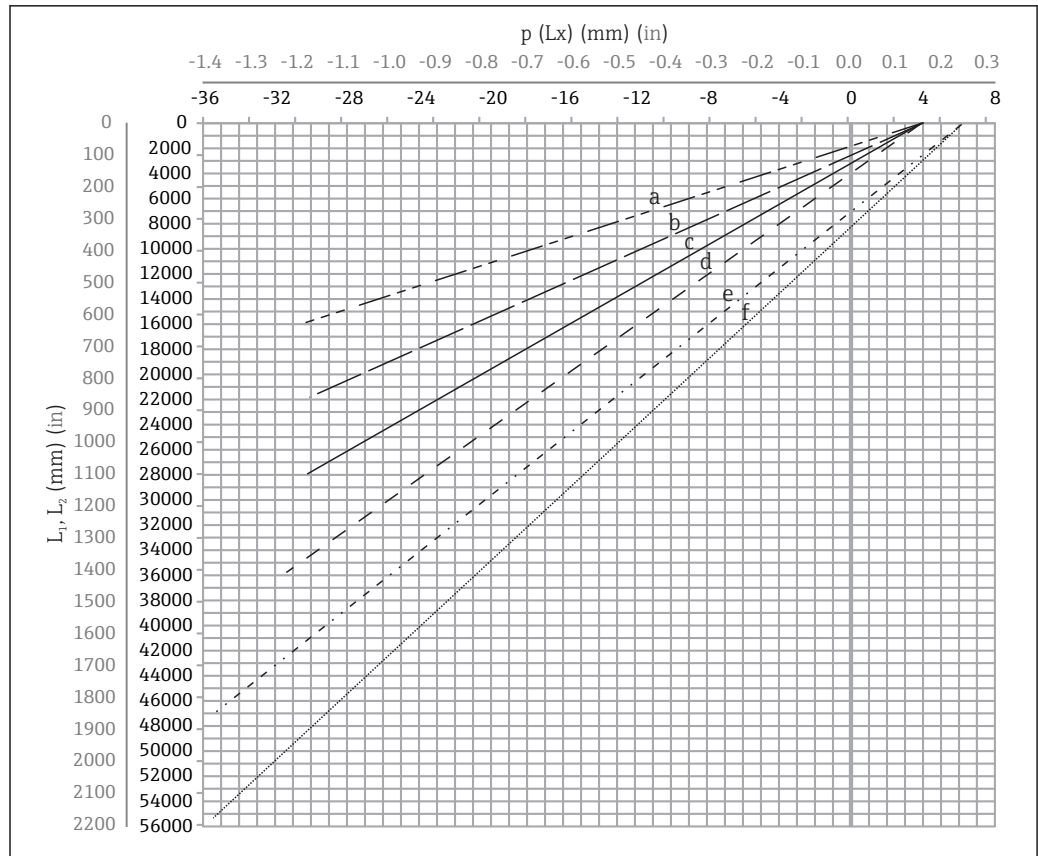

A0027997

9 Lateral shift of displacer according to measurement range

- a 16 m (A3) (NMS80/NMS81/NMS83)
- b 22 m (C2) (NMS80/NMS81/NMS83)
- c 28 m (D1) (NMS80/NMS81)
- d 36 m (F1) (NMS80/NMS81)
- e 47 m (G1) (NMS81)
- f 55 m (H1) (NMS81)

Upper diameter of stilling well

The dimension of D_1 has to be the largest value of the dimensions D_{1a} , D_{1b} , D_{1c} , and D_{1d} according to the following formula.

D ₁ Dimension (Example)	D _{1x} Dimension		Description	Formula
	Example	Parameter		
>68.1 mm (2.68 in)	68.1 mm (2.68 in)	D _{1a}	D ₁ dimension when the displacer is at the center of the calibration window	$= 2 \times (p(0) + d/2 + s)$
	65.6 mm (2.58 in)	D _{1b}	D ₁ dimension when the displacer is at the upper part of the stilling well	$= 2 \times (p(L_1) + d/2 + s)$

D ₁ Dimension (Example)	D _{1x} Dimension		Description	Formula
	Example	Parameter		
	50.9 mm (2.00 in)	D _{1c}	D ₁ dimension when the displacer is at the bottom of the stilling well	$= 2 \times (p (L_2) + s)$
		D _{1d}	D ₁ dimension when the radial direction offset is considered. This calculation is used only with the 47 m (154.20 ft) wire drum (G1 in Feature110) and 55 m (180.45 ft) (H1 in feature 110)	$= 2 \times (d/2 + r + s)$

 Example: L₁ = 1 000 mm, L₂ = 20 000 mm, d = 50 mm, s = 5.0, 28 m drum

Lower diameter of stilling well

The dimension of D₂ has to be the larger value of the dimensions D₁ and D_{2b} .

See the table below.

Concentric pipe

D ₂ Dimension (Example)	D _{2x} Dimension		Description	Formula
	Example	Parameter		
>100.9 mm (3.97 in)	68.1 mm (2.68 in)	D ₁	Calculated D ₁ value	
	100.9 mm (3.97 in)	D _{2b}	D ₂ dimension when the displacer is in L ₂ length	$= 2 \times (p (L_2) + d/2 + s)$

 Example: L₂ = 20 000 mm, d = 50 mm, s = 5.0, 28 m drum

Asymmetric pipe

D ₂ Dimension (Example)	D _{2x} Dimension		Description	Formula
	Example	Parameter		
>84.5 mm (3.33 in)	68.1 mm (2.68 in)	D ₁	Calculated D ₁ value	
	84.5 mm (3.33 in)	D _{2b}	D ₂ dimension that the displacer can pass through (nth groove)	$= p (L_2) + d/2 + s + D_1/2$

 Example: L₂ = 20 000 mm, d = 50 mm, s = 5.0, 28 m drum

Recommendations for NMS8x mounting with a stilling well

Follow the recommendations for mounting NMS8x with a stilling well.

- Keep the pipe connection welds smooth.
- When drilling holes into the pipe, keep the interior surface of the holes clear of metal chips and burrs.
- Coat or paint the interior surface of the pipe to prevent corrosion.
- Keep the pipe as vertical as possible. Check using a plumb bob.
- Install the asymmetric pipe under the valve and align the centers of the NMS8x and the valve.
- Set the center of the lower part of the asymmetric pipe in the direction of the lateral motion.
- Observe the recommendations as per API MPMS chapter 3.1B.
- Confirm grounding between NMS8x and the tank nozzle.

5.1.5 Mounting with guide wires

It is also possible to guide the displacer with guide wires to prevent swinging.

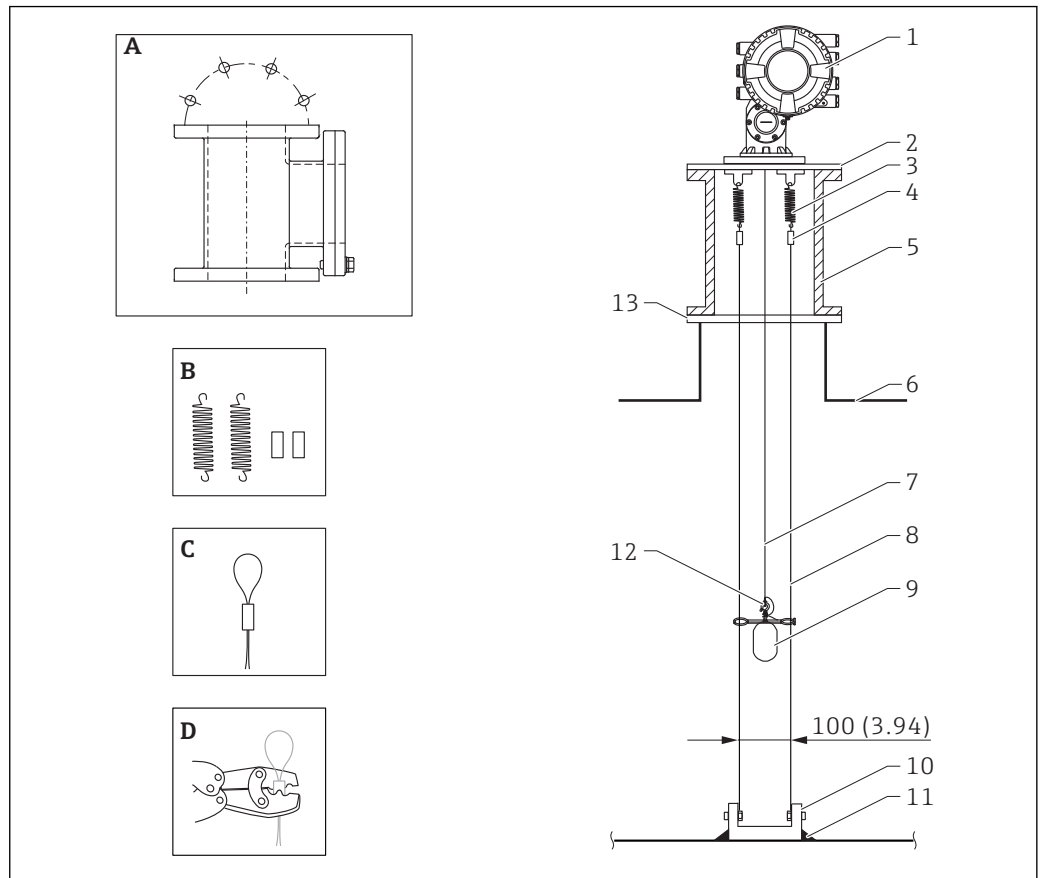

A0026819

10 Guide wire; dimensions mm (in)

No.	Description
A	Calibration chamber
B	Spring and sleeve
C	Guide wire sleeve
D	Crimp tool
1	NMS8x
2	Reducer plate
3	Spring, SUS304
4	Sleeve, SUS316
5	Calibration chamber for maintenance
6	Tank
7	Measuring wire
8	Guide wire, SUS316
9	Displacer
10	Anchor hook plate, SUS304
11	Welding point
12	Wire ring, SUS316L
13	Flange

Guide wire installation

Guide wire installation procedure

1. Install NMS8x [1] on the reducer plate.
2. Perform calibration steps (→  87) before the displacer [3] is attached to the guide wires.
 - ↳ Make sure that the displacer does not touch the guide wires during calibration. This could be done by mounting the NMS8x to the reducer plate [2] prior to fitting the guide wires [4].

 Perform calibration steps so that displacer does not touch the guide wires if the guide wires are already installed to the reducer plate.

3. Secure the guide wires to the hooks of the springs [5].
4. Secure the springs to the reducer plate.
5. Put the guide wires through the displacer guide ring [6] and set the displacer.

This completes the guide wire installation procedure.

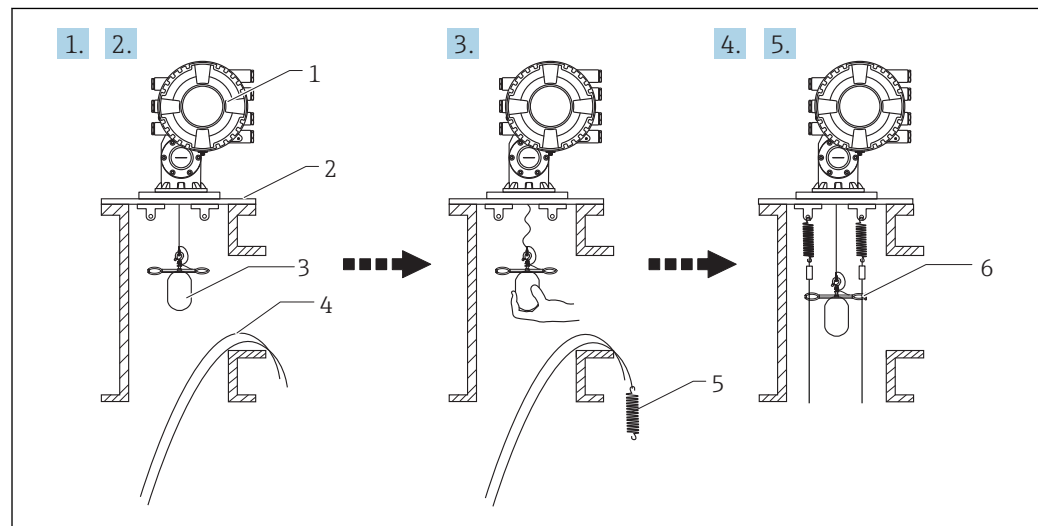

 11 Guide wire installation

- 1 NMS8x
- 2 Reducer plate
- 3 Displacer
- 4 Guide wires
- 5 Springs
- 6 Displacer guide ring

5.1.6 Alignment of NMS8x

Flange

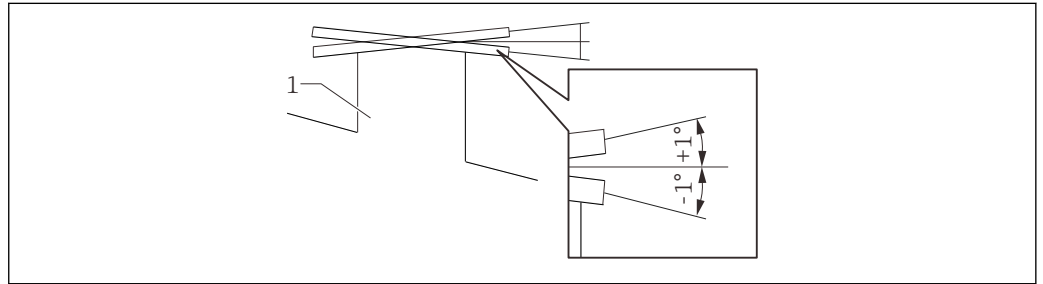

Confirm that the size of the nozzle and the flange is matched prior to mounting NMS8x on the tank. The flange size and the rating of NMS8x vary depending on the customer's specifications.

-  Check the flange size of NMS8x.
- Mount the flange on the top of the tank. The deviation of the flange from the horizontal plane should not exceed ± 1 degree.
- When mounting NMS8x on a long nozzle, make sure that the displacer does not touch the inner wall of the nozzle.



 12 Allowable inclination of mounting flange

1 Nozzle

-  When NMS8x is installed without a guide system, follow the recommendations below:
 - Confirm the mounting nozzle is in the sector between 45 and 90 degrees (or -45 and -90 degrees) away from the inlet pipe of the tank. This prevents heavy swinging of the displacer caused by waves or turbulence from the inlet liquid.
 - Confirm the mounting nozzle is 500 mm (19.69 in) or more away from the tank wall.
 - Confirm the minimum measuring level is at 500 mm (19.69 in) or more above the top of the inlet pipe by setting the low stop (for details of low stop setting, →  97). This protects the displacer from direct flow of the inlet liquid.
 - If a stilling well cannot be mounted in the tank due to the shape or condition of the tank, attaching a guide system is recommended. Consult E+H services for further information.

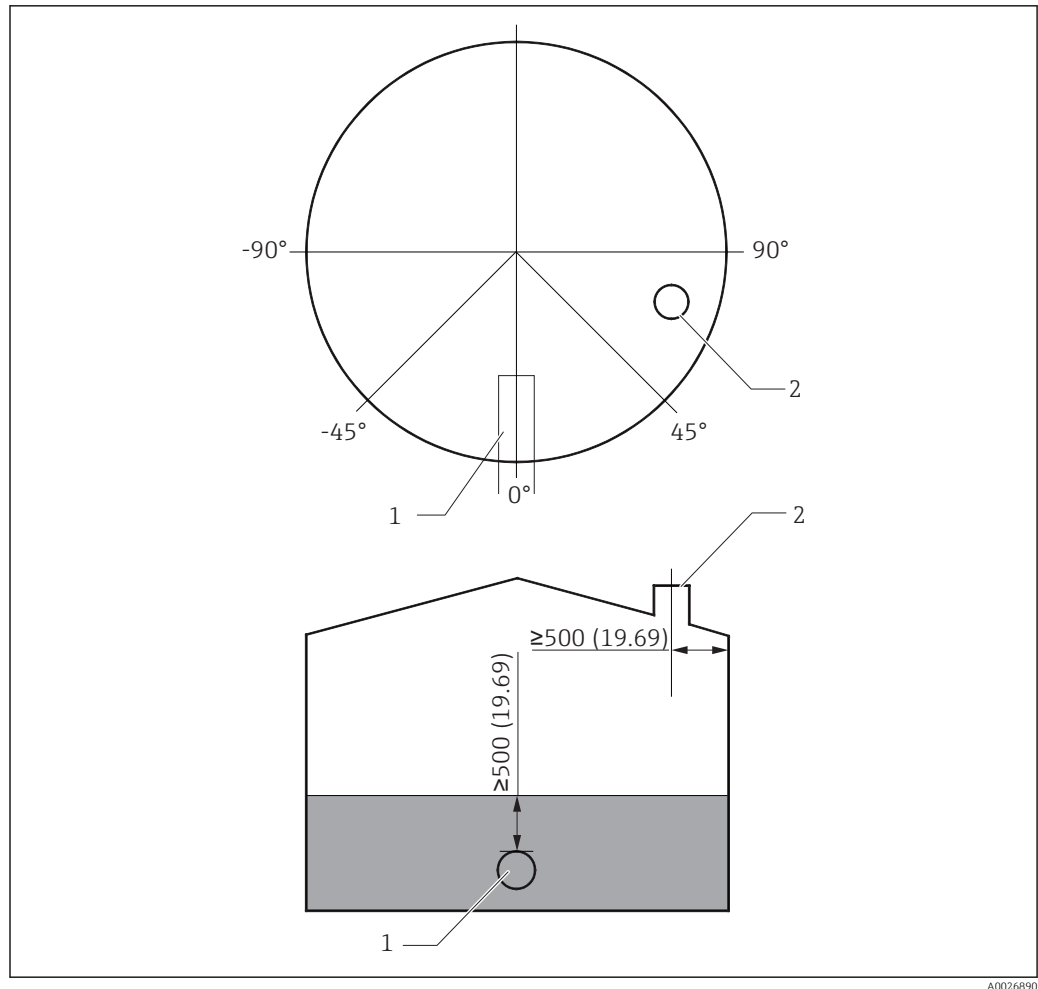

13 Recommended position for mounting NMS8x and minimum measuring level; dimensions mm (in)

- 1 Inlet pipe
2 Tank nozzle

- i** Before pouring liquid into the tank, confirm that liquid flowing through the inlet of the pipe will not contact the displacer directly.
- When discharging liquid out of the tank, ensure that the displacer will not get caught in the liquid current and sucked into the outlet pipe.

5.1.7 Electrostatic charge

When liquid measured by NMS8x has a conductivity of 1 uS/m or less, it is quasi-nonconductive. In this case, using a stilling well or guide wire is recommended. This releases the electrostatic charge on the liquid surface.

5.2 Mounting of the device

The NMS8x is delivered in two different packing styles depending on the mounting method of the displacer.

- For the all-in-one method, the displacer is mounted on the measuring wire of NMS8x.
- For the displacer shipped separately method, it is necessary to install the displacer on the measuring wire inside NMS8x.

5.2.1 Available installations

The following installation procedures are available for NMS8x.

- Mounting without guide system
- Mounting with stilling well
- Mounting with guide wire

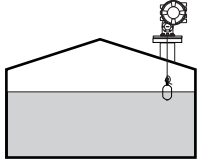
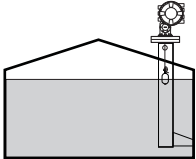
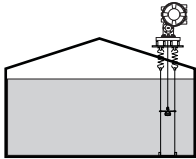
Mounting options	Without guide system (Free-space mounting)	With stilling well	With guide wire
Type of tanks			
Type of installations	<ul style="list-style-type: none"> ■ All-in one ■ Displacer shipped separately ■ Displacer installation through calibration window 	<ul style="list-style-type: none"> ■ All-in one ■ Displacer shipped separately ■ Displacer installation through calibration window 	Displacer shipped separately

5.2.2 Verification of displacer and wire drum

Prior to installation of NMS8x, confirm that the serial numbers of displacer and the wire drum match with those printed to the label attached on the housing.

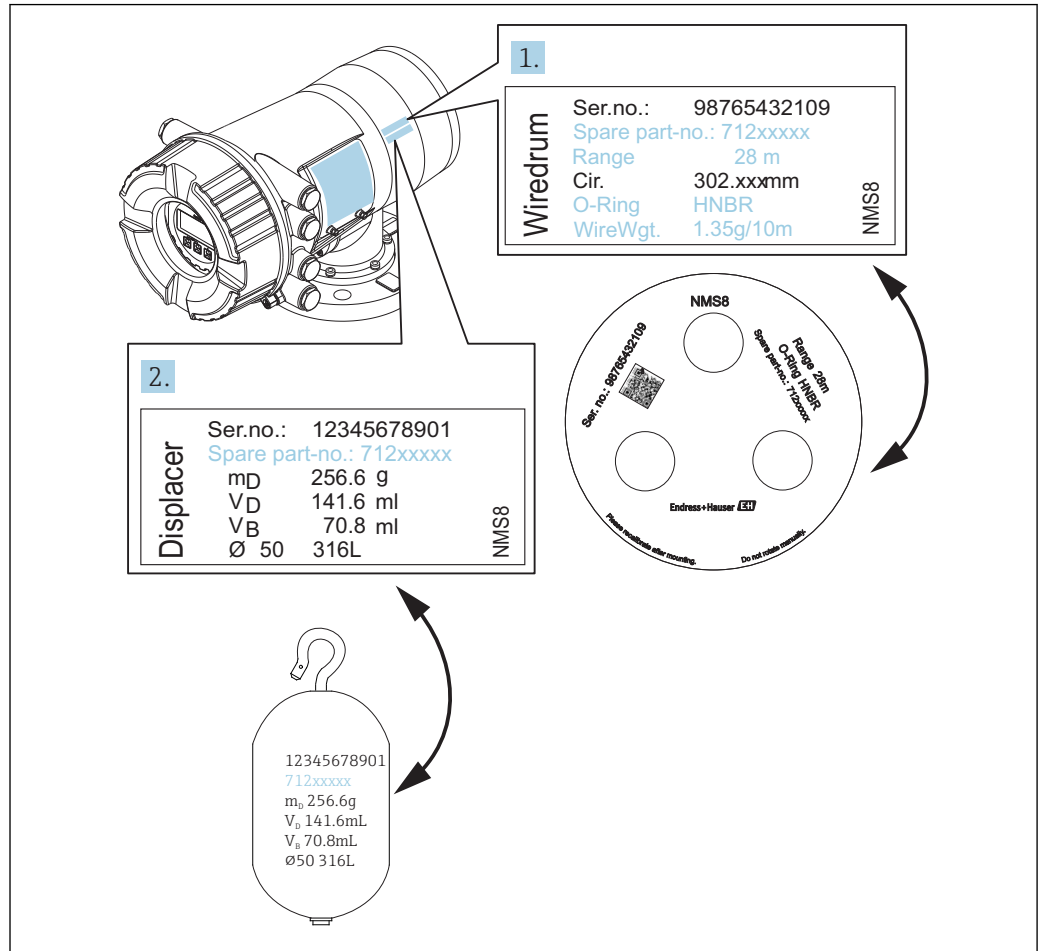





A0030106

14 Verification of displacer and wire drum

5.2.3 Tools to be required for installation

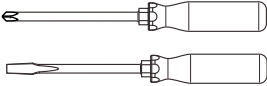
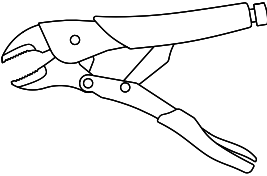
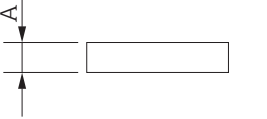
The following tools are required when installing NMS8x.

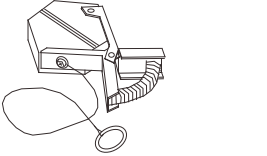
Tools	Figures	Notes
Crescent wrench		Use the size of 350 mm (13.78 in)
Allen key		Use the size of 3 mm (0.12 in) or 5 mm (0.17 in)
Screw driver <ul style="list-style-type: none"> ■ Cross-head screwdriver ■ Flat-blade screwdriver 		
Wire cutters or terminal pliers		
Crimp terminal		A: Signal and power supply: 0.2 to 2.5 mm ² (24 to 13 AWG) <ul style="list-style-type: none"> ■ Ground terminal in the terminal compartment: max. 2.5 mm² (13 AWG) ■ Ground terminal at the housing: max. 4 mm² (11 AWG)
Water pump pliers		
Density calibration test weight		This tool is used especially for density measurement application (optional).

5.2.4 Installation for all-in-one method

In the case of a 50 mm (1.97 in) or 70 mm (2.76 in) diameter displacer, the device can be delivered by all-in-one method.

i Displacer is shipped separately according to the following specifications.

- 47 m (154.2 ft) measuring range
- 55 m (180.5 ft) measuring range
- 110 mm (4.33 in) measuring range
- NPS8 in flange
- Cleaned from oil+grease option

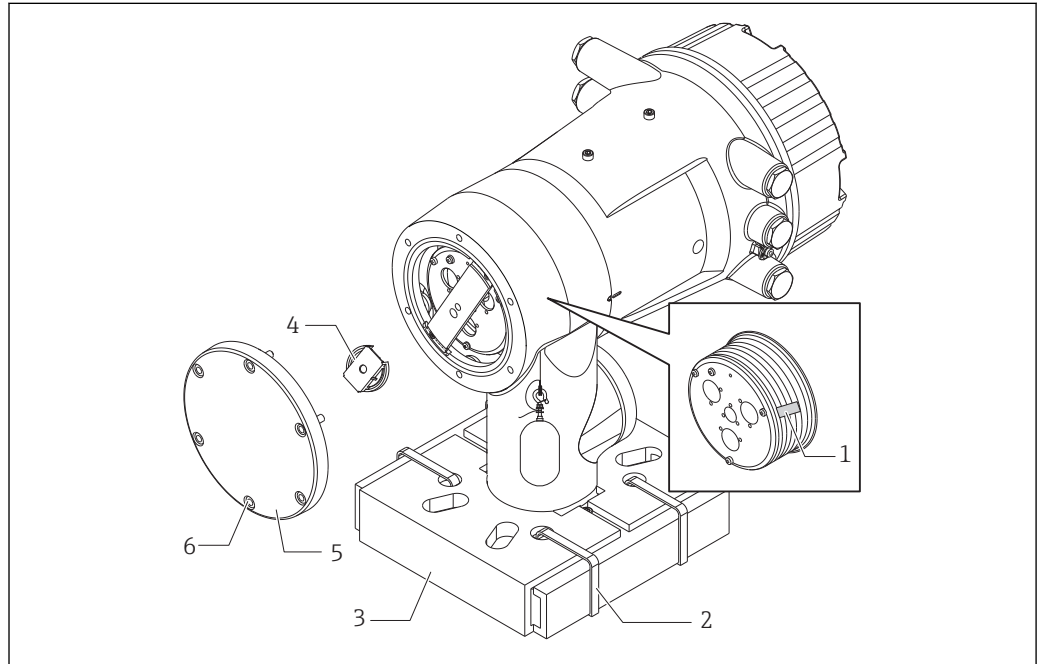

A0030108

i 15 Removing packing materials

- 1 Tape
- 2 Fixing band
- 3 Displacer holder
- 4 Wire drum stopper
- 5 Drum housing cover
- 6 Screws and bolts

Steps	Procedures	Notes
1	<ol style="list-style-type: none"> 1. Hold the gauge so that it stays horizontal against the flange. 2. Cut the fixing bands [2]. 3. Remove the displacer holder [3] and packing material of the displacer. 	<ul style="list-style-type: none"> ▪ Perform these steps before mounting NMS8x on the nozzle. ▪ Do not tilt NMS8x after removing the displacer holder.
2	<ol style="list-style-type: none"> 4. Mount NMS8x on the nozzle. 	<ul style="list-style-type: none"> ▪ Make sure that the measuring wire hangs vertically. ▪ Confirm that there are no kinks or other defects in the measuring wire.
3	<ol style="list-style-type: none"> 5. Remove screws and M6 bolts [6] (M10 bolts for stainless steel housing) to remove the drum housing cover [5]. 6. Loosen two screws and remove the wire drum stopper [4]. 	<p>Be sure not to lose the O-ring and the fixing bolts for the cover of the drum housing.</p>

Steps	Procedures	Notes
4	7. Remove the tape [1] from the wire drum carefully.	<ul style="list-style-type: none">Remove the tape by hand to avoid damaging the wire drum.Make sure that the measuring wire is wound so that it fits correctly in the grooves.
5	8. Mount the drum housing cover.	Confirm that the O-ring is in the drum housing cover.
6	9. Turn on the power of NMS8x.	 Sensor, reference, and drum calibration steps are not required because they are all performed prior to delivery.

5.2.5 Installation for displacer shipped separately method

It is necessary to remove the wire drum from NMS8x, remove the tape on the wire drum, mount the wire drum in the drum housing, and install the displacer on the measuring wire.

Use blocks or a pedestal to secure NMS8x and provide an environment where electrical power can be supplied to NMS8x.

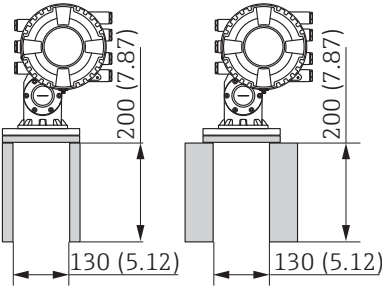
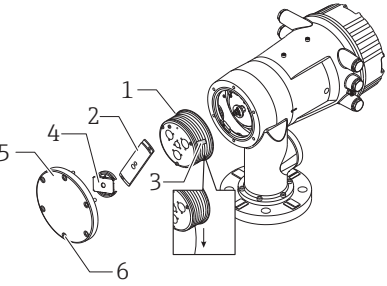
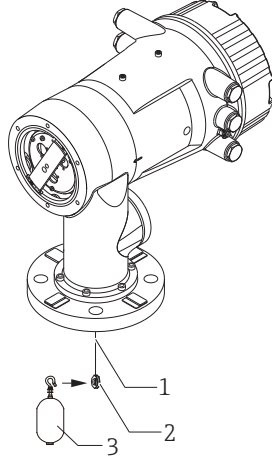
Procedures	Figures
<ol style="list-style-type: none"> 1. Secure NMS8x on the blocks or pedestal. 2. Confirm that there is enough space under NMS8x. <p>i Be careful not to drop NMS8x.</p>	 <p style="text-align: center;">Dimensions mm (in)</p>
<ol style="list-style-type: none"> 3. Remove screws and M6 bolts [6] (M10 bolts for stainless steel housing). 4. Remove the wire drum cover [5], wire drum stopper [4], and the bracket [2]. 5. Remove the wire drum [1] from the drum housing. 6. Remove the tape [3] on the wire drum. 7. Unwind the measuring wire approximately 250 mm (9.84 in) so that the wire ring is positioned under the flange. 8. Mount the wire drum on NMS8x. 9. Mount the bracket. <p>i</p> <ul style="list-style-type: none"> ▪ Take special care to not hit the wire drum against the housing due to strong magnet force. ▪ Handle the measuring wire with care. It may kink. ▪ Be sure that the wire is wound correctly in the grooves. 	 <p style="text-align: right; font-size: small;">A0030109</p>
<ol style="list-style-type: none"> 10. Hook the displacer [3] on the ring [2]. <p>i</p> <ul style="list-style-type: none"> ▪ Be sure that the wire is wound correctly in the grooves. ▪ If not, remove the displacer and the wire drum, and repeat step 7. 	 <p style="text-align: right; font-size: small;">A0030110</p>

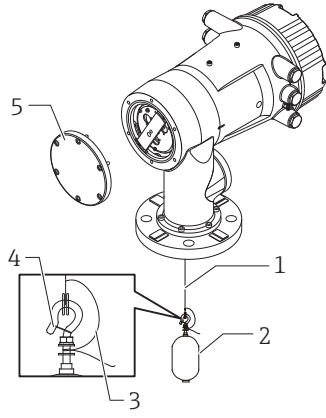
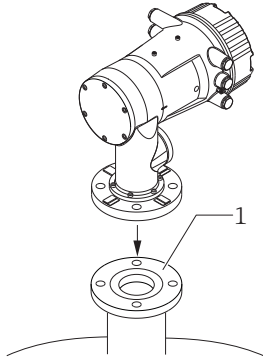
Procedures	Figures
<p>11. Turn on the power of NMS8x.</p> <p>12. Perform sensor calibration</p> <p>13. Secure the displacer [2] to the measuring wire [1] using the securing wire [4].</p> <p>14. Install the ground wire [3] of the displacer (for details of displacer ground wire installation → 44).</p> <p>15. Perform reference calibration.</p> <p>16. Turn off the power.</p> <p>17. Mount the wire drum cover [5].</p> <p>i For sensor calibration, → 90 For reference calibration, → 92.</p>	 <p style="text-align: right;">A0030111</p>
<p>18. Mount NMS8x on the tank nozzle [1].</p> <p>19. Confirm that the displacer does not touch the inner wall of the nozzle.</p> <p>20. Turn on the power.</p> <p>21. Perform drum calibration.</p> <p>i For drum calibration, → 93</p>	 <p style="text-align: right;">A0030112</p>

5.2.6 Installation through the calibration window

In the case of a 50 mm (1.97 in) diameter displacer, the displacer can be installed through the calibration window.

i It is only possible to install the following displacers through the calibration window:
50 mm SUS, 50 mm alloy C, 50 mm PTFE

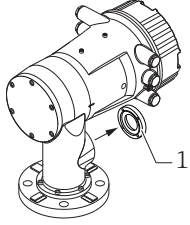
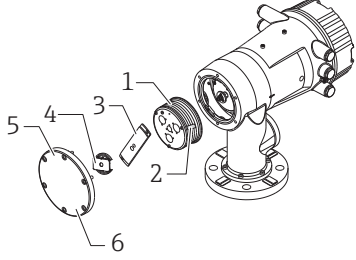
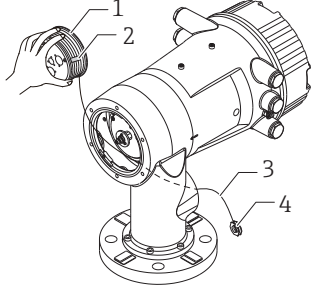
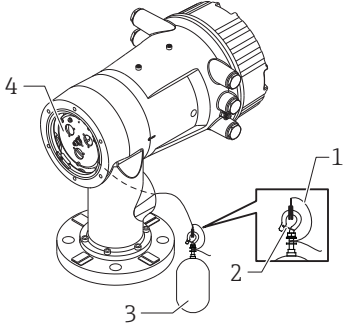
Procedures	Figures
<p>1. Remove the calibration window cover [1].</p>	 <p style="text-align: right;">A0030113</p>
<p>2. Remove M6 bolts and screws [6] (M10 bolts for stainless steel housing).</p> <p>3. Remove the cover [5], wire drum stopper [4], and the bracket [3].</p> <p>4. Remove the wire drum [1] from the drum housing.</p> <p>5. Remove the tape [2] that is securing the wire.</p> <p>i Handle the measuring wire with care. It may kink.</p>	 <p style="text-align: right;">A0030114</p>
<p>6. Holding the wire drum [1] with one hand, unwind the measuring wire [3] approximately 500 mm (19.69 in).</p> <p>7. Secure the wire [3] temporarily with the tape [2].</p> <p>8. Insert the wire ring [4] into the drum housing.</p> <p>9. Pull the wire ring out through the calibration window.</p> <p>i Handle the measuring wire with care.</p>	 <p style="text-align: right;">A0030115</p>
<p>10. Insert the wire drum [4] temporarily into the drum housing.</p> <p>11. Hook the displacer [3] on the wire ring.</p> <p>12. Secure the displacer to the measuring wire using the securing wire [2].</p> <p>13. Install the ground wire [1] for the displacer (for details of displacer ground wire installation → 44).</p> <p>i</p> <ul style="list-style-type: none"> ▪ Take special care to not hit the wire drum against the housing due to strong magnet force. ▪ Handle the measuring wire with care. It may kink. 	 <p style="text-align: right;">A0030116</p>

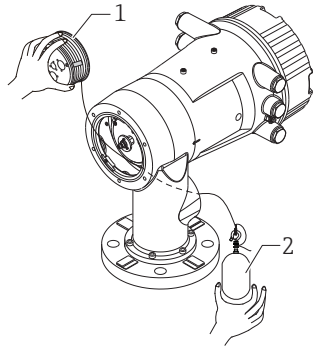
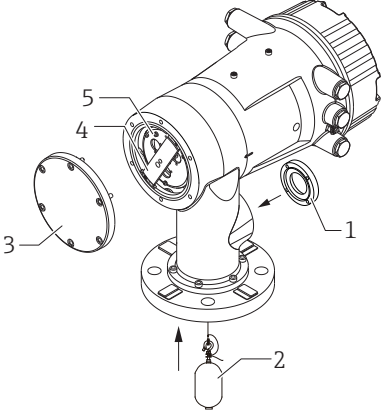
Procedures	Figures
<p>14. Remove the wire drum from the drum housing and unwind the measuring wire approximately 500 mm (19.69 in).</p> <p>15. Hold the wire drum [1] up and place the displacer [2] into the calibration window.</p> <p>16. Hold the displacer at the center of the calibration window.</p> <p>17. Hold the other hand (wire drum) up to add tension to the measuring wire in order not to drop the displacer rapidly.</p>	 <p>A0030117</p>
<p>18. Let go of the displacer [2].</p> <p>19. Remove the tape from the wire drum [5].</p> <p>20. Insert the wire drum into the drum housing.</p> <p>21. Mount the bracket [4].</p> <p>i Be sure that the wire is wound correctly in the grooves.</p> <p>22. Turn on the power of NMS8x and move the displacer up using the Move displacer wizard → 88 until the wire ring can be seen in the calibration window.</p> <p>i</p> <ul style="list-style-type: none"> ▪ Confirm that there are no kinks or other defects in the measuring wire. ▪ Confirm that the displacer does not touch the inner wall of the nozzle. <p>23. Perform sensor calibration.</p> <p>i For sensor calibration, → 90</p> <p>24. Perform reference calibration.</p> <p>i For reference calibration, → 92.</p> <p>25. Mount the drum housing cover [3] and the calibration window cover [1].</p> <p>26. Perform drum calibration.</p> <p>i For drum calibration, → 93</p>	 <p>A0030118</p>

5.2.7 Displacer ground wire installation

Depending on the application and Ex requirements, electrical grounding of the displacer is required. There are different procedures depending on the displacer type, which are described below.

 For details of displacer installation →  35

Standard displacer installation

1. Mount the displacer [3] on the wire ring [1].
2. Wind the securing wire [4] on the wire hook.
3. Wind the ground wire [2] between the washers [5] twice.
 - ↳ If grounding is not required for non-explosion-proof applications, skip this step.
4. Secure the nut [6] with a wrench [7].

This completes the displacer installation procedure.

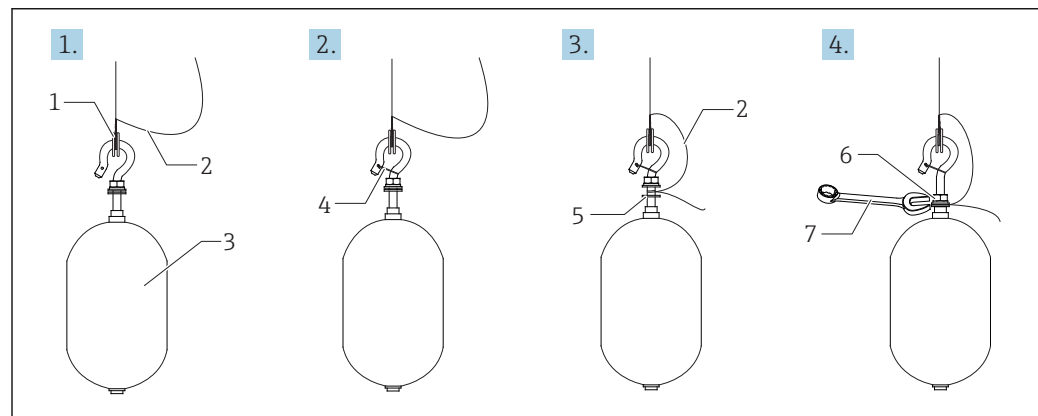

A0028694

 16 Displacer installation

- 1 Wire ring
- 2 Ground wire
- 3 Displacer
- 4 Securing wire
- 5 Washer
- 6 Nut
- 7 Wrench

PTFE displacer installation

1. Remove the screw [1] using a flathead screwdriver.
2. Mount the displacer [4] on the PFA covered ring [2].
3. Remove the PFA cover approximately 10 mm (0.39 in) for conductivity.
4. Install the ground wire [6] onto the displacer from the wire insertion slot [3] until the ground wire contacts to the wall of the screw hole [5].
5. Tighten the screw [1].
 - ↳ Hold the ground wire with finger tips so that the wire does not come out from the slot.
6. Lift the displacer using a screwdriver and confirm that the ground wire does not come out from the slot.

This completes the PTFE displacer installation.

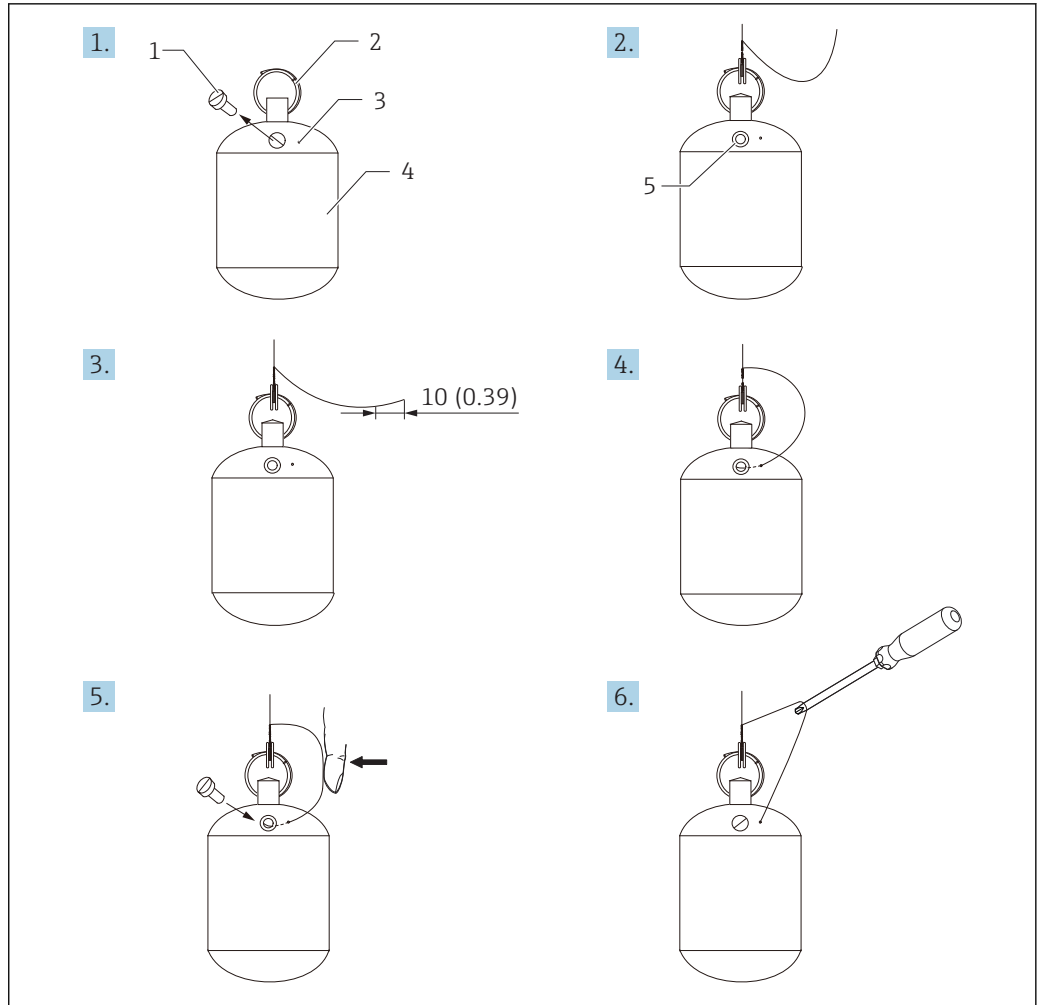

A0028696

17 PTFE displacer installation; dimensions mm (in)

- 1 Screw
- 2 PFA covered ring
- 3 Wire insertion slot
- 4 Displacer
- 5 Screw hole
- 6 Ground wire

5.3 Post-installation check

<input type="radio"/>	Is the device undamaged (visual inspection)?
<input type="radio"/>	Does the device conform to the measuring point specifications? For example: <ul style="list-style-type: none"> ■ Process temperature ■ Process pressure (refer to the chapter on "Material load curves" of the "Technical Information" document) ■ Ambient temperature range ■ Measuring range
<input type="radio"/>	Are the measuring point identification and labeling correct (visual inspection)?
<input type="radio"/>	Is the device adequately protected from precipitation and direct sunlight?

6 Electrical connection

6.1 Terminal assignment

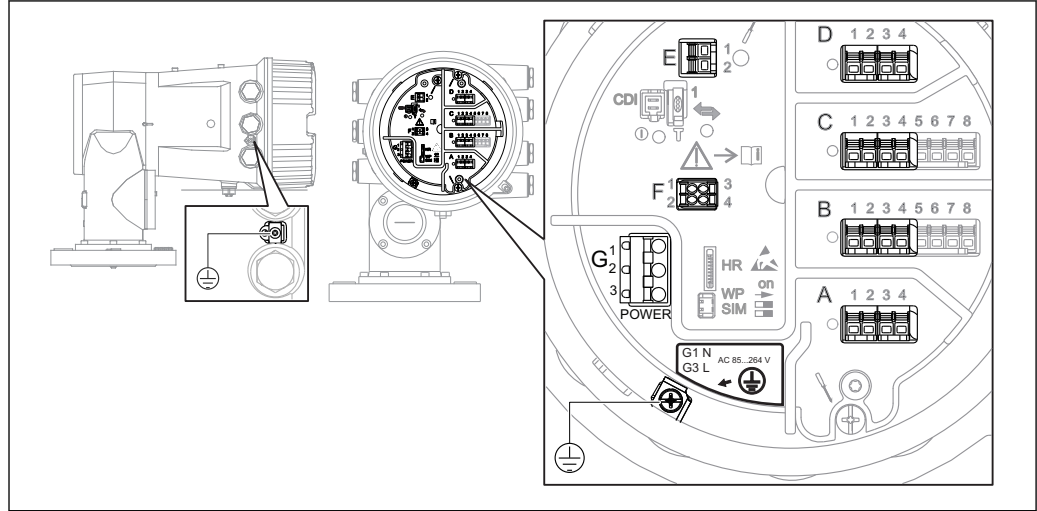

A0026905

18 Terminal compartment (typical example) and ground terminals

Terminal area	Module
A/B/C/D (slots for I/O modules)	<p>Up to four I/O modules, depending on the order code</p> <ul style="list-style-type: none"> Modules with four terminals can be in any of these slots. Modules with eight terminals can be in slot B or C. <p>i The exact assignment of the modules to the slots is dependent on the device version → 49.</p>
E	<p>HART Ex i/IS interface</p> <ul style="list-style-type: none"> E1: H+ E2: H-
F	<p>Remote display</p> <ul style="list-style-type: none"> F1: V_{CC} (connect to terminal 81 of the remote display) F2: Signal B (connect to terminal 84 of the remote display) F3: Signal A (connect to terminal 83 of the remote display) F4: Gnd (connect to terminal 82 of the remote display)
G	<p>Power consumption: 28.8 VA¹⁾</p> <p>Power supply: 85 to 264 V_{AC}</p> <ul style="list-style-type: none"> G1: N G2: not connected G3: L
	<p>Protective ground connection (M4 screw)</p> <p>A0018339</p>

1) Maximum power varies depending on the configuration of the modules. As the value of 28.8 VA shows maximum apparent power, select the applicable cables accordingly. The actual consumed effective power is 12 w.

6.1.1 Power supply

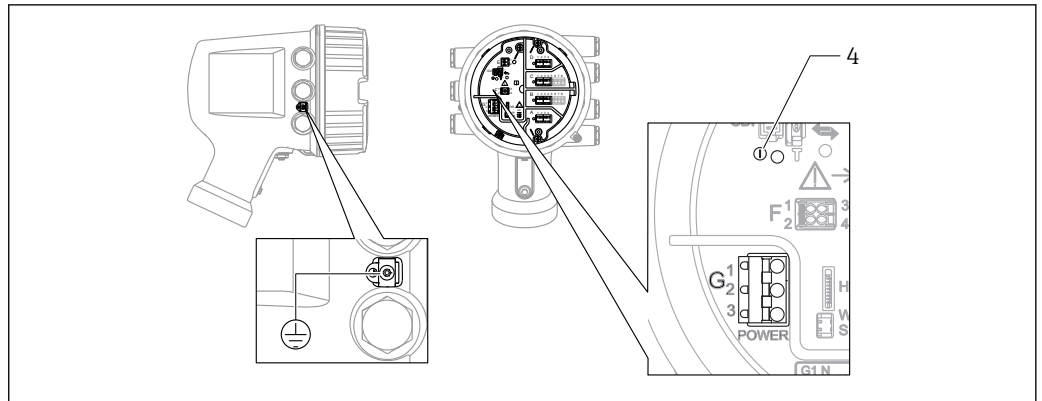

- G1 N
- G2 not connected
- G3 L
- 4 Green LED: indicates power supply

Supply voltage

85 to 264 V_{AC}, 50/60 Hz, 28.8 VA ¹⁾

i The supply voltage is also indicated on the nameplate.

6.1.2 Remote display and operating module DKX001

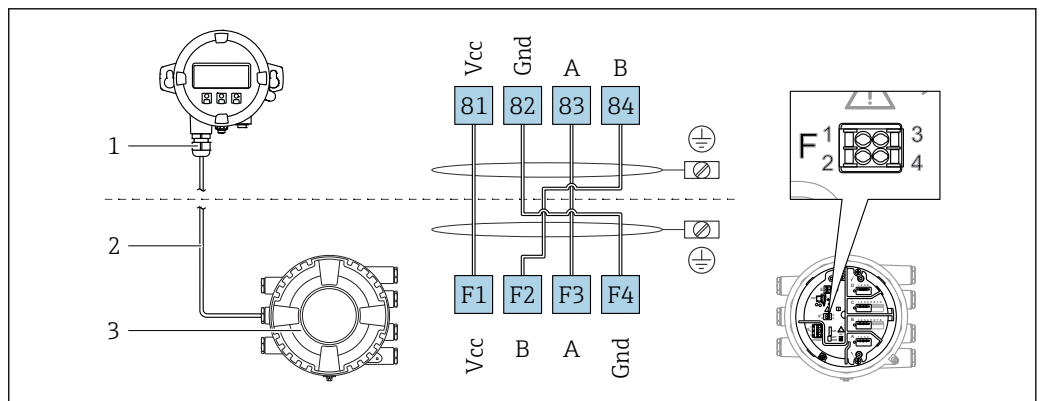

19 Connection of the remote display and operating module DKX001 to the Tank Gauging device (NMR8x, NMS8x or NRF8x)

- 1 Remote display and operating module
- 2 Connecting cable
- 3 Tank Gauging device (NMR8x, NMS8x or NRF8x)

i The remote display and operating module DKX001 is available as an accessory. For details refer to SDO1763D.

- i**
 - The measured value is indicated on the DKX001 and on the local display and operating module simultaneously.
 - The operating menu cannot be accessed on both modules at the same time. If the operating menu is entered in one of these modules, the other module is automatically locked. This locking remains active until the menu is closed in the first module (back to measured value display).

1) maximum value; actual value depending on modules installed. 28.8 VA includes the nominal power, and the cabling specification has to meet this value. On the other hand, the effective power consumption is 12 W.

6.1.3 HART Ex i/IS interface

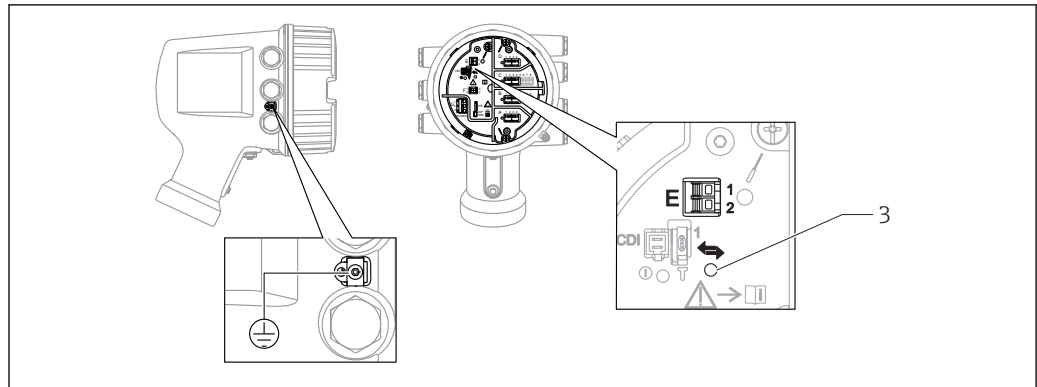

A0033414

- E1 H+
- E2 H-
- 3 Orange LED: indicates data communication

i This interface always operates as the main HART master for connected HART slave transmitters. The Analog I/O modules, on the other hand, can be configured as a HART master or slave → [56](#) → [58](#).

6.1.4 Slots for I/O modules

The terminal compartment contains four slots (A, B, C and D) for I/O modules. Depending on the device version (ordering features 040, 050 and 060) these slots contain different I/O modules. The table below shows which module is located in which slot for a specific device version.

 The slot assignment for the device is also indicated on a label attached to the back cover of the display module.

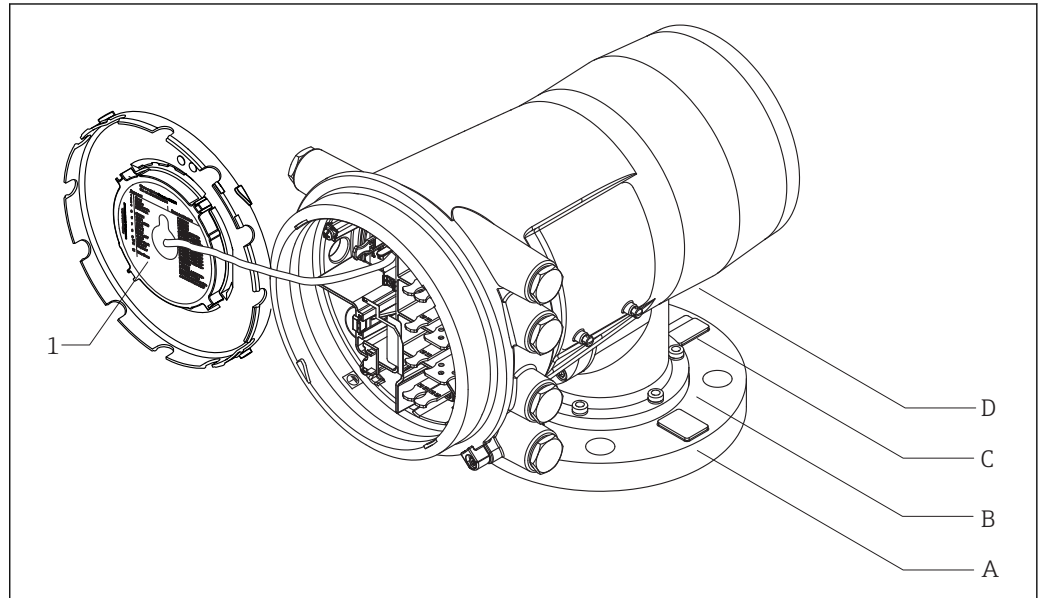

A0030119

- 1 Label showing (among other things) the modules in the slots A to D.
- A Cable entry for slot A
- B Cable entry for slot B
- C Cable entry for slot C
- D Cable entry for slot D

"Primary Output" (040) = "Modbus" (A1)

Ordering feature			Terminal area			
NMx8x - xxxx <u>XX</u> <u>XX</u> <u>XX</u> ... 040 050 060						
040 Primary Output	050 Secondary IO Analog	060 Secondary IO Digital Ex d/XP				
A1	X0	X0	Modbus	-	-	-
A1	X0	A1	Modbus	-	-	Digital
A1	X0	A2	Modbus	-	Digital	Digital
A1	X0	A3	Modbus	Digital	Digital	Digital
A1	X0	B1	Modbus	Modbus	-	-
A1	X0	B2	Modbus	Modbus	-	Digital
A1	X0	B3	Modbus	Modbus	Digital	Digital
A1	A1	X0	Modbus	Analog Ex d/XP	-	-
A1	A1	A1	Modbus	Analog Ex d/XP	-	Digital
A1	A1	A2	Modbus	Analog Ex d/XP	Digital	Digital
A1	A1	B1	Modbus	Modbus	Analog Ex d/XP	-
A1	A1	B2	Modbus	Modbus	Analog Ex d/XP	Digital
A1	A2	X0	Modbus	Analog Ex d/XP	Analog Ex d/XP	-
A1	A2	A1	Modbus	Analog Ex d/XP	Analog Ex d/XP	Digital
A1	A2	B1	Modbus	Analog Ex d/XP	Analog Ex d/XP	Modbus
A1	B1	X0	Modbus	Analog Ex i/IS	-	-
A1	B1	A1	Modbus	Analog Ex i/IS	-	Digital
A1	B1	A2	Modbus	Analog Ex i/IS	Digital	Digital
A1	B1	B1	Modbus	Modbus	Analog Ex i/IS	-
A1	B1	B2	Modbus	Modbus	Analog Ex i/IS	Digital
A1	B2	X0	Modbus	Analog Ex i/IS	Analog Ex i/IS	-
A1	B2	A1	Modbus	Analog Ex i/IS	Analog Ex i/IS	Digital
A1	B2	B1	Modbus	Analog Ex i/IS	Analog Ex i/IS	Modbus
A1	C2	X0	Modbus	Analog Ex i/IS	Analog Ex d/XP	-
A1	C2	A1	Modbus	Analog Ex i/IS	Analog Ex d/XP	Digital
A1	C2	B1	Modbus	Analog Ex i/IS	Analog Ex d/XP	Modbus

"Primary Output" (040) = "V1" (B1)

Ordering feature			Terminal area			
NMx8x - xxxx <u>XX</u> <u>XX</u> <u>XX</u> ... 040 050 060						
040 Primary Output	050 Secondary IO Analog	060 Secondary IO Digital Ex d/XP				
B1	X0	X0	V1	-	-	-
B1	X0	A1	V1	-	-	Digital
B1	X0	A2	V1	-	Digital	Digital
B1	X0	A3	V1	Digital	Digital	Digital
B1	X0	B1	V1	Modbus	-	-
B1	X0	B2	V1	Modbus	-	Digital
B1	X0	B3	V1	Modbus	Digital	Digital
B1	A1	X0	V1	Analog Ex d/XP	-	-
B1	A1	A1	V1	Analog Ex d/XP	-	Digital
B1	A1	A2	V1	Analog Ex d/XP	Digital	Digital
B1	A1	B1	V1	Modbus	Analog Ex d/XP	-
B1	A1	B2	V1	Modbus	Analog Ex d/XP	Digital
B1	A2	X0	V1	Analog Ex d/XP	Analog Ex d/XP	-
B1	A2	A1	V1	Analog Ex d/XP	Analog Ex d/XP	Digital
B1	A2	B1	V1	Analog Ex d/XP	Analog Ex d/XP	Modbus
B1	B1	X0	V1	Analog Ex i/IS	-	-
B1	B1	A1	V1	Analog Ex i/IS	-	Digital
B1	B1	A2	V1	Analog Ex i/IS	Digital	Digital
B1	B1	B1	V1	Modbus	Analog Ex i/IS	-
B1	B1	B2	V1	Modbus	Analog Ex i/IS	Digital
B1	B2	X0	V1	Analog Ex i/IS	Analog Ex i/IS	-
B1	B2	A1	V1	Analog Ex i/IS	Analog Ex i/IS	Digital
B1	B2	B1	V1	Analog Ex i/IS	Analog Ex i/IS	Modbus
B1	C2	X0	V1	Analog Ex i/IS	Analog Ex d/XP	-
B1	C2	A1	V1	Analog Ex i/IS	Analog Ex d/XP	Digital
B1	C2	B1	V1	Analog Ex i/IS	Analog Ex d/XP	Modbus

"Primary Output" (040) = "4-20mA HART Ex d" (E1)

Ordering feature			Terminal area			
NMx8x - xxxx <u>XX</u> <u>XX</u> <u>XX</u> ... 040 050 060						
040 Primary Output	050 Secondary IO Analog	060 Secondary IO Digital Ex d/XP				
E1	X0	X0	-	Analog Ex d/XP	-	-
E1	X0	A1	-	Analog Ex d/XP	-	Digital
E1	X0	A2	-	Analog Ex d/XP	Digital	Digital
E1	X0	A3	Digital	Analog Ex d/XP	Digital	Digital
E1	X0	B1	Modbus	Analog Ex d/XP	-	-
E1	X0	B2	Modbus	Analog Ex d/XP	-	Digital
E1	X0	B3	Modbus	Analog Ex d/XP	Digital	Digital
E1	A1	X0	-	Analog Ex d/XP	Analog Ex d/XP	-
E1	A1	A1	-	Analog Ex d/XP	Analog Ex d/XP	Digital
E1	A1	A2	Digital	Analog Ex d/XP	Analog Ex d/XP	Digital
E1	A1	B1	Modbus	Analog Ex d/XP	Analog Ex d/XP	-
E1	A1	B2	Modbus	Analog Ex d/XP	Analog Ex d/XP	Digital
E1	B1	X0	-	Analog Ex d/XP	Analog Ex i/IS	-
E1	B1	A1	-	Analog Ex d/XP	Analog Ex i/IS	Digital
E1	B1	A2	Digital	Analog Ex d/XP	Analog Ex i/IS	Digital
E1	B1	B1	Modbus	Analog Ex d/XP	Analog Ex i/IS	-
E1	B1	B2	Modbus	Analog Ex d/XP	Analog Ex i/IS	Digital

"Primary Output" (040) = "4-20mA HART Ex i" (H1)

Ordering feature			Terminal area			
NMx8x - xxxx <u>XX</u> <u>XX</u> <u>XX</u> ... 040 050 060						
040 Primary Output	050 Secondary IO Analog	060 Secondary IO Digital Ex d/XP				
H1	X0	X0	-	Analog Ex i/IS	-	-
H1	X0	A1	-	Analog Ex i/IS	-	Digital
H1	X0	A2	-	Analog Ex i/IS	Digital	Digital
H1	X0	A3	Digital	Analog Ex i/IS	Digital	Digital
H1	X0	B1	Modbus	Analog Ex i/IS	-	-
H1	X0	B2	Modbus	Analog Ex i/IS	-	Digital
H1	X0	B3	Modbus	Analog Ex i/IS	Digital	Digital
H1	A1	X0	-	Analog Ex i/IS	Analog Ex d/XP	-
H1	A1	A1	-	Analog Ex i/IS	Analog Ex d/XP	Digital
H1	A1	A2	Digital	Analog Ex i/IS	Analog Ex d/XP	Digital
H1	A1	B1	Modbus	Analog Ex i/IS	Analog Ex d/XP	-
H1	A1	B2	Modbus	Analog Ex i/IS	Analog Ex d/XP	Digital
H1	B1	X0	-	Analog Ex i/IS	Analog Ex i/IS	-
H1	B1	A1	-	Analog Ex i/IS	Analog Ex i/IS	Digital
H1	B1	A2	Digital	Analog Ex i/IS	Analog Ex i/IS	Digital
H1	B1	B1	Modbus	Analog Ex i/IS	Analog Ex i/IS	-
H1	B1	B2	Modbus	Analog Ex i/IS	Analog Ex i/IS	Digital

6.1.5 Terminals of the "Modbus" or "V1" module

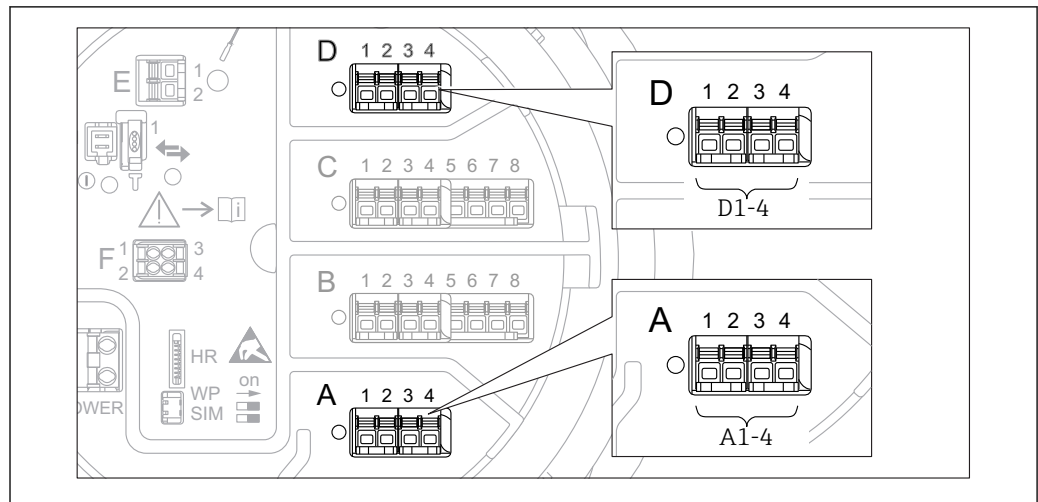

20 Designation of the "Modbus" or "V1" modules (examples); depending on the device version these modules may also be in slot B or C.

Depending on the device version, the "Modbus" and/or "V1" module may be in different slots of the terminal compartment. In the operating menu the "Modbus" and "V1" interfaces are designated by the respective slot and the terminals within this slot: **A1-4, B1-4, C1-4, D1-4.**

Terminals of the "Modbus" module

Terminal ¹⁾	Name	Description
X1	S	Cable shielding connected via a capacitor to EARTH
X2	0V	Common reference
X3	B-	Non-inverting signal line
X4	A+	Inverting signal line
Designation of the module in the operating menu: Modbus X1-4 ; (X = A, B, C or D)		

1) In this column, "X" stands for one of the slots "A", "B", "C", or "D".

Terminals of the "V1" module

Terminal ¹⁾	Name	Description
X1	S	Cable shielding connected via capacitor to EARTH
X2		not connected
X3	B-	Protocol loop signal -
X4	A+	Protocol loop signal +
Designation of the module in the operating menu: V1 X1-4 ; (X = A, B, C or D)		

1) In this column, "X" stands for one of the slots "A", "B", "C", or "D".

6.1.6 Terminals of the "Analog I/O" module (Ex d /XP or Ex i/IS)

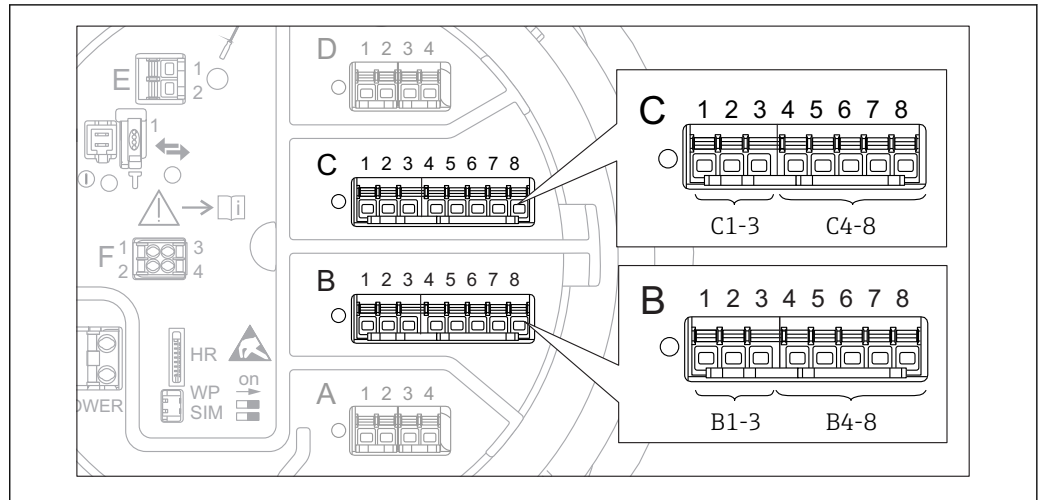

A0031168

Terminals	Function	Connection diagrams	Designation in the operating menu
B1-3	Analog input or output (configurable)	<ul style="list-style-type: none"> ■ Passive usage: → 56 ■ Active usage: → 58 	Analog I/O B1-3 (→ 213)
C1-3			Analog I/O C1-3 (→ 213)
B4-8	Analog input	RTD: → 59	Analog IP B4-8 (→ 207)
C4-8			Analog IP C4-8 (→ 207)

6.1.7 Connection of the "Analog I/O" module for passive usage

- i** In the passive usage the supply voltage for the communication line must be supplied by an external source.
- The wiring must be in accordance with the intended operating mode of the Analog I/O module; see the drawings below.

"Operating mode" = "4..20mA output" or "HART slave +4..20mA output"

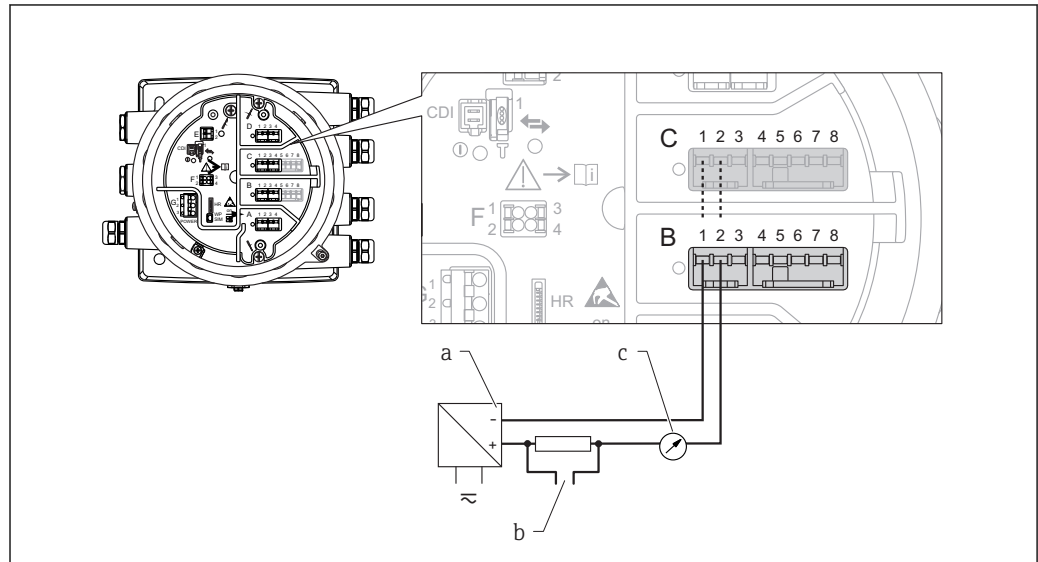

A0027931

21 Passive usage of the Analog I/O module in the output mode

- a Power supply
- b HART signal output
- c Analog signal evaluation

"Operating mode" = "4..20mA input" or "HART master+4..20mA input"

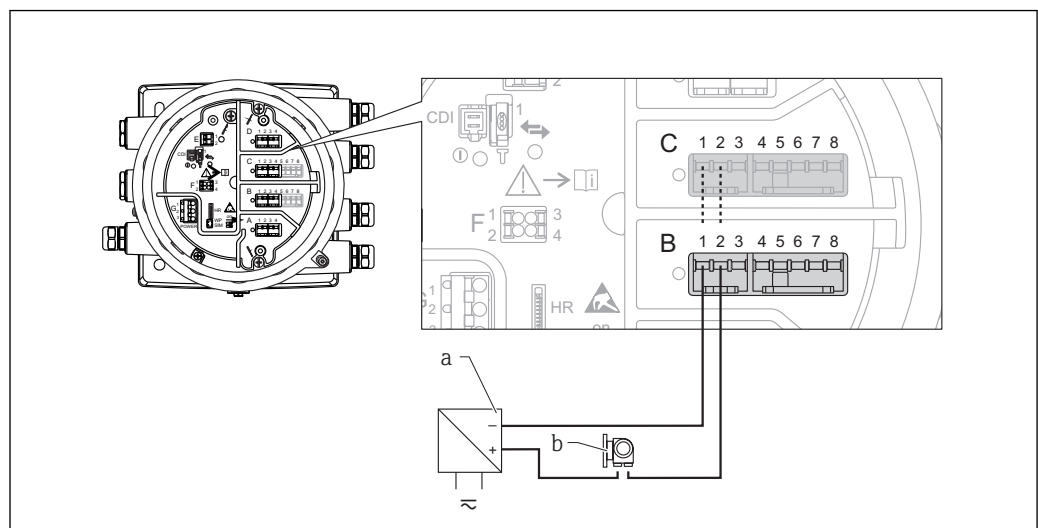

A0027933

22 Passive usage of the Analog I/O module in the input mode

- a Power supply
- b External device with 4...20mA and/or HART signal output

"Operating mode" = "HART master"

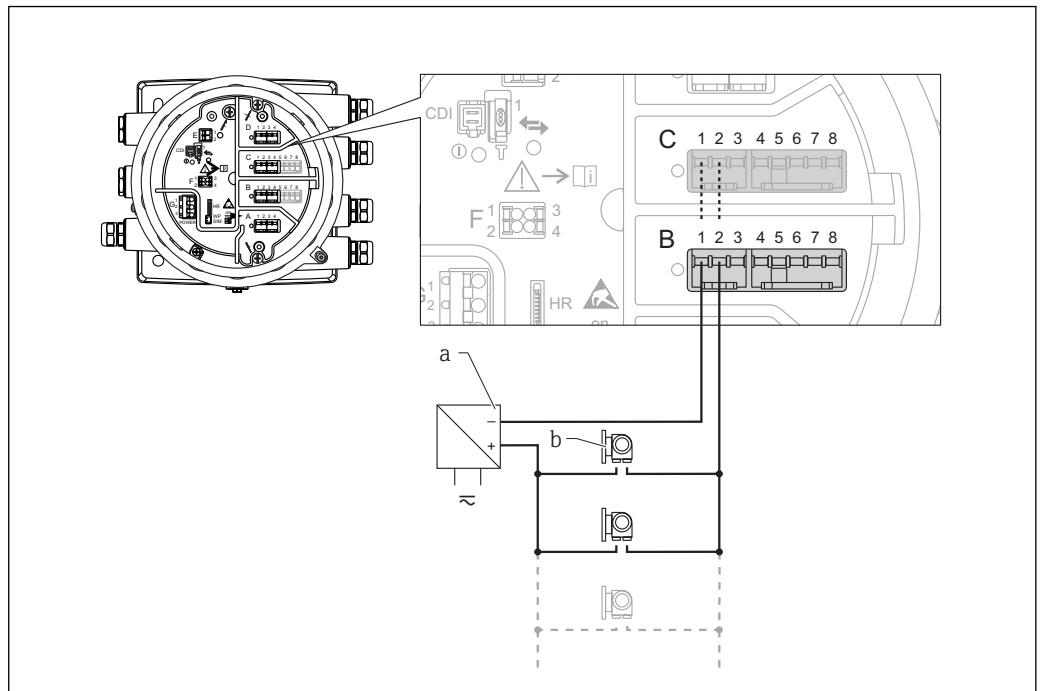

A0027934

23 Passive usage of the Analog I/O module in the HART master mode

- a Power supply
- b Up to 6 external devices with HART signal output

6.1.8 Connection of the "Analog I/O" module for active usage

- i** In the active usage the supply voltage for the communication line is supplied by the device itself. There is no need of an external power supply.
- The wiring must be in accordance with the intended operating mode of the Analog I/O module; see the drawings below.
- i** Maximum current consumption of the connected HART devices: 24 mA (i.e. 4 mA per device if 6 devices are connected).
- Output voltage of the Ex-d module: 17.0 V@4 mA to 10.5 V@22 mA
- Output voltage of the Ex-ia module: 18.5 V@4 mA to 12.5 V@22 mA

"Operating mode" = "4..20mA output" or "HART slave +4..20mA output"

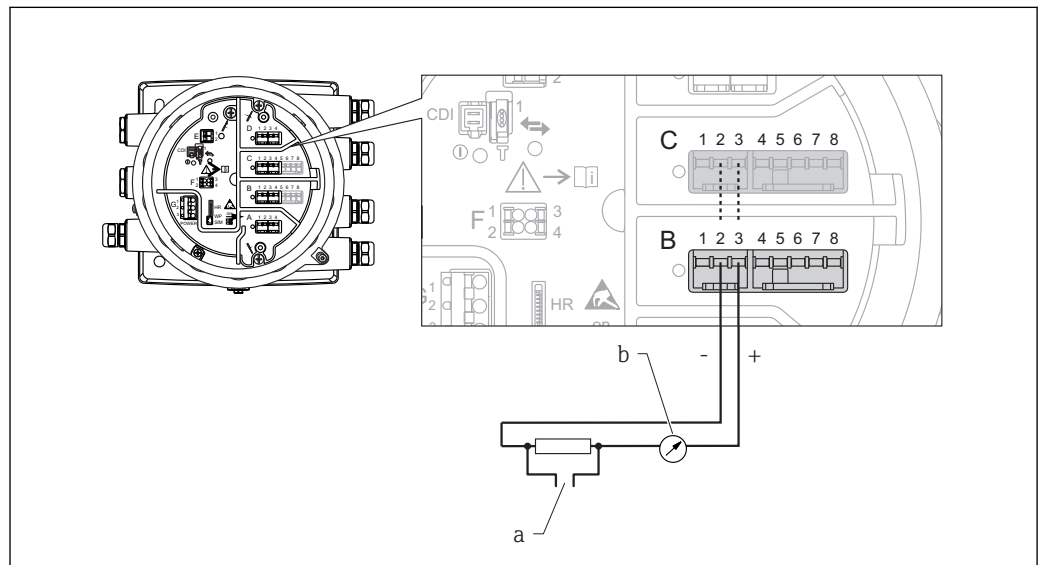

A0027932

24 Active usage of the Analog I/O module in the output mode

- a HART signal output
- b Analog signal evaluation

"Operating mode" = "4..20mA input" or "HART master+4..20mA input"

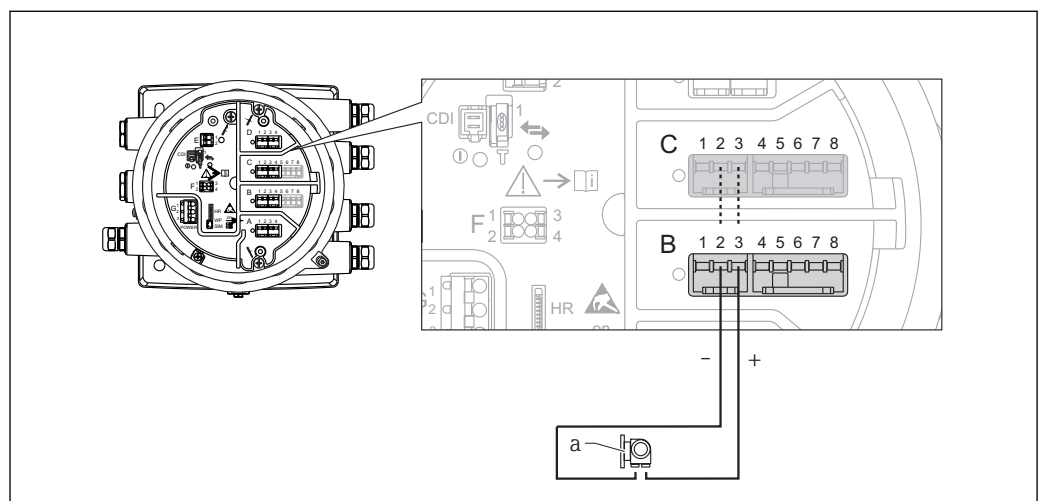

A0027935

25 Active usage of the Analog I/O module in the input mode

- a External device with 4...20mA and/or HART signal output

"Operating mode" = "HART master"

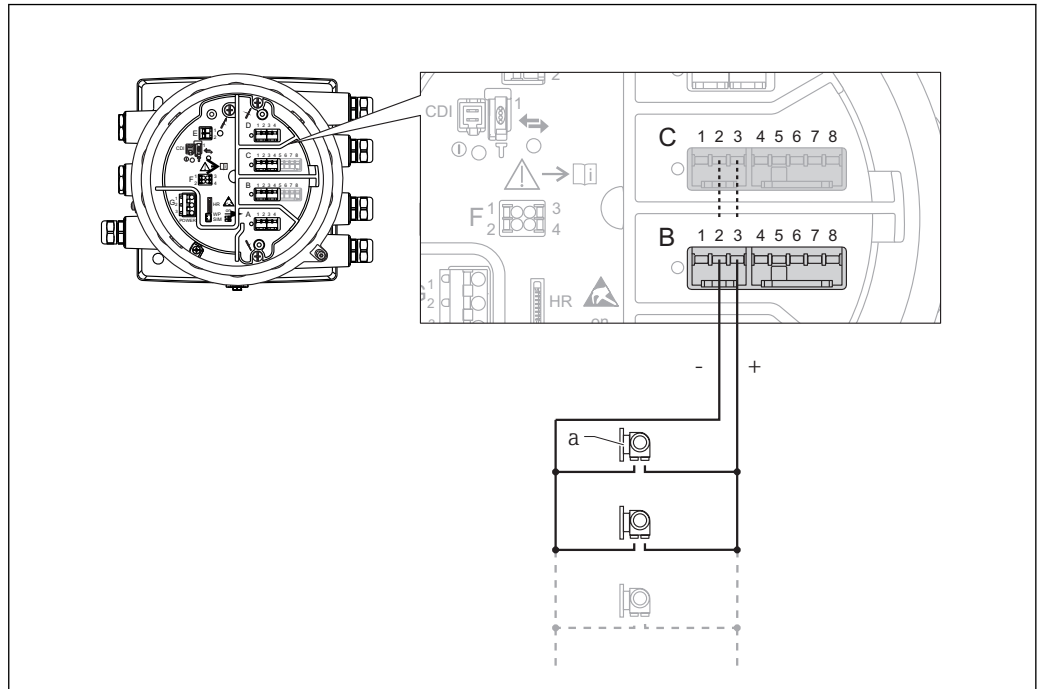

A0027936

26 Active usage of the Analog I/O module in the HART master mode

a Up to 6 external devices with HART signal output

i The maximum current consumption for the connected HART devices is 24 mA (i.e. 4 mA per device if 6 devices are connected).

6.1.9 Connection of a RTD

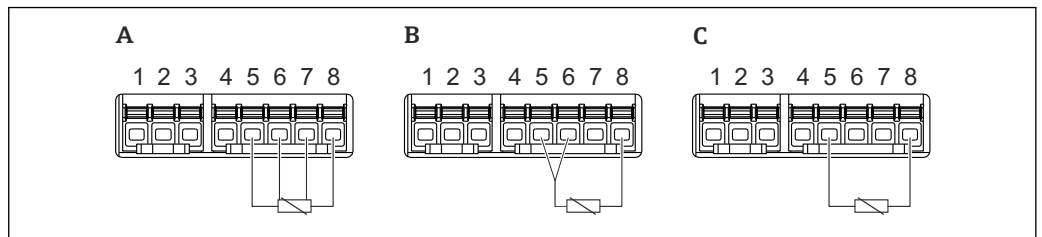

A0026371

A 4-wire RTD connection

B 3-wire RTD connection

C 2-wire RTD connection

6.1.10 Terminals of the "Digital I/O" module

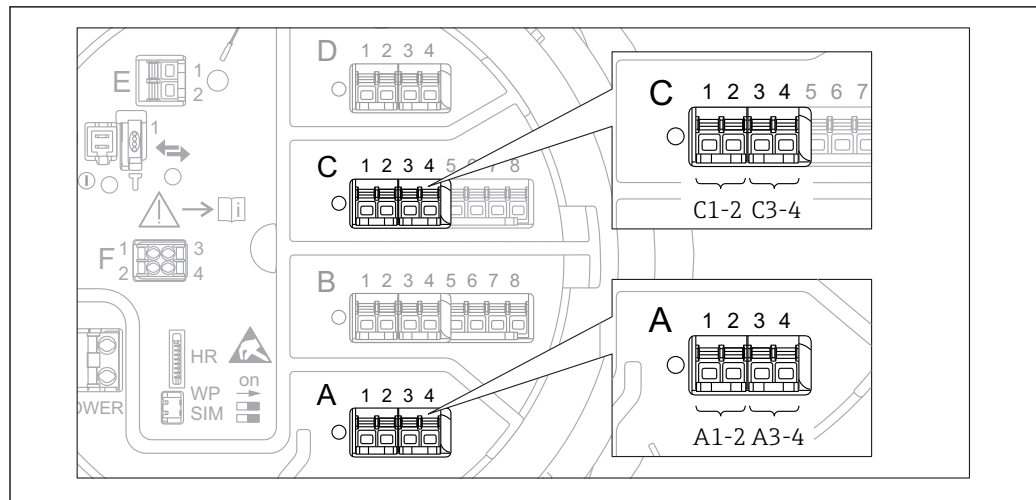

A0026424

27 Designation of the digital inputs or outputs (examples)

- Each Digital IO Module provides two digital inputs or outputs.
- In the operating menu each input or output is designated by the respective slot and two terminals within this slot. **A1-2**, for example, denotes terminals 1 and 2 of slot **A**. The same is valid for slots **B**, **C** and **D** if they contain a Digital IO module.
- For each of these pairs of terminals, one of the following operating modes can be selected in the operating menu:
 - Disable
 - Passive Output
 - Passive Input
 - Active Input

6.2 Connecting requirements

6.2.1 Cable specification

Terminals

Terminal	Wire cross section
Signal and power supply <ul style="list-style-type: none"> ▪ Spring terminals (NMx8x-xx1...) ▪ Screw terminals (NMx8x-xx2...) 	0.2 to 2.5 mm ² (24 to 13 AWG)
Ground terminal in the terminal compartment	max. 2.5 mm ² (13 AWG)
Ground terminal at the housing	max. 4 mm ² (11 AWG)

Power supply line

Standard device cable is sufficient for the power line.

HART communication line

- Standard device cable is sufficient if only the analog signal is used.
- Shielded cable is recommended if using the HART protocol. Observe the grounding concept of the plant.

Modbus communication line

- Observe the cable conditions from the TIA-485-A, Telecommunications Industry Association.
- Additional conditions: Use shielded cable.

V1 communication line

- Two wire (twisted pair) screened or un-screened cable
- Resistance in one cable: $\leq 120 \Omega$
- Capacitance between lines: $\leq 0.3 \mu\text{F}$

6.3 Ensuring the degree of protection

To guarantee the specified degree of protection, carry out the following steps after the electrical connection:

1. Check that the housing seals are clean and fitted correctly. Dry, clean or replace the seals if necessary.
2. Tighten all housing screws and screw covers.
3. Firmly tighten the cable glands.
4. To ensure that moisture does not enter the cable entry, route the cable so that it loops down before the cable entry ("water trap").

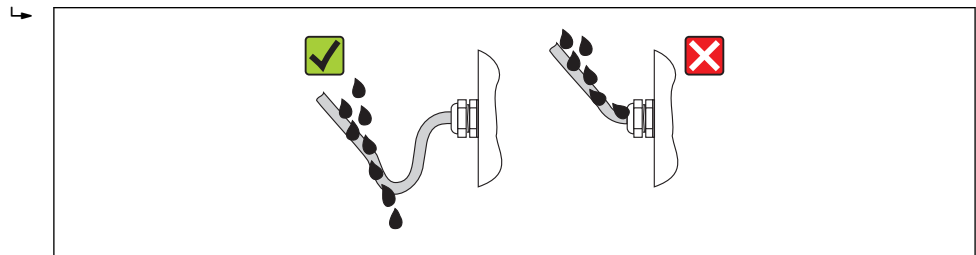

A0013960

5. Insert blind plugs appropriate for the safety rating of the device (e.g. Ex d/XP).





6.4 Post-connection check

<input type="radio"/>	Are cables or the device undamaged (visual inspection)?
<input type="radio"/>	Do the cables comply with the requirements?
<input type="radio"/>	Do the cables have adequate strain relief?
<input type="radio"/>	Are all cable glands installed, firmly tightened and correctly sealed?
<input type="radio"/>	Does the supply voltage match the specifications on the transmitter nameplate?
<input type="radio"/>	Is the terminal assignment correct → 46?
<input type="radio"/>	If required: Is the protective earth connected correctly ?
<input type="radio"/>	If supply voltage is present: Is the device ready for operation and do values appear on the display module?
<input type="radio"/>	Are all housing covers installed and firmly tightened?
<input type="radio"/>	Is the securing clamp tightened correctly?

7 Operability

7.1 Overview of the operation options

The device is operated via an operating menu →  64. This menu can be accessed by the following interfaces:

- The display and operating module at the device or the remote display and operating module DKX001 (→  66).
- FieldCare connected through the service interface in the terminal compartment of the device (→  79).
- FieldCare connected through Tankvision Tank Scanner NXA820 (remote operation; →  80).
- FieldCare connected through Commubox FXA195 (→  157) to a HART interface of the device.



Confirm that the servo motor stops before changing parameters for safety use.

7.2 Structure and function of the operating menu

Menu	Submenu / parameter	Meaning
Operation	Proservo parameters	Contains parameters to operate Proservo (e.g. Gauge command).
	Level	Shows the measured and calculated level values.
	Temperature	Shows the measured and calculated temperature values.
	Density	Shows the measured and calculated density values.
	Pressure	Shows the measured and calculated pressure values.
	GP values	Shows the general purpose values.
Setup	Standard parameters	Standard commissioning parameters
	Calibration	Calibration of the measurement
	Advanced setup	Contains further parameters and submenus: <ul style="list-style-type: none"> ▪ to adapt the device to special measuring conditions. ▪ to process the measured value. ▪ to configure the signal output.
Diagnostics	Diagnostic parameters	Indicates: <ul style="list-style-type: none"> ▪ The latest diagnostic messages and their timestamps. ▪ The operating time (overall time and time since last restart). ▪ The time according to the real-time clock.
	Diagnostic list	Contains up to 5 currently active error messages.
	Device information	Contains information needed to identify the device.
	Simulation	Used to simulate measured values or output values.
	Device check	Contains all parameters needed to check the measurement capability of the device.
Expert ¹⁾ Contains all parameters of the device (including those which are already contained in one of the other menus). This menu is organized according to the function blocks of the device. The parameter of the Expert menu are described in: GP01074G (NMS80)	System	Contains all general device parameters which do not affect the measurement or the communication interface.
	Sensor	Contains all parameters needed to configure the measurement.
	Input/output	Contains submenus to configure the analog and discrete I/O modules and connected HART devices.
	Communication	Contains all parameters needed to configure the digital communication interface.
	Application	Contains submenus to configure <ul style="list-style-type: none"> ▪ the tank gauging application ▪ the tank calculations ▪ the alarms.

Menu	Submenu / parameter	Meaning
	Tank values	Shows measured and calculated tank values
	Diagnostics	Contains all parameters needed to detect and analyze operational errors.

- 1) On entering the "Expert" menu, an access code is always requested. If a customer specific access code has not been defined, "0000" has to be entered.

7.3 Access to the operating menu via the local or remote display and operating module.

- i
 - Operating via the remote display and operating module DKX001 (→ 47) or the local display and operating module at the device are equivalent.
 - The measured value is indicated on the DKX001 and on the local display and operating module simultaneously.
 - The operating menu cannot be accessed on both modules at the same time. If the operating menu is entered in one of these modules, the other module is automatically locked. This locking remains active until the menu is closed in the first module (back to measured value display).

7.3.1 Display and operating elements

The device has an illuminated **liquid crystal display (LCD)** that shows measured and calculated values as well as the device status in the standard view. Other views are used to navigate through the operating menu and to set parameter values.

The device is operated by **three optical keys**, namely "-", "+" and "E". They are actuated when the appropriate field on the protective glass of the front is touched with the finger ("touch control").

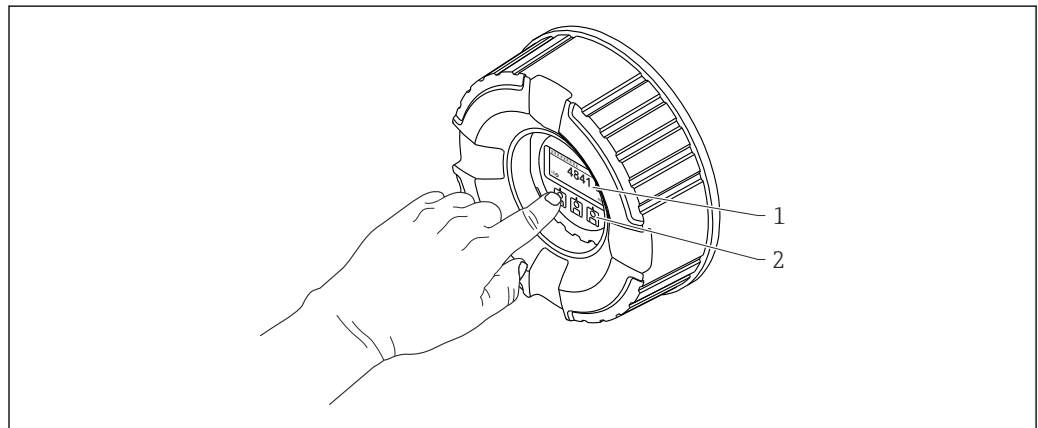

A0028345

i 28 Display and operating elements

- 1 Liquid crystal display (LCD)
- 2 Optical keys; can be operated through the cover glass.

7.3.2 Standard view (measured value display)

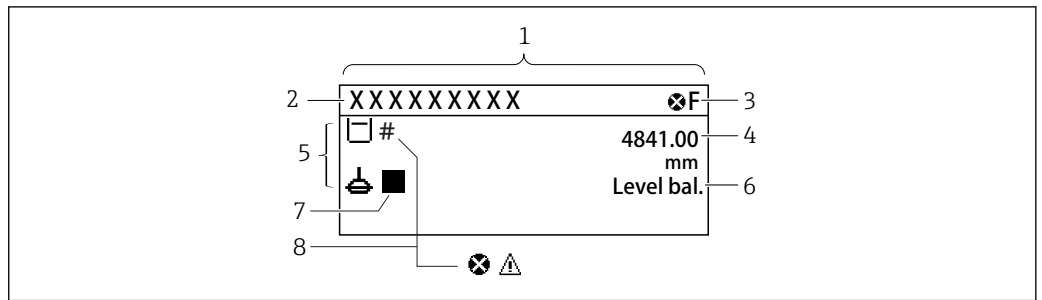

A0028702

☐ 29 Typical appearance of the standard view (measured value display)



- 1 Display module
- 2 Device tag
- 3 Status area
- 4 Display area for measured values
- 5 Display area for measured value and status symbols
- 6 Gauge status indication
- 7 Gauge status symbol
- 8 Measured value status symbol

Status symbols











Symbol	Meaning
F A0013956	"Failure" A device error is present. The measured value is no longer valid.
C A0013959	"Function check" The device is in service mode (e.g. during a simulation).
S A0013958	"Out of specification" The device is operated: <ul style="list-style-type: none"> ▪ Outside of its technical specifications (e.g. during startup or a cleaning) ▪ Outside of the configuration carried out by the user (e.g. level outside configured span)
M A0013957	"Maintenance required" Maintenance is required. The measured value is still valid.

Measured value symbols





Symbol 1	Symbol 2	Measured value
 A0028148		<ul style="list-style-type: none"> ▪ Tank level ▪ Measured level ▪ Tank level %
 A0028149		Water level
T A0028528		Liquid temperature
T A0028528	V A0027990	Vapor temperature
T A0028528	A A0027991	Air temperature
 A0027993		<ul style="list-style-type: none"> ▪ Tank ullage ▪ Tank ullage %
ρ A0028150		Observed density value

Symbol 1	Symbol 2	Measured value
 A0028150	 A0027991	Average profile density
 A0028151	 A0028141	P1 (bottom)
 A0028151	 A0028142	P2 (middle)
 A0028151	 A0028146	P3 (top)
 A0027992	 A0028141	GP 1 value This is used for an external device.
 A0027992	 A0028142	GP 2 value This is used for an external device.
 A0027992	 A0028146	GP 3 value This is used for an external device.
 A0027992	 A0028147	GP 4 value This is used for an external device.
 A0028149	 A0028529	Upper I/F level
 A0028149	 A0027989	Lower I/F level
 A0028150	 A0028529	Upper density
 A0028150	 A0013957	Middle density
 A0028150	 A0027989	Lower density
 A0028145		Bottom level
 A0027994		Displacer position



Gauge command and gauge status symbols

Symbol 1	Symbol 2	Meaning
 A0028139		Gauge command This shows current command.
 A0028143	 A0028144	Gauge status  : Displacer is unbalanced (Level/Interface not found yet).  : Displacer is balanced (Level/Interface measurement valid).  : Displacer is moving up.  : Displacer is moving down.  : Displacer stopped.
 A0027995	 A0028138	
 A0028140		

Measured value status symbols

Symbol	Meaning
 A0012102	Status "Alarm" The measurement is interrupted. The output assumes the defined alarm value. A diagnostic message is generated.
 A0012103	Status "Warning" The device continues measuring. A diagnostic message is generated.
 A0031169	Calibration to regulatory standards disturbed Is displayed in the following situations: <ul style="list-style-type: none"> ▪ The write protection switch is OFF. →  77 ▪ The write protection switch is ON but the level value can currently not be guaranteed because the displacer is not balanced.

Locking state symbols

Symbol	Meaning
 A0011978	Display parameter Marks display-only parameters which cannot be edited.
 A0011979	Device locked <ul style="list-style-type: none"> ▪ In front of a parameter name: The device is locked via software and/or hardware. ▪ In the header of the measured value screen: The device is locked via hardware.

Meaning of the keys in the standard view

Key	Meaning
 A0028326	Enter key <ul style="list-style-type: none"> ▪ Pressing the key briefly opens the operating menu. ▪ Pressing the key for 2 s opens the context menu: <ul style="list-style-type: none"> - Level (visible if the keylock is inactive): Shows the measured levels. - Keylock on (visible if the keylock is inactive): Activates the keylock. - Keylock off (visible if the keylock is active): Deactivates the keylock.

7.3.3 Navigation view

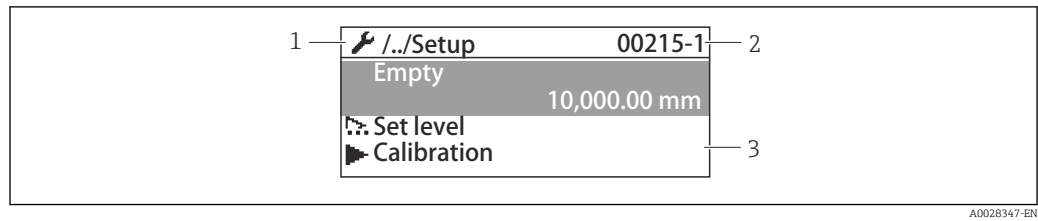

A0028347-EN





30 Navigation view

- 1 Current submenu or wizard
- 2 Quick access code
- 3 Display area for navigation

Navigation symbols

Symbol	Meaning
 A0011975	Operation Is displayed: <ul style="list-style-type: none"> ▪ in the main menu next to the selection Operation ▪ in the header, if you are in the Operation menu.
 A0011974	Setup Is displayed: <ul style="list-style-type: none"> ▪ in the main menu next to the selection Setup ▪ in the header, if you are in the Setup menu
 A0011976	Expert Is displayed: <ul style="list-style-type: none"> ▪ in the main menu next to the selection Expert ▪ in the header, if you are in the Expert menu
 A0011977	Diagnostics Is displayed: <ul style="list-style-type: none"> ▪ in the main menu next to the selection Diagnostics ▪ in the header, if you are in the Diagnostics menu
 A0013967	Submenu
 A0013968	Wizard
 A0013963	Parameter locked When displayed in front of a parameter name, indicates that the parameter is locked.

Meaning of the keys in the navigation view

Key	Meaning
 <p style="text-align: right; font-size: small;">A0028324</p>	<p>Minus key Moves the selection bar upwards in a picklist.</p>
 <p style="text-align: right; font-size: small;">A0028325</p>	<p>Plus key Moves the selection bar downwards in a picklist.</p>
 <p style="text-align: right; font-size: small;">A0028326</p>	<p>Enter key</p> <ul style="list-style-type: none"> ▪ Pressing the key briefly opens the selected menu, submenu or parameter. ▪ For parameters: Pressing the key for 2 s opens the help text for the function of the parameter (if present).
 <p style="text-align: right; font-size: small;">A0028327</p>	<p>Escape key combination (press keys simultaneously)</p> <ul style="list-style-type: none"> ▪ Pressing the keys briefly <ul style="list-style-type: none"> - Exits the current menu level and takes you to the next higher level. - If help text is open, closes the help text of the parameter. ▪ Pressing the keys for 2 s returns you to the measured value display ("standard view").

7.3.4 Wizard view

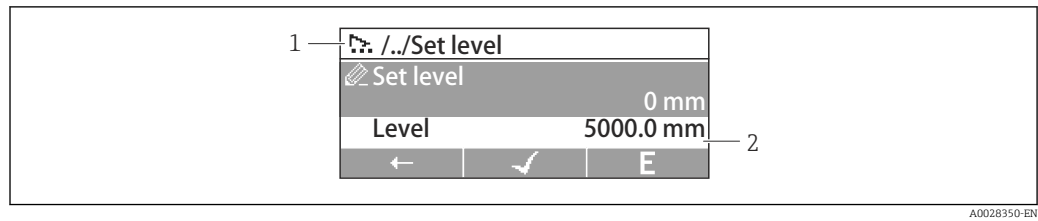





A0028350-EN

31 Wizard view on the display module

- 1 Current wizard
- 2 Display area for navigation

Wizard navigation symbols

Symbol	Meaning
 A0013972	Parameters within a wizard
 A0013978	Switches to the previous parameter.
 A0013976	Confirms the parameter value and switches to the next parameter.
 A0013977	Opens the editing view of the parameter.

 In the wizard view the meaning of the keys is indicated by the navigation symbol directly above the respective key (softkey functionality).



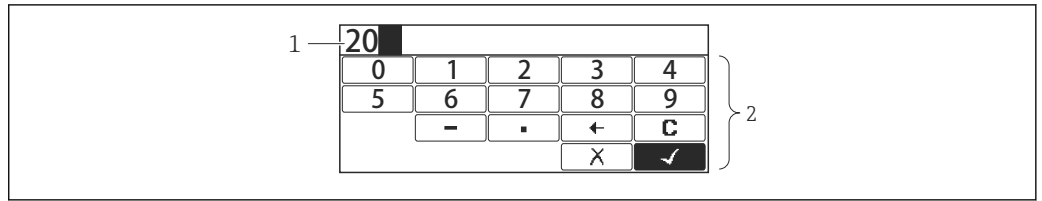



7.3.5 Numeric editor







A0028341

32 Numeric editor on the display module

- 1 Display area of the entered value
- 2 Input mask

Symbol	Meaning
 <p>A0013998</p>	Selection of numbers from 0 to 9.
 <p>A0016619</p>	Inserts decimal separator at the input position.
 <p>A0016620</p>	Inserts minus sign at the input position.
 <p>A0013985</p>	Confirms selection.
 <p>A0016621</p>	Moves the input position one position to the left.
 <p>A0013986</p>	Exits the input without applying the changes.
 <p>A0014040</p>	Clears all entered characters.

Meaning of the keys in the numeric editor

Key	Meaning
 <p>A0028324</p>	Minus key In the input mask, moves the selection bar to the left (backwards).
 <p>A0028325</p>	Plus key In the input mask, moves the selection bar to the right (forwards).
 <p>A0028326</p>	Enter key <ul style="list-style-type: none"> ■ Pressing the key briefly adds the selected number to the current decimal place or carries out the selected action. ■ Pressing the key for 2 s confirms the edited parameter value.
 <p>A0028327</p>	Escape key combination (press keys simultaneously) Closes the text or numeric editor without applying changes.

7.3.6 Text editor

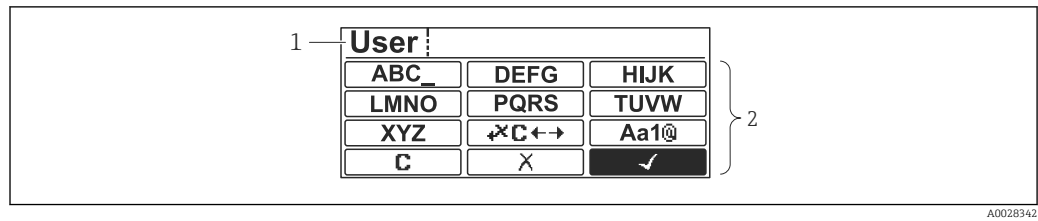

A0028342

33 Text editor on the display module

- 1 Display area of the entered text
- 2 Input mask





Text editor symbols

Symbol	Meaning
 ... A0013997	Selection of letters from A to Z
 A0013981	Toggle <ul style="list-style-type: none"> ▪ Between upper-case and lower-case letters ▪ For entering numbers ▪ For entering special characters
 A0013985	Confirms selection.
 A0013987	Switches to the selection of the correction tools.
 A0013986	Exits the input without applying the changes.
 A0014040	Clears all entered characters.

Correction symbols under ✕C↔

 A0013989	Clears all entered characters.
 A0013991	Moves the input position one position to the right.
 A0013990	Moves the input position one position to the left.
 A0013988	Deletes one character immediately to the left of the input position.

Meaning of the keys in the text editor

Key	Meaning
 <small>A0028324</small>	Minus key In the input mask, moves the selection bar to the left (backwards).
 <small>A0028325</small>	Plus key In the input mask, moves the selection bar to the right (forwards).
 <small>A0028326</small>	Enter key <ul style="list-style-type: none"> ▪ Pressing the key briefly <ul style="list-style-type: none"> - Opens the selected group. - Carries out the selected action. ▪ Pressing the key for 2 s confirms the edited parameter value.
 <small>A0028327</small>	Escape key combination (press keys simultaneously) Closes the text or numeric editor without applying changes.

7.3.7 Keypad lock

Automatic keypad lock

Operation via the local display is automatically locked:

- after a start-up or restart of the device.
- if the device has not been operated via the display for > 1 minute.

 When attempting to access the operating menu while the keylock is enabled, the **Keylock on** message appears.

Disabling the keypad lock

1. The keylock is enabled.
 Press  for at least 2 seconds.
 ↳ A context menu appears.
2. Select **Keylock off** from the context menu.
 ↳ The keylock is disabled.

Manual activation of the keypad lock

After commissioning of the device the keypad lock can be activated manually.

1. The device is in the measured value display.
 Press  for at least 2 seconds.
 ↳ A context menu appears.
2. Select **Keylock on** from the context menu.
 ↳ The keylock is enabled.

7.3.8 Access code and user roles

Meaning of the access code

An access code can be defined in order to distinguish between the following user roles:

User role	Definition
Maintenance	<ul style="list-style-type: none"> ▪ Knows the access code. ▪ Has write access to all parameters (except service parameters).
Operator	<ul style="list-style-type: none"> ▪ Doesn't know the access code. ▪ Has write access to only a few parameters.



-  The description of parameters states which role is needed at least for read and write access to each parameter.
- The current user role is indicated by the **Access status display** parameter.
- If the access code is "0000", every user is in the **Maintenance** role. This is the default setting on delivery of the device.

Defining an access code

1. Navigate to: Setup → Advanced setup → Administration → Define access code → Define access code
2. Enter the intended access code (max. 4 digits).
3. Repeat the same code in the **Confirm access code** parameter.
 - ↳ The user is in the **Operator** role. The -symbol appears in front of all write-protected parameters.

Switching to the "Maintenance" role

If the -symbol appears on the local display in front of a parameter, the parameter is write-protected because the user is in the **Operator** role. To switch to the **Maintenance** role, proceed as follows:

1. Press .
 - ↳ The input prompt for the access code appears.
2. Enter the access code.
 - ↳ The user is in the **Maintenance** role. The -symbol in front of the parameters disappears; all previously write-protected parameters are now re-enabled.

Switching back to the "Operator" role automatically

The user automatically switches back to the **Operator** role:

- if no key is pressed for 10 minutes in the navigation and editing mode.
- 60 s after going back from the navigation and editing mode to the standard view (measured value display).

7.3.9 Write protection switch

The operating menu can be locked by a hardware switch in the connection compartment. In this locking state W&M related parameters are read only.

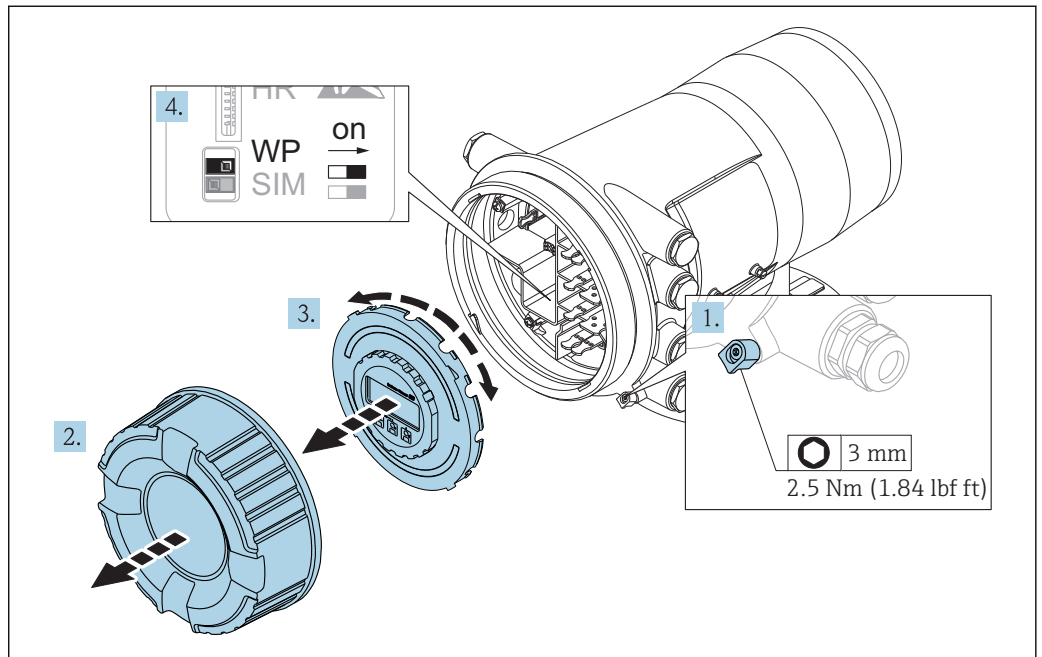

A0030122

1. Loosen the securing clamp.
2. Unscrew the housing cover.
3. Pull out the display module with a gentle rotation movement.
4. Using a flat blade screwdriver or a similar tool, set the write protection switch (**WP**) into the desired position. **ON**: operating menu is locked; **OFF**: operating menu is unlocked.
5. Put the display module onto the connection compartment, screw the cover closed and tighten the securing clamp.

i To avoid access to the write protection switch, the cover of the connection compartment can be secured by a lead seal.

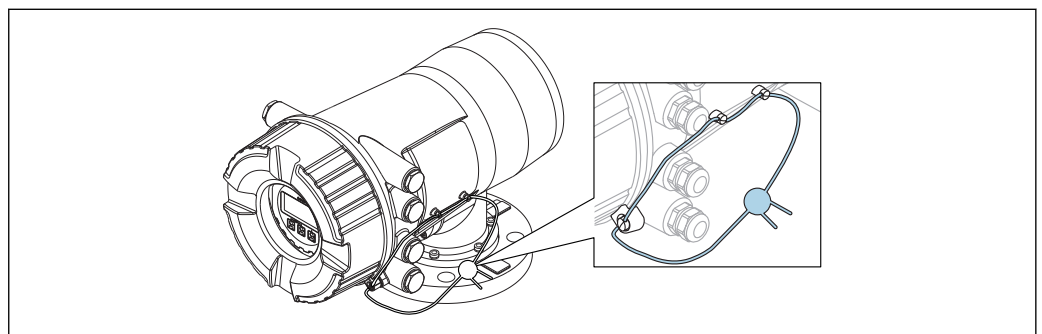

A0033284

i The display module can be attached to the edge of the electronics compartment. This makes it easier to access the lock switch.

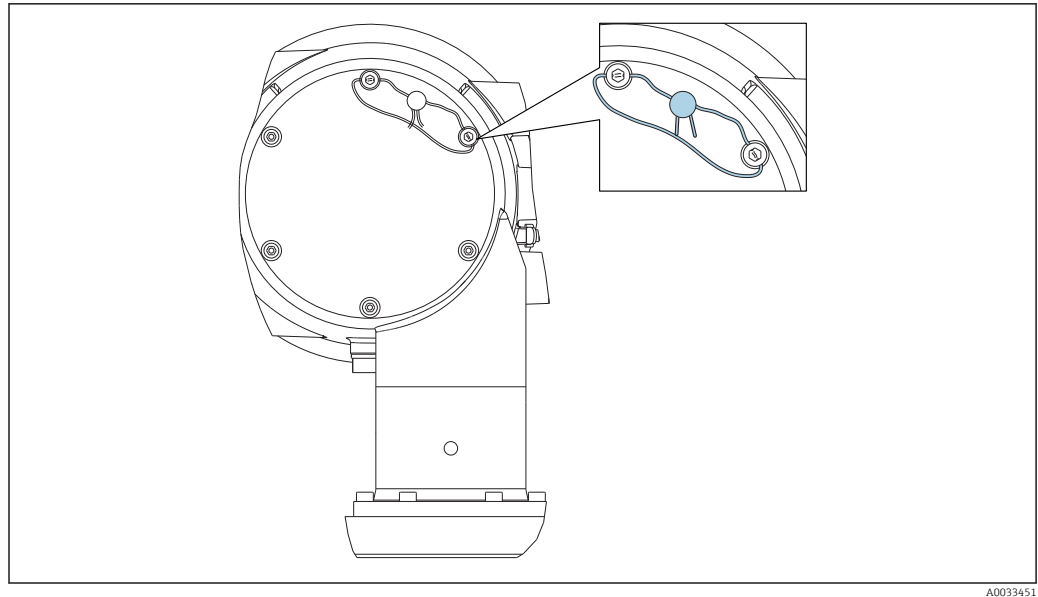

A0033451

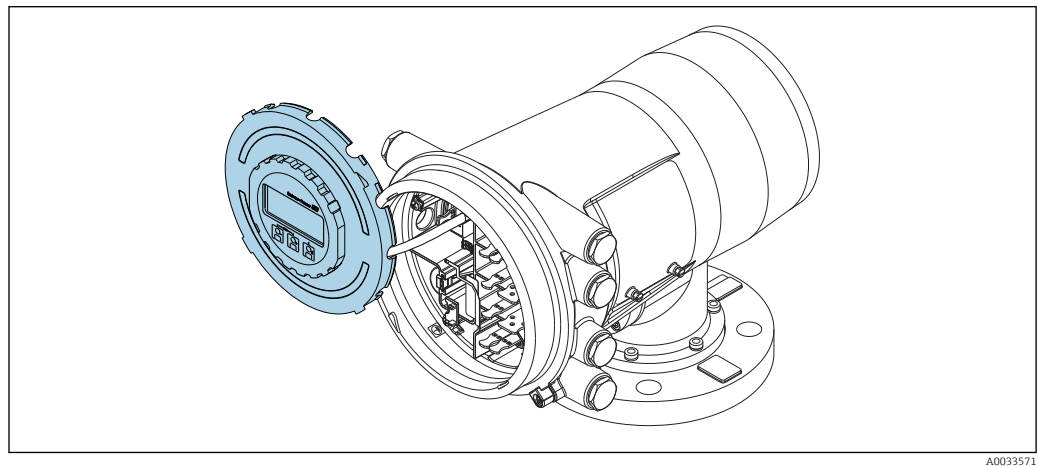

A0033571

▣ 34 NMS80: Display module attached to the edge of the terminal compartment

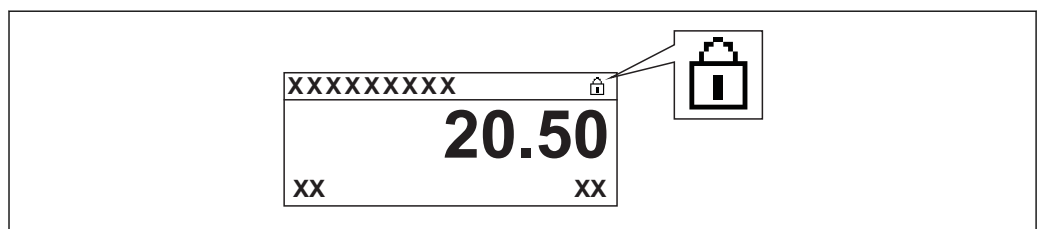

Indication of the locking state



A0015870

▣ 35 Write protection symbol in the header of the display

Write protection via locking switch is indicated as follows:

- **Locking status** (→  199) = **Hardware locked**
-  appears in the header of the display.

7.4 Access to the operating menu via the service interface and FieldCare

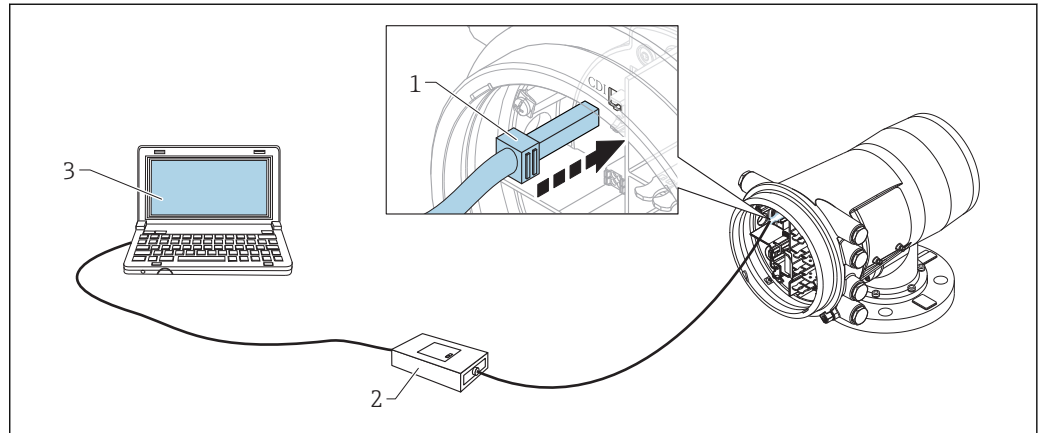

A0030161

 36 Operation via service interface

- 1 Service interface (CDI = Endress+Hauser Common Data Interface)
- 2 Combox FXA291
- 3 Computer with "FieldCare" operating tool and "CDI Communication FXA291" COM DTM



The "Save/Restore" function

After a device configuration has been saved to a computer and restored to the device using the **Save/Restore** function of FieldCare, the device must be restarted by the following setting:

Setup → **Advanced setup** → **Administration** → **Device reset** = **Restart device**.

This ensures correct operation of the device after the restore.

7.5 Access to the operating menu via Tankvision Tank Scanner NXA820 and FieldCare

7.5.1 Wiring scheme

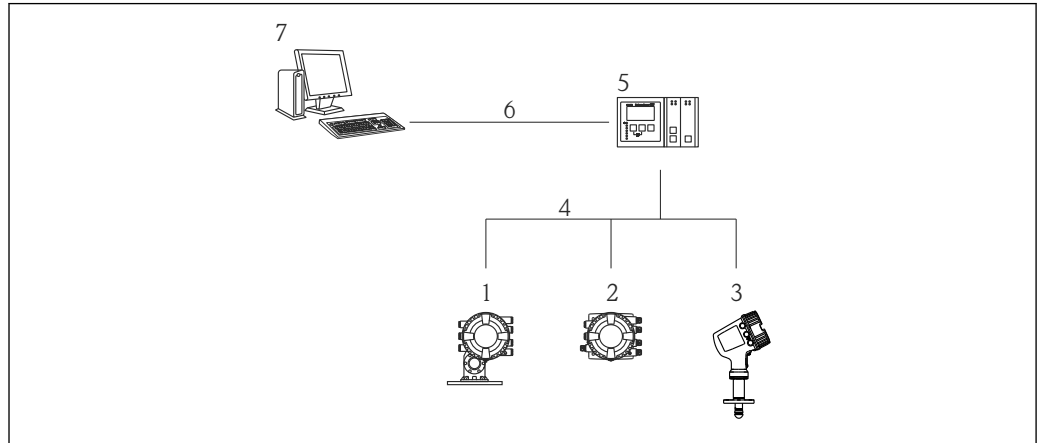

A0025621

37 Connection of Tank Gauging devices to FieldCare via the Tankvision Tank Scanner NXA820

- 1 Proservo NMS8x
- 2 Tankside Monitor NRF81
- 3 Micropilot NMR8x
- 4 Field protocol (e.g. Modbus, V1)
- 5 Tankvision Tank Scanner NXA820
- 6 Ethernet
- 7 Computer with FieldCare installed

7.5.2 Establishing the connection between FieldCare and the device

1. Make sure the **HART CommDTM NXA** is installed and update the DTM catalogue if required.
2. Create a new project in FieldCare.
- 3.

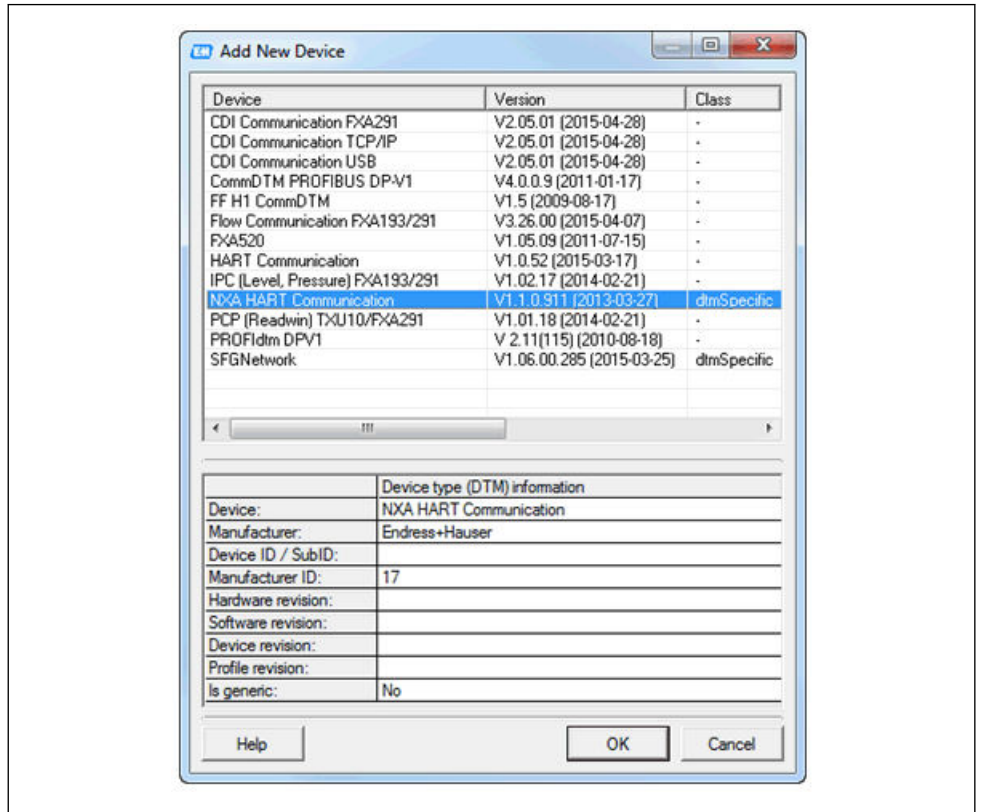

A0028515

Add a new device: **NXA HART Communication**

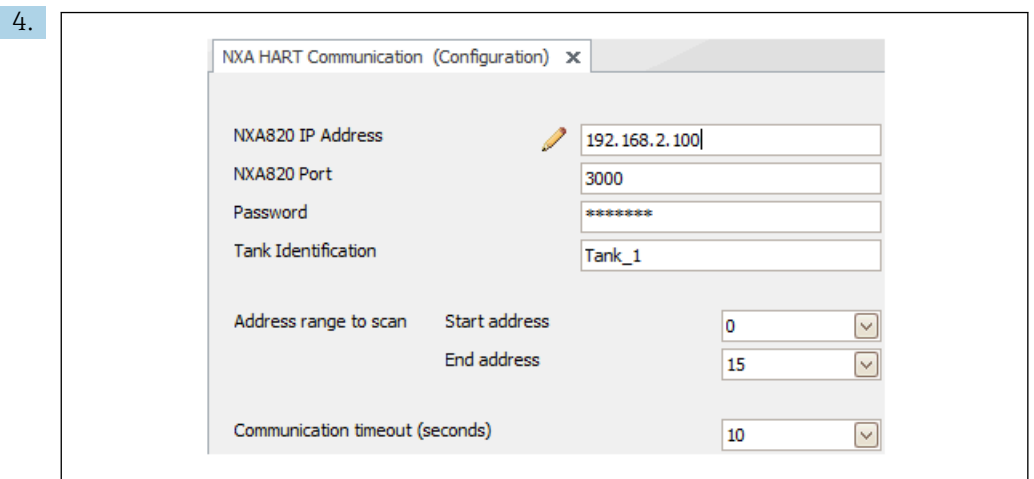

A0028516

Open the configuration of the DTM and enter the required data (IP address of the NXA820; "Password" = "hart"; "Tank identification" only with NXA V1.05 or higher)

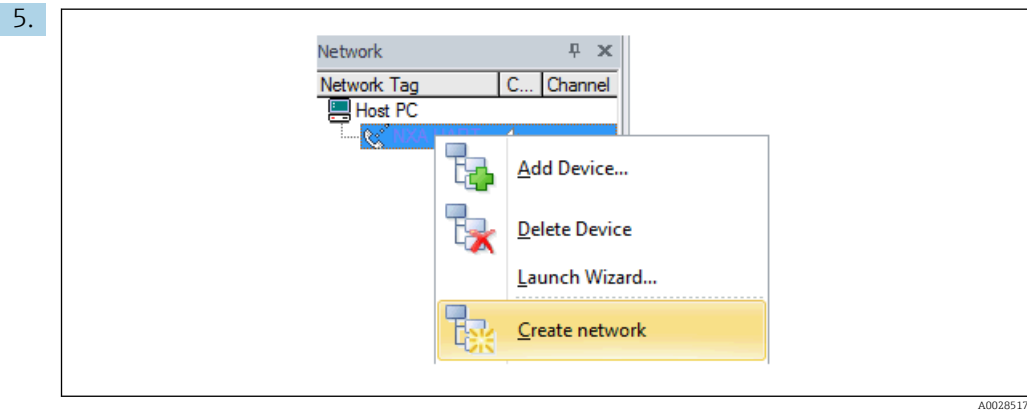

Select **Create network** from the context menu.

↳ The device is detected and the DTM is assigned.

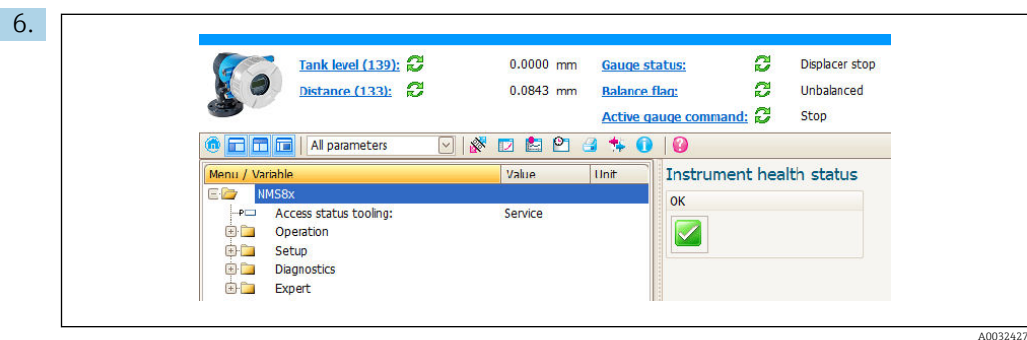

↳ The device can be configured.

i The "Save/Restore" function

After a device configuration has been saved to a computer and restored to the device using the **Save/Restore** function of FieldCare, the device must be restarted by the following setting:

Setup → **Advanced setup** → **Administration** → **Device reset** = **Restart device**.

This ensures correct operation of the device after the restore.

8 System integration

8.1 Overview of the Device Description files (DTM)

To integrate the device via HART into FieldCare, a Device Description file (DTM) according to the following specification is required:

Manufacturer ID	0x11
Device type (NMS8x)	0x112D
HART specification	7.0
DD files	For information and files see: www.endress.com

9 Commissioning

9.1 Terms related to tank measurement

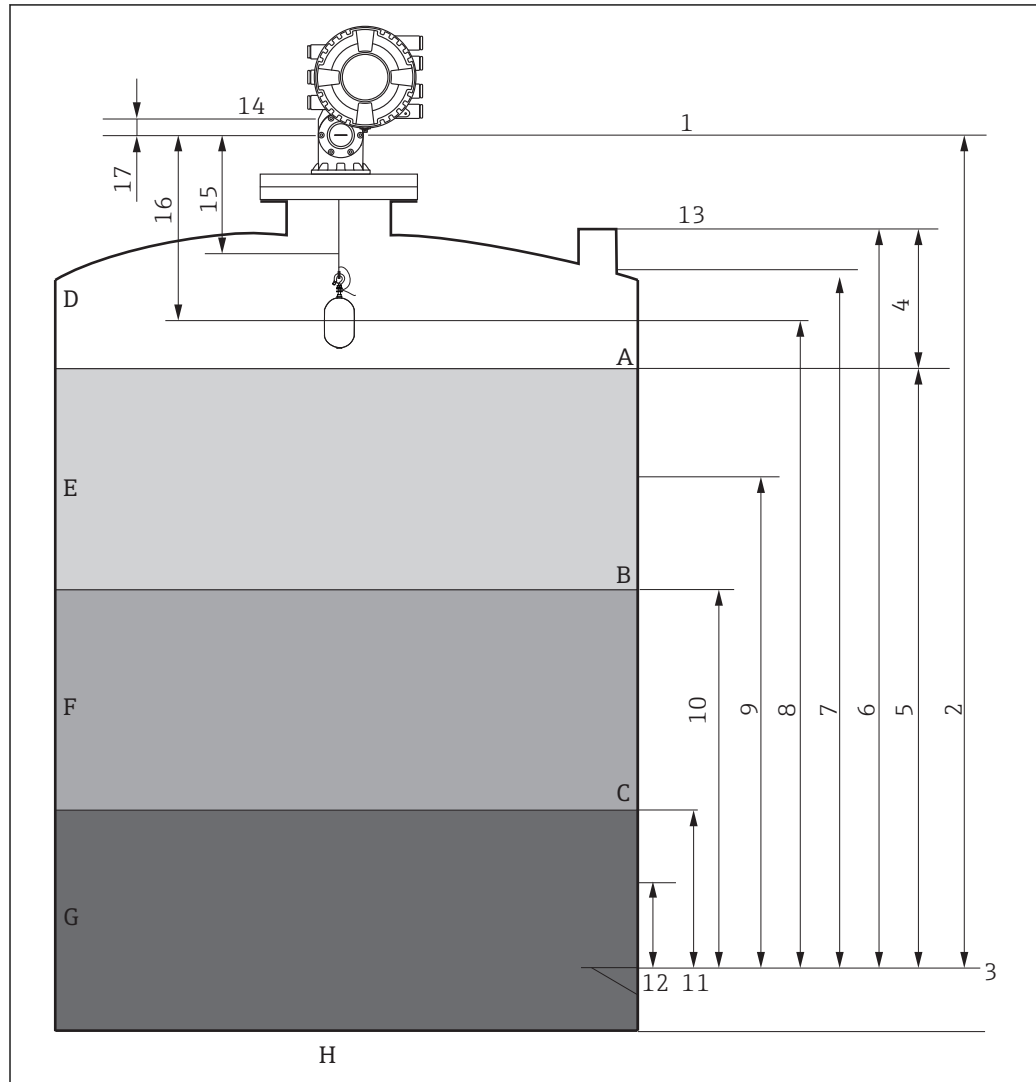

A0026916

38 Terms concerning NMS8x installation (e.g. NMS81)

- A Liquid level
- B Upper interface
- C Lower interface
- D Gas phase
- E Upper phase
- F Middle phase
- G Lower phase
- H Tank bottom
- 1 Gauge reference height
- 2 Empty
- 3 Datum plate
- 4 Tank ullage
- 5 Tank level
- 6 Tank reference height
- 7 High stop level
- 8 Displacer position
- 9 Standby level
- 10 Upper interface level
- 11 Lower interface level
- 12 Low stop level
- 13 Dipping reference

- 14 Mechanical stop
- 15 Slow hoist zone
- 16 Distance
- 17 Reference position

9.2 Initial settings

Depending on NMS8x specification, some of the initial settings described below may not be required.

9.2.1 Setting the display language

Setting the display language via the display module

1. While in the standard view (→  67), press "E". If required, select **Keylock off** from the context menu and press "E" again.
 - ↳ The **Language** parameter appears.
2. Open the **Language** parameter and select the display language.

Setting the display language via an operating tool (e.g. FieldCare)

1. Navigate to: Setup → Advanced setup → Display → Language
2. Select the display language.

 This setting only affects the language on the display module. To set the language in the operating tool use the language setting functionality of FieldCare or DeviceCare, respectively.

9.2.2 Setting the real-time clock

Setting the real-time clock via the display module

1. Navigate to: Setup → Advanced setup → Date / time → Set date
2. Use the following parameters to set the the real-time clock to the current date and time: **Year, Month, Day, Hour, Minutes**.

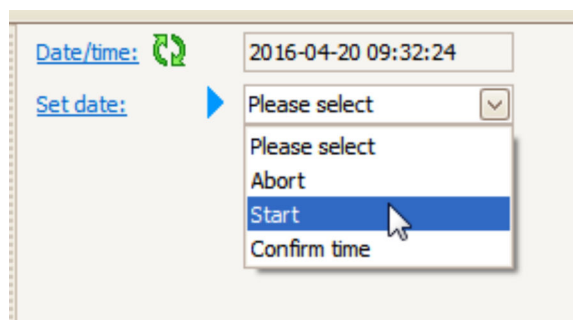

Setting the real-time clock via an operating tool (e.g. FieldCare)

1. Navigate to: Setup → Advanced setup → Date / time
- 2.







Go to the **Set date** parameter and select the **Start** option.

3.

Date/time:		2016-04-20 09:34:25
Set date:	 	Please select <input type="button" value="v"/>
Year:		2016
Month:		4
Day:		20
Hour:		9
Minute:		34

Use the following parameters to set the date and time: **Year, Month, Day, Hour, Minutes.**

4.

Date/time:		2016-04-20 09:35:49
Set date:	 	Please select <input type="button" value="v"/>
Year:		Please select
Month:		Abort
Day:		Start
Hour:		Confirm time 
Minute:		9
		34

Go to the **Set date** parameter and select the **Confirm time** option.

↳ The real-time clock is set to the current date and time.

9.3 Calibration

After installing or replacing NMS8x or its parts (sensor module, detector unit, wire drum, or measuring wire), several calibration steps are required. All calibration steps may not be required, depending on whether the device is being installed, adjusted, or replaced (see table below).

Type of installation/replacement	Calibration step		
	Sensor calibration	Reference calibration	Drum calibration
All-in one	Not required	Not required	Not required
Displacer shipped separately	Required	Required	Required
Displacer installation through calibration window	Required	Required	Required
Replacement/ maintenance	Drum	Required	Required
	Displacer	Not required	Required
	Sensor module	Not required	Required
	Detector unit	Required	Required

9.3.1 Verification of displacer and wire drum

Prior to installation of NMS8x, confirm that all of the following data of the displacer and the wire drum on the nameplate match with those programmed into the device.

Parameters to be confirmed

Parameters	Navigate to:
Displacer diameter	Setup → Advanced setup → Sensor config → Displacer → Displacer diameter
Displacer weight	Setup → Advanced setup → Sensor config → Displacer → Displacer weight
Displacer volume	Setup → Advanced setup → Sensor config → Displacer → Displacer volume
Displacer balance volume	Setup → Advanced setup → Sensor config → Displacer → Displacer balance volume
Drum circumference	Setup → Advanced setup → Sensor config → Wire drum
Wire weight	Expert → Sensor → Sensor config → Wire drum → Wire weight

Data verification

Data verification procedure

1. Check the displacer diameter, weight, volume, and balance volume for the **Displacer diameter** parameter, the **Displacer weight** parameter, the **Displacer volume** parameter, and the **Displacer balance volume** parameter.
2. Check the drum circumference and wire weight for the **Drum circumference** parameter and **Wire weight** parameter.

This completes the data verification procedure.

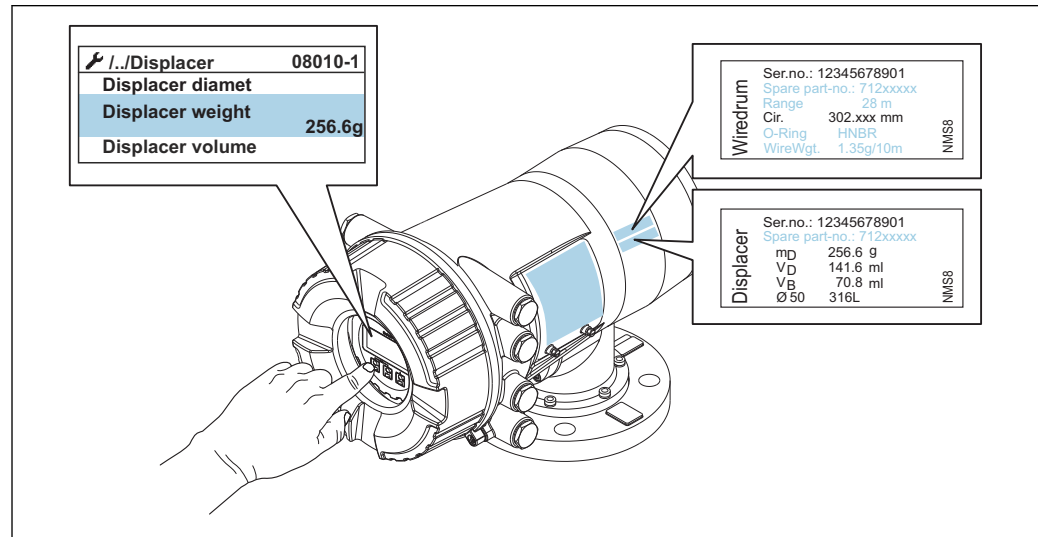

A0030107

39 Data verification

9.3.2 Move displacer

The move displacer operation is optional and can be used to change the current position of the displacer in order to perform the calibration steps more easily.

1. Make sure that the wire drum stopper has been removed.
2. Navigate to: Setup → Calibration → Move displacer → Move distance
3. Input the relative moving distance for the **Move distance** parameter.
4. Select the **Move down** option or the **Move up** option
5. Select the **Yes**.

This completes move displacer commands procedure.

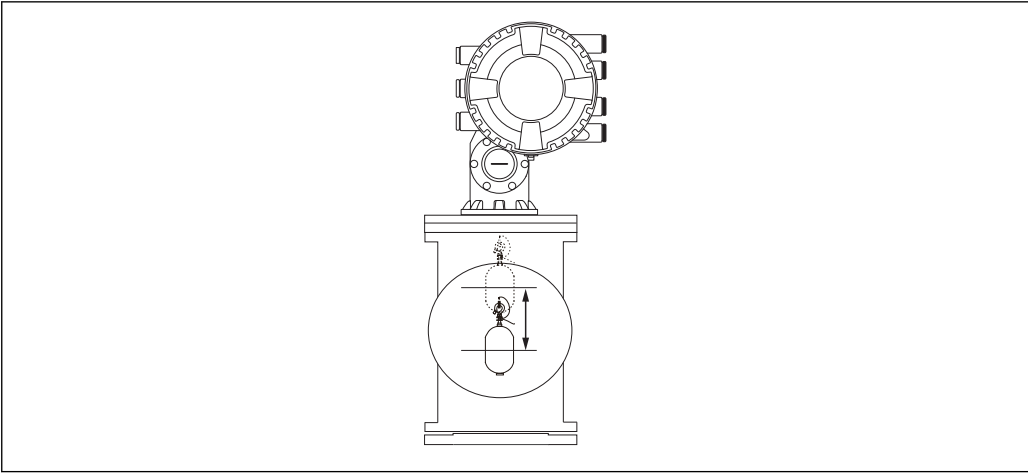

A0029119

40 Move displacer

9.3.3 Sensor calibration

Sensor calibration adjusts the weight measurement of the detector unit. The calibration consists of three steps as follows.

- ADC zero calibration
- ADC offset calibration
- ADC span calibration

For the ADC offset weight calibration, either 0 g or an offset weight (0 to 100 g) can be used.

 Using an offset weight other than 0 g is recommended for density measurement.

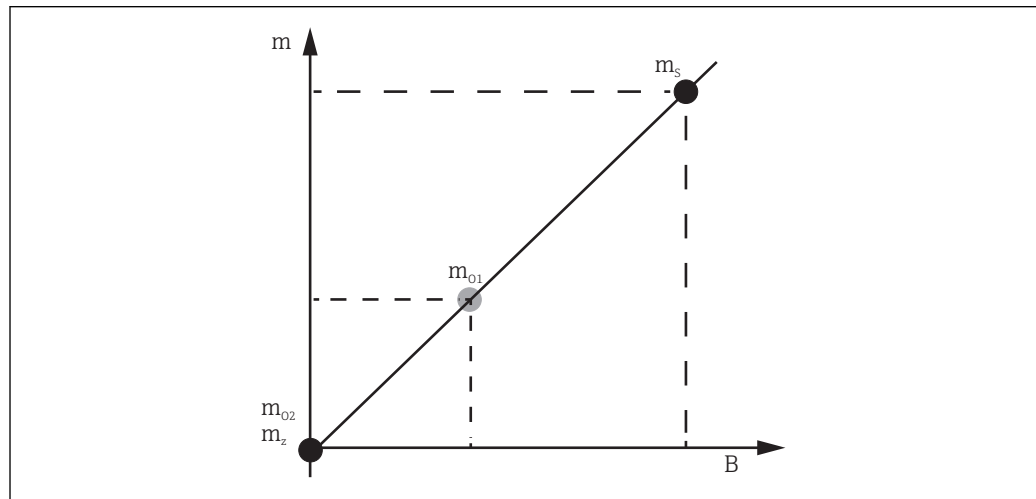











A0029472

 41 Concept of sensor calibration

- m Weight of displacer
- B Binary value of AD-Converter
- m_s Span weight
- m_{o1} Offset weight in case of 0 to 100 g (50 g is recommended.)
- m_{o2} Offset weight in case of 0 g
- m_z Zero weight

Calibration procedure

Step	Using displacer	Using offset weight	Description
1.	 A0028000	 A0028000	<ul style="list-style-type: none"> ▪ Navigate to: Setup → Calibration → Sensor calibration → Sensor calibration ▪ Input the offset weight for the Offset weight parameter used in step 3 (0.0 g in case of using the displacer only). ▪ Input the value for the Span weight parameter used in step 4 (weight of displacer indicated on nameplate).
2.	 A0027999	 A0028001	<ul style="list-style-type: none"> ▪ Hold up or remove the displacer. ▪ Select <input checked="" type="checkbox"/> for next parameter. ▪ Measuring zero weight option is shown on the display. ▪ Wait until the Zero calibration parameter shows the Finished option and calibration status shows Idle. <p> When the displacer is being held up, do not release it until this step is completed.</p>
3.	 A0027999	 A0028002	<ul style="list-style-type: none"> ▪ Confirm that the Offset calibration parameter shows the Place offset weight option. ▪ Hold up the displacer or attach the offset weight. ▪ Select <input checked="" type="checkbox"/> for next parameter. ▪ Measuring offset weight option is shown on the display. ▪ Wait until the Offset calibration parameter shows the Finished option and Calibration status shows Idle. <p> When the displacer is being held up, do not release it until this step is completed.</p>
4.	 A0028000	 A0028000	<ul style="list-style-type: none"> ▪ Release the displacer or mount it on the measuring ring if an offset weight was used in the previous step. ▪ Select <input checked="" type="checkbox"/> for next parameter. ▪ Measuring span weight option is shown on the display. ▪ Confirm that the Span calibration parameter shows the Finished option and Calibration status shows Idle. ▪ Select the Next option. ▪ Confirm that the Sensor calibration parameter shows the Calibration finished option and Calibration status shows Idle. <p>This completes sensor calibration procedure.</p> <p> Do not swing the displacer and keep it in as stable a position as possible.</p>

9.3.4 Reference calibration

The reference calibration defines the zero distance position of the displacer from the mechanical stop.

1. Navigate to: Setup → Calibration → Reference calibration → Reference calibration
2. Select the **Start** option
3. Check the reference position (e.g. 70 mm (2.76 in)).
↳ The reference position is preset prior to delivery.
4. Confirm that the displacer is correctly attached to the measuring wire.
5. The reference calibration starts automatically.

This completes the reference calibration.

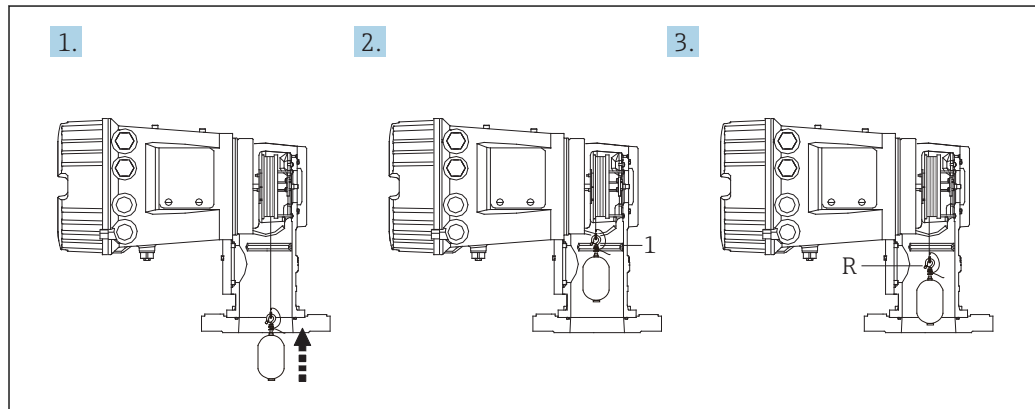

A0030162

42 Reference calibration sequence

- 1 Mechanical stop
R Reference position

9.3.5 Drum calibration

1. Navigate to: Setup → Calibration → Drum calibration → Drum calibration
2. Ensure a distance of 500 mm (19.69 in) or more from the bottom of the displacer to the liquid level.
3. Confirm that the displacer weight is correct for the **Set high weight** parameter.
4. Select the **Start** option.
 - ↳ The drum calibration starts automatically.
The drum calibration records fifty points which will take approximately eleven minutes.
5. Select the **No** option as usual for the **Make low table** parameter.
 - ↳ To make a low table for special applications, select the **Yes** and use 50 g weight.

This completes drum calibration procedure.

- i** To cancel any calibration, press $\square + \oplus$ simultaneously. If the drum calibration is canceled while making the new table, the old table remains effective. If making a new table fails due to an obstruction, NMS8x will not accept the new table and shows an error message.

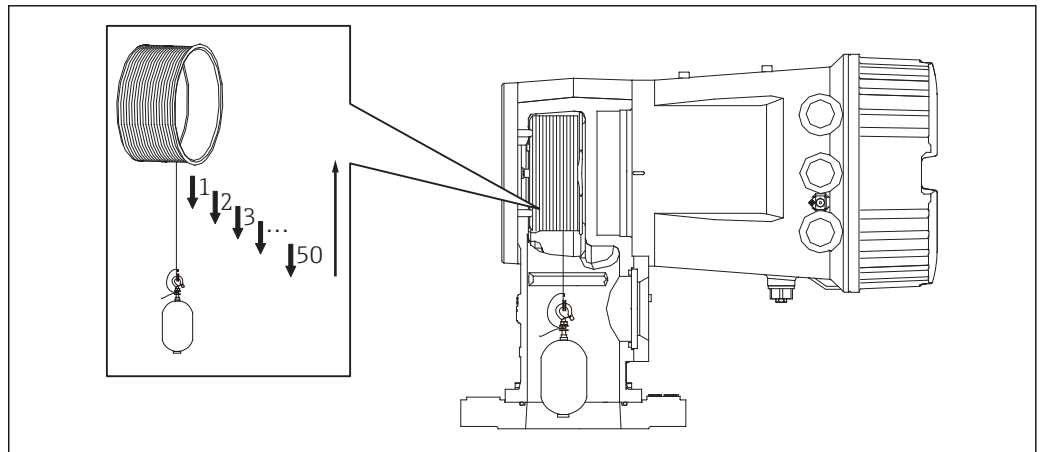

i 43 Making drum table

A0030163

9.3.6 Commissioning check

This procedure is to confirm that all calibration steps have been completed appropriately.

1. Navigate to: Diagnostics → Device check → Commissioning check → Commissioning check
2. Select the **Start** option.
 - ↳ **Executing** option is shown on the verify drum table.
3. Select the **Next** option.
4. Confirm that the **Commissioning check** wizard shows the **Finished** option.
5. Confirm that the **Result drum check** parameter is passed.

This completes the commissioning check procedure.

9.4 Configuring the measuring device

Configuration task	Description
Configuring the level and interface measurement	Setting density → 95
	Setting tank height → 96
	Setting high and low stop → 97
Level calibration	Setting for open tank with liquid → 98
	Setting for open tank without liquid → 99
	Setting for closed tank → 100
	Setting process condition → 101
Configuring the density measurement	Setting spot density → 101
	Setting tank profile → 104
	Setting interface profile → 105
	Setting manual profile → 106

9.4.1 Configuring the level and interface measurement

The level measurement is to measure the position where the displacer is balanced (immersion point) in the liquid. When the liquid surface level changes, the displacer continuously follows the position to measure the liquid level. To define the appropriate level measurement, the following settings are required prior to operation.

The interface measurement can determine the interface between different liquids in a tank (e.g. water and oil). Up to two different interfaces can be determined within a maximum of three phases in a tank.

Setting the density of application

Density values for three liquid phases are set as follows prior to delivery.

- Upper density: 800 kg/m³
- Middle density: 1 000 kg/m³
- Lower density: 1 200 kg/m³

Change the data to reflect the actual density values. For tanks with only one liquid phase, set the upper density. For tanks with two or three phases, set middle and bottom densities as well.

Number of phases	Parameters to be set
1 phase	Upper density
2 phases	Upper/middle density
3 phases	Upper/middle/lower density

When performing an interface measurement, the minimum density difference between phases should be at least 100 kg/m³.

Setting the density

1. Navigate to: Setup → Upper density , Setup → Middle density and Setup → Lower density
2. Input the value to Upper, Middle, and Lower densities accordingly.

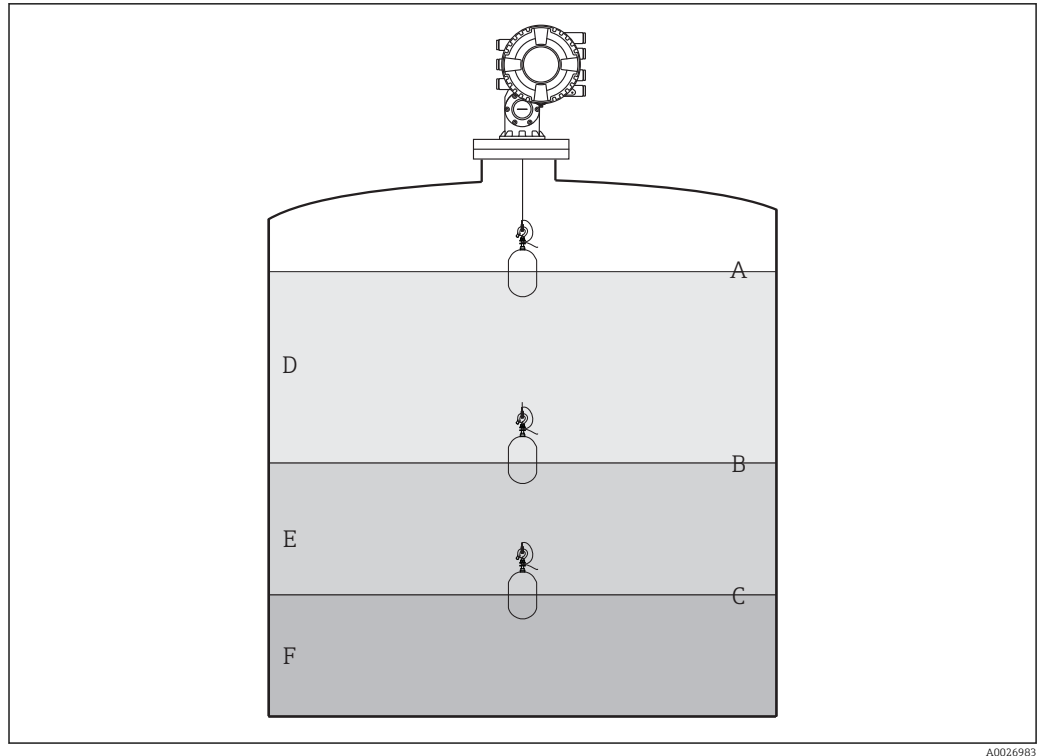

A0026983

44 Tank configuration

- A Liquid level
- B Upper interface
- C Lower interface
- D Upper phase (density)
- E Middle phase (density)
- F Lower phase (density)

Setting the tank height

To measure the tank level correctly, the tank reference height and empty (distance from reference point to datum plate) must be set in advance.

- i** Tank reference height: Set by the customer to represent the height of the tank. Distance between the dipping reference and the datum plate. Used for percentage calculation and as reference for the ullage level.
- Empty: Distance between the zero point of device and datum plate. Empty is automatically adjusted by the **Set level** parameter.
- Refer to Level calibration for details how to determine the empty parameter accurately. → 98

Setting the tank reference height and empty

1. Navigate to: Setup → Empty
2. Input the empty value.
3. Navigate to: Setup → Tank reference height
4. Input the value of tank reference height.

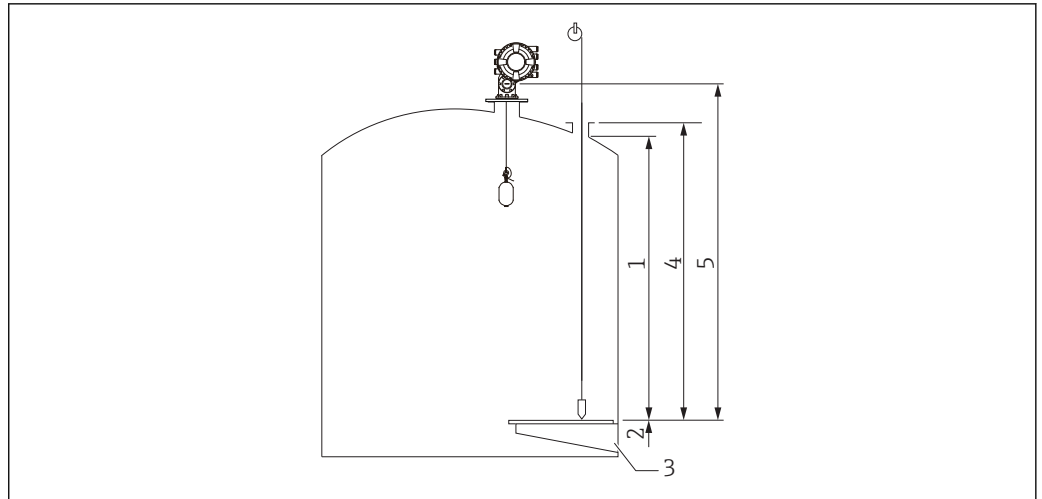

A0028032

45 Tank height

- 1 High stop
- 2 Low stop
- 3 Datum plate
- 4 Tank reference height
- 5 Empty

Setting the high stop and low stop

The high stop and low stop determine the highest and lowest points of displacer movement. Set these data to the desired actual upper and lower limit values.

- i** If the displacer should be able to determine a tank bottom that is below the datum plate, set the low stop to a negative value. To make sure that the displacer travels up to the reference position, set the high stop to a value greater than or equal to empty.

High stop and low stop setting procedure

1. Navigate to: Setup → High stop level
2. Input the actual value for high stop.
3. Navigate to: Setup → Low stop level
4. Input the actual value for low stop.

This completes upper and lower stop setting procedure.

9.4.2 Level calibration

The following table shows the most likely options for setting the level calibration.

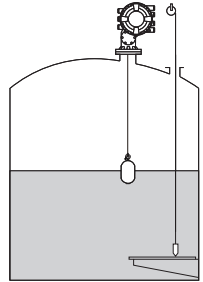
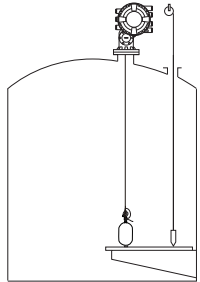
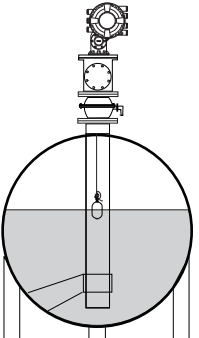
Open tank with liquid	Open tank without liquid	Closed tank
 <p>A0028865</p>	 <p>A0029120</p>	 <p>A0029126</p>

Setting for an open tank with liquid

Level setting procedure

1. Navigate to: Setup → Gauge command
2. Select the **Level** option for the **Gauge command** parameter.
 - ↳ The displacer automatically searches for the point where it balances.
3. Wait until the displacer is balanced on the liquid.
4. Perform dipping to determine the liquid level (L) in the tank.
5. Navigate to: Setup → Set level
6. Input the determined level value for the **Set level** parameter.

 The **Set level** parameter adjusts the **Empty** parameter to reflect the new level value.

This completes setting for open tank with liquid procedure.

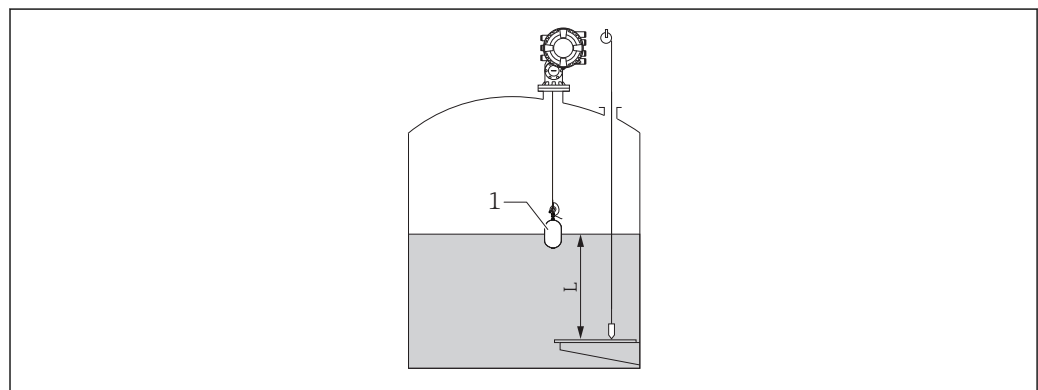

 46 Set level for opened tank

- 1 Displacer
L Measured value

Setting for an open tank without liquid

If there is no liquid in the tank, the following procedure can be used to set the tank bottom or datum plate to 0 mm for the tank level.

Level setting procedure

1. Navigate to: Operation → Gauge command → Gauge command
2. Select the **Bottom level** option to measure the tank bottom.
3. Navigate to: Operation → One-time command status
4. Wait until the **Finished** option is shown.
5. Navigate to: Operation → Level → Bottom level
6. Read the **Bottom level** parameter (Bv).
7. Navigate to: Setup → Empty
8. Read the actual empty value (Ea).
9. Calculate the new empty value using following formula.
 - ↳ $En = Ea - Bv - Z0$
10. Input the calculated value for the **Empty** parameter.

Example: $Ea = 28m, Bv = 10.5m, Z0 = 0.5m$
 $En = 28m - 10.5m = 17m$

A0029473

- i The parameter Z0 defines the distance between the desired 0mm level value and the physical tank bottom (if displacer measures the datum plate, $Z0 = 0$ mm (0 in)).
- Bottom level operation considers the immersion depth of the displacer in the measurement.

This completes the level setting for open tank without liquid procedure.

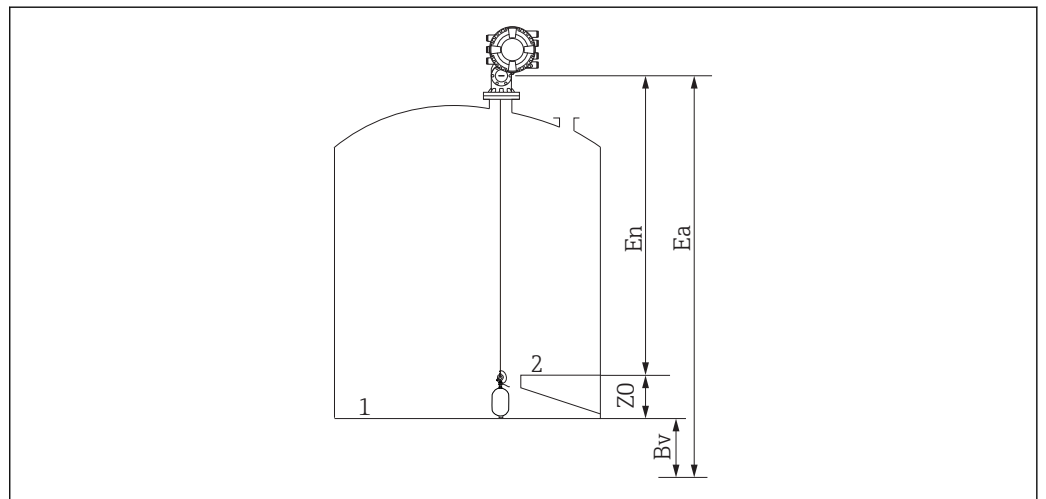

A0028133

47 Open tank without liquid

- 1 Tank bottom
- 2 Datum plate
- Ea Initial empty setting
- Bv Initial bottom level
- En New empty
- Z0 Distance from tank bottom to datum plate

- i It is recommended to repeating the level calibration when there is liquid in the tank (→ 98).

Setting for a closed tank

For tanks that cannot be hand-dipped, follow the procedure shown below.

Level setting procedure

1. Navigate to: Operation → Gauge command → Gauge command
2. Select the **Bottom level** option to measure the tank bottom.
 - ↳ NMS8x measures the tank bottom and returns to level if the post gauge command is set to level (default).
3. Navigate to: Operation → One-time command status
4. Wait until the **Finished** option is shown.
5. Navigate to: Operation → Level → Bottom level
6. Read the bottom value (Bv).
7. Navigate to: Operation → Level → Tank level (a)
8. Calculate the level value (L) by using following formula.
 - ↳ $L = a - Bv$
9. Navigate to: Setup → Set level
10. Input the value L for the **Set level** parameter.

This completes the level setting procedure.

i If the datum plate is not zero (e.g. Z mm), adjust the set level value (L) by subtracting Z from the value L ($L = a - Bv - Z$).

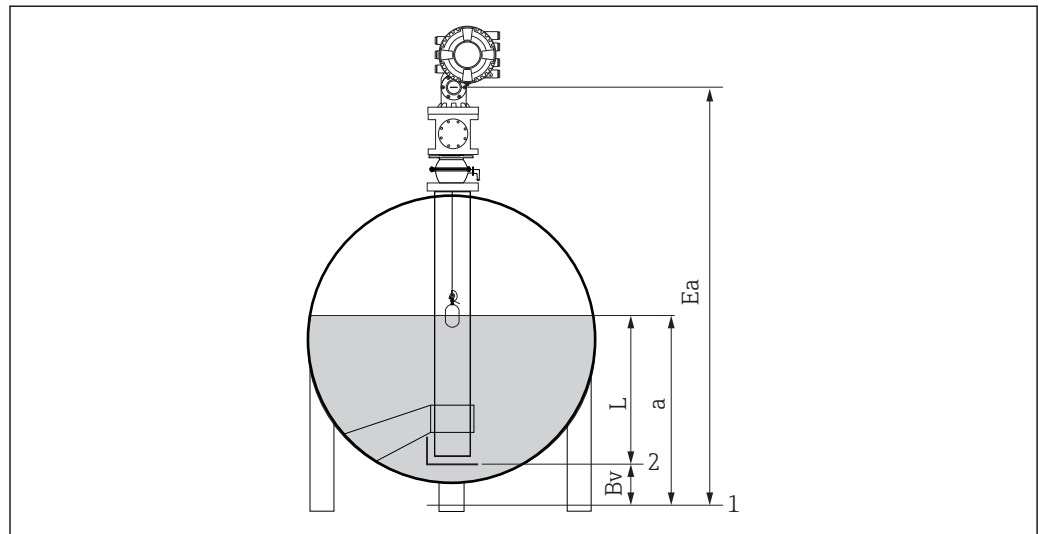

A0028137

i 48 Closed tank

- 1 Initial zero level position
- 2 Datum plate
- Ea Initial setting of Empty
- Bv Bottom level
- a Tank level
- L Set level value

Selecting the process condition

The process condition is used to adjust the device to the application. By changing this parameter, several balancing parameters are adjusted automatically to make setup easier.

1. Navigate to: Setup → Process condition
2. Select an appropriate condition for the **Process condition** parameter.

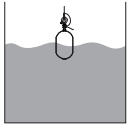
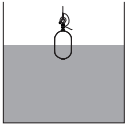
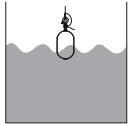
Parameter name	Process condition		
Parameter setting	Universal (Default setting)	Calm surface	Turbulent surface
Description	 A0028027	 A0028028	 A0028029
	Provides reliable results in various applications and for various liquids.	For storage tanks with a calm surface and focus on highest accuracy measurement.	For applications where the surface is turbulent.

9.4.3 Configuring the density measurement

The density measurement is performed to confirm and maintain the quality of the liquid. The density measurement is largely divided into two methods as shown below.

Density methods	Gauge command	Description
Spot density	Upper density Middle density Lower density	One spot density measurement for designated layer <ul style="list-style-type: none"> ▪ Upper density is for upper layer. ▪ Middle density is for middle layer. ▪ Lower density is for lower layer.
Profile density	Tank profile	Profile between the bottom of the tank and the level position <ul style="list-style-type: none"> ▪ Normal mode ▪ Compensation mode
	Interface profile	Profile between the upper interface (I/F) and the level position <ul style="list-style-type: none"> ▪ Normal mode ▪ Compensation mode
	Manual profile	Profile between the desired start point and the level position <ul style="list-style-type: none"> ▪ Normal mode ▪ Compensation mode

Spot density measurement

Three different spot density gauge commands are available as shown below.

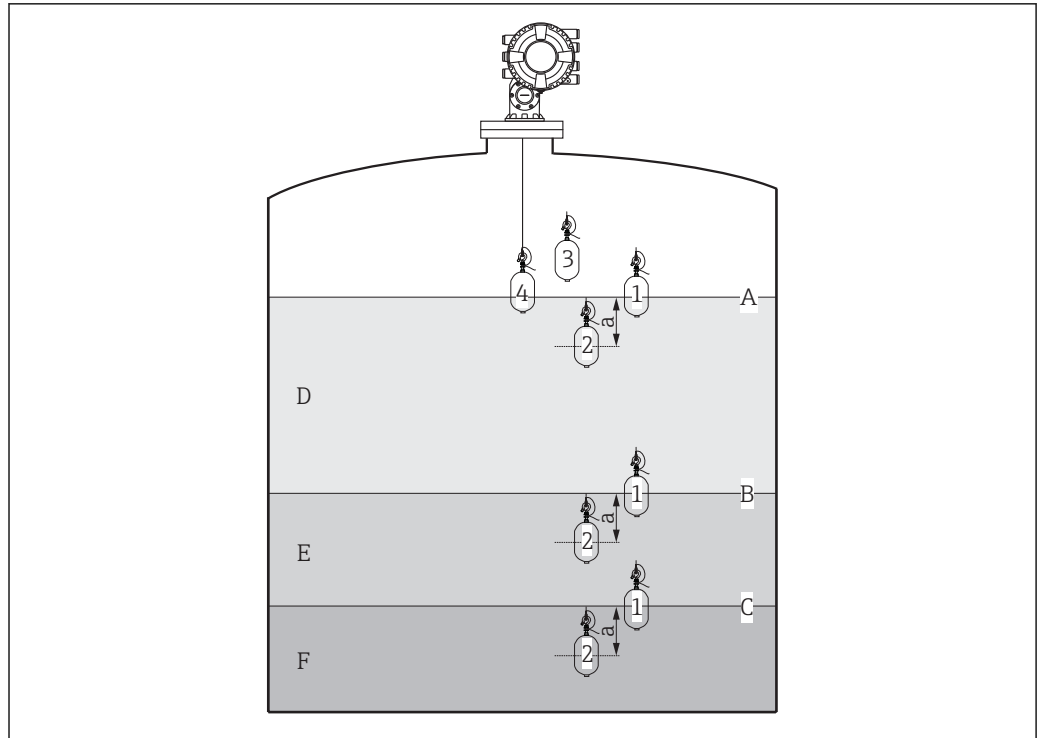

A0029468

49 Spot density (The numbers show the order of displacer movement.)

- A Liquid level
- B Upper interface
- C Lower interface
- D Upper density
- E Middle density
- F Lower density
- a Submersion depth

The submersion depth (a) is set to 150 mm (5.91 in) prior to delivery. To change the submersion depth, perform the following steps.

1. Navigate to: Setup → Advanced setup → Sensor config → Spot density → Submersion depth
2. Input the desired value for the **Submersion depth** parameter.

Setting the spot density

1. Navigate to: Operation → Gauge command → Gauge command
2. Select the **Upper density** option, the **Middle density** option, or the **Lower density** option for the **Gauge command** parameter.
3. Verify that the value that was examined in a laboratory and the actual value that was measured in the tank are the same or within an allowable range.
4. Adjust the value if necessary.
 - ↳ Navigate to: Setup → Advanced setup → Sensor config → Spot density
Select the **Upper density offset** parameter, the **Middle density offset** parameter, and the **Lower density offset** parameter and input the desired values for each offset.

This completes the setting spot density procedure.

Profile density measurement

Profile density has three gauge commands as shown below.

i NMS8x measures a density profile according to a defined interval of up to 50 points.

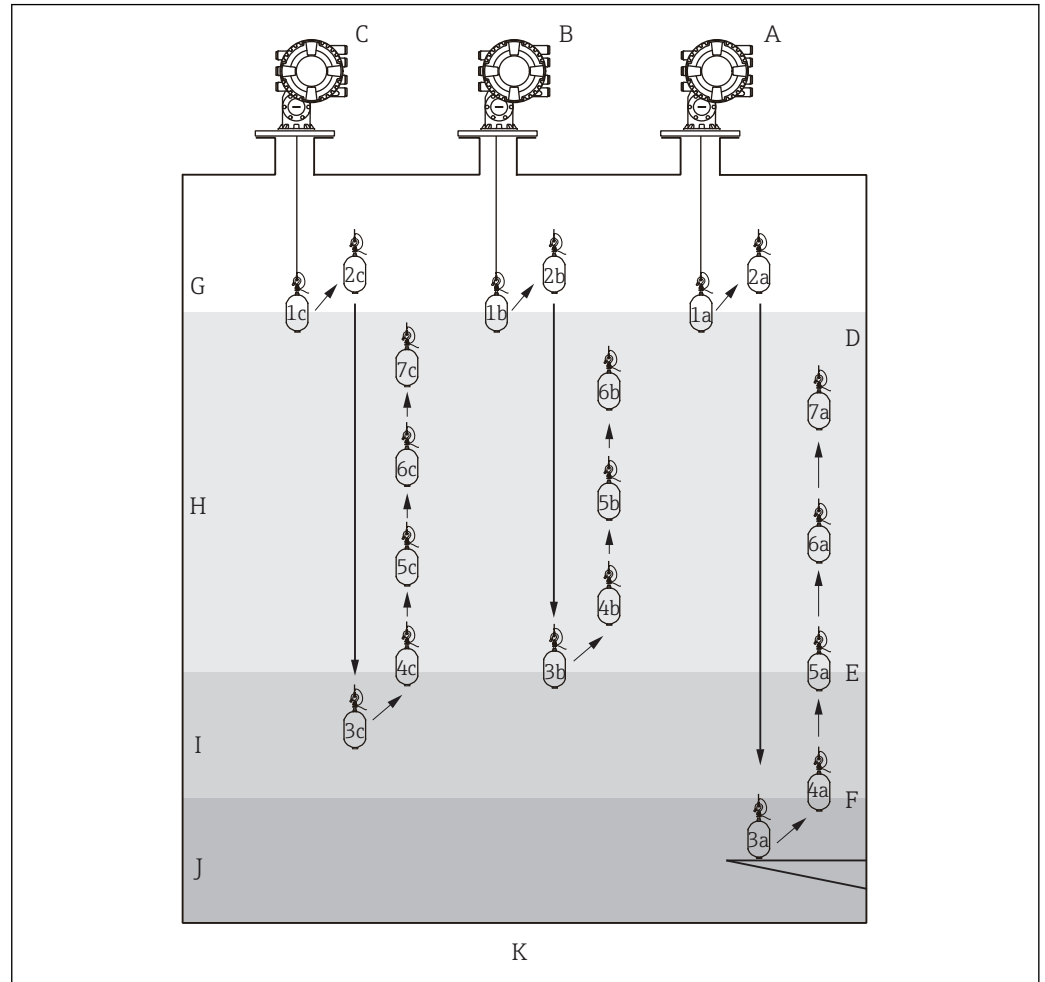

50 Overview of profile density (1a, 2a, 3a...show the order of displacer movements.)

- A Tank profile
- B Interface profile
- C Manual profile
- D Liquid level
- E Upper interface
- F Lower interface
- G Gas phase
- H Upper density
- I Middle density
- J Lower density
- K Tank bottom

i Density measurement has two types of modes.

- Normal measure mode: Profile points are measured at exactly configured positions.
- Compensation mode: Profile points are measured at multiples of the wire drum circumference to further improve accuracy.

Select normal mode as usual. However, when selecting compensation mode, NMS8x automatically adjusts the measurement positions to where the density measurement can be the most accurate.

Tank profile measurement

Setting tank profile procedure

The tank profile operation measures a profile starting at the physical tank bottom up to the liquid level.

1. Navigate to: Setup → Advanced setup → Sensor config → Profile density → Profile density offset distance
2. Input the desired value for the **Profile density offset distance** parameter.
 - ↳ The value of the profile density offset distance defines the distance between the start point (upper interface) and the first measurement point.
3. Navigate to: Setup → Advanced setup → Sensor config → Profile density → Profile density interval
4. Input the desired value for the **Profile density interval** parameter.
5. Set **Tank profile** option in the **Gauge command** parameter to start measurement.

This completes the setting tank profile procedure.

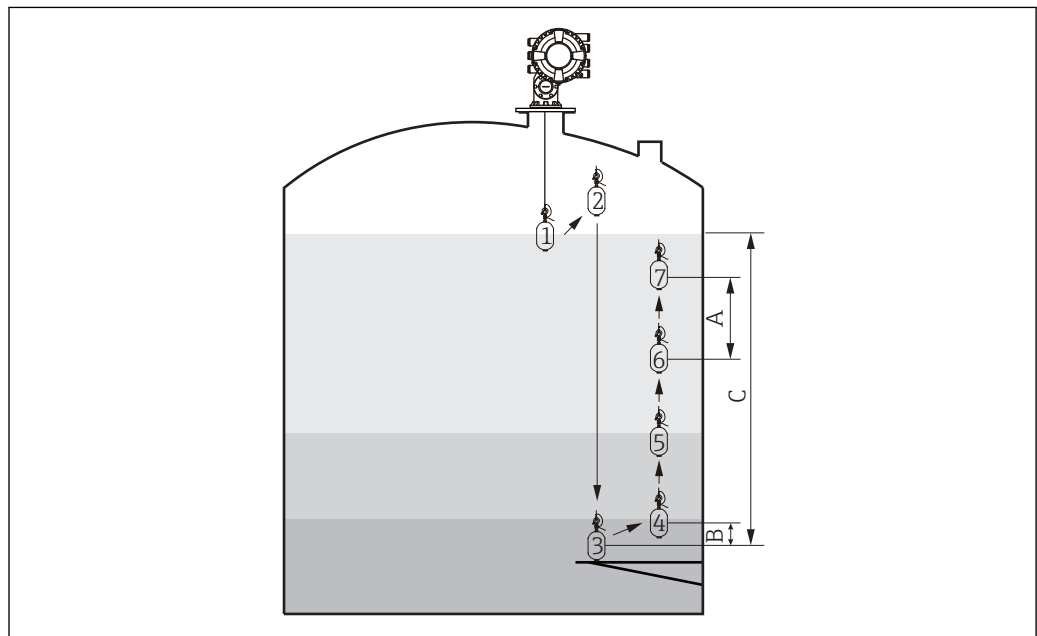

A0029107

51 Tank profile movement (The numbers show the order of the displacer movement.)

- A Profile density interval
- B Profile density offset distance
- C Datum plate
- D Tank profile range

Interface profile measurement

Setting interface profile procedure

The interface profile operation measures a profile starting at the upper interface level up to the liquid level.

1. Navigate to: Setup → Advanced setup → Sensor config → Profile density → Profile density offset distance
2. Input the desired value for the **Profile density offset distance** parameter.
 - ↳ The value of the profile density offset distance defines the distance between the start point (upper interface profile) and the first measurement point.
3. Navigate to: Setup → Advanced setup → Sensor config → Profile density → Profile density interval
4. Input the desired value for the **Profile density interval** parameter.
5. Set **Interface profile** option in the **Gauge command** parameter to start measurement.

This completes the setting interface profile procedure.

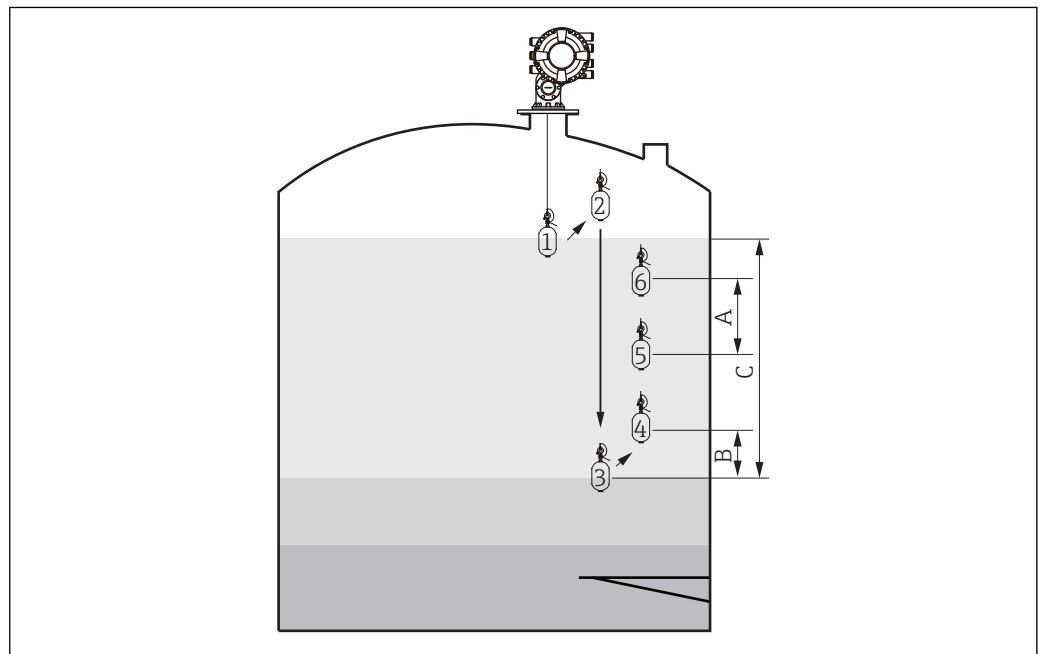

52 Interface profile movement (The numbers show the order of the displacer movement.)

- A Profile density interval
- B Profile density offset distance
- C Tank profile range

A0029109

Manual profile measurement

Setting manual profile procedure

The manual profile operation measures a profile starting at a manually specified level up to the liquid level.

1. Navigate to: Setup → Advanced setup → Sensor config → Profile density → Manual profile level
2. Input the desired value for the **Manual profile level** parameter.
3. Navigate to: Setup → Advanced setup → Sensor config → Profile density → Profile density offset distance
 - ↳ For the manual profile, the level offset can be set to 0 so that the first point can be measured at the manual profile level.
4. Input the desired value for the **Profile density offset distance** parameter.
 - ↳ The value of the profile density offset distance defines the distance between the start point (manual profile) and the first measurement point.
5. Navigate to: Setup → Advanced setup → Sensor config → Profile density → Profile density interval
6. Input the desired value for the **Profile density interval** parameter.
7. Set **Manual profile** option in the **Gauge command** parameter to start measurement.

This completes the setting manual profile.

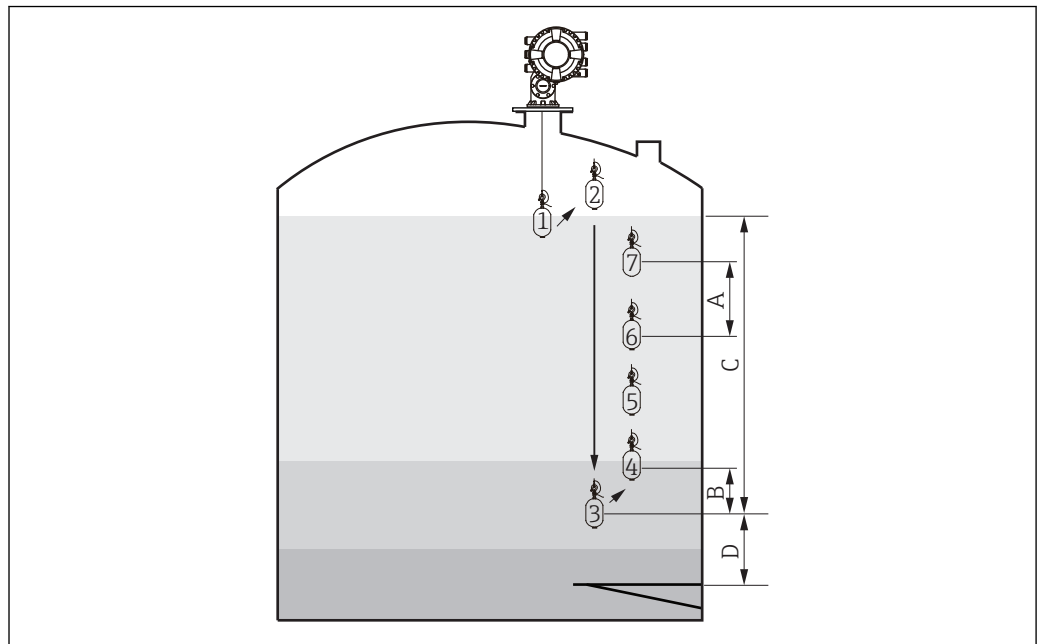

















A0029111

53 Manual profile movement (The numbers show the order of the displacer movement.)

- A Profile density interval
- B Profile density offset distance
- C Manual profile range
- D Manual profile level

9.5 Configuring the tank gauging application

Configuration of the inputs:	Description
HART inputs	→  108
NMT532/539 connected via HART	→  110
4-20mA inputs	→  111
RTD input	→  112
Digital inputs	→  114
Configuration of the data processing in the device:	Description
Linking input values to tank variables	→  116
Tank calculation: Direct Level Measurement	→  117
Tank calculation: Hybrid Tank Measurement System (HTMS)	→  118
Tank calculation: Correction of the Hydrostatic Tank Deformation (HyTD)	→  119
Tank calculation: Thermal Tank Shell Correction (CTSh)	→  120
Alarms (limit evaluation)	→  121
Configuration of the signal output:	Description
4-20mA output	→  122
HART slave + 4-20mA output	→  123
Modbus	→  125
V1	→  126
Digital outputs	→  127

9.5.1 Configuration of the HART inputs

Connecting and addressing HART devices

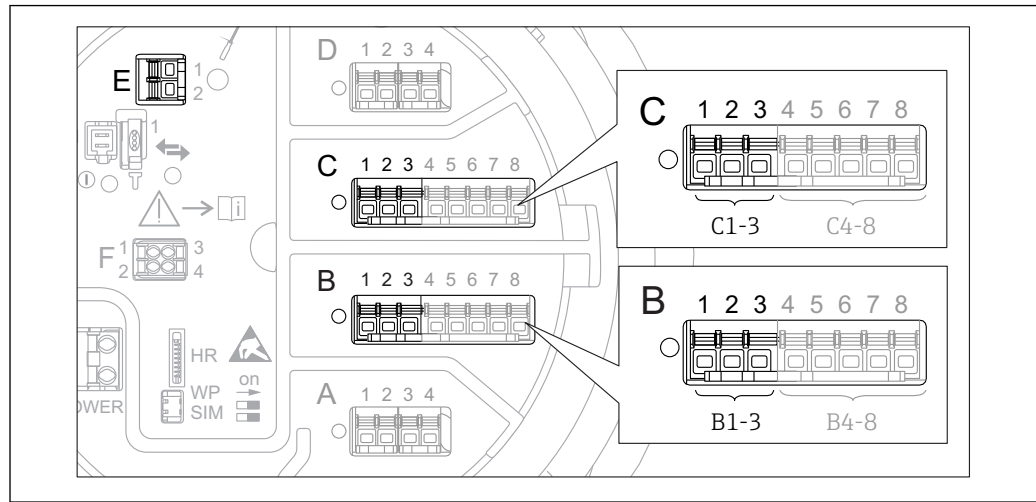

54 Possible terminals for HART loops

- B Analog I/O module in slot B (availability depending on device version → 49)
- C Analog I/O module in slot C (availability depending on device version → 49)
- E HART Ex is output (available in all device versions)

i HART devices must be configured and given a unique HART address in the range from 1 to 15 via their own user interface before they are connected to the Proservo NMS80²⁾. Make sure they are connected as defined by the terminal assignment → 55. Devices with an address larger than 15 are not recognized by the Proservo.

Slot B or C: Setting the operating mode of the Analog I/O module



i This section is not relevant for the HART Ex is output (Slot E). This output always functions as a HART master for the connected HART slaves.

If HART devices are connected to an Analog I/O module (slot B or C in the terminal compartment), this module must be configured as follows:





1. Navigate to the submenu of the respective Analog I/O module: Setup → Advanced setup → Input/output → Analog I/O X1-3
2. Go to the **Operating mode** parameter (→ 213).
3. If only one HART device is connected to this loop:
Select the **HART master+4..20mA input** option. In this case the 4-20mA signal can be used in addition to the HART signal. For the configuration of the 4-20mA input: → 111.
4. If up to 6 HART devices are connected to this loop:
Select the **HART master** option.

2) The current software does not support HART devices with address 0 (zero).

Defining the type of measured value

-  This setting can be skipped for a connected Prothermo NMT5xx as the type of measured value is automatically recognized by the Proservo NMS8x in this case.
- 
 - The measured values can only be used in the system if the unit of the assigned HART variable fits the type of measured value. The HART variable assigned to **Output temperature**, for example, has to be in °C or °F.
 - A HART variable with unit "%" can not be used for **Output level**. Instead, the HART variable must be in mm, m, ft or in.

The type of measured value must be specified for each HART variable (PV, SV, TV and QV). To do so, proceed as follows:

1. Navigate to: Setup → Advanced setup → Input/output → HART devices
 - ↳ There is a submenu for each connected HART device.
2. For each device go to the corresponding submenu.
3. If the device measures a pressure:
 - Go to the **Output pressure** parameter (→  203) and specify which of the four HART variables contains the measured pressure. Only a HART variable with a pressure unit may be selected.
4. If the device measures a density:
 - Go to the **Output density** parameter (→  204) and specify which of the four HART variables contains the measured density. Only a HART variable with a density unit may be selected.
5. If the device measures a temperature:
 - Go to the **Output temperature** parameter (→  204) and specify which of the four HART variables contains the measured temperature. Only a HART variable with a temperature unit may be selected.
6. If the device measures the vapor temperature:
 - Go to the **Output vapor temperature** parameter (→  205) and specify which of the four HART variables contains the measured vapor temperature. Only a HART variable with a temperature unit may be selected.
7. If the device measures a level:
 - Go to the **Output level** parameter (→  205) and specify which of the four HART variables contains the measured level. Only a HART variable with a level unit (not "%") may be selected.

Disconnecting HART devices

When a HART device is disconnected from the device, it must also be logically removed as follows:

1. Navigate to Setup → Advanced setup → Input/output → HART devices → Forget device → Forget device
2. Select the HART device to be removed.

-  This procedure is also necessary if a defective device is exchanged.

9.5.2 Configuration of a connected Prothermo NMT532/NMT539

If a Prothermo NMT532 or NMT539 temperature transmitter is connected via HART, it can be configured as follows:

1. Navigate to: Expert → Input/output → HART devices → HART Device(s) → NMT device config; here, **HART Device(s)** is the name of the connected Prothermo.
2. Go to the **Configure device?** parameter and select **Yes**.
3. Go to the **Bottom point** parameter and enter the position of the bottom temperature element (see picture below).

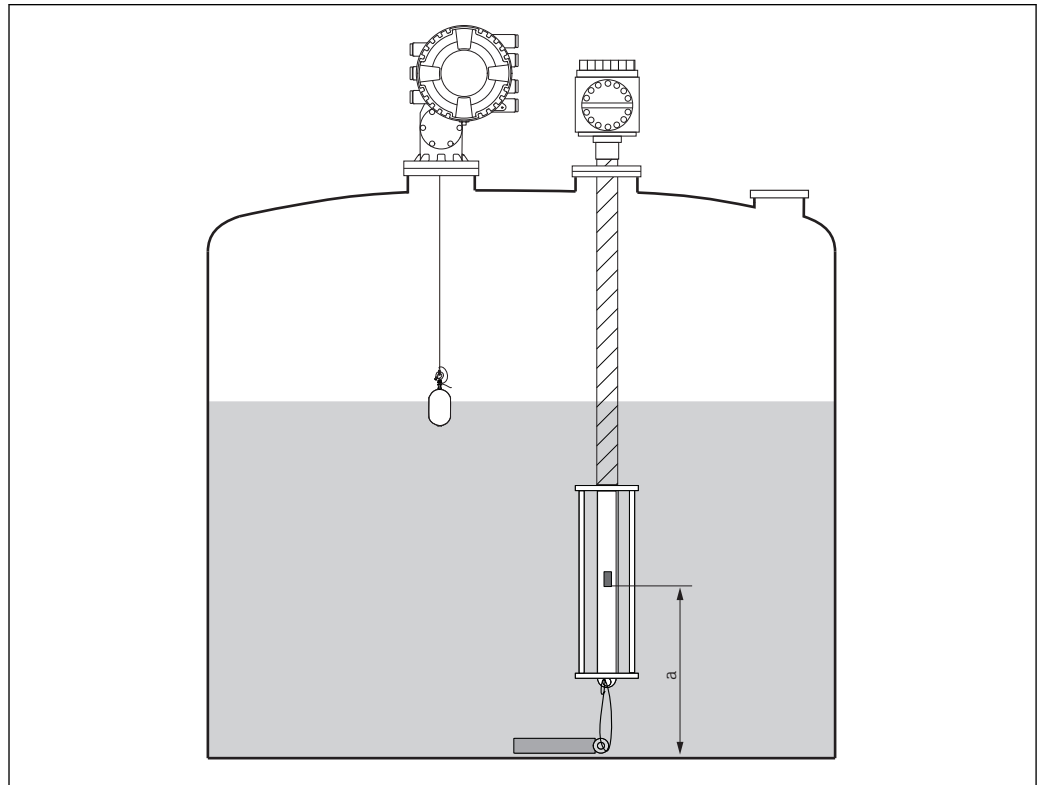

 55 Position of the bottom temperature element

- a* Distance from bottom temperature element to zero reference (tank bottom or datum plate). The standard factory default setting is 500 mm (19.69 in), and it can be adjusted according to the actual installation.

-  To check the temperatures measured by the individual elements, go to the following submenu: Operation → Temperature → NMT element values → Element temperature
There is a **Element temperature X** parameter for each element of the Prothermo.

9.5.3 Configuration of the 4-20mA inputs

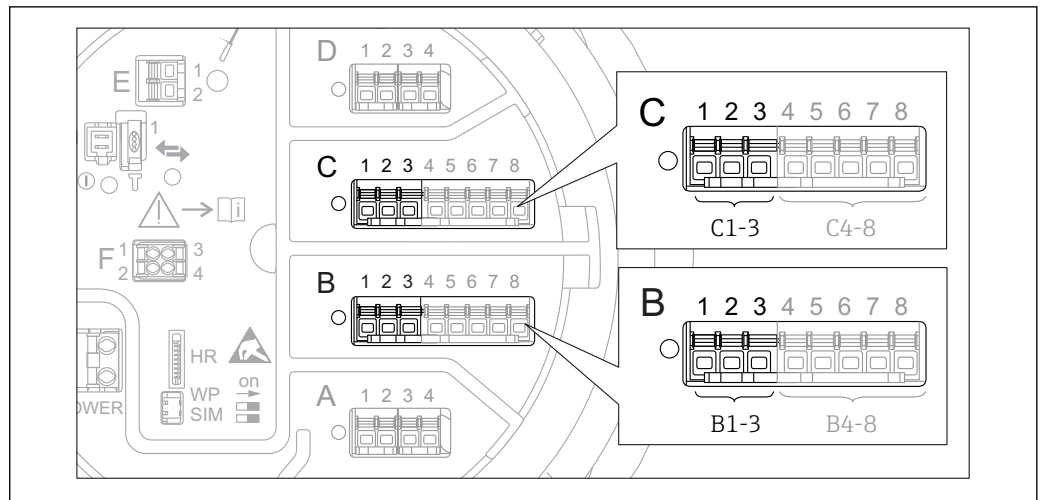

56 Possible locations of the Analog I/O modules, which can be used as a 4-20mA input. The order code of the device determines which of these modules is actually present → 49.

For each Analog I/O module to which a 4-20mA device is connected, proceed as follows:

1. Make sure the 4-20mA devices are connected as defined by the terminal assignment → 55.
2. Navigate to the submenu of the respective Analog I/O module: Setup → Advanced setup → Input/output → Analog I/O X1-3
3. Go to the **Operating mode** parameter (→ 213) and select **4..20mA input** or **HART master+4..20mA input**.
4. Go to the **Process variable** parameter (→ 219) and specify which process variable is transmitted by the connected device.
5. Go to the **Analog input 0% value** parameter (→ 219) and define which value of the process variable corresponds to an input current of 4 mA (see diagram below).
6. Go to the **Analog input 100% value** parameter (→ 219) and define which value of the process variable corresponds to an input current of 20 mA (see diagram below).
7. Go to the **Process value** parameter (→ 220) and check whether the indicated value matches the actual value of the process variable.

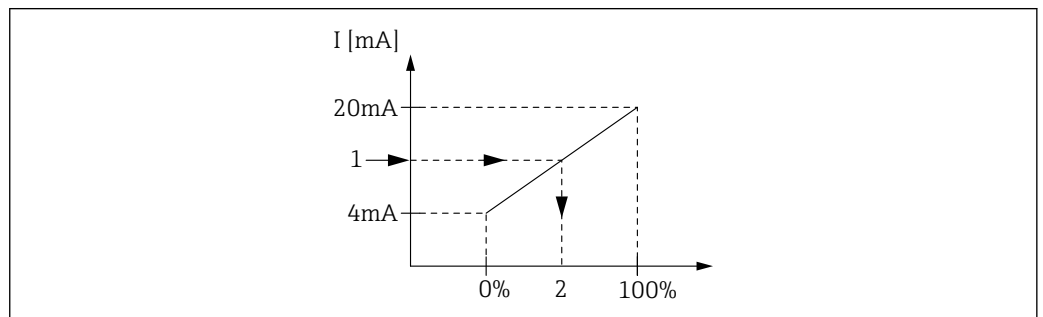

57 Scaling of the 4-20mA input to the process variable

- 1 Input value in mA
- 2 Process value

i The **Analog I/O** submenu contains additional parameters for a more detailed configuration of the Analog Input. For a description refer to : → 213

9.5.4 Configuration of a connected RTD

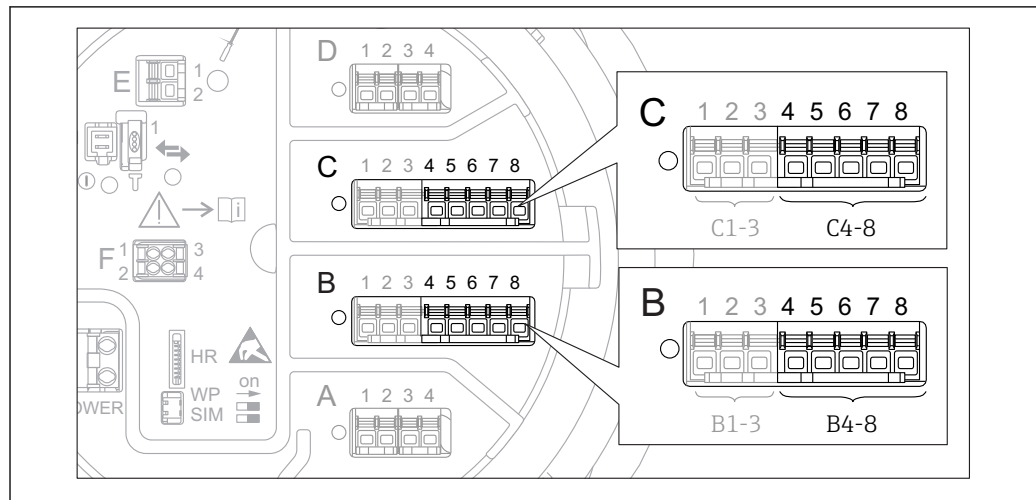

A0032465

58 Possible locations of the Analog I/O modules, to which an RTD can be connected. The order code of the device determines which of these modules is actually present → 49.

1. Make sure the RTD is connected as defined by the terminal assignment → 59.
2. Navigate to the submenu of the respective Analog I/O module: Setup → Advanced setup → Input/output → Analog IP X4-8.
3. Go to the **RTD type** parameter (→ 207) and specify the type of the connected RTD.

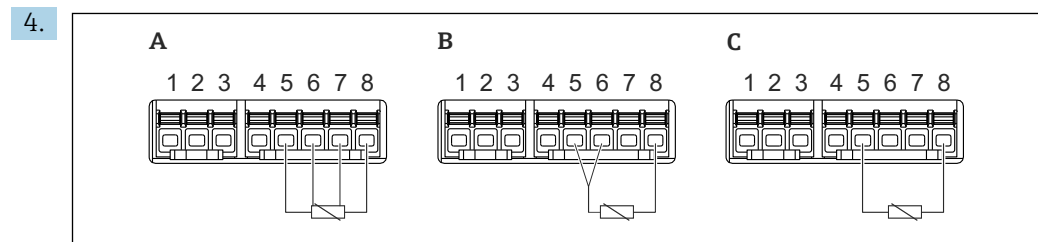

A0026371

59 RTD connection types

- A 2 wire RTD connection
- B 3 wire RTD connection
- C 4 wire RTD connection

Go to the **RTD connection type** parameter (→ 208) and specify the type of connection of the RTD (2-, 3- or 4-wire).

5. Go to the **Input value** parameter (→ 210) and check whether the indicated temperature matches the actual temperature.
6. Go to the **Minimum probe temperature** parameter (→ 210) and specify the minimum approved temperature of the connected RTD.
7. Go to the **Maximum probe temperature** parameter (→ 210) and specify the maximum approved temperature of the connected RTD.

8.

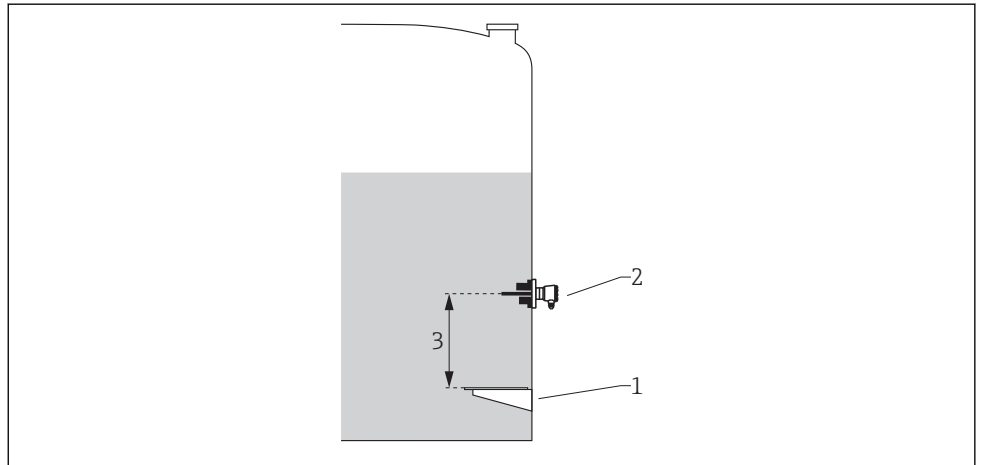

A0029269

- 1 Datum plate
- 2 RTD
- 3 Probe position (→ 211)

Go to the **Probe position** parameter and enter the mounting position of the RTD (measured from the datum plate).

↳ This parameter, in conjunction with the measured level, determines whether the measured temperature refers to the product or to the gas phase.

Offset for resistance and/or temperature

i An offset for the resistance or the temperature can be defined in the following submenu: Expert → Input/output → Analog IP X4-8.

- **Ohms offset** is added to the measured resistance before the calculation of the temperature.
- **Temperature offset after conversion** is added to the measured temperature.

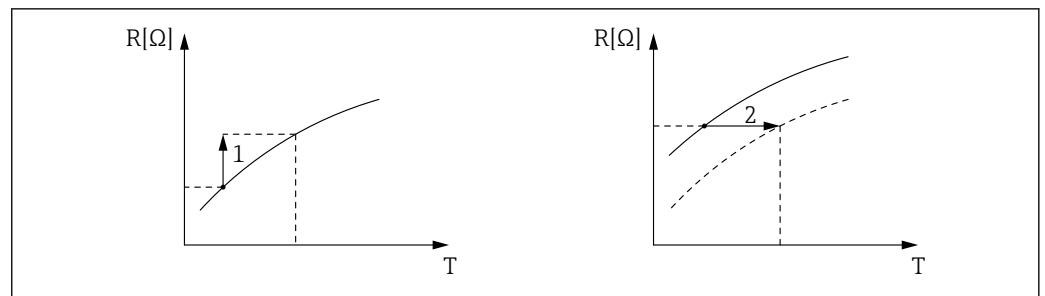

A0029265

- 1 Ohms offset
- 2 Temperature offset after conversion

9.5.5 Configuration of the digital inputs

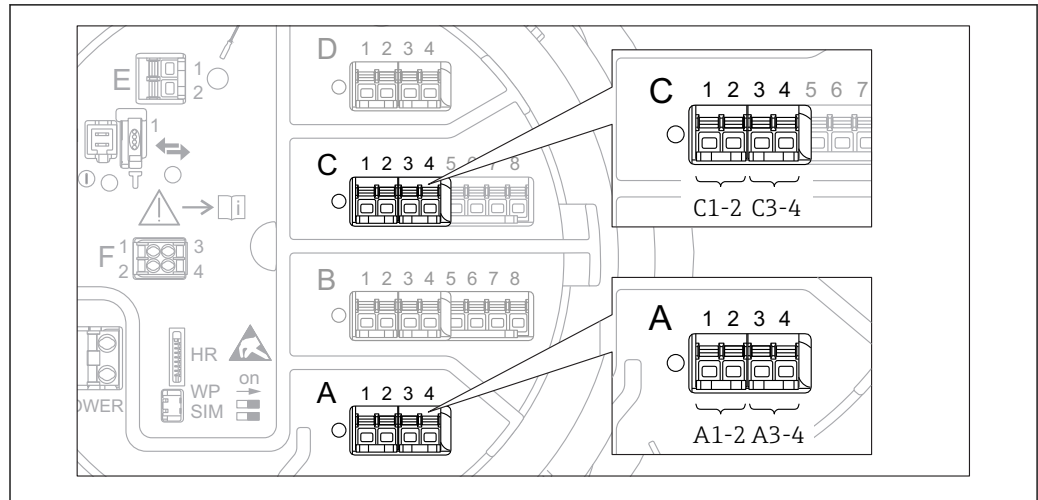

60 Possible locations of the Digital I/O modules (examples); the order code defines the number and location of digital input modules → 49.

There is a **Digital Xx-x** submenu for each digital I/O module of the device. "X" designates the slot in the terminal compartment, "x-x" the terminals within this slot. The most important parameters of this submenu are **Operating mode** and **Contact type**.

The "Operating mode" parameter

Setup → Advanced setup → Input/output → Digital Xx-x → Operating mode

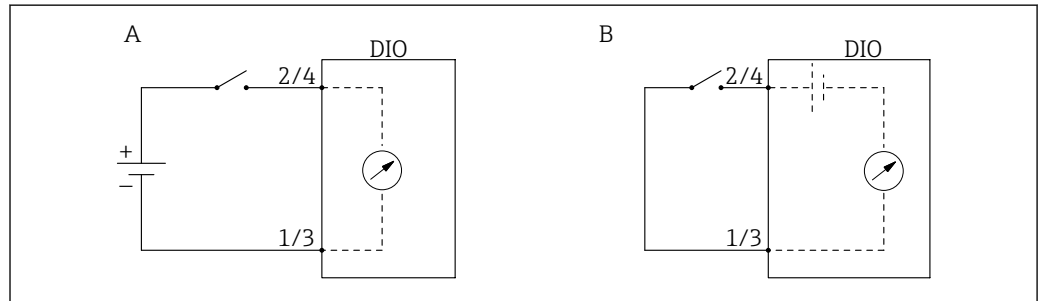

A "Operating mode" = "Input passive"
 B "Operating mode" = "Input active"

Meaning of the options

- **Input passive**

The DIO module measures the voltage provided by an external source. Depending on the status of the external switch, this voltage is 0 at the input (switch open) or exceeds a certain limit voltage (switch closed). These two states represent the digital signal.

- **Input active**



The DIO module provides a voltage and uses it to detect whether the external switch is open or closed.

The "Contact type" parameter

Setup → Advanced setup → Input/output → Digital Xx-x → Contact type

This parameter determines how the state of the external switch is mapped to the internal states of the DIO module:

State of the external switch	Internal state of the DIO module	
	Contact type = Normally open	Contact type = Normally closed
Open	Inactive	Active
Closed	Active	Inactive
Behavior in special situations:		
During start-up	Unknown	Unknown
Fault in measurement	Error	Error

- 
 The internal state of the Digital Input can be transferred to a Digital Output or can be used to control the measurement.
- The **Digital Xx-x** submenu contains additional parameters for a more detailed configuration of the Digital Input. For a description refer to →  223.

9.5.6 Linking input values to tank variables

Measured values must be linked to tank variables before they can be used in the Tank Gauging application. This is done by defining the source of each tank variable in the following parameters:

Tank variable	Parameter defining the source of this variable
Product level	<ul style="list-style-type: none"> ■ Setup → Level source ■ Setup → Advanced setup → Application → Tank configuration → Level → Level source
Bottom water level	Setup → Advanced setup → Application → Tank configuration → Level → Water level source
Average or spot temperature of the product	<ul style="list-style-type: none"> ■ Setup → Liquid temp source ■ Setup → Advanced setup → Application → Tank configuration → Temperature → Liquid temp source
Temperature of the air surrounding the tank	Setup → Advanced setup → Application → Tank configuration → Temperature → Air temperature source
Temperature of the vapor above the product	Setup → Advanced setup → Tank configuration → Temperature → Vapor temp source
Density of the product	Setup → Advanced setup → Application → Tank configuration → Density → Observed density source
Bottom pressure (P1)	Setup → Advanced setup → Application → Tank configuration → Pressure → P1 (bottom) source
Top pressure (P3)	Setup → Advanced setup → Application → Tank configuration → Pressure → P3 (top) source

 Depending on the application not all these parameters will be relevant in a given situation.

9.5.7 Tank calculation: Direct level measurement

If no tank calculation is configured, level and temperature are measured directly.

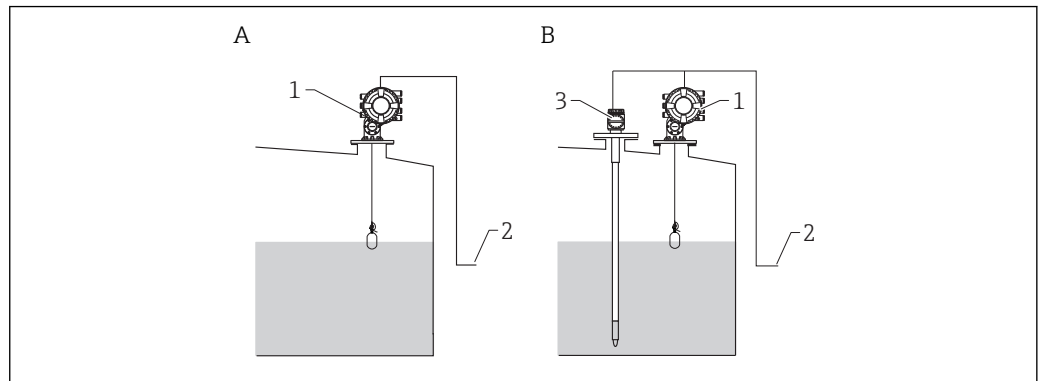

A0029274

- A Direct level measurement (without temperature)
B Direct level and temperature measurement
1 NMS8x
2 To inventory management system
3 Temperature transmitter

1. Navigate to: "Setup → Level source" and specify from which device the level is obtained.
2. If a temperature transmitter is connected:
Navigate to: "Setup → Liquid temp source" and specify from which device the temperature is obtained.

9.5.8 Tank calculation: Hybrid tank measurement system (HTMS)

HTMS uses level and pressure measurements to calculate the density of the medium.

i In non-atmospheric (i.e. pressurized) tanks it is recommended to use the **HTMS P1+P3** mode. Two pressure sensors are required in this case. In atmospheric (i.e. unpressurized) tanks the **HTMS P1** with only one pressure sensor is sufficient.

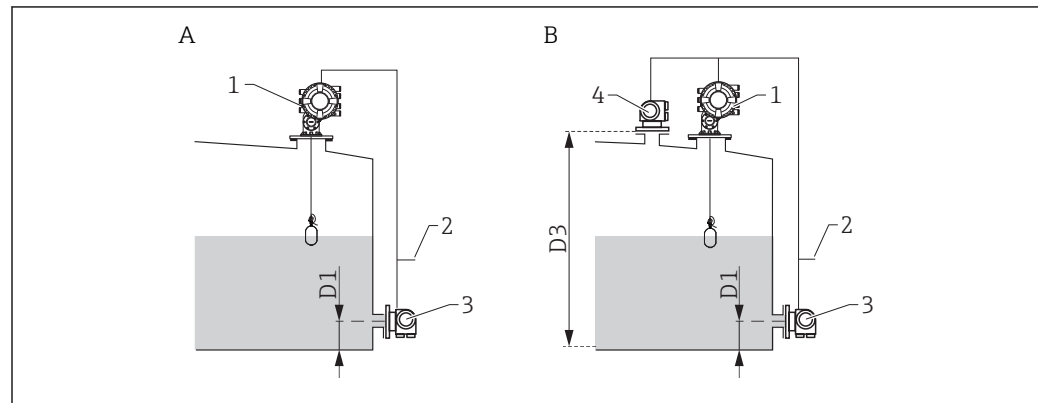

- A The "HTMS P1" measurement mode
 B The "HTMS P1+P3" measurement mode
 D1 P1 position
 D3 P3 position
 1 NMS8x
 2 To inventory management system
 3 Pressure sensor (bottom)
 4 Pressure sensor (top)

1. Navigate to Setup → Advanced setup → Application → Tank configuration → Level
2. Go to **Level source** (→ 📖 189) and specify from which device the level is obtained.
3. Navigate to Setup → Advanced setup → Application → Tank configuration → Pressure
4. Go to **P1 (bottom) source** (→ 📖 261) and specify from which device the bottom pressure (P1) is obtained.
5. If a top pressure transmitter (P3) is connected:
 Go to **P3 (top) source** (→ 📖 263) and specify from which device the bottom pressure (P1) is obtained.
6. Navigate to: Setup → Advanced setup → Application → Tank calculation → HTMS
7. Go to **HTMS mode** (→ 📖 278) and specify the HTMS mode.
8. Navigate to Setup → Advanced setup → Application → Tank configuration → Density
9. Go to **Observed density source** (→ 📖 259) and select **HTMS**.
10. Use the other parameters of the **HTMS** submenu to configure the calculation. For a detailed description: → 📖 276

9.5.9 Tank calculation: Hydrostatic Tank Deformation (HyTD)

Hydrostatic Tank Deformation can be used to compensate the vertical movement of the Gauge Reference Height (GRH) due to bulging of the tank shell caused by the hydrostatic pressure exerted by the liquid stored in the tank. The compensation is based on a linear approximation obtained from manual hand dips at several levels divided over the full range of the tank.

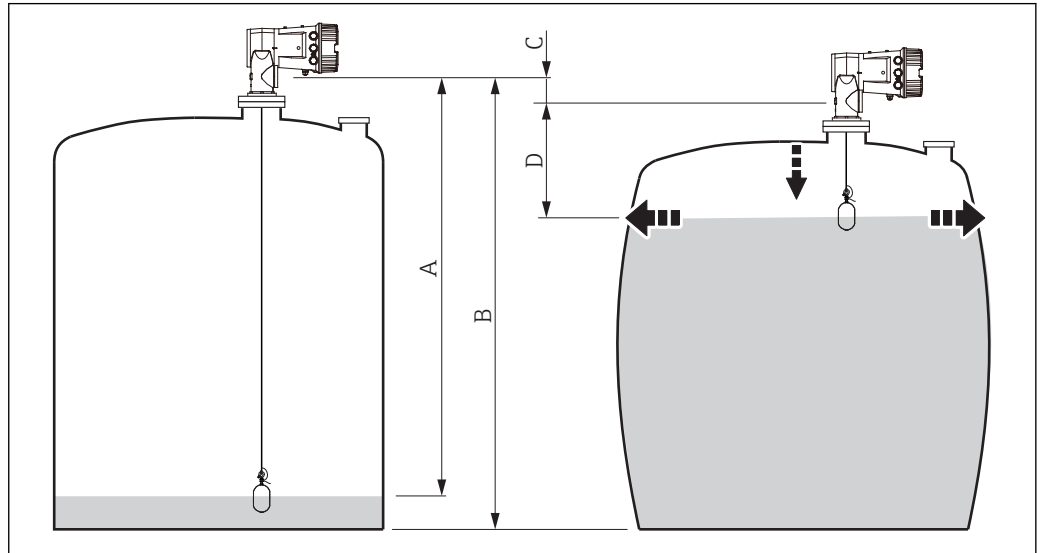

A0030164



61 Correction of the hydrostatic tank deformation (HyTD)

- A "Distance" (tank nearly empty)
- B Gauge Reference Height (GRH)
- C HyTD correction value
- D "Distance" (tank filled)

i The Correction of the Hydrostatic Tank Deformation is configured in the **HyTD** submenu (→ 268)

9.5.10 Tank calculation: Thermal tank shell correction (CTSh)

CTSh (correction for the thermal expansion of the tank shell) compensates for effects on the Gauge Reference Height (GRH) and on the expansion or contraction of the measuring wire due to temperature effects on the tank shell or stilling well. The temperature effects are separated into two parts, respectively affecting the 'dry' and 'wetted' part of the tank shell or stilling well. The correction function is based on thermal expansion coefficients of steel and insulation factors for both the 'dry' and 'wet' parts of the wire and the tank shell. The temperatures used for the correction can be selected from on manual or measured values.

-  This correction is recommended for the following situations:
 - if the operating temperature deviates considerably from the temperature during calibration ($\Delta T > 10\text{ }^{\circ}\text{C}$ (18 °F))
 - for extremely high tanks
 - for refrigerated, cryogenic or heated applications
-  As the use of this correction will influence the innage level reading, it is recommended to ensure the manual hand dip and level verification procedures are being conducted correctly before enabling this correction method.
-  This mode cannot be used in conjunction with HTG because the level is not measured relative to the gauge reference height with HTG.

9.5.11 Configuration of the alarms (limit evaluation)

A limit evaluation can be configured for up to 4 tank variables. The limit evaluation issues an alarm if the value exceeds an upper limit or falls below a lower limit, respectively. The limit values can be defined by the user.

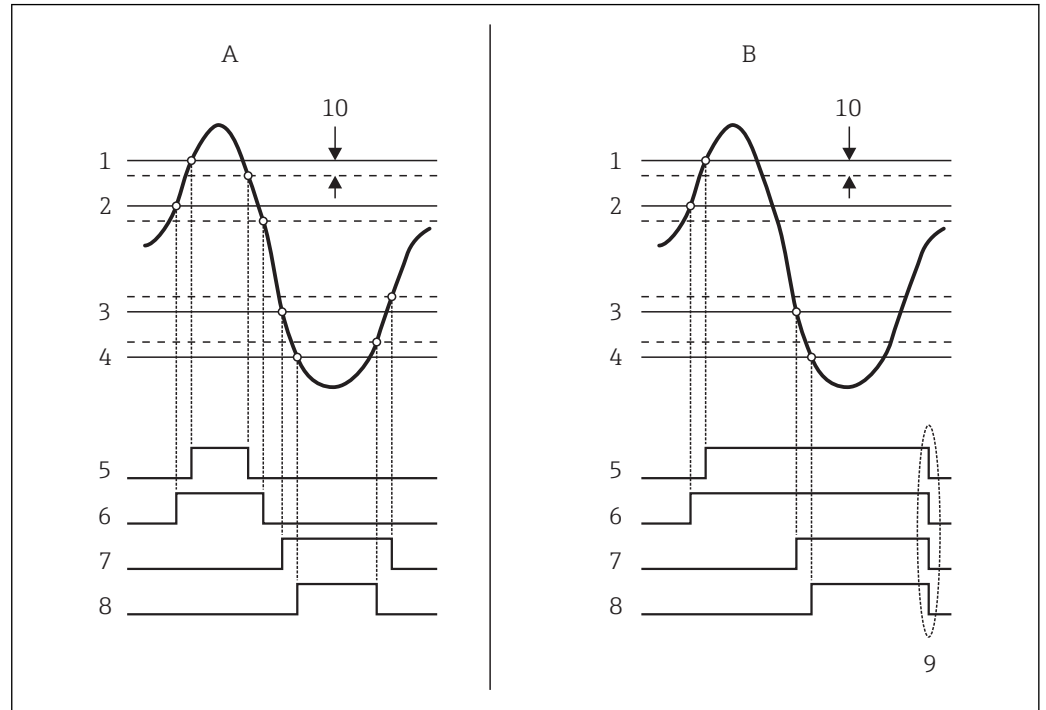

A0029539

62 Principle of the limit evaluation

- A Alarm mode = On
- B Alarm mode = Latching
- 1 HH alarm value
- 2 H alarm value
- 3 L alarm value
- 4 LL alarm value
- 5 HH alarm
- 6 H alarm
- 7 L alarm
- 8 LL alarm
- 9 "Clear alarm" = "Yes" or power off-on
- 10 Hysteresis

The limit evaluation is configured in the **Alarm 1 to 4** submenus.

Navigation path: Setup → Advanced setup → Alarm → Alarm 1 to 4

i For **Alarm mode = Latching** all alarms remain active until the user selects **Clear alarm = Yes** or the power is switched off and on.

9.5.12 Configuration of the 4-20mA output

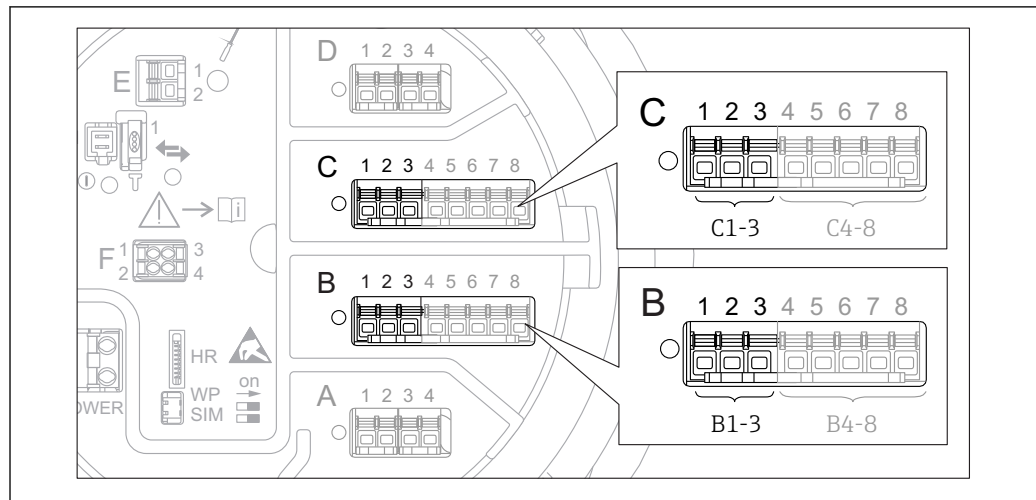

63 Possible locations of the Analog I/O modules, which can be used as a 4-20mA output. The order code of the device determines which of these modules is actually present → 49.

Each Analog I/O module of the device can be configured as a 4...20mA analog output. To do so, proceed as follows:

1. Navigate to: Setup → Advanced setup → Input/output → Analog I/O X1-3.
2. Go to the **Operating mode** parameter and select **4..20mA output** or **HART slave +4..20mA output**³⁾.
3. Go to the **Analog input source** parameter and select the tank variable which is to be transmitted via the 4...20mA output.
4. Go to the **0 % value** parameter and enter the value of the selected tank variable which will be mapped to 4 mA.
5. Go to the **100 % value** parameter and enter the value of the selected tank variable which will be mapped to 20 mA.

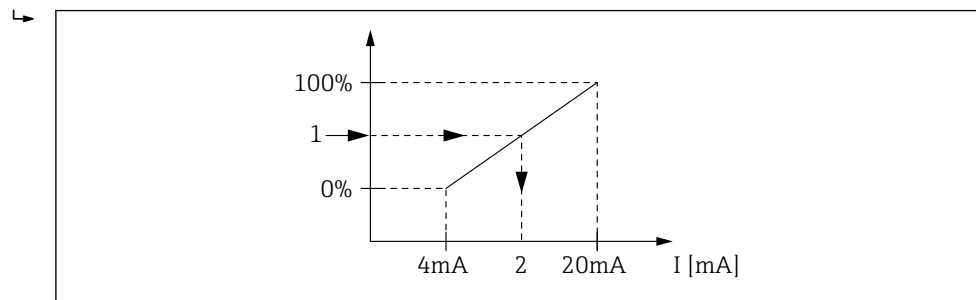

64 Scaling of the tank variable to the output current

- 1 Tank variable
- 2 Output current



i After startup of the device, as long as the assigned tank variable is not yet available, the output current assumes the defined error value.

i The **Analog I/O** submenu contains more parameters which can be used for a more detailed configuration of the analog output. For a description see → 213

3) "HART slave +4..20mA output" means that the Analog I/O module serves as a HART slave which cyclically sends up to four HART variables to a HART master. For the configuration of the HART output: → 123

9.5.13 Configuration of the HART slave + 4-20mA output

If **Operating mode = HART slave +4..20mA output** has been selected for an Analog I/O module, it serves as a HART slave which sends up to four HART variables to a HART master.

 The 4-20 mA signal can be used in this case, too. For its configuration: →  122

Standard case: PV = 4-20mA signal

By default, the Primary Variable (PV) is identical to the tank variable transmitted by the 4-20mA output. To define the other HART variables and to configure the HART output in more detail, proceed as follows:

1. Navigate to: Setup → Advanced setup → Communication → HART output → Configuration
2. Go to the **System polling address** parameter and set the HART slave address of the device.
3. Use the following parameters to assign tank variables to the second to fourth HART variable: **Assign SV**, **Assign TV**, **Assign QV**.
 - ↳ The four HART variables are transmitted to a connected HART Master.

Special case: PV ≠ 4-20mA signal

In exceptional cases it might be required that the Primary Variable (PV) transmits a different tank variable than the 4-20mA output. This is configured as follows.

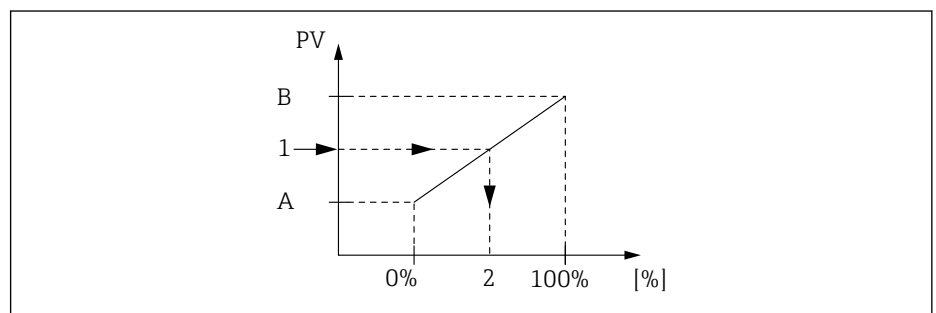

1. Navigate to: Setup → Advanced setup → Communication → HART output → Configuration
2. Go to the **PV source** parameter and select **Custom**.
 - ↳ The following additional parameters appear in the submenu: **Assign PV**, **0 % value**, **100 % value** and **PV mA selector**.
3. Go to the **Assign PV** parameter and select the tank variable to be transmitted as the Primary Variable (PV).
4. Use the **0 % value** and **100 % value** parameters to define a range for the PV. The **Percent of range** parameter indicates the percentage for the actual value of the PV. It is included in the cyclical output to the HART master.
 - ↳



 65 Scaling of the tank variable to the percentage

- A 0 % value
- B 100 % value
- 1 Primary variable (PV)
- 2 Percent of range

5. Use the **PV mA selector** parameter to define whether the output current of an Analog I/O module is to be included in the cyclical HART output.

-  After startup of the device, as long as the assigned tank variable is not yet available, the output current assumes the defined error value.
-  The **PV mA selector** parameter does not influence the output current at the terminals of the Analog I/O module. It only defines whether the value of this current is part of the HART output or not.

9.5.14 Configuration of the Modbus output

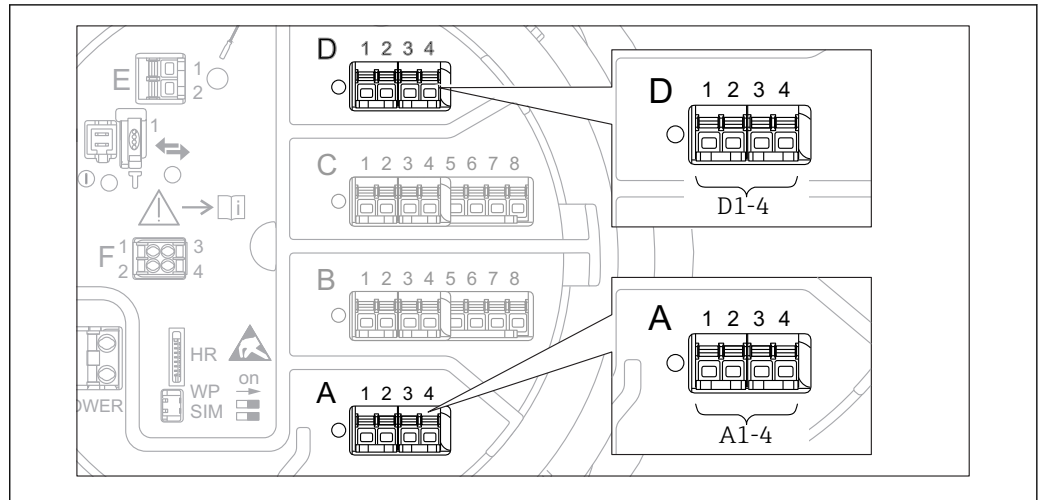

66 Possible locations of the Modbus modules (examples); depending on the device version these modules may also be in slot B or C → 49.

The Proservo NMS8x acts as a Modbus slave. Measured or calculated tank values are stored in registers which can be requested by a Modbus master.

The following submenu is used to configure the communication between the device and the Modbus master:

Setup → Advanced setup → Communication → Modbus X1-4 → Configuration (→ 233)

9.5.15 Configuration of the V1 output

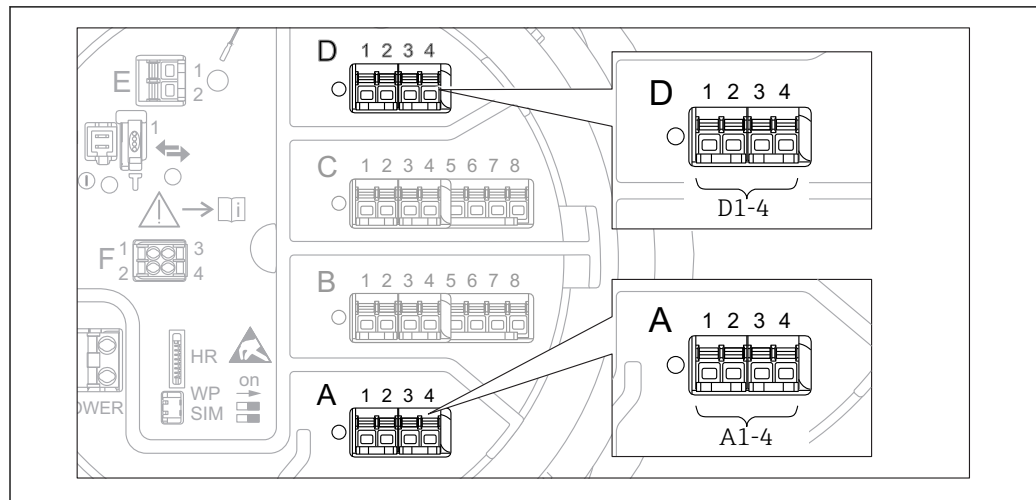

A0031200

67 Possible locations of the V1 modules (examples); depending on the device version these modules may also be in slot B or C → 49.

The following submenus are used to configure the V1 communication between the device and the control system:

- Setup → Advanced setup → Communication → V1 X1-4 → Configuration (→ 236)
- Setup → Advanced setup → Communication → V1 X1-4 → V1 input selector (→ 239)

9.5.16 Configuration of the digital outputs

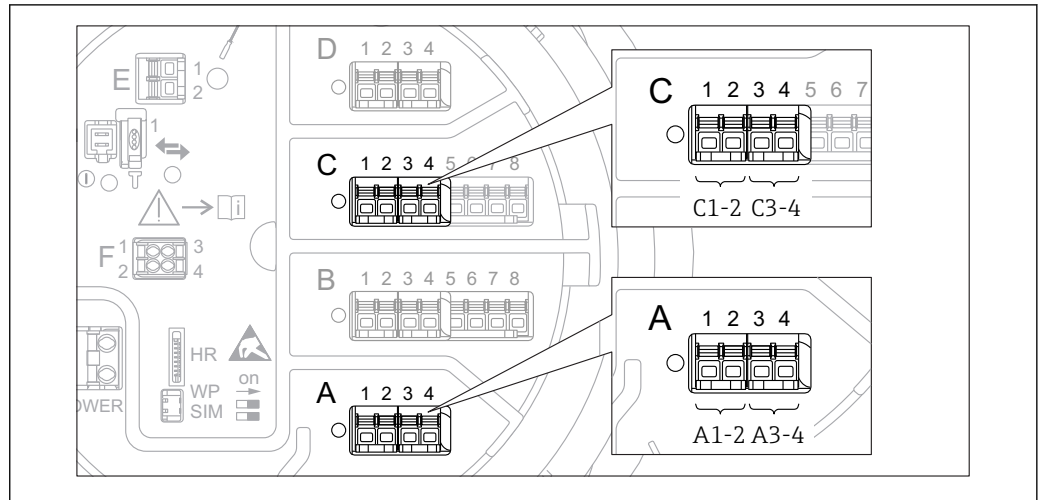

A0026424

68 Possible locations of the Digital I/O modules (examples); the order code defines the number and location of Digital I/O modules → 49.

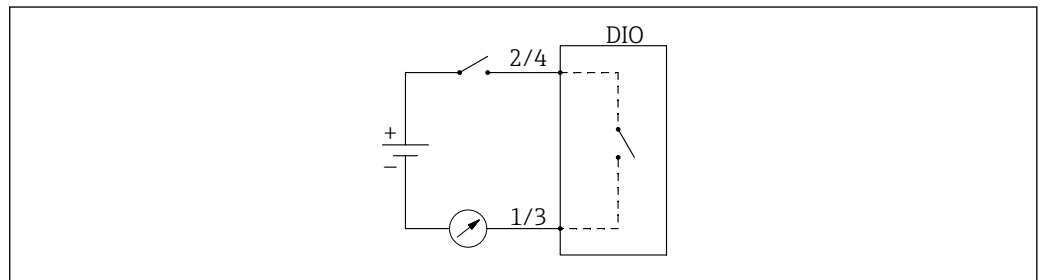

A0033029

69 Usage of the Digital I/O module as a digital output

There is a **Digital Xx-x** submenu for each digital I/O module of the device. "X" designates the slot in the terminal compartment, "x-x" the terminals within this slot. The most important parameters of this submenu are **Operating mode**, **Digital input source** and **Contact type**.

A digital output can be used to

- output the state of an alarm (if an alarm has been configured → 121)
- transmit the status of a digital input (if a digital input has been configured → 114)

To configure a digital output, proceed as follows:

1. Navigate to Setup → Advanced setup → Input/output → Digital Xx-x, where Xx-x designates the digital I/O module to be configured.
2. Go to the **Operating mode** parameter and select the **Output passive** option.
3. Go to the **Digital input source** parameter and select the alarm or digital input to be transmitted.
4. Go to the **Contact type** parameter and select how the internal state of the alarm or digital input is to be mapped to the digital output (see table below).

<ul style="list-style-type: none"> ▪ State of the alarm ▪ Internal state of the digital input 	Switching state of the digital output	
	Contact type = Normally open	Contact type = Normally closed
Inactive	Open	Closed
Active	Closed	Open

- i
 - For SIL applications, **Contact type** is automatically set to **Normally closed** by the device when starting the SIL confirmation procedure.
 - In case of a power supply failure, the switching state is always "open", irrespective of the selected option.
 - The **Digital Xx-x** submenu contains additional parameters for a more detailed configuration of the Digital Input. For a description refer to →  223.

9.6 Advanced settings



For a more detailed configuration of the signal inputs, the tank calculations and the signal outputs refer to the **Advanced setup** submenu (→  199).

9.7 Simulation

To check the correct configuration of the device and of the control system, it is possible to simulate different situations (measured values, diagnostic messages etc.). See the **Simulation** submenu (→  323) for details.

9.8 Protecting settings from unauthorized access



There are two possibilities to protect the settings from unauthorized access:

- By an access code (→  76)
This locks the access via the display and operating module.
- By the protection switch (→  77)
This locks the access to W&M-related parameters by any user interface (display and operating module, FieldCare, other configuration tools).

10 Operation

10.1 Reading off the device locking status

Depending on the locking state of the device some operations may be locked. The current locking status is indicated at: Setup → Advanced setup → Locking status. The following table summarizes the different locking statuses:

Locking status	Meaning	Unlocking procedure
Hardware locked	The device is locked by the write-protection switch in the terminal compartment.	→  77
SIL locked	The device is in SIL-locked mode.	See the SIL Safety manual
CT active - all parameters	The custody transfer mode is active.	→  77
WHG locked (in preparation)	The device is in WHG-locked mode.	in preparation
Temporarily locked	Write access to the parameters is temporarily lock due to device-internal processing (e.g. data upload/download, reset). Once the internal processing has been completed, the parameters can be changed again.	Wait for completion of the device-internal processing.

A locking is indicated by the write protection symbol in the header of the display:

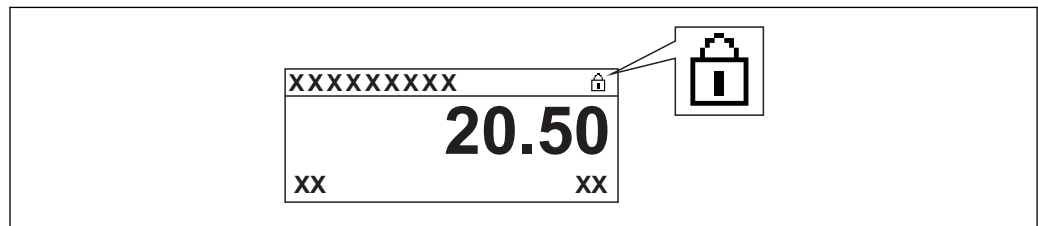

A0015870

10.2 Reading off measured values

Tank values can be read off in the following submenus:

- Operation → Level
- Operation → Temperature
- Operation → Density
- Operation → Pressure

10.3 Gauge commands

10.3.1 Overview of available device functions

Gauge commands are mainly divided into two categories.

- Continuous gauge command
- One-time gauge command (non-continuous)

i One-time gauge commands have a defined end state. After a one-time gauge command is completed, another gauge command is executed which is defined by the **Post gauge command** parameter. If **Post gauge command** is set to **None**, the operation will stop.

The gauge command can be chosen by navigating to Operation → Gauge command. The status of the gauge command execution is shown in the **Gauge status** parameter. The gauge status is displayed on the home screen by default.

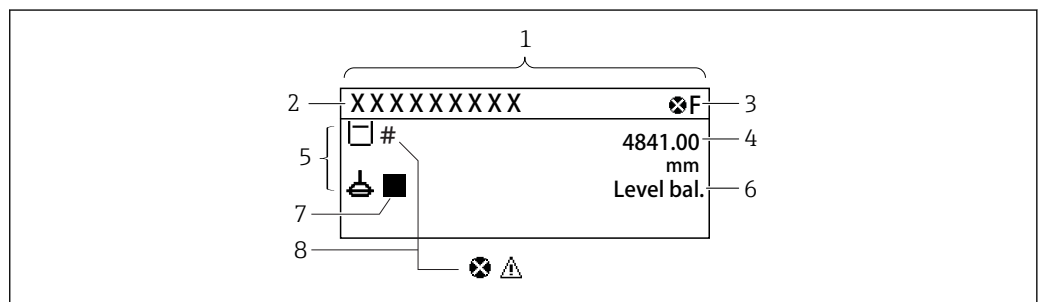

A0028702

70 Typical appearance of the standard view (measured value display)

- 1 Display module
- 2 Device tag
- 3 Status area
- 4 Display area for measured values
- 5 Display area for measured value and status symbols
- 6 Gauge status indication
- 7 Gauge status symbol
- 8 Measured value status symbol

For details of status symbols → **66**





When a one-time gauge command is executed, additional information is shown in the **One-time command status** parameter in the operation menu.

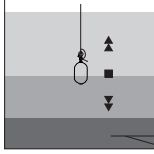
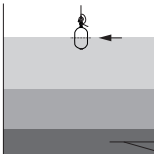
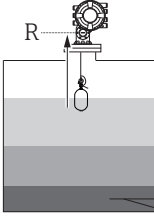
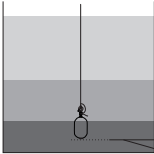
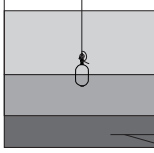
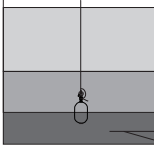
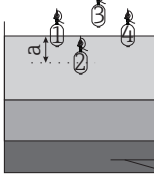

10.3.2 Descriptions of gauge commands

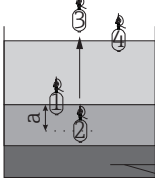
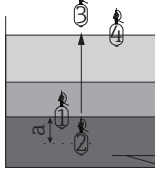
The following table shows the available gauge commands and functions of NMS8x.

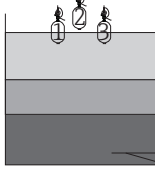
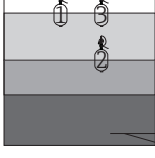
 The numbers in the figures show the sequence of displacer movement.

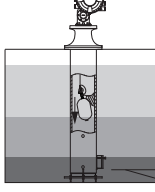
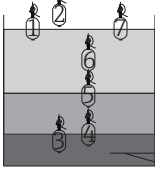
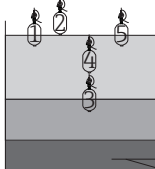
Gauge command	Descriptions		Post gauge command
Stop	Displacer stops.		Not available
Level	The displacer searches for the liquid level surface and balances there.		Not available
Up	The displacer moves up to the reference position.	 <i>R Reference position</i>	Not available
Bottom level	The displacer searches for the tank bottom. After determining the bottom value, the post gauge command is executed.		Customer setting value
Upper I/F level	The displacer searches for the upper interface level and balances there.		Not available
Lower I/F level	The displacer searches for the lower interface level and balances there.		Not available
Upper density	NMS8x performs a spot density measurement in the upper phase of the tank. After completing the measurement, the post gauge command is executed.	 <i>a Immersion depth</i>	Customer setting value

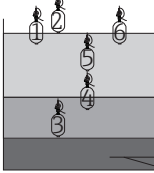
Gauge command	Descriptions		Post gauge command
Middle density	<p>NMS8x performs a spot density measurement in the middle phase of the tank. After completing the measurement, the post gauge command is executed.</p>	 <p><i>a</i> Immersion depth</p>	Customer setting value
Lower density	<p>NMS8x performs a spot density measurement in the lower phase of the tank. After completing measurement, the post gauge command is executed.</p>	 <p><i>a</i> Immersion depth</p>	Customer setting value
Repeatability	<p>The displacer is taken out of the liquid. After that, the displacer returns to the level measurement. This can be used for a function check.</p> <p> This gauge command should only be executed if the current gauge command is level.</p>		Level
Water dip	<p>The displacer searches for the upper interface level. After balancing on the liquid, the post gauge command is executed.</p>		Customer setting value
Release overtension	<p>When the displacer hits any obstacle in the tank and gets stuck (Error message: Overtension) this command will release the tension on the wire by moving down a short distance.</p> <p> During an overtension error, no other gauge command will be executed.</p>		Stop
Tank profile	<p>Density profile measurement of the tank (tank bottom to level)</p>		Customer setting value
Interface profile	<p>Density profile measurement of the upper interface (upper I/F level to level)</p>		Customer setting value

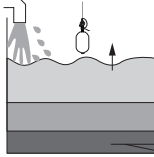
Gauge command	Descriptions		Post gauge command
Manual profile	Density profile measurement from a manually set position to level		Customer setting value
Level standby	<p>The displacer moves to a set position and stays there until the tank level reaches this position. After that, gauge command is changed back to level.</p> <p> This function can be used when supplying or discharging liquid.</p>		Level

10.3.3 Sources for gauge commands

Gauge commands can be sent via various sources.

- Displays or CDI (e.g. FieldCare)
- Digital input (e.g. control switch)
- Fieldbus (Modbus, V1, HART)

The last received gauge command via any sources will be executed as usual.

i During calibration, gauge commands are not accepted from any sources.

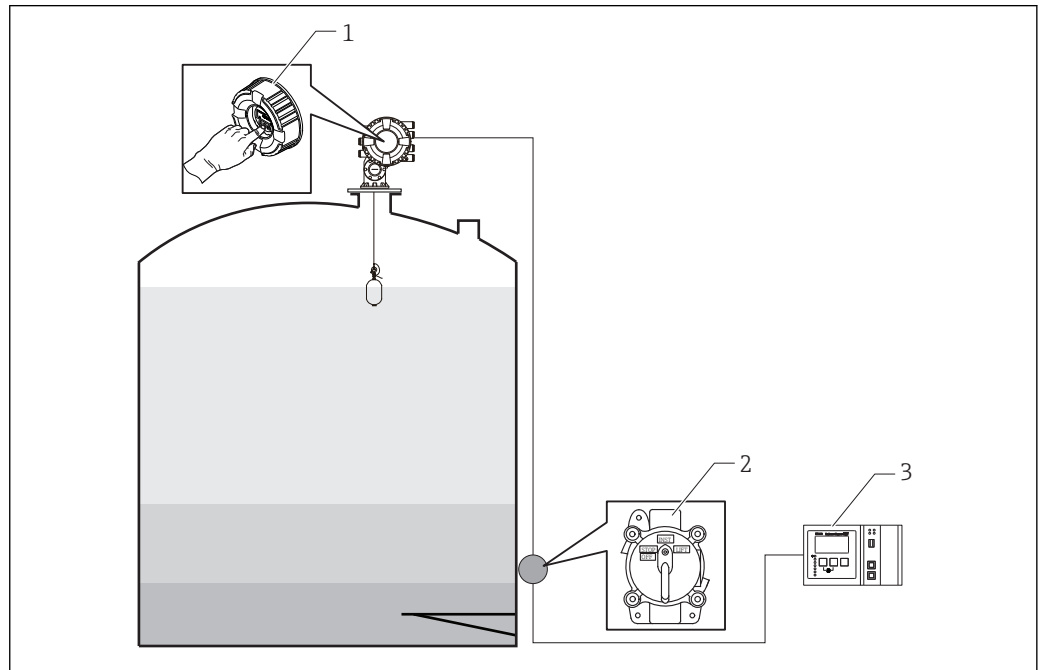

- 1 Display operation
- 2 Digital input (e.g. control switch)
- 3 Tankvision

Gauge command priorities

The priority of the gauge command for NMS8x is very simple. The last received gauge command via any sources will be executed to take of the former gauge command. However the priority varies depending on the devices. When replacing the device with the NMS8x, check the priorities shown below.

NOTICE

Undesired gauge command will be executed.

If the setting is not changed, an undesired gauge command will be executed (e.g. Level command via Fieldbus would overwrite Stop command for maintenance.).

- ▶ If the system has been automatically or semi-automatically programmed for operation, maintenance or other purposes, the setting should be changed corresponding to use.

Proservo NMS8x

By display		From digital input		From Fieldbus	
Command	Priority	Command	Priority	Command	Priority
Level	1	Level	1	Level	1
Interface	1	Interface	1	Interface	1
Tank bottom	1	Tank bottom	1	Tank bottom	1

By display		From digital input		From Fieldbus	
Spot density	1	Spot density	1	Spot density	1
Profile density	1	Profile density	1	Profile density	1
Up	1	Up	1	Up	1
Stop	1	Stop	1	Stop	1

Proservo NMS5/NMS7

By display		From NRF560		From digital input		From Fieldbus	
Command	Priority	Command	Priority	Command	Priority	Command	Priority
Level	4	Level	4	Level	4	Level	4
Interface	2	Interface	3	Interface	1	Interface	4
Tank bottom	2	Tank bottom	3	N/A	N/A	Tank bottom	4
Spot density	2	Spot density	3	N/A	N/A	Spot density	4
Profile density	2	Profile density	3	N/A	N/A	Profile density	4
Up	2	Up	3	Up	1	Up	4
Stop	2	Stop	3	Stop	1	Stop	4

Servo level gauge TGM5

By display		From NRF560		From DRM9700		From digital input		From Fieldbus	
Command	Priority	Command	Priority	Command	Priority	Command	Priority	Command	Priority
Level	4	Level	4	Level	4	Level	4	Level	4
Interface	2	Interface	3	N/A	N/A	N/A	N/A	Interface	4
Tank bottom	2	Tank bottom	3	N/A	N/A	N/A	N/A	Tank bottom	4
Spot density	2	Spot density	3	N/A	N/A	N/A	N/A	Spot density	4
Profile density	2	Profile density	3	N/A	N/A	N/A	N/A	Profile density	4
Up	2	Up	3	Up	1	Up	1	Up	4
Stop	2	Stop	3	N/A	N/A	Stop	1	Stop	4

Servo level gauge TGM4000

By display		From DRM9700		From digital input		From Fieldbus	
Command	Priority	Command	Priority	Command	Priority	Command	Priority
Level	4	Level	4	Level	4	Level	4
Interface	2	Interface	1	N/A	N/A	Interface	4
Tank bottom	2	N/A	N/A	N/A	N/A	Tank bottom	4
Spot density	2	N/A	N/A	N/A	N/A	Spot density	4
Profile density	2	N/A	N/A	N/A	N/A	Profile density	4
Up	2	Up	1	Up	1	Up	4
Stop	2	Stop	N/A	Stop	1	Stop	4

11 Diagnostics and troubleshooting

11.1 General trouble shooting

11.1.1 General errors

Error	Possible cause	Remedial action
Device does not respond.	Supply voltage not connected.	Connect the correct voltage.
	The cables do not contact the terminals properly.	Ensure electrical contact between the cable and the terminal.
Values on the display invisible	The plug of the display cable is not connected correctly.	Connect the plug correctly.
	Display is defective.	Replace display.
	Display contrast too low.	Set Setup → Advanced setup → Display → Contrast display to a value ≥ 60 %.
"Communication error" is indicated on the display when starting the device or connecting the display	Electromagnetic interference	Check grounding of the device.
	Broken display cable or display plug.	Exchange display.
CDI communication does not work.	Wrong setting of the COM port on the computer.	Check the setting of the COM port on the computer (e.g. FieldCare) and change it if necessary.
Device measures incorrectly.	Parametrization error	Check and adjust parameterization.

11.2 Diagnostic information on local display

11.2.1 Diagnostic message

Faults detected by the self-monitoring system of the measuring device are displayed as a diagnostic message in alternation with the measured value display.

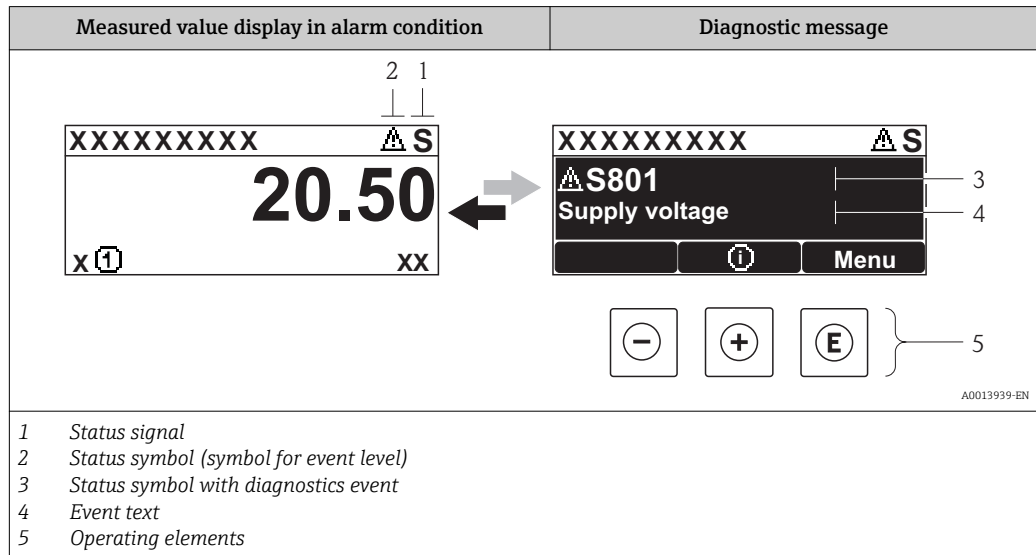

Status signals

F <small>A0013956</small>	"Failure" A device error is present. The measured value is no longer valid.
C <small>A0013959</small>	"Function check" The device is in service mode (e.g. during a simulation or a warning).
S <small>A0013958</small>	"Out of specification" The device is operated: <ul style="list-style-type: none"> ▪ Outside of its technical specifications (e.g. during startup or a cleaning) ▪ Outside of the configuration carried out by the user (e.g. level outside configured span)
M <small>A0013957</small>	"Maintenance required" Maintenance is required. The measured value is still valid.

Status symbol (symbol for event level)

 <small>A0013961</small>	"Alarm" status The measurement is interrupted. The signal outputs take on the defined alarm condition. A diagnostic message is generated.
 <small>A0013962</small>	"Warning" status The device continues to measure. A diagnostic message is generated.

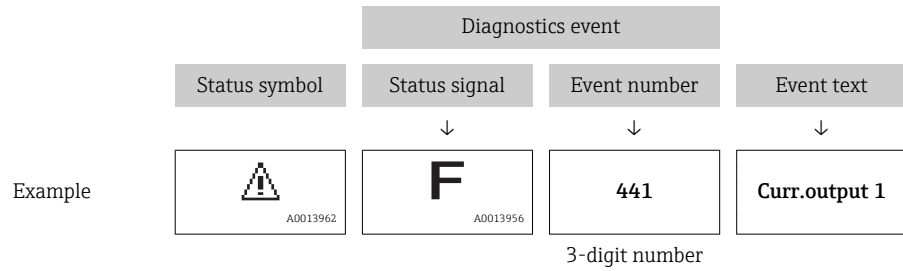

Diagnostics event and event text

The fault can be identified using the diagnostics event. The event text helps you by providing information about the fault. In addition, the corresponding symbol is displayed before the diagnostics event.



If two or more diagnostic messages are pending simultaneously, only the message with the highest priority is shown. Additional pending diagnostic messages can be shown in **Diagnostic list** submenu (→  319).

Operating elements

Operating functions in menu, submenu	
 A0013970	Plus key Opens the message about the remedial measures.
 A0013952	Enter key Opens the operating menu.

11.2.2 Calling up remedial measures

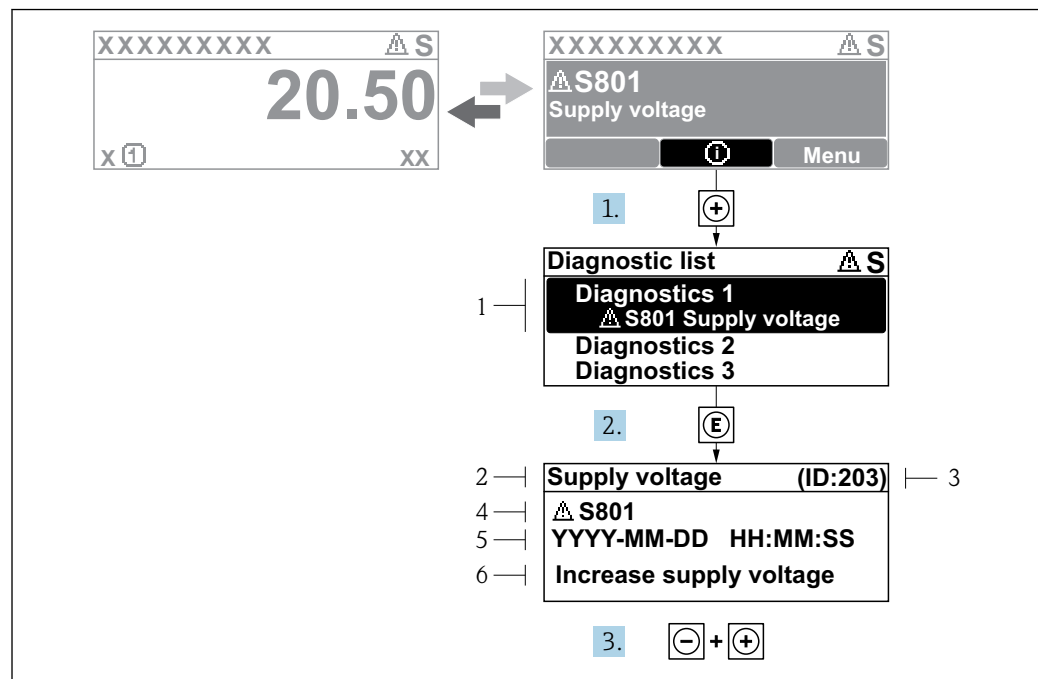

A0032957-EN

71 Message for remedial measures

- 1 Diagnostic information
- 2 Short text
- 3 Service ID
- 4 Diagnostic behavior with diagnostic code
- 5 Operation time of occurrence
- 6 Remedial measures

A diagnostic message appears in the standard view (measured value display).

1. Press \oplus (ⓘ symbol).
 - ↳ The **Diagnostic list** submenu opens.
2. Select the desired diagnostic event with \oplus or \ominus and press ⏏ .
 - ↳ The message for the remedial measures for the selected diagnostic event opens.
3. Press $\ominus + \oplus$ simultaneously.
 - ↳ The message for the remedial measures closes.

The user is in the **Diagnostics** menu at an entry for a diagnostics event, e.g. in the **Diagnostic list** submenu or in the **Previous diagnostics**.

1. Press ⏏ .
 - ↳ The message for the remedial measures for the selected diagnostic event opens.
2. Press $\ominus + \oplus$ simultaneously.
 - ↳ The message for the remedial measures closes.

11.3 Diagnostic information in FieldCare

Any faults detected by the measuring device are displayed on the home page of the operating tool once the connection has been established.

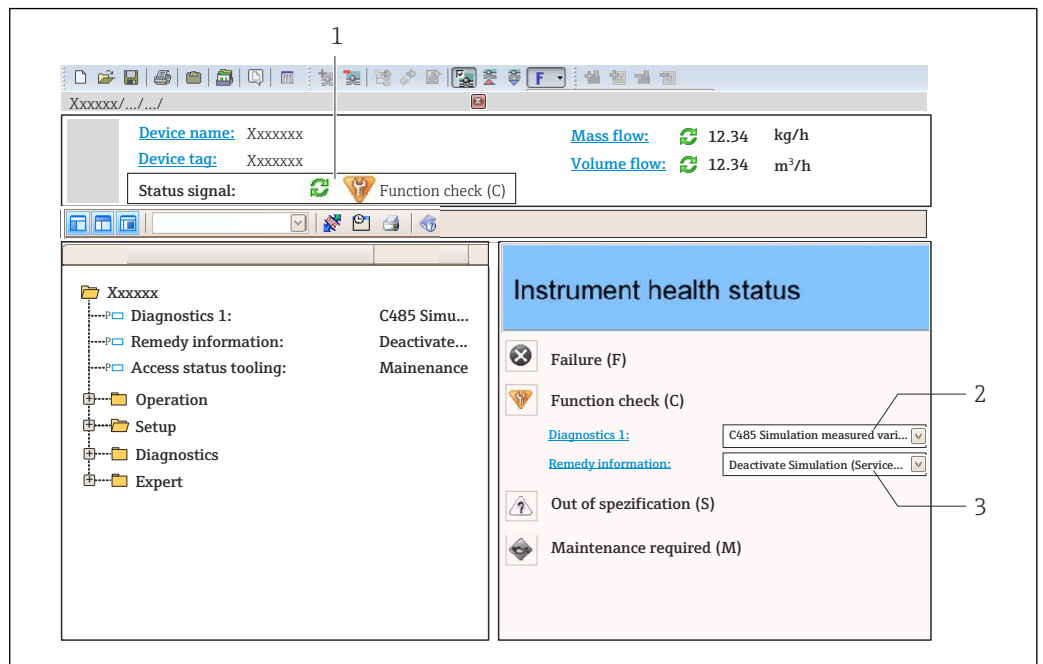

- 1 Status area with status signal
- 2 Diagnostic information
- 3 Remedial measures with Service ID

i Furthermore, diagnostic events that have occurred can be viewed in the **Diagnostic list** submenu.

11.3.1 Status signals

The status signals provide information on the state and reliability of the device by categorizing the cause of the diagnostic information (diagnostic event).

Symbol	Meaning
 <small>A0017271</small>	Failure A device error has occurred. The measured value is no longer valid.
 <small>A0017278</small>	Function check The device is in service mode (e.g. during a simulation or a warning).
 <small>A0017277</small>	Out of specification The device is operated outside its technical specification limits (e.g. outside the process temperature range)
 <small>A0017276</small>	Maintenance required Maintenance is required. The measured value is still valid.

i The status signals are categorized in accordance with VDI/VDE 2650 and NAMUR Recommendation NE 107.

11.3.2 Calling up remedy information

Remedy information is provided for every diagnostic event to ensure that problems can be rectified quickly:

- On the home page
Remedy information is displayed in a separate field below the diagnostics information.
- In the **Diagnostics** menu
Remedy information can be called up in the working area of the user interface.

The user is in the **Diagnostics** menu.

1. Call up the desired parameter.
2. On the right in the working area, mouse over the parameter.
 - ↳ A tool tip with remedy information for the diagnostic event appears.

11.4 Overview of the diagnostic messages

Diagnostic number	Short text	Remedy instructions	Status signal [from the factory]	Diagnostic behavior [from the factory]
Diagnostic of sensor				
102	Sensor incompatible error	1. Restart device 2. Contact service	F	Alarm
150	Detector error	1. Restart device 2. Check electrical connections of detector 3. Replace detector unit	F	Alarm
151	Sensor electronic failure	Replace sensor electronic module	F	Alarm
Diagnostic of electronic				
242	Software incompatible	1. Check software 2. Flash or change main electronics module	F	Alarm
252	Modules incompatible	1. Check if correct electronic modul is plugged 2. Replace electronic module	F	Alarm
261	Electronic modules	1. Restart device 2. Check electronic modules 3. Change I/O Modul or main electronics	F	Alarm
262	Module connection	1. Check module connections 2. Change electronic modules	F	Alarm
270	Main electronic failure	Replace main electronics	F	Alarm
271	Main electronic failure	1. Restart device 2. Change main electronic module	F	Alarm
272	Main electronic failure	1. Restart device 2. Contact service	F	Alarm
273	Main electronic failure	1. Emergency operation via display 2. Change main electronics	F	Alarm
275	I/O module failure	1. Restart device 2. Change I/O module	F	Alarm
276	I/O module faulty	1. Restart device 2. Change I/O module	F	Alarm
282	Data storage	1. Restart device 2. Contact service	F	Alarm
283	Memory content	1. Transfer data or reset device 2. Contact service	F	Alarm
284	Detector SW update in progress	Firmware update active, please wait!	F	Alarm
311	Electronic failure	Maintenance required! 1. Do not perform reset 2. Contact service	M	Warning
333	System recovery required	HW change detected System configuration recovery required Go to menu on device and perform recovery	F	Alarm
334	System recovery failure	HW changed, system recovery failure. Return to factory	F	Alarm

Diagnostic number	Short text	Remedy instructions	Status signal [from the factory]	Diagnostic behavior [from the factory]
381	Displacer distance invalid	1. Calibrate sensor 2. Restart device 3. Replace sensor electronics	F	Alarm
382	Sensor communication	1. Check connection of sensor electronics 2. Restart device 3. Replace sensor electronics	F	Alarm
Diagnostic of configuration				
400	AIO simulation output	Deactivate simulation AIO output	C	Warning
401	DIO simulation output	Deactivate simulation DIO output	C	Warning
403	Calibration AIO	1. Restart device 2. Change I/O module	F	Alarm
404	Calibration AIP	1. Restart device 2. Change I/O module	F	Alarm
405	COMM timeout DIO 1 to 8	1. Check wiring 2. Change I/O module	F	Alarm
406	IOM offline	1. Check wiring 2. Change I/O module	F	Alarm
407	COMM timeout AIO 1 to 2	1. Check wiring 2. Change I/O module	F	Alarm
408	Invalid range AIO 1 to 2	1. Check device configuration. 2. Check wiring.	C	Warning
409	RTD temp out of range 1 to 2	1. Check electronic modules 2. Change I/O or main electronic module	C	Warning
410	Data transfer	1. Check connection 2. Retry data transfer	F	Alarm
411	Hart device 1 to 15 has malfunction	1. Check HART device 2. Change HART device	F	Alarm ¹⁾
412	Processing download	Download active, please wait	C	Warning
413	NMT 1 to 15: element is open or short	1. Check NMT wiring connection 2. Replace NMT	C	Warning
415	Hart device 1 to 15 offline	1. Check HART device 2. Change HART device	C	Warning
434	Real time clock defective	Replace main electronics	C	Warning
436	Date/Time incorrect	Check date and time settings.	M	Warning
437	Configuration incompatible	1. Restart device 2. Contact service	F	Alarm
438	Dataset	1. Check data set file 2. Check device configuration 3. Up- and download new configuration	M	Warning
441	AIO 1 to 2 current output alarm	1. Check process 2. Check current output settings	F	Alarm
442	AIO 1 to 2 current output warning	1. Check process 2. Check current output settings	C	Warning
443	AIO 1 to 2 Input not HART compatible	Change PV source or AIO input source.	C	Warning
484	Failure mode simulation	Deactivate simulation	C	Alarm

Diagnostic number	Short text	Remedy instructions	Status signal [from the factory]	Diagnostic behavior [from the factory]
495	Diagnostic event simulation	Deactivate simulation	C	Warning
500	AIO C1-3 source no longer valid	Change input source	C	Warning
501	Level source no longer valid	Change input source	C	Warning
502	GP1 source no longer valid	Change input source	C	Warning
503	GP2 source no longer valid	Change input source	C	Warning
504	GP3 source no longer valid	Change input source	C	Warning
505	GP4 source no longer valid	Change input source	C	Warning
506	Water level source no longer valid	Change input source	C	Warning
507	Liquid temp source no longer valid	Change input source	C	Warning
508	Vapor temperatur source no longer valid	Change input source	C	Warning
509	Air temperature source no longer valid	Change input source	C	Warning
510	P1 source no longer valid	Change input source	C	Warning
511	P2 source no longer valid	Change input source	C	Warning
512	P3 source no longer valid	Change input source	C	Warning
513	Upper density source no longer valid	Change input source	C	Warning
514	Middle density source no longer valid	Change input source	C	Warning
515	Lower density source no longer valid	Change input source	C	Warning
516	Gauge command source no longer valid	Change input source	C	Warning
517	Gauge status source no longer valid	Change input source	C	Warning
518	Average density source no longer valid	Change input source	C	Warning
519	Upper interface source no longer valid	Change input source	C	Warning
520	Lower interface source no longer valid	Change input source	C	Warning
521	Bottom level source no longer valid	Change input source	C	Warning
522	Displacer position source not valid	Change input source	C	Warning
523	Distance source no longer valid	Change input source	C	Warning
524	Balance flag source no longer valid	Change input source	C	Warning
525	One time cmd source no longer valid	Change input source	C	Warning
526	Alarm 1 to 4 source no longer valid	Change input source	C	Warning

Diagnostic number	Short text	Remedy instructions	Status signal [from the factory]	Diagnostic behavior [from the factory]
527	AIO B1-3 source no longer valid	Change input source	C	Warning
528	CTSh	1. Check device configuration. 2. Check wiring.	C	Warning
529	HTG	1. Check device configuration. 2. Check wiring.	C	Warning
530	HTMS	1. Check device configuration. 2. Check wiring.	C	Warning
531	HyTD correction value	1. Check device configuration. 2. Check wiring.	C	Warning
532	HART output: PV source not valid	Change input source	C	Warning
533	HART output: SV source not valid	Change input source	C	Warning
534	HART output: QV source not valid	Change input source	C	Warning
535	HART output: TV source not valid	Change input source	C	Warning
536	Display: source no longer valid	Change input source	C	Warning
537	Trend: source no longer valid	Change input source	C	Warning
538	HART output: PV mA source not valid	Change input source	C	Warning
539	Modbus 1-4 SP source invalid	Set valid SP input selector	C	Warning
540	V1 1-4 SP source invalid	Set valid SP input selector	C	Warning
541	Modbus 1-4 alarm source invalid	Set valid alarm input selector	C	Warning
542	V1 1-4 alarm source invalid	Set valid alarm input selector	C	Warning
543	Modbus 1-4 analog source invalid	Set valid analog input selector	C	Warning
544	V1 1-4 analog source invalid	Set valid analog input selector	C	Warning
545	Modbus 1-4 user value source invalid	Set valid user value input selector	C	Warning
546	Modbus 1-4 discrete value source invalid	Set valid user discrete input selector	C	Warning
547	V1 1-4 user value source invalid	Set valid user value input selector	C	Warning
548	V1 1-4 discrete value source invalid	Set valid user discrete input selector	C	Warning
549	Modbus 1-4 percent source invalid	Set valid percentage input selector	C	Warning
550	V1 1-4 percent source invalid	Set valid percentage input selector	C	Warning
560	Calibration mandatory	1. Carry out weight calibration 2. Carry out reference calibration 3. Carry out drum calibration	C	Alarm
564	DIO B1-2 source no longer valid	Change input source	C	Warning
565	DIO B3-4 source not valid	Change input source	C	Warning

Diagnostic number	Short text	Remedy instructions	Status signal [from the factory]	Diagnostic behavior [from the factory]
566	DIO C1-2 source no longer valid	Change input source	C	Warning
567	DIO C3-4 source no longer valid	Change input source	C	Warning
568	DIO D1-2 source no longer valid	Change input source	C	Warning
569	DIO D3-4 source no longer valid	Change input source	C	Warning
585	Simulation distance	Deactivate simulation	C	Warning
586	Record map	Recording of mapping please wait	C	Warning
598	DIO A1-2 source no longer valid	Change input source	C	Warning
599	DIO A3-4 source no longer valid	Change input source	C	Warning
Diagnostic of process				
801	Energy too low	Increase supply voltage	S	Warning
803	Current loop	1. Check device configuration. 2. Check wiring.	F	Alarm
803	Current loop 1 to 2		M	Warning
803	Current loop		C	Warning
825	System temperature	1. Check ambient temperature 2. Check process temperature	S	Warning
825	System temperature		F	Alarm
826	Sensor temperature	1. Check ambient temperature 2. Check process temperature	S	Warning
826	Sensor temperature		F	Alarm
844	Process value out of specification	1. Check process value 2. Check application 3. Check sensor	S	Alarm ¹⁾
844	Process value out of specification		S	Warning
903	Current loop 1 to 2	1. Check device configuration. 2. Check wiring.	F	Alarm
904	Digital output 1 to 8	1. Check device configuration. 2. Check wiring.	F	Alarm
941	Echo lost	1. Check process value 2. Check application 3. Check sensor	S	Warning
942	In safety distance	1. Check level 2. Check safety distance 3. Reset self holding	S	Warning
943	In blocking distance	Reduced accuracy Check level	S	Warning
950	Advanced diagnostics	Maintain your diagnostic event	M	Warning
961	Alarm 1 to 4 HighHigh	1. Check alarm source 2. Check configuration settings	C	Warning
962	Alarm 1 to 4 High	1. Check alarm source 2. Check configuration settings	C	Warning
963	Alarm 1 to 4 Low	1. Check alarm source 2. Check configuration settings	C	Warning

Diagnostic number	Short text	Remedy instructions	Status signal [from the factory]	Diagnostic behavior [from the factory]
964	Alarm 1 to 4 LowLow	1. Check alarm source 2. Check configuration settings	C	Warning
965	Alarm 1 to 4 HighHigh	1. Check alarm source 2. Check configuration settings	F	Alarm
966	Alarm 1 to 4 High	1. Check alarm source 2. Check configuration settings	F	Alarm
967	Alarm 1 to 4 Low	1. Check alarm source 2. Check configuration settings	F	Alarm
968	Alarm 1 to 4 LowLow	1. Check alarm source 2. Check configuration settings	F	Alarm
970	Overtension	1. Check displacer and process conditions 2. Release overtension	C	Alarm
971	Undertension	Check displacer and process.	C	Alarm

- 1) Diagnostic behavior can be changed.



11.5 Diagnostic list

In the Diagnostic list submenu, up to 5 currently pending diagnostic messages can be displayed. If more than 5 messages are pending, the messages with the highest priority are shown on the display.

Navigation path

Diagnostics → Diagnostic list

Calling up and closing the remedial measures

1. Press .
 - ↳ The message for the remedial measures for the selected diagnostic event opens.
2. Press  +  simultaneously.
 - ↳ The message about the remedial measures closes.

11.6 Reset measuring device

To reset the device to a defined state use the **Device reset** parameter (→  315).

11.7 Device information

Information on the device (order code, hardware and software version of the individual modules etc.) can be found in the **Device information** submenu (→  320).

11.8 Firmware history

Date	Software version	Modifications	Documentation (NMS80)		
			Operating Instructions	Description of Parameters	Technical Information
04.2016	01.00.zz	Original software	BA01456G/00/EN/01.16	GP01074G/00/EN/01.16	TI01248G/00/EN/01.16
12.2016	01.02.zz	Bugfixes and improvements	BA01456G/00/EN/02.17	GP01074G/00/EN/02.17	TI01248G/00/EN/02.17
07.2018	01.03.zz	Software update	BA01456G/00/EN/04.18	GP01074G/00/EN/03.18	TI01248G/00/EN/04.18

12 Maintenance

12.1 Maintenance tasks

No special maintenance work is required.

12.1.1 Exterior cleaning

When cleaning the exterior of measuring devices, always use cleaning agents that do not attack the surface of the housing or the seals.

12.2 Endress+Hauser services

Endress+Hauser offers a wide variety of services for maintenance such as recalibration, maintenance service or device tests.



Your Endress+Hauser Sales Center can provide detailed information on the services.

13 Repair

13.1 General information on repairs

13.1.1 Repair concept

The Endress+Hauser repair concept assumes that the devices have a modular design and that repairs can be done by the Endress+Hauser service or specially trained customers.

Spare parts are contained in suitable kits. They contain the related replacement instructions.

For more information on service and spare parts, contact the Service Department at Endress+Hauser.

13.1.2 Repairs to Ex-approved devices



When carrying out repairs to Ex-approved devices, please note the following:

- Repairs to Ex-approved devices may only be carried out by trained personnel or by the Endress+Hauser Service.
- Comply with the prevailing standards, national Ex-area regulations, safety instructions (XA) and certificates.
- Only use original spare parts from Endress+Hauser.
- When ordering a spare part, please note the device designation on the nameplate. Only replace parts with identical parts.
- Carry out repairs according to the instructions. On completion of repairs, carry out the specified routine test on the device.
- Only Endress+Hauser Service may convert a certified device into a different certified variant.
- Document all repair work and conversions.

13.1.3 Replacement of a device or electronic module

After a complete device or the electronic mainboard has been replaced, the parameters can be downloaded into the instrument again via FieldCare.

Condition: The configuration of the old device has been saved to the computer via FieldCare.

 If an electronic module of the sensor or other parts of the sensor have been replaced, the servo calibration must be repeated. Please refer to →  87.

The "Save/Restore" function

After a device configuration has been saved to a computer and restored to the device using the **Save/Restore** function of FieldCare, the device must be restarted by the following setting:

Setup → **Advanced setup** → **Administration** → **Device reset** = **Restart device**.

This ensures correct operation of the device after the restore.

13.2 Spare parts

Some interchangeable measuring device components are listed on an overview sign in the connection compartment cover.

The spare part overview sign contains the following information:

- A list of the most important spare parts for the measuring device, including their ordering information.
- The URL for the *W@M Device Viewer* (www.endress.com/deviceviewer):
All the spare parts for the measuring device, along with the order code, are listed here and can be ordered. If available, users can also download the associated Installation Instructions.

13.3 Endress+Hauser services

Endress+Hauser offers a wide range of services.

 Your Endress+Hauser Sales Center can provide detailed information on the services.

13.4 Return

The measuring device must be returned if it is need of repair or a factory calibration, or if the wrong measuring device has been delivered or ordered. Legal specifications require Endress+Hauser, as an ISO-certified company, to follow certain procedures when handling products that are in contact with the medium.

To ensure safe, swift and professional device returns, please refer to the procedure and conditions for returning devices provided on the Endress+Hauser website at <http://www.endress.com/support/return-material>

13.5 Disposal

Observe the following notes during disposal:

- Observe valid federal/national regulations.
- Ensure proper separation and reuse of the device components.

14 Accessories

14.1 Device-specific accessories

14.1.1 Weather protection cover

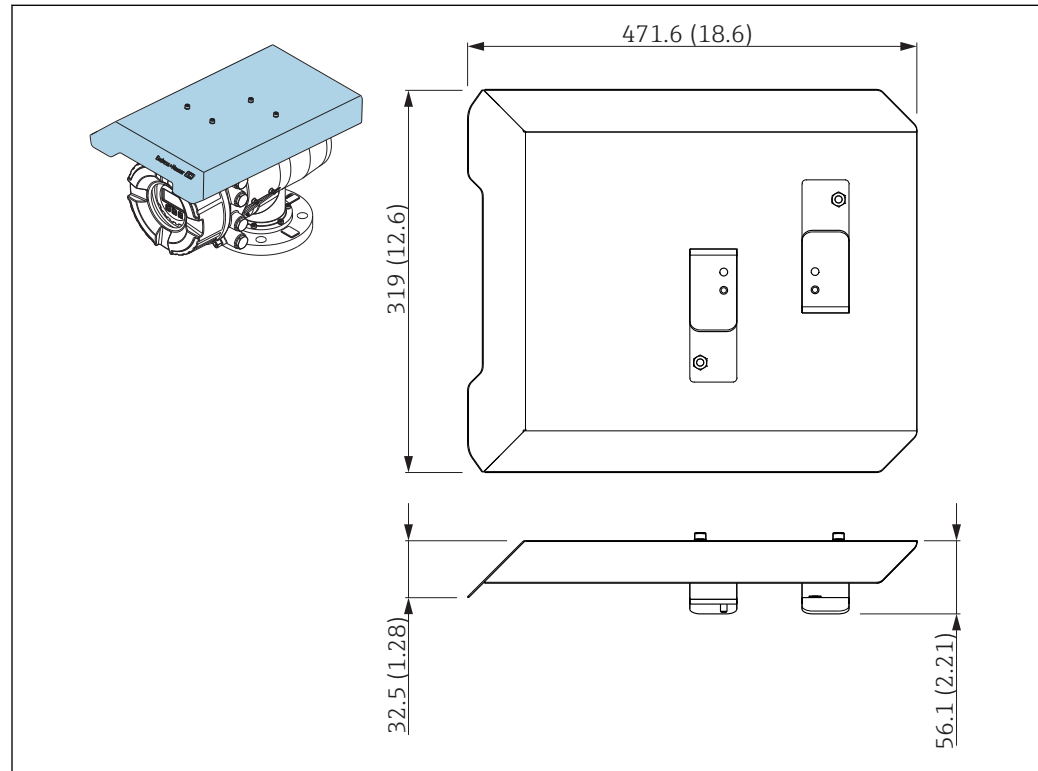

A0029585

 72 Weather protection cover; dimensions: mm (in)

Materials

Part	Material
Protection cover and mounting brackets	316L (1.4404)
Screws and washers	A4

-  The weather protection cover can be ordered together with the device:
Ordering feature 620 "Accessory Enclosed", option PA "Weather Protection Cover")
- It can also be ordered as an accessory:
Order code: 71305035 (for NMS8x)

14.1.2 Calibration chamber

A calibration chamber is recommended for use with tank level gauges in order to allow maintenance (removing the 70 mm (2.76 in) displacer or larger), while the tank is in service. Contact your Endress+Hauser Sales Center if necessary.

14.1.3 Ball valve

Ball valves are recommended for use with tank level gauges in order to allow maintenance such as removing displacers while tank is in service. Contact your Endress+Hauser Sales Center if necessary.

14.1.4 Control switch

A control switch is used for field mounted tank gauges. This provides additional gauge operation contact switching in order to control the gauge's operation, such as hoisting up the displacer. Contact your Endress+Hauser Sales Center if necessary.

14.1.5 Relief valve and pressure gauge

A relief valve is used to release pressure inside the housing of NMS8x before maintenance.

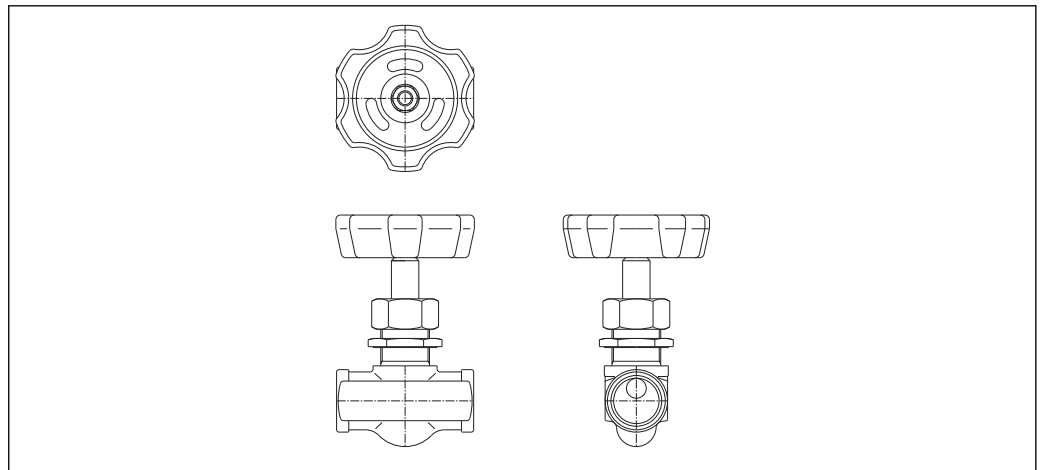

A0028881

 73 Relief valve

A pressure gauge is used to check process pressure inside the housing.

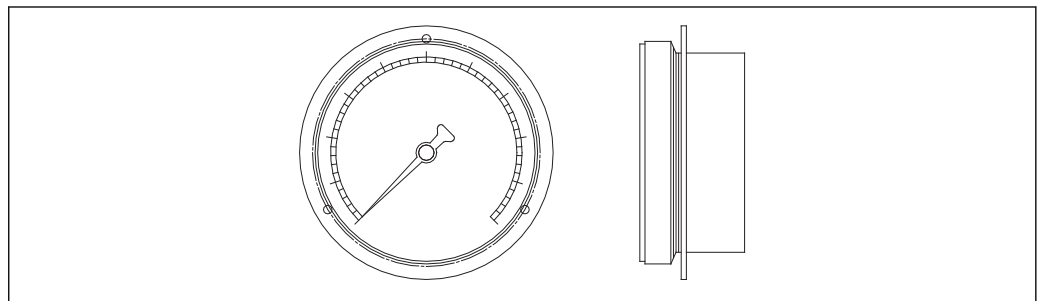

A0028882

 74 Pressure gauge

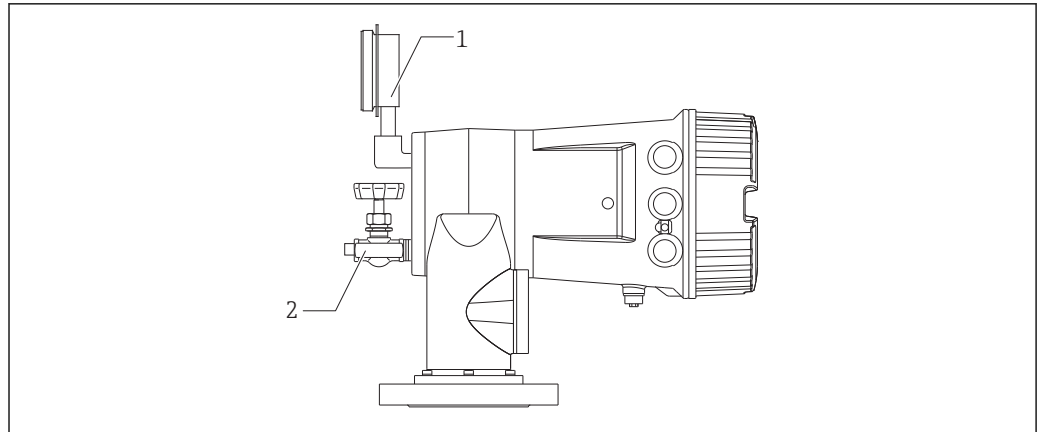

A0030102

75 Mounting position of relief valve and pressure gauge

- 1 Pressure gauge
- 2 Relief valve

14.1.6 Cleaning nozzle and gas purging nozzle

A cleaning nozzle used for washing inside housing is especially recommended for F&B or alcohol applications.

A gas purging nozzle used for purging gas inside the housing is especially recommended for a nitrogen blanket for petrochemical or chemical applications.

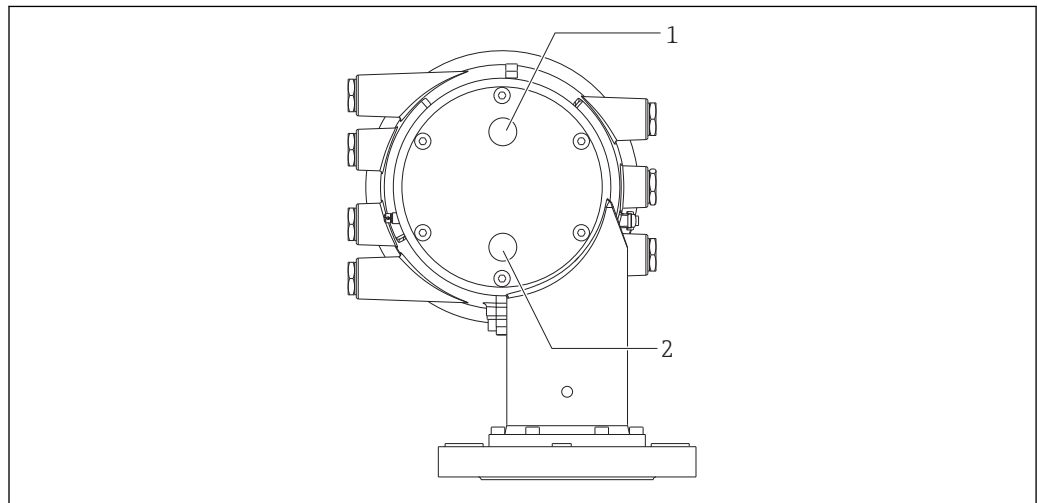

A0030103

76 Holes for cleaning nozzle and gas purging nozzle

- 1 Cleaning nozzle
- 2 Gas purging nozzle

14.2 Communication-specific accessories

Accessory	Description
WirelessHART Adapter SWA70	<p>Connects field devices to a WirelessHART network. The WirelessHART adapter can be mounted directly at a HART device and is easily integrated into an existing HART network. It ensures safe data transmission and can be operated in parallel with other wireless networks.</p> <p> For details refer to Operating Instructions BA00061S</p>



14.3 Service-specific accessories

Accessory	Description
Commubox FXA195 HART	<p>For intrinsically safe HART communication with FieldCare via the USB interface.</p> <p> For details refer to Technical Information TI00404F</p>





Accessory	Description
Commubox FXA291	<p>Connects Endress+Hauser field devices with CDI interface (= Endress+Hauser Common Data Interface) to the USB interface of a computer.</p> <p> For details refer to Technical Information TI00405C</p>

Accessory	Description
FieldCare	<p>Endress+Hauser's FDT-based Plant Asset Management tool. Helps to configure and maintain all field devices of your plant. By supplying status information it also supports the diagnosis of the devices.</p> <p> For details refer to Operating Instructions BA00027S and BA00059S.</p>





14.4 System components

Accessory	Description
RIA15	<p>Compact process display unit with very low voltage drop for universal use to display 4 to 20 mA/HART signals</p> <p> For details refer to Technical Information TI01043K.</p>
Tankvision <ul style="list-style-type: none"> ▪ Tank Scanner NXA820 ▪ Data Concentrator NXA821 ▪ Host Link NXA822 	<p>Inventory Management System with completely integrated software for operation via standard web browser</p> <p> For details refer to Technical Information TI00419G.</p>

15 Operating menu















-   : Navigation path for operating module at the device
-  : Navigation path for operating tool (e.g. FieldCare)
-  : Parameter can be locked via software locking

























15.1 Overview of the operating menu

-  This section lists the parameters of the following menus:
 - Operation (→  169)
 - Setup (→  185)
 - Diagnostics (→  316)
- For the **Expert** menu refer to the "Description of Device Parameters" (GP) of the respective device.
- Depending on the device version and parametrization some parameters will not be available in a given situation. For details refer to the "Prerequisite" category in the description of the respective parameter.
- The representation essentially corresponds to the menu in an operating tool (e.g. FieldCare). On the local display there may be minor differences in the menu structure. Details are mentioned in the description of the respective submenu.

























Navigation

  Operating tool

Operation	→  169
Gauge command	→  169
Distance	→  170
Net weight	→  170
Gauge status	→  171
Balance flag	→  171
Standby level	→  171
One-time command status	→  171
▶ Level	→  172
Tank level	→  172
Tank Level %	→  172
Tank ullage	→  172
Tank ullage %	→  172
Upper interface level	→  173
Upper interface level timestamp	→  173

Lower interface level	→  173
Lower interface level timestamp	→  173
Bottom level	→  174
Bottom level timestamp	→  174
Water level	→  174
Measured level	→  174
Distance	→  170
Displacer position	→  175
► Temperature	→  175
Air temperature	→  175
Liquid temperature	→  175
Vapor temperature	→  176
► NMT element values	→  176
► Element temperature	→  176
Element temperature 1 to 24	→  176
► Element position	→  177
Element position 1 to 24	→  177
► Density	→  177
Observed density	→  177
Vapor density	→  177
Air density	→  178
Measured upper density	→  178
Upper density timestamp	→  178
Measured middle density	→  178
Middle Density Timestamp	→  179

Measured lower density	→ 179
Lower density timestamp	→ 179
Profile point	→ 179
Profile average density	→ 180
Profile density timestamp	→ 180
▶ Profile density	→ 181
Profile density 0 to 49	→ 181
Profile density position 0 to 49	→ 181
▶ Pressure	→ 181
P1 (bottom)	→ 181
P3 (top)	→ 182
▶ GP values	→ 183
GP 1 to 4 name	→ 183
GP Value 1	→ 183
GP Value 2	→ 183
GP Value 3	→ 183
GP Value 4	→ 184
 Setup	→ 185
Device tag	→ 185
Units preset	→ 185
Upper density	→ 186
Middle density	→ 186
Lower density	→ 186
Gauge command	→ 169
Process condition	→ 187

Empty	→  187
Tank reference height	→  188
Tank level	→  172
Set level	→  188
Level source	→  189
High stop level	→  189
Low stop level	→  190
Distance	→  170
Liquid temp source	→  190
► Calibration	→  191
► Move displacer	→  191
Move distance	→  191
Distance	→  170
Move displacer	→  191
Motor status	→  192
Move displacer	→  192
► Sensor calibration	→  193
Sensor calibration	→  193
Offset weight	→  193
Span weight	→  193
Zero calibration	→  194
Calibration status	→  194
Offset calibration	→  194
Span calibration	→  194

























▶ Reference calibration	→ 195
Reference calibration	→ 195
Reference position	→ 195
Progress	→ 195
Calibration status	→ 194
▶ Drum calibration	→ 197
Drum calibration	→ 197
Set high weight	→ 197
Make drum table	→ 197
Drum table point	→ 197
Calibration status	→ 194
Make low table	→ 198
Set low weight	→ 198
▶ Advanced setup	→ 199
Locking status	→ 199
Access status tooling	→ 199
Enter access code	→ 199
▶ Input/output	→ 200
▶ HART devices	→ 200
Number of devices	→ 200
▶ HART Device(s)	→ 201
▶ Forget device	→ 206
▶ Analog IP	→ 207
Operating mode	→ 207
RTD type	→ 207



























RTD connection type	→ 208
Process value	→ 208
Process variable	→ 209
0 % value	→ 209
100 % value	→ 209
Input value	→ 210
Minimum probe temperature	→ 210
Maximum probe temperature	→ 210
Probe position	→ 211
Damping factor	→ 211
Gauge current	→ 212
► Analog I/O	→ 213
Operating mode	→ 213
Current span	→ 214
Fixed current	→ 215
Analog input source	→ 215
Failure mode	→ 216
Error value	→ 217
Input value	→ 217
0 % value	→ 217
100 % value	→ 218
Input value %	→ 218
Output values	→ 218
Process variable	→ 219
Analog input 0% value	→ 219

















Analog input 100% value	→ 219
Error event type	→ 220
Process value	→ 220
Input value in mA	→ 220
Input value percent	→ 221
Damping factor	→ 221
Used for SIL/WHG	→ 221
Expected SIL/WHG chain	→ 222
► Digital Xx-x	→ 223
Operating mode	→ 223
Digital input source	→ 224
Input value	→ 225
Contact type	→ 225
Output simulation	→ 225
Output values	→ 226
Readback value	→ 226
Used for SIL/WHG	→ 227
► Digital input mapping	→ 228
Digital input source 1	→ 228
Digital input source 2	→ 228
Gauge command 0	→ 229
Gauge command 1	→ 229
Gauge command 2	→ 230
Gauge command 3	→ 231

▶ Communication	→ 232
▶ Communication interface 1 to 2	
Communication interface protocol	→ 232
▶ Configuration	→ 233
▶ Configuration	→ 236
▶ V1 input selector	→ 239
▶ HART output	→ 241
▶ Configuration	→ 241
▶ Information	→ 249
▶ Application	→ 251
▶ Tank configuration	→ 251
▶ Level	→ 251
▶ Temperature	→ 255
▶ Density	→ 259
▶ Pressure	→ 261
▶ Tank calculation	→ 266
▶ HyTD	→ 268
▶ CTSh	→ 273
▶ HTMS	→ 278
▶ Alarm	
▶ Alarm 1 to 4	→ 282
▶ Safety settings	→ 290
Output out of range	→ 290
High stop level	→ 290
Low stop level	→ 291

Slow hoist zone	→	📖 291
Overtension weight	→	📖 291
Undertension weight	→	📖 292
▶ Sensor config	→	📖 293
Post gauge command	→	📖 293
▶ Displacer	→	📖 294
Displacer type	→	📖 294
Displacer diameter	→	📖 294
Displacer weight	→	📖 294
Displacer volume	→	📖 295
Displacer balance volume	→	📖 295
Displacer height	→	📖 295
Immersion depth	→	📖 296
▶ Wiredrum	→	📖 297
Drum circumference	→	📖 297
Wire weight	→	📖 297
▶ Spot density	→	📖 298
Upper density offset	→	📖 298
Middle density offset	→	📖 298
Lower density offset	→	📖 298
Submersion depth	→	📖 299
▶ Profile density	→	📖 300
Density measurement mode	→	📖 300
Manual profile level	→	📖 300
Profile density offset distance	→	📖 300

Profile density interval	→  301
Profile density offset	→  301
► Display	→  302
Language	→  302
Format display	→  302
Value 1 to 4 display	→  303
Decimal places 1 to 4	→  304
Separator	→  304
Number format	→  305
Header	→  305
Header text	→  305
Display interval	→  306
Display damping	→  306
Backlight	→  306
Contrast display	→  307
► System units	→  308
Units preset	→  185
Distance unit	→  308
Pressure unit	→  309
Temperature unit	→  309
Density unit	→  309
► Date / time	→  311
Date/time	→  311
Set date	→  311
Year	→  311

Month	→  312
Day	→  312
Hour	→  312
Minute	→  313
▶ SIL confirmation	→  314
▶ Deactivate SIL/WHG	→  314
▶ Administration	→  315
Define access code	→  315
Device reset	→  315
 Diagnostics	→  316
Actual diagnostics	→  316
Timestamp	→  316
Previous diagnostics	→  316
Timestamp	→  317
Operating time from restart	→  317
Operating time	→  317
Date/time	→  311
▶ Diagnostic list	→  319
Diagnostics 1 to 5	→  319
Timestamp 1 to 5	→  319
▶ Device information	→  320
Device tag	→  320
Serial number	→  320
Firmware version	→  320
Firmware CRC	→  320

Weight and measures configuration CRC	→  321
Device name	→  321
Order code	→  321
Extended order code 1 to 3	→  321
▶ Simulation	→  323
Device alarm simulation	→  323
Diagnostic event simulation	→  323
Simulation distance on	→  323
Simulation distance	→  324
Current output 1 simulation	→  324
Simulation value	→  324
▶ Device check	→  326
Result drum check	→  326
▶ Commissioning check	→  327
Commissioning check	→  327
Result drum check	→  326
Step X / 11	→  327

15.2 "Operation" menu

The **Operation** menu (→  169) shows the most important measured values and allows to issue a gauge command.

Navigation   Operation

Gauge command

Navigation  Operation → Gauge command

Description Gauge operation command to choose the measurement mode of the device.

- Selection**
- Stop
 - Level
 - Up
 - Bottom level
 - Upper I/F level
 - Lower I/F level
 - Upper density
 - Middle density
 - Lower density
 - Repeatability
 - Water dip
 - Release overtension
 - Tank profile
 - Interface profile
 - Manual profile
 - Level standby

Factory setting Stop

Additional information

Read access	Operator
Write access	Maintenance

Distance

Navigation  Operation → Distance

Description Shows measured distance from reference position.

Additional information

Read access	Operator
Write access	-

Net weight

Navigation   Operation → Net weight

Description Shows the corrected weight data from the detector, as compensated by the drum table, This weight is used for measurement.

Additional information

Read access	Operator
Write access	-

Gauge status

Navigation  Operation → Gauge status

Description Indicates the current status of the device gauge command.

Additional information

Read access	Operator
Write access	-

Balance flag

Navigation  Operation → Balance flag

Description Indicates the validity of the Measurement. If balanced, corresponding Value (Liquid Level, Upper Interface, Lower Interface, Tank Bottom) is updated.

Additional information

Read access	Operator
Write access	-

Standby level



Navigation  Operation → Standby level

Description Defines the position in the tank where the displacer waits for the liquid level to rise during standby level gauge command.

User entry -999 999.9 to 999 999.9 mm

Factory setting 0 mm

Additional information

Read access	Operator
Write access	Maintenance

One-time command status

Navigation  Operation → One-time command status

Description Indicates the status of the last executed one-time gauge command.

Additional information

Read access	Operator
Write access	-

15.2.1 "Level" submenu

Navigation  Operation → Level

Tank level

Navigation  Operation → Level → Tank level

Description Shows the distance from the zero position (tank bottom or datum plate) to the product surface.

Additional information

Read access	Operator
Write access	-

Tank Level %

Navigation  Operation → Level → Tank Level %

Description Shows the level as a percentage of the full measuring range.

Additional information

Read access	Operator
Write access	-

Tank ullage

Navigation  Operation → Level → Tank ullage

Description Shows the remaining empty space in the tank.

Additional information

Read access	Operator
Write access	-

Tank ullage %

Navigation  Operation → Level → Tank ullage %

Description Shows the remaining empty space in percentage related to parameter tank reference height.

Additional information

Read access	Operator
Write access	-

Upper interface level

Navigation  Operation → Level → Upper interface level

Description Shows measured interface level from zero position (tank bottom or datum plate). Value is updated when device generates a valid Interface measurement.

Additional information

Read access	Maintenance
Write access	-

Upper interface level timestamp

Navigation  Operation → Level → Upper interface level timestamp

Description Shows timestamp for the last measured upper interface level.

Additional information

Read access	Operator
Write access	-

Lower interface level

Navigation  Operation → Level → Lower interface level

Description Shows measured interface level from zero position (tank bottom or datum plate). Value is updated when device generates a valid interface measurement.

Additional information

Read access	Maintenance
Write access	-

Lower interface level timestamp

Navigation  Operation → Level → Lower interface level timestamp

Description Shows timestamp of the last measured lower interface level.

Additional information

Read access	Operator
Write access	-

Bottom level

Navigation  Operation → Level → Bottom level

Description Shows the bottom level.

Additional information

Read access	Operator
Write access	-

Bottom level timestamp

Navigation  Operation → Level → Bottom level timestamp

Description Shows the timestamp for measured bottom level.

Additional information

Read access	Operator
Write access	-

Water level

Navigation  Operation → Level → Water level

Description Shows the bottom water level.

Additional information

Read access	Operator
Write access	-

Measured level

Navigation  Operation → Level → Measured level

Description Shows the measured level without any correction from the tank calculations.

Additional information

Read access	Operator
Write access	-

Distance

Navigation  Operation → Level → Distance

Description Shows measured distance from reference position.

Additional information

Read access	Operator
Write access	-

Displacer position

Navigation  Operation → Level → Displacer position

Description Shows the displacer position.

Additional information

Read access	Operator
Write access	-

15.2.2 "Temperature" submenu

Navigation  Operation → Temperature

Air temperature

Navigation  Operation → Temperature → Air temperature

Description Shows the air temperature.

Additional information

Read access	Operator
Write access	-

Liquid temperature

Navigation  Operation → Temperature → Liquid temperature

Description Shows the average or spot temperature of the measured liquid.

Additional information

Read access	Operator
Write access	-

Vapor temperature

Navigation  Operation → Temperature → Vapor temperature

Description Shows the measured vapor temperature.

Additional information

Read access	Operator
Write access	-

"NMT element values" submenu

 This submenu is only visible if a Prothermo NMT is connected.

Navigation  Operation → Temperature → NMT element values

"Element temperature" submenu

Navigation  Operation → Temperature → NMT element values → Element temperature

Element temperature 1 to 24

Navigation  Operation → Temperature → NMT element values → Element temperature → Element temperature 1 to 24

Description Shows the temperature of an element in the NMT.

Additional information

Read access	Operator
Write access	-

"Element position" submenu

Navigation  Operation → Temperature → NMT element values → Element position

Element position 1 to 24

Navigation  Operation → Temperature → NMT element values → Element position → Element position 1 to 24

Description Shows the position of the selected element in the NMT.



Additional information

Read access	Operator
Write access	-

15.2.3 "Density" submenu

Navigation   Operation → Density



Observed density

Navigation   Operation → Density → Observed density

Description Calculated density of the product.



Additional information

Read access	Operator
Write access	-

 This value is calculated from different measured variables depending on the selected calculation method →  266.

Vapor density



Navigation   Operation → Density → Vapor density

Description Defines the density of the gas phase in the tank.

User entry 0.0 to 500.0 kg/m³

Factory setting 1.2 kg/m³

Additional information

Read access	Operator
Write access	Maintenance

Air density**Navigation**

Operation → Density → Air density

Description

Defines the density of the air surrounding the tank.

User entry

0.0 to 500.0 kg/m³

Factory setting

1.2 kg/m³

Additional information

Read access	Operator
Write access	Maintenance

Measured upper density**Navigation**

Operation → Density → Measured upper density

Description

Shows the density of the upper phase.

Additional information

Read access	Operator
Write access	-

Upper density timestamp**Navigation**

Operation → Density → Upper density timestamp

Description

Shows timestamp of the last measured upper density.

Additional information

Read access	Operator
Write access	-

Measured middle density**Navigation**

Operation → Density → Measured middle density

Description



Density of the middle phase.

Additional information

Read access	Operator
Write access	-

Middle Density Timestamp

Navigation

  Operation → Density → Middle Density Timestamp

Description



Shows the timestamp of the last measured middle density.

Additional information

Read access	Operator
Write access	-

Measured lower density

Navigation

  Operation → Density → Measured lower density

Description



Density of the lower phase.

Additional information

Read access	Maintenance
Write access	-

Lower density timestamp

Navigation

  Operation → Density → Lower density timestamp

Description

Shows timestamp of last measured lower density.

Additional information

Read access	Operator
Write access	-

Profile point

Navigation

  Operation → Density → Profile point

Description

Shows actual number of Density Points measured so far in current operation, and the total Number of Points after Density Profile Operation is complete.

Additional information

Read access	Operator
Write access	-

Profile average density

Navigation Operation → Density → Profile average density**Description**

Shows the average density calculated after a profile density measurement is complete.

Additional information

Read access	Operator
Write access	-

Profile density timestamp

Navigation Operation → Density → Profile density timestamp**Description**

Shows the timestamp when the last average density profile was finished.

Additional information

Read access	Operator
Write access	-

"Profile density" submenu

Navigation  Operation → Density → Profile density

Profile density 0 to 49

Navigation  Operation → Density → Profile density → Profile density 0 to 49

Description Shows the density measurement at the corresponding profile density position.

Additional information

Read access	Operator
Write access	-

Profile density position 0 to 49

Navigation  Operation → Density → Profile density → Profile density position 0 to 49

Description Shows the position where the corresponding density was measured.



Additional information

Read access	Operator
Write access	-

15.2.4 "Pressure" submenu

Navigation   Operation → Pressure

P1 (bottom)

Navigation   Operation → Pressure → P1 (bottom)

Description Shows the pressure at the tank bottom.

Additional information

Read access	Operator
Write access	-

P3 (top)

Navigation Operation → Pressure → P3 (top)**Description**

Shows the pressure (P3) at the top transmitter.

Additional information

Read access	Operator
Write access	-

15.2.5 "GP values" submenu

Navigation  Operation → GP values

GP 1 to 4 name

Navigation  Operation → GP values → GP 1 name

Description Defines the label associated with the respective GP value.

Factory setting GP Value 1

Additional information

Read access	Operator
Write access	Maintenance

GP Value 1

Navigation  Operation → GP values → GP Value 1

Description Displays the value that will be used as general purpose value.

Additional information

Read access	Operator
Write access	-

GP Value 2

Navigation  Operation → GP values → GP Value 2

Description Displays the value that will be used as general purpose value.

Additional information

Read access	Operator
Write access	-

GP Value 3

Navigation  Operation → GP values → GP Value 3

Description Displays the value that will be used as general purpose value.

Additional information

Read access	Operator
Write access	-

GP Value 4

Navigation Operation → GP values → GP Value 4**Description**





Displays the value that will be used as general purpose value.



Additional information

Read access	Operator
Write access	-





15.3 "Setup" menu

Navigation   Setup

Device tag 					
Navigation	  Setup → Device tag				
Description	Enter a unique name for the measuring point to identify the device quickly within the plant.				
Factory setting	NMS8x				
Additional information	<table border="1"> <tr> <td>Read access</td> <td>Operator</td> </tr> <tr> <td>Write access</td> <td>Maintenance</td> </tr> </table>	Read access	Operator	Write access	Maintenance
Read access	Operator				
Write access	Maintenance				
Units preset 					

Navigation	  Setup → Units preset				
Description	Defines a set of units for length, pressure and temperature.				
Selection	<ul style="list-style-type: none"> ■ mm, bar, °C ■ m, bar, °C ■ mm, PSI, °C ■ ft, PSI, °F ■ ft-in-16, PSI, °F ■ ft-in-8, PSI, °F ■ Customer value 				
Factory setting	mm, bar, °C				
Additional information	<table border="1"> <tr> <td>Read access</td> <td>Operator</td> </tr> <tr> <td>Write access</td> <td>Maintenance</td> </tr> </table>	Read access	Operator	Write access	Maintenance
Read access	Operator				
Write access	Maintenance				

If the **Customer value** option is selected, the units are defined in the following parameters:

- Distance unit (→  308)
- Pressure unit (→  309)
- Temperature unit (→  309)
- Density unit (→  309)

In any other case these are read-only parameters used to indicate the respective unit.

Upper density
**Navigation**

Setup → Upper density

Description

Sets the density of the upper phase of the liquid.

User entry50 to 2 000 kg/m³**Factory setting**800 kg/m³**Additional information**

Read access	Operator
Write access	Maintenance

Middle density
**Navigation**

Setup → Middle density

Description

Sets Density of Middle Phase in the Tank if three Phases are available. Otherwise used for the Lower Phase in the Tank if two Phases are available.

User entry50 to 2 000 kg/m³**Factory setting**1 000 kg/m³**Additional information**

Read access	Operator
Write access	Maintenance

Lower density
**Navigation**

Setup → Lower density

Description

Sets the density of the lower Phase in the tank if three phases are available.

User entry50 to 2 000 kg/m³**Factory setting**1 200 kg/m³**Additional information**

Read access	Operator
Write access	Maintenance

Gauge command



Navigation Setup → Gauge command

Description Gauge operation command to choose the measurement mode of the device.

- Selection**
- Stop
 - Level
 - Up
 - Bottom level
 - Upper I/F level
 - Lower I/F level
 - Upper density
 - Middle density
 - Lower density
 - Repeatability
 - Water dip
 - Release overtension
 - Tank profile
 - Interface profile
 - Manual profile
 - Level standby

Factory setting Stop

Additional information

Read access	Operator
Write access	Maintenance

Process condition



Navigation Setup → Process condition

Description Select tank liquid condition.

- Selection**
- Universal
 - Calm surface
 - Turbulent surface

Factory setting Universal

Additional information

Read access	Operator
Write access	Maintenance

Empty



Navigation Setup → Empty

Description Distance from reference point to zero position (tank bottom or datum plate).

User entry 0 to 10 000.00 mm

Factory setting Dependent on the device version

Additional information

Read access	Operator
Write access	Maintenance

 The reference point is the reference line of the calibration window.

Tank reference height 

Navigation  Setup → Tank reference height

Description Defines the distance from the dipping reference point to the zero position (tank bottom or datum plate).

User entry 0 to 10 000.00 mm

Factory setting Dependent on the device version

Additional information

Read access	Operator
Write access	Maintenance

Tank level

Navigation  Setup → Tank level

Description Shows the distance from the zero position (tank bottom or datum plate) to the product surface.

Additional information

Read access	Operator
Write access	-

Set level 

Navigation  Setup → Set level

Description If the level measured by the device does not match the actual level obtained by a manual dip, enter the correct level into this parameter.

User entry 0 to 10 000.00 mm



Factory setting 0 mm

Additional information

Read access	Operator
Write access	Maintenance

The device adjusts the **Empty** parameter (→  187) according to the entered value, such that the measured level will match the actual level.

Level source**Navigation**

  Setup → Level source

Description

Defines the source of the level value.

Selection

- No input value
- HART device 1 ... 15 level
- Level SR *
- Level *
- Displacer position *
- AIO B1-3 value *
- AIO C1-3 value *
- AIP B4-8 value *
- AIP C4-8 value *



Factory setting

Dependent on the device version

Additional information

Read access	Operator
Write access	Maintenance

High stop level**Navigation**

  Setup → High stop level

Description

Position of the displacer high stop as measured from defined zero position (tank bottom or datum plate).

User entry

-999 999.9 to 999 999.9 mm

Factory setting

20 000 mm

Additional information

Read access	Operator
Write access	Maintenance

* Visibility depends on order options or device settings

Low stop level



Navigation	Setup → Low stop level				
Description	Position of the displacer low stop as measured from defined zero position (tank bottom or datum plate).				
User entry	-999 999.9 to 999 999.9 mm				
Factory setting	0 mm				
Additional information	<table border="1"> <tr> <td>Read access</td> <td>Operator</td> </tr> <tr> <td>Write access</td> <td>Maintenance</td> </tr> </table>	Read access	Operator	Write access	Maintenance
Read access	Operator				
Write access	Maintenance				

Distance

Navigation	Setup → Distance				
Description	Shows measured distance from reference position.				
Additional information	<table border="1"> <tr> <td>Read access</td> <td>Operator</td> </tr> <tr> <td>Write access</td> <td>-</td> </tr> </table>	Read access	Operator	Write access	-
Read access	Operator				
Write access	-				

Liquid temp source



Navigation	Setup → Liquid temp source				
Description	Defines source from which the liquid temperature is obtained.				
Selection	<ul style="list-style-type: none"> ■ Manual value ■ HART device 1 ... 15 temperature ■ AIO B1-3 value ■ AIO C1-3 value ■ AIP B4-8 value ■ AIP C4-8 value 				
Factory setting	Manual value				
Additional information	<table border="1"> <tr> <td>Read access</td> <td>Operator</td> </tr> <tr> <td>Write access</td> <td>Maintenance</td> </tr> </table>	Read access	Operator	Write access	Maintenance
Read access	Operator				
Write access	Maintenance				

15.3.1 "Calibration" submenu

Read access	Maintenance
-------------	-------------

Navigation  Setup → Calibration

"Move displacer" wizard

Navigation  Setup → Calibration → Move displacer

Move distance

Navigation  Setup → Calibration → Move displacer → Move distance

Description Up or down movement of displacer in mm.

User entry 0 to 999 999.9 mm

Factory setting 0 mm

Additional information

Read access	Operator
Write access	Maintenance

Distance

Navigation  Setup → Calibration → Move displacer → Distance

Description Shows measured distance from reference position.

Additional information

Read access	Operator
Write access	-

Move displacer

Navigation  Setup → Calibration → Move displacer → Move displacer

Selection

- Stop
- Move down
- Move up



Factory setting Stop

Additional information

Read access	Operator
Write access	Maintenance

Motor status

Navigation

  Setup → Calibration → Move displacer → Motor status

Description

Shows the current moving Direction of the Motor.

Additional information

Read access	Operator
Write access	-

Move displacer



Navigation

  Setup → Calibration → Move displacer → Move displacer

Selection

- No
- Yes

Factory setting

No

Additional information

Read access	Operator
Write access	Maintenance

"Sensor calibration" wizard

Navigation  Setup → Calibration → Sensor calibration

Sensor calibration 

Navigation  Setup → Calibration → Sensor calibration → Sensor calibration

Description This sequence calibrates the sensor of the servo.

Additional information

Read access	Operator
Write access	Maintenance

Offset weight 

Navigation  Setup → Calibration → Sensor calibration → Offset weight

Description Sets the weight that is used for the lower point sensor calibration. Changing the value will delete the calibration data.

User entry 0 to 150 g

Factory setting Dependent on the device version

Additional information

Read access	Operator
Write access	Maintenance

 For density measurement application, it is recommended to apply 50 g.

Span weight 

Navigation  Setup → Calibration → Sensor calibration → Span weight

Description Sets the weight that is used for the middle point sensor calibration. Changing the value will delete the calibration data.

User entry 10 to 999.9 g

Factory setting Dependent on the device version

Additional information

Read access	Operator
Write access	Maintenance

Zero calibration
**Navigation**

Setup → Calibration → Sensor calibration → Zero calibration

Description

In this step the sensor calibration zero weight will be done.

Additional information

Read access	Operator
Write access	Maintenance

Calibration status
Navigation

Setup → Calibration → Sensor calibration → Calibration status

Description

Gives feedback on the latest status of the calibration process.

Additional information

Read access	Operator
Write access	-

Offset calibration
**Navigation**

Setup → Calibration → Sensor calibration → Offset calibration

Description

In this step the sensor calibration with offset weight will be done.

Additional information

Read access	Operator
Write access	Maintenance

Span calibration
**Navigation**

Setup → Calibration → Sensor calibration → Span calibration



Description

In this step the sensor calibration with span weight will be done.

Additional information

Read access	Operator
Write access	Maintenance

"Reference calibration" wizard

Navigation   Setup → Calibration → Reference calibration

Reference calibration 

Navigation   Setup → Calibration → Reference calibration → Reference calibration

Description This sequence will move the displacer to the mechanical stop and set the reference position.

Additional information

Read access	Operator
Write access	Maintenance

Reference position 

Navigation   Setup → Calibration → Reference calibration → Reference position

Description Defines in mm, during reference calibration, the distance between mechanical stop inside the drum housing and the middle of the wire ring.



User entry 0 to 9999.9 mm

Factory setting Dependent on the device version

Additional information

Read access	Operator
Write access	Maintenance

Progress 

Navigation   Setup → Calibration → Reference calibration → Progress

Description Gives feedback on the latest status of the reference calibration process.

Additional information

Read access	Operator
Write access	Maintenance

Calibration status



Navigation Setup → Calibration → Reference calibration → Calibration status**Description**

Gives feedback on the latest status of the calibration process.

Additional information

Read access	Operator
Write access	-

"Drum calibration" wizard

Navigation   Setup → Calibration → Drum calibration

Drum calibration 

Navigation   Setup → Calibration → Drum calibration → Drum calibration

Description This sequence will perform a drum calibration.

Additional information

Read access	Operator
Write access	Maintenance

Set high weight 

Navigation   Setup → Calibration → Drum calibration → Set high weight

Description High weight that is used for a drum calibration (normally it is the displacer weight).

User entry 10 to 999.9 g

Factory setting Dependent on the device version

Additional information

Read access	Operator
Write access	Maintenance

Make drum table 



Navigation   Setup → Calibration → Drum calibration → Make drum table

Description This will perform a drum calibration.

Additional information

Read access	Operator
Write access	Maintenance

Drum table point

Navigation   Setup → Calibration → Drum calibration → Drum table point

Description Shows the currently measured point of the drum calibration. Maximum number of measured points is 50.

Additional information

Read access	Operator
Write access	-

Calibration status**Navigation**
 Setup → Calibration → Drum calibration → Calibration status
Description

Gives feedback on the latest status of the calibration process.

Additional information

Read access	Operator
Write access	-

Make low table**Navigation**
 Setup → Calibration → Drum calibration → Make low table
Description

For additional accuracy it is possible to perform a second drum calibration with low weight. Choose 'Yes' or 'No' to start/stop calibration.

Selection

- No
- Yes

Factory setting

No

Additional information

Read access	Operator
Write access	Maintenance

Set low weight**Navigation**
 Setup → Calibration → Drum calibration → Set low weight
Description

Set weight for additional drum calibration sequence.

User entry

10 to 999.9 g

Factory setting

Dependent on the device version

Additional information

Read access	Operator
Write access	Maintenance

15.3.2 "Advanced setup" submenu

Navigation  Setup → Advanced setup

Locking status

Navigation  Setup → Advanced setup → Locking status

Description Indicates the write protection with the highest priority that is currently active.

Additional information

Read access	Operator
Write access	-

Access status tooling

Navigation  Setup → Advanced setup → Access status tooling

Description Shows the access authorization to the parameters via the operating tool.

Additional information

Read access	Operator
Write access	-

Enter access code

Navigation  Setup → Advanced setup → Enter access code

Description Enter access code to disable write protection of parameters.

Additional information

Read access	Operator
Write access	Operator

"Input/output" submenu

Navigation  Setup → Advanced setup → Input/output

"HART devices" submenu

Navigation  Setup → Advanced setup → Input/output → HART devices

Number of devices

Navigation

 Setup → Advanced setup → Input/output → HART devices → Number of devices

Description

Shows the number of devices on the HART bus.

Additional information

Read access	Operator
Write access	-

"HART Device(s)" submenu

 There is a **HART Device(s)** submenu for each HART slave device found on the HART loop.

Navigation  Setup → Advanced setup → Input/output → HART devices → HART Device(s)

Device name

Navigation  Setup → Advanced setup → Input/output → HART devices → HART Device(s) → Device name

Description Shows the name of the transmitter.

Additional information

Read access	Operator
Write access	-

Polling address

Navigation  Setup → Advanced setup → Input/output → HART devices → HART Device(s) → Polling address

Description Shows the polling address of the transmitter.

Additional information

Read access	Operator
Write access	-

Device tag

Navigation  Setup → Advanced setup → Input/output → HART devices → HART Device(s) → Device tag

Description Shows the device tag of the transmitter.

Additional information

Read access	Operator
Write access	-

Operating mode



- Navigation** Setup → Advanced setup → Input/output → HART devices → HART Device(s) → Operating mode
- Prerequisite** Not available if the HART device is a Prothermo NMT.
- Description** Selection of the operation mode PV only or PV,SV,TV,QV. Devines which values are polled from the connected HART Device.
- Selection**
- PV only
 - PV,SV,TV & QV
 - Level ⁴⁾
 - Measured level ⁴⁾
- Factory setting** PV,SV,TV & QV

Additional information

Read access	Operator
Write access	Maintenance

Communication status

- Navigation** Setup → Advanced setup → Input/output → HART devices → HART Device(s) → Communication status
- Description** Shows the operating status of the transmitter.
- User interface**
- Operating normally
 - Device offline

Additional information

Read access	Operator
Write access	-

#blank# (HART PV - designation dependent on device)

- Navigation** Setup → Advanced setup → Input/output → HART devices → HART Device(s) → #blank#
- Description** Shows the first HART variable (PV).

Additional information

Read access	Operator
Write access	-

4) only visible if the conneced device is a Micropilot

#blank# (HART SV - designation dependent on device)

Navigation  Setup → Advanced setup → Input/output → HART devices → HART Device(s) → #blank#

Prerequisite For HART devices other than NMT: **Operating mode** (→  202) = PV,SV,TV & QV

Description Shows the second HART variable (SV).

Additional information

Read access	Operator
Write access	-

#blank# (HART TV - designation dependent on device)

Navigation  Setup → Advanced setup → Input/output → HART devices → HART Device(s) → #blank#

Prerequisite For HART devices other than NMT: **Operating mode** (→  202) = PV,SV,TV & QV

Description Shows the third HART variable (TV).

Additional information

Read access	Operator
Write access	-

#blank# (HART QV - designation dependent on device)

Navigation  Setup → Advanced setup → Input/output → HART devices → HART Device(s) → #blank#

Prerequisite For HART devices other than NMT: **Operating mode** (→  202) = PV,SV,TV & QV

Description Shows the fourth HART variable (QV).

Additional information

Read access	Operator
Write access	-

Output pressure



Navigation  Setup → Advanced setup → Input/output → HART devices → HART Device(s) → Output pressure

Prerequisite Not available for Micropilot S FMR5xx and Prothermo 53x. (In these cases the measured variables are allocated automatically).

Description Defines which HART variable is the pressure.



- Selection**
- No value
 - Primary variable (PV)
 - Secondary variable (SV)
 - Tertiary variable (TV)
 - Quaternary variable (QV)

Factory setting No value

Additional information

Read access	Operator
Write access	Maintenance

Output density

Navigation   Setup → Advanced setup → Input/output → HART devices → HART Device(s) → Output density

Prerequisite Not available for Micropilot S FMR5xx and Prothermo 53x. (In these cases the measured variables are allocated automatically).

Description Defines which HART variable is the density.



- Selection**
- No value
 - Primary variable (PV)
 - Secondary variable (SV)
 - Tertiary variable (TV)
 - Quaternary variable (QV)

Factory setting No value

Additional information

Read access	Operator
Write access	Maintenance

Output temperature

Navigation   Setup → Advanced setup → Input/output → HART devices → HART Device(s) → Output temperature

Prerequisite Not available for Micropilot S FMR5xx and Prothermo 53x. (In these cases the measured variables are allocated automatically).

Description Defines which HART variable is the temperature.

- Selection**
- No value
 - Primary variable (PV)
 - Secondary variable (SV)
 - Tertiary variable (TV)
 - Quaternary variable (QV)

Factory setting No value

Additional information

Read access	Operator
Write access	Maintenance

Output vapor temperature



Navigation

Setup → Advanced setup → Input/output → HART devices → HART Device(s) → Output vapor temperature

Prerequisite

Not available for Micropilot S FMR5xx and Prothermo 53x. (In these cases the measured variables are allocated automatically).

Description

Defines which HART variable is the vapor temperature.

Selection

- No value
- Primary variable (PV)
- Secondary variable (SV)
- Tertiary variable (TV)
- Quaternary variable (QV)

Factory setting

No value

Additional information

Read access	Operator
Write access	Maintenance

Output level



Navigation

Setup → Advanced setup → Input/output → HART devices → HART Device(s) → Output level

Prerequisite

Not available for Micropilot S FMR5xx and Prothermo 53x. (In these cases the measured variables are allocated automatically).

Description

Defines which HART variable is the level.

Selection

- No value
- Primary variable (PV)
- Secondary variable (SV)
- Tertiary variable (TV)
- Quaternary variable (QV)

Factory setting



No value

Additional information

Read access	Operator
Write access	Maintenance

"Forget device" wizard

Read access	Maintenance
-------------	-------------

 This submenu is only visible if **Number of devices** (→  200) ≥ 1.

Navigation  Setup → Advanced setup → Input/output → HART devices → Forget device

Forget device



Navigation

 Setup → Advanced setup → Input/output → HART devices → Forget device → Forget device

Description

With this function an offline device can be deleted from the device list.

Selection

- HART Device 1 *
- HART Device 2 *
- HART Device 3 *
- HART Device 4 *
- HART Device 5 *
- HART Device 6 *
- HART Device 7 *
- HART Device 8 *
- HART Device 9 *
- HART Device 10 *
- HART Device 11 *
- HART Device 12 *
- HART Device 13 *
- HART Device 14 *
- HART Device 15 *
- None

Factory setting

None

Additional information

Read access	Operator
Write access	Maintenance

* Visibility depends on order options or device settings

"Analog IP" submenu

i There is a **Analog IP** submenu for each Analog I/O module of the device. This submenu refers to terminals 4 to 8 of this module (the analog input). They are primarily used to connect an RTD. For terminals 1 to 3 (analog input or output) refer to → **213**.

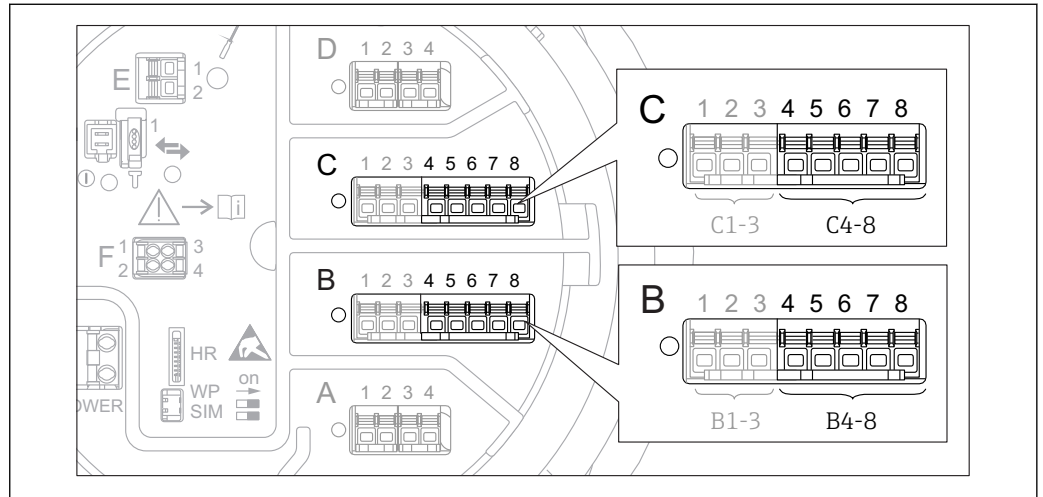

77 Terminals for the "Analog IP" submenu ("B4-8" or "C4-8", respectively)

Navigation **☰** Setup → Advanced setup → Input/output → Analog IP

Operating mode **☰**

Navigation **☰** Setup → Advanced setup → Input/output → Analog IP → Operating mode

Description Defines the operating mode of the analog input.

- Selection**
- Disabled
 - RTD temperature input
 - Gauge power supply

Factory setting Disabled

Additional information

Read access	Operator
Write access	Maintenance

RTD type **☰**

Navigation **☰** Setup → Advanced setup → Input/output → Analog IP → RTD type

Prerequisite **Operating mode** (→ **207**) = RTD temperature input

Description Defines the type of the connected RTD.

- Selection**
- Cu50 (w=1.428, GOST)
 - Cu53 (w=1.426, GOST)
 - Cu90; 0°C (w=1.4274, GOST)
 - Cu100; 25°C (w=1.4274, GOST)
 - Cu100; 0°C(w=1.4274, GOST)
 - Pt46 (w=1.391, GOST)
 - Pt50 (w=1.391, GOST)
 - Pt100(385) (a=0.00385, IEC751)
 - Pt100(389) (a=0.00389, Canadian)
 - Pt100(391) (a=0.003916, JIS1604)
 - Pt100 (w=1.391, GOST)
 - Pt500(385) (a=0.00385, IEC751)
 - Pt1000(385) (a=0.00385, IEC751)
 - Ni100(617) (a=0.00617, DIN43760)
 - Ni120(672) (a=0.00672, DIN43760)
 - Ni1000(617) (a=0.00617, DIN43760)

Factory setting Pt100(385) (a=0.00385, IEC751)

Additional information

Read access	Operator
Write access	Maintenance

RTD connection type



Navigation Setup → Advanced setup → Input/output → Analog IP → RTD connection type

Prerequisite **Operating mode (→ 207) = RTD temperature input**

Description Defines the connection type of the RTD.

- Selection**
- 4 wire RTD connection
 - 2 wire RTD connection
 - 3 wire RTD connection

Factory setting 4 wire RTD connection

Additional information

Read access	Operator
Write access	Maintenance

Process value

Navigation Setup → Advanced setup → Input/output → Analog IP → Process value

Prerequisite **Operating mode (→ 207) ≠ Disabled**

Description Shows the measured value received via the analog input.

Additional information

Read access	Operator
Write access	-

Process variable



Navigation Setup → Advanced setup → Input/output → Analog IP → Process variable

Prerequisite **Operating mode (→ 207) ≠ RTD temperature input**

Description Determines type of measured value.

- Selection**
- Level linearized
 - Temperature
 - Pressure
 - Density

Factory setting Level linearized

Additional information

Read access	Operator
Write access	Maintenance

0 % value



Navigation Setup → Advanced setup → Input/output → Analog IP → 0 % value

Prerequisite **Operating mode (→ 207) = 4..20mA input**

Description Defines the value represented by a current of 4mA.

User entry -100 000 to 100 000 mm

Factory setting 0 mm

Additional information

Read access	Operator
Write access	Maintenance

100 % value



Navigation Setup → Advanced setup → Input/output → Analog IP → 100 % value

Prerequisite **Operating mode (→ 207) = 4..20mA input**

Description Defines the value represented by a current of 20mA.

User entry -100 000 to 100 000 mm

Factory setting 0 mm

Additional information

Read access	Operator
Write access	Maintenance

Input value

Navigation  Setup → Advanced setup → Input/output → Analog IP → Input value

Prerequisite **Operating mode (→  207) ≠ Disabled**

Description Shows the value received via the analog input.

Additional information

Read access	Operator
Write access	-

Minimum probe temperature



Navigation  Setup → Advanced setup → Input/output → Analog IP → Minimum probe temperature

Prerequisite **Operating mode (→  207) = RTD temperature input**

Description Minimum approved temperature of the connected probe. If the temperature falls below this value, the W&M status will be 'invalid'.

User entry -213 to 927 °C

Factory setting -100 °C

Additional information

Read access	Operator
Write access	Maintenance

Maximum probe temperature



Navigation  Setup → Advanced setup → Input/output → Analog IP → Maximum probe temperature

Prerequisite **Operating mode (→  207) = RTD temperature input**

Description Maximum approved temperature of the connected probe. If the temperature rises above this value, the W&M status will be 'invalid'.

User entry -213 to 927 °C

Factory setting 250 °C

Additional information

Read access	Operator
Write access	Maintenance

Probe position



Navigation Setup → Advanced setup → Input/output → Analog IP → Probe position

Prerequisite **Operating mode (→ 207) = RTD temperature input**

Description Position of the temperature probe, measured from zero position (tank bottom or datum plate). This parameter, in conjunction with the measured level, determines whether the temperature probe is still covered by the product. If this is no longer the case, the status of the temperature value will be 'invalid'.

User entry -5 000 to 30 000 mm

Factory setting 5 000 mm

Additional information

Read access	Operator
Write access	Maintenance

Damping factor



Navigation Setup → Advanced setup → Input/output → Analog IP → Damping factor

Prerequisite **Operating mode (→ 207) ≠ Disabled**

Description Defines the damping constant (in seconds).



User entry 0 to 999.9 s

Factory setting 0 s

Additional information

Read access	Operator
Write access	Maintenance

Gauge current

Navigation Setup → Advanced setup → Input/output → Analog IP → Gauge current**Prerequisite****Operating mode (→  207) = Gauge power supply****Description**

Shows the current on the power supply line for the connected device.

Additional information

Read access	Operator
Write access	-

"Analog I/O" submenu

i There is a **Analog I/O** submenu for each Analog I/O module of the device. This submenu refers to terminals 1 to 3 of this module (an analog input or output). For terminals 4 to 8 (always an analog input) refer to → **207**.

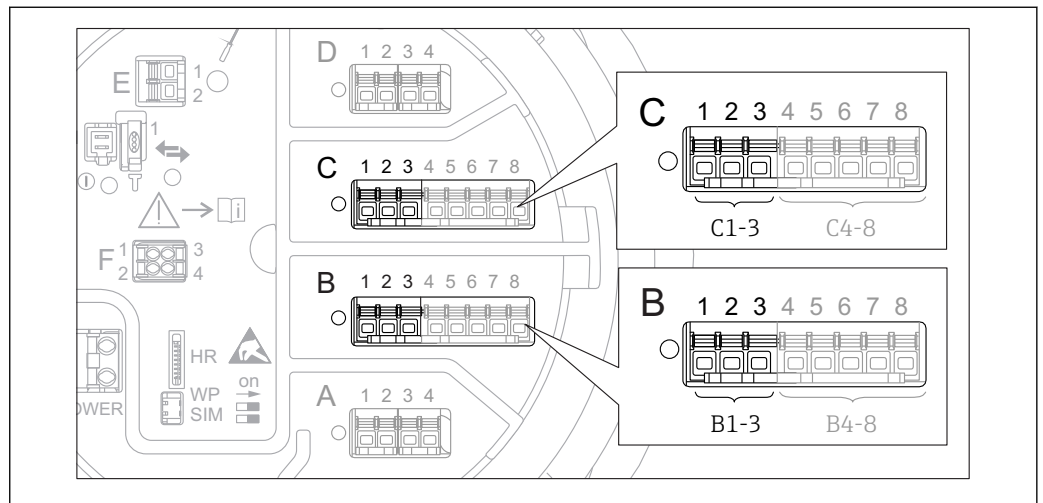

A0032464

78 Terminals for the "Analog I/O" submenu ("B1-3" or "C1-3", respectively)

Navigation **☰** Setup → Advanced setup → Input/output → Analog I/O

Operating mode **🔒**

Navigation **☰** Setup → Advanced setup → Input/output → Analog I/O → Operating mode

Description Defines the operating mode of the analog I/O module.

- Selection**
- Disabled
 - 4..20mA input
 - HART master+4..20mA input
 - HART master
 - 4..20mA output
 - HART slave +4..20mA output

Factory setting Disabled

Additional information

Read access	Operator
Write access	Maintenance

Meaning of the options

Operating mode (→ 213)	Direction of signal	Type of signal
Disabled	-	-
4..20mA input	Input from 1 external device	Analog (4...20mA)
HART master+4..20mA input	Input from 1 external device	<ul style="list-style-type: none"> ■ Analog (4...20mA) ■ HART
HART master	Input from up to 6 external devices	HART

Operating mode (→  213)	Direction of signal	Type of signal
4...20mA output	Output to higher-level unit	Analog (4...20mA)
HART slave +4...20mA output	Output to higher-level unit	<ul style="list-style-type: none"> ■ Analog (4...20mA) ■ HART

Depending on the terminals used, the Analog I/O module is used in the passive or active mode.

Mode	Terminals of the I/O module		
	1	2	3
Passive (power supply from external source)	-	+	not used
Active (power supplied by the device itself)	not used	-	+

-  In the active mode the following conditions must be met:
- Maximum current consumption of the connected HART devices: 24 mA (i.e. 4 mA per device if 6 devices are connected).
 - Output voltage of the Ex-d module: 17.0 V@4 mA to 10.5 V@22 mA
 - Output voltage of the Ex-ia module: 18.5 V@4 mA to 12.5 V@22 mA

Current span



Navigation

  Setup → Advanced setup → Input/output → Analog I/O → Current span

Prerequisite

Operating mode parameter (→  213) ≠ **Disabled** option or **HART master** option

Description

Defines the current range for the measured value transmission.

Selection

- 4...20 mA NAMUR
- 4...20 mA US
- 4...20 mA
- Fixed current *

Factory setting

4...20 mA NAMUR

Additional information

Read access	Operator
Write access	Maintenance

Meaning of the options



Option	Current range for process variable	Lower alarm signal level	Upper alarm signal level
4...20 mA	4 to 20.5 mA	< 3.6 mA	> 21.95 mA
4...20 mA NAMUR	3.8 to 20.5 mA	< 3.6 mA	> 21.95 mA

* Visibility depends on order options or device settings

Option	Current range for process variable	Lower alarm signal level	Upper alarm signal level
4...20 mA US	3.9 to 20.8 mA	< 3.6 mA	> 21.95 mA
Fixed current	Constant current, defined in the Fixed current parameter (→ ⓘ 215).		

 In the case of an error, the output current assumes the value defined in the **Failure mode** parameter (→ ⓘ 216).

Fixed current

Navigation   Setup → Advanced setup → Input/output → Analog I/O → Fixed current

Prerequisite **Current span** (→ ⓘ 214) = **Fixed current**

Description Defines the fixed output current.

User entry 4 to 22.5 mA

Factory setting 4 mA

Additional information

Read access	Operator
Write access	Maintenance

Analog input source

Navigation   Setup → Advanced setup → Input/output → Analog I/O → Analog input source

Prerequisite

- **Operating mode** (→ ⓘ 213) = **4..20mA output** or **HART slave +4..20mA output**
- **Current span** (→ ⓘ 214) ≠ **Fixed current**

Description Defines the process variable transmitted via the AIO.

Selection

- None
- Tank level
- Tank level %
- Tank ullage
- Tank ullage %
- Measured level
- Distance
- Displacer position
- Water level
- Upper interface level
- Lower interface level
- Bottom level
- Tank reference height
- Liquid temperature
- Vapor temperature
- Air temperature

- Observed density value
- Average profile density ⁵⁾
- Upper density
- Middle density
- Lower density
- P1 (bottom)
- P2 (middle)
- P3 (top)
- GP 1 ... 4 value
- AIO B1-3 value ⁵⁾
- AIO B1-3 value mA ⁵⁾
- AIO C1-3 value ⁵⁾
- AIO C1-3 value mA ⁵⁾
- AIP B4-8 value ⁵⁾
- AIP C4-8 value ⁵⁾
- Element temperature 1 ... 24 ⁵⁾
- HART device 1...15 PV ⁵⁾
- HART device 1 ... 15 PV mA ⁵⁾
- HART device 1 ... 15 PV % ⁵⁾
- HART device 1 ... 15 SV ⁵⁾
- HART device 1 ... 15 TV ⁵⁾
- HART device 1 ... 15 QV ⁵⁾

Factory setting

Tank level

Additional information

Read access	Operator
Write access	Maintenance

Failure mode



Navigation

Setup → Advanced setup → Input/output → Analog I/O → Failure mode

Prerequisite

Operating mode (→ 213) = 4..20mA output or HART slave +4..20mA output

Description

Defines the output behavior in case of an error.

Selection

- Min.
- Max.
- Last valid value
- Actual value
- Defined value

Factory setting

Max.

Additional information

Read access	Operator
Write access	Maintenance

⁵⁾ Visibility depends on order options or device settings

Error value



Navigation Setup → Advanced setup → Input/output → Analog I/O → Error value

Prerequisite **Failure mode (→ 216) = Defined value**

Description Defines the output value in case of an error.

User entry 3.4 to 22.6 mA

Factory setting 22 mA

Additional information

Read access	Operator
Write access	Maintenance

Input value

Navigation Setup → Advanced setup → Input/output → Analog I/O → Input value

Prerequisite

- **Operating mode (→ 213) = 4..20mA output or HART slave +4..20mA output**
- **Current span (→ 214) ≠ Fixed current**

Description Shows the input value of the analog I/O module.

Additional information

Read access	Operator
Write access	-

0 % value



Navigation Setup → Advanced setup → Input/output → Analog I/O → 0 % value

Prerequisite

- **Operating mode (→ 213) = 4..20mA output or HART slave +4..20mA output**
- **Current span (→ 214) ≠ Fixed current**

Description Value corresponding to an output current of 0% (4mA).





User entry Signed floating-point number

Factory setting 0 Unitless

Additional information

Read access	Operator
Write access	Maintenance





100 % value 

Navigation	  Setup → Advanced setup → Input/output → Analog I/O → 100 % value
Prerequisite	<ul style="list-style-type: none"> ▪ Operating mode (→  213) = 4..20mA output or HART slave +4..20mA output ▪ Current span (→  214) ≠ Fixed current
Description	Value corresponding to an output current of 100% (20mA).
User entry	Signed floating-point number
Factory setting	0 Unitless

Additional information

Read access	Operator
Write access	Maintenance



Input value %

Navigation	  Setup → Advanced setup → Input/output → Analog I/O → Input value %
Prerequisite	<ul style="list-style-type: none"> ▪ Operating mode (→  213) = 4..20mA output or HART slave +4..20mA output ▪ Current span (→  214) ≠ Fixed current
Description	Shows the output value as a percentage of the complete 4...20mA range.

Additional information

Read access	Operator
Write access	-

Output value

Navigation	  Setup → Advanced setup → Input/output → Analog I/O → Output value
Prerequisite	Operating mode (→  213) = 4..20mA output or HART slave +4..20mA output
Description	Shows the output value in mA.

Additional information

Read access	Operator
Write access	-

Process variable



- Navigation** Setup → Advanced setup → Input/output → Analog I/O → Process variable
- Prerequisite** **Operating mode (→ 213) = 4..20mA input or HART master+4..20mA input**
- Description** Defines the type of measuring variable.
- Selection**
 - Level linearized
 - Temperature
 - Pressure
 - Density
- Factory setting** Level linearized

Additional information

Read access	Operator
Write access	Maintenance

Analog input 0% value



- Navigation** Setup → Advanced setup → Input/output → Analog I/O → Analog input 0% value
- Prerequisite** **Operating mode (→ 213) = 4..20mA input or HART master+4..20mA input**
- Description** Value corresponding to an input current of 0% (4mA).
- User entry** -100 000 to 100 000 mm
- Factory setting** 0 mm

Additional information

Read access	Operator
Write access	Maintenance

Analog input 100% value



- Navigation** Setup → Advanced setup → Input/output → Analog I/O → Analog input 100% value
- Prerequisite** **Operating mode (→ 213) = 4..20mA input or HART master+4..20mA input**
- Description** Value corresponding to an input current of 100% (20mA).
- User entry** -100 000 to 100 000 mm
- Factory setting** 0 mm

Additional information

Read access	Operator
Write access	Maintenance

Error event type**Navigation**

Setup → Advanced setup → Input/output → Analog I/O → Error event type

Prerequisite

Operating mode (→ 213) ≠ Disabled or HART master

Description

Defines the type of event message (alarm/warning) in case of an error or output out of range in the analog I/O module.

Selection

- None
- Warning
- Alarm

Factory setting

Warning

Additional information

Read access	Operator
Write access	Maintenance

Process value**Navigation**

Setup → Advanced setup → Input/output → Analog I/O → Process value

Prerequisite

Operating mode (→ 213) = 4..20mA input or HART master+4..20mA input

Description

Shows the input value scaled to customer units.

Additional information

Read access	Operator
Write access	-

Input value in mA**Navigation**

Setup → Advanced setup → Input/output → Analog I/O → Input value in mA

Prerequisite

Operating mode (→ 213) = 4..20mA input or HART master+4..20mA input



Description

Shows the input value in mA.

Additional information



Read access	Operator
Write access	-

Input value percent

Navigation	 Setup → Advanced setup → Input/output → Analog I/O → Input value percent				
Prerequisite	Operating mode (→  213) = 4..20mA input or HART master+4..20mA input				
Description	Shows the input value as a percentage of the complete 4...20mA current range.				
Additional information	<table border="1" style="width: 100%; border-collapse: collapse;"> <tr> <td style="width: 50%;">Read access</td> <td>Operator</td> </tr> <tr> <td>Write access</td> <td>-</td> </tr> </table>	Read access	Operator	Write access	-
Read access	Operator				
Write access	-				



Damping factor



Navigation	 Setup → Advanced setup → Input/output → Analog I/O → Damping factor				
Prerequisite	Operating mode (→  213) ≠ Disabled or HART master				
Description	Defines the damping constant (in seconds).				
User entry	0 to 999.9 s				
Factory setting	0 s				
Additional information	<table border="1" style="width: 100%; border-collapse: collapse;"> <tr> <td style="width: 50%;">Read access</td> <td>Operator</td> </tr> <tr> <td>Write access</td> <td>Maintenance</td> </tr> </table>	Read access	Operator	Write access	Maintenance
Read access	Operator				
Write access	Maintenance				

Used for SIL/WHG



Navigation	 Setup → Advanced setup → Input/output → Analog I/O → Used for SIL/WHG				
Prerequisite	<ul style="list-style-type: none"> ▪ Operating mode (→  213) = 4..20mA output or HART slave +4..20mA output ▪ The device has a SIL approval. 				
Description	Determines whether the discrete I/O module is in SIL/WHG mode.				
Selection	<ul style="list-style-type: none"> ▪ Enabled ▪ Disabled 				
Factory setting	Disabled				
Additional information	<table border="1" style="width: 100%; border-collapse: collapse;"> <tr> <td style="width: 50%;">Read access</td> <td>Operator</td> </tr> <tr> <td>Write access</td> <td>Maintenance</td> </tr> </table>	Read access	Operator	Write access	Maintenance
Read access	Operator				
Write access	Maintenance				

Expected SIL/WHG chain

Navigation Setup → Advanced setup → Input/output → Analog I/O → Expected SIL/WHG chain**Prerequisite**

- **Operating mode (→  213) = 4..20mA output or HART slave +4..20mA output**
- The device has a SIL approval.

Additional information

Read access	Operator
Write access	-

"Digital Xx-x" submenu

- i
 - In the operating menu, each digital input or output is designated by the respective slot of the terminal compartment and two terminals within this slot. **A1-2**, for example, denotes terminals 1 and 2 of slot **A**. The same is valid for slots **B**, **C** and **D** if they contain a Digital IO module.
 - In this document, **Xx-x** designates any of these submenus. The structure of all these submenus is the same.

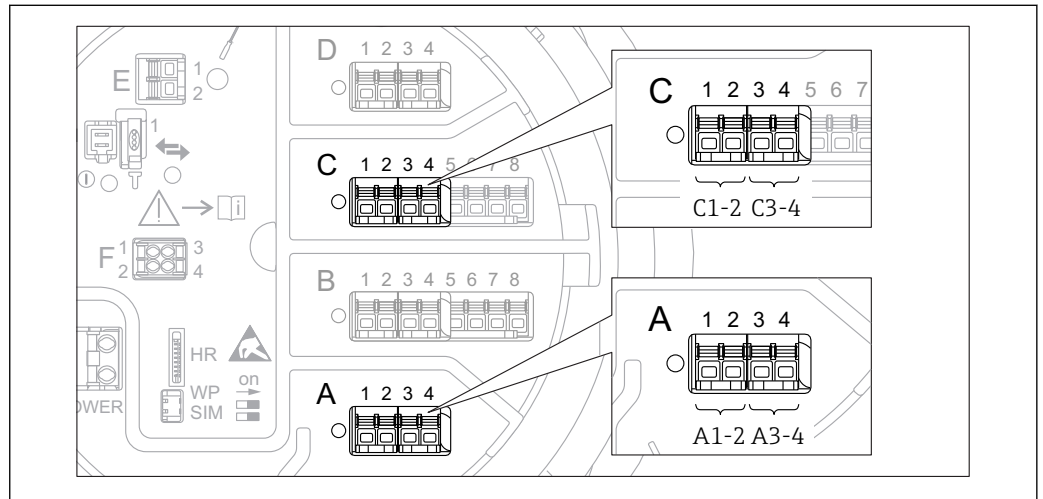

A0026424

79 Designation of the digital inputs or outputs (examples)

Navigation ☰ Setup → Advanced setup → Input/output → Digital Xx-x

Operating mode 🔒

Navigation	☰ Setup → Advanced setup → Input/output → Digital Xx-x → Operating mode
Description	Defines the operating mode of the discrete I/O module.
Selection	<ul style="list-style-type: none"> ▪ Disabled ▪ Output passive ▪ Input passive ▪ Input active
Factory setting	Disabled

Additional information

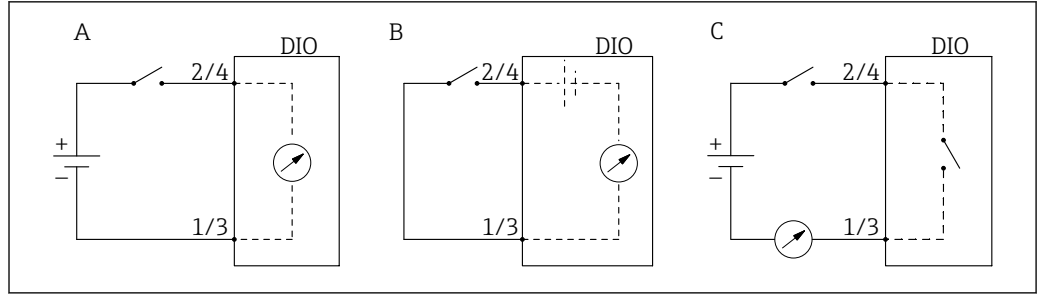

80 Operating modes of the Digital I/O module

- A Input passive
- B Input active
- C Output passive

Digital input source



Navigation

Setup → Advanced setup → Input/output → Digital Xx-x → Digital input source

Prerequisite

Operating mode (→ 223) = Output passive

Description

Defines which device state is indicated by the digital output.

Selection

- None
- Alarm x any
- Alarm x High
- Alarm x HighHigh
- Alarm x High or HighHigh
- Alarm x Low
- Alarm x LowLow
- Alarm x Low or LowLow
- Digital Xx-x
- Pri. Modbus x
- Sec. Modbus x

Factory setting

None

Additional information

Meaning of the options

- **Alarm x any, Alarm x High, Alarm x HighHigh, Alarm x High or HighHigh, Alarm x Low, Alarm x LowLow, Alarm x Low or LowLow**

The digital output indicates if the selected alarm is currently active. The alarms themselves are defined in the **Alarm 1 to 4** submenus.

- **Digital Xx-x**⁶⁾

The digital signal present at the digital input **Xx-x** is passed through to the digital output.

- **Modbus A1-4 Discrete x**
- **Modbus B1-4 Discrete x**
- **Modbus C1-4 Discrete x**
- **Modbus D1-4 Discrete x**

The digital value written by the Modbus Master device to the **Modbus discrete x** parameter⁷⁾ is passed to the digital output. For details refer to Special Documentation SD02066G.

6) Only present if "Operating mode (→ 223)" = "Input passive" or "Input active" for the respective Digital I/O module.

7) Expert → Communication → Modbus Xx-x → Modbus discrete x

Input value

Navigation   Setup → Advanced setup → Input/output → Digital Xx-x → Input value

Prerequisite **Operating mode (→  223) = "Input passive" option or "Input active" option**

Description Shows the digital input value.

Additional information

Read access	Operator
Write access	-

Contact type



Navigation   Setup → Advanced setup → Input/output → Digital Xx-x → Contact type

Prerequisite **Operating mode (→  223) ≠ Disabled**

Description Determines the switching behavior of the input or output.



Selection

- Normally open
- Normally closed

Factory setting Normally open

Output simulation



Navigation   Setup → Advanced setup → Input/output → Digital Xx-x → Output simulation

Prerequisite **Operating mode (→  223) = Output passive**

Description Sets the output to a specific simulated value.

Selection

- Disable
- Simulating active
- Simulating inactive
- Fault 1
- Fault 2

Factory setting Disable

Additional information

Read access	Operator
Write access	Maintenance

The digital output consists of two relays connected in series:

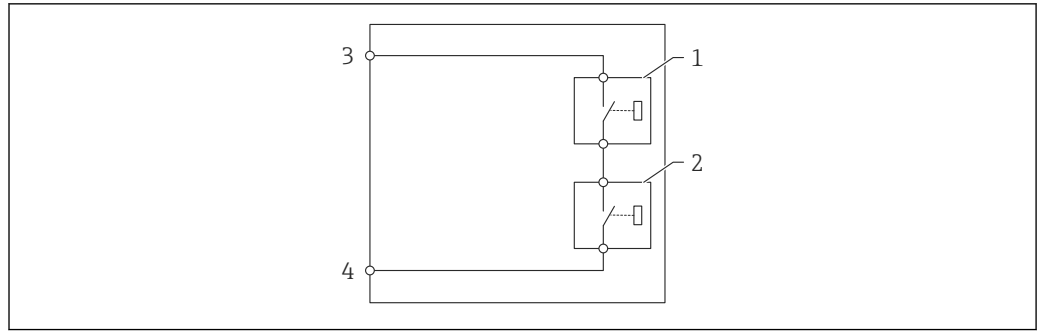

A0028602

81 The two relays of a digital output

1/2 The relays

3/4 The terminals of the digital output

The switching state of these relays is defined by the **Output simulation** parameter as follows:

Output simulation	State of relay 1	State of relay 2	Expected result on the terminals of the I/O module
Simulating active	Closed	Closed	Closed
Simulating inactive	Open	Open	Open
Fault 1	Closed	Open	Open
Fault 2	Open	Closed	Open

i The **Fault 1** and **Fault 2** options can be used to check the correct switching behavior of the two relays.

Output value

Navigation

Setup → Advanced setup → Input/output → Digital Xx-x → Output values

Prerequisite

Operating mode (→ 223) = Output passive

Description

Shows the digital output value.

Additional information

Read access	Operator
Write access	-

Readback value

Navigation

Setup → Advanced setup → Input/output → Digital Xx-x → Readback value

Prerequisite

Operating mode (→ 223) = Output passive

Description

Shows the value read back from the output.

Additional information

Read access	Operator
Write access	-

Used for SIL/WHG



Navigation

Setup → Advanced setup → Input/output → Digital Xx-x → Used for SIL/WHG

Prerequisite

- **Operating mode** (→ 223) = **Output passive**
- The device has a SIL certificate.

Description

Determines whether the discrete I/O module is in SIL/WHG mode.

Selection

- Enabled
- Disabled

Factory setting

Disabled

Additional information

Read access	Operator
Write access	Maintenance

"Digital input mapping" submenu

Navigation  Setup → Advanced setup → Input/output → Digital input mapping

Digital input source 1 

Navigation  Setup → Advanced setup → Input/output → Digital input mapping → Digital input source 1

Description Selects the source of digital input #1 (for gauge command).

- Selection**
- None
 - Digital A1-2 *
 - Digital A3-4 *
 - Digital B1-2 *
 - Digital B3-4 *
 - Digital C1-2 *
 - Digital C3-4 *
 - Digital D1-2 *
 - Digital D3-4 *

Factory setting None

Additional information

Read access	Operator
Write access	Maintenance

Digital input source 2 

Navigation  Setup → Advanced setup → Input/output → Digital input mapping → Digital input source 2

Description Selects the source of digital input #2 (for gauge command).

- Selection**
- None
 - Digital A1-2 *
 - Digital A3-4 *
 - Digital B1-2 *
 - Digital B3-4 *
 - Digital C1-2 *
 - Digital C3-4 *
 - Digital D1-2 *
 - Digital D3-4 *

Factory setting None

* Visibility depends on order options or device settings

Additional information

Read access	Operator
Write access	Maintenance

Gauge command 0**Navigation**

Setup → Advanced setup → Input/output → Digital input mapping → Gauge command 0

Prerequisite

Digital input source 1 (→ 228) ≠ None

Description

Gauge command assigned to digital input combination 0 (DI2=0, DI1=0).

Selection

- Stop
- Level
- Up
- Bottom level
- Upper I/F level
- Lower I/F level
- Upper density
- Middle density
- Lower density
- Repeatability
- Water dip
- Release overtension
- Tank profile
- Interface profile
- Manual profile
- Level standby

Factory setting

Level

Additional information

Read access	Operator
Write access	Maintenance

Gauge command 1**Navigation**

Setup → Advanced setup → Input/output → Digital input mapping → Gauge command 1

Prerequisite

Digital input source 1 (→ 228) ≠ None

Description

Gauge command assigned to digital input combination 1 (DI2=0, DI1=1).

Selection

- Stop
- Level
- Up
- Bottom level
- Upper I/F level
- Lower I/F level

- Upper density
- Middle density
- Lower density
- Repeatability
- Water dip
- Release overtension
- Tank profile
- Interface profile
- Manual profile
- Level standby

Factory setting

Up

Additional information

Read access	Operator
Write access	Maintenance

Gauge command 2



Navigation

Setup → Advanced setup → Input/output → Digital input mapping → Gauge command 2

Prerequisite

- **Digital input source 1** (→ 228) ≠ None
- **Digital input source 2** (→ 228) ≠ None

Description

Gauge command assigned to digital Input combination 2 (DI2=1, DI1=0).

Selection

- Stop
- Level
- Up
- Bottom level
- Upper I/F level
- Lower I/F level
- Upper density
- Middle density
- Lower density
- Repeatability
- Water dip
- Release overtension
- Tank profile
- Interface profile
- Manual profile
- Level standby

Factory setting

Stop

Additional information

Read access	Operator
Write access	Maintenance

Gauge command 3



Navigation Setup → Advanced setup → Input/output → Digital input mapping → Gauge command 3

Prerequisite

- **Digital input source 1** (→ 228) ≠ None
- **Digital input source 2** (→ 228) ≠ None

Description Gauge command assigned to digital input combination 3 (DI2=1, DI1=1).

Selection

- Stop
- Level
- Up
- Bottom level
- Upper I/F level
- Lower I/F level
- Upper density
- Middle density
- Lower density
- Repeatability
- Water dip
- Release overtension
- Tank profile
- Interface profile
- Manual profile
- Level standby

Factory setting Upper I/F level

Additional information

Read access	Operator
Write access	Maintenance

"Communication" submenu

This menu contains a submenu for each digital communication interface of the device. The communication interfaces are designated by "X1-4" where "X" specifies the slot in the terminal compartment and "1-4" the terminals within this slot.

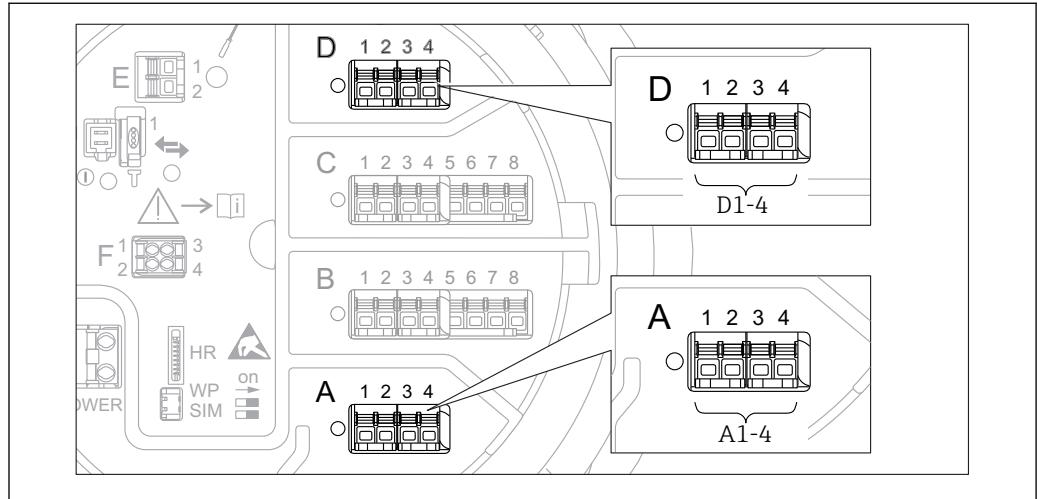

A0031200

82 Designation of the "Modbus" or "V1" modules (examples); depending on the device version these modules may also be in slot B or C.

Navigation Setup → Advanced setup → Communication

"Modbus X1-4" or "V1 X1-4" submenu

This submenu is only present for devices with **MODBUS** and/or **V1** communication interface. There is one submenu of this type for each communication interface.

Navigation Setup → Advanced setup → Communication → Modbus X1-4 / V1 X1-4

Communication interface protocol

Navigation Setup → Advanced setup → Communication → Modbus X1-4 / V1 X1-4 → Communication interface protocol

Description Shows the type of communication protocol.

Additional information

Read access	Operator
Write access	-

"Configuration" submenu

This submenu is only present for devices with a **MODBUS** communication interface.

Navigation  Setup → Advanced setup → Communication → Modbus X1-4 → Configuration

Baudrate 

Navigation  Setup → Advanced setup → Communication → Modbus X1-4 → Configuration → Baudrate

Prerequisite **Communication interface protocol (→  232) = MODBUS**

Description Defines the baud rate of the Modbus communication.

- Selection**
- 300 BAUD
 - 600 BAUD
 - 1200 BAUD
 - 2400 BAUD
 - 4800 BAUD
 - 9600 BAUD
 - 19200 BAUD

Factory setting 9600 BAUD

Additional information

Read access	Operator
Write access	Maintenance

Parity 

Navigation  Setup → Advanced setup → Communication → Modbus X1-4 → Configuration → Parity

Prerequisite **Communication interface protocol (→  232) = MODBUS**

Description Defines the parity of the Modbus communication.

- Selection**
- Odd
 - Even
 - None / 1 stop bit
 - None / 2 stop bits

Factory setting None / 1 stop bit

Additional information

Read access	Operator
Write access	Maintenance

Modbus address



Navigation Setup → Advanced setup → Communication → Modbus X1-4 → Configuration → Device ID

Prerequisite **Communication interface protocol (→ 232) = MODBUS**

Description Defines the Modbus address of the device.

User entry 1 to 247

Factory setting 1

Additional information

Read access	Operator
Write access	Maintenance

Float swap mode



Navigation Setup → Advanced setup → Communication → Modbus X1-4 → Configuration → Float swap mode

Prerequisite **Communication interface protocol (→ 232) = MODBUS**

Description Sets the format of how the floating point value is transferred on Modbus.

- Selection**
- Normal 3-2-1-0
 - Swap 0-1-2-3
 - WW Swap 1-0-3-2

Factory setting Swap 0-1-2-3

Additional information

Read access	Operator
Write access	Maintenance

Bus termination



Navigation Setup → Advanced setup → Communication → Modbus X1-4 → Configuration → Bus termination

Prerequisite **Communication interface protocol (→ 232) = MODBUS**

Description Activates or deactivates the bus termination at the device. Should only be activated on the last device in a loop.

- Selection**
- Off
 - On

Factory setting

Off

Additional information

Read access	Operator
Write access	Maintenance

"Configuration" submenu

This submenu is only present for devices with a **V1** communication interface.

Navigation  Setup → Advanced setup → Communication → V1 X1-4 → Configuration

Communication interface protocol variant 

Navigation  Setup → Advanced setup → Communication → V1 X1-4 → Configuration → Communication interface protocol variant

Description Determines which variant of the V1 protocol is used.

User interface

- None
- V1 *

Factory setting None

Additional information

Read access	Operator
Write access	Maintenance

V1 address 

Navigation  Setup → Advanced setup → Communication → V1 X1-4 → Configuration → V1 address

Prerequisite **Communication interface protocol variant (→  236) = V1**

Description Identifier of the device for the V1 communication.

User entry 0 to 99

Factory setting 1

Additional information

Read access	Operator
Write access	Maintenance

* Visibility depends on order options or device settings

V1 address



Navigation	Setup → Advanced setup → Communication → V1 X1-4 → Configuration → V1 address				
Prerequisite	Communication interface protocol variant (→ 236)				
Description	Identifier of the previous device for V1 communication.				
User entry	0 to 255				
Factory setting	1				
Additional information	<table border="1" style="width: 100%; border-collapse: collapse;"> <tr> <td style="width: 50%;">Read access</td> <td>Operator</td> </tr> <tr> <td>Write access</td> <td>Maintenance</td> </tr> </table>	Read access	Operator	Write access	Maintenance
Read access	Operator				
Write access	Maintenance				

Level mapping



Navigation	Setup → Advanced setup → Communication → V1 X1-4 → Configuration → Level mapping				
Prerequisite	Communication interface protocol (→ 232) = V1				
Description	Determines the transmittable range of levels.				
Selection	<ul style="list-style-type: none"> ■ +ve ■ +ve & -ve 				
Factory setting	+ve				
Additional information	<table border="1" style="width: 100%; border-collapse: collapse;"> <tr> <td style="width: 50%;">Read access</td> <td>Operator</td> </tr> <tr> <td>Write access</td> <td>Maintenance</td> </tr> </table>	Read access	Operator	Write access	Maintenance
Read access	Operator				
Write access	Maintenance				

In V1, the level is always represented by a number in the range from 0 to 999 999. This number corresponds to a level as follows:

"Level mapping" = "+ve"

Number	Corresponding level
0	0.0 mm
999 999	99 999.9 mm

"Level mapping" = "+ve & -ve"

Number	Corresponding level
0	0.0 mm
500 000	50 000.0 mm

Number	Corresponding level
500 001	-0.1 mm
999 999	-49 999.9 mm

Line impedance

Navigation   Setup → Advanced setup → Communication → V1 X1-4 → Configuration → Line impedance

Prerequisite **Communication interface protocol (→  232) = V1**

Description Adjusts the impedance of the communication line.

User entry 0 to 15



Factory setting 15

Additional information

Read access	Operator
Write access	Maintenance

 The line impedance affects the voltage difference between a logical 0 and a logical 1 on the message of the device to the bus. The default setting is suitable for most applications.

Compatibility mode

Navigation   Setup → Advanced setup → Communication → Modbus Xx-x / V1 Xx-x → Configuration → Compatibility mode

Description Defines the compatibility mode.

Selection

- NMS5x
- NMS8x

Factory setting NMS8x

Additional information

Read access	Operator
Write access	Maintenance

"V1 input selector" submenu

This submenu is only present for devices with a **V1** communication interface.

Navigation  Setup → Advanced setup → Communication → V1 X1-4 → V1 input selector

Alarm 1 input source 

Navigation  Setup → Advanced setup → Communication → V1 X1-4 → V1 input selector → Alarm 1 input source

Description Determines which discrete value will be transmitted as V1 alarm 1 status.

- Selection**
- None
 - Alarm 1-4 any
 - Alarm 1-4 HighHigh
 - Alarm 1-4 High or HighHigh
 - Alarm 1-4 High
 - Alarm 1-4 Low
 - Alarm 1-4 Low or LowLow
 - Alarm 1-4 LowLow

Factory setting None

Additional information

Read access	Operator
Write access	Maintenance

Alarm 2 input source 

Navigation  Setup → Advanced setup → Communication → V1 X1-4 → V1 input selector → Alarm 2 input source

Description Determines which discrete value will be transmitted as V1 alarm 2 status.

- Selection**
- None
 - Alarm 1-4 any
 - Alarm 1-4 HighHigh
 - Alarm 1-4 High or HighHigh
 - Alarm 1-4 High
 - Alarm 1-4 Low
 - Alarm 1-4 Low or LowLow
 - Alarm 1-4 LowLow

Factory setting None

Additional information

Read access	Operator
Write access	Maintenance

Value percent selector

**Navigation**

Setup → Advanced setup → Communication → V1 X1-4 → V1 input selector → Value percent selector

Description

Selects which value shall be transmitted as a 0..100% value in the V1 Z0/Z1 message.

Selection

- None
- Tank level %
- Tank ullage %
- AIO B1-3 value % *
- AIO C1-3 value % *

Factory setting

None

Additional information

Read access	Operator
Write access	Maintenance

* Visibility depends on order options or device settings

"HART output" submenu

Navigation  Setup → Advanced setup → Communication → HART output

"Configuration" submenu

Navigation  Setup → Advanced setup → Communication → HART output → Configuration

System polling address 

Navigation  Setup → Advanced setup → Communication → HART output → Configuration → System polling address

Description Device address for HART communication.

User entry 0 to 63

Factory setting 15

Additional information

Read access	Operator
Write access	Maintenance

No. of preambles 

Navigation  Setup → Advanced setup → Communication → HART output → Configuration → No. of preambles

Description Defines the number of preambles in the HART telegram.

User entry 5 to 20

Factory setting 5

Additional information

Read access	Operator
Write access	Maintenance

PV source 

Navigation  Setup → Advanced setup → Communication → HART output → Configuration → PV source

Description Decides, if the PV configuration is according to an analog output (HART slave) or customized (in case of HART tunneling only).

- Selection**
- AIO B1-3 *
 - AIO C1-3 *
 - Custom

Factory setting Custom

Additional information

Read access	Maintenance
Write access	Maintenance

Assign PV



Navigation Setup → Advanced setup → Communication → HART output → Configuration → Assign PV

Prerequisite PV source (→ 241) = Custom

Description Assigns a tank variable to the primary HART variable (PV).

- Selection**
- None
 - Tank level
 - Tank ullage
 - Measured level
 - Distance
 - Displacer position
 - Water level
 - Upper interface level
 - Lower interface level
 - Bottom level
 - Tank reference height
 - Liquid temperature
 - Vapor temperature
 - Air temperature
 - Observed density value
 - Average profile density
 - Upper density
 - Middle density
 - Lower density
 - P1 (bottom)
 - P2 (middle)
 - P3 (top)
 - GP 1 value
 - GP 2 value
 - GP 3 value
 - GP 4 value

Factory setting Tank level

* Visibility depends on order options or device settings

Additional information

Read access	Operator
Write access	Maintenance

 The **Measured level** option doesn't contain a unit. If a unit is needed, select the **Tank level** option.

0 % value



Navigation

 Setup → Advanced setup → Communication → HART output → Configuration → 0 % value

Prerequisite

PV source = Custom

Description

0% value of the primary variable (PV).

User entry

-100 000 to 100 000 mm

Factory setting

0 mm

Additional information

Read access	Operator
Write access	Maintenance

100 % value



Navigation

 Setup → Advanced setup → Communication → HART output → Configuration → 100 % value

Prerequisite

PV source = Custom

Description

100% value of the primary variable (PV).

User entry

-100 000 to 100 000 mm

Factory setting

0 mm

Additional information

Read access	Operator
Write access	Maintenance

PV mA selector



Navigation

 Setup → Advanced setup → Communication → HART output → Configuration → PV mA selector

Prerequisite

PV source = Custom

Description Assigns a current to the primary HART variable (PV).

Selection

- None
- AIO B1-3 value mA *
- AIO C1-3 value mA *

Factory setting None

Additional information

Read access	Operator
Write access	Maintenance

Primary variable (PV)

Navigation  Setup → Advanced setup → Communication → HART output → Configuration → Primary variable (PV)

Description Shows the value of the primary HART variable (PV).

Additional information

Read access	Operator
Write access	-

Percent of range

Navigation  Setup → Advanced setup → Communication → HART output → Configuration → Percent of range

Description Shows the value of the primary variable (PV) as a percentage of the defined 0% to 100% range.

Additional information

Read access	Operator
Write access	-

Assign SV

Navigation  Setup → Advanced setup → Communication → HART output → Configuration → Assign SV

Description Assigns a tank variable to the secondary HART variable (SV).

Selection

- None
- Tank level
- Tank ullage

* Visibility depends on order options or device settings

- Measured level
- Distance
- Displacer position
- Water level
- Upper interface level
- Lower interface level
- Bottom level
- Tank reference height
- Liquid temperature
- Vapor temperature
- Air temperature
- Observed density value
- Average profile density
- Upper density
- Middle density
- Lower density
- P1 (bottom)
- P2 (middle)
- P3 (top)
- GP 1 value
- GP 2 value
- GP 3 value
- GP 4 value

Factory setting

Liquid temperature

Additional information

Read access	Operator
Write access	Maintenance



The **Measured level** option doesn't contain a unit. If a unit is needed, select the **Tank level** option.

Secondary variable (SV)

Navigation

Setup → Advanced setup → Communication → HART output → Configuration → Secondary variable (SV)

Prerequisite

Assign SV (→ 244) ≠ None

Description

Shows the value of the secondary HART variable (SV).

Additional information

Read access	Operator
Write access	-

Assign TV



Navigation

Setup → Advanced setup → Communication → HART output → Configuration → Assign TV

Description

Assigns a tank variable to the third HART variable (TV).

Selection

- None
- Tank level
- Tank ullage
- Measured level
- Distance
- Displacer position
- Water level
- Upper interface level
- Lower interface level
- Bottom level
- Tank reference height
- Liquid temperature
- Vapor temperature
- Air temperature
- Observed density value
- Average profile density
- Upper density
- Middle density
- Lower density
- P1 (bottom)
- P2 (middle)
- P3 (top)
- GP 1 value
- GP 2 value
- GP 3 value
- GP 4 value

Factory setting

Water level

Additional information

Read access	Operator
Write access	Maintenance

The **Measured level** option doesn't contain a unit. If a unit is needed, select the **Tank level** option.

Tertiary variable (TV)

Navigation

Setup → Advanced setup → Communication → HART output → Configuration → Tertiary variable (TV)

Prerequisite

Assign TV (→ 246) ≠ None

Description

Shows the value of the third HART variable (TV).

Additional information

Read access	Operator
Write access	-

Assign QV



Navigation

Setup → Advanced setup → Communication → HART output → Configuration → Assign QV

Description

Assigns a tank variable to the fourth HART variable (QV).

Selection

- None
- Tank level
- Tank ullage
- Measured level
- Distance
- Displacer position
- Water level
- Upper interface level
- Lower interface level
- Bottom level
- Tank reference height
- Liquid temperature
- Vapor temperature
- Air temperature
- Observed density value
- Average profile density
- Upper density
- Middle density
- Lower density
- P1 (bottom)
- P2 (middle)
- P3 (top)
- GP 1 value
- GP 2 value
- GP 3 value
- GP 4 value

Factory setting

Observed density value

Additional information

Read access	Operator
Write access	Maintenance



The **Measured level** option doesn't contain a unit. If a unit is needed, select the **Tank level** option.

Quaternary variable (QV)

Navigation

 Setup → Advanced setup → Communication → HART output → Configuration
→ Quaternary variable (QV)

Prerequisite

Assign QV (→  247) ≠ None

Description

Shows the value of the fourth HART variable (QV).

Additional information

Read access	Operator
Write access	-

"Information" submenu

Navigation  Setup → Advanced setup → Communication → HART output → Information

HART short tag 

Navigation  Setup → Advanced setup → Communication → HART output → Information → HART short tag

Description Defines the short tag for the measuring point. Maximum length: 8 characters Allowed characters: A-Z, 0-9, certain special characters.

Factory setting NMS8x

Additional information

Read access	Operator
Write access	Maintenance

Device tag 

Navigation  Setup → Advanced setup → Communication → HART output → Information → Device tag

Description Enter a unique name for the measuring point to identify the device quickly within the plant.

Factory setting NMS8x

Additional information

Read access	Operator
Write access	Maintenance

HART descriptor 

Navigation  Setup → Advanced setup → Communication → HART output → Information → HART descriptor

Description User defined HART descriptor (16 characters).

Factory setting NMS8x

Additional information

Read access	Operator
Write access	Maintenance

HART message**Navigation**

Setup → Advanced setup → Communication → HART output → Information → HART message

Description

User defined HART message (32 characters).

Factory setting

NMS8x

Additional information

Read access	Operator
Write access	Maintenance

HART date code**Navigation**

Setup → Advanced setup → Communication → HART output → Information → HART date code

Description

Enter date of the last configuration change. Use this format yyyy-mm-dd.

Factory setting

2009-07-20

Additional information

Read access	Operator
Write access	Maintenance

"Application" submenu

Navigation  Setup → Advanced setup → Application

"Tank configuration" submenu

Navigation  Setup → Advanced setup → Application → Tank configuration

"Level" submenu

Navigation  Setup → Advanced setup → Application → Tank configuration → Level

Level source 

Navigation  Setup → Advanced setup → Application → Tank configuration → Level → Level source

Description Defines the source of the level value.

- Selection**
- No input value
 - HART device 1 ... 15 level
 - Level SR*
 - Level*
 - Displacer position*
 - AIO B1-3 value*
 - AIO C1-3 value*
 - AIP B4-8 value*
 - AIP C4-8 value*

Factory setting Dependent on the device version

Additional information

Read access	Operator
Write access	Maintenance

Empty 

Navigation  Setup → Advanced setup → Application → Tank configuration → Level → Empty

Description Distance from reference point to zero position (tank bottom or datum plate).

User entry 0 to 10 000.00 mm

Factory setting Dependent on the device version

* Visibility depends on order options or device settings

Additional information

Read access	Operator
Write access	Maintenance

 The reference point is the reference line of the calibration window.

Tank reference height 

Navigation

 Setup → Advanced setup → Application → Tank configuration → Level → Tank reference height

Description

Defines the distance from the dipping reference point to the zero position (tank bottom or datum plate).

User entry

0 to 10 000.00 mm

Factory setting

Dependent on the device version

Additional information

Read access	Operator
Write access	Maintenance

Tank level

Navigation

 Setup → Advanced setup → Application → Tank configuration → Level → Tank level

Description

Shows the distance from the zero position (tank bottom or datum plate) to the product surface.

Additional information

Read access	Operator
Write access	-

Set level 

Navigation

 Setup → Advanced setup → Application → Tank configuration → Level → Set level

Description

If the level measured by the device does not match the actual level obtained by a manual dip, enter the correct level into this parameter.

User entry

0 to 10 000.00 mm



Factory setting





0 mm



Additional information

Read access	Operator
Write access	Maintenance

The device adjusts the **Empty** parameter (→  187) according to the entered value, such that the measured level will match the actual level.

Water level source						
Navigation	  Setup → Advanced setup → Application → Tank configuration → Level → Water level source					
Description	Defines the source of the bottom water level.					
Selection	<ul style="list-style-type: none"> ■ Manual value ■ Bottom level ■ HART device 1 ... 15 level ■ AIO B1-3 value ■ AIO C1-3 value ■ AIP B4-8 value ■ AIP C4-8 value 					
Factory setting	Manual value					
Additional information	<table border="1" style="width: 100%; border-collapse: collapse;"> <tr> <td style="width: 50%; padding: 2px;">Read access</td> <td style="padding: 2px;">Operator</td> </tr> <tr> <td style="padding: 2px;">Write access</td> <td style="padding: 2px;">Maintenance</td> </tr> </table>		Read access	Operator	Write access	Maintenance
Read access	Operator					
Write access	Maintenance					

Manual water level						
Navigation	  Setup → Advanced setup → Application → Tank configuration → Level → Manual water level					
Prerequisite	Water level source (→  253) = Manual value					
Description	Defines the manual value of the bottom water level.					
User entry	-2 000 to 5 000 mm					
Factory setting	0 mm					
Additional information	<table border="1" style="width: 100%; border-collapse: collapse;"> <tr> <td style="width: 50%; padding: 2px;">Read access</td> <td style="padding: 2px;">Operator</td> </tr> <tr> <td style="padding: 2px;">Write access</td> <td style="padding: 2px;">Maintenance</td> </tr> </table>		Read access	Operator	Write access	Maintenance
Read access	Operator					
Write access	Maintenance					

Water level	
Navigation	  Setup → Advanced setup → Application → Tank configuration → Level → Water level
Description	Shows the bottom water level.

Additional information

Read access	Operator
Write access	-

"Temperature" submenu

Read access	Maintenance
-------------	-------------

Navigation  Setup → Advanced setup → Application → Tank configuration → Temperature

Liquid temp source 

Navigation  Setup → Advanced setup → Application → Tank configuration → Temperature → Liquid temp source

Description Defines source from which the liquid temperature is obtained.

- Selection**
- Manual value
 - HART device 1 ... 15 temperature
 - AIO B1-3 value
 - AIO C1-3 value
 - AIP B4-8 value
 - AIP C4-8 value

Factory setting Manual value

Additional information

Read access	Operator
Write access	Maintenance

Manual liquid temperature 

Navigation  Setup → Advanced setup → Application → Tank configuration → Temperature → Manual liquid temperature

Prerequisite **Liquid temp source (→  190) = Manual value**

Description Defines the manual value of the liquid temperature.



User entry -50 to 300 °C

Factory setting 25 °C

Additional information

Read access	Operator
Write access	Maintenance

Liquid temperature



Navigation   Setup → Advanced setup → Application → Tank configuration → Temperature → Liquid temperature

Description Shows the average or spot temperature of the measured liquid.

Additional information

Read access	Operator
Write access	-

Air temperature source

Navigation   Setup → Advanced setup → Application → Tank configuration → Temperature → Air temperature source

Description Defines source from which the air temperature is obtained.



- Selection**
- Manual value
 - HART device 1 ... 15 temperature
 - AIO B1-3 value
 - AIO C1-3 value
 - AIP B4-8 value
 - AIP C4-8 value

Factory setting Manual value

Additional information

Read access	Operator
Write access	Maintenance

Manual air temperature

Navigation   Setup → Advanced setup → Application → Tank configuration → Temperature → Manual air temperature

Prerequisite **Air temperature source** (→  256) = **Manual value**

Description Defines the manual value of the air temperature.

User entry -50 to 300 °C

Factory setting 25 °C

Additional information

Read access	Operator
Write access	Maintenance

Air temperature

Navigation  Setup → Advanced setup → Application → Tank configuration → Temperature → Air temperature

Description Shows the air temperature.

Additional information

Read access	Operator
Write access	-

Vapor temp source



Navigation  Setup → Advanced setup → Application → Tank configuration → Temperature → Vapor temp source

Description Defines the source from which the vapor temperature is obtained.

- Selection**
- Manual value
 - HART device 1 ... 15 vapor temp
 - AIO B1-3 value
 - AIO C1-3 value
 - AIP B4-8 value
 - AIP C4-8 value

Factory setting Manual value

Additional information

Read access	Operator
Write access	Maintenance

Manual vapor temperature



Navigation  Setup → Advanced setup → Application → Tank configuration → Temperature → Manual vapor temperature

Prerequisite **Vapor temp source (→  257) = Manual value**

Description Defines the manual value of the vapor temperature.

User entry -50 to 300 °C

Factory setting 25 °C

Additional information

Read access	Operator
Write access	Maintenance

Vapor temperature

Navigation

 Setup → Advanced setup → Application → Tank configuration → Temperature
→ Vapor temperature

Description

Shows the measured vapor temperature.

Additional information

Read access	Operator
Write access	-

"Density" submenu

Navigation  Setup → Advanced setup → Application → Tank configuration → Density

Observed density source 

Navigation  Setup → Advanced setup → Application → Tank configuration → Density → Observed density source

Description Determines how the density is obtained.

- Selection**
- HTG *
 - HTMS *
 - Average profile density *
 - Upper density
 - Middle density
 - Lower density

Factory setting Dependent on the device version

Additional information

Read access	Operator
Write access	Maintenance

Observed density

Navigation  Setup → Advanced setup → Application → Tank configuration → Density → Observed density

Description Shows the measured or calculated density.

Additional information

Read access	Operator
Write access	-

Air density 

Navigation  Setup → Advanced setup → Application → Tank configuration → Density → Air density

Description Defines the density of the air surrounding the tank.

User entry 0.0 to 500.0 kg/m³

* Visibility depends on order options or device settings

Factory setting 1.2 kg/m³

Additional information

Read access	Operator
Write access	Maintenance

Vapor density



Navigation

Setup → Advanced setup → Application → Tank configuration → Density → Vapor density

Description

Defines the density of the gas phase in the tank.

User entry

0.0 to 500.0 kg/m³

Factory setting

1.2 kg/m³

Additional information

Read access	Operator
Write access	Maintenance

"Pressure" submenu

Navigation  Setup → Advanced setup → Application → Tank configuration → Pressure

P1 (bottom) source 

Navigation  Setup → Advanced setup → Application → Tank configuration → Pressure → P1 (bottom) source

Description Defines the source of the bottom pressure (P1).

- Selection**
- Manual value
 - HART device 1 ... 15 pressure
 - AIO B1-3 value
 - AIO C1-3 value
 - AIP B4-8 value
 - AIP C4-8 value

Factory setting Manual value

Additional information

Read access	Operator
Write access	Maintenance

P1 (bottom)

Navigation  Setup → Advanced setup → Application → Tank configuration → Pressure → P1 (bottom)

Description Shows the pressure at the tank bottom.

Additional information

Read access	Operator
Write access	-

P1 (bottom) manual pressure 

Navigation  Setup → Advanced setup → Application → Tank configuration → Pressure → P1 (bottom) manual pressure

Prerequisite P1 (bottom) source (→  261) = Manual value

Description Defines the manual value of the bottom pressure (P1).

User entry -25 to 25 bar

Factory setting 0 bar

Additional information

Read access	Operator
Write access	Maintenance

P1 position 

Navigation

  Setup → Advanced setup → Application → Tank configuration → Pressure → P1 position

Description

Defines the position of the bottom pressure transmitter (P1), measured from zero position (tank bottom or datum plate).

User entry

-10 000 to 100 000 mm

Factory setting



5 000 mm

Additional information

Read access	Operator
Write access	Maintenance

P1 offset 

Navigation

  Setup → Advanced setup → Application → Tank configuration → Pressure → P1 offset

Description

Offset for the bottom pressure (P1). The offset is added to the measured pressure prior to any tank calculation.

User entry

-25 to 25 bar

Factory setting

0 bar

Additional information

Read access	Operator
Write access	Maintenance

P1 absolute / gauge 

Navigation

  Setup → Advanced setup → Application → Tank configuration → Pressure → P1 absolute / gauge

Description

Defines whether the connected pressure transmitter measures an absolute or a gauge pressure.

Selection

- Absolute
- Gauge

Factory setting

Gauge

Additional information

Read access	Operator
Write access	Maintenance

P3 (top) source



Navigation

Setup → Advanced setup → Application → Tank configuration → Pressure → P3 (top) source

Description

Defines the source of the top pressure (P3).

Selection

- Manual value
- HART device 1 ... 15 pressure
- AIO B1-3 value
- AIO C1-3 value
- AIP B4-8 value
- AIP C4-8 value

Factory setting

Manual value

Additional information

Read access	Operator
Write access	Maintenance

P3 (top)

Navigation

Setup → Advanced setup → Application → Tank configuration → Pressure → P3 (top)

Description

Shows the pressure (P3) at the top transmitter.

Additional information

Read access	Operator
Write access	-

P3 (top) manual pressure



Navigation

Setup → Advanced setup → Application → Tank configuration → Pressure → P3 (top) manual pressure

Prerequisite

P3 (top) source (→ 263) = Manual value

Description

Defines the manual value of the top pressure (P3).

User entry

-2.5 to 2.5 bar

Factory setting

0 bar

Additional information

Read access	Operator
Write access	Maintenance

P3 position**Navigation**

Setup → Advanced setup → Application → Tank configuration → Pressure → P3 position

Description

Defines the position of the top pressure transmitter (P3), measured from zero position (tank bottom or datum plate).

User entry

0 to 100 000 mm

Factory setting

20 000 mm

Additional information

Read access	Operator
Write access	Maintenance

P3 offset**Navigation**

Setup → Advanced setup → Application → Tank configuration → Pressure → P3 offset

Description

Offset for the top pressure (P3). The offset is added to the measured pressure prior to any tank calculation.

User entry

-2.5 to 2.5 bar

Factory setting

0 bar

Additional information

Read access	Operator
Write access	Maintenance

P3 absolute / gauge**Navigation**

Setup → Advanced setup → Application → Tank configuration → Pressure → P3 absolute / gauge

Description

Defines whether the connected pressure transmitter measures an absolute or a gauge pressure.

Selection

- Absolute
- Gauge

Factory setting

Gauge

Additional information

Read access	Operator
Write access	Maintenance

Ambient pressure



Navigation

Setup → Advanced setup → Application → Tank configuration → Pressure → Ambient pressure

Description

Defines the manual value of the ambient pressure.

User entry

0 to 2.5 bar

Factory setting

1 bar

Additional information

Read access	Operator
Write access	Maintenance

"Tank calculation" submenu

Navigation  Setup → Advanced setup → Application → Tank calculation

*"HyTD" submenu**Overview*

Hydrostatic Tank Deformation can be used to compensate the vertical movement of the Gauge Reference Height (GRH) due to bulging of the tank shell caused by the hydrostatic pressure exerted by the liquid stored in the tank. The compensation is based on a linear approximation obtained from manual hand dips at several levels distributed over the full range of the tank.

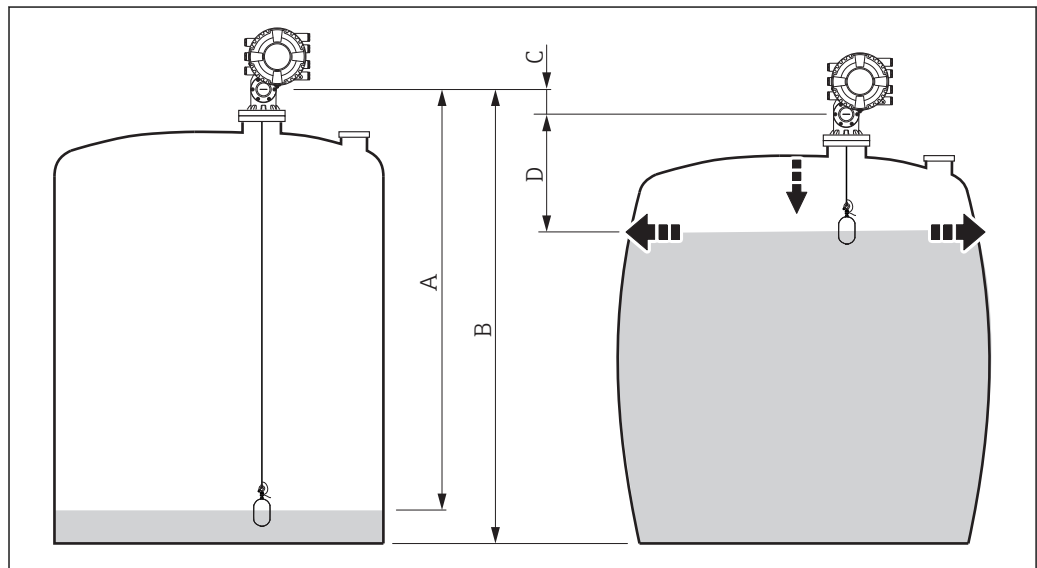

A0030164

 83 Correction of the hydrostatic tank deformation (HyTD)

- A "Distance" (level below L_0 → "HyTD correction value" = 0)
- B Gauge Reference Height (GRH)
- C HyTD correction value
- D "Distance" (level above L_0 → "HyTD correction value" > 0)

Linear approximation of the HyTD correction

The real amount of deformation varies non-linearly with the level due to the construction of the tank. However, as the correction values are typically small compared to the measured level, a simple straight line method can be used with good results.

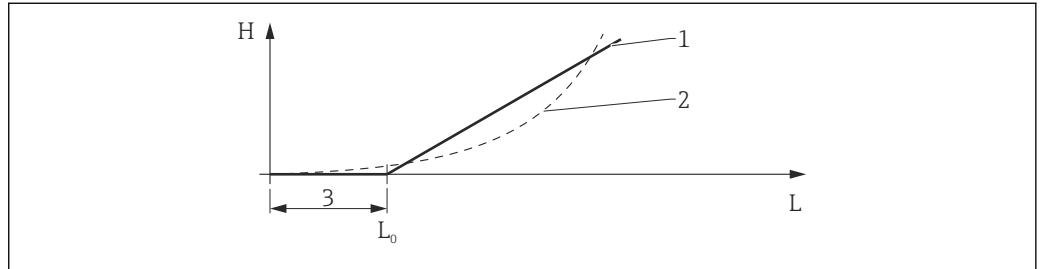

A0028724

84 Calculation of the HyTD correction

- 1 Linear correction according to "Deformation factor (→ 269)"
- 2 Real correction
- 3 Starting level (→ 268)
- L Measured level
- H HyTD correction value (→ 268)

Calculation of the HyTD correction

$$L \leq L_0 \Rightarrow C_{HyTD} = 0$$

$$L > L_0 \Rightarrow C_{HyTD} = - (L - L_0) \times D$$

A0028715

L	Measured level
L₀	Starting level
C_{HyTD}	HyTD correction value
D	Deformation factor

Description of parameters

Navigation  Setup → Advanced setup → Application → Tank calculation → HyTD

HyTD correction value

Navigation  Setup → Advanced setup → Application → Tank calculation → HyTD → HyTD correction value

Description Shows the correction value from the Hydrostatic Tank Deformation.

Additional information

Read access	Operator
Write access	-

HyTD mode



Navigation  Setup → Advanced setup → Application → Tank calculation → HyTD → HyTD mode

Description Activates or deactivates the calculation of the Hydrostatic Tank Deformation.

- Selection**
- No
 - Yes

Factory setting No

Additional information

Read access	Operator
Write access	Maintenance

Starting level



Navigation  Setup → Advanced setup → Application → Tank calculation → HyTD → Starting level

Description Defines the starting level for the Hydrostatic Tank Deformation. Levels below this value are not corrected.

User entry 0 to 5 000 mm

Factory setting 500 mm

Additional information

Read access	Operator
Write access	Maintenance

Deformation factor



Navigation

Setup → Advanced setup → Application → Tank calculation → HyTD → Deformation factor

Description

Defines the deformation factor for the HyTD (change of device position per change of level).

User entry

-1.0 to 1.0 %

Factory setting



0.2 %

Additional information

Read access	Operator
Write access	Maintenance

*"CTSh" submenu**Overview*

CTSh (correction for the thermal expansion of the tank shell) compensates for effects on the Gauge Reference Height (GRH) and on the expansion or contraction of the measuring wire due to temperature effects on the tank shell or stilling well. The temperature effects are separated into two parts, respectively affecting the 'dry' and 'wetted' part of the tank shell or stilling well. The correction function is based on thermal expansion coefficients of steel and insulation factors for both the 'dry' and 'wet' parts of the wire and the tank shell. The temperatures used for the correction can be selected from on manual or measured values.

-  This correction is recommended for the following situations:
 - if the operating temperature deviates considerably from the temperature during calibration ($\Delta T > 10\text{ °C}$ (18 °F))
 - for extremely high tanks
 - for refrigerated, cryogenic or heated applications
-  As the use of this correction will influence the innage level reading, it is recommended to ensure the manual hand dip and level verification procedures are being conducted correctly before enabling this correction method.
-  This mode cannot be used in conjunction with HTG because the level is not measured relative to the gauge reference height with HTG.

CTSh: Calculation of the wall temperature

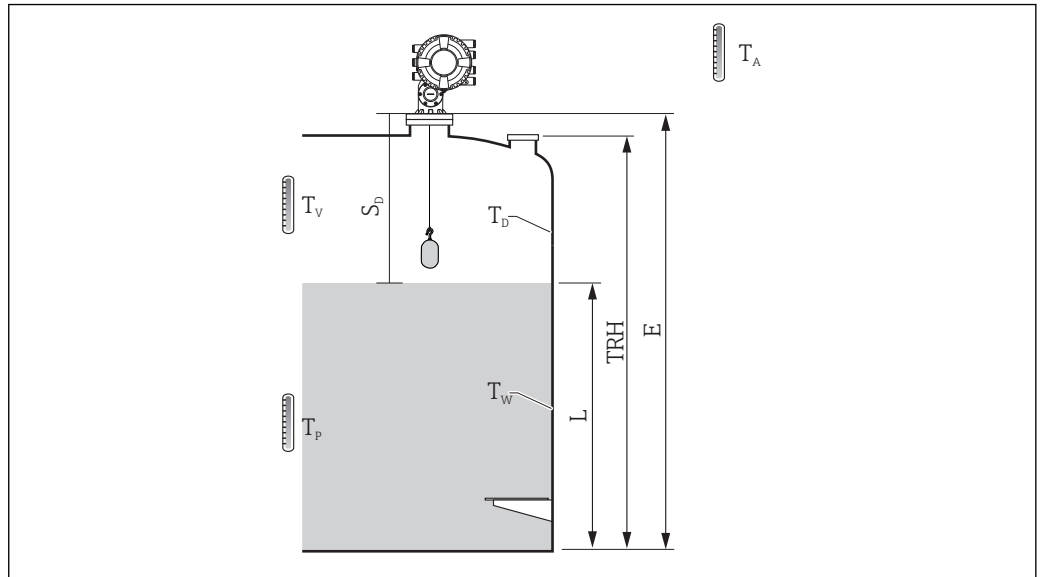

A0028713

85 Parameters for the CTSh calculation

T_W	Temperature of the wetted part of the tank shell
T_D	Temperature of the dry part of the tank shell
T_P	Product temperature
T_V	Vapor temperature (in the tank)
T_A	Ambient temperature (atmosphere surrounding the tank)
S_d	Measured distance (Empty to Level)
TRH	Tank reference height
E	Empty
L	Level

CTSh: Calculation of the wall temperature

Depending on the parameters **Covered tank** (→ 273) and **Stilling well** (→ 274), the temperatures T_W of the wetted and T_D of the dry part of the tank wall are calculated as follows:

Covered tank (→ 273)	Stilling well (→ 274)	T_W	T_D
Covered	Yes ¹⁾	T_P	T_V
	No	$(7/8) T_P + (1/8) T_A$	$(1/2) T_V + (1/2) T_A$
Open top	Yes	T_P	T_A
	No	$(7/8) T_P + (1/8) T_A$	T_A

1) This option is also valid for insulated tanks without a stilling well. This is due to the temperature inside and outside of the tank shell being the same due to the insulation of the tank.

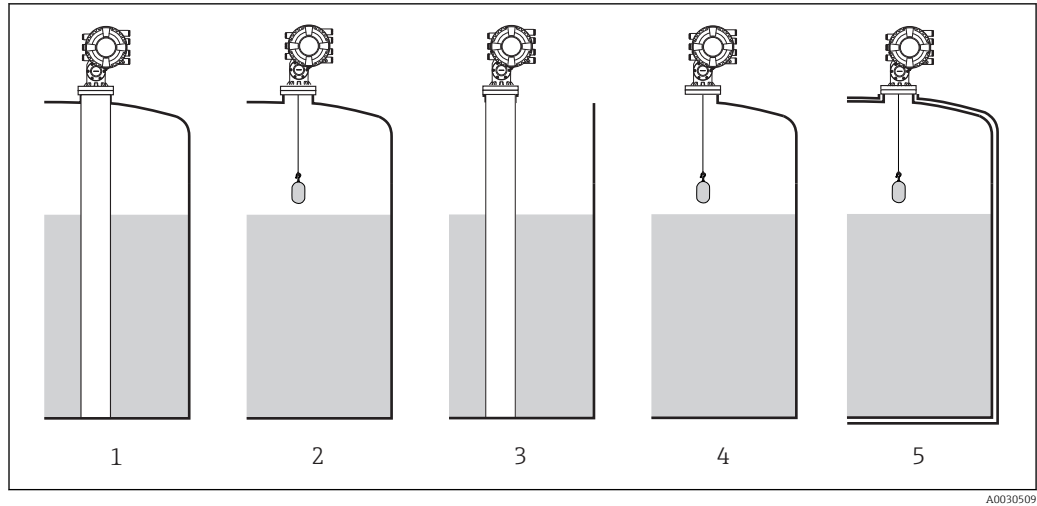

- 1 Covered tank (→ 273) = Covered; Stilling well (→ 274) = Yes
- 2 Covered tank (→ 273) = Covered; Stilling well (→ 274) = No
- 3 Covered tank (→ 273) = Open top; Stilling well (→ 274) = Yes
- 4 Covered tank (→ 273) = Open top; Stilling well (→ 274) = No
- 5 Insulated tank: Covered tank (→ 273) = Open top; Stilling well (→ 274) = Yes

CTSh: Calculation of the correction

$$C_{CTSh} = \alpha_{\text{tank}} (TRH - L) (T_D - T_{\text{cal}}) + \alpha_{\text{tank}} L (T_W - T_{\text{cal}}) - \alpha_{\text{wire}} S_D (T_v - T_{\text{cal}})$$

TRH	Tank reference height
L	Level
T_D	Temperature of the dry part of the tank shell (calculated from T _p , T _v and T _A)
T_W	Temperature of the wetted part of the tank shell (calculated from T _p , T _v and T _A)
T_{cal}	Temperature at which the measurement has been calibrated
α_{tank}	Linear expansion coefficient of tank
α_{wire}	Linear expansion coefficient of wire
C_{CTSh}	CTSh correction value

Description of parameters

Navigation  Setup → Advanced setup → Application → Tank calculation → CTSh

CTSh correction value

Navigation  Setup → Advanced setup → Application → Tank calculation → CTSh → CTSh correction value

Description Shows the CTSh correction value.

Additional information

Read access	Operator
Write access	-

CTSh mode



Navigation  Setup → Advanced setup → Application → Tank calculation → CTSh → CTSh mode

Description Activates or deactivates the CTSh.

- Selection**
- No
 - Yes
 - With wire *
 - Only wire *

Factory setting No

Additional information

Read access	Operator
Write access	Maintenance

Covered tank



Navigation  Setup → Advanced setup → Application → Tank calculation → CTSh → Covered tank

Description Determines whether the tank is covered.

- Selection**
- Open top
 - Covered

Factory setting Open top

* Visibility depends on order options or device settings

Additional information

Read access	Operator
Write access	Maintenance

 The **Covered** option is only valid for fixed tank roofs. For a floating roof select **Open top**.

Stilling well**Navigation**

 Setup → Advanced setup → Application → Tank calculation → CTSh → Stilling well

Description

Determines whether the device is mounted on a stilling well.

Selection

- No
- Yes

Factory setting

No

Additional information

Read access	Operator
Write access	Maintenance

Calibration temperature**Navigation**

 Setup → Advanced setup → Application → Tank calculation → CTSh → Calibration temperature

Description

Specify temperature at which the measurement has been calibrated.

User entry

-50 to 250 °C

Factory setting

25 °C

Additional information

Read access	Operator
Write access	Maintenance

Linear expansion coefficient**Navigation**

 Setup → Advanced setup → Application → Tank calculation → CTSh → Linear expansion coefficient

Description

Defines the linear expansion coefficient of the tank shell material.

User entry

0 to 100 ppm

Factory setting

15 ppm

Additional information

Read access	Operator
Write access	Maintenance

Wire expansion coefficient**Navigation**

Setup → Advanced setup → Application → Tank calculation → CTSh → Wire expansion coefficient

Description

Defines the expansion coefficient of the wire material of the drum. Value is programmed in factory.

User entry

0 to 100 ppm

Factory setting

15 ppm

"HTMS" submenu

Overview

The Hybrid Tank Measurement System (HTMS) is a method to calculate the density of a product in a tank based on both a (top mounted) level and at least one (bottom mounted) pressure measurement. An additional pressure sensor can be installed at the top of the tank to provide information about the vapor pressure and to make the density calculation more accurate. The calculation method also takes into account a possible level of water at the bottom of the tank to make density calculations as accurate as possible.

HTMS parameters

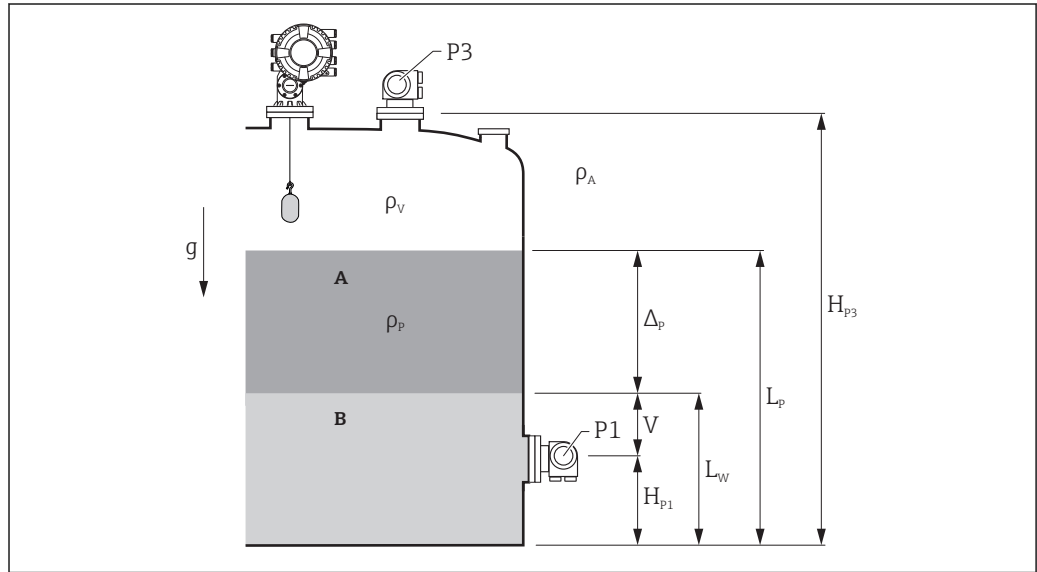

86 HTMS parameters

- A Product
- B Water

Parameter	Navigation path
P1 (Bottom pressure)	Setup → Advanced setup → Tank configuration → Pressure → P1 (bottom)
H_{p1} (Position of P1 transmitter)	Setup → Advanced setup → Tank configuration → Pressure → P1 position
P3 (Top pressure)	Setup → Advanced setup → Tank configuration → Pressure → P3 (top)
H_{p3} (Position of P3 transmitter)	Setup → Advanced setup → Tank configuration → Pressure → P3 position
ρ_p (Density of the product ¹⁾)	<ul style="list-style-type: none"> ■ Measured value: Setup → Advanced setup → Calculation → HTMS → Density value ■ User-defined value: Setup → Advanced setup → Calculation → HTMS → Manual upper density
ρ_v (Vapor density)	Expert → Application → Tank configuration → Density → Vapor density
ρ_A (Ambient air temperature)	Setup → Advanced setup → Tank configuration → Density → Air density
g (Local gravity)	Expert → Application → Tank Calculation → Local gravity
L_p (Level of the product)	Operation → Tank level
L_w (Bottom water level)	Operation → Water level
$V = L_w - H_{p1}$	
$\Delta p = L_p - L_w = L_p - V - H_{p1}$	

1) Depending on the situation this parameter is measured or a user-defined value is used.

HTMS modes

Two HTMS modes can be selected in the **HTMS mode** parameter (→  278). The mode determines whether one or two pressure values are used. Depending on the selected mode a number of additional parameters are required for the calculation of the product density.

 The **HTMS P1+P3** option must be used in pressurized tanks in order to compensate for the pressure of the vapor phase.

HTMS mode (→  278)	Measured variables	Required additional parameters	Calculated variables
HTMS P1	<ul style="list-style-type: none"> ▪ P₁ ▪ L_P 	<ul style="list-style-type: none"> ▪ g ▪ H_{P1} ▪ L_W (optional) 	ρ _P
HTMS P1+P3	<ul style="list-style-type: none"> ▪ P₁ ▪ P₃ ▪ L_P 	<ul style="list-style-type: none"> ▪ ρ_V ▪ ρ_A ▪ g ▪ H_{P1} ▪ H_{P3} ▪ L_W (optional) 	ρ _P (more precise calculation for pressurized tanks)

Minimum level

The density of the product can only be calculated if the product has a minimum thickness :

$$\Delta_p \geq \Delta_{p, \min}$$

A0028864

This is equivalent to the following condition for the product level:

$$L_p - V \geq \Delta_{p, \min} + H_{P1} = L_{\min}$$

A0028863

L_{min} is defined in the **Minimum level** parameter (→  279). As can be seen from the formula it always must be bigger than H_{P1}.

If L_p - V falls below this limit, the density is calculated as follows:

- If a previous calculated value is available, this value will be kept as long as no new calculation is possible.
- If no value was previously calculated, the manual value (defined in the **Manual upper density** parameter) will be used.

Hysteresis

The level of the product in a tank is not constant but slightly varies, due for example to filling disturbances. If the level oscillates around the changeover level (**Minimum level** (→  279)), the algorithm will constantly switch between calculating the value and holding the previous result. To avoid this effect a positional hysteresis is defined around the changeover point.

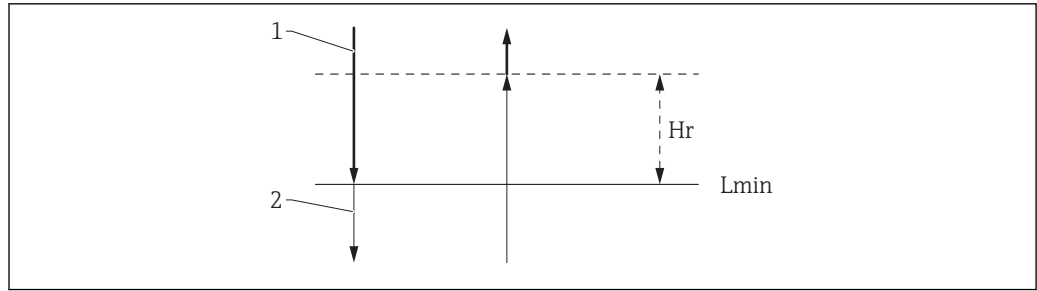

A0029148

87 HTMS hysteresis

- 1 Value calculated
- 2 Value held/manual
- L_{min} Minimum level (→ 279)
- H_r Hysteresis (→ 280)

Description of parameters

Navigation Setup → Advanced setup → Application → Tank calculation → HTMS

HTMS mode

Navigation	Setup → Advanced setup → Application → Tank calculation → HTMS → HTMS mode				
Description	Defines the HTMS mode. Depending on the mode one or two pressure transmitters are used.				
Selection	<ul style="list-style-type: none"> ■ HTMS P1 ■ HTMS P1+P3 				
Factory setting	HTMS P1				
Additional information	<table border="1" style="width: 100%; border-collapse: collapse;"> <tr> <td style="padding: 2px;">Read access</td> <td style="padding: 2px;">Operator</td> </tr> <tr> <td style="padding: 2px;">Write access</td> <td style="padding: 2px;">Maintenance</td> </tr> </table>	Read access	Operator	Write access	Maintenance
Read access	Operator				
Write access	Maintenance				

Meaning of the options

- HTMS P1
Only a bottom pressure transmitter (P1) is used.
- HTMS P1+P3
A bottom (P1) and top (P3) pressure transmitter are used. This option should be selected for pressurized tanks.

Manual density

Navigation	Setup → Advanced setup → Application → Tank calculation → HTMS → Manual density
Description	Defines the manual density.

User entry 0 to 3 000 kg/m³

Factory setting 800 kg/m³

Additional information

Read access	Maintenance
Write access	Maintenance

Density value

Navigation  Setup → Advanced setup → Application → Tank calculation → HTMS → Density value

Description Shows the calculated product density.

Additional information

Read access	Operator
Write access	-

Minimum level



Navigation  Setup → Advanced setup → Application → Tank calculation → HTMS → Minimum level

Description Defines the minimum product level for a HTMS calculation. If Lp - V falls below the limit defined in this parameter, the density retains its last value or the manual value is used instead.

User entry 0 to 20 000 mm

Factory setting 7 000 mm

Additional information

Read access	Operator
Write access	Maintenance

Minimum pressure



Navigation  Setup → Advanced setup → Application → Tank calculation → HTMS → Minimum pressure

Description Defines the minimum pressure for a HTMS calculation. If the pressure P1 (or the difference P1 - P3) falls below the limit defined in this parameter, the density retains its last value or the manual value is used instead.

User entry 0 to 100 bar

Factory setting 0.1 bar

Additional information

Read access	Operator
Write access	Maintenance

Safety distance



Navigation

Setup → Advanced setup → Application → Tank calculation → HTMS → Safety distance

Description

Defines the minimum level which must be present above the bottom pressure sensor before its signal is used for the calculation.

User entry

0 to 10 000 mm

Factory setting

2 000 mm

Additional information

Read access	Operator
Write access	Maintenance

Hysteresis



Navigation

Setup → Advanced setup → Application → Tank calculation → HTMS → Hysteresis

Description

Defines the hysteresis for the HTMS calculation. Prevents constant switching if the level is near the switch-over point.

User entry

0 to 2 000 mm

Factory setting

50 mm

Additional information

Read access	Operator
Write access	Maintenance

Water density



Navigation

Setup → Advanced setup → Application → Tank calculation → HTMS → Water density

Description

Density of the water in the tank.

User entry

Signed floating-point number

Factory setting

1 000 kg/m³

Additional information

Read access	Operator
Write access	Maintenance

"Alarm" submenu

Navigation  Setup → Advanced setup → Application → Alarm → Alarm → Alarm mode

Alarm mode



Navigation  Setup → Advanced setup → Application → Alarm → Alarm → Alarm mode

Description Defines the alarm mode of the selected alarm.

- Selection**
- Off
 - On
 - Latching

Factory setting Off

Additional information

Read access	Operator
Write access	Maintenance

Meaning of the options

- **Off**
No alarms are generated.
- **On**
An alarm disappears if the alarm condition is no longer present (taking into consideration the hysteresis).
- **Latching**
All alarms remain active until the user selects **Clear alarm** (→  288) = **Yes** or the power is switched off and on.

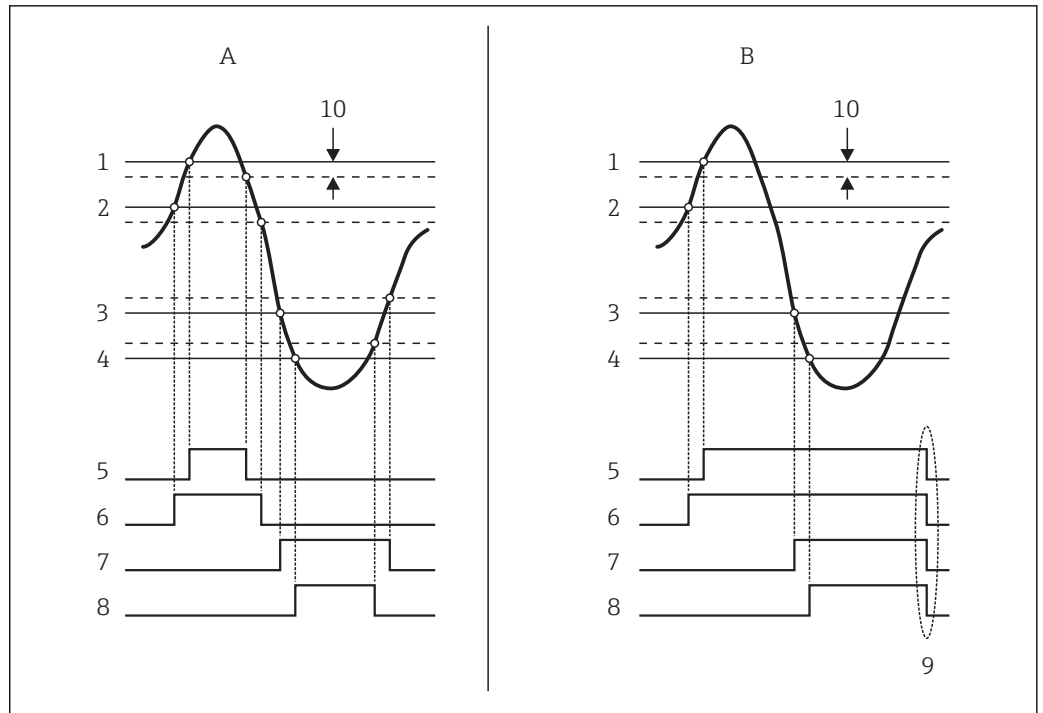

A0029539

88 Principle of the limit evaluation

- A Alarm mode (→ 282) = On
- B Alarm mode (→ 282) = Latching
- 1 HH alarm value (→ 285)
- 2 H alarm value (→ 285)
- 3 L alarm value (→ 286)
- 4 LL alarm value (→ 286)
- 5 HH alarm (→ 286)
- 6 H alarm (→ 287)
- 7 L alarm (→ 287)
- 8 LL alarm (→ 287)
- 9 "Clear alarm (→ 288)" = "Yes" or power off-on
- 10 Hysteresis (→ 289)

Error value



Navigation

Setup → Advanced setup → Application → Alarm → Alarm → Error value

Prerequisite

Alarm mode (→ 282) ≠ Off

Description

Defines the alarm to be issued if the input value is invalid.

Selection

- No alarm
- HH+H alarm
- H alarm
- L alarm
- LL+L alarm
- All alarms

Factory setting

All alarms

Additional information

Read access	Operator
Write access	Maintenance

Alarm value source



Navigation Setup → Advanced setup → Application → Alarm → Alarm → Alarm value source

Prerequisite **Alarm mode (→ 282) ≠ Off**

Description Determines the process variable to be monitored.



- Selection**
- Tank level
 - Liquid temperature
 - Vapor temperature
 - Water level
 - P1 (bottom)
 - P2 (middle)
 - P3 (top)
 - Observed density value
 - Volume
 - Flow velocity
 - Volume flow
 - Vapor density
 - Middle density
 - Upper density
 - Correction
 - Tank level %
 - GP 1...4 value
 - Measured level
 - P3 position
 - Tank reference height
 - Local gravity
 - P1 position
 - Manual density
 - Tank ullage
 - Average profile density
 - Lower density
 - Upper interface level
 - Lower interface level
 - Bottom level
 - Displacer position
 - HART device 1...15 PV
 - HART device 1...15 SV
 - HART device 1...15 TV
 - HART device 1...15 QV
 - HART device 1...15 PV mA
 - HART device 1...15 PV %
 - Element temperature 1...24
 - AIO B1-3 value
 - AIO C1-3 value
 - AIP B4-8 value
 - AIP C4-8 value
 - None

Factory setting None

Additional information

Read access	Operator
Write access	Maintenance

Alarm value

Navigation   Setup → Advanced setup → Application → Alarm → Alarm → Alarm value

Prerequisite **Alarm mode** (→  282) ≠ Off

Description Shows the current value of the process variable being monitored.

User interface Signed floating-point number



Factory setting 0 None

Additional information

Read access	Operator
Write access	-

HH alarm value



Navigation   Setup → Advanced setup → Application → Alarm → Alarm → HH alarm value

Prerequisite **Alarm mode** (→  282) ≠ Off

Description Defines the high-high(HH) limit value.

User entry Signed floating-point number



Factory setting 0 None

Additional information

Read access	Operator
Write access	Maintenance

H alarm value



Navigation   Setup → Advanced setup → Application → Alarm → Alarm → H alarm value

Prerequisite **Alarm mode** (→  282) ≠ Off

Description Defines the high(H) limit value.

User entry Signed floating-point number

Factory setting 0 None

Additional information

Read access	Operator
Write access	Maintenance

L alarm value

Navigation Setup → Advanced setup → Application → Alarm → Alarm → L alarm value

Prerequisite **Alarm mode (→ 282) ≠ Off**

Description Defines the low limit value.

User entry Signed floating-point number

Factory setting 0 None

Additional information

Read access	Operator
Write access	Maintenance

LL alarm value

Navigation Setup → Advanced setup → Application → Alarm → Alarm → LL alarm value

Prerequisite **Alarm mode (→ 282) ≠ Off**

Description Defines the low-low(LL) limit value.

User entry Signed floating-point number

Factory setting 0 None

Additional information

Read access	Operator
Write access	Maintenance

HH alarm

Navigation Setup → Advanced setup → Application → Alarm → Alarm → HH alarm



Prerequisite **Alarm mode (→ 282) ≠ Off**

Description Shows whether an HH alarm is currently active.

Additional information

Read access	Operator
Write access	-

H alarm

Navigation   Setup → Advanced setup → Application → Alarm → Alarm → H alarm



Prerequisite **Alarm mode (→  282) ≠ Off**

Description Shows whether an H alarm is currently active.

Additional information

Read access	Operator
Write access	-

HH+H alarm

Navigation   Setup → Advanced setup → Application → Alarm → Alarm → HH+H alarm

Prerequisite **Alarm mode (→  282) ≠ Off**

Description Shows whether an HH or H alarm is currently active.

Additional information

Read access	Operator
Write access	-

L alarm

Navigation   Setup → Advanced setup → Application → Alarm → Alarm → L alarm

Prerequisite **Alarm mode (→  282) ≠ Off**

Description Shows whether an L alarm is currently active.

Additional information

Read access	Operator
Write access	-

LL alarm

Navigation   Setup → Advanced setup → Application → Alarm → Alarm → LL alarm

Prerequisite **Alarm mode (→  282) ≠ Off**

Description Shows whether an LL alarm is currently active.

Additional information

Read access	Operator
Write access	-

LL+L alarm**Navigation**

 Setup → Advanced setup → Application → Alarm → Alarm → LL+L alarm

Prerequisite

Alarm mode (→  282) ≠ Off

Description

Shows whether an LL or L alarm is currently active.

Additional information

Read access	Operator
Write access	-

Any error**Navigation**

 Setup → Advanced setup → Application → Alarm → Alarm → Any error

Prerequisite

Alarm mode (→  282) ≠ Off

Description

Show whether any alarm is currently active.

User interface

- Unknown
- Inactive
- Active
- Error

Factory setting

Unknown

Additional information

Read access	Operator
Write access	-

Clear alarm**Navigation**

 Setup → Advanced setup → Application → Alarm → Alarm → Clear alarm

Prerequisite

Alarm mode (→  282) = Latching

Description

Deletes an alarm which is still active although the alarm condition is no longer present.

Selection

- No
- Yes

Factory setting

No

Additional information

Read access	Operator
Write access	Maintenance

Alarm hysteresis**Navigation**

Setup → Advanced setup → Application → Alarm → Alarm → Alarm hysteresis

Prerequisite

Alarm mode (→ 282) ≠ Off

Description

Defines the hysteresis for the limit values. The hysteresis prevents constant changes of the alarm state if the level is near one of the limit values.

User entry

Signed floating-point number

Factory setting

0.001

Additional information

Read access	Maintenance
Write access	Maintenance

Damping factor**Navigation**

Setup → Advanced setup → Application → Alarm → Alarm → Damping factor

Description

Defines the damping constant (in seconds).

User entry

0 to 999.9 s

Factory setting

0 s

Additional information

Read access	Operator
Write access	Maintenance



"Safety settings" submenu

Navigation  Setup → Advanced setup → Safety settings

Output out of range 

Navigation	 Setup → Advanced setup → Safety settings → Output out of range				
Description	Selection of behavior between Alarm or Last valid value when displacer reached HighStoplevel, LowStopLevel or ReferencePosition.				
Selection	<ul style="list-style-type: none"> ■ Last valid value ■ Alarm 				
Factory setting	Last valid value				
Additional information	<table border="1" style="width: 100%; border-collapse: collapse;"> <tr> <td style="padding: 2px;">Read access</td> <td style="padding: 2px;">Operator</td> </tr> <tr> <td style="padding: 2px;">Write access</td> <td style="padding: 2px;">Maintenance</td> </tr> </table>	Read access	Operator	Write access	Maintenance
Read access	Operator				
Write access	Maintenance				

Output out of range 

Navigation	 Setup → Advanced setup → Safety settings → Output out of range				
Description	Selection of behavior when displacer reached High stop level (→  189), Low stop level or Reference position .				
Selection	<ul style="list-style-type: none"> ■ Last valid value ■ Alarm 				
Factory setting	Last valid value				
Additional information	<table border="1" style="width: 100%; border-collapse: collapse;"> <tr> <td style="padding: 2px;">Read access</td> <td style="padding: 2px;">Operator</td> </tr> <tr> <td style="padding: 2px;">Write access</td> <td style="padding: 2px;">Maintenance</td> </tr> </table>	Read access	Operator	Write access	Maintenance
Read access	Operator				
Write access	Maintenance				

High stop level 

Navigation	 Setup → Advanced setup → Safety settings → High stop level
Description	Position of the displacer high stop as measured from defined zero position (tank bottom or datum plate).
User entry	-999 999.9 to 999 999.9 mm
Factory setting	Dependent on the device version

Additional information

Read access	Operator
Write access	Maintenance

Low stop level



Navigation

Setup → Advanced setup → Safety settings → Low stop level

Description

Position of the displacer low stop as measured from defined zero position (tank bottom or datum plate).

User entry

-999 999.9 to 999 999.9 mm

Factory setting

0 mm

Additional information

Read access	Operator
Write access	Maintenance

Slow hoist zone



Navigation

Setup → Advanced setup → Safety settings → Slow hoist zone

Description

Defines the interval in millimeters, measured down from the Reference Position, in which the Displacer reduces moving speed.

User entry

10 to 999 999.9 mm

Factory setting

70 mm

Additional information

Read access	Operator
Write access	Maintenance

Overtension weight



Navigation

Setup → Advanced setup → Safety settings → Overtension weight

Description

Sets the minimum Weight in grams when Overtension Alarm will be set.

User entry

100 to 999.9 g

Factory setting

350 g

Additional information

Read access	Operator
Write access	Maintenance

Undertension weight

**Navigation**

Setup → Advanced setup → Safety settings → Undertension weight

Description

Defines the undertension error weight. Undertension error will be issued if displacer weight is below this value longer than 7 seconds.

User entry

0 to 300 g

Factory setting

10 g

Additional information

Read access	Operator
Write access	Maintenance

"Sensor config" submenu

Navigation  Setup → Advanced setup → Sensor config

Post gauge command



Navigation  Setup → Advanced setup → Sensor config → Post gauge command

Description Defines the gauge command that will be executed after a one-time gauge command has finished.

- Selection**
- Stop
 - Level
 - Up
 - Upper I/F level
 - Lower I/F level
 - None

Factory setting Level

Additional information

Read access	Operator
Write access	Maintenance

"Displacer" submenu

Navigation  Setup → Advanced setup → Sensor config → Displacer

Displacer type 

Navigation  Setup → Advanced setup → Sensor config → Displacer → Displacer type

Description Chooses the type of displacer used.

- Selection**
- Custom diameter
 - Diameter 30 mm
 - Diameter 50 mm
 - Diameter 70 mm
 - Diameter 110 mm

Factory setting Dependent on the device version

Additional information

Read access	Operator
Write access	Maintenance

Displacer diameter 

Navigation  Setup → Advanced setup → Sensor config → Displacer → Displacer diameter

Prerequisite **Displacer type (→  294) = Custom diameter**

Description Sets the diameter of the cylindrical part of displacer.

User entry 0 to 999.9 mm

Factory setting See label on the device.

Additional information

Read access	Operator
Write access	Maintenance

Displacer weight 

Navigation  Setup → Advanced setup → Sensor config → Displacer → Displacer weight

Description Set the weight of the displacer in air. Indicated on the displacer in grams.



User entry 10 to 999.9 g

Factory setting See label on the device.

Additional information

Read access	Operator
Write access	Maintenance



Displacer volume 

- Navigation**   Setup → Advanced setup → Sensor config → Displacer → Displacer volume
- Description** Displacer volume indicated on displacer in milliliter.
- User entry** 10 to 999.9 ml
- Factory setting** See label on the device.

Additional information

Read access	Operator
Write access	Maintenance



Displacer balance volume 

- Navigation**   Setup → Advanced setup → Sensor config → Displacer → Displacer balance volume
- Description** Defines the balance volume of the displacer as the lower part of displacer immersed in liquid. Units in milliliters. Indicated on displacer.
- User entry** 10 to 999.9 ml
- Factory setting** See label on the device.

Additional information

Read access	Operator
Write access	Maintenance

Displacer height 

- Navigation**   Setup → Advanced setup → Sensor config → Displacer → Displacer height
- Description** Sets the displacer height in mm.
- User entry** 10 to 300 mm
- Factory setting** Dependent on the device version

Additional information

Read access	Operator
Write access	Maintenance

Immersion depth

**Navigation**

Setup → Advanced setup → Sensor config → Displacer → Immersion depth

Description

Defines distance (mm) from displacer bottom to balancing line defined by balanced volume. Value is needed for correct bottom level measurement.

User entry

0 to 99.9 mm

Factory setting

Dependent on the device version

Additional information

Read access	Operator
Write access	Maintenance

"Wiredrum" submenu

Navigation  Setup → Advanced setup → Sensor config → Wiredrum

Drum circumference 

Navigation  Setup → Advanced setup → Sensor config → Wiredrum → Drum circumference

Description Sets the circumference of the wire drum. Indicated in Label.

User entry 100 to 999.9 mm

Factory setting See label on the device.

Additional information

Read access	Operator
Write access	Maintenance

Wire weight 

Navigation  Setup → Advanced setup → Sensor config → Wiredrum → Wire weight

Description Defines the weight of the measuring wire in g/10m. Indicated on Label.

User entry 0 to 999.9 g

Factory setting See label on the device.

Additional information

Read access	Operator
Write access	Maintenance

"Spot density" submenu

Navigation  Setup → Advanced setup → Sensor config → Spot density

Upper density offset 

Navigation  Setup → Advanced setup → Sensor config → Spot density → Upper density offset

Description Defines an offset value which is added to the measured upper density value.

User entry -999.99 to 999.99 kg/m³

Factory setting 0 kg/m³

Additional information

Read access	Operator
Write access	Maintenance

Middle density offset 

Navigation  Setup → Advanced setup → Sensor config → Spot density → Middle density offset

Description Defines an Offset Value which is added to the measured Middle Density Value.

User entry -999.99 to 999.99 kg/m³

Factory setting 0 kg/m³

Additional information

Read access	Operator
Write access	Maintenance

Lower density offset 

Navigation  Setup → Advanced setup → Sensor config → Spot density → Lower density offset

Description Defines an offset value which is added to the measured lower density value.

User entry -999.99 to 999.99 kg/m³

Factory setting 0 kg/m³

Additional information

Read access	Operator
Write access	Maintenance

Submersion depth

**Navigation**

Setup → Advanced setup → Sensor config → Spot density → Submersion depth

Description

Sets the displacer submersion depth (mm) for spot density operations.

User entry

50 to 99 999.9 mm

Factory setting

150 mm

Additional information

Read access	Operator
Write access	Maintenance

"Profile density" submenu

Navigation  Setup → Advanced setup → Sensor config → Profile density

Density measurement mode 

Navigation  Setup → Advanced setup → Sensor config → Profile density → Density measurement mode

Description In normal measure mode, measures at specified positions. In compensation mode measures using next integer value of drum turns to improve accuracy.

Selection

- Normal measure mode
- Compensation mode

Factory setting Normal measure mode

Additional information

Read access	Operator
Write access	Maintenance

Manual profile level 

Navigation  Setup → Advanced setup → Sensor config → Profile density → Manual profile level

Description Sets the level position in the tank where the manual profile density operation starts.

User entry -999 999.9 to 999 999.9 mm

Factory setting 1 000 mm

Additional information

Read access	Operator
Write access	Maintenance

Profile density offset distance 

Navigation  Setup → Advanced setup → Sensor config → Profile density → Profile density offset distance

Description Profile density offset distance [mm] is the distance between start point and first measurement point.

User entry 0 to 999 999.9 mm

Factory setting 500 mm

Additional information

Read access	Operator
Write access	Maintenance

Profile density interval



Navigation

Setup → Advanced setup → Sensor config → Profile density → Profile density interval

Description

Sets the interval between two measurement points in profile density operation.

User entry

1 to 100 000 mm

Factory setting

1 000 mm

Additional information

Read access	Operator
Write access	Maintenance

Profile density offset



Navigation

Setup → Advanced setup → Sensor config → Profile density → Profile density offset

Description

Defines an offset value which is added to the measured profile density value.

User entry

-999.99 to 999.99 kg/m³

Factory setting

0 kg/m³

Additional information

Read access	Operator
Write access	Maintenance

"Display" submenu

This menu is only visible if the device has a local display.

Navigation  Setup → Advanced setup → Display

Language

Navigation  Setup → Advanced setup → Display → Language

Prerequisite The device has a local display.

Description Set display language.

- Selection**
- English
 - Deutsch *
 - Français *
 - Español *
 - Italiano *
 - Nederlands *
 - Portuguesa *
 - Polski *
 - русский язык (Russian) *
 - Svenska *
 - Türkçe *
 - 中文 (Chinese) *
 - 日本語 (Japanese) *
 - 한국어 (Korean) *
 - العربية (Arabic) *
 - Bahasa Indonesia *
 - ภาษาไทย (Thai) *
 - tiếng Việt (Vietnamese) *
 - čeština (Czech) *

Factory setting English

Additional information

Read access	Operator
Write access	Operator

Format display

Navigation  Setup → Advanced setup → Display → Format display

Prerequisite The device has a local display.

Description Select how measured values are shown on the display.



* Visibility depends on order options or device settings

- Selection**
- 1 value, max. size
 - 1 bargraph + 1 value
 - 2 values
 - 1 value large + 2 values
 - 4 values

Factory setting 2 values



Additional information

Read access	Operator
Write access	Operator

- The **Value 1 to 4 display** (→  303) parameters specify which measured values are shown on the display and in which order.
- If more measured values are specified than the current display mode permits, the values alternate on the device display. The display time until the next change is configured in the **Display interval** parameter (→  306).

Value 1 to 4 display



Navigation   Setup → Advanced setup → Display → Value 1 display

Prerequisite The device has a local display.

Description Select the measured value that is shown on the local display.

- Selection**
- None ⁸⁾
 - Tank level
 - Measured level
 - Tank level %
 - Water level ⁸⁾
 - Liquid temperature ⁸⁾
 - Vapor temperature ⁸⁾
 - Air temperature ⁸⁾
 - Tank ullage
 - Tank ullage %
 - Observed density value ⁸⁾
 - P1 (bottom) ⁸⁾
 - P2 (middle) ⁸⁾
 - P3 (top) ⁸⁾
 - GP 1 value ⁸⁾
 - GP 2 value ⁸⁾
 - GP 3 value ⁸⁾
 - GP 4 value ⁸⁾
 - Gauge command ⁸⁾
 - Gauge status ⁸⁾
 - AIO B1-3 value ⁸⁾
 - AIO B1-3 value mA ⁸⁾
 - AIO B1-3 value % ⁸⁾
 - AIO C1-3 value ⁸⁾
 - AIO C1-3 value mA ⁸⁾
 - AIO C1-3 value % ⁸⁾

8) not available for the **Value 1 display** parameter

- AIP B4-8 value ⁸⁾
- AIP B4-8 value mA ⁸⁾
- AIP B4-8 value % ⁸⁾
- AIP C4-8 value ⁸⁾
- AIP C4-8 value mA ⁸⁾
- AIP C4-8 value % ⁸⁾

Factory setting

Depending on device version

Additional information

Read access	Operator
Write access	Maintenance

Decimal places 1 to 4



Navigation

Setup → Advanced setup → Display → Decimal places 1

Prerequisite

The device has a local display.

Description

This selection does not affect the measurement and calculation accuracy of the device.

Selection

- X
- X.X
- X.XX
- X.XXX
- X.XXXX

Factory setting

x.x

Additional information

Read access	Operator
Write access	Maintenance

Separator



Navigation

Setup → Advanced setup → Display → Separator

Prerequisite

The device has a local display.

Description

Select decimal separator for displaying numerical values.

Selection

- .
- ,

Factory setting

.

Additional information

Read access	Operator
Write access	Maintenance

Number format



Navigation Setup → Advanced setup → Display → Number format

Prerequisite The device has a local display.

Description Choose number format for the display.

- Selection**
- Decimal
 - ft-in-1/16"

Factory setting Decimal

Additional information

Read access	Operator
Write access	Maintenance

The **ft-in-1/16"** option is only valid for distance values.

Header



Navigation Setup → Advanced setup → Display → Header

Prerequisite The device has a local display.

Description Select header contents on local display.

- Selection**
- Device tag
 - Free text

Factory setting Device tag

Additional information

Read access	Operator
Write access	Maintenance

Meaning of the options

- **Device tag**
The header contents is defined in the **Device tag** parameter (→ 320).
- **Free text**
The header contents is defined in the **Header text** parameter (→ 305).

Header text



Navigation Setup → Advanced setup → Display → Header text

Prerequisite Header (→ 305) = Free text



Description Enter display header text.

Factory setting TG-Platform

Additional information

Read access	Operator
Write access	Maintenance

Display interval

Navigation   Setup → Advanced setup → Display → Display interval

Description Set time measured values are shown on display if display alternates between values.



User entry 1 to 10 s

Factory setting 5 s

Additional information

Read access	Operator
Write access	Operator

Display damping

Navigation   Setup → Advanced setup → Display → Display damping

Prerequisite The device has a local display.

Description Set display reaction time to fluctuations in the measured value.



User entry 0.0 to 999.9 s

Factory setting 0.0 s

Additional information

Read access	Operator
Write access	Maintenance

Backlight

Navigation   Setup → Advanced setup → Display → Backlight

Prerequisite The device has a local display.

Description Switch the local display backlight on and off.

Selection ▪ Disable
 ▪ Enable

Factory setting Enable

Additional information

Read access	Operator
Write access	Operator

Contrast display

Navigation  Setup → Advanced setup → Display → Contrast display

Prerequisite The device has a local display.

Description Adjust local display contrast setting to ambient conditions (e.g. lighting or reading angle).

User entry 20 to 80 %

Factory setting 30 %

Additional information

Read access	Operator
Write access	Operator

"System units" submenu

Navigation  Setup → Advanced setup → System units

Units preset 

Navigation  Setup → Advanced setup → System units → Units preset

Description Defines a set of units for length, pressure and temperature.





- Selection**
- mm, bar, °C
 - m, bar, °C
 - mm, PSI, °C
 - ft, PSI, °F
 - ft-in-16, PSI, °F
 - ft-in-8, PSI, °F
 - Customer value

Factory setting mm, bar, °C

Additional information

Read access	Operator
Write access	Maintenance

If the **Customer value** option is selected, the units are defined in the following parameters:

- Distance unit (→  308)
- Pressure unit (→  309)
- Temperature unit (→  309)
- Density unit (→  309)

In any other case these are read-only parameters used to indicate the respective unit.

Distance unit 

Navigation  Setup → Advanced setup → System units → Distance unit

Description Select distance unit.

- Selection**
- | | |
|--|--|
| <p><i>SI units</i></p> <ul style="list-style-type: none"> ■ m ■ mm ■ cm | <p><i>US units</i></p> <ul style="list-style-type: none"> ■ ft ■ in ■ ft-in-16 ■ ft-in-8 |
|--|--|

Factory setting mm

Additional information

Read access	Operator
Write access	Maintenance (if Units preset (→  185) = Customer value)

Pressure unit



Navigation Setup → Advanced setup → System units → Pressure unit

Description Select process pressure unit.

Selection

<i>SI units</i> ■ bar ■ Pa ■ kPa ■ MPa ■ mbar a	<i>US units</i> psi	<i>Other units</i> ■ inH2O ■ inH2O (68°F) ■ ftH2O (68°F) ■ mmH2O ■ mmHg
--	------------------------	--

Factory setting bar

Additional information

Read access	Operator
Write access	Maintenance (if Units preset (→ 185) = Customer value)

Temperature unit



Navigation Setup → Advanced setup → System units → Temperature unit

Description Select temperature unit.

Selection

<i>SI units</i> ■ °C ■ K	<i>US units</i> ■ °F ■ °R
--------------------------------	---------------------------------

Factory setting °C

Additional information

Read access	Operator
Write access	Maintenance (if Units preset (→ 185) = Customer value)

Density unit



Navigation Setup → Advanced setup → System units → Density unit

Description Select density unit.

Selection

<i>SI units</i> ■ g/cm ³ ■ g/ml ■ g/l ■ kg/l ■ kg/dm ³ ■ kg/m ³	<i>US units</i> ■ lb/ft ³ ■ lb/gal (us) ■ lb/in ³ ■ STon/yd ³	<i>Other units</i> ■ °API ■ SGU
--	--	---------------------------------------

Factory settingkg/m³**Additional information**

Read access	Operator
Write access	Maintenance (if Units preset (→  185) = Customer value)

"Date / time" submenu

Navigation  Setup → Advanced setup → Date / time

Date/time

Navigation  Setup → Advanced setup → Date / time → Date/time

Description Displays the device internal real time clock.

Additional information

Read access	Operator
Write access	-

Set date



Navigation  Setup → Advanced setup → Date / time → Set date

Description Controls the setting of the real-time clock.

Selection

- Please select
- Abort
- Start
- Confirm time

Factory setting Please select

Additional information

Read access	Operator
Write access	Maintenance

Meaning of the options

- **Please select**
Prompts the user to select an action.
- **Abort**
Discards the entered date and time.
- **Start**
Starts the setting of the real time clock.
- **Confirm time**
Sets the real-time clock to the entered date and time.

Year



Navigation  Setup → Advanced setup → Date / time → Year

Prerequisite Set date (→  311) = Start

Description Enter the current year.

User entry 2 016 to 2 079

Factory setting 2 016

Additional information

Read access	Operator
Write access	Maintenance

Month

Navigation  Setup → Advanced setup → Date / time → Month

Prerequisite **Set date (→  311) = Start**

Description Enter the current month.

User entry 1 to 12

Factory setting 1

Additional information

Read access	Operator
Write access	Maintenance

Day

Navigation  Setup → Advanced setup → Date / time → Day

Prerequisite **Set date (→  311) = Start**

Description Enter the current day.

User entry 1 to 31

Factory setting 1

Additional information

Read access	Operator
Write access	Maintenance

Hour

Navigation  Setup → Advanced setup → Date / time → Hour

Prerequisite **Set date (→  311) = Start**

Description Enter the current hour.

User entry 0 to 23

Factory setting 0

Additional information

Read access	Operator
Write access	Maintenance

Minute



Navigation Setup → Advanced setup → Date / time → Minute

Prerequisite Set date (→ 311) = Start

Description Enter the current minute.

User entry 0 to 59

Factory setting 0

Additional information

Read access	Operator
Write access	Maintenance

"SIL confirmation" wizard

-  The **SIL confirmation** wizard is only available for devices with SIL or WHG approval (Feature 590: "Additional Approval", option LA: "SIL" or LC: "WHG overflow prevention") which are currently **not** in the SIL- or WHG-locked state.
- The **SIL confirmation** wizard is required to lock the device according to SIL or WHG. For details refer to the "Functional Safety Manual" of the respective device, which describes the locking procedure and the parameters of this wizard.

Navigation  Setup → Advanced setup → SIL confirmation

"Deactivate SIL/WHG" wizard

-  The **Deactivate SIL/WHG** wizard is only available for devices with SIL or WHG approval (Feature 590: "Additional Approval", option LA: "SIL" or LC: "WHG overflow prevention") which are currently in the SIL- or WHG-locked state.
- The **Deactivate SIL/WHG** wizard is required to undo the locking of the device according to SIL or WHG. For details refer to the "Functional Safety Manual" of the respective device, which describes the locking procedure and the parameters of this wizard.

Navigation  Setup → Advanced setup → Deactivate SIL/WHG

"Administration" submenu

Navigation  Setup → Advanced setup → Administration

Define access code 

Navigation  Setup → Advanced setup → Administration → Define access code





Description Define release code for write access to parameters.

User entry 0 to 9999

Factory setting 0

Additional information

Read access	Operator
Write access	Maintenance

-  If the factory setting is not changed or 0 is defined as the access code, the parameters are not write-protected and the configuration data of the device can then always be modified. The user is logged on in the *Maintenance* role.
-  The write protection affects all parameters marked with the  symbol in this document.
-  Once the access code has been defined, write-protected parameters can only be modified if the access code is entered in the **Enter access code** parameter.

Device reset 

Navigation   Setup → Advanced setup → Administration → Device reset

Description Reset the device configuration - either entirely or in part - to a defined state.

Selection

- Cancel
- To fieldbus defaults **
- To factory defaults *
- Restart device

Factory setting Cancel

Additional information

Read access	Operator
Write access	Maintenance

** Visibility depends on communication
 * Visibility depends on order options or device settings

15.4 "Diagnostics" menu

Navigation  Diagnostics

Actual diagnostics

Navigation  Diagnostics → Actual diagnostics

Description Shows the current occurred diagnostic event along with its diagnostic information.

Additional information

Read access	Operator
Write access	-

The display consists of:

- Symbol for event behavior
- Code for diagnostic behavior
- Operating time of occurrence
- Event text

 If several messages are active at the same time, the messages with the highest priority is displayed.

 Information on what is causing the message, and remedy measures, can be viewed via the  symbol on the display.

Timestamp

Navigation  Diagnostics → Timestamp

Description Displays the timestamp for the currently active diagnostic message.

Additional information

Read access	Operator
Write access	-

Previous diagnostics

Navigation  Diagnostics → Previous diagnostics

Description Shows the diagnostic event that occurred prior to the current diagnostic event along with its diagnostic information.

Additional information

Read access	Operator
Write access	-

The display consists of:

- Symbol for event behavior
- Code for diagnostic behavior
- Operating time of occurrence
- Event text

 If several messages are active at the same time, the messages with the highest priority is displayed.

 Information on what is causing the message, and remedy measures, can be viewed via the ⓘ symbol on the display.

Timestamp

Navigation  Diagnostics → Timestamp

Description Shows the timestamp of the previous diagnostic message.

Additional information

Read access	Operator
Write access	-

Operating time from restart

Navigation  Diagnostics → Operating time from restart

Description Shows the time the device has been in operation since the last device restart.

Additional information

Read access	Operator
Write access	-

Operating time

Navigation  Diagnostics → Operating time

Description Indicates how long the device has been in operation.

Additional information

Read access	Operator
Write access	-

Date/time

Navigation Diagnostics → Date/time**Description**

Displays the device internal real time clock.



Additional information

Read access	Operator
Write access	-

15.4.1 "Diagnostic list" submenu

Navigation   Diagnostics → Diagnostic list

Diagnostics 1 to 5

Navigation	  Diagnostics → Diagnostic list → Diagnostics 1 to 5
Description	Display the current diagnostics messages with the highest to fifth-highest priority.
Additional information	The display consists of: <ul style="list-style-type: none">■ Symbol for event behavior■ Code for diagnostic behavior■ Operating time of occurrence■ Event text

Timestamp 1 to 5

Navigation	 Diagnostics → Diagnostic list → Timestamp
Description	Timestamp of the diagnostic message.

15.4.2 "Device information" submenu

Navigation  Diagnostics → Device information

Device tag

Navigation  Diagnostics → Device information → Device tag

Description Shows the device tag.

Factory setting NMS8x

Additional information

Read access	Operator
Write access	-

Serial number

Navigation  Diagnostics → Device information → Serial number

Description Shows the serial number of the measuring device.

Additional information

Read access	Operator
Write access	-

Firmware version

Navigation  Diagnostics → Device information → Firmware version

Description Shows the device firmware version installed.

Additional information

Read access	Operator
Write access	-

Firmware CRC

Navigation  Diagnostics → Device information → Firmware CRC

Description Result of the cyclic redundancy check of the firmware.

Additional information

Read access	Operator
Write access	-

Weight and measures configuration CRC

Navigation

 Diagnostics → Device information → Weight and measures configuration CRC

Description

Result of the cyclic redundancy check of the weights and measure relevant parameters.

Additional information

Read access	Operator
Write access	-

Device name

Navigation

 Diagnostics → Device information → Device name

Description

Shows the name of the transmitter.

Additional information

Read access	Operator
Write access	-

Order code



Navigation

 Diagnostics → Device information → Order code

Description

Shows the device order code.

Additional information

Read access	Operator
Write access	Service

Extended order code 1 to 3



Navigation

 Diagnostics → Device information → Extended order code 1

Description

Display the three parts of the extended order code.

Additional information

Read access	Operator
Write access	Service



The extended order code indicates the selected option of all ordering features and thus uniquely identifies the device.

15.4.3 "Simulation" submenu

Read access	Maintenance
-------------	-------------

Navigation  Diagnostics → Simulation

Device alarm simulation

Navigation   Diagnostics → Simulation → Device alarm simulation

Description Switch the device alarm on and off.

Selection



- Off
- On

Factory setting Off

Additional information

Read access	Operator
Write access	Maintenance

Diagnostic event simulation

Navigation   Diagnostics → Simulation → Diagnostic event simulation

Description Select a diagnostic event to simulate this event.

Selection The diagnostic events of the device

Factory setting Off

Additional information

Read access	Operator
Write access	Maintenance

 To terminate the simulation, select **Off**.

Simulation distance on

Navigation   Diagnostics → Simulation → Simulation distance on

Description Switches the distance simulation on or off.

Selection

- Off
- On

Factory setting Off

Additional information

Read access	Operator
Write access	Maintenance

Simulation distance



Navigation Diagnostics → Simulation → Simulation distance

Prerequisite **Simulation distance on (→ 323) = On**

Description Defines the distance value to be simulated.

User entry Signed floating-point number

Factory setting 0 mm

Additional information

Read access	Operator
Write access	Maintenance

Current output simulation



Navigation Diagnostics → Simulation → Current output 1 simulation

Diagnostics → Simulation → Current output 2 simulation

Prerequisite

- The device has an Anlog I/O module.
- **Operating mode (→ 213) = 4..20mA output or HART slave +4..20mA output**

Description Switches the simulation of the current on or off.

Selection

- Off
- On

Factory setting Off

Additional information

Read access	Operator
Write access	Maintenance

Simulation value



Navigation Diagnostics → Simulation → Simulation value

Diagnostics → Simulation → Simulation value

Prerequisite **Current output simulation (→ 324) = On**

Description Defines the current to be simulated.

User entry 3.4 to 23 mA

Factory setting The current at the time the simulation was started.

Additional information

Read access	Operator
Write access	Maintenance

15.4.4 "Device check" submenu

Navigation  Diagnostics → Device check

Result drum check

Navigation  Diagnostics → Device check → Result drum check

Description Gives feedback on the latest status of the commissioning check.

Additional information

Read access	Operator
Write access	-

"Commissioning check" wizard

Navigation  Diagnostics → Device check → Commissioning check

Commissioning check 

Navigation  Diagnostics → Device check → Commissioning check → Commissioning check

Description This sequence supports checking of the hardware on sensor side and correct installation of the sensor.

Additional information

Read access	Operator
Write access	Maintenance

Result drum check

Navigation  Diagnostics → Device check → Commissioning check → Result drum check

Description Gives feedback on the latest status of the commissioning check.

Additional information

Read access	Operator
Write access	-

Step X / 11

Navigation  Diagnostics → Device check → Commissioning check → Step X / 11

Description Indicates which step of the commissioning check is currently running.

Additional information

Read access	Operator
Write access	-

Index

Symbols

#blank# (Parameter) 202, 203

0 ... 9

0 % value (Parameter) 209, 217, 243

100 % value (Parameter) 209, 218, 243

A

Access status tooling (Parameter) 199

Accessories

 Communication specific 157

 Service specific 157

Actual diagnostics (Parameter) 316

Administration (Submenu) 315

Advanced setup (Submenu) 199

Air density (Parameter) 178, 259

Air temperature (Parameter) 175, 257

Air temperature source (Parameter) 256

Alarm (Submenu) 282

Alarm 1 input source (Parameter) 239

Alarm 2 input source (Parameter) 239

Alarm hysteresis (Parameter) 289

Alarm mode (Parameter) 282

Alarm value (Parameter) 285

Alarm value source (Parameter) 284

Ambient pressure (Parameter) 265

Analog I/O (Submenu) 213

Analog input 0% value (Parameter) 219

Analog input 100% value (Parameter) 219

Analog input source (Parameter) 215

Analog IP (Submenu) 207

Any error (Parameter) 288

Application 10

 Residual risk 10

Application (Submenu) 251

Assign PV (Parameter) 242

Assign QV (Parameter) 247

Assign SV (Parameter) 244

Assign TV (Parameter) 246

B

Backlight (Parameter) 306

Balance flag (Parameter) 171

Baudrate (Parameter) 233

Bottom level (Parameter) 174

Bottom level timestamp (Parameter) 174

Bus termination (Parameter) 234

C

Calibration (Submenu) 191

Calibration status (Parameter) 194, 196, 198

Calibration temperature (Parameter) 274

CE mark 11

Cleaning

 Exterior cleaning 151

Clear alarm (Parameter) 288

Commissioning check (Parameter) 327

Commissioning check (Wizard) 327

Communication (Submenu) 232

Communication interface protocol (Parameter) 232

Communication interface protocol variant

(Parameter) 236

Communication status (Parameter) 202

Compatibility mode (Parameter) 238

Configuration (Submenu) 233, 236, 241

Contact type (Parameter) 225

Contrast display (Parameter) 307

Covered tank (Parameter) 273

CTSh (Submenu) 273

CTSh correction value (Parameter) 273

CTSh mode (Parameter) 273

Current output 1 simulation (Parameter) 324

Current output 2 simulation (Parameter) 324

Current span (Parameter) 214

D

Damping factor (Parameter) 211, 221, 289

Date / time (Submenu) 311

Date/time (Parameter) 311, 318

Day (Parameter) 312

DD 83

Deactivate SIL/WHG (Wizard) 314

Decimal places 1 (Parameter) 304

Declaration of Conformity 11

Define access code (Parameter) 315

Deformation factor (Parameter) 269

Density (Submenu) 177, 259

Density measurement mode (Parameter) 300

Density unit (Parameter) 309

Density value (Parameter) 279

Designated use 10

Device alarm simulation (Parameter) 323

Device check (Submenu) 326

Device Descriptions 83

Device ID (Parameter) 234

Device information (Submenu) 320

Device name (Parameter) 201, 321

Device replacement 152

Device reset (Parameter) 315

Device tag (Parameter) 185, 201, 249, 320

Diagnostic event simulation (Parameter) 323

Diagnostic events 138

Diagnostic information

 FieldCare 141

 Diagnostic list 149

 Diagnostic list (Submenu) 319

 Diagnostic message 138

 Diagnostics

 Symbols 138

 Diagnostics (Menu) 316

 Diagnostics 1 to 5 (Parameter) 319

 Diagnostics event 139

 Digital input mapping (Submenu) 228

Digital input source (Parameter) 224
 Digital input source 1 (Parameter) 228
 Digital input source 2 (Parameter) 228
 Digital Xx-x (Submenu) 223
 DIP switch
 see Write protection switch
 Displacer (Submenu) 294
 Displacer balance volume (Parameter) 295
 Displacer diameter (Parameter) 294
 Displacer height (Parameter) 295
 Displacer position (Parameter) 175
 Displacer type (Parameter) 294
 Displacer volume (Parameter) 295
 Displacer weight (Parameter) 294
 Display (Submenu) 302
 Display damping (Parameter) 306
 Display interval (Parameter) 306
 Disposal 153
 Distance (Parameter) 170, 175, 190, 191
 Distance unit (Parameter) 308
 Document
 Function 4
 Document function 4
 Drum calibration (Parameter) 197
 Drum calibration (Wizard) 197
 Drum circumference (Parameter) 297
 Drum table point (Parameter) 197

E

Element position (Submenu) 177
 Element position 1 to 24 (Parameter) 177
 Element temperature (Submenu) 176
 Element temperature 1 to 24 (Parameter) 176
 Empty (Parameter) 187, 251
 Endress+Hauser services
 Maintenance 151
 Repair 153
 Enter access code (Parameter) 199
 Error event type (Parameter) 220
 Error value (Parameter) 217, 283
 Event level
 Explanation 138
 Symbols 138
 Event text 139
 Expected SIL/WHG chain (Parameter) 222
 Extended order code 1 (Parameter) 321
 Exterior cleaning 151

F

Failure mode (Parameter) 216
 Firmware CRC (Parameter) 320
 Firmware version (Parameter) 320
 Fixed current (Parameter) 215
 Float swap mode (Parameter) 234
 Forget device (Parameter) 206
 Forget device (Wizard) 206
 Format display (Parameter) 302

G

Gauge command (Parameter) 169, 187
 Gauge command 0 (Parameter) 229
 Gauge command 1 (Parameter) 229
 Gauge command 2 (Parameter) 230
 Gauge command 3 (Parameter) 231
 Gauge current (Parameter) 212
 Gauge status (Parameter) 171
 GP 1 name (Parameter) 183
 GP Value 1 (Parameter) 183
 GP Value 2 (Parameter) 183
 GP Value 3 (Parameter) 183
 GP Value 4 (Parameter) 184
 GP values (Submenu) 183

H

H alarm (Parameter) 287
 H alarm value (Parameter) 285
 Hardware write protection 77
 HART date code (Parameter) 250
 HART descriptor (Parameter) 249
 HART Device(s) (Submenu) 201
 HART devices (Submenu) 200
 HART message (Parameter) 250
 HART output (Submenu) 241
 HART short tag (Parameter) 249
 Header (Parameter) 305
 Header text (Parameter) 305
 HH alarm (Parameter) 286
 HH alarm value (Parameter) 285
 HH+H alarm (Parameter) 287
 High stop level (Parameter) 189, 290
 Hour (Parameter) 312
 HTMS (Submenu) 278
 HTMS mode (Parameter) 278
 Hysteresis (Parameter) 280
 HyTD (Submenu) 268
 HyTD correction value (Parameter) 268
 HyTD mode (Parameter) 268

I

Immersion depth (Parameter) 296
 Information (Submenu) 249
 Input value (Parameter) 210, 217, 225
 Input value % (Parameter) 218
 Input value in mA (Parameter) 220
 Input value percent (Parameter) 221
 Input/output (Submenu) 200

L

L alarm (Parameter) 287
 L alarm value (Parameter) 286
 Language (Parameter) 302
 Level (Submenu) 172, 251
 Level mapping (Parameter) 237
 Level source (Parameter) 189, 251
 Line impedance (Parameter) 238
 Linear expansion coefficient (Parameter) 274
 Liquid temp source (Parameter) 190, 255

Liquid temperature (Parameter) 175, 256
 LL alarm (Parameter) 287
 LL alarm value (Parameter) 286
 LL+L alarm (Parameter) 288
 Local display
 see Diagnostics message
 see In alarm condition
 Locking status (Parameter) 199
 Low stop level (Parameter) 190, 291
 Lower density (Parameter) 186
 Lower density offset (Parameter) 298
 Lower density timestamp (Parameter) 179
 Lower interface level (Parameter) 173
 Lower interface level timestamp (Parameter) 173

M

Maintenance 151
 Make drum table (Parameter) 197
 Make low table (Parameter) 198
 Manual air temperature (Parameter) 256
 Manual density (Parameter) 278
 Manual liquid temperature (Parameter) 255
 Manual profile level (Parameter) 300
 Manual vapor temperature (Parameter) 257
 Manual water level (Parameter) 253
 Maximum probe temperature (Parameter) 210
 Measured level (Parameter) 174
 Measured lower density (Parameter) 179
 Measured materials 10
 Measured middle density (Parameter) 178
 Measured upper density (Parameter) 178
 Menu
 Diagnostics 316
 Operation 169
 Setup 185
 Middle density (Parameter) 186
 Middle density offset (Parameter) 298
 Middle Density Timestamp (Parameter) 179
 Minimum level (Parameter) 279
 Minimum pressure (Parameter) 279
 Minimum probe temperature (Parameter) 210
 Minute (Parameter) 313
 Month (Parameter) 312
 Motor status (Parameter) 192
 Move displacer (Parameter) 191, 192
 Move displacer (Wizard) 191
 Move distance (Parameter) 191

N

Net weight (Parameter) 170
 NMT element values (Submenu) 176
 No. of preambles (Parameter) 241
 Number format (Parameter) 305
 Number of devices (Parameter) 200

O

Observed density (Parameter) 177, 259
 Observed density source (Parameter) 259
 Offset calibration (Parameter) 194

Offset weight (Parameter) 193
 One-time command status (Parameter) 171
 Operating elements
 Diagnostics message 139
 Operating mode (Parameter) 202, 207, 213, 223
 Operating time (Parameter) 317
 Operating time from restart (Parameter) 317
 Operation (Menu) 169
 Operational safety 11
 Order code (Parameter) 321
 Output density (Parameter) 204
 Output level (Parameter) 205
 Output out of range (Parameter) 290
 Output pressure (Parameter) 203
 Output simulation (Parameter) 225
 Output temperature (Parameter) 204
 Output value (Parameter) 218, 226
 Output values (Parameter) 226
 Output vapor temperature (Parameter) 205
 Overtension weight (Parameter) 291

P

P1 (bottom) (Parameter) 181, 261
 P1 (bottom) manual pressure (Parameter) 261
 P1 (bottom) source (Parameter) 261
 P1 absolute / gauge (Parameter) 262
 P1 offset (Parameter) 262
 P1 position (Parameter) 262
 P3 (top) (Parameter) 182, 263
 P3 (top) manual pressure (Parameter) 263
 P3 (top) source (Parameter) 263
 P3 absolute / gauge (Parameter) 264
 P3 offset (Parameter) 264
 P3 position (Parameter) 264
 Parity (Parameter) 233
 Percent of range (Parameter) 244
 Polling address (Parameter) 201
 Post gauge command (Parameter) 293
 Pressure (Submenu) 181, 261
 Pressure unit (Parameter) 309
 Previous diagnostics (Parameter) 316
 Primary variable (PV) (Parameter) 244
 Probe position (Parameter) 211
 Process condition (Parameter) 187
 Process value (Parameter) 208, 220
 Process variable (Parameter) 209, 219
 Product safety 11
 Profile average density (Parameter) 180
 Profile density (Submenu) 181, 300
 Profile density 0 to 49 (Parameter) 181
 Profile density interval (Parameter) 301
 Profile density offset (Parameter) 301
 Profile density offset distance (Parameter) 300
 Profile density position 0 to 49 (Parameter) 181
 Profile density timestamp (Parameter) 180
 Profile point (Parameter) 179
 Progress (Parameter) 195
 PV mA selector (Parameter) 243
 PV source (Parameter) 241

Q

Quaternary variable (QV) (Parameter) 248

R

Readback value (Parameter) 226
 Recalibration 151
 Reference calibration (Parameter) 195
 Reference calibration (Wizard) 195
 Reference position (Parameter) 195
 Remedial measures
 Calling up 140
 Closing 140
 Repair concept 152
 Replacing a device 152
 Requirements for personnel 10
 Result drum check (Parameter) 326, 327
 Return 153
 RTD connection type (Parameter) 208
 RTD type (Parameter) 207

S

Safety distance (Parameter) 280
 Safety instructions
 Basic 10
 Safety settings (Submenu) 290
 Secondary variable (SV) (Parameter) 245
 Sensor calibration (Parameter) 193
 Sensor calibration (Wizard) 193
 Sensor config (Submenu) 293
 Separator (Parameter) 304
 Serial number (Parameter) 320
 Set date (Parameter) 311
 Set high weight (Parameter) 197
 Set level (Parameter) 188, 252
 Set low weight (Parameter) 198
 Setup (Menu) 185
 SIL confirmation (Wizard) 314
 Simulation (Submenu) 323
 Simulation distance (Parameter) 324
 Simulation distance on (Parameter) 323
 Simulation value (Parameter) 324
 Slow hoist zone (Parameter) 291
 Span calibration (Parameter) 194
 Span weight (Parameter) 193
 Spot density (Submenu) 298
 Standby level (Parameter) 171
 Starting level (Parameter) 268
 Status signals 138, 141
 Step X / 11 (Parameter) 327
 Stilling well (Parameter) 274
 Submenu
 Administration 315
 Advanced setup 199
 Alarm 282
 Analog I/O 213
 Analog IP 207
 Application 251
 Calibration 191
 Communication 232

Configuration 233, 236, 241
 CTS# 273
 Date / time 311
 Density 177, 259
 Device check 326
 Device information 320
 Diagnostic list 319
 Digital input mapping 228
 Digital Xx-x 223
 Displacer 294
 Display 302
 Element position 177
 Element temperature 176
 GP values 183
 HART Device(s) 201
 HART devices 200
 HART output 241
 HTMS 278
 HyTD 268
 Information 249
 Input/output 200
 Level 172, 251
 NMT element values 176
 Pressure 181, 261
 Profile density 181, 300
 Safety settings 290
 Sensor config 293
 Simulation 323
 Spot density 298
 System units 308
 Tank calculation 266
 Tank configuration 251
 Temperature 175, 255
 V1 input selector 239
 Wiredrum 297
 Submersion depth (Parameter) 299
 System components 157
 System polling address (Parameter) 241
 System units (Submenu) 308

T

Tank calculation (Submenu) 266
 Tank configuration (Submenu) 251
 Tank level (Parameter) 172, 188, 252
 Tank Level % (Parameter) 172
 Tank reference height (Parameter) 188, 252
 Tank ullage (Parameter) 172
 Tank ullage % (Parameter) 172
 Temperature (Submenu) 175, 255
 Temperature unit (Parameter) 309
 Tertiary variable (TV) (Parameter) 246
 Timestamp (Parameter) 316, 317, 319
 Trouble shooting 137

U

Undertension weight (Parameter) 292
 Units preset (Parameter) 185, 308
 Upper density (Parameter) 186
 Upper density offset (Parameter) 298

Upper density timestamp (Parameter)	178
Upper interface level (Parameter)	173
Upper interface level timestamp (Parameter)	173
Used for SIL/WHG (Parameter)	221, 227

V

V1 address (Parameter)	236, 237
V1 input selector (Submenu)	239
Value 1 display (Parameter)	303
Value percent selector (Parameter)	240
Vapor density (Parameter)	177, 260
Vapor temp source (Parameter)	257
Vapor temperature (Parameter)	176, 258

W

Water density (Parameter)	280
Water level (Parameter)	174, 253
Water level source (Parameter)	253
Weight and measures configuration CRC (Parameter)	321
Wire expansion coefficient (Parameter)	275
Wire weight (Parameter)	297
Wiredrum (Submenu)	297
Wizard	
Commissioning check	327
Deactivate SIL/WHG	314
Drum calibration	197
Forget device	206
Move displacer	191
Reference calibration	195
Sensor calibration	193
SIL confirmation	314
Workplace safety	11
Write protection	
Via write protection switch	77
Write protection switch	77

Y

Year (Parameter)	311
----------------------------	-----

Z

Zero calibration (Parameter)	194
--	-----



71411068

www.addresses.endress.com
