



MonoExact DF150E/DF310E and AquaXact 1688 Gas Analyzers

Operator Manual



IMPORTANT INFORMATION

Continued safe and reliable operation of this equipment is conditional on all installation, operation and maintenance procedures being carried out in accordance with the appropriate manuals, by personnel having appropriate qualifications, experience and training. Failure to observe the requirements of the manual may result in the user being held responsible for the consequences and may invalidate any warranty. Servomex accepts no liability for unauthorised modifications to Servomex supplied equipment.

Servomex has paid particular attention to Health and Safety throughout this manual. Where special precautions need to be taken due to the nature of the equipment or product, an appropriate safety icon and warning message is shown. Special attention should be made to section 3 – Safety, where all such messages are summarized.

This document, and all specifications and drawings within the document, are the property of Servomex, unless agreed otherwise by contract. They must not be reproduced, copied or transmitted in any form, or by any means, or used as the basis for the manufacture or sale of apparatus, programs or services without permission.

In line with our continuous policy of research and development, we reserve the right to amend models and specifications without prior notice, therefore the information in this document is subject to change without notice and does not represent a commitment on the part of Servomex Group Limited. This handbook is accurate at the date of printing, but will be superseded and should be disregarded if specifications or appearance are changed. Check the internet for updates to the manual. The latest revision of this manual is available in Adobe Acrobat format at www.servomex.com.

The customer agrees that in accepting and using this instrument Servomex's liability arising from or in any way connected with this instrument shall be limited exclusively to performing a new calibration or replacement or repair of the instrument or sensor, at Servomex's sole option, as covered by Servomex's warranty. In no event shall Servomex be liable for any incidental, consequential or special damages of any kind or nature whatsoever, including but not limited to lost profits arising from or in any way connected with this instrument or items hereunder, whether alleged to arise from breach of contract, express or implied warranty, or in tort, including without limitation, negligence, failure to warn or strict liability.

Servomex is a registered trademark of Servomex Group Inc. The use of all trademarks in this document is acknowledged.

North America:

Servomex Group Inc.
4 Constitution Way
Woburn MA 01801-1087
United States

t: +1 781 935 4600
+1 800 433 2552 (US toll free)
f: + 1 781 938 0531
e: americas_sales@servomex.com
w: www.servomex.com

Europe:

Servomex Group Ltd
Jarvis Brook
Crowborough
East Sussex TN6 3FB
United Kingdom

t: + 44 (0) 1892 652 181
f: + 44 (0) 1892 662 253
e: europa_sales@servomex.com
w: www.servomex.com

Representative:

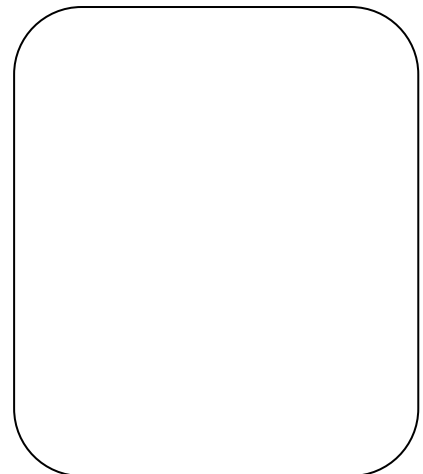

© 2017. Servomex Group Limited. A Spectris Company. All rights reserved

Contents

1	Introduction	6
1.1	About this manual	6
1.2	Product overview	7
1.3	Product identification	8
1.4	Ordering options	11
2	Unpacking	12
3	Safety	14
3.1	General warnings	14
3.2	Chemical warnings	15
3.3	Electrical warnings	15
3.4	Markings	17
4	User interface	18
4.1	Introduction	18
4.2	General techniques	18
4.3	Menu structure	21
4.4	Home screen	23
4.5	Menu screen	24
4.6	Measurement screen	25
4.7	Diagnostics screen	28
4.8	Maintenance screen	30
4.9	Settings screen	31
4.10	Touchscreen icon glossary	33
5	Installation and set-up	36
5.1	Transducer specific installation	36
5.2	Mechanical Installation	38
5.3	Electrical installation	41
5.4	Sample / calibration gas pipeline connection	48
5.5	Switch on and set-up	50
5.6	Configure the relays	52
5.7	Configure and use the mA outputs	54
5.8	Using the voltage outputs	54
5.9	Correct O ₂ measurements for differing background gases	55
5.10	Configure measurement alarms	58
5.11	Configure the measurement record option	65
5.12	Setting display / 4-20 mA range	66
6	Sample gas preparation and delivery	67

7	Calibration	68
7.1	Manual calibration	68
7.2	Span reference value	70
8	Operation	72
8.1	Check the relay signal outputs	72
8.2	View flow levels	72
8.3	Switch off the analyser	72
9	Technical specification	73
9.1	Mechanical specification	73
9.2	Electrical specification	73
9.3	Maximum voltage ratings	74
9.4	Environmental limits	75
9.5	Sample gas	75
9.6	Calibration gas	76
9.7	Approvals / classifications	76
10	Routine maintenance	77
10.1	Cleaning the analyzer	77
10.2	Routine checks	77
10.3	Preventative maintenance	80
11	Troubleshooting	81
11.1	Coulometric sample system leak test (Low flow sensitivity)	81
11.2	Error codes	82
12	Storage and disposal	83
12.1	Storage	83
12.2	Disposal	83
13	Spares	84
14	Warranty	86
14.1	Maintenance policy	87
Appendix A	Options for RS485 / RS232	88
A.1	Introduction	88
A.2	Connections	88
A.3	Set up parameters	89
A.4	Connecting the analyzer to a PC	90
Appendix B	Sample wetted materials	91
Appendix C	Coulometric O₂ transducers	92
C.1	Theory of operation	92
C.2	Sample gas preparation and delivery	93
C.3	Coulometric sensor maintenance	103

Appendix D Paramagnetic O₂ transducers	105
D.1 Paramagnetic Oxygen analysis: theory of operation.....	105
D.2 Considerations for sample preparation.....	106
D.3 Overview of measurement errors for paramagnetic O ₂ transducer	107
D.4 Cross interference offsets (for paramagnetic transducer).....	108
Appendix E Compliance and standards.....	114
Appendix F Performance data.....	116
F.1 Coulometric O ₂ trace measurement	116
F.2 Paramagnetic O ₂ % measurement	117
F.3 Flow alarm	117
Appendix G Recommended calibration periods.....	118
Appendix H Implementation guide for Modbus communications.....	119
H.1 Introduction	119
H.2 References	119
H.3 Modbus setup	119
H.4 Supported function codes	119
H.5 Exception codes.....	120
H.6 Addressing.....	120
H.7 Floating point numbers.....	121
H.8 System data.....	121
H.9 System Settings.....	122
H.10 System Control	124
H.11 Measurements	124
H.12 Transducer calibration data.....	124
H.13 Transducer live info.....	125
H.14 Transducer settings.....	127
H.15 Transducer control	128
Appendix I Material Safety Data Sheet.....	129
Appendix J Return Authorization Request.....	137
Appendix K AquaXact 1688 digital controller	139
K.1 Dual display	139
K.2 Moisture units.....	140
K.3 Process and sample system pressures	141
K.4 Setting range limits	142
K.5 AquaXact calibration	143
K.6 Replace the sensor tip	144
K.7 Touchscreen icon glossary.....	145
Index	146

1 Introduction

1.1 About this manual

1.1.1 Scope of the manual

This manual covers the installation, operation and routine maintenance of the MonoExact DF150E/DF310E and AquaXact 1688 Controller. It is intended for those already familiar with the installation, use and maintenance of analytical or process instrumentation.

The information in this manual is general. Transducer-specific instructions are contained in the relevant appendices at the rear of the manual.

A separate manual covers the AquaXact 1688 transmitter in more detail, including theory and performance data.

1.1.2 Safety information

Read this manual and make sure you fully understand its contents before you attempt to install, use or maintain the analyzer.

The following icons are used throughout this manual to identify any potential hazards that could cause serious injury to people. Always follow the safety instructions and be aware of the hazard.



This symbol warns of specific hazards which, if not taken into account, may result in personal injury or death.



This symbol warns of specific hazards due to high voltages which, if not taken into account, may result in personal injury or death.



This symbol warns of specific hazards due to high temperatures which, if not taken into account, may result in personal injury or death.



This symbol warns of specific hazards due to hazardous substances which, if not taken into account, may result in personal injury or death.



This symbol warns of specific hazards due to caustic or corrosive substances which, if not taken into account, may result in personal injury or death.



This symbol highlights where you must take special care to ensure the analyzer or to other equipment or property is not damaged.

1.1.3 Other information provided by the manual

Note: Notes give extra information about the equipment.

Hint: Hints give helpful tips and highlights information which is useful for you to be aware of, for example, specific operating conditions.

1.2 Product overview

The MonoExact DF150E, DF310E and AquaXact 1688 Gas Analyzers are designed to meet the needs of the control and product quality applications of industrial gas producers and users, who require fast, accurate and reliable gas analysis.

The analyzer can support a gas measurement, using coulometric or paramagnetic transducers while also allowing a moisture measurement to be brought in from a custom external probe.

Gas sample measurements are shown on the analyzer display, and can also be output to a serial device connected to the analyzer, or as milliamp (mA) / voltage outputs, or over a selection of digital communications protocols.

Note: The MonoExact DF310E and AquaXact Controller can have RS232 or RS485 communications, but only one can be active at a time. This is specified in the Serial Menu. These options must be specified when the instrument is purchased.

The analyzer conforms to the requirements of the NAMUR (Normenarbeitsgemeinschaft für Mess Und Regeltechnik in der Chemischen Industrie) standards NE43 (4 – 20 mA output) and NA64 (status outputs).

The analyzer is simple to operate, with an intuitive user interface. The analyzer is 193 mm (7.6”) high and is suitable for 19 inch rack, panel or bench mounting.

The analyzer requires little routine maintenance, other than calibration which is essential for the accuracy of sample gas measurements (section 7) and replacement of filter elements (if fitted external to the analyzer).

1.3 Product identification



Figure 1-1: The MonoExact DF310E Gas Analyzer

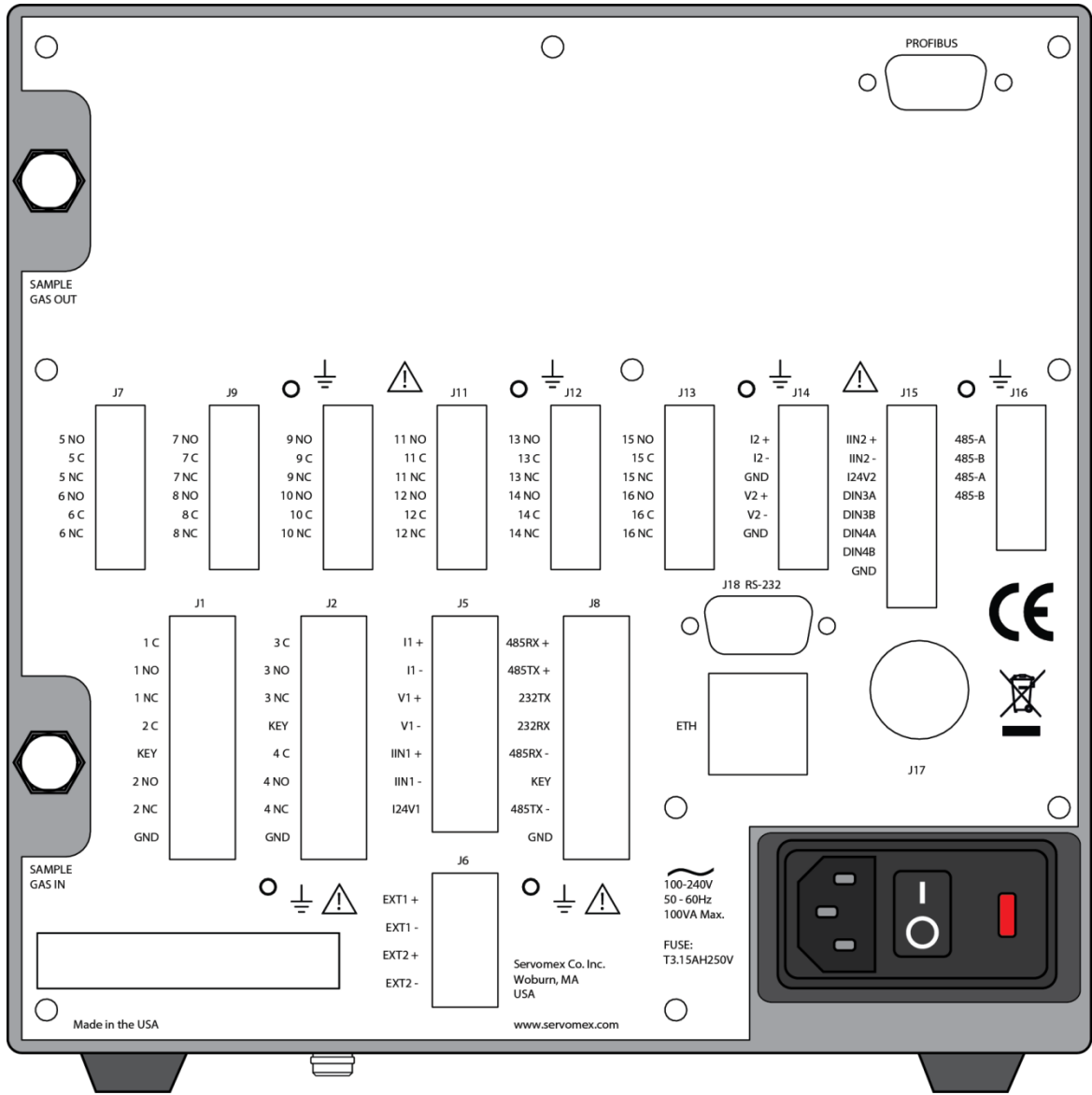



Figure 1-2: Rear of the MonoExact DF310E and AquaXact 1688 Gas Analyzer

ID	Description
J1 – J2	Relay I/O connections
J5	4 – 20 mA output / analog inputs <i>Note: A legacy 4-lead cable can be connected to the top 4 connections labeled I1+, I1-, V1+ and V1-.</i>
J6	General purpose digital inputs that can be used in future software releases for functions such as closing a relay for pump control or turning a coulometric sensor on or off.
J7	Relay I/O
J8	RS485 / RS232 comms port <i>(optional)</i>
J9 – J13	Relay I/O connections
J14	Analog output

ID	Description
J15	Analog and digital inputs
J16	RS485 (Modbus) <i>(optional)</i>
J17	Moisture probe input
J18	RS232 <i>(optional)</i>
ETH	Ethernet
	Earth (ground) connection

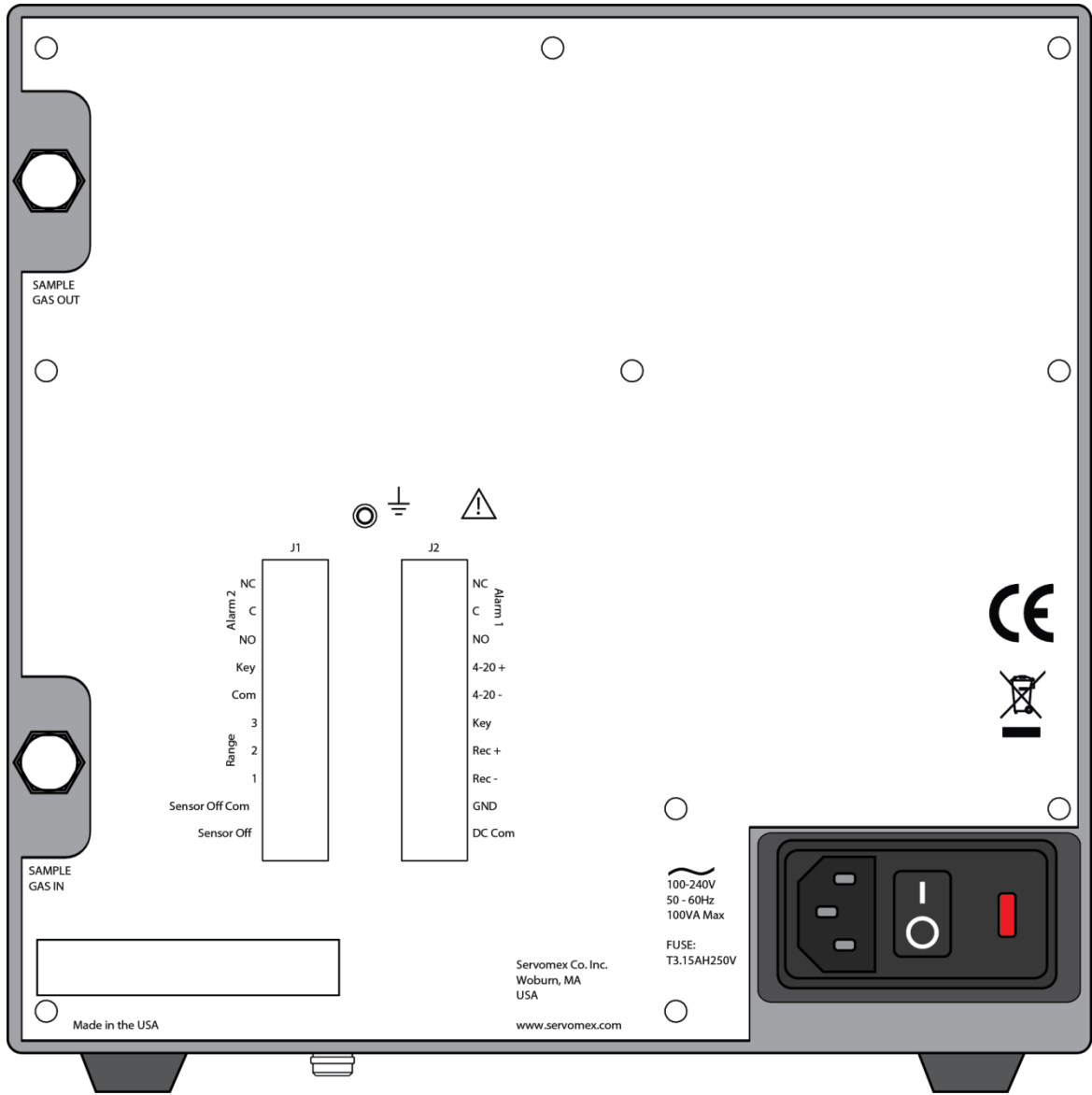



Figure 1-3: Rear of the MonoExact DF150E Gas Analyzer

ID	Description
J1 – J2	Relay I/O connections
	Earth (ground) connection

1.4 Ordering options

For the latest ordering options please contact your local Servomex agent or visit www.servomex.com.

2 Unpacking



Read this manual carefully **BEFORE** you remove the MonoExact Gas Analyzer from its shipping container, or you attempt to install, commission or use the equipment.



The analyzer is heavy (section 9.1). Take care when handling the instrument. Lift it with hands positioned on either side on the base of the chassis.

1. Remove the analyzer and any other equipment from its packaging.
2. Remove the protective plastic covers from the sample gas inlets and outlets on the rear of the analyzer (Figure 2-1).

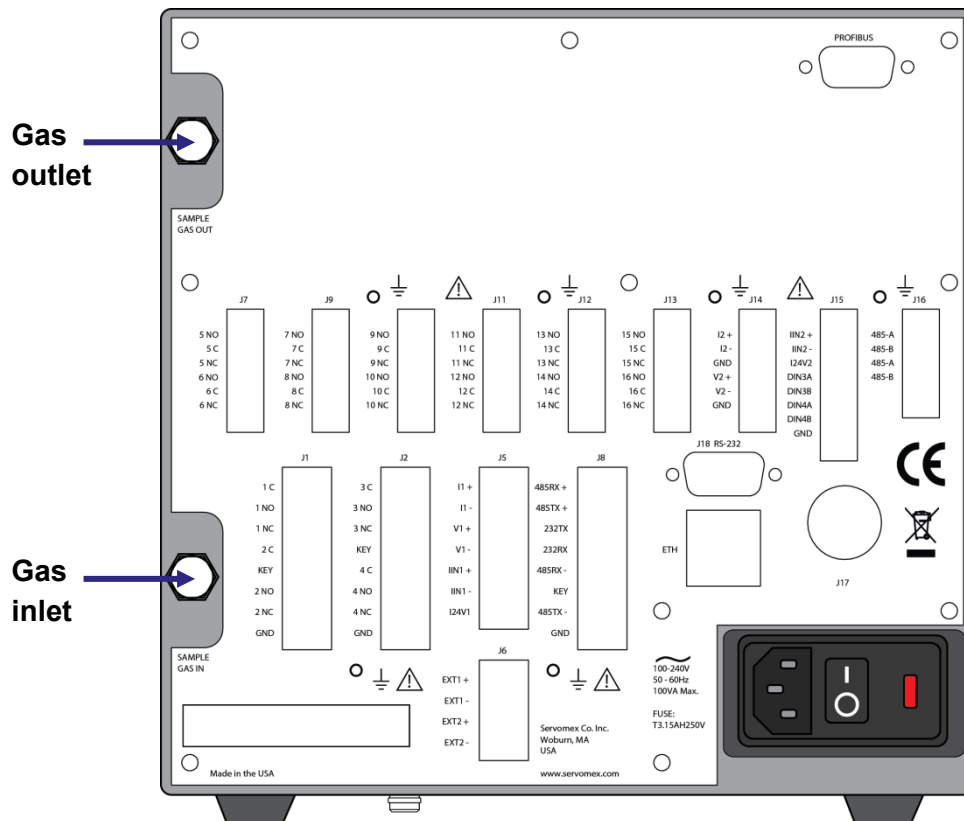

Figure 2-1: Gas inlets and outlets on rear of the analyzer

Hint: If you do not intend to use the analyzer immediately, replace the protective plastic covers and remove them just before connecting into the process sample pipework fitting.

3. Inspect the analyzer and the other items supplied, and check that they are not damaged. If any item is damaged, contact Servomex or your local Servomex agent immediately.
4. Check that you have received all of the items that you ordered. If any item is missing, contact Servomex or your local Servomex agent immediately.
5. If you do not intend to use the analyzer immediately:
 - Refit any protective plastic covers.
 - Place the analyzer and any other equipment supplied back in its protective packaging.
 - Store the analyzer as described in section 12.1.
6. If you are using the analyzer straight away, read section 3 – Safety before proceeding.

Hint: *Keep the shipping documentation and packaging for future use, for example when moving the equipment, or returning it for service or repair.*

3 Safety

3.1 General warnings



Before you attempt to install, commission or use the MonoExact DF150E/DF310E and AquaXact 1688 Controller, read this manual carefully.



Do not attempt to install, commission, maintain or use the MonoExact DF150E/DF310E and AquaXact 1688 Controller unless you are trained and know what you are doing. The analyzer must be maintained by a suitably skilled and competent person.



Do not connect the MonoExact DF150E/DF310E and AquaXact 1688 Controller to a power source until all signal and plumbing connections are made.



This analyzer must be operated in a manner consistent with its intended use and as specified in this manual.



The MonoExact DF150E/DF310E and AquaXact 1688 Controller are only suitable for installation in safe areas.



Do not modify the unit, either mechanically or electrically, or the certification of the instrument will be invalidated and it may not operate safely.



The MonoExact DF150E/DF310E and AquaXact 1688 Controller do not include any user-serviceable parts.



Do not use the MonoExact DF150E/DF310E and AquaXact 1688 Controller as Personal Protective Equipment (PPE).



Make sure that all floors or platforms where you install the MonoExact DF150E/DF310E and AquaXact 1688 Controller are large enough for you to move freely and to change position.



The MonoExact DF150E/DF310E and AquaXact 1688 Controller may be attached to equipment that is hot. Always wear the appropriate PPE to minimize the risk of burns.



If the process gas is shut off, make sure the sensor is turned off using the software option. The sensor can be damaged if power to it is on with no gas flowing for several hours.

3.2 Chemical warnings



Sample and calibration gases may be toxic or asphyxiant:

- Make sure that the external connections are leak free at full operating pressure before you use sample or calibration gases.
- Make sure that the sample/bypass outlet pipes are vented to an area where the gases will not be a hazard to people.
- Make sure that the analyzer is used in a sufficiently well-ventilated environment, to prevent the build-up of toxic gases.
- Make sure that the pipes that you connect to the analyzer are routed so that they do not present a hazard to people.
- Never inspect the inlet filter(s), or service or repair the analyzer while such gases are still connected to it.
- If the analyzer is to be serviced or repaired it is important that all pipework is flushed with an inert gas and the analyzer is allowed to freely vent to local atmosphere.



Where there is a risk associated with the release of potentially harmful gases into the operating environment, always use suitable monitoring equipment.



The electrolyte is a caustic solution. Review the Material Safety Data Sheet (MSDS) before handling the electrolyte solution.

The sensor is shipped dry and must be charged with electrolyte before it is operated. Do not ship the analyzer with electrolyte – thoroughly drain and rinse sensor before shipping.

3.3 Electrical warnings



Always observe the appropriate electrical safety codes and regulations.



Make sure that the electrical installation of the analyzer conforms with all applicable local and national electrical safety requirements.



Potentially hazardous AC voltages are present within this instrument. Leave all servicing to qualified personnel. Disconnect the AC power source when installing or removing: external connections, the sensor, the electronics, or when charging or draining electrolyte.



Make sure the analyzer is provided with a sound earth connection via the electrical supply plug.



Make sure the electrical supply coupler or plug is easily accessible for disconnection from the electrical supply.



All signal and electrical supply cables must be rated for temperatures of 70 °C or higher.



The I/O terminals and connections are separated from the analyzer mains circuits by reinforced insulation. The terminals must only be connected to circuits that are themselves separated from mains voltages by at least reinforced insulation.



Make sure that the cables that you connect to the analyzer are routed so they do not present a trip hazard.

3.3.1 Electromagnetic Compatibility (EMC) considerations

The MonoExact DF150E/DF310E and AquaXact 1688 Controller meet the essential requirements of the European EMC Directive (2014/30/EU). The sensor and the 4-20 mA loop are electrically connected, but are isolated from the analyzer housing and sample cell fitting threads.

The analyzer generates and uses small amounts of radio frequency energy. There is no guarantee that interference to radio or television signals will not occur in a particular installation. If interference is experienced, switch off the analyzer to see if the interference disappears. If it does, try one or more of the following methods to correct the problem:

- Reorient the receiving antenna.
- Move the instrument with respect to the receiver.
- Place the analyzer and receiver on different a.c. circuits.

Always consider the following electromagnetic interference issues when installing the MonoExact DF150E/DF310E and AquaXact 1688 Controller:



To provide an acceptable noise environment for the MonoExact DF310E, MonoExact DF150E or other digital equipment in the proximity of switching inductive loads, Servomex recommend that you place varistors across the inductors to lessen high voltage spikes that occur during transitions.



Circuitry activated by relay contacts should allow for the contact bounce. One simple method is to place a capacitor across the relay contacts.



Route a.c. power wiring as far from the analyzer and its wiring as possible.

3.4 Markings

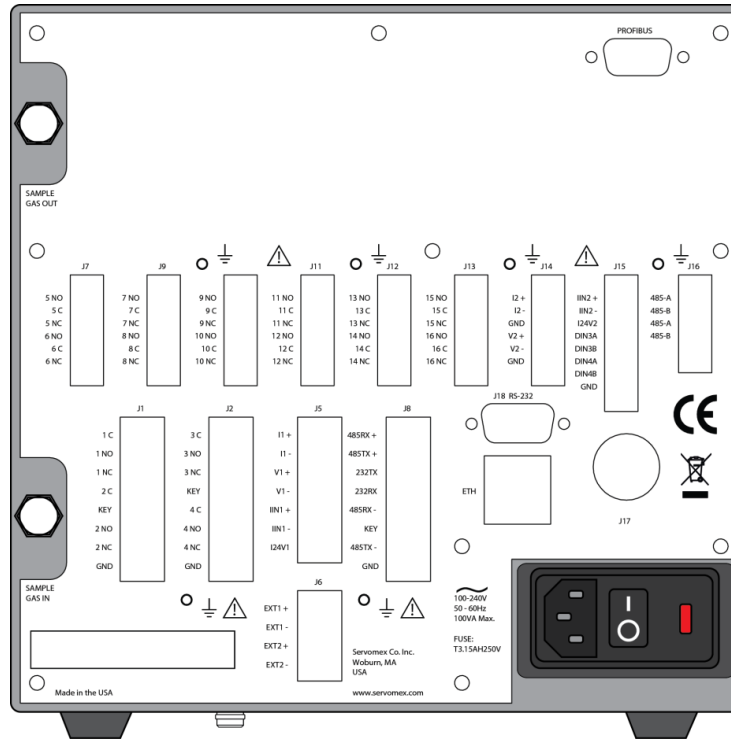

Figure 3-1: Rear of the MonoExact DF310E and AquaXact 1688 Gas Analyzer

The MonoExact DF150E/DF310E and AquaXact 1688 Controller include the following external markings on the rear panel.



Do not connect any cables carrying mains voltage or cables that have inadequate insulation between line and mains to any of the I/O connectors.



Earth / ground connections. These are screw terminals used to connect the ground shields of cables plugged into the nearby connectors. Do not connect any voltages to these connections.



This label identifies that:

- **The analyzer is considered to be within the scope of the Waste Electrical and Electronic Equipment (WEEE).**
- **The analyzer is not intended for disposal in a municipal waste stream (such as landfill sites, domestic recycling centers and so on), but must be submitted for material recovery and recycling in accordance with the local regulations which implement the WEEE Directive.**

Follow the appropriate safety instructions and be aware of any warnings about potential hazards.

4 User interface

Note: All ordering options referred to in this manual (for example, auto validate) must be specified at the time of purchase. If your analyzer does not have the corresponding product options, then menus and menu options associated with the option will not be available for use.

4.1 Introduction

The user interface is a touchscreen that displays screens to allow you to operate the MonoExact DF150E/DF310E and AquaXact 1688 Controller. All of the analyzers share common features but each has unique features which are detailed in this manual.

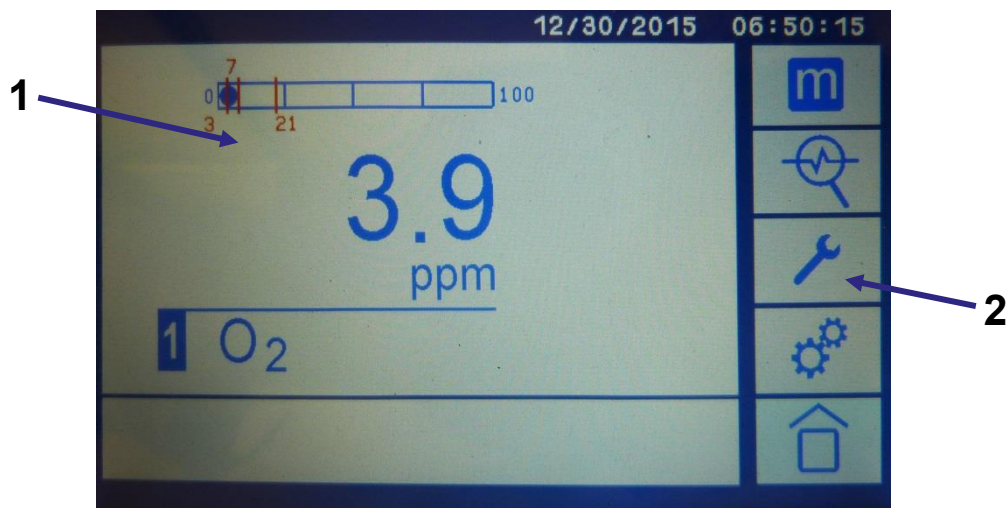

Figure 4-1: The user interface menu screen

The user interface comprises the following:

- 1 Touchscreen display Screens are displayed on the touchscreen (section 4.2 onwards). The function of the active icons depends on the screen currently displayed.
- 2 Touchscreen icons The icons displayed depend on the current screen.

4.2 General techniques

4.2.1 Touchscreen operation











Each screen displays active icons that are relevant to that screen operation. To use the icon, just touch the screen on top of the icon graphic.

Note: The touchscreen icons turn blue when they are selected.



When a screen is selected, more touchscreen icons are displayed.

4.2.2 Touchscreen icons

The following table shows touchscreen icons that frequently appear on different screens.

Icon	Meaning	Function
	Menu	Displays the Menu screen (Figure 4-1).
	Measurement	Displays the Measurement screen.
	Diagnostics	Displays the Diagnostics screen where system-wide diagnostic tools can be found.
	Maintenance	Displays the Maintenance screen where system-wide maintenance can be carried out.
	Settings	Displays the Settings screen where system-wide parameters can be defined.
	Calibrate	Displays the Calibrate screen where system-wide settings can be defined.
	Alarm settings	Displays the Alarm settings screen where system-wide alarm parameters can be defined.
	Home	Displays the Home screen.
	Accept	Touch this icon to accept any changes made.
	Reject	Touch this icon to reject any changes made.

In this manual, the navigation route through the user interface screens is described by a sequence of icons that you must touch on the interface screen. For example, to display the Alarms screen, a sub-screen of the Measurement screen, you must:

1. Touch the  icon to display the Menu screen.
2. Touch the  icon to display the Measurement screen
3. Touch the  icon to display the Alarms screen.

This sequence is shortened to:



4.2.3 System and measurement status icons

The status icon is located at the top right corner of the Home screen. If the system is healthy, the green OK icon displays (Figure 4-2).

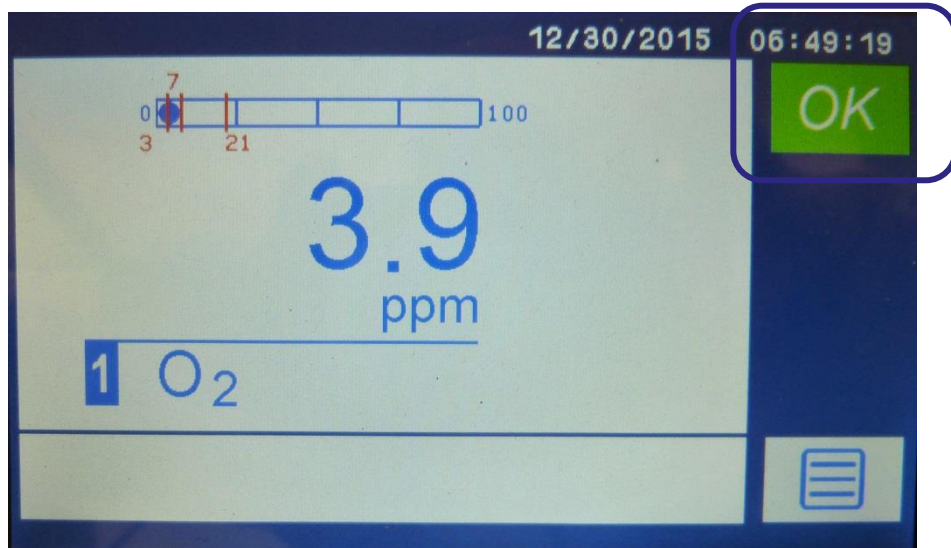

Figure 4-2: Home screen

Note: Touch the green OK icon to display the date and time when the analyzer was last started.

If a problem occurs with the system, the status icon changes to one of the symbols shown in Table 4-1.



Icon	Meaning	Meaning
	Alarm	Indicates that there is an alarm on the system. Touch the icon to display the Alarm Selection screen.
	Faults	Indicates a fault with the system, for example a communication failure with the sensor, an over-temperature condition or a low electrolyte condition or out of specification where the measured value is out of the maximum range for the sensor. Touch the icon to display a message in the text bar describing the fault.

Table 4-1: Status icons

4.3 Menu structure

- Notes:
1. Alarms 1 – 8 each have their own settings. Only one set is shown.
 2. Screens marked * are not applicable to the DF150E.

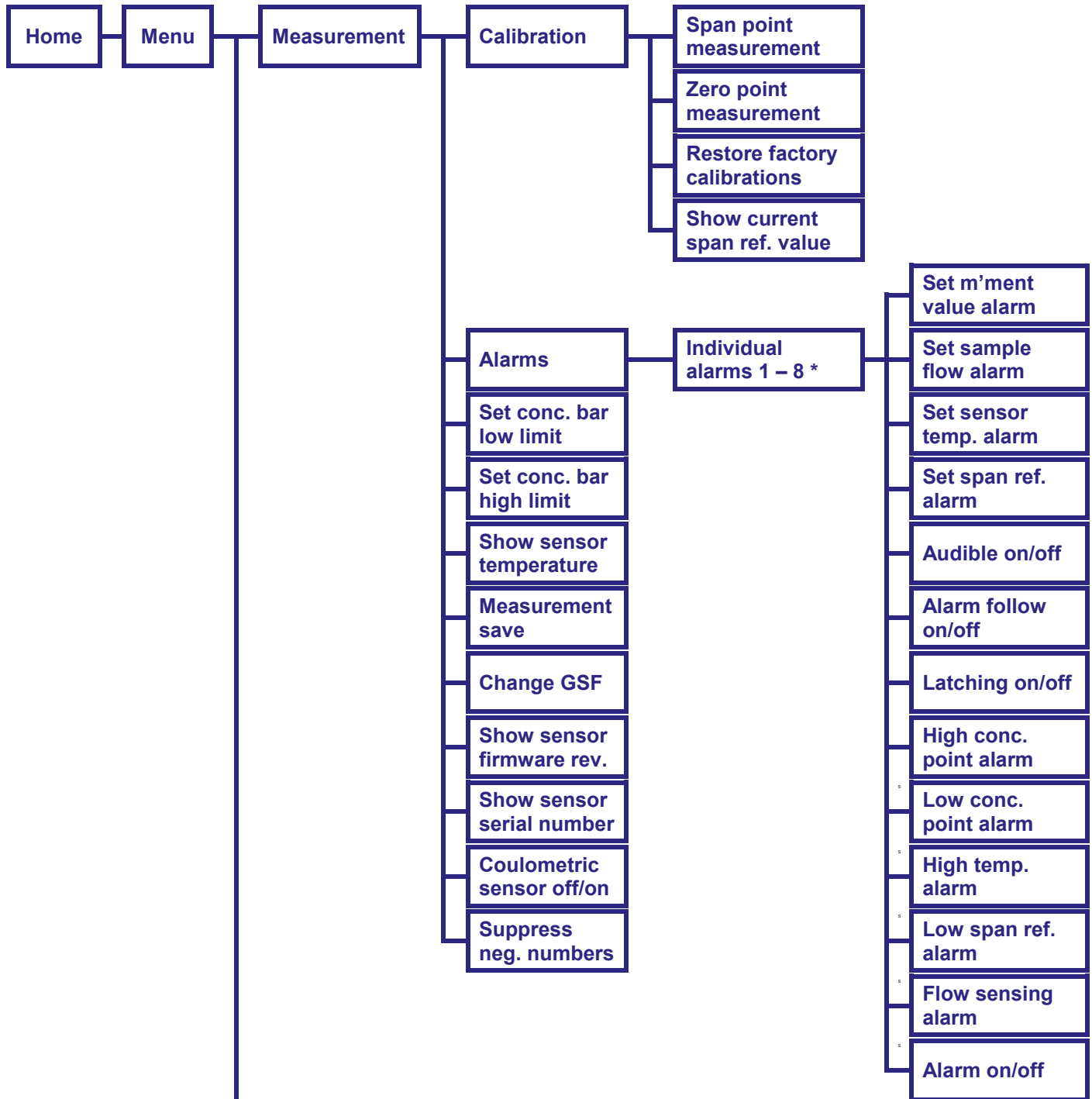

Continued...

From previous page...

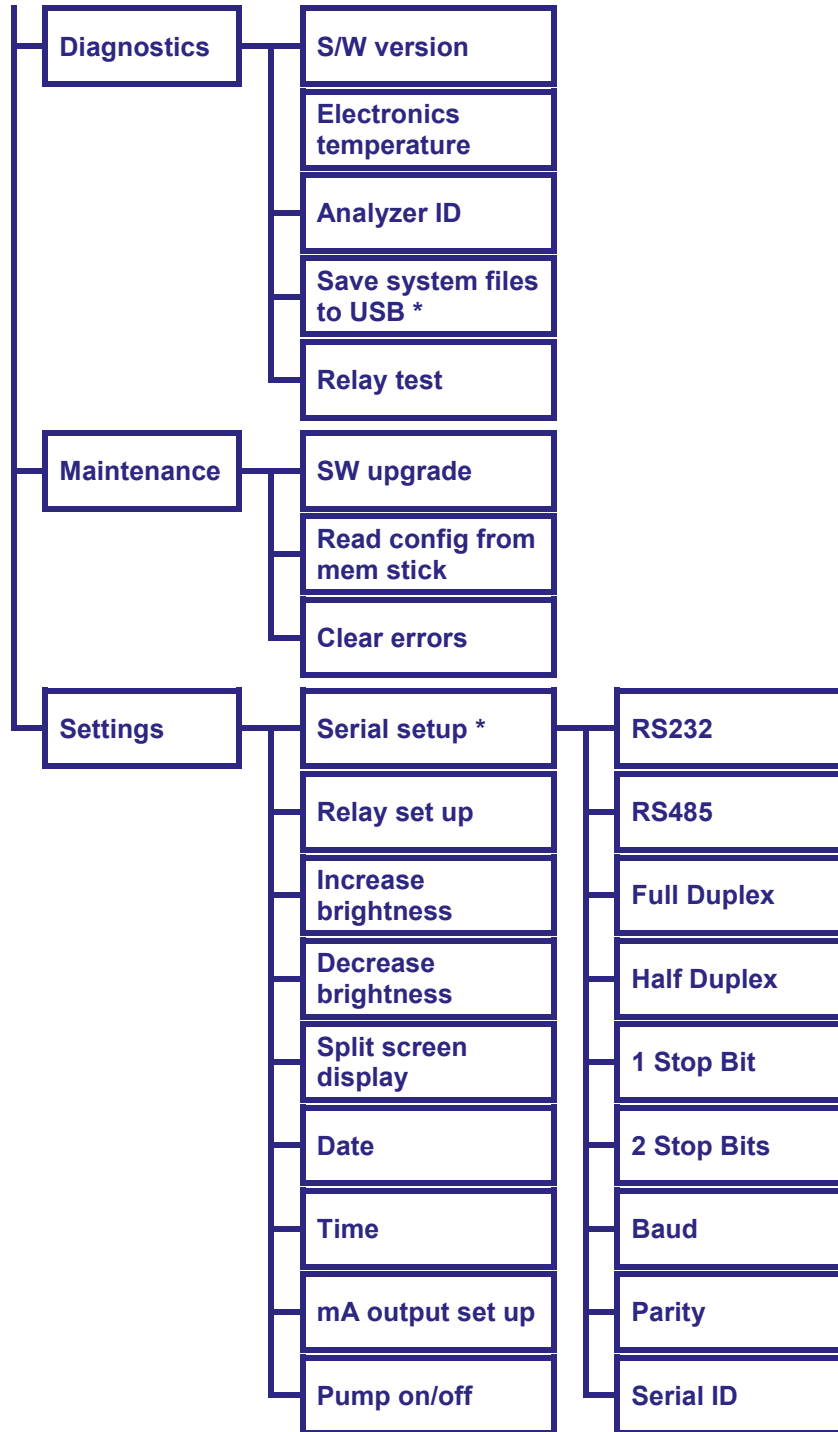

Figure 4-3: User interface menu structure

4.4 Home screen

The Home screen (Figure 4-4) displays the current measurement and system status.

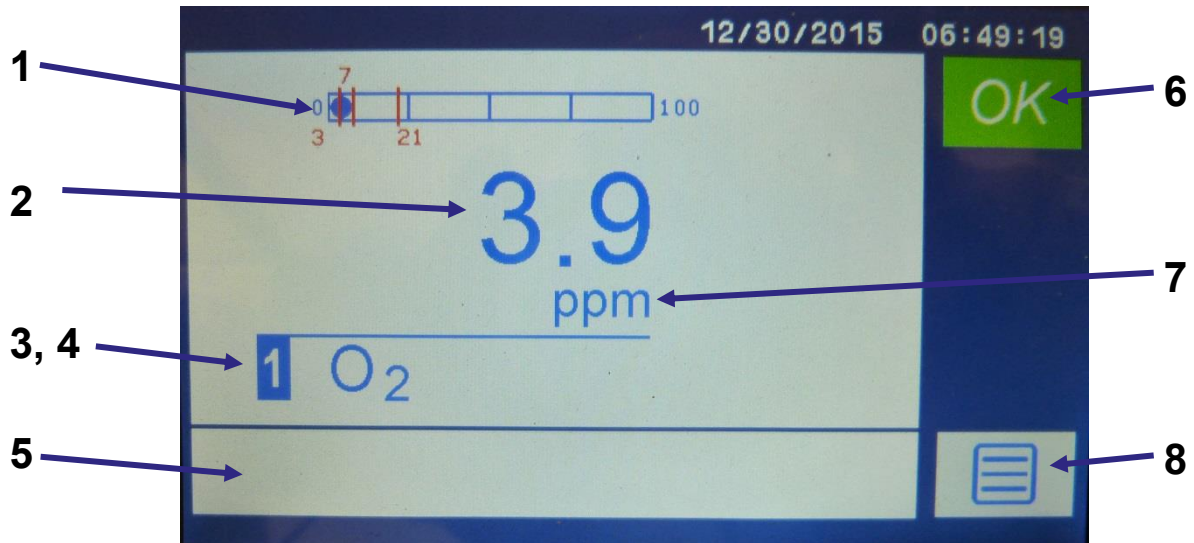

Figure 4-4: Home screen

- | | | | |
|---|---|---|--|
| 1 | Bar graph showing the measurement relative to range boundaries and relative to alarm thresholds | 5 | Information area where messages such as error codes, IP address, and diagnostic information are displayed. |
| 2 | Current measurement | 6 | System status |
| 3 | Transducer number
<i>Note: 1 is always shown.</i> | 7 | Measurement units |
| 4 | Gas being measured | 8 | Menu icon (section 4.5) |

Hint: If no icon is pressed for 1 minute, the measurement screen is automatically displayed. You will also then have to re-enter the password to access any password-protected screens.

4.5 Menu screen

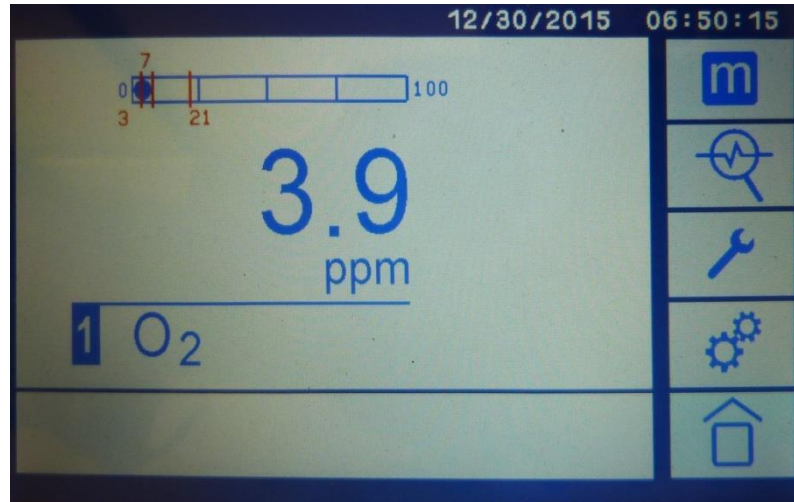







Figure 4-5: Menu screen

Icon	Meaning	Function
	Measurement	Displays the Measurement screen where measurement and alarm settings can be adjusted (section 4.6).
	Diagnostics	Displays the Diagnostics screen where system-wide diagnostic tools can be found (section 4.7).
	Maintenance	Displays the Maintenance screen where system-wide maintenance actions can be initiated (section 4.8).
	Settings	Displays the Settings screen where system-wide parameters can be defined (section 4.9).
	Return to the Home screen	Touch this to close the menu options and return to the Home screen (section 4.4).

Note: The first column of icons on each main screen is the same as the Menu screen. The relevant icon changes to blue to show which screen is the current screen.

4.6 Measurement screen



The Measurement screen has three pages (Figure 4-6 to Figure 4-8) where a second column of icons appears.

Note: Page 1 displays first.

To go to the subsequent pages, press the  icon.

To go back to the previous page, press the  icon.

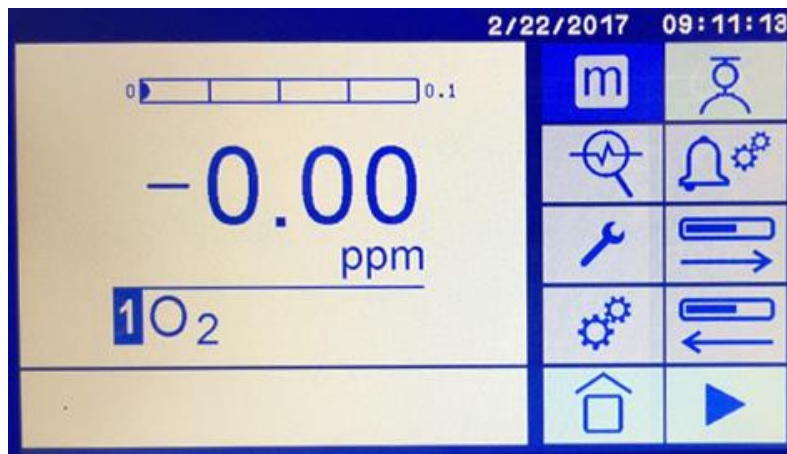

Figure 4-6: Measurement screen – page 1



Figure 4-7: Measurement screen (DF310E) – page 2

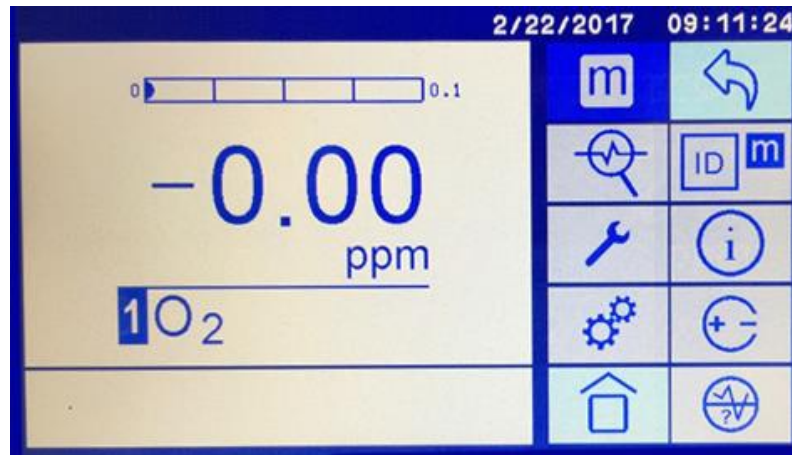

Figure 4-8: Measurement screen – page 3

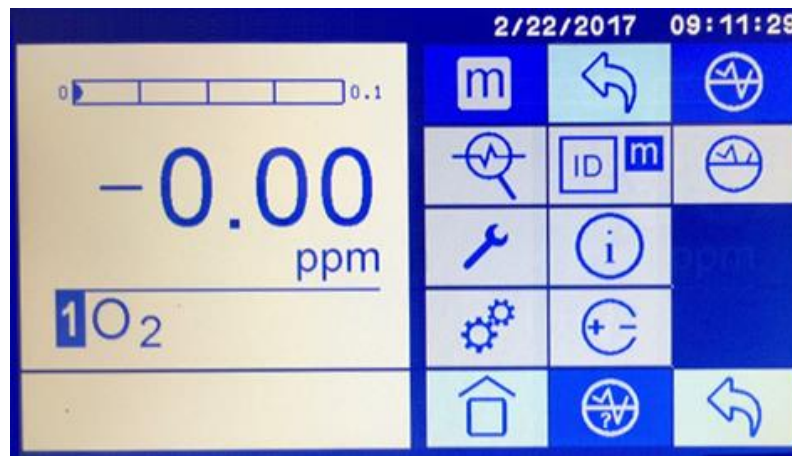















Figure 4-9: Measurement screen – page 4 (DF310E only)

The measurement icons are listed below:

Icon	Meaning	Function
	Calibrate menu	To define the calibration settings for the system.
	Alarm menu	To define the alarm settings for the system.
	Range bar: high limit	To set the upper limit of the range bar.
	Range bar: low limit	To set the lower limit of the range bar.
	Sensor temperature	To display the sensor temperature.
	Measurement save option	<i>DF310E only.</i> To setup the measurement save option.

	GSF settings	To change the Gas Scale Factor.
	Sensor firmware revision	To display the sensor firmware revision.
	Sensor serial number	To display the sensor serial number.
	Coulometric sensor on/off	To turn the coulometric sensor on and off.
	Suppress negative numbers on/off	<i>DF310E only.</i> To turn the 'suppress negative numbers' option on and off.
	Suppress negative numbers off	<i>DF310E only.</i> Negative numbers will not be suppressed and will be displayed.
	Suppress negative numbers on	<i>DF310E only.</i> Negative numbers will be suppressed and will not be displayed.

Note: The sensor firmware revision, temperature and serial number display in a text box at the bottom of the screen when the relevant button is pressed.





If the process gas is shut off, make sure the sensor is turned off using the software option. The sensor can be damaged if power to it is on with no gas flowing for several hours.

4.7 Diagnostics screen



Note: Page 1 displays first.

To go to the subsequent pages, press the  icon.

To go back to the previous page, press the  icon.

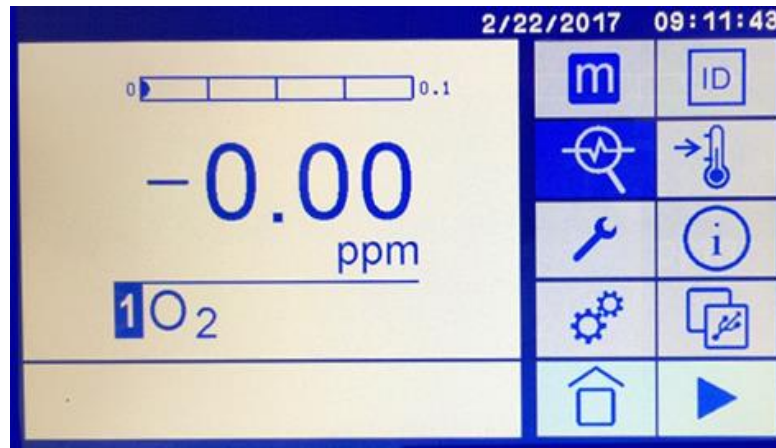

Figure 4-10: Diagnostics screen – page 1

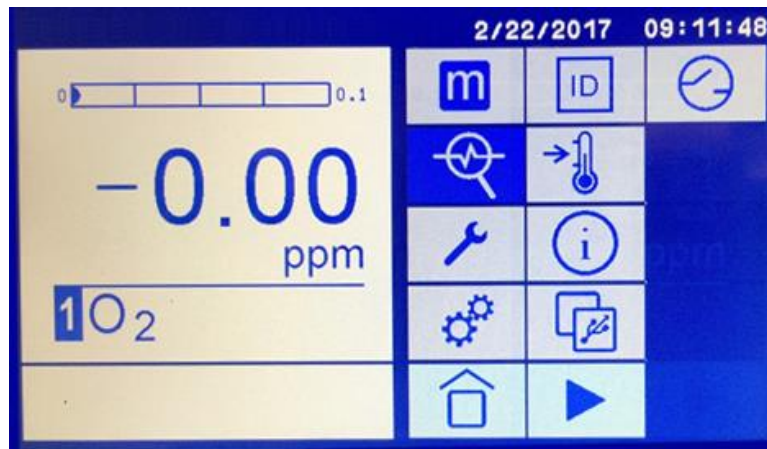







Figure 4-11: Diagnostics screen – page 2



Figure 4-12: Diagnostics screen – page 3

The diagnostics icons are listed below:

Icon	Meaning	Function
	Software revision number	To display the software revision number.
	Electronics temperature	To display the temperature of the electronics.
	Analyzer serial number	To display the serial number of the analyser.
	Save system files to USB	To save the system files to a USB memory device.
	Relay test	To display a screen showing all relays (Figure 4-12). Click on each relay in screen 3 to test them.



Note: The firmware revision and temperature display in a text box at the bottom of the screen when the relevant button is pressed.

4.8 Maintenance screen



Figure 4-13: Maintenance screen

The maintenance icons are listed below:

Icon	Meaning	Function
	Update firmware	To update the firmware.
	Read config files from USB memory device	To read configuration files from a USB memory device.
	Clear errors	This clears any error warnings such as Failed Calibration.

4.9 Settings screen



Note: Page 1 displays first.

To go to the subsequent pages, press the  icon.

To go back to the previous page, press the  icon.

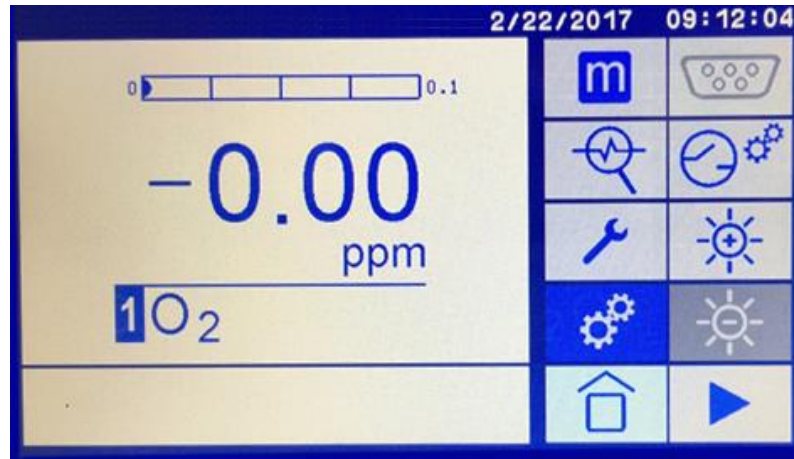

Figure 4-14: Settings screen – page 1

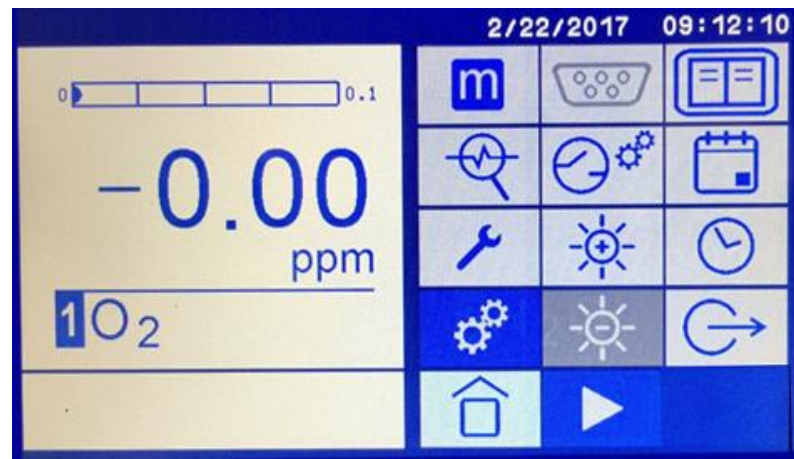

Figure 4-15: Settings screen – page 2

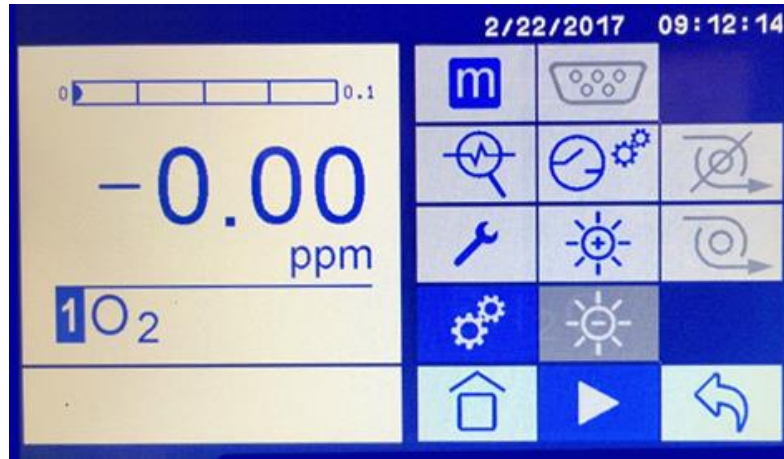

































Figure 4-16: Settings screen – page 3





















The settings icons are listed below:

Icon	Meaning	Function
	Serial set up	<i>DF310E & AquaXact Controller only:</i> To set up serial communications parameters.
	Relay set up	To set up the relays.
	Increase brightness	To increase the screen brightness.
	Decrease brightness	To decrease the screen brightness.
	Split screen	To show two screens together. This toggles with the single screen icon below.
	Single screen	To show a single screens. This icon toggles with the split screen icon below.
	Date set up	To set up the date for the system.
	Time set up	To set up the time for the system.
	mA output set up	To set up the mA outputs.
	Pump off	To turn the pump off. This toggles with the pump on icon below.
	Pump on	To turn the pump on. This toggles with the pump off icon above.

4.10 Touchscreen icon glossary

Icon	Meaning	Para.	Icon	Meaning	Para.
	Alarm menu	5.10.1		Analyzer serial number	4.7
	Alarm: off	5.10.2		Calibrate menu	5.10.2 K.5
	Alarm: low concentration point	5.10.2		Calibration: restore factory calibration	7.1 K.5
	Alarm: high concentration point	5.10.2		Calibrate: single point calibration value <i>(AquaXact 1688 only)</i>	K.5
	Alarm: flow	5.10.2		Clear errors	4.8
	Alarm: high temperature	5.10.2		Concentration range: high	5.12
	Alarm: low span reference	5.10.2		Concentration range: low	5.12
	Alarm: flow sensing	5.10.2		Coulometric sensor off	4.6
	Alarm: not audible	5.10.2		Coulometric sensor on	4.6
	Alarm: audible	5.10.2		Date set up	5.5.2
	Alarm: not followed	5.10.2		Diagnostics menu	4.7
	Alarm: followed	5.10.2		Electrolyte replenishment	C.3.1
	Alarm: latching off	5.10.2		Firmware update	4.8
	Alarm: latching on	5.10.2		Follow	5.7
	Alarm: measurement	5.10.2		Not follow	5.7
	Alarm: span ref.	5.10.2		GSF settings	5.9.2
	Alarm: temperature	5.10.2		Home screen	4.4

Icon	Meaning	Para.	Icon	Meaning	Para.
	mA output screen	4.9		Relay test	4.7
	Maintenance menu	4.8		<i>RS232/485 are for DF310E & AquaXact Controller only:</i>	
	Measurement menu	4.6		RS232 communications	A.3
	Measurement: span point	7.1		RS485 communications	A.3
	Measurement: zero point	7.1		RS232/485 comms: Baud rate	A.3
	Moisture units	K.2		RS232/485 comms: Duplex: Full	A.3
	Next page			RS232/485 comms: Duplex: Half	A.3
	Pump off	4.9		RS232/485 comms: Parity	A.3
	Pump on	4.9		RS232/485 comms: Stop bits: 1	A.3
	<i>AquaXact 1688 only:</i> Pressure	K.3		RS232/485 comms: Stop bits: 2	A.3
	<i>AquaXact 1688 only:</i> Pressure: pipeline	K.3		RS232/485 comms: RS485 function	A.3
	<i>AquaXact 1688 only:</i> Pressure: transmitter	K.3		RS232/485 comms: RS485 function: DF communications	A.3
	<i>AquaXact 1688 only:</i> Pressure correction: on	K.3		RS232/485 comms: RS485 function : None	A.3
	<i>AquaXact 1688 only:</i> Pressure correction: off	K.3		RS232/485 comms: RS485 function: Modbus	A.3
	Read config files from USB device	4.8		RS232/485 comms: RS485 – Modbus: Word swapping on	A.3
	Relay setup	4.9		RS232/485 comms: RS485 – Modbus: Word swapping off	A.3

Icon	Meaning	Para.	Icon	Meaning	Para.
	<i>DF310E & AquaXact Controller only:</i> Save: Measurement save option	4.6		Split screen	4.9
	Save: System files to USB	4.7		Status: alarm	5.10
	Serial set up	App A		Status: system health OK	4.4
	Settings menu	4.9		Suppress negative numbers: on/off	4.6
	Screen brightness: increase	4.9		Suppress negative numbers off	4.6
	Screen brightness: decrease	4.9		Suppress negative numbers on	4.6
	Sensor firmware revision	4.6		Temperature: Electronics	4.7
	Sensor serial number	4.6		Temperature: Sensor	4.6
	Show current span ref. value	7.1		Time set up	5.5.3
	Single screen	4.9		<i>AquaXact 1688 only:</i> Tip replacement	K.6
	Software revision number	4.7			

5 Installation and set-up



Do not attempt to install, commission, maintain or use the MonoExact DF150E/DF310E and AquaXact 1688 Controller unless you are trained and know what you are doing.



The MonoExact DF150E/DF310E and AquaXact 1688 Controller are only suitable for installation in safe areas.



Follow the instructions in this section to safely install the MonoExact DF150E/DF310E and AquaXact 1688 Controller.



Make sure that all floors or platforms where you install the MonoExact DF150E/DF310E and AquaXact 1688 Controller are large enough for you to move freely and to change position.



Do not install the unit in places subject to extreme mechanical vibration or shock. If you do, sample measurements may not be accurate or the analyzer may be damaged.

5.1 Transducer specific installation

5.1.1 Coulometric transducer

Adding electrolyte



The electrolyte is a caustic solution. Review the Material Safety Data Sheet (MSDS) before handling the electrolyte solution.

The sensor is shipped dry and must be charged with electrolyte before it is operated. Do not ship the analyzer with electrolyte – thoroughly drain and rinse sensor with replenishing solution or distilled water before shipping.



Use only Hummingbird E-lectrolyte Blue. Failure to do so will void warranty. Install one bottle.



Do not apply power before adding electrolyte and thoroughly purging the sample line.

Remove the sensor as follows:

1. Remove four screws and the cover, then open the front door of the analyzer (turn rotary knob to right of the touchscreen display, or turn the key lock latch).
2. Use a ½ inch open-end wrench to disconnect the gas fittings on the left side of the sensor (F1 and F2 in Figure 5-1).



Figure 5-1: Disconnect the gas fittings

3. Completely loosen the bracket retaining thumbscrew immediately in front of the sensor (Figure 5-1).
4. Slide the sensor assembly back slightly, then upwards to move the sensor to a position just in front of the analyzer.
5. Unscrew the blue sensor cap from the electrolyte reservoir and add the entire contents of one bottle (125 ml) of ϵ -lectrolyte Blue to the sensor.
6. Replace the cap and hand-tighten securely.
7. Reinstall the sensor by repeating steps 1 through 4 in reverse order.
8. Allow the sensor to sit with electrolyte in it for approximately 60 minutes before flowing gas through the analyzer.



For best performance at initial start or anytime the electrolyte is changed, it is important to allow the sensor to sit with electrolyte in it for 60 minutes before the gas is allowed to flow through the sensor.

5.2 Mechanical Installation

5.2.1 Bench mounting

Place the analyzer on a firm level bench or other suitable solid work surface.

5.2.2 Panel mounting



Make sure that an addition support is provided under the base of the analyzer towards the rear of the enclosure (Figure 5-2). Do not support the analyzer by the side mounting brackets alone.

If you do not, the analyzer may be damaged or may fall and damage other equipment.

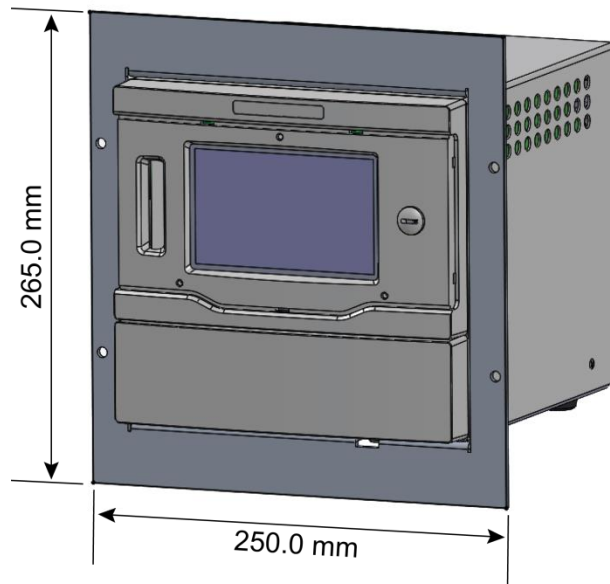

Figure 5-2: Panel installation

1. Refer to Figure 5-2. Prepare a cut-out in a suitable panel.
2. Prepare a suitable base support and secure it in your frame or cabinet.
3. If the bolts and washers are supplied separately, use them to fit the left- and right-hand mounting brackets to the analyzer.
4. Fit the analyzer in the panel and secure it in place with nuts and bolts fitted through the holes in the panel and mounting bracket.

5.2.3 Rack mounting

Before installing the analyzer, determine where you will install it in the rack enclosure. The analyzer will occupy 9 rack flange cage nut positions vertically. With the bottom cage nut designated as position 1, you will need to use positions 1, 3, 4 and 7 on both the right-hand and left-hand front and rear rack enclosure flanges.

Note: You do not need to punch out any of the other cage nut positions.

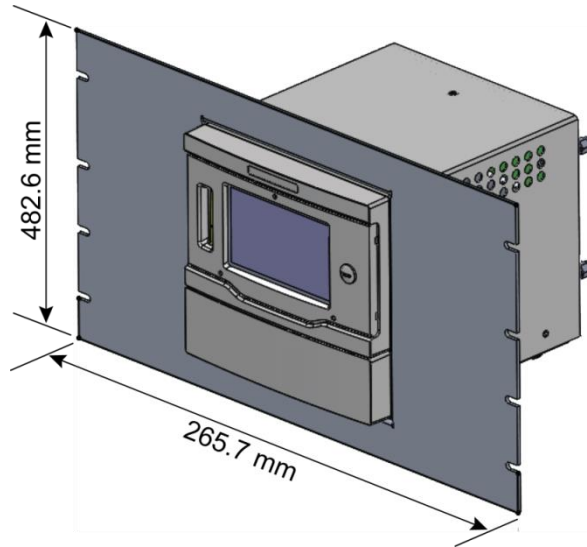

Figure 5-3: Rack installation

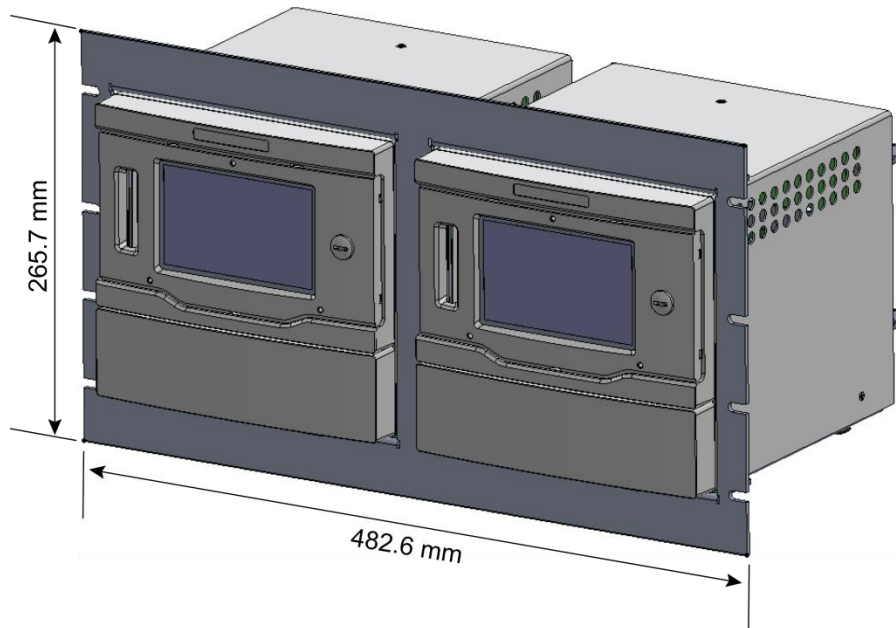

Figure 5-4: Dual rack installation

Refer to Figure 5-3 or Figure 5-4 and install the analyzer as follows:

If the rack mounting kit has been supplied as a spare:

1. Remove the two slide inner sections from the two slide outer sections.
2. Use the supplied M5 screws to fit the two slide inner sections to the sides of the analyzer.
3. Determine where the analyzer will be fitted in the rack, then, counting from the bottom cage nut position (position 1):
 - Install cage nuts in positions 1, 3, 4, and 7 on the left-hand and right-hand front rack enclosure flanges.
 - Install cage nuts in positions 1 and 4 on the left-hand and right-hand rear rack enclosure flanges.
4. Engage the two M6 waisted screws into the cage nuts in positions 1 and 4 on the left-hand and right-hand front and rear rack enclosure flanges.
5. Fit the right-hand slide support clamps:
 - Hold the front slide support clamp in position behind the rack enclosure front flange, and align the fixing holes in the clamp with the cage nuts in positions 1 and 4.
 - Engage the two M6 waisted screws in the fixing holes in the clamp. Do not fully tighten the waisted screws.
 - Hold the rear slide support clamp in position behind the rack enclosure rear flange, and align the fixing holes in the clamp with the cage nuts in positions 1 and 4.
 - Engage the two M5 waisted screws in the fixing holes in the clamp. Do not fully tighten the waisted nuts.
6. Fit the right-hand slide support brackets:
 - Fit the front slide support bracket between the cage nuts and the front side support clamp, then fully tighten the two M6 waisted screws to secure the support bracket in position.
 - Fit the rear slide support bracket (10) between the cage nuts and the rear slide support clamp then fully tighten the two M6 waisted screws to secure the support in position.
7. Make sure that the slide opening is at the front, then loosely fit the right-hand outer slide section to the front and rear slide support brackets and secure with the four M4 screws, and the nuts and washers.
8. Ensure that the front of the right-hand outer slide section is 35 mm behind the rack enclosure front flange, then fully tighten the nuts to secure the slide section in position.
9. Use the procedure in Steps 4 to 8 to fit the left-hand support clamps, slide support brackets and outer slide section.
10. Align the ends of the left-hand and right-hand slide inner sections in the openings in the front of the left-hand and right-hand slide outer sections and slide the analyzer into the rack enclosure.
11. Use the four M6 pan head screws and plastic cup washers to secure the analyzer in place.

5.3 Electrical installation

5.3.1 Electrical safety



Make sure that the electrical installation of the analyzer conforms with all applicable local and national electrical safety requirements.



Make sure the electrical supply coupler or plug is easily accessible for disconnection from the electrical supply.



Make sure the analyzer is provided with a sound earth connection via the electrical supply plug.



All signal and electrical supply cables must be rated for temperatures of 70 °C or higher.



Make sure that the cables that you connect to the analyzer are routed so they do not present a trip hazard.



Follow and obey the instructions given below when you install the analyzer. If you do not, the analyzer warranty may be invalidated, the analyzer may not operate correctly or it may be damaged.



Make sure your electrical supply can provide the necessary maximum power consumption.

5.3.2 Analog output connections



The analog output terminals are separated from the analyzer mains circuits by reinforced insulation. The terminals must only be connected to circuits that are themselves separated from mains voltages by at least reinforced insulation.



To comply with EMC requirements, screened cables must be used to connect the analog outputs.

DF310E

1. Connect the wires in the cable to the screw terminals on J14 or J5 on the rear panel of the analyzer.

Note: J5 provides the same pin out points as the green legacy connector.

Note: Section 9.2 for information on the rating and size of cable.

2. Connect the cable screen to the ground point on the rear of the analyzer.
3. Connect the wires as shown in Table 5-1:

Coulometric or paramagnetic sensor J5			AquaXact 1688 attached J14		
Pin	Signal	Use	Pin	Signal	Use
1	4-20mA	I1+	1	4-20mA	I2+
2	4-20mA	I1-	2	4-20mA	I2-
3	0-10 Vdc	V1+	3	GND	GND
4	0-10 Vdc	V1+	4	0-10 Vdc	V2+
			5	0-10 Vdc	V2+
			6	GND	GND

Table 5-1: Analog output interface connector (J5 and J14)

Note: For the coulometric or paramagnetic sensors an analog Vdc output is provided across J5 pins 3 (V1+) and 4 (V1-). (A mA analog output is optional).

Note: If your analyzer is configured to provide voltage outputs, for the coulometric or paramagnetic sensor the 0-10 Vdc out is J5 pins 3 (V1+) and 4 (V1-).

Note: When the AquaXact transmitter is used with the dedicated controller, the J5 connections are used. J14 is used when the transmitter is used with the MonoExact DF310E.

DF150E

The analog output is proportional to the oxygen reading of the analyzer and on a three range analyzer will be scaled to the 'selected' range. The analog output is 0 to 10 Vdc.

The minimum load impedance is 10 kΩ. Connections to the analog output should be made through a shielded, twisted pair with the shield tied to the nearest ground stud to the terminals labelled Rec + and Rec -.

1. Connect the wires in the shielded, twisted pair cable to the screw terminals labeled Rec+ and Rec- on J2 on the rear panel of the analyzer.

Note: Section 9.2 for information on the rating and size of cable.

2. Connect the cable screen to the ground point on the rear of the analyzer nearest to the connectors labeled Rec+ and Rec-.

5.3.3 Relay connections



The relay connections are separated from the analyzer mains circuits by reinforced insulation. The terminals must only be connected to circuits that are themselves separated from mains voltages by at least reinforced insulation.

Note: The relays do not have default settings. Users can create alarms and assign them to any relay (section 5.6).

DF310E

The DF310E analyzer has a number of relays available via the connectors J1, J2, J7, J9, J10, J11, J12 and J13 as shown in Table 5-3 (J1), Table 5-4 (J2) and Table 5-5 (J7, J9, J10 – J13).

The relays correspond to the following connectors:

Relay	Connector	Relay	Connector
1	J1	9	J10
2	J1	10	J10
3	J2	11	J11
4	J2	12	J11
5	J7	13	J12
6	J7	14	J12
7	J9	15	J13
8	J9	16	J13

Table 5-2: MonoExact DF310E relay connections

Note: Relays 9 – 16 are not supported in this release of the product.

Connect the wires in your cable to the screw terminals on the relevant connectors as shown in the following tables:

Note: Section 9.2 for information on the rating and size of cable.

J1 Pin	Use	Relay	J1 Pin	Use	Relay
1	COM	1	5	KEY	-
2	N/O	1	6	N/O	2
3	N/C	1	7	N/C	2
4	COM	2	8	GND	-

Table 5-3: Relay interface connector J1 (DF310E)

J2 Pin	Use	Relay	J2 Pin	Use	Relay
1	COM	3	5	COM	4
2	N/O	3	6	N/O	4
3	N/C	3	7	N/C	4
4	KEY	-	8	GND	-

Table 5-4: Relay interface connector J2 (DF310E)

		Connector					
		J7	J9	J10	J11	J12	J13
Pin	Use	Relay	Relay	Relay	Relay	Relay	Relay
1	N/O	5	7	9	11	13	15
2	COM	5	7	9	11	13	15
3	N/C	5	7	9	11	13	15
4	N/O	6	8	10	12	14	16
5	COM	6	8	10	12	14	16
6	N/C	6	8	10	12	14	16

Table 5-5: Relay interface connector J7, J9, J10 – J13 (DF310E)

DF150E

The DF150E analyzer has two relays available via the connectors J1 and J2 as shown in Table 5-7 (J1) and Table 5-8 (J2).

The relays correspond to the following connectors:

Relay	Connector
1	J2
2	J1

Table 5-6: MonoExact DF150E relay connections

Alarms 1 and 2 are optional on the DF150E. Typically, the alarms are configured for high and low oxygen set points but they can also be assigned to a low flow condition if the flow switch option has been purchased.

In the 'No Alarm' condition the NC contact is connected to the C contact.

In the 'Alarm' condition the NO contact is connected to the C contact.

Connect the wires in your cable to the screw terminals on the relevant connectors as shown in the following tables:

Note: Section 9.2 for information on the rating and size of cable.

J1 Pin	Relay	J1 Pin	Relay
N/C	2	RANGE 3	-
COM	2	RANGE 2	-
N/O	2	RANGE 1	-
KEY	-	SENSOR OFF COM	-
COM	-	SENSOR OFF	-

Table 5-7: Relay interface connector J1 (DF150E)

J2 Pin	Relay	J2 Pin	Relay
N/C	1	KEY	-
COM	1	REC +	-
N/O	1	REC -	-
4-20 +	-	GND	-
4-20 -	-	DC COM	-

Table 5-8: Relay interface connector J2 (DF150E)

Remote Range Indicator (Range 1, 2, 3)

The analog output is proportional to the oxygen reading of the analyzer. On three range analyzers the output will be scaled to the currently selected range. If the analyzer has three ranges and the analog output is being sent to a recorder or other remote device, it will be necessary to also send a Range Indicator so the remote reading can be properly scaled.

The Remote Range Indication is a contact closure between a J1 COM connection and the selected range with the lowest range being contact #1 and the highest range being contact #3. The contacts are rated at 24 Vdc, 0.5 Amps.

4 to 20 mA isolated output (4-20+, 4-20-)

The optional 4 to 20 mA output is proportional to the oxygen reading of the analyzer. The output on a three range analyzer will be scaled to the currently selected range.

An output of 4 mA represents an operating analyzer with zero detected oxygen. Outputs ranging from 4 to 20 mA represent oxygen concentrations from zero to the top of the currently selected range.

The 4 to 20 mA output is electrically isolated from all other analyzer outputs and from the chassis (earth) ground. The maximum load resistance is 1 k Ω . The analyzer provides a loop supply of approximately 28 Vdc.

Connections to the 4-20 mA output should be through a shielded, twisted pair with the shield tied to the nearest ground stud.

Note: DF310E: If the concentration exceeds the set range, the analyzer auto ranges to the maximum range. For example if a 0-100 ppm analyzer is set to a range 0-10 and the measured value exceeds 10 then the range will automatically be sent to 0-100.

Note: If a relay is to be thrown when a custom range is exceeded and the analyzer goes to full sensor range, you must set the range in the relay assignment menu (section 5.6).

5.3.4 Connect the electrical supply



Make sure that your external electrical supply outlet is isolated and locked-out before you connect the conductors in the electrical supply cable.



Only use the power supply cord provided with the unit.



Make sure the analyzer is suitable for use with your electrical supply voltage and frequency (section 9.2). If the analyzer is not suitable, it may not operate correctly or it may be damaged if you operate it.

The analyzer is supplied with an electrical supply cable, configured for your electrical supply. Connect the electrical supply to the analyzer as follows:

1. Fit the IEC plug on the end of the electrical supply cable provided to the electrical supply socket on the rear of the analyzer (1 in Figure 5-5).

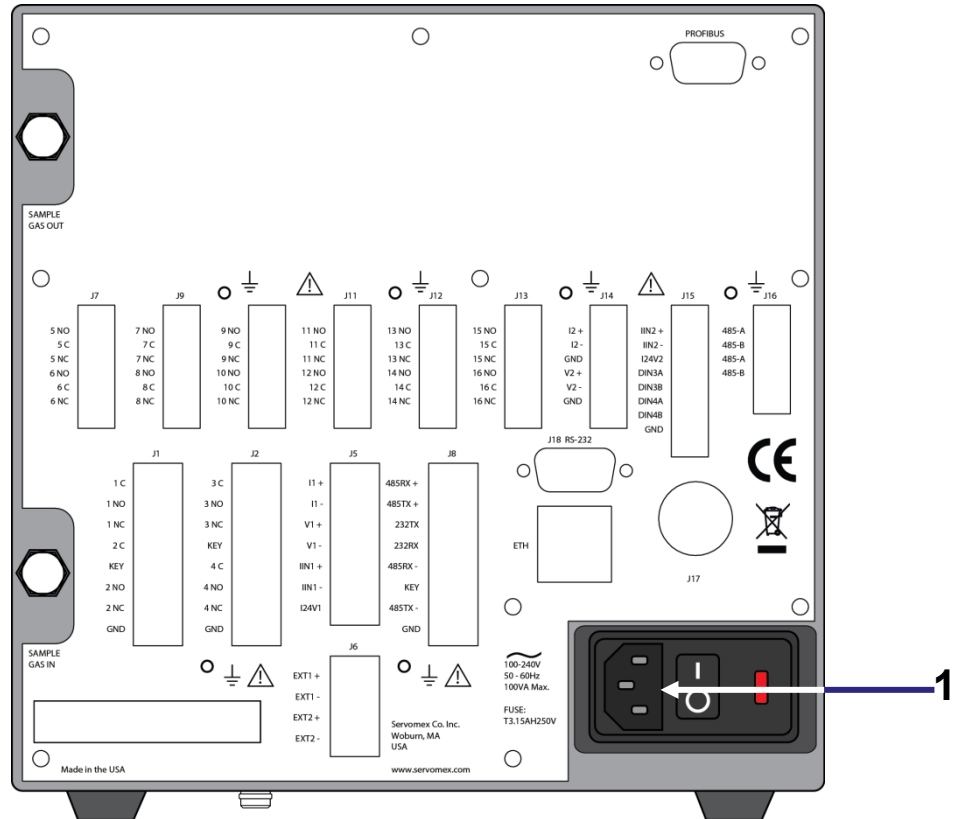

Figure 5-5: Electrical supply socket on rear of analyzer

2. Plug the other end of the electrical supply cable into your electrical supply outlet.
3. Check the earth (ground) continuity between your electrical supply outlet earth (ground) and the functional earth (ground) terminal on the rear of the analyzer.
4. If a local earth bonding is required the functional earth stud can be used. The earthing cable must be kept to less than 3 metres to comply with EMC standards.



This does not replace the earth conductor on the electrical supply socket which must always be connected.

5.4 Sample / calibration gas pipeline connection



Sample and calibration gases may be toxic or asphyxiant:

- Make sure that the external connections are leak free at full operating pressure before you use sample or calibration gases.
- Make sure that the sample/bypass outlet pipes are vented to an area where the gases will not be a hazard to people.
- Make sure that the analyzer is used in a sufficiently well-ventilated environment, to prevent the build-up of toxic gases.
- Make sure that the pipes that you connect to the analyzer are routed so that they do not present a hazard to people.



Over-pressurizing the sensor can result in permanent damage to the sensor. Limit the backpressure to the analyzer to ± 1 psig. Be sure the downstream isolation valve (if so equipped) is toggled open before gas flow is started.



When you carry out a leak test, do not exceed a maximum pressure of 34.5 kPa gauge (0.35 bar gauge, 5 psig) and do not introduce a sudden change of pressure into the analyzer. If you do, the analyzer could be damaged.



It is essential that the analyzer is isolated from the sample system until any cleaning solvents are fully purged from the pipelines. Failure to take this precaution may lead to contamination of the sensor, which will be observed as an offset and drift in output.



If the process gas is shut off, make sure the sensor is turned off using the software option. The sensor can be damaged if power to it is on with no gas flowing for several hours.

Hint:

This section gives simple instructions about connecting the sample and calibration gas pipelines to the analyzer. Refer to section 6 and Appendix C for more information about sample gas preparation and delivery.

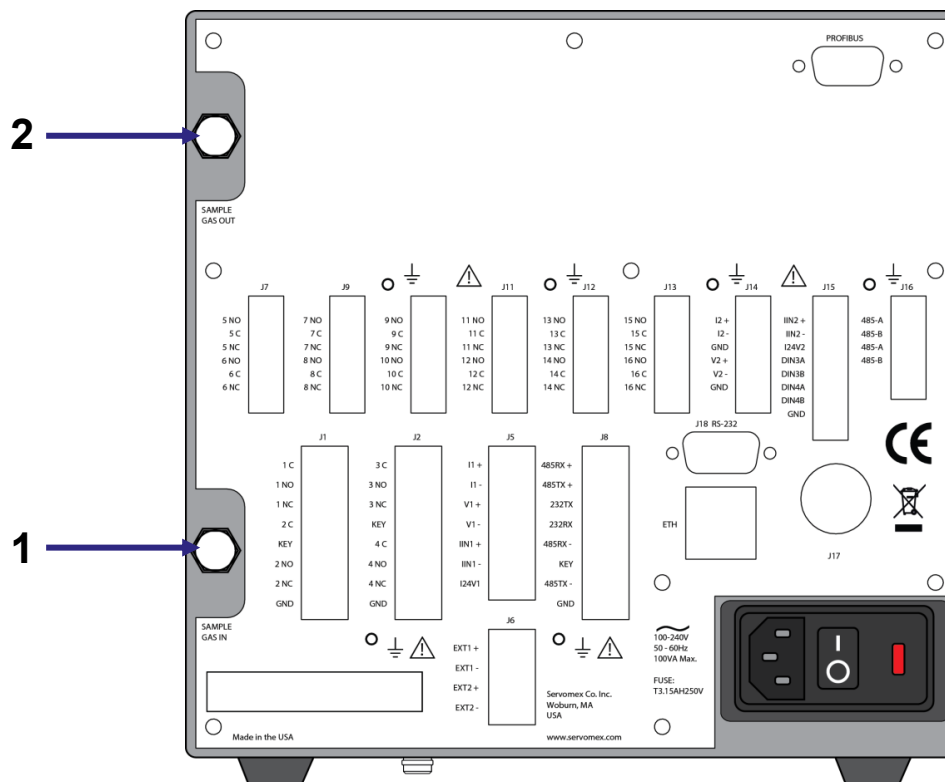

Figure 5-6: Gas inlets and outlets on rear of analyzer

The sample gas inlet and outlet lines at the back of the instrument have stainless steel $\frac{1}{8}$ inch compression bulkhead fittings (unless equipped with the optional $\frac{1}{4}$ inch VCR inlet). There is no gas inlet or outlet when using the AquaXact Controller. Refer to the AquaXact 1688 transmitter manual.

Before connecting any gas line to the analyzer, fully install the supplied gas nut and compression ferrule on your tubing.

Connect your sample/calibration gas inlet and outlet pipelines to the inlet (1 in Figure 5-6) and outlet (2 in Figure 5-6) on the rear of the analyzer. Do not over-tighten the fittings.

Note: A backup wrench is not needed since anti-torque plates inside the cabinet secure the bulkhead fittings.

Note: The optional external filter should be fitted to the inlet pipe with the compression fittings provided.

*Note: Section 9.5 lists the sample gas requirements.
Section 9.6 lists the calibration gas requirements.*

Locate the gas selection valves as close as possible to the analyzer.

Hint: You must connect process gas, switch on the electrical supply and leave the analyzer for at least 4 hours before the results will stabilize. Pay particular attention to the warnings at the start of section 3.

5.5 Switch on and set-up

Hint: When the electrical supply to the analyser is switched on, the readings are displayed on screen and the clock in the upper right hand corner of the screen starts running.

5.5.1 Switch on

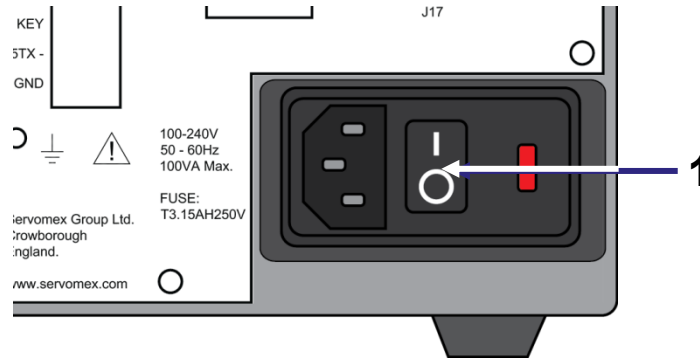

Figure 5-7: On/off switch on the rear of the analyser

To switch on the analyser:

1. Make sure that the ac power is connected to the analyser and that the power supply is switched on.
2. Press I on the On/Off switch on the rear of the analyser (1 in Figure 5-7).

When the analyser is first switched on, the screen displays a progress bar, followed by the Home screen (Figure 5-8).

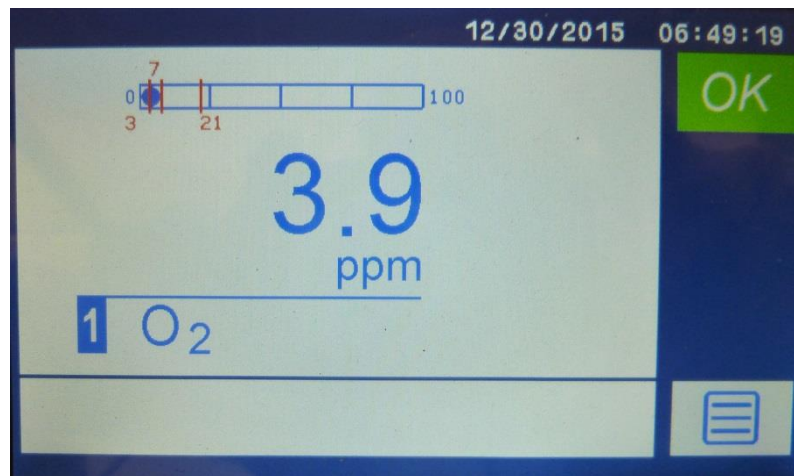

Figure 5-8: Home screen

5.5.2 Set the date

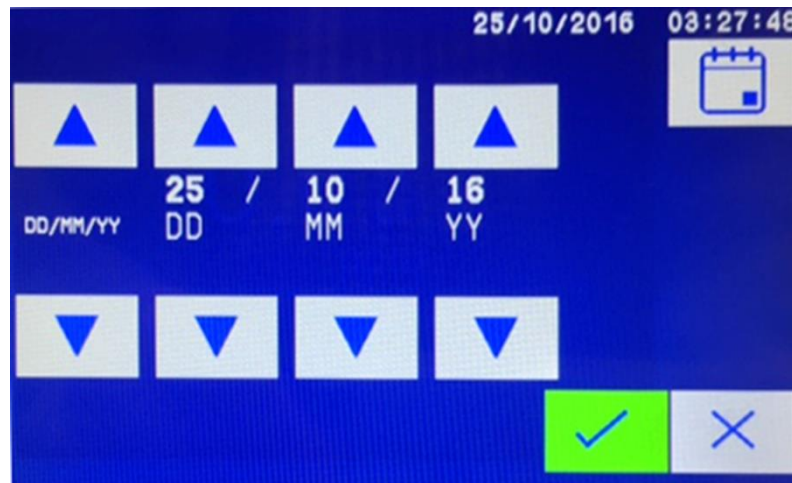





Figure 5-9: Set the date screen

1. Touch the left-hand up or down arrows to select how the date will be displayed (either dd/mm/yy or mm/dd/yy).
2. Touch the second up or down arrows to select the month (where 1 is January, and 12 is December).
3. Touch the middle up or down arrows to select the date (from 1 to 31).
4. Touch the right-hand up or down arrows to select the year.
5. Touch the  icon to accept the value or the  icon to leave the screen without updating the value.

5.5.3 Set the time



1. Touch the left-hand up or down arrows to increase or decrease the hour (where from 00 to 23).
2. Touch the middle up or down arrows to increase or decrease the minute (from 00 to 59).
3. Touch the right-hand up or down arrows to increase or decrease the seconds (from 00 to 59).
4. Touch the  icon to accept the value or the  icon to leave the screen without updating the value.

5.6 Configure the relays



The relays are configured using the relay configuration menus in the Settings Menu. The first page of these menus shows the number of relays purchased as options (Figure 5-10).

Note: There can be two relays for a DF150E and up to eight for a DF310E.

The icons with a dark blue background are active.

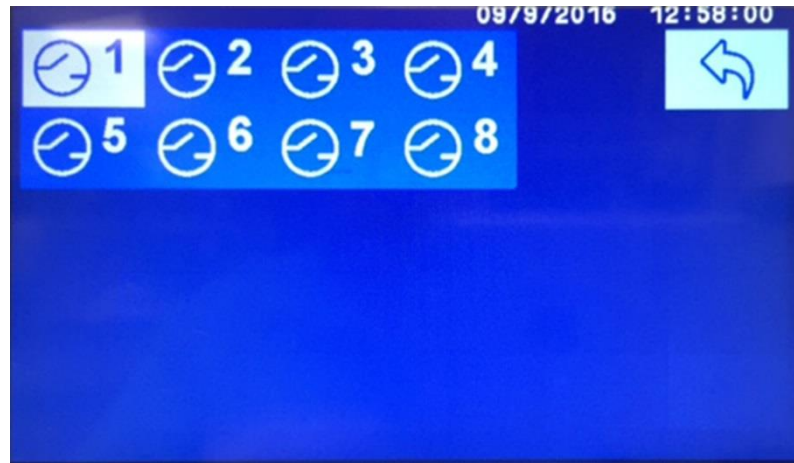

Figure 5-10: Available relays on the system

Touch a relay icon to display the Activity Assignment Menu (Figure 5-11).

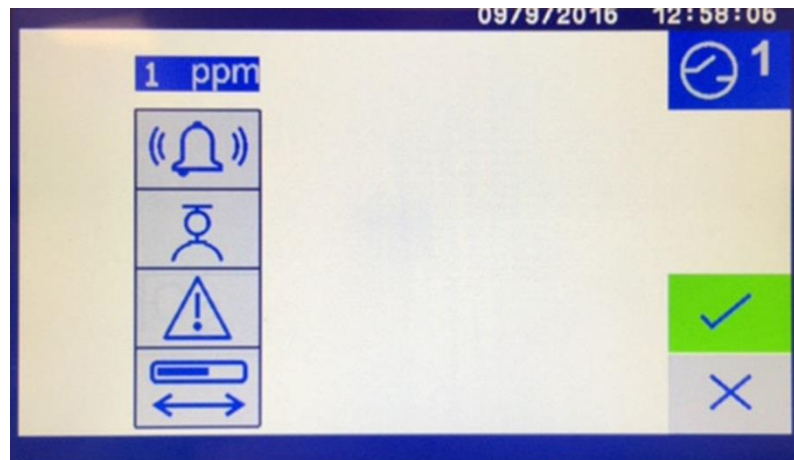





Figure 5-11: Activity Assignment Menu

A relay can be assigned to one or more activities:

-  Alarm
-  Calibration in progress
-  System alarm
-  Out of range state

Note: The activities that will trigger the relay have a dark blue background.

If an alarm relay is chosen, an alarm assignment screen appears (Figure 5-12) and one or more customer set alarms can be selected. These are configured separately (section 5.10).

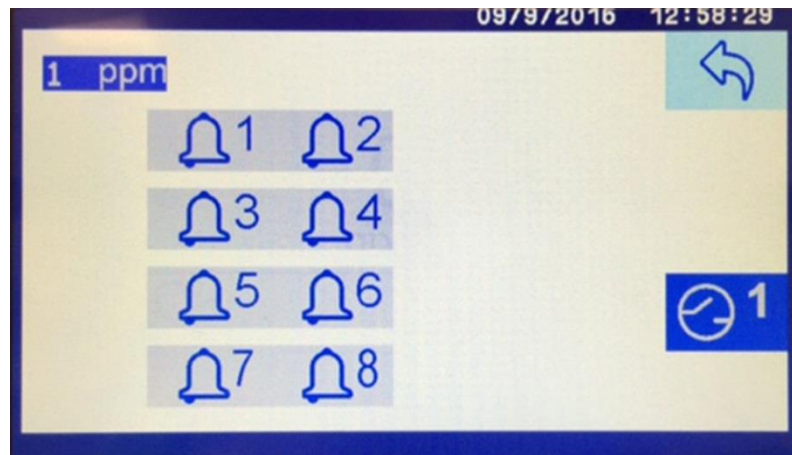



Figure 5-12: Alarm assignment screen

Touch the  icon to return to the relay assignment page

Touch the  icon to save the relay information.

5.7 Configure and use the mA outputs



Figure 5-13: mA output screen

When the mA output screen appears, select either to follow or not follow:

Icon	Meaning	Function
	Follow	The mA output goes to the jam state (either 0 or 2 mA, depending on the option purchased).
	Not follow	The mA output freezes during calibration.

Touch the icon to save the mA output information or the icon to quit the screen without saving.

5.8 Using the voltage outputs

Currently under construction.

5.9 Correct O₂ measurements for differing background gases

Hint: If you are measuring O₂ (oxygen) in a background of nitrogen or air, you do not need to correct the measurements.

5.9.1 Enable cross-interference (X-interference) compensation for O₂ control

Hint: You can only apply cross-interference compensation to O₂ control measurements. See Appendix D.3 for more information.

5.9.2 Enter a gas scale factor (GSF) for compensation

The MonoExact DF oxygen analyzers are calibrated using oxygen in nitrogen standards. The GSF (Gas Scale Factor) is used to correct for changes in the rate of oxygen diffusion when background gases other than nitrogen are present in the process or sample gas.

In many applications, the sample GSF does not need to be altered from the default value of 1.00. However, if the sample gas has a significantly different diffusivity compared with nitrogen (such as helium or hydrogen), the GSF should be applied.

Refer to Section X for a list of gases and GSF correction values. If entering the GSF values manually for background mixtures, calculate the GSF as shown in the Appendix E.2.5 example.

To use the Advanced GSF feature (*DF310E only*), enter the volumetric percentages of the sample gas as described below and the total GSF is automatically calculated by the analyzer. The sum of the background percentages must be equal to 100%. The software in the analyzer supports the gases listed below:

Ammonia	NH ₃	Helium	He
Argon	Ar	Hexane	C ₆ H ₁₄
Butane	C ₄ H ₁₀	Hydrogen	H ₂
Carbon Monoxide	CO	Methane	CH ₄
Ethane	C ₂ H ₆	Nitrogen	N ₂
Ethylene	C ₂ H ₄	Propylene	C ₃ H ₆

Note: Contact the local Servomex Business Center for assistance with gases not listed.

Note: *DF310E:* The method of entering the GSF value depends on the version of the *DF310E* that you purchased.

DF150E: The MonoExact *DF150E* has the GSF set for Nitrogen as standard. If the optional advanced GSF is purchased, press the icon to get a choice of 3 gases: N₂, He and H₂.

Standard GSF (Base model DF310E only)



The GSF screen displays a number pad.

Type in the required GSF value (Figure 5-14) and touch the  icon to set the value.



Figure 5-14: Standard GSF screen

Advanced GSF



The GSF screen displays a page of chemical compounds (Figure 5-15).

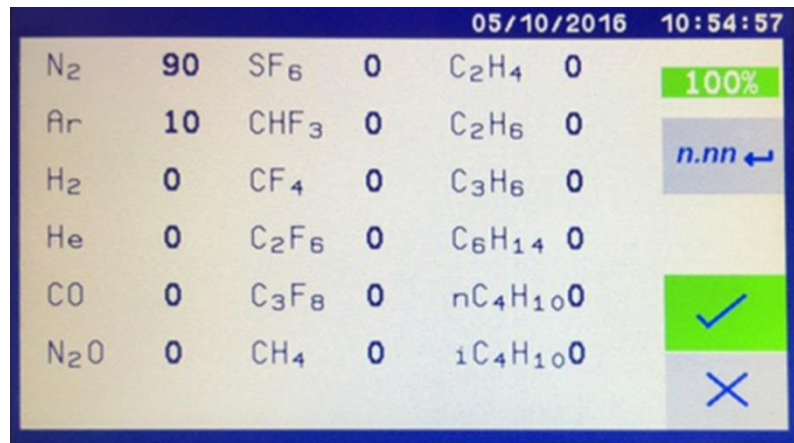

Figure 5-15: Compound screen

1. Touch a compound in the list of gases that display on the screen to select it.
2. A number pad displays. Type in the percentage of a compound in the background gas.



3. Touch the  icon to set the value.
4. Repeat this procedure for each of the components in the background gas.
5. As each compound is added, the percentage box shows the current total (Figure 5-16). This is red until the total reaches 100%



Figure 5-16: Compound screen showing total of 100%

Note: If the total is less than 100%, the percentage box in the top right corner is red and shows the current percentage.

6. Touch the  icon to calculate and set the GSF value.

Note: If you touch the  icon before the total is 100%, an error sounds and the screen returns to the main screen.



Alternatively, to bypass the compound selection method, touch the  icon to display the number pad screen where you can type in a specific GSF value (Figure 5-17). Touch the  icon to set the value.



Figure 5-17: Standard GSF screen

5.10 Configure measurement alarms

5.10.1 Display the Alarms screen



The Alarms screen shows how each of the eight alarms is currently configured. There are options for 0, 2, 4 and eight alarms (*DF310E*) or 0 and 2 alarms (*DF150E*).



Figure 5-18: Alarms screen showing 8 alarms which have been set

Note: During a calibration, an alarm will only be activated if the alarm 'Follow' option is set to yes (section 5.10.2).

5.10.2 Alarm settings

Up to eight separate measurement alarms are available for each sample gas measurement for which the analyzer is configured, and you can configure each alarm to operate in one of the four modes listed in Table 5-9:.

To configure an alarm:

1. Touch an individual alarm icon on the Alarms screen (Figure 5-19).



Figure 5-19: Alarm icons on alarm screen

2. The Alarm setup screen for that particular alarm is displayed.



Figure 5-20: Alarm setup screen

3. Press the required icon to configure the alarm (Table 5-9):

Note: The selected icon is highlighted in blue. For example,  indicates that alarm sound on is selected.

Icon	Description
------	-------------



Alarm type.









Alarms can be set to one of the following alarm types:



Measurement alarm.

An alarm condition is activated when a condition exceeds the limits set in the alarm mode.

Icon	Description
	<p>Flow alarm.</p> <p>An alarm condition will be activated when the sample gas flow drops below 0.1 L/min. The flow alarm only functions if the optional flow switch was ordered with the analyzer.</p>
	<p>Sensor temperature alarm.</p> <p>An alarm condition will be activated when the sensor measurement is higher than 45 °C. If the sensor exceeds 45°C for 30 minutes, the sensor automatically turns off.</p>
	<p>Span reference alarm.</p> <p>The span reference value can be used to monitor the condition of the coulometric sensor versus the performance at the factory. Assign a high and/or low alarm as required.</p>
<p>Alarm mode.</p> <p>In Figure 5-19, Alarms 1 is set to high alarm, Alarm 3 is a low alarm, Alarm 2 and 6 are flow alarms and Alarms 4, 5, 7 and 8 are unconfigured.</p>	
	<p>Unconfigured.</p> <p>The alarm is not used (i.e. an alarm condition will not be activated under any circumstances).</p>
	<p>Low alarm.</p> <p>An alarm condition will be activated when a sample measurement is lower than the preset alarm level.</p>
	<p>High alarm.</p> <p>An alarm condition will be activated when a sample measurement is higher than the preset alarm level.</p>
	<p>Threshold value (for high or low alarms).</p> <p>This is the value of the measurement that will raise the alarm.</p> <p>To set the alarm threshold value, touch the number to the right of the icon. Use the number keypad that displays to type in the threshold value.</p> <p><i>Note: Touch the  icon to delete the last digit typed in.</i></p> <p>Touch the  icon to accept the value or touch the  icon to cancel the entry.</p>

Icon	Description
	<p>Hysteresis value (for high or low alarms) (see section 5.10.3).</p> <p>To set the alarm threshold value, touch the number to the right of the  icon.</p> <p>Use number keypad that displays to type in the threshold value.</p> <p>Touch the  icon to accept the value or touch the  icon to cancel the entry.</p>
<p>Audible alarm.</p> <p>Touch one of the following icons to select the required option:</p> <p><i>Note: The selected option is colored blue.</i></p>	
	<p>The alarm is not audible.</p>
	<p>An audible alarm will sound if the alarm settings are triggered.</p> <p>To silence the alarm, touch the the  icon.</p>
<p>Alarm following.</p> <p>This determines whether alarms will be raised during calibration.</p> <p>Touch one of the icons to select the required option:</p>	
	<p>The alarm is not followed. The alarm will not be seen.</p> <p>This is the default option during calibration.</p>
	<p>The alarm is followed. The alarm will be seen, even during calibration.</p>





Icon	Description
	Alarm latching.
	<p>Alarm latching off.</p> <p>Once the alarm condition has been activated, the alarm condition remains activated only until a subsequent sample measurement which would not trigger the alarm is made. The alarm condition is then deactivated.</p> <p>To unlatch any 'latched' measurement alarm(s), touch the  icon. All latched alarms will be unlatched and the Measurement screen displayed again.</p>
	<p>Alarm latching on.</p> <p>Once the alarm condition has been activated, the alarm condition remains activated (even if subsequent sample measurements would not trigger the alarm) until the alarm is manually unlatched.</p>

Table 5-9: Alarm configuration

- Press the  icon to save the alarm, or the  icon to return to the alarms screen.

Note: On the Home screen, the alarm is displayed as a red line on the bar graph (Figure 5-21).

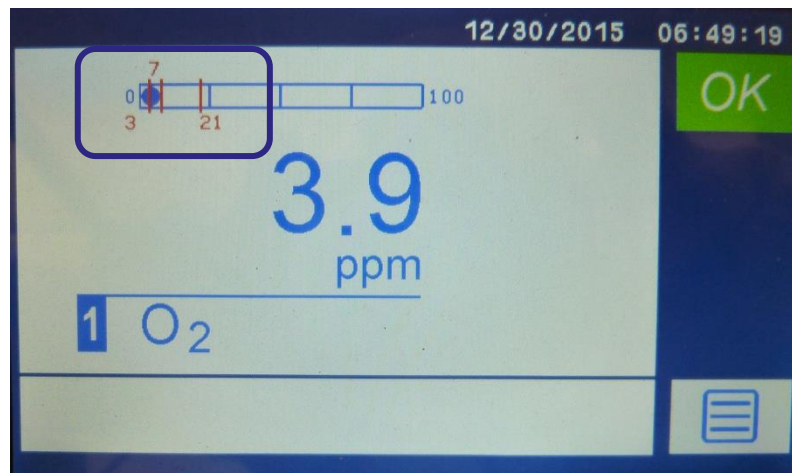

Figure 5-21: Home screen showing alarm settings on the bar graph

- When the alarm has been set, assign the relay for that alarm (section 5.6).
- Repeat this for each alarm required.

5.10.3 Hysteresis levels

The hysteresis level associated with a measurement alarm determines when an alarm condition (once activated) is deactivated, and this depends on the alarm mode, as follows:

Alarm mode	Effect of hysteresis
Low alarm	Once the low alarm condition has been activated, the alarm condition will not be deactivated until a sample measurement is above (alarm level + hysteresis level).
High alarm	Once the high alarm condition has been activated, the alarm condition will not be deactivated until a sample measurement is below (alarm level – hysteresis level).

For example:

- If a 'low' alarm has an alarm level of 15% and a hysteresis level of 1%, the alarm is activated when a sample measurement is < 15%, and the alarm is not deactivated until a sample measurement is > 16%.
- If a 'high' alarm has an alarm level of 3 ppm and a hysteresis level of 1 ppm, the alarm is activated when a sample measurement is 3 ppm, and the alarm is not deactivated until a sample measurement is 2 ppm.

5.10.4 Activated alarms

While a measurement alarm condition is activated:

- The screen changes to flashing red (Figure 5-22).
- The Alarm Status icon appears at the upper right of the screen (1 in Figure 5-22).
- The appropriate alarm relay will be triggered.



Figure 5-22: Measurement alarm condition

To view the details of the activated alarm (1 in Figure 5-23):





Figure 5-23: Alarms screen showing triggered alarm

Hint: Ensure that the measurement alarm and hysteresis levels are not too close to the expected sample measurements. (If they are, minor – and acceptable – variations in your sample gas concentrations will result in spurious alarms.)

Hint: If you configure one measurement alarm as 'low' and configure the other alarm as 'high', ensure that the 'high' alarm and hysteresis levels are higher than the 'low' alarm and hysteresis levels. (If you do not, the analyzer can be permanently in an alarm condition, until you correct the levels.)

5.11 Configure the measurement record option

(DF310E and AquaXact Controller only)

The measurement record option allows the operator to save time-stamped concentration readings as a text file. It is possible to configure two record files if there are two sensors.

Three time intervals are possible: seconds, minutes and hours.



To store a result:

1. Press the clock icon to toggle through the time options until the required time page displays.
2. Type **1** on the numeric pad to select 1 second, 1 minute or 1 hour, depending on the time interval selected.
3. Press the  icon to start the logging.
4. To stop the logging, set the time interval to zero by typing **0** on the numeric pad.
5. The log must be saved onto a memory stick before it can be viewed. Open the analyser door and insert a memory stick into the USB socket on the right hand side of the interior.
6. Navigate to the Diagnostics page and press the USB icon:



A number of system files including the measurement log will be written onto the memory stick.

The measurement log (measurementlog1) is located in config_files/dth03900/measurementlog1:

```
50 27/7/2016 09:34:09
50 27/7/2016 09:44:09
50 27/7/2016 09:54:09
50 27/7/2016 10:04:10
50 27/7/2016 10:14:10
50 27/7/2016 10:24:10
51 27/7/2016 10:34:10
51 27/7/2016 10:44:10
51 27/7/2016 10:54:10
51 27/7/2016 11:04:10
```

Note: Column 1 is the ppm measured value; column 2 is the date; column 3 is the time.

5.12 Setting display / 4-20 mA range

5.12.1 MonoExact DF310E and AquaXact Controller

The 4-20 mA output range is determined by the minimum and maximum range values set using the upper and lower range icons on the Measurement screen (section 4.6).



Any over-range is automatically detected, so for example, if a range of 0-100 is set on a 0-10000 sensor and the reading exceeds 100, the sensor automatically switches to the full range (0-10000) for both the display and 4-20mA output.

5.12.2 MonoExact DF150E



The MonoExact DF150E has three range options that are listed when the range icon is pressed (Figure 5-24):

- 0 – 100 ppm Sensor 0-1, 0-10, 0-100
- 0 – 1000 ppm Sensor 0-10, 0-100, 0-1000
- 0 – 10000 ppm Sensor 0-100, 0-1000, 0-10000

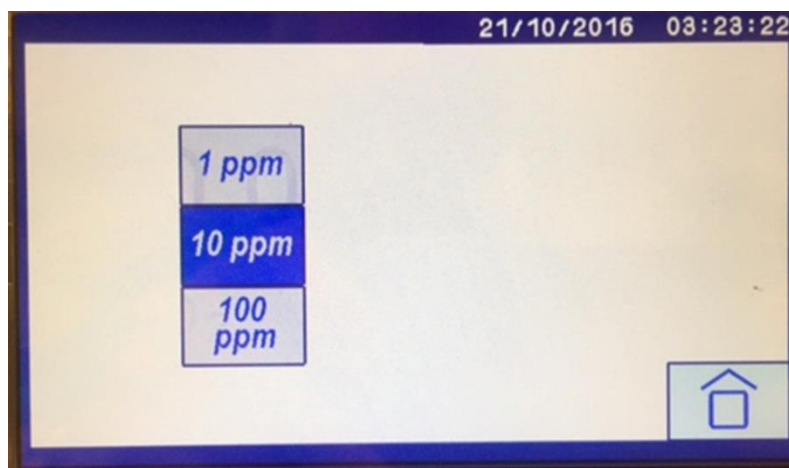

Figure 5-24: DF150E Range screen

6 Sample gas preparation and delivery

The sample gases must be non-flammable, clean, non-corrosive, free from oil and condensates and compatible with the sample wetted materials listed in Appendix B.

You must connect process gas, switch on the electrical supply and leave the analyzer for at least 4 hours before the results will stabilize.

Note: Pay particular attention to the warnings at the start of section 3.

For optimum calibration results, the calibration gas flow rate/pressure should be the same as the flow rate/pressure of the gases to be sampled.

During calibration of O₂ control (paramagnetic) it is good practice to perform a low (Lo) calibration followed by a high (Hi) calibration.

The required frequency of calibration depends on the reliance that you place upon the accuracy and consistency of the measurements made by the analyzer. Adjust the frequency according to your requirements and the drift characteristics of your analyzer.



Sample and calibration gases may be toxic or asphyxiant:

- **Make sure that the external connections are leak free at full operating pressure before you use sample or calibration gases.**
- **Make sure that the sample/bypass outlet pipes are vented to an area where the gases will not be a hazard to people.**
- **Make sure that the analyzer is used in a sufficiently well ventilated environment, to prevent the build-up of toxic gases.**
- **Make sure that the pipes that you connect to the analyzer are routed so that they do not present a hazard to people.**

When you carry out a leak test, do not exceed a maximum pressure of 34.5 kPa gauge (0.35 bar gauge, 5 psig) and do not introduce a sudden change of pressure into the analyzer. If you do, you can damage it.



If you use a liquid to assist in leak testing, do not spill liquid onto the horizontal surfaces of the analyzer or its electrical connections.

7 Calibration



Coulometric measurements are fully calibrated at the factory, and it is not a requirement to calibrate in service, except as suggested by Servomex applications group.

For paramagnetic O₂ percent measurements, it is highly recommended manually calibrate the analyzer when it is first set-up and also whenever ambient conditions change.

During the paramagnetic oxygen calibration, it is good practice to perform a low (Lo) calibration followed by a high (Hi) calibration. However, a single point calibration is often sufficient.

7.1 Manual calibration

Hint: *The required frequency of calibration depends on the reliance that you place upon the accuracy and consistency of the measurements made by the analyzer. Adjust the frequency according to your requirements and the drift characteristics of your analyzer.*

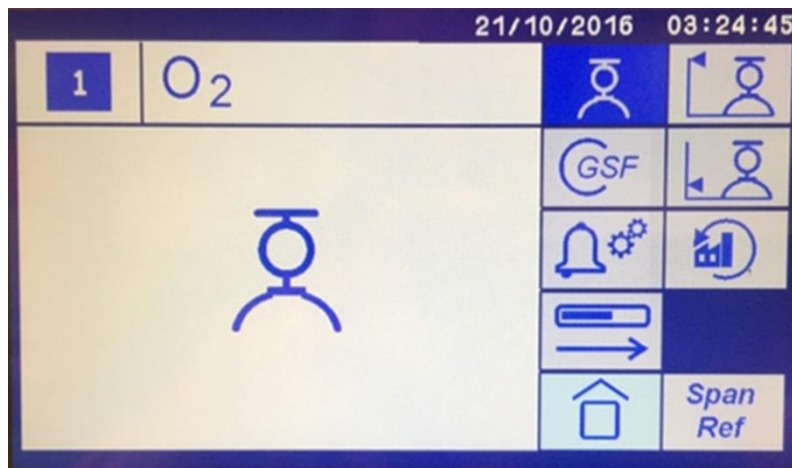







Figure 7-1: Calibration screen

Icon	Description
	Span calibration point.
	Zero calibration point.
	Restore factory calibration.
	Show current span reference value.

To manually calibrate the analyzer:

1. Make sure that your equipment is configured to correctly route your calibration gas supply to the analyzer sample gas inlet.
2. Route the calibration gas and wait 15 minutes. If the display does not change for one minute, touch the icon for the high span measurement  icon.

The screen will display the target value along with the last span value that was used to calibrate. If the target value is not correct for the calibration gas you are using, change the target value to the required value using the numeric keypad (Figure 7-2).

3. Press .



Figure 7-2: Enter the value using the keypad

4. Press the  icon to start the calibration (Figure 7-3).



Figure 7-3: Start calibration

5. Repeat steps 2 to 4 of this section to calibrate the zero point measurement .

Note: To restore the factory calibration settings, press the  icon. Take care as any changes that you have made to the calibration will be lost if you restore the factory calibration.

7.2 Span reference value

The span reference value is a coulometric diagnostic parameter that can be used as a sensor diagnostic.

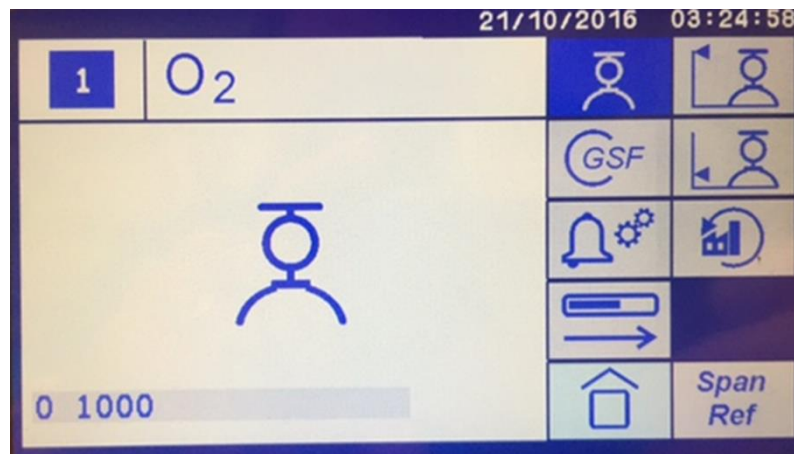

Figure 7-4: Calibration screen showing span reference value

Two numbers appear at the bottom of the screen (Figure 7-4). The second number is the span reference value (in Figure 7-4 the span reference value is 1000, the factory default value).

When the factory calibration is modified in the field, the span reference value is likely to change. Some change is expected because the span gas used in the field will not be identical to the one used in the factory.

However if there is a large change in the span reference value, this indicates that there either a problem with the field calibration or that the coulometric sensor is not operating properly. If the span reference value is below 750 or above 1250, consult the Servomex service group. We have made monitoring the span reference value possible through the alarms setting options.

8 Operation



Sample and calibration gases must be as specified in sections 9.5 and 9.6. If the pressure/flow rates are outside the ranges specified in sections 9.5 and 9.6, you must regulate the gases externally, before they enter the analyzer.

8.1 Check the relay signal outputs

Hint: Relays assigned for gas stream switching will not be energized during the relay test functions as this could cause hazardous gas flows.

8.2 View flow levels

The flow meter is visible via front panel, and is calibrated for use with air / N₂. If the molecular weight of the background gas is much different from N₂, the flowmeter reading is not accurate. The Rotameter type is calibrated for use in air (or N₂). Most other gases have molecular weights within ± 25 percent of air. Since the required flow rate is not extremely critical most gases produces reasonably correct readings. The exceptions are light gases such as Helium and Hydrogen whose flow rates should be set to approximately one-third that of Nitrogen.

8.3 Switch off the analyser

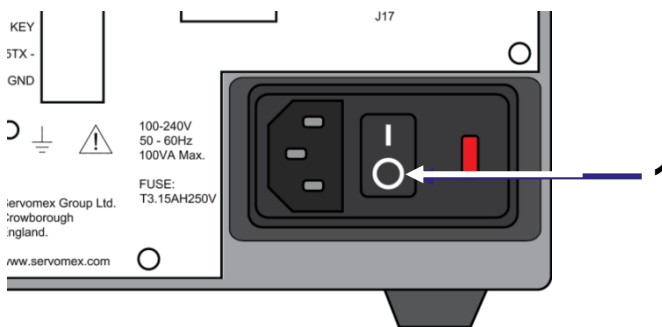

Figure 8-1: On/off switch on the rear of the analyzer

To switch off the analyser, press **O** on the On/Off switch on the rear of the analyzer (1 in Figure 8-1).

After you have switched off the analyzer, when required or as necessary (for example, if you need to carry out plant/factory maintenance and will not use the analyzer for several days):

- Ensure the gas inlet and outlets are blocked off (closed valve or protective caps supplied).
- Disconnect the electrical supply cable from the analyzer.

9 Technical specification



The protection, accuracy, operation and condition of the equipment may be impaired if the analyzer is not installed in accordance with the requirements of this and other sections of the manual.

9.1 Mechanical specification

Dimensions: *(Length x Height x Width)*

Rack mountable analyzer:

Without 19-inch rack mounting brackets: 236 x 193 x 205 mm
9.3 x 7.6 x 8.1 inches

With 19-inch rack mounting brackets fitted: 236 x 266 x 483 mm
8 x 5.2 x 19 inches

Bench mounted analyzer: 240 x 193 x 205 mm
9.5 x 7.6 x 8.1 inches
(including feet and handle)

Mass: < 5 kg

9.2 Electrical specification

Electrical supply:

Voltage: 100 to 240 Vac, 50 to 60 Hz
(± 10% maximum fluctuation)

Supply fuse rating / type: T3.15 AH / 250V. Size 20 x 5 mm

Maximum power consumption: 40 VA

Interface signal relay ratings 30 V (dc or ac) / 1A

Note: The relay output signals are volt-free signals

mA output (active):

Maximum load resistance: 1 kΩ

Isolation voltage (to earth): 500 V (dc or ac)

Output range:

Normal sample measurement: 4 to 20 mA

Fault condition: 0 mA, 2 mA. User selectable
(sections 5.6)

Voltage output (active):

Minimum load resistance: 100 kΩ

Isolation voltage (to earth): 250 V (dc or ac)

Output range:

Normal sample measurement: 0 to 10 V

Fault condition: Fault condition selected as an option at the
time of purchase.

Under range: Not applicable

**Signal / voltage / mA / RS485 output
terminals suitable for:**

Flexible conductors: 0.5 to 1.5 mm² (20 to 16 AWG)

Solid conductors: 0.5 to 1.0 mm² (20 to 18 AWG)

9.3 Maximum voltage ratings

Common mode compared to chassis ground reference:

Signals:	Maximum voltage rating:
I1+, I1-, I2+, I2-, V1+, V1-, V2+, V2-, IIN1+, IIN1-, IIN2+, IIN2-, DIN3A, DIN3B, DIN4A, DIN4B J17(ALL)	250 Vac
All relays C, NC, NO	40 Vac
J6 (ALL)	15 Vdc
J8(ALL)	
J18 (ALL)	

Differential mode between pairs:

Signals:	Maximum voltage rating:
All relays C, NC,NO	30 Vac, dc
IIN1+, IIN- or IIN2+, IIN2-	40 Vdc wrt V1-, V2-
DIN3A, DIN3B or DIN4A, DIN4B	24 Vdc
RS485TX+, RS485TX-	15 Vdc

Signals:	Maximum voltage rating:
RS485RX+, RS485RX-	15 Vdc
RS232TX, RS232RX	15 Vdc
J17 pin to pin	9 Vdc

9.4 Environmental limits

The equipment is suitable for indoor use only.

Ambient temperature range:

Operation: 5 to 45 °C

Storage: 0 to 50 °C

Operating ambient pressure range: 101.3 kPa ± 10% (1.013 bar ± 10%)

Operating ambient humidity range: 10 to 90% RH, non-condensing

Operating altitude range: -500 metres (below sea level) to 2000 metres (above sea level)

Ingress protection: IP20

9.5 Sample gas



The sample gases must be non-flammable, clean, non-corrosive, free from oil and condensates and compatible with the materials listed in Appendix B.

Coulometric transducer (trace O₂)

Flow rate: 300 to 700 ml min⁻¹

Temperature: 5 to 45 °C

Particulate size: < 2 µm (2 micron)

Paramagnetic transducer (% O₂)

Flow rate: 100 to 250 ml min⁻¹

Dewpoint: 5 °C below ambient temperature (minimum)

Temperature: 5 to 45 °C

Particulate size: < 2 µm (2 micron)

Note: The flow rates apply to flow-driven transducers only. On pressure-driven transducers, the sample gas pressure must be in the range 14 to 56 kPa (2 to 8 psig).

9.6 Calibration gas



The calibration gases must be non-flammable, clean, non-corrosive, free from oil and condensates and compatible with the materials listed in Appendix B.



For optimum calibration results, the calibration gas flow rate / pressure should be the same as the flow rate / pressure of the gases to be sampled.

Coulometric O₂ trace transducer calibration gases

High calibration setpoint: 40 to 80% of full scale

Low calibration setpoint: UHP Nitrogen recommended

Paramagnetic O₂ transducer calibration gases

High calibration setpoint: 10 – 25% O₂

Low calibration setpoint: 0 – 15% O₂

Minimum difference: 0.5%

Low calibration tolerance level:

Calibration gas < 5% O₂: ± 0.5% O₂

Calibration gas ≥ 5% O₂: ± 10% O₂

High calibration tolerance level:

Calibration gas < 5% O₂: ± 0.5% O₂

Calibration gas ≥ 5% O₂: ± 10% O₂

Note: If, during a calibration or validation routine, the measurement is outside the specified range, a status message is displayed to indicate that there may be a problem (for example, the wrong calibration gas has been introduced, or the transducer has drifted excessively). The status can be over-ridden but the history will still remain.

9.7 Approvals / classifications

CE: CE for electromagnetic compatibility, accredited laboratory tested and certified.

10 Routine maintenance



The MonoExact DF150E/DF310E and AquaXact 1688 Controller do not contain any user serviceable parts.



Do not attempt to maintain or service the MonoExact DF150E/DF310E and AquaXact 1688 Controller unless you are trained and know what you are doing. The analyzer must be maintained by a suitably skilled and competent person.



Do not open or attempt to remove the analyzer cover yourself. If you do, you will invalidate any warranty on the analyzer, and the analyzer may not operate safely or provide accurate measurements.



Sample and calibration gases may be toxic or asphyxiant.

Never inspect the inlet filter(s), or service or repair the analyzer while such gases are still connected to it.

If the analyzer is to be serviced or repaired it is important that all pipework is flushed with an inert gas and the analyzer is allowed to freely vent to local atmosphere.



Do not store replacement tips for more than 12 months before use to assure the calibration is still valid.

10.1 Cleaning the analyzer

When necessary, use a damp (but not wet) cloth to wipe clean the outer surfaces of the analyzer (to prevent the entry of dust or other particulates into the interior of the analyzer).

10.2 Routine checks

The MonoExact DF150E/DF310E and AquaXact 1688 Controller contain no moving parts. The coulometric transducers require electrolyte maintenance as described in section C.3.

You only need to carry out simple maintenance procedures annually. Carry out the following regular checks to ensure continuous and safe operation of the monitor.

10.2.1 Inspect / replace the fuse



Ensure that the electrical supply is isolated / locked-out from the analyzer. If you do not, there will be a danger of injury or death from electric shock.



Fire Hazard: Only use the same type and rated fuse as recommended.

If you think that an electrical supply fuse has failed, use the following procedure to inspect the fuses and replace them if necessary:

1. Open the fuse panel on the rear of the analyzer (Figure 10-1). To do this, carefully insert a small screwdriver into the gap on the right of the panel and press the clip to open the panel.



Figure 10-1: Open the fuse panel



Figure 10-2: Fuse panel opened

2. Pull the red fuse holder out of the panel (Figure 10-3).
Both live and neutral lines have fuse protection. The neutral fuse is shown (1 in Figure 10-3); the live fuse is located in the underside of the red fuse holder (2 in Figure 10-3).

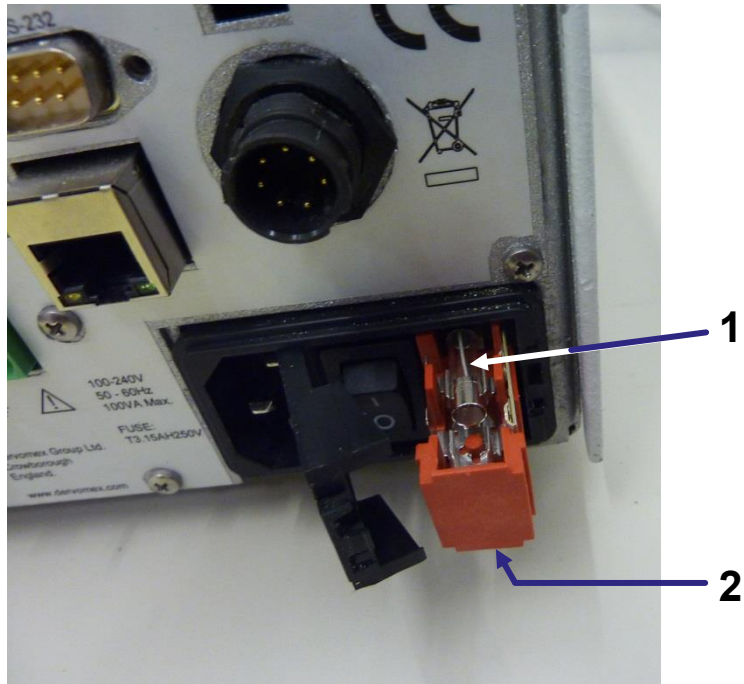

Figure 10-3: Pull out the red fuse holder

3. Remove the top (neutral) fuse from the holder and check the continuity across the fuse.

If there is continuity, the fuse has not failed, so refit it into the fuse holder.

If there is no continuity, fit a new fuse into the fuse holder.



Make sure the fuses are the correct type and rating. The fuse type and rating is shown on the rear panel to the left of the mains connector.



Make sure you fit the fuse in the correct position in the fuse holder as shown in Figure 10-3.

4. Repeat step 3 for the bottom (live) fuse which is located on the underside of the red fuse holder.
5. Push the fuse holder back into the fuse panel and close the panel door. It will click into place.

10.3 Preventative maintenance

To minimise unscheduled analyzer downtime, ensure the proper operation of the analyzer and to comply with the guidelines of applicable regulatory bodies, we recommend that you utilise an annual preventative maintenance program for your analyzer.

The preventative maintenance program consists of an annual inspection of the analyzer, and repair of any faults, to ensure that the analyzer meets its original factory specification.

Contact Servomex or your local Servomex agent to arrange for a preventative maintenance contract.

11 Troubleshooting

The following section will help to resolve many of the common operational situations that occur with the analyser. Try the possible remedies in the order listed.

11.1 Coulometric sample system leak test (Low flow sensitivity)

By far the most common reason for high Oxygen readings is a leak in the sample delivery system. Leaks are divided into two types:

- Real leaks A real leak is a lack of integrity in the sample delivery system.

- Virtual leaks A virtual leak is caused by Oxygen that is trapped in the upstream plumbing and components, such as regulators and filters. This Oxygen is slowly being purged out of the system.
Virtual leaks are most common in new installations.

Determining the nature of the leak is not a difficult task, but it is important to be consistent in the approach and technique. The steps listed below will help resolve any leak related problems:

1. Determine if the high reading is due to a leak or is a real indication of Oxygen level. To do this, perform a Flow Sensitivity Test. This test requires a positive pressure sample delivery system. If it is not possible to provide positive sample pressure to the analyzer, skip to Step 2.

Note: If the analyzer is equipped with a pump, it is recommended that it is not used during the Flow Sensitivity Test.

Perform the Flow Sensitivity Test as follows:

- a. Establish a flow rate that is within the normal operating tolerances of the analyzer. Generally a flow rate between 0.5 LPM or 1.0 SCFH is ideal.
- b. Give the analyzer a couple of minutes to stabilize, and then carefully note the flow rate and the Oxygen level displayed.
- c. Reduce the flow rate by 75%. In a system with good integrity, there should be little change in the front panel display. If a leak exists however, the reading will rise noticeably. Allow it time to stabilize, and carefully note the flow rate and the Oxygen level displayed.
- d. Re-establish a normal flow rate and allow the analyzer to purge for ½ hour. Note again the flow rate and Oxygen level displayed.
- e. Repeat step c. If the Oxygen level stabilizes at a level that is close to the prior value from step c, then the leak is real. If the reading shows a lower

Oxygen level than the prior value from step c, the leak is probably a virtual leak and continued purging should rectify the problem.

2. Once it has been determined that there is a leak, the next logical step is to locate it. The easiest way to locate a leak is to close off the feed to the analyzer from the sample delivery system, and to allow the system to pressurize. Apply Snoop[®] or another type of liquid leak detector to all of the fittings on the system. Any fitting that shows bubbles should be tightened or replaced.
3. If it is not practical to remove the analyzer from the sample delivery system, leaks can be located by monitoring analyzer output while applying Snoop[®] or another liquid leak detector to one fitting at a time. Snoop[®] will not show bubbles at the low pressure required for proper analyzer operation. However, Snoop[®] will temporarily block any leak, at the fitting being checked, and the analyzer output will drop. It is important to give sufficient time for the analyzer to respond before going on to the next fitting. The more distance between the fitting and the analyzer, the more time should be given for the analyzer to respond.

11.2 Error codes

The following codes may be displayed in the event of a problem or error. The table gives a suitable remedy.

Code	Meaning	Possible remedy
C: COMMS fault	Data not received from sensor	Check sensor cable
L: Low Fluid	Coulometric sensor fluid is low	Add replenishing solution
T: Overtemp	Sensor temperature is over range	Reduce ambient temperature
E: Out of Spec	The reading exceeds the maximum range	Check plumbing

12 Storage and disposal

12.1 Storage

Refit any protective plastic covers (section 2) and place the analyzer and any associated equipment in its original packaging before storage. Alternatively, seal it inside a waterproof plastic bag, sack, or storage box.

Store the analyzer and any associated equipment in a clean, dry area. Do not subject it to excessively hot, cold, or humid conditions (section 9.3).

12.2 Disposal

Dispose of the analyzer and any associated equipment safely, and in accordance with all of your local and national safety and environmental requirements.

Hint: If you send the analyzer to Servomex or your local Servomex agent for disposal, it must be accompanied by a correctly completed decontamination certificate and a Return Authorization Number (RAN) (Appendix J).

12.2.1 Disposal in accordance with the Waste Electrical and Electronic Equipment (WEEE) Directive

The label shown in Figure 12-1 is fitted to the analyzer.



Figure 12-1: The WEEE label

This label identifies that:

- The analyzer is considered to be within the scope of the Waste Electrical and Electronic Equipment (WEEE).
- The analyzer is not intended for disposal in a municipal waste stream (such as landfill sites, domestic recycling centers and so on), but must be submitted for material recovery and recycling in accordance with the local regulations which implement the WEEE Directive.

For additional information and advice on the disposal of the analyzer in accordance with the requirements of the WEEE Directive, contact Servomex or your local Servomex agent.

13 Spares



Do not use spares other than those specified below, and do not attempt to carry out any maintenance procedures other than those specified in this manual. If you do, you can damage the analyzer and invalidate any warranty.

The standard spares available for the analyzer are shown below. You can order these spares from Servomex or your Servomex agent.

Part number	Description
PCB Assemblies:	
S08000901	PCB Assembly, Back Plane Interface 08000
S08000902	PCB Assembly, Display Board 08000
S08000903	PCB Assembly, Option Board 08000
S08000904	PCB Assembly, 310 Connector Board 08000
S08000905	PCB Assembly, 150 Connector Board 08000
Power:	
S220268	AC/DC Converter 24V 30W Phoenix 2902991
211133	Fuse,3.15A,SB,5X20,2183.15XP,LITTELFUSE
All transducers:	
S03900711	Coulometric O ₂ 100 ppm High Resolution
S03900712	Coulometric O ₂ 100 ppm
S03900713	Coulometric O ₂ 1000 ppm
S03900714	Coulometric O ₂ 10000 ppm

Part number	Description
General:	
220562	USB, Clip Flashdrive 2GB
210397	Sensor Cap – Blue
210513	Hummingbird Brand Replenishment Solution – 1.0l
210514	Hummingbird Brand Replenishment Solution – 0.5l
210515	Hummingbird Brand Replenishment Solution – 100ml
210516	Hummingbird Brand Replenishment Solution – 2.0l

14 Warranty

Servomex instruments are warranted to be free from defects in workmanship and materials. Liability under this warranty is limited to servicing, calibrating, and replacing any defective parts of the instrument returned to the factory for that purpose. Fuses are specifically excluded from any liability.

This warranty is effective from the date of delivery to the original purchaser. The equipment must be determined by Servomex to have been defective for the warranty to be valid.

This warranty applies as follows:

- one year for electronics
- one year for mechanical failures to the sensor

If damage is determined to have been caused by misuse or abnormal conditions of operation, the owner will be notified and repairs will be billed at standard rates after approval.

Servomex Group Limited warrants each instrument manufactured by them to be free from defects in material and workmanship at the F.O.B. point specified in the order, its liability under this warranty being limited to repairing or replacing, at the Seller's option, items which are returned to it prepaid within one year from delivery to the carrier and found, to the Seller's satisfaction, to have been so defective.

In addition, if the coulometric oxygen sensor in this analyzer fails under normal use within five years from the date of purchase, such sensor may be returned to the Seller and, if such sensor is determined by the Seller to be defective, the Seller shall provide the Buyer a repaired or replacement sensor at no additional cost. The original warranty expiration date is not extended by this action. Customer induced failures including but not limited to over pressuring, electrolyte spills and over temperature are not covered.

In no event shall the Seller be liable for consequential damages. NO PRODUCT IS WARRANTED AS BEING FIT FOR A PARTICULAR PURPOSE AND THERE IS NO WARRANTY OF MERCHANTABILITY.

Additionally, this warranty applies only if: (i) the items are used solely under the operating conditions and in the manner recommended in the Seller's instruction manual, specifications, or other literature; (ii) the items have not been misused or abused in any manner or repairs attempted thereon; (iii) written notice of the failure within the warranty period is forwarded to the Seller and the directions received for properly identifying items returned under warranty are followed; and (iv) with return, notice authorizes the Seller to examine and disassemble returned products to the extent the Seller deems necessary to ascertain the cause of failure. The warranties stated herein are exclusive. THERE ARE NO OTHER WARRANTIES, EITHER EXPRESSED OR IMPLIED, BEYOND THOSE SET FORTH HEREIN, and the Seller does not assume any other obligation or liability in connection with the sale or use of said products.

14.1 Maintenance policy

In cases when equipment fault is suspected, please notify your representative of the problem and provide them with model and serial numbers.

If the problem cannot be resolved, then ask for a Return Authorization Number (RAN) and shipping instructions. The issue of an RAN does not automatically imply that the equipment is covered by our warranty - that will be determined after we receive the equipment.

Pack the equipment in a suitable box with sufficient padding, include the RAN number on your paperwork, and send the equipment, prepaid, to the designated address. Servomex will not accept equipment returned without a RAN, or with reversed shipping or import/export charges.

If the warranty has expired, or the damage is due to improper use or exposure of the equipment, Servomex will provide an estimate and wait for approval before commencing repairs.

For your convenience a Return Authorization Request Form is provided in Appendix J. Fill out the form and sent it back to Servomex to obtain a RAN.

Appendix A Options for RS485 / RS232

MonoExact DF310E and AquaXact Controller only.

A.1 Introduction

The MonoExact DF310E has options for RS232 or RS485 serial communications. If RS232 is purchased, the connection is via the 9-pin D-type serial connector (J18) on the back plane. If RS485 is purchased, the connection is via connector J16 on the back plane.



Make sure that the electrical installation of any equipment connected to the analyzer conforms with all applicable local and national electrical safety requirements.



The RS232 output is separated from the analyzer mains circuits by reinforced insulation. The terminals must only be connected to circuits that are themselves separated from mains voltages by at least reinforced insulation.



To comply with EMC requirements, you must use a screened cable to connect to the RS232 output. The screen must also be connected to the analyzer enclosure.

A.2 Connections

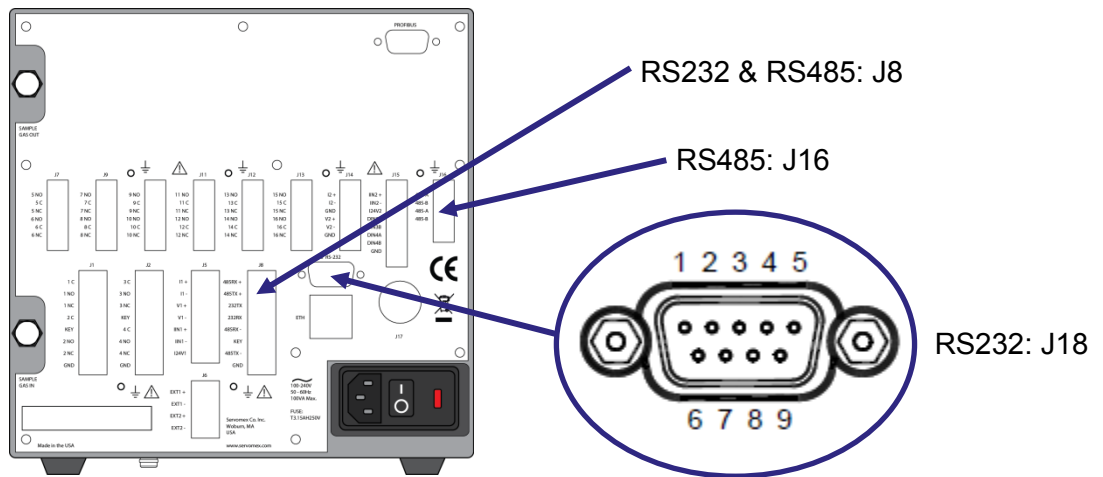

Figure A-1: Rear panel of the analyzer showing RS232 and RS485 connectors

Pin	Use	Pin	Use
1	485-A	3	485-A
2	485-B	4	485-B

Table A-1: RS485 connection pin details (J16)

Pin	Use	Pin	Use
1	Not used	4	Not used
2	Rx (to the analyzer)	5	0 V
3	Tx (from the analyzer)	6, 7, 8, 9	Not used

Table A-2: RS232 connection pin details (J18)

Note: RS232 and RS485 connections are also available on J8:

Pin	Use	Pin	Use
1	485RX+	5	485RX-
2	485TX+	6	KEY
3	232TX	7	485TX-
4	232RX	8	GND

Table A-3: Connector J8



A.3 Set up parameters



Figure A-2: Serial parameter setup page

The serial parameter icons are listed below:

Icon	Meaning	Function
	RS232 communications	To select RS232.

Icon	Meaning	Function
	RS485 communications	To select RS485.
	Full Duplex	To select full duplex.
	Half Duplex	To select half duplex.
	1 stop bit	To set 1 stop bit.
	2 stop bits	To set 2 stop bits.
	Baud rate	To set the baud rate.
	Parity	To set the parity.
	RS485 function	To assign RS485 function.
	RS485 function: DF communications	To assign RS485 function to legacy DF communications.
	RS485 function : None	No RS485 function.
	RS485 function: Modbus	To assign RS485 function to Modbus (Appendix H).
	RS485 – Modbus: Word swapping on	To switch on Modbus word swapping.
	RS485 – Modbus: Word swapping off	To switch off Modbus word swapping.

A.4 Connecting the analyzer to a PC

The analyzer can be directly connected to the 9-way 'D' type serial port (usually designated "COM1" or "COM2") on your PC.

Use a compatible 9-way 'D Null Modem' cable (with a recommended maximum length of 3 meters), with female-to-female connectors. To prevent the cable coming loose at the analyzer ensure the connector screws are tightened (if supplied on the cable).

If your PC only has USB serial ports, use a commercially available 9-way 'D' type serial to USB converter to connect the PC.

Appendix B Sample wetted materials

The materials of the parts of the analyzer in contact with the sample and calibration gases are listed below. These materials have a wide range of chemical compatibility and corrosion resistance.

Paramagnetic O₂ % measurement	Coulometric O₂ trace measurement
303 stainless steel	Stainless Steel
Viton	G10 epoxy
Polypropylene	Carbon/Teflon composite
PPS with carbon fibre filler *	Paraffin wax
PPS *	1M aqueous potassium hydroxide
Borosilicate glass *	Delrin
Polysulphone	EPDM O-ring
316 stainless steel	Borosilicate glass
Platinum	Cellulose, if filter ordered for both sensors
Platinum / iridium alloy	Titanium (standard, no pump)
Electroless nickel	Duraluminum (pump option only)
10% glass filled polyetherimide(ultem)	
RTV silicone	Rotameter flow meter
Epoxy	Borosilicate glass
Silgel (silicone)	316 and 303 Stainless steel
Gold	Duralumin
Silicon	Delrin
	EPDM O-ring
	Flow switch
	Acrylic
	Stainless steel
	Loctite 565 thread sealant

* with optional filter

Appendix C Coulometric O₂ transducers

C.1 Theory of operation

The Servomex Coulometric Sensor uses an ambient temperature oxygen reaction that is non-depleting. The cell produces a current flow that is determined by the number of oxygen molecules that are reduced at the cathode. The sensor reaction is driven by 1.3 V applied across the electrodes. The resulting electron flow is measured as a current that is precisely proportional to the oxygen concentration in the sample gas.

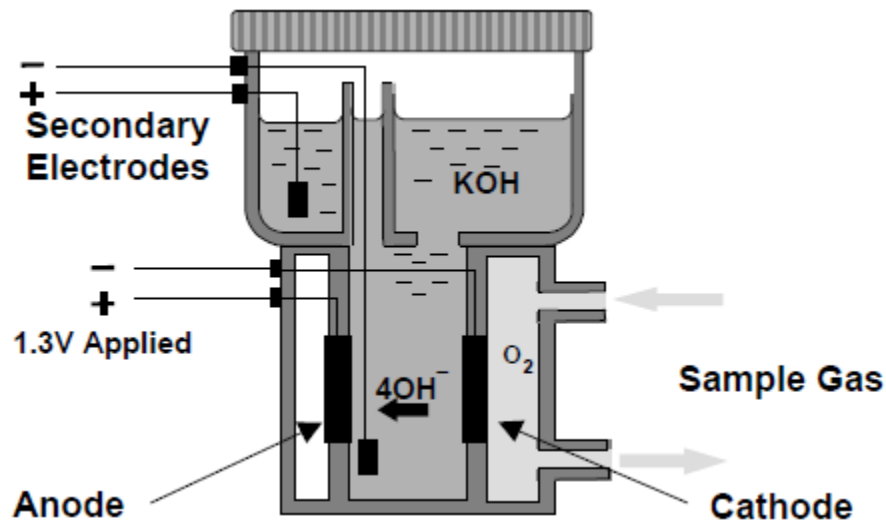
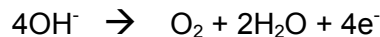

Figure C-1: Servomex Oxygen sensor schematic

The cathode reaction uses 4 electrons from the 1.3 volt circuit, 2 water molecules from the electrolyte, and 1 oxygen molecule from the sample gas to generate 4 hydroxyl ions which migrate across the reaction chamber to the anode:



The anode reaction consumes the 4 hydroxyl ions and delivers 4 electrons to the circuit, 2 water molecules back to the electrolyte, and vents one oxygen molecule.



There is no net change to the electrolyte and no depletion of the sensor or electrodes.

C.2 Sample gas preparation and delivery

C.2.1 Measurements of acid containing gases

The MonoExact DF150E and DF310E are compatible with inert and passive gases, including N₂, H₂, CO, Ar, freons, hydrocarbons, etc. It also has limited tolerance to gas compositions containing 'acid' gases such as CO₂, H₂S, Cl₂, NOx, SO₂, HCl, etc.

As a guide, the data in Table C-1 represents the maximum allowable limits of acid gases under continuous operation that can be tolerated with the analyzer.

Measuring Range Of Analyzer	CO ₂ * %	SO ₂ ppm	H ₂ S ppm	NOX ppm	Cl ₂ ppm	HCL ppm
0-100 ppm	0.2	200	200	200	100	100
0-1000 ppm	0.4	500	500	500	200	200
0-10,000 ppm	0.8	1500	1500	1500	800	800

* Concentrations of CO₂ are in %. 1% is equivalent to 10,000 ppm.

Table C-1: Maximum allowable acid gas limits

Contact the local Servomex Business Center for recommendations on using the MonoExact DF150E and DF310E sensor on acid gases other than those listed above.

The limits shown in Table C-1 represent guidelines for continuous exposure. In most cases, substantially higher acid gas levels can be tolerated on a limited duty cycle basis. For example, a 0-100 ppm sensor can be used to sample a 100% CO₂ background gas for a 15 minute period 3-4 times per week, and the balance of the time sampling from a clean gas like N₂, Ar, H₂, etc. In general, a good guideline is to limit the exposure and not exceed the continuous limits if the total exposure is averaged over a weekly period. Consult with Servomex for details.

There are applications where the acid gas components may exceed the upper limits on a continuous basis. In such circumstances a sample dilution system can easily be fabricated to mix clean N₂ with the sample gas in a 2:1 to 20:1 ratio using simple pressure control and flowmeter components. Depending upon the continuous acid gas level and the oxygen level to be measured, a dilution ratio must be selected such that the resulting O₂ level is accurately measurable and at least one order of magnitude above the O₂ level in the N₂ dilution gas. Contact the local Servomex Business Center for specific recommendations.

Another approach when acid gas levels are continuously above the recommended limits is the use of a scrubber system. The scrubber will remove the bulk of the acid gases, allowing the analyzer to provide continuous stable measurements. If a breakthrough occurs, the sensor's ability to tolerate high levels of acid gas for limited periods of time will avoid catastrophic loss of performance.

Servomex offers a broad range of scrubbers for applications in severe environments. Standard scrubber columns are available in various sizes, and in single or dual bed configurations. The columns are fabricated from clear PVC and are designed to accept a variety of different acid gas absorbent media which have a color-change indication to facilitate convenient change-out. For more information, contact the local Servomex Business Center.

C.2.2 Coulometric Sample Gas Scale Factor (GSF)

The MonoExact DF150E and DF310E oxygen analyzers are calibrated using oxygen in nitrogen standards. The GSF (Gas Scale Factor) is used to correct for changes in the rate of oxygen diffusion when background gases other than nitrogen are present in the process or sample gas.

In many applications, the sample GSF does not need to be altered from the default value of 1.00. However, if the sample gas has a significantly different diffusivity compared with nitrogen (such as helium or hydrogen), the GSF should be applied. To use the GSF feature, the volumetric percentages of the sample gas are entered as described in section 5.9.2 and the total GSF is automatically calculated by the analyzer.

The software in the analyzer supports gases listed below:

Ammonia	NH ₃	Ethane	C ₂ H ₆	Hydrogen	H ₂
Argon	Ar	Ethylene	C ₂ H ₄	Methane	CH ₄
Butane	C ₄ H ₁₀	Helium	He	Nitrogen	N ₂
Carbon Monoxide	CO	Hexane	C ₆ H ₁₄	Propylene	C ₃ H ₆

Note: Contact the local Servomex Business Center for assistance with gases not listed.

Hint: *The method used to correct the calibration of the analyzer for measurement in non-nitrogen background gases is derived from a well-known theoretical mass transfer equation. This equation accounts for the change in oxygen diffusion rates through different gases.*

Although significant empirical work has been done in this field, it is generally accepted that the equation may be only 85-90 percent accurate. In addition, there is further error introduced when correcting for a 'multi' component background gas. This may result in up to an additional 3-5% error.

An alternate method when using a non-nitrogen or 'multi' component background gas for spanning is to obtain a certified Calibration standard that has been prepared in a background gas that models the average process sample. Care must still be used, however, as certified standards may also have an inaccuracy associated with them.

Questions regarding the calculation of a background gas correction factor for a specific application should be directed to the local Servomex Business Center.

GSF Values for Various Gases

Example Calculation: 60% Nitrogen and 40% Helium 0-100ppm analyzer

$$\text{GSF} = (0.6 \times 1) + (0.4 \times 0.69)$$

$$\text{GSF} = 0.88$$

Note: The GSF for the gas used to calibrate the system may be different from that used during analysis. If the GSF is changed to reflect the composition of the calibrating gas, be sure to reset the GSF before analyzing samples.

Name	Formula	100PPM	1000 PPM	10,000 PPM
1-Chloro-1,2,2,2-tetrafluoroethane (R124)	C2HClF4	2.17	2.76	2.47
Acetylene	C2H2	1.05	1.08	1.06
Argon	Ar	1.03	1.05	1.04
Butadiene	C4H6	1.41	1.61	1.51
Butane	C4H10	1.48	1.72	1.60
Butene	C4H8	1.46	1.69	1.58
Carbon Monoxide	CO	1.01	1.02	1.01
Chloro-1-Difluoro-1,1-ethane (R142B)	C2H3ClF2	1.53	1.79	1.66
ChloroDifluoromethane Freon 22	ChClF2	1.68	2.02	1.85
Chloropentafluoroethane (R115)	C2F5Cl	1.99	2.49	2.24
chlorotrifluoromethane Freon (R13)	CCLF3	1.76	2.14	1.95
Cyclohexane	C6H12	1.57	1.86	1.71
Cyclopropane	C3H6	1.26	1.38	1.32
Difluoro-1,1-ethylene (R1132A)	F2C=CH2	1.36	1.53	1.44
Ethane	C2H6	1.15	1.23	1.19
Ethylene	C2H4	1.10	1.15	1.12
Halocarbon 32- Difluoremethane	CH2F2	1.48	1.72	1.60
HaloCarbons 116	C2F6	2.20	2.80	2.50
HaloCarbons 125	C2HF5	2.10	2.65	2.38
HaloCarbons 218	C3F8	2.58	3.37	2.97
HaloCarbons 23	CHF3	1.69	2.04	1.87
HaloCarbons 41	CH3F	1.26	1.38	1.32
Helium	He	0.69	0.53	0.61
Hexafluoro 1,3 Butadiene	C4F6	2.44	3.15	2.80
Hexafluoropropylene (R1216)	C3F6	2.15	2.72	2.44
Hexane	C6H14	1.75	2.13	1.94
Hexene	C6H12	1.71	2.06	1.88
Hydrogen	H2	0.61	0.42	0.51
IsoButane	C4H10	1.50	1.75	1.62
Krypton	Kr	1.21	1.32	1.26
Methane	CH4	0.94	0.90	0.92
Monochloropentafluoroethane (CFC-115)	C2F5Cl	1.99	2.49	2.24
Neon	Ne	0.85	0.78	0.81
Nitrogen	N2	1.00	1.00	1.00
Nitrous Oxide	N2O	1.26	1.38	1.32
Octafluorocyclobutane C-318	C4F8	2.25	2.88	2.57
Propane	C3H8	1.26	1.38	1.32
Propylene	C3H6	1.28	1.42	1.35
Sulfur Hexafluoride	SF6	1.84	2.27	2.06
Tetrafluoroethane - Halocarbons 134A	C2H2F4	1.99	2.49	2.24
Tetrafluormethane	CF4	1.61	1.91	1.76
Tetrafluoroethylene (TFE) (R1114)	C2F4	1.83	2.24	2.03
VinylChloride	CH2=CHCl	1.36	1.53	1.44
Vinylidene Fluoride	C2H2F2	1.30	1.44	1.37
Xenon	Xe	1.44	1.65	1.54

C.2.4 Sample flow rate and pressure

The analyzer is factory calibrated at a flow rate of 1.0 scfh, in N₂, and should be operated at that level for optimal accuracy. However, the Servomex Sensor is relatively unaffected by gas sample flow rate, within limits. Sample flow rate should be maintained within the recommended range of 1.0 to 2.0 scfh. The analyzer can be operated at flow rates outside that range, but it should be recalibrated at that different flow rate to maintain optimal accuracy.

The analyzer has a small pressure drop (0.2 to 0.5 psi), so relatively small changes in inlet or outlet pressure causes dramatic changes in flow rate. Consequently, it is preferable to vent the outlet to atmosphere so that outlet pressure remains constant, leaving inlet pressure as the only variable to control.

Flow rate effects on sensor performance

Assuming a leak-tight system, higher flow rates may cause O₂ readings to increase by a few percent of reading above the level that would be displayed if flow was within the recommended 1.0 to 2.0 scfh range. Lower flow rates similarly cause O₂ readings to decrease by a few percent of reading. Very low flow rates (below 0.5 scfh) should be avoided as the sample inside of the sensor is no longer representative of the actual sample.

The insensitivity to flow rate changes is the basis for the sample system leak detection described below. The sensor output should be fairly constant for readings between 1.0 and 2.0 scfh. If O₂ readings become higher at lower flows, then ambient O₂ is leaking into the sample system, or venting from a dead space (closed pocket with trapped higher O₂ level gas) in the sample system. A higher flow rate dilutes the O₂ entering the sample system decreasing the reading. O₂ readings in a leak free sample system should not go up or down significantly with flow changes between 0.5 and 2.0 scfh.

Checking for plumbing leaks using flow rate effects

Significant measurement error can be caused by leaks in the plumbing system. A simple test can be performed to identify oxygen intrusion leaks. Observe the analyzer readout at two flow levels: 0.5 and 2.0 scfh. Only a slight increase, if any, in readout will occur in a tight system as the flow is increased. If leakage in the plumbing system exists, then the increased flow results in a substantial decrease in oxygen readout -- typically dropping by 25 to 50 percent.

When flow sensitivity is observed, check the plumbing system for leaks. Once proficient with this test, the user can estimate the distance to the leak based on the response time of the reading changes.

Background gas effects on Indicated flow rate

If the molecular weight of the background gas is much different from N₂, the flowmeter reading is not accurate. The Rotameter type is calibrated for use in air (or N₂). Most other gases have molecular weights within ± 25 percent of air. Since the required flow rate is not

extremely critical most gases produces reasonably correct readings. The exceptions are light gases such as Helium and Hydrogen whose flow rates should be set to approximately one-third that of Nitrogen or 0.3 scfh.

Regulator requirements

If the pressure in the sample line varies, but does not drop below 2.0 psig, use a regulator to drop the pressure to approximately 1.0 psig. Set final flow rate with the sensor flow control valve.

If a regulator is not used, the flow rate changes when the pressure at the inlet of the flow control valve changes. As long as this pressure variation does not bring the flow rate out of the recommended flow range (1.0 - 2.0 scfh) no regulator is required. A flow change of ± 1.0 scfh may result in a small change to the oxygen reading.

If a pressure change causes the flow rate to move outside the recommended range, an adjustment of the flow control valve must be made. If the adjustment is not made, and the flow rate remains outside the recommended range, the analyzer may not be operating within its stated accuracy.

Pressure regulator purge

Regulators used on bottled calibration standards are typically equipped with two pressure gauges, one to measure the cylinder pressure, and the other to measure the outlet pressure. The regulator must have a metal (preferably stainless steel) diaphragm. It is good practice to install a flow control valve to adjust the flow after the regulator.

All user-added upstream plumbing should be consistent with the instrument gas delivery components so that the highest level of integrity can be maintained. All connections should be welded or include metal face-seal components.

Pressure gauges are not recommended on regulators used on process sample lines because they add measurement delay time and offer opportunities for leaks.

Before connecting the gas to the analyzer, follow the regulator purge procedure on page 102 to purge ambient air from the regulator. This ensures that any ambient air trapped in the pressure gauges and cavities of the regulator is purged prior to use. Once the regulator is mounted, do not remove it from the cylinder until a fresh cylinder is required.

Pressure effects on sensor performance

If the analyzer is not vented to atmosphere, the sensor pressure is influenced by the conditions downstream of the analyzer. A recalibration under your operating conditions may be desirable to remain within the stated accuracy specifications. However, in most cases the error introduced is relatively small, and may not affect the process application.

Hint: *It is not recommended that gauges be installed upstream of the analyzer. The presence of a gauge increases response times and introduces potential leaks to ambient.*

Sample gas line lengths, fittings and bends should be kept to a minimum to maintain low pressure drops. Larger diameter tubing and fittings reduce pressure drop and also lengthen response time. In general, 1/8-inch tubing should be limited to 15-foot runs; longer runs should be made with 1/4-inch tubing.

Sample outlet back-pressure effects

It is always recommended to vent the analyzer to atmospheric pressure. However, if a sample vent or return line is used, attention must be given to maintain a low and consistent backpressure so as not to affect the flow rate. The allowable back-pressure on the sensor is ± 1 psig. If variations in the vent line pressure are expected, a sub-atmospheric back-pressure regulator should be installed on the vent line to maintain an even back-pressure on the analyzer.

Consider the regulator's pressure drop (typically 1 psi) when designing the sample vent system in order to stay within the ± 1 psig pressure limits at the sensor.

When not venting the analyzer to atmosphere, it is also suggested to install a fairly high resolution pressure gauge immediately at the analyzer outlet.

Hint: *If a regulator or gauge is installed on the analyzer outlet, also install the Stainless Steel Downstream Plumbing option.*

C.2.4 Sample gas compatibility

Note: There are a wide range of considerations in determining the gas sample compatibility of the Process Oxygen Analyzer. Servomex attempts to identify all pertinent application details prior to quoting and order processing. All non-typical applications concerning gas sample compatibility must be reviewed by our in-house Application Engineers. It is impossible to accurately predict all of the chemical tolerances under the variety of process gases and process conditions that exist.

Condensation

The analyzer should be installed and operated with a sample gas that is preconditioned (if necessary) to avoid condensation in the gas lines. Several methods are available to minimize the possibility of condensation. If the sample gas is a hydrocarbon, maintain the gas temperature 20° F to 40° F above its dew point. In some applications, it may be necessary to chill the sample gas before it enters the analyzer so that the hydrocarbons can be condensed, collected, and removed. It is good practice to pitch the sample gas lines to allow condensables to drain away from the analyzer. Gas sample delivery lines that contain sample gases with high moisture content must not be exposed to temperatures below the dew point.

Gas solubility in aqueous KOH solution

Some sample gas constituents are soluble in the sensor's potassium hydroxide (KOH) electrolyte. Gases that are rated as 'Soluble' to 'Infinitely-Soluble' may pose a threat to the sensor.

The sensor should have limited exposure (less than 1% by volume on a continuous basis) to highly water soluble alcohols, such as methanol, and/or be supplemented with periodic electrolyte changes to limit build-up within the electrolyte.

Many gas species with infinite solubility in aqueous KOH (such as nitrous oxide (N₂O)), however, do not affect the electrode or sealing materials, or interfere with the O₂ reduction/oxidation reactions. Contact the local Servomex Business Center for recommendations on a specific application.

Reactivity with KOH electrolyte

Many process sample streams contain various concentrations of acid gases. Acid gases are gases that react with the basic KOH electrolyte solution to form a neutralized solution. The sensor does not operate properly when the electrolyte solution is neutralized.

Besides a neutralization of the electrolyte, a base reactive sample gas may have other negative effects, such as a base-catalyzed polymerization reaction. The O₂ electrode reaction sites may become blocked by the polymerized byproduct residue at the interface where the gas sample meets the electrolyte.

Flammable sample gas

There is nothing within the analyzer sample system that can ignite a flammable sample gas. However, it is critical to ensure that the sample gas does not escape from the sample system into the analyzer enclosure, or the room, where ignition is possible. Stainless steel plumbing should be used throughout the entire sample system if the sample gas is flammable. There is no viable way to purge the analyzer itself however the entire analyzer can be mounted in a purged enclosure, so that any sample gas that escapes the plumbing is diluted.

Trace acids in the sample gas

With the Servomex Acid Gas system, oxygen measurements in sample gases containing certain levels of acids are possible. Trace acids are common byproducts of gas distribution system assembly and its accessories. Trace acids can compromise the accuracy of the sensor and its construction if they are not managed properly. See section C.1- Theory of operation on page 92 for more detail.

Contact the local Servomex Business Center for recommendations on using the sensor on acid gases other than those listed.

Sample gas temperature

Gas temperature should not exceed 50 °C (122° F), nor should it fall below 0° C (32° F). Gas temperature can be controlled by passing the gas through 5 to 10 feet of metal tubing that is within the recommended sample temperature. Because of its low thermal mass, the gas sample quickly reaches the gas sample line temperature.

Ideally, the analyzer should be operated at a nominal temperature of 70° F. Calibration temperature should be close to operating temperature. If the analyzer is to be operated at an average ambient temperature outside 65° F to 80° F, it should be recalibrated at the operating temperature for optimal performance.

Hint: *The sensor temperature can be displayed at any time by accessing the second page of the Measurement Menu (section 4.8). Press the  icon to display the sensor temperature at the bottom of the screen. This temperature value is updated at intervals of 15 to 45 seconds.*

Protecting the analyzer from process upsets

The analyzer should be protected from extended exposure to high concentrations of oxygen or hostile gases. Automatically solenoid controlled valves should be installed to switch the analyzer over to an N₂ purge when the process reaches some identifiable condition.

Gas line maintenance operations must also be examined for their effect on the analyzer. For example, in many pipeline process or normal gas applications the plumbing system is cleaned with either a liquid solvent or detergent solution. Since either causes damage to the sensor, switch the analyzer over to a N₂ bypass purge, or shut off sample flow and power to the analyzer prior to initiating the potentially hazardous process.

C.2.5 Calibration gas considerations

Calibrations performed from a bottled, calibrated sample gas, may introduce additional issues that could adversely affect the analyzer calibration.

Calibration standards

Certified calibration standards are available from gas manufacturers. These standards are available in steel and aluminum cylinders. Steel cylinders are less expensive but do not dependably maintain a stable oxygen concentration for long periods of time.

Calibration standards in aluminum cylinders are recommended. Servomex has found that calibration standards in aluminum cylinders are very stable for long periods of time (between 6 and 24 months) but steel cylinder standards should be recalibrated every three months.

Calibration cylinder regulators

Regulators used on bottled calibration standards are typically equipped with two Bourdon pressure gauges, one to measure the cylinder pressure, and the other to measure the outlet pressure. The regulator must have a metal (preferably stainless steel) diaphragm. Install a flow control valve after the regulator to adjust the flow.

Purge procedure

Before the calibration gas is connected to the analyzer follow the procedure listed below to purge ambient air from the regulator which prevents contamination of the gas in the cylinder rendering it useless:

After securely attaching the regulator to the cylinder:

1. Open the regulator flow control valve slightly.
2. Open the cylinder valve.
3. Set the regulator to its maximum delivery pressure.
4. Adjust the flow control valve to allow a modest flow rate (hissing sound).
5. Close the cylinder valve until the cylinder pressure falls to zero. If equipped with gauges, allow the secondary (output) gauge to approach zero. Otherwise wait for the hissing to nearly stop.
6. Immediately open the cylinder valve to restore full delivery pressure.
7. Repeat steps 5 and 6 five to ten times to thoroughly purge the regulator and gauges.
8. Close the shut off valve on the outlet side of the regulator to isolate the purged regulator from atmospheric contamination.
9. Set the delivery pressure to 5 psig (15 psi for welded sample line with VCR connection).

Once the regulator is mounted and purged, do not remove it from the cylinder until a fresh cylinder is required.

Sample gas delivery and vent pressure during calibration

The most accurate calibration is obtained when the analyzer is plumbed into the gas sample system so that the analyzer is under actual process operating conditions. However, when the process sample is being delivered to the analyzer under vacuum conditions, or being returned from the sample outlet under either positive pressure or vacuum conditions the operating pressure at the sensor is likely to be quite different than under factory calibration conditions.

For systems where the gas sample is not vented to atmosphere, the analyzer outlet should remain connected in the same manner during calibration, if possible. This ensures that downstream pressure effects on the sensor are the same during calibration and process monitoring.

Use the flow control valve on the regulator to meter the calibration gas to the analyzer at the suggested 1.0 scfh flow. By leaving the analyzer's flow controls untouched from when the analyzer is used on process, the calibration pressure duplicates the process sampling pressure.

Background gas effects on calibration

Flow rate

Ideally, the calibration gas and the sample gas have the same gas composition, and as a result, the indicated flow rate during calibration and process sampling are identical. However, if the compositions of the calibration and sample gases are not the same, the flow rate indicated on the rotameter may need to be adjusted. Light gases, such as H₂ and He, have a higher flow rate than is indicated on the flowmeter. As a result, the flow rate of the light gas should be set to one third of the flow specifications found in this manual. For example, the recommended flow rate for N₂ is 1.0 scfh. In H₂ or He service, the recommended flow rate (as indicated on the analyzer flowmeter) is 0.3 scfh.

Gas Scale Factor (GSF)

If possible, the background of the calibration gas should be the same as the process sample gas. If not, a gas scale factor may have to be applied to the calibration gas oxygen readings because of the difference between the diffusion rate of oxygen in nitrogen (factory calibration gas) versus the diffusion rate in the user's calibration gas. The Sample Gas Preparation and Delivery section discusses the proper setting of the gas scale factor option during calibration as well as during process gas measurement.

C.3 Coulometric sensor maintenance

The only regular routine maintenance required is to add replenishment solution to the electrolyte. Exposure to dry gas for an extended time gradually extracts water from the sensor, so the electrolyte must be refilled occasionally with Hummingbird Replenishment Solution for optimum performance and long term reliability.



If the electrolyte level is low, only add Hummingbird Replenishment Solution to the sensor for optimum performance, long term reliability. Using any other replenishing materials will void the five year sensor warranty.

Always replace the cap on the bottle immediately after use.

In an emergency, distilled water can be used as an alternative, however this is not recommended over an extended period.

Do not add electrolyte solution to restore the electrolyte level.

Do not overfill.

The Sensor Assembly consists of two connected chambers. The operation of the sensor is satisfactory as long as the level of electrolyte is above the minimum indicator line and below the maximum line on the reservoir label.

One 125 cc bottle of electrolyte should be added at the time of start-up. Under normal operation is not necessary to ever add additional electrolyte.



Use replenishing solution to top up the system. Do not use electrolyte.

Check the electrolyte level every 1 to 2 months as typically, very dry sample gas can extract approximately 5 to 10 cc of water per month. If the liquid level is low, add Hummingbird Replenishment Solution to bring the electrolyte level between the minimum and maximum indicator lines on the reservoir label.

Operation at elevated temperatures and / or with sample gases at very low dew points will increase the frequency of replenishing the electrolyte.

The Oxygen Analyzer is equipped with an Electrolyte Condition alarm to indicate that the electrolyte level is low. The operation of this alarm is described in the Alarms section.

C.3.1 Procedure for adding replenishment solution to the sensor



The electrolyte is caustic. Be careful of drips of electrolyte from the cover.

1. Open the front door.
2. Unscrew and remove the filler cap.
3. Add Hummingbird Replenishment Solution to the electrolyte solution using a squeeze bottle
4. Fill to the maximum level indicator line on the reservoir label. Be careful not to spill solution on the electronics or on the outside of the sensor. Do not overfill.
5. Replace the filler cap securely and close the front door.

Appendix D Paramagnetic O₂ transducers

D.1 Paramagnetic Oxygen analysis: theory of operation

Oxygen is attracted into a strong magnetic field. Most other gases are not. This paramagnetism is used to obtain fast, accurate oxygen measurements.

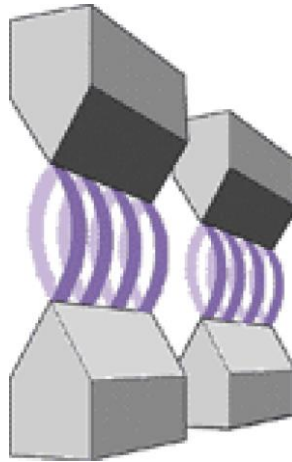

Figure D-1: Strong magnetic field

A focused magnetic field is created (Figure D-1). Any oxygen that is present will be attracted into the strongest part of the magnetic field.

Two nitrogen filled glass spheres are mounted on a rotating suspension within a magnetic field (Figure D-2).

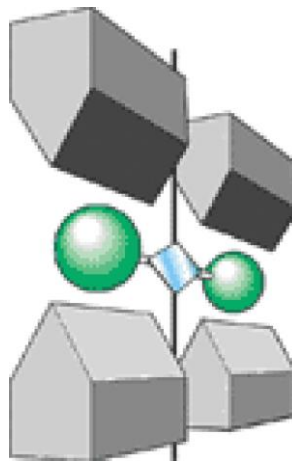

Figure D-2: Two nitrogen filled spheres

A mirror is mounted centrally on the suspension and light is shone onto the mirror (Figure D-3). The reflected light is directed onto a pair of photocells.

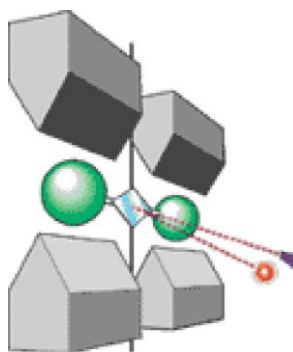

Figure D-3: Reflected light

Oxygen attracted into the magnetic field will displace the nitrogen filled spheres, causing the suspension to rotate. The photocells will detect the movement and generate a signal. The signal generated by the photocells is passed to a feedback system (Figure D-4).

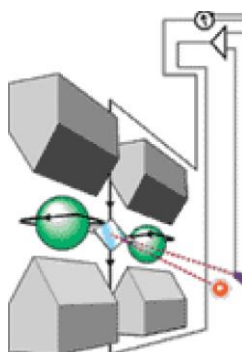

Figure D-4: Signal passed to a feedback system

The feedback system will pass a current around a wire mounted on the suspension. This causes a motor effect, which will keep the suspension in its original position. The current measured flowing around the wire will be directly proportional to the concentration of oxygen within the gas mixture.

D.2 Considerations for sample preparation

Paramagnetic transducer (% O₂)	
Flow rate *	100 to 250 ml min ⁻¹
Dew point	5 °C below ambient temperature (minimum)
Temperature	5 to 45 °C
Particulate size	< 2 µm (2 micron)

* *The flow rates apply to flow driven transducers only. On pressure driven transducers, the sample gas pressure must be in the range 14 to 56 kPa (2 to 8 psig).*

D.3 Overview of measurement errors for paramagnetic O₂ transducer

For an O₂ transducer, the composition of any typical background gas in the gas sample will have an impact on the analyzer measurement accuracy.

Table D-1 gives 4 examples of cross-interference errors (O₂ measurement errors) in gases which contain 100% of a specific background gas, for an analyzer which has been 'Lo' calibrated with N₂ (nitrogen) and 'Hi' calibrated with O₂.

Background gas	Error
Argon	-0.22%
Carbon dioxide	-0.26%
Halothane	-1.93%
Helium	-0.29%

Table D-1: Example cross-interference measurement errors

Note that the error is directly proportional to the concentration of the background gas in the sample being measured and in most cases can be ignored. A detailed listing of these measurement errors for a wide variety of background gases are listed in section D.4.

XINT is a reported concentration adjustment that can be set in the Paramagnetic Measurement menus. It is a scaling factor that is used to correct the current sensor reading. The default value is 1.0. If required the operator can change this value to compensate for the background gas. For example: If you are measuring oxygen in a background of carbon dioxide -0.26 should be entered as the XINT value.



Figure D-5: XINT icon

If XINIT compensation is to be used, care must be taken to insure that the value used for the background gases is correct. During a calibration, no XINT compensation is applied and it is assumed that the calibration gas sample has negligible cross-interference.

D.4 Cross interference offsets (for paramagnetic transducer)

Pure gas	Formula	Molar mag. susc $\times 10^{-6}$	Cross interference offsets			
			Control = 20 °C		Purity = 60 °C	
			20 °C	50 °C	60 °C	110 °C
Acetaldehyde	CH ₂ CHO	-22.70	-0.31	-0.34	-0.35	-0.40
Acetic acid	CH ₃ CO ₂ H	-31.50	-0.56	-0.62	-0.64	-0.74
Acetone	CH ₃ COCH ₃	-33.70	-0.63	-0.69	-0.71	-0.82
Acetylene	HCCH	-20.80	-0.25	-0.28	-0.29	-0.33
Acrylonitrile	CH ₂ =CHCN	-24.10	-0.35	-0.39	-0.40	-0.46
Allyl alcohol	CH ₂ CHCH ₂ OH	-36.70	-0.71	-0.79	-0.81	-0.93
Ammonia	NH ₃	-18.00	-0.17	-0.19	-0.20	-0.23
Argon	Ar	-19.60	-0.22	-0.24	-0.25	-0.29
Benzene	C ₆ H ₆	-54.84	-1.24	-1.36	-1.41	-1.62
Boron chloride	BCl ₃	-59.90	-1.38	-1.53	-1.57	-1.81
Boron trifluoride	BF ₃	-19.00	-0.20	-0.22	-0.23	-0.26
Bromine	Br ₂	-73.50	-1.78	-1.96	-2.02	-2.32
1,2 Butadiene	C ₄ H ₆	-35.60	-0.68	-0.75	-0.77	-0.89
1,3 Butadiene	C ₄ H ₆	-30.60	-0.54	-0.59	-0.61	-0.70
N-Butane	C ₄ H ₁₀	-50.30	-1.11	-1.22	-1.26	-1.45
iso-Butane	(CH ₃) ₂ CHCH ₂	-51.70	-1.15	-1.26	-1.30	-1.50
1 Butene	CH ₃ CH ₂ CH=CH ₂	-41.10	-0.84	-0.93	-0.96	-1.10
N-Butyl acetate	CH ₃ COOC ₄ H ₉	-77.50	-1.89	-2.09	-2.15	-2.47
iso-Butylene	(CH ₃) ₂ CH=CH ₂	-44.40	-0.94	-1.03	-1.06	-1.22
1 Butyne (Ethylacetylene)	CH ₃ C ₃ H ₂	-43.50	-0.91	-1.00	-1.03	-1.19
Carbon dioxide	CO ₂	-21.00	-0.26	-0.29	-0.30	-0.34
Carbon disulphide	CS ₂	-42.20	-0.87	-0.96	-0.99	-1.14
Carbon monoxide	CO	-9.80	0.06	0.07	0.07	0.08
Carbon tetrachloride	CCl ₄	-66.60	-1.58	-1.74	-1.79	-2.06
Carbon tetrafluoride	CF ₄	-31.20	-0.55	-0.61	-0.63	-0.72

Pure gas	Formula	Molar mag. susc x 10 ⁻⁶	Cross interference offsets			
			Control = 20 °C		Purity = 60 °C	
			20 °C	50 °C	60 °C	110 °C
Chlorine	Cl ₂	-40.50	-0.82	-0.91	-0.94	-1.08
Chloro ethanol	ClCH ₂ CH ₂ OH	-51.40	-1.14	-1.25	-1.29	-1.49
Chloroform	CHCl ₃	-59.30	-1.37	-1.51	-1.55	-1.78
Cumene	(CH ₃) ₂ CHC ₆ H ₅	-89.53	-2.24	-2.47	-2.55	-2.93
Cyclohexane	C ₆ H ₁₂	-68.13	-1.62	-1.79	-1.84	-2.12
Cyclopentane	C ₅ H ₁₀	-59.18	-1.36	-1.50	-1.55	-1.70
Cyclopropane	C ₃ H ₆	-39.90	-0.81	-0.89	-0.92	-1.05
Diacetylene	C ₄ H ₂	-37.50	-0.74	-0.81	-0.84	-0.96
Dichloroethylene	(CHCl) ₂	-49.20	-1.07	-1.18	-1.22	-1.40
Diethyl ether	(C ₂ H ₅) ₂ O	-55.10	-1.25	-1.37	-1.41	-1.63
2,2 Difluoro 1 chloroethane	CClH ₂ CHF ₂	-52.40	-1.17	-1.29	-1.33	-1.52
1,2 Difluoro 1,2 dichloroethylene	CFCI=CFCl	-60.00	-1.39	-1.53	-1.58	-1.81
Difluoro dichloro methane (Freon 12)	CCl ₂ F ₂	-52.20	-1.16	-1.28	-1.32	-1.5
Dimethoxy methane	CH ₂ (OCH ₃) ₂	-47.30	-1.02	-1.12	-1.16	-1.33
Dimethylamine	(CH ₃) ₂ NH	-39.90	-0.81	-0.89	-0.92	-1.05
Dimethylether	CH ₃ OCH ₃	-26.30	-0.41	-0.46	-0.47	-0.54
Dimethylethylamine	(CH ₃) ₂ NC ₂ H ₅	-63.60	-1.49	-1.64	-1.69	-1.95
Enflurane (Ethrane)	C ₃ H ₂ F ₅ ClO	-80.10	-1.97	-2.17	-2.24	-2.57
Ethane	C ₂ H ₆	-26.80	-0.43	-0.47	-0.49	-0.56
Ethanol	C ₂ H ₅ OH	-33.60	-0.62	-0.69	-0.71	-0.82
Ethyl acetate	CH ₃ COOC ₂ H ₅	-54.20	-1.22	-1.34	-1.39	-1.59
Ethyl amine	C ₂ H ₅ NH ₂	-39.90	-0.81	-0.89	-0.92	-1.05
Ethyl benzene	C ₆ H ₅ C ₂ H ₅	-77.20	-1.88	-2.08	-2.14	-2.46
Ethyl bromide	C ₂ H ₅ Br	-54.70	-1.23	-1.36	-1.40	-1.61
Ethyl chloride	C ₂ H ₅ Cl	-46.00	-0.98	-1.08	-1.12	-1.28

Pure gas	Formula	Molar mag. susc $\times 10^{-6}$	Cross interference offsets			
			Control = 20 °C		Purity = 60 °C	
			20 °C	50 °C	60 °C	110 °C
Ethylene	C ₂ H ₄	-18.80	-0.20	-0.22	-0.22	-0.26
Ethylene glycol	(CH ₂ OH) ₂	-38.80	-0.77	-0.85	-0.88	-1.01
Ethylene oxide	(CH ₂) ₂ O	-30.70	-0.54	-0.60	-0.61	-0.71
Ethyl mercaptan	C ₂ H ₅ OSO ₃ H	-47.00	-1.01	-1.11	-1.15	-1.32
Fluorochlorobromomethane	CFCIBr	-58.00	-1.33	-1.46	-1.51	-1.74
Fluorodichloromethane (Freon 21)	CHCl ₂ F	-48.80	-1.06	-1.17	-1.21	-1.39
Fluoroxene	CF ₃ CH ₂ OCHCH ₂	-56.70	-1.29	-1.42	-1.47	-1.69
Freon 114	C ₂ Cl ₂ F ₄	-77.40	-1.89	-2.08	-2.15	-2.47
Furan	C ₄ H ₄ O	-43.09	-0.90	-0.99	-1.02	-1.17
Germanium tetrachloride	GeCl ₄	-72.00	-1.73	-1.91	-1.97	-2.26
Halothane	C ₂ HBrClF ₃	-78.80	-1.93	-2.13	-2.19	-2.52
Helium	He	-1.88	0.29	0.32	0.33	0.38
N-Heptane	C ₇ H ₁₆	-85.24	-2.12	-2.33	-2.40	-2.76
N-Hexane	C ₆ H ₁₄	-73.60	-1.78	-1.96	-2.02	-2.32
Hydrogen	H ₂	-3.98	0.23	0.26	0.26	0.30
Hydrogen bromide	Br	-35.30	-0.67	-0.74	-0.76	-0.88
Hydrogen chloride	HCl	-22.60	-0.31	-0.34	-0.35	-0.40
Hydrogen cyanide	HCN	-14.50	-0.07	-0.08	-0.08	-0.09
Hydrogen iodide	HI	-48.20	-1.05	-1.15	-1.19	-1.37
Hydrogen selenide	H ₂ Se	-39.20	-0.79	-0.87	-0.89	-1.03
Hydrogen sulphide	H ₂ S	-25.50	-0.39	-0.43	-0.44	-0.51
Isoflurane (Forane)	C ₃ H ₂ F ₅ ClO	-80.10	-1.97	-2.17	-2.24	-2.57
Isoprene	C ₅ H ₈	-44.80	-0.95	-1.04	-1.08	-1.24
Ketene	CH ₂ CO	-15.70	-0.11	-0.12	-0.12	-0.14
Krypton	Kr	-28.80	-0.49	-0.54	-0.55	-0.63
Methane	CH ₄	-17.40	-0.16	-0.17	-0.18	-0.20

Pure gas	Formula	Molar mag. susc x 10 ⁻⁶	Cross interference offsets			
			Control = 20 °C		Purity = 60 °C	
			20 °C	50 °C	60 °C	110 °C
Methanol	CH ₃ OH	-21.40	-0.27	-0.30	-0.31	-0.35
Methoxyfluorane	CHCl ₂ CF ₂ OCH ₃	-87.10	-2.17	-2.39	-2.47	-2.83
Methyl acetate	CH ₃ COCH ₃	-42.60	-0.88	-0.97	-1.00	-1.15
Methyl cyclopentane	C ₆ H ₁₂	-70.20	-1.68	-1.85	-1.91	-2.20
Methylene chloride	CH ₂ Cl ₂	-46.60	-1.00	-1.10	-1.14	-1.31
Methylethylketone	CH ₃ COCH ₂ CH ₃	-45.50	-0.97	-1.07	-1.10	-1.26
Methyl fluoride	CH ₃ F	-25.50	-0.39	-0.43	-0.44	-0.51
Methyl formate	HCOOCH ₃	-32.00	-0.58	-0.64	-0.66	-0.75
Methyl iodide	CH ₃ I	-57.20	-1.31	-1.44	-1.48	-1.71
Methyl iso-butyl ketone (MIBK)	C ₄ H ₈ COCH ₃	-69.30	-1.66	-1.82	-1.88	-2.16
Methyl mercaptan	CH ₃ SH	-35.30	-0.67	-0.74	-0.76	-0.88
Molybdenum hexafluoride	MoF ₆	-26.00	-0.40	-0.45	-0.46	-0.53
Monochlorobenzene	C ₆ H ₅ Cl	-70.00	-1.68	-1.85	-1.90	-2.19
Neon	Ne	-6.70	0.15	0.17	0.17	0.20
Nitric oxide	NO	1461.00	42.56	42.96	42.94	41.62
Nitrobenzene	C ₆ H ₅ NO ₂	-61.80	-1.44	-1.59	-1.63	-1.88
Nitrogen	N ₂	-12.00	0.00	0.00	0.00	0.00
Nitrogen dioxide	NO ₂	150.00	5.00	16.00	20.00	35.00
Ortho-Nitrotoluene	C ₆ H ₄ CH ₃ NO ₂	-72.30	-1.74	-1.92	-1.98	-2.28
para-Nitrotoluene	C ₆ H ₄ CH ₃ NO ₂	-76.90	-1.88	-2.07	-2.13	-2.45
Nitrous oxide	N ₂ O	-18.90	-0.20	-0.22	-0.23	-0.26
N-Nonane	C ₉ H ₂₀	-108.13	-2.78	-3.06	-3.16	-3.63
N-Octane	C ₈ H ₁₈	-96.63	-2.45	-2.70	-2.78	-3.19
Oxygen	O ₂	3449.00	100.0	100.0	100.0	100.0
Ozone	O ₃	6.70	0.54	0.60	0.61	0.71
iso-Pentane	C ₅ H ₁₂	-64.40	-1.51	-1.67	-1.72	-1.98

Pure gas	Formula	Molar mag. susc $\times 10^{-6}$	Cross interference offsets			
			Control = 20 °C		Purity = 60 °C	
			20 °C	50 °C	60 °C	110 °C
N-Pentane	C ₅ H ₁₂	-63.10	-1.48	-1.63	-1.68	-1.93
0.01%Phenol	C ₆ H ₅ OH	-60.21	-1.39	-1.54	-1.58	-1.82
Phosphine	PH ₃	-26.00	-0.40	-0.45	-0.46	-0.53
Phosphorous oxychloride	POCl ₃	-69.00	-1.65	-1.82	-1.87	-2.15
Propane	C ₃ H ₈	-38.60	-0.77	-0.85	-0.87	-1.00
iso-Propanol	(CH ₃) ₂ CHOH	-47.60	-1.03	-1.13	-1.17	-1.34
Propene	CH ₃ CH=CH ₂	-31.50	-0.56	-0.62	-0.64	-0.74
N-Propyl acetate	CH ₃ COOC ₃ H ₇	-65.90	-1.56	-1.72	-1.77	-2.03
Propyl amine	C ₃ H ₇ NH ₂	-52.40	-1.17	-1.29	-1.33	-1.52
Propyl chloride	C ₃ H ₇ Cl	-56.10	-1.27	-1.40	-1.45	-1.66
Propylene	C ₃ H ₆	-31.50	-0.56	-0.62	-0.64	-0.74
Propylene oxide	OCH ₂ CHCH ₃	-42.50	-0.88	-0.97	-1.00	-1.15
iso-Propyl ether	(CH ₃) ₄ CHOCH	-79.40	-1.95	-2.15	-2.21	-2.54
Propyl fluoride	C ₃ H ₇ F	-52.20	-1.16	-1.28	-1.32	-1.52
Pyridine	N(CH) ₅	-49.21	-1.08	-1.19	-1.22	-1.40
Silane	SiH ₄	-20.50	-0.25	-0.27	-0.28	-0.32
Silicon tetrachloride	SiCl ₄	-88.30	-2.20	-2.43	-2.50	-2.88
Styrene	C ₆ H ₅ CH=CH ₂	-68.20	-1.62	-1.79	-1.85	-2.12
Sulphur dioxide	SO ₂	-18.20	-0.18	-0.20	-0.20	-0.23
Sulphur hexafluoride	SF ₆	-44.00	-0.92	-1.02	-1.05	-1.21
Tetrachoroethylene	Cl ₂ C=CCl ₂	-81.60	-2.01	-2.22	-2.28	-2.63
Tetrahydrofuran	C ₄ H ₈ O	-52.00	-1.16	-1.27	-1.31	-1.51
Toluene	C ₆ H ₅ CH ₃	-66.11	-1.56	-1.72	-1.78	-2.04
1,1,2 Trichloroethane (Freon 113)	CHCl ₂ CH ₂ Cl	-66.20	-1.57	-1.73	-1.78	-2.05
Trichloroethylene	CHCl=CCl ₂	-65.80	-1.55	-1.71	-1.77	-2.03
Trifluorochloroethylene	C ₂ F ₃ Cl	-49.10	-1.07	-1.18	-1.22	-1.40

Pure gas	Formula	Molar mag. susc x 10 ⁻⁶	Cross interference offsets			
			Control = 20 °C		Purity = 60 °C	
			20 °C	50 °C	60 °C	110 °C
Trimethylamine	(CH ₃) ₃ N	-51.70	-1.15	-1.26	-1.30	-1.50
Tungsten fluoride	WF ₆	-40.00	-0.81	-0.89	-0.92	-1.06
Urethane	CO(NH ₂)OC ₂ H ₅	-57.00	-1.30	-1.43	-1.48	-1.70
Vacuum	-	0.00	0.35	0.38	0.39	0.45
Vinyl bromide	CH ₂ =CHBr	-44.80	-0.95	-1.04	-1.08	-1.24
Vinyl chloride	CH ₂ =CHCl	-35.60	-0.68	-0.75	-0.77	-0.89
Vinyl fluoride	CH ₂ =CHF	-28.80	-0.49	-0.54	-0.55	-0.63
Water	H ₂ O	-13.00	-0.03	-0.03	-0.03	-0.04
Xenon	Xe	-43.90	-0.92	-1.02	-1.05	-1.20
Xylene	(CH ₃) ₂ C ₆ H ₄	-77.78	-1.90	-2.09	-2.16	-2.48

Appendix E Compliance and standards

SERVOMEX 

Declaration of Conformance

Applicable Directive(s): Low Voltage (LVD) 2006/95/EC – Until 19 April 2016
Low Voltage (LVD) 2014/35/EU – From 20 April 2016
Electromagnetic Compatibility (EMC) 2004/108/EC – Until 19 April 2016
Electromagnetic Compatibility (EMC) 2014/30/EU - From 20 April 2016

Standards to which conformity is declared: **EN 61010-1:2010**
EN 61326-1:2013 / IEC 61326-1:2012

Third Party Test Report: Parker Chomerics: SAF6899B.16 Rev. 1 - July 18, 2016
Parker Chomerics: EMI899A.16 - July 27, 2016

Manufacturer's Name: **Servomex LLC, Inc.**
Manufacturer's Address: **4 Constitution Way**
Woburn, MA 01801
USA

Equipment Type: **Process/Control/Laboratory Oxygen Analyzer**

Model Number: **MONOEXACT DF310E**

Year of Manufacture: **2016**

I, the undersigned, hereby declare that the equipment specified above conforms to the above Directives and Standards.

Woburn, MA, USA
October 21, 2016

Clyde A Woodruff
Director, Research & Development



This certificate may only be reproduced in its entirety and without any change.



Declaration of Conformance

Applicable Directive(s): Low Voltage (LVD) 2006/95/EC – Until 19 April 2016
Low Voltage (LVD) 2014/35/EU – From 20 April 2016
Electromagnetic Compatibility (EMC) 2004/108/EC – Until 19 April 2016
Electromagnetic Compatibility (EMC) 2014/30/EU - From 20 April 2016

Standards to which conformity is declared: **EN 61010-1:2010**
EN 61326-1:2013 / IEC 61326-1:2012

Third Party Test Report: Parker Chomerics: SAF6899B.16 Rev. 1 July 18,2016
Parker Chomerics: EMI899.16 July 15, 2016

Manufacturer's Name: **Servomex LLC, Inc.**
Manufacturer's Address: **4 Constitution Way**
Woburn, MA 01801
USA

Equipment Type: **Process/Control/Laboratory Oxygen Analyzer**

Model Number: **MONOEXACT DF150E**

Year of Manufacture: **2016**

I, the undersigned, hereby declare that the equipment specified above conforms to the above Directives and Standards.

Woburn, MA, USA
October 21, 2016

Clyde A Woodruff
Director, Research & Development



This certificate may only be reproduced in its entirety and without any change.

Appendix F Performance data

F.1 Coulometric O₂ trace measurement

Display indication:	Measured volume ppm O ₂
Accuracy:	DF310E: Greater of ± 3% of reading or 0.05% of full scale range.
	DF310E High Res: The High Resolution (0 – 100 ppm) analyser has an accuracy of ± 3% of reading or ± 10 ppb, whichever is larger.
	DF150E: Greater of ± 5% of reading or 0.05% of full scale range.
Response time:	Typically less than 30 seconds to read 90% of a step change. Equilibrium time depends on the specific conditions.
Oxygen sensitivity:	3 ppb
Low detection limit:	3 ppb
Resolution:	0.005 ppm for HR 100 ppm range 0.01 ppm for 100 ppm range 0.1 ppm for 1000 ppm range 1 ppm for 10000 ppm range
Overall operating temperature range:	
	Gas sample: 32 °F to 113 °F (0 °C to 45 °C)
	Sensor: 32 °F to 113 °F (0 °C to 45 °C)
	Electronics: 32 °F to 113 °F (0 °C to 45 °C)
Storage temperature:	Not to exceed 113 °F (45 °C) or less than 43°F (6 °C)
Sensor type:	Non-depleting coulometric
Sensor warranty:	5 years (limited)
Spare storage time:	Do not store spare sensors for more than 9 months, or the electrode may degrade and the warranty will be voided.

F.2 Paramagnetic O₂ % measurement

Hint: The display indication given below is the default indication. You can configure the analyzer to provide other display indications in the Measurement screen.

Hint: Performance data has been determined in accordance with EN61207.

Display indication:	Measured volume % O ₂
Full scale range:	0 to 25% O ₂
Analog output range:	User selectable (minimum difference – 0.5%)
Resolution:	0.1% O ₂
Repeatability:	0.1% O ₂
Linearity:	No measurable error
Intrinsic error (accuracy):	± 0.1% O ₂
Zero drift per week:	± 0.05% O ₂
Span drift per week:	± 0.1% O ₂
Output fluctuation:	± 0.05% O ₂
Response time: *	10 seconds
Flow effect:	
Flow driven:	± 0.1% O ₂ (for a 100 to 250 ml min ⁻¹ change in sample gas flow rate)
Pressure driven:	± 0.1% O ₂ (for a 14 to 55 kPa (0.14 to 0.55 bar, 2 to 8 psi) change in sample gas inlet pressure)
Zero temperature coefficient:	± 0.1% O ₂ per 10 °C
Span temperature coefficient:	± 0.1% O ₂ or 1% of reading per 10 °C (whichever is the greater)
Pressure effects:	Directly proportional to ambient air pressure

Note: Response time - T₉₀ at 200 ml min⁻¹ or 68.9 kPa gauge (7 psig, 0.48 bar gauge) sample gas supply pressure.*

F.3 Flow alarm

The low flow alarm is raised when flow drops below 0.1 L/min.

Appendix G Recommended calibration periods

Gas transducer	Low cal	High cal
O ₂ % paramagnetic	2 weekly	Monthly
O ₂ coulometric*	Not required	Not required

** replenish electrolyte when the level is below the indicator line on the sensor reservoir.*

Appendix H Implementation guide for Modbus communications

H.1 Introduction

This appendix details the implementation and use of the Modbus protocol in the MonoExact 310E analyzer.

H.2 References

Document "MODBUS over Serial Line Specification & Implementation guide V1.0 Nov 02"
Modbus web site modbus.org.

H.3 Modbus setup

The Modbus setup form will allow the user to configure the following parameters:

Default values are in **Bold**.

Parameter	Options	Comments
Address	1 to 247	Slave address of unit.
Mode	ASCII or RTU	Select serial transmission mode.
Baud rate	2400, 4800, 9600, 19200 , 38400	
Parity	Odd, Even , None	

H.4 Supported function codes

For simplicity, only the following function codes will be supported:

Function	Description	Usage
01	Read coils	Read calibration status, pump state, etc.
02	Read discrete inputs	Read faults and alarm states.
03	Read holding registers	Read settings.
04	Read input registers	Read measurements, units, etc.

Function	Description	Usage
05	Write single coil	Change modes, perform calibration etc.
06	Write single register	Change single setting.
08	Sub Function 00 = Return query data	Diagnostic to test communications.
16	Write multiple registers	Change multiple settings.

H.5 Exception codes

If an error occurs while processing a message one of the following exception codes will be returned by the instrument:

Code	Condition	Meaning
01	Illegal function	Requested function code is not supported.
02	Illegal data address	The combination of data address and transfer length is invalid for this function.
03	Illegal data value	A value contained in the query data field is not an allowable value. This indicates a fault in the structure of the remainder of a complex request. This does NOT mean that a value to be stored in a register is incorrect as Modbus has no means of determining what is legal for any particular register.
04	Slave device failure	An unrecoverable error occurred while the unit was attempting to perform the requested action.

H.6 Addressing

Addresses in Modbus ADU (application data unit), run from 1 – N, whereas addresses in the Modbus PDU (protocol data unit) run from 0 – N. This appendix gives addresses in the ADU model. Depending on the particular Modbus master, addresses may have to be entered as they are given or have 1 subtracted from them. For example to read register 101 an address of 100 may be needed.

H.7 Floating point numbers

Floating point numbers (e.g. 12.34, -1012.32, etc.), are digitally represented using the IEEE-754 format. Single precision floating point numbers are used throughout and they require 32 bits of data. Since a Modbus register holds 16 bits it takes 2 registers to represent a floating point number. We default to having the most significant word of the float, bits 16 – 31, in the first register, and the least significant word, bits 0 – 15, in the next register.

Note: This order can be reversed by setting a coil in the system control mapping. Refer to Section H.9 – Base address 2001, Floating point order. This changes the order of the Modbus registers when dealing with 32-bit floating point numbers:

0= Big-endian, e.g. 40001=high word, 400002=low word (default)

1= Little-endian, e.g. 40001=low word, 400002=high word

H.8 System data

Base Address	Block	Base Address Offset	Parameter	Supports Function Code								
				1	2	3	4	5	6	8	16	
3001	0	0-9	Instrument Serial Number			✓						
		10-19	Analyzer Firmware			✓						
3021	1	0-9	Reserved			✓						
		10-19	Reserved			✓						
3041	2	0-9	Option Board Digital Firmware			✓						
		10-19	Option Board Analog Firmware			✓						
3061	3	0-9	Reserved			✓						
		10-19	Bootloader Firmware			✓						
3981	49	0	NumberOfInternalTransducers			✓						
		1	NumberOfExternalTransducers			✓						
		2	NumberOfTransducers			✓						
		3	NumberOfMeasurements			✓						
		4	NumberOfAins			✓						
		5	NumberOfAouts			✓						

Base Address	Block	Base Address Offset	Parameter	Supports Function Code								
				1	2	3	4	5	6	8	16	
		6	NumberOfAlarms			✓						
		7	NumberOfRelays			✓						
		8	NumberOfDins			✓						
		9	Number of legacy pressure devices			✓						
		10	Number of legacy flow alarms			✓						
		11	Number of Legacy Heaters			✓						
		12	Number of Legacy Sample Heater			✓						
		13	Number of Field Buses			✓						
		14	Number Of Ovens			✓						
		15	Number Of Network Cards			✓						
		16	NumberOfResources			✓						

H.9 System Settings

Base Address	Block	Base Address Offset	Parameter	Supports Function Code								
				1	2	3	4	5	6	8	16	
2001	0	0	Floating point order	✓				✓				
		1	User interface busy	✓								
		2	Disable user interface	✓				✓				
		3	Audible alarm	✓				✓				
		4	ResponseDelay			✓			✓		✓	
		5	Language			✓			✓		✓	
		6	Date format			✓			✓		✓	
		7	Decimal format			✓			✓		✓	

Base Address	Block	Base Address Offset	Parameter	Supports Function Code								
				1	2	3	4	5	6	8	16	
		8	Backlight Time			✓				✓		✓
		9	clock: Hrs			✓				✓		✓
		10	clock: Mins			✓				✓		✓
		11	clock: Seconds			✓				✓		✓
		12	date: Year			✓				✓		✓
		13	date: Month			✓				✓		✓
		14	date: Day			✓				✓		✓
		15	CalLink			✓				✓		✓
2021	1	0	Temperature Units			✓				✓		✓
		1	Pressure Units			✓				✓		✓
		2	Flow Units			✓				✓		✓
		3	Moisture Units			✓				✓		✓
		4	Distance Units			✓				✓		✓
		5	Current Units			✓				✓		✓
		6	Voltage Units			✓				✓		✓
		7	Resistance Units			✓				✓		✓
		8	Reserved			✓				✓		✓
		9	Reserved			✓				✓		✓
		10	Time Units			✓				✓		✓

H.10 System Control

Base Address	Block	Base Address Offset	Parameter	Supports Function Code									
				1	2	3	4	5	6	8	16		
1	0	0	Service in Progress							✓			✓

0=Not in Service Mode, 1=Service Mode.
Instrument MUST be set to Service in Progress before any calibration or override actions are performed.

H.11 Measurements

Base Address	Block	Base Address Offset	Parameter	Supports Function Code			
				1	2	3	4
1001	0	0	Number Of Measurements			✓	
	0	1	Repeat (safeguard)			✓	
	0-49	2(n-1) + 2	Measurement n			✓	

H.12 Transducer calibration data

Base Address	First Block Number	Block	Base Address Offset	Parameter	Supports Function Code								
					1	2	3	4	5	6	8	16	
4721	0	Tx (n)	0	AutovalState			✓						
			1	AutovalGas			✓						
			2	AVFinishing			✓						
			3	AVFailState			✓						
			4	Number of Cal / Val Points			✓						
			5	Select Cal/val point			✓			✓			✓
			6	LastCal/val Point n Reading			✓						

Base Address	First Block Number	Block	Base Address Offset	Parameter	Supports Function Code								
					1	2	3	4	5	6	8	16	
			8	LastCalPoint n Target			✓						
			10	LastCalPoint n Delta			✓						
			12	Last Cal point n Time			✓						
			13	Last Cal point n Date			✓						
			15	Cal point passed/failed			✓						

AVFinishing 0=Not Finishing, 1=Finishing

AVFailState 0=Not in Fail State, 1=In Fail State

H.13 Transducer live info

Base Address	First Block Number	Block	Base Address Offset	Parameter	Supports Function Code								
					1	2	3	4	5	6	8	16	
4161	0	Tx (4n-1)	0	Transducer Type			✓						
			1	Tag Number			✓						
			2	Name			✓						
			11	Measurement			✓						
			13	Pressure Compensated Measurement			✓						
			15	Filtered Measurement			✓						
4181	1	Tx (4n)	0	Alarm Active	✓								
			1	Fault	✓								
			2	Service in progress	✓								
			3	Out of Specification	✓								
			4	Maintenance required	✓								

Base Address	First Block Number	Block	Base Address Offset	Parameter	Supports Function Code											
					1	2	3	4	5	6	8	16				
			5	Transducer maintenance fault	✓											
			6	Transducer error	✓											
			7	Transducer fatal fault	✓											
			8	WarmingOn	✓											
			9	Reserved	✓											
			10	Reserved	✓											
			11	Calibration fault	✓											
			12	Communication fail	✓											
			13	Transducer not detected	✓											
			14	Reserved	✓											
			15	Remote calibration/val denied	✓											
4201	2	Tx (4n+1)	0	Clipping Active	✓											
			1	Remote service in progress	✓											
			2	Transducer calibration mode	✓											
			3	Reserved	✓											
			4	Incorrect transducer type	✓											

H.14 Transducer settings

Base Address	First Block Number	Block	Base Address Offset	Parameter	Supports Function Code								
					1	2	3	4	5	6	8	16	
4481	0	Tx (n)	0	Name			✓						
			9	Units			✓						
4561	56		0	Reserved			✓			✓		✓	
			2	Reserved			✓			✓		✓	
			4	Unit selection (scaling Factor)			✓			✓		✓	
			6	PMR			✓						
			8	Cross Interference correction			✓			✓		✓	
4641	112		0	Reserved			✓			✓		✓	
			1	Reserved			✓			✓		✓	
			3	Reserved			✓			✓		✓	
			4	Reserved			✓			✓		✓	
			6	Reserved			✓			✓		✓	
			7	Reserved			✓			✓		✓	
			9	Reserved			✓			✓		✓	
			10	Reserved			✓			✓		✓	
			12	Reserved			✓			✓		✓	
			13	Reserved			✓			✓		✓	
			15	Reserved			✓			✓		✓	
			16	Reserved			✓			✓		✓	

H.15 Transducer control

Base Address	Block	Base Address Offset	Parameter	Supports Function Code									
				1	2	3	4	5	6	8	16		
4001	0	0	Calibration mode on/off	✓					✓				
		1	Start auto val						✓				
		2	Stop auto val						✓				
		3	Capture and enable baseline subtraction	✓					✓				
4021	1	0	Invoke calibration n			✓				✓		✓	
		1	Calibration point n gas			✓							
		2	Sample Gas selection			✓				✓		✓	

Appendix I Material Safety Data Sheet

1. Identification of the substance

Trade name	ElectrolyteSolution, <i>ε</i> -lectrolyte Gold, <i>ε</i> -lectrolyte Blue, <i>ε</i> -lectrolyte Black, DF-E05, DF-E06, DF-E07, DF-E09
Manufacturer	Servomex, Inc. Boston Technical Center 4 Constitution Way, Woburn, MA 01801-1087, USA, Tel + 1-781-935-4600
Emergency contact	ChemTel Expert Assistance Hotline USA: 1-800-255-3924 International: +01-813-248-0585

2. Composition

CAS #	Component	EC Code/class	Concentration	Risk Phrase	Risk Description
7732-18-5	Water and non-hazardous salts	231-791-2	95.7% w/w	Not Applicable	None
1310-58-3	Potassium Hydroxide in aqueous solution	215-181-3 C	0.77N: 4.3% w/w	R35	Causes severe burns

3. Hazards identification

Main Hazard



Corrosive. Causes severe burns on contact with skin, eyes and mucous membrane.

CERCLA Ratings (scale 0-3) Health = 3 Fire = 0 Reactivity = 1 Persistence = 0

NFPA Ratings (scale 0-4) Health = 3 Fire = 0 Reactivity = 1

Potential Health Effects:

Eye Contact

Causes severe eye burns. May cause irreversible eye injury. Contact may cause ulceration of the conjunctiva and cornea. Eye damage may be delayed.

Skin Contact	Causes skin burns. May cause deep, penetrating ulcers of the skin.
Ingestion	May cause circulatory system failure. May cause perforation of the digestive tract. Causes severe digestive tract burns with abdominal pain, vomiting, and possible death.
Inhalation	Inhalation under normal use would not be expected as this product is supplied as an aqueous solution and no hazardous vapors are emitted. Effects of inhalation are irritation that may lead to chemical pneumonitis and pulmonary edema. Causes severe irritation of upper respiratory tract with coughing, burns, breathing difficulty, and possible coma.
Chronic	Prolonged or repeated skin contact may cause dermatitis. Prolonged or repeated eye contact may cause conjunctivitis.

4. First-Aid measures

Skin Contact	In case of skin contact, remove contaminated clothing and shoes immediately. Wash affected area with soap or mild detergent and large amounts of water for at least 15 minutes. Obtain medical attention immediately.
Eye Contact	If the substance has entered the eyes, wash out with plenty of water for at least 15 - 20 minutes, occasionally lifting the upper and lower lids. Obtain medical attention immediately.
Ingestion	If the chemical has been confined to the mouth, give large quantities of water as a mouthwash. Ensure the mouthwash has not been swallowed. If the chemical has been swallowed, do NOT induce vomiting. Give 470 - 950ml (2 - 4 cups) of water or milk. Never give anything by mouth to an unconscious person. Obtain medical attention immediately.
Inhalation	Inhalation under normal use would not be expected as this product is supplied as an aqueous solution and no hazardous vapors are emitted; however, if inhalation should somehow occur, remove from exposure to fresh air immediately. If not breathing, give artificial respiration. If breathing is difficult, give oxygen. Seek medical aid immediately.

5. Fire-fighting measures

Special Exposure Hazard	Not applicable
Extinguishing Media	Not Combustible. Select extinguishing media appropriate to the surrounding fire conditions.
Protective Equipment	Wear appropriate protective clothing to prevent contact with skin and eyes. Wear a self-contained breathing apparatus (SCBA) to prevent contact with thermal decomposition products.

6. Accidental release measures

Personal Protection	Use proper personal protective equipment as indicated in Section 8.
Leaks and Spills	Absorb spill with inert material (e.g., dry sand or earth), then place into a chemical waste container. Neutralize spill with a weak acid such as vinegar or acetic acid.
Clean-up Procedures	Wash the spillage site with large amounts of water.

7. Handling and storage

Handling Precautions	Complete eye and face protection, protective clothing, and appropriate gloves must be used. Do not get in eyes, on skin, or on clothing. Wash thoroughly after handling. Remove contaminated clothing and wash before reuse. Do not ingest or inhale.
Storage Precautions	Store in a tightly closed container. Store in a cool, dry, well-ventilated area away from incompatible substances. Keep away from strong acids.

8. Exposure controls / personal protection

Personal Protection	
Eyes	Wear appropriate protective chemical safety goggles and face shield as described by OSHA's eye and face protection regulations in 29 CFR 1910.133 or European Standard EN166.
Skin	Wear appropriate gloves to prevent skin exposure.
Clothing	Wear appropriate protective clothing to prevent skin exposure.
Respirators	Not Applicable. Inhalation under normal use would not be expected as this product is supplied as an aqueous solution and no hazardous vapors are emitted.

Airborne Exposure	This material is supplied as an aqueous solution and will not be present in the atmosphere in normal use.
Exposure Limits	Potassium Hydroxide UK EH40, OEL (8hr TWA) 2mg/m ³ NIOSH, (8hr TWA) 2mg/m ³ ACGIH, Ceiling 2mg/m ³ OSHA, not listed

9. Physical and chemical properties

Molecular Formula	KOH Mixture
Physical State	.77N aqueous solution. Colorless, odorless
pH	Alkaline
Solubility	Completely soluble in water
Boiling Point	104.5°C
Melting Point	-3.5°C
Flash Point	Not applicable
Flammability	Not flammable
Explosion Limits	Not applicable
Specific Gravity	1.15
Vapor Pressure	16.1 mm Hg @ 20°C

10. Stability and reactivity

Chemical Stability	Stable
Conditions/Materials to Avoid	Incompatible materials, acids and metals
Incompatibilities with other Materials	Reacts with chlorine dioxide, nitrobenzene, nitromethane, nitrogen trichloride, peroxidized tetrahydrofuran, 2,4,6-trinitrotoluene, bromoform+ crown ethers, acids alcohols, sugars, germanium cyclopentadiene, maleic dicarbide. Corrosive to metals such as aluminum, tin, and zinc to cause formation of flammable hydrogen gas.
Hazardous Decomposition Products	Oxides of potassium
Hazardous Polymerization	Has not been reported

11. Toxicological information

RTECS#	CAS# 7732-18-5	ZC0110000
	CAS# 1310-58-3	TT2100000
LD50/ LC50	CAS# 7732-18-5	Oral, ret:LD50 = >90 ml/kg
	CAS# 1310-58-3	Draize test, rabbit, skin: 50 mg/24H Severe Oral, rat: LD50 = 273 mg/kg
Carcinogen Status	CAS# 7732-18-5	Not listed by ACGIH, IARC, NIOSH, NTP, or OSHA
	CAS# 1310-58-3	Not listed by ACGIH, IARC, NIOSH, NTP, or OSHA

Potassium Hydroxide Solution is a severe eye, mucus membrane, and skin irritant.

12. Ecological information

Mobility	Completely soluble in water
Degradability	Will degrade by reaction with carbon dioxide from the atmosphere to produce a non-hazardous product.
Accumulation	No
Ecotoxicity	Information not available. No long-term effects expected due to degradation. The preparation is already in dilute solution and adverse aquatic effects are not expected due to further dilution. The preparation is corrosive, and direct contact with fauna will cause burns.

13. Disposal considerations

Waste Disposal	Dispose of in a manner consistent with federal, state, and local regulations.
-----------------------	---

14. Transportation information

	Shipping Name	Hazard Class	UN Number	Packaging Group
US DOT	Potassium Hydroxide Solution	8	UN1814	II
IATA	Potassium Hydroxide Solution	8	UN1814	II
ADR/RID	Potassium Hydroxide Solution	8	UN1814	II
IMDG Code	Potassium Hydroxide Solution	8	UN1814	II
Canadian TDG	Potassium Hydroxide Solution	8(9.2)	UN1814	Not available

15. Regulatory information

US Federal

TSCA	CAS# 7732-18-5	Listed on TSCA Inventory
	CAS# 1310-58-3	Listed on TSCA Inventory

Health & Safety Reporting List None of the chemicals on Health & Safety Reporting List

Chemical Test Rules None of the chemicals are under Chemical Test Rule

Section 12b None of the chemicals are listed under TSCA Section 12b.

TSCA Significant New Use Rule None of the chemicals have a SNUR under TSCA

CERCLA Hazardous Substances and corresponding RQ's CAS# 1310-58-3 1000 lb final RQ; 454kg final RQ

SARA Section 302 Extremely Hazardous Substances None of the chemicals have a TQP

SARA Codes CAS# 1310-58-3 Immediate, Reactive

Section 313 No chemicals are reportable under Section 313

Clean Air Act Does not contain any hazardous air pollutants
Does not contain any Class 1 Ozone depletors
Does not contain any Class 2 Ozone depletors

Clean Water Act	CAS# 1310-58-3	Listed as a Hazardous Substance under the CWA None of the chemicals are listed as Priority Pollutants under the CWA None of the chemicals are listed as Toxic Pollutants under the CWA
OSHA		None of the chemicals are considered highly hazardous by OSHA
STATE	CAS# 7732-18-5	Not present on state lists from CA, PA, MN, MA, or NJ.
	CAS# 1310-58-3	Can be found on the following state right to know lists; CA, NJ, PA, MN, MA.
California Prop 65		California No Significant Risk Level: None of the chemicals are listed.

European/International Regulations

European Labeling in Accordance with EC Directives

Classification	Corrosive	
Hazard Symbol	C	
EC Number	215-181-3	
Risk Phrases	R35	Causes severe burns.
	R22	Harmful if swallowed
Safety Phrases	S1/2	Keep locked up and out of reach of children.
	S26	In case of contact with the eyes, rinse immediately with plenty of water and seek medical advice.
	S36	Wear suitable protective clothing.
	S37/39	Wear suitable gloves and eye/face protection.
	S45	In case of accident or if you feel unwell, seek medical advice immediately (show label where possible).

WGK (Water Danger/Protection)	CAS# 7732-18-5	No information available
	CAS# 1310-58-3	1
Canada – DSL/ NDSL	CAS# 7732-18-5	Listed on Canada’s DSL List
	CAS# 1310-58-3	Listed on Canada’s DSL List
Canada - WHMIS	Classification E, D1B	Classified in accordance with the hazard criteria of the Controlled Products Regulations and the MSDS contains all of the information required by those regulations.
Canadian Ingredient Disclosure List	CAS# 1310-58-3	Listed on the Canadian Ingredient Disclosure List

16. Other information

MSDS Creation Date: 09/30/94 MSDS Revised: December 10, 2010

The information above is believed to be accurate and represents the best information currently available to us. However, we make no warranty of merchantability or any other warranty, express or implied, with respect to such information. Liability is expressly disclaimed for loss or injury arising out of use of this information or the use of any materials designated. Users should make their own investigation to determine the suitability of the information for their particular purpose.

Appendix J Return Authorization Request

Servomex must approve and sign a Return Authorization Number (RAN) to any instrument being returned. The RAN must appear on all paperwork and packaging.

The issuance of a RAN does not automatically imply that the instrument is covered by our warranty.

In order to serve you better and to protect our employees from any potentially hazardous contaminants, Servomex must return, unopened and at the sender's expense, all items that do not have a RAN.

OSHA Hazard Communication Standard 29CFR 1920.1200 mandated that we take specific steps to protect our employees from exposure to potential hazards. Therefore, a letter certifying that the equipment has been decontaminated must accompany all equipment exposed to hazardous contamination.

To obtain a RAN, fill out a copy of this form and fax it to (631) 345-5349.

Customer information:	
Company name:	
Address:	
Contact name:	
Phone:	
Fax:	
Equipment information:	
Part or model number:	MonoExact DF310E / MonoExact DF150E
Serial number:	
Original purchase date:	
PO number:	
Reason for return: (Failure and hookup description if applicable)	
Process material(s) and/or environments (including radiation) to which the equipment has been exposed:	
Has the equipment been decontaminated?	
Does a letter stating that the equipment has been decontaminated accompany the equipment?	

Appendix K AquaXact 1688 digital controller

This chapter explains the unique menu functions of the AquaXact 1688 digital controller. The digital controller can be a MonoExact DF310E that also has a coulometric or paramagnetic oxygen sensor or a standalone AquaXact controller. The common functions and features of the software are documented in the main body of the manual. This appendix only covers the unique features of the AquaXact.

Note: The AquaXact controller has the same analog and digital output options as the DF310E.

Refer to the main AquaXact 1688 Operator Manual for details of the AquaXact 1688 transmitter.

K.1 Dual display



When purchased as a MonoExact DF310E, the screen can show both the results for the oxygen and moisture sensors. The display can be setup to show one or two sensor outputs using the upper right icon in the settings menu (Figure K-1).



Figure K-1: Split display icon



Figure K-2: Split display example

Note: When the display changes to dual display, the icon changes to the single screen icon.  Click on this icon to change the display back to a single screen.

K.2 Moisture units



The units used to report the moisture results can be set using the Units icon which is located on the third page of the measurement menu.

The units that can be set are ppm, dew point degrees Centigrade or dew point degrees Fahrenheit.



Figure K-3: Units icon

K.3 Process and sample system pressures

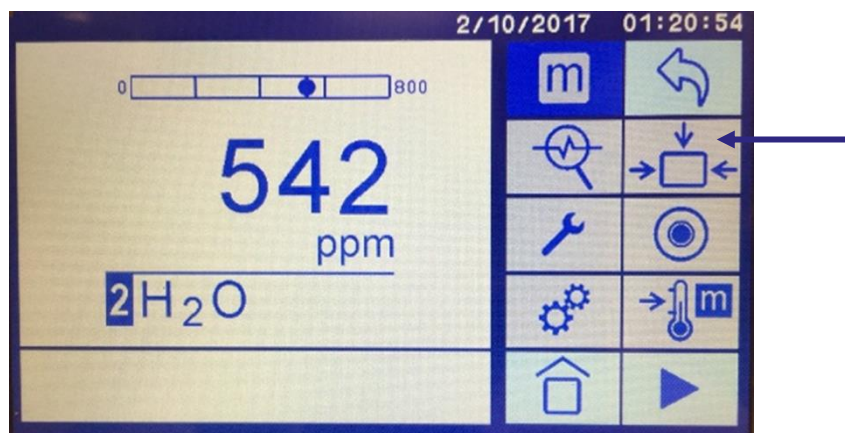

Figure K-4: Pressure compensation icon

As a default the dew point is reported at ambient pressure rather than process pressure (i.e. one atmosphere of pressure).

To calculate the process pressure dew point, the process pressure and the pressure at the dew point transmitter must be entered.

Touch the pressure compensation icon to display the next page (Figure K-5).

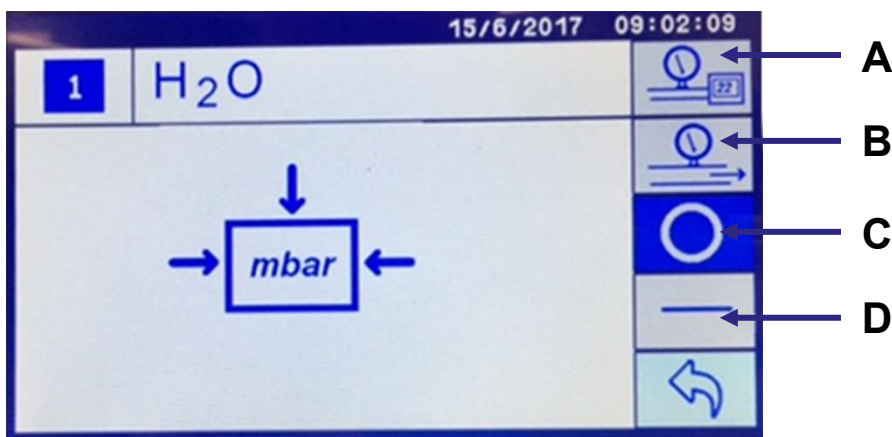





Figure K-5: Transmitter (A) and process stream (B) pressure icons

Touch the Pressure at transmitter (A in Figure K-5) and the Pressure in process stream (B in Figure K-5) icons in turn to display the current value and to enter a new value.

Type in pressure values in mbar on the number pad that displays, followed by the  key.

Note: The default value is atmospheric pressure (1013.25 mbar).

To turn the pressure correction on, press the  icon (C in Figure K-5).

To turn the pressure correction off, press the  icon (D in Figure K-5).

K.4 Setting range limits



The minimum and maximum of the range as output on the 4-20 mA and 0-10 Vdc outputs and shown on the display are set independently using the arrow buttons.



Figure K-6: Range limit icons

K.5 AquaXact calibration

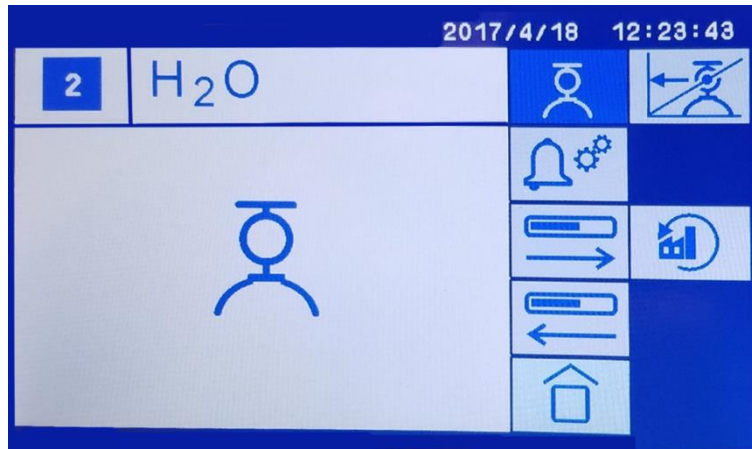



Figure K-7: Calibration screen

The AquaXact offers a single point calibration. Press the  icon to display the numeric keypad where you can type in the calibration value. The calibration value must always be in °C dew-point.

Praxair has a table of ppm and corresponding dew points that customers can use if they normally run in ppm. Refer to the website: <https://www.praxairdirect.com/Specialty-Gas-Information-Center/Techical%20Data/Dew-Point.html>

After the calibration is performed the system can take up to five minutes to stabilize. It will report values in the units that the customer has previously set before the calibration.

To restore the factory calibration settings, press the  icon.

K.6 Replace the sensor tip



Do not store replacement tips for more than 12 months before use to assure the calibration is still valid.

Each sensor tip comes with a USB memory drive that contains the calibration information for the tip.

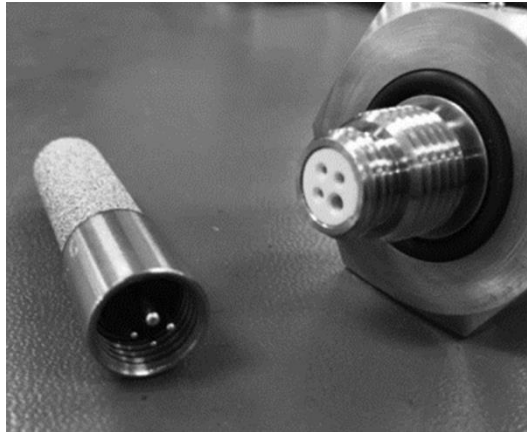

Figure K-8: Sensor tip

To change a sensor tip:

1. Remove the transmitter.
2. Unscrew the old sensor tip and replace it with the new one. Make sure it is secure.
3. Press the tip replacement icon (Figure K-9).

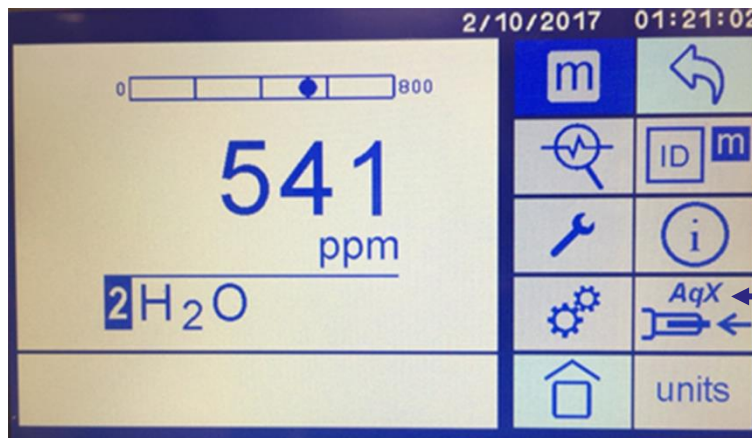

Figure K-9: Tip replacement icon

4. The serial number screen displays (Figure K-10).

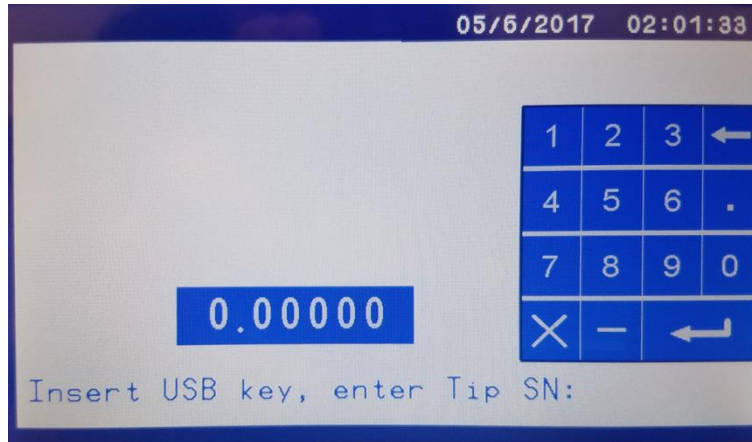













Figure K-10: Enter sensor tip details

5. Insert the USB drive into the slot.
6. Type in the 6-digit serial number of the tip, followed by . The sensor tip serial number is etched on the removable tip barrel.

Note: If the file identified by the serial number is not found, an error is sounded and the display reverts to the previous screen.

K.7 Touchscreen icon glossary

Icon	Meaning	Para.	Icon	Meaning	Para.
	Moisture units	K.2		Pressure correction: off	K.3
	Pressure	K.3		Tip replacement	K.6
	Pressure: pipeline	K.3		Calibrate	K.5
	Pressure: transmitter	K.3		Calibrate: single point calibration value	K.5
	Pressure correction: on	K.3		Restore factory defaults	K.5

Index

A

alarms	
activation.....	63
hysteresis levels.....	63
settings.....	58
Alarms screen.....	58
approvals.....	76
AquaXact.....	139
dual display.....	139
moisture units.....	140
pressures.....	141
range limits.....	142
sensor tip replacement.....	144
touchscreen icons.....	145

B

bench mounting.....	38
---------------------	----

C

calibration.....	68
manual.....	68
span reference value.....	70
calibration gas specification.....	76
calibration periods.....	118
cleaning.....	77
compliance and standards.....	114
contents.....	3
coulometric O ₂ transducers.....	92
add replenishment solution.....	104
GSF.....	94
sample gas preparation and delivery.....	93
acid gas system.....	93
calibration gas considerations.....	101
sample flow rate and pressure.....	97
sample gas compatibility.....	99
sample gas scale factor.....	94
sensor maintenance.....	103
add replenishment solution.....	104
theory of operation.....	92
coulometric transducer	
add electrolyte.....	36

D

date.....	51
Diagnostics screen.....	28
digital controller.....	139
disposal.....	83

E

electrical installation.....	41
analog output connections.....	41
electrical safety.....	41
electrical supply connection.....	46
relay connections.....	43
electrical specification.....	73
electrolyte	
add.....	36
EMC considerations.....	16
environmental limits.....	75
error codes.....	82

F

fuse replacement.....	77
-----------------------	----

G

gas pipeline connection.....	48
gas scale factor.....	55
GSF.....	55

H

Home screen.....	23
------------------	----

I

icons.....	33
index.....	146
installation and set-up.....	36
Alarms screen.....	58
alarms settings.....	58, 63
electrical installation.....	41
analog output connections.....	41
electrical safety.....	41
electrical supply connection.....	46
relay connections.....	43
gas pipeline connection.....	48

mA outputs.....	54
measurement alarms	58
measurement record option	65
mechanical installation.....	38
bench mounting	38
panel mounting.....	38
rack mounting.....	39
O ₂ measurements.....	55
relay configuration	52
setting display/4-20mA range	66
switch on and set up	50
set date	51
set time	51
switch on.....	50
transducer specific installation	36
coulometric	36
add electrolyte.....	36
voltage outputs	54
introduction	6
manual conventions	6
ordering options.....	11
product identification.....	8
product overview	7
safety information conventions	6
scope	6

M

mA outputs	54
Maintenance screen	30
markings	17
Material Safety Data Sheet	129
measurement alarms.....	58
activated alarms	63
Alarms screen	58
alarms settings	58
hysteresis levels.....	63
measurement icons	20
measurement record	65
Measurement screen.....	25
mechanical installation.....	38
bench mounting	38
panel mounting	38
rack mounting	39
mechanical specification.....	73
Menu screen	24
Modbus communications	119

MSDS	129
------------	-----

O

O ₂ measurements	55
operation	72
check relay outputs	72
switch off.....	72
view flow levels	72

P

panel mounting	38
paramagnetic O ₂ transducers	105
cross interference offsets.....	108
measurement errors	107
sample preparation considerations	106
theory of operation	105
performance data	116
coulometric O ₂ trace measurement.....	116
flow alarm	117
paramagnetic O ₂ % measurement	117
preventative maintenance	80

R

rack mounting.....	39
RAN	83, 137
relay configuration	52
replenishment solution	
add.....	104
Return Authorization Number	83, 137
Return Authorization Request	137
routine checks	77
fuse.....	77
routine maintenance	77
cleaning	77
routine checks	77
fuse replacement	77
RS232 options	88
RS485 options	88

S

safety	14
chemical warnings.....	15
electrical warnings	15
general warnings	14
markings.....	17
sample gas preparation and delivery	67
sample gas specification	75

sample wetted materials	91	error codes	82
set date	51	system leak test.....	81
set time	51		
setting display / 4-20mA range.....	66	U	
Settings screen.....	31	unpacking	12
spares.....	84	user interface.....	18
storage	83	Diagnostics screen.....	28
switch off	72	general techniques.....	18
switch on.....	50	measurement icons	20
switch on and set up.....	50	system icons.....	20
set date.....	51	touchscreen icons	19
set time.....	51	touchscreen operation.....	18
switch on	50	Home screen	23
system icons	20	Maintenance screen.....	30
		Measurement screen	25
T		Menu screen	24
technical specification	73	menu structure.....	21
approvals	76	Settings screen	31
calibration gas	76	touchscreen icons	33
electrical	73		
environmental limits	75	V	
maximum voltage ratings.....	74	voltage outputs.....	54
mechanical	73	voltage ratings	74
sample gas.....	75		
time.....	51	W	
touchscreen		warnings	
icons	19	chemical	15
operation.....	18	electrical.....	15
touchscreen icons	33	general	14
transducer specific installation	36	warranty	86
coulometric	36	WEEE Directive	83
add electrolyte	36		
troubleshooting	81		