

MATRICE 200 SERIES

M210/M210 RTK

User Manual V1.4

2018.08

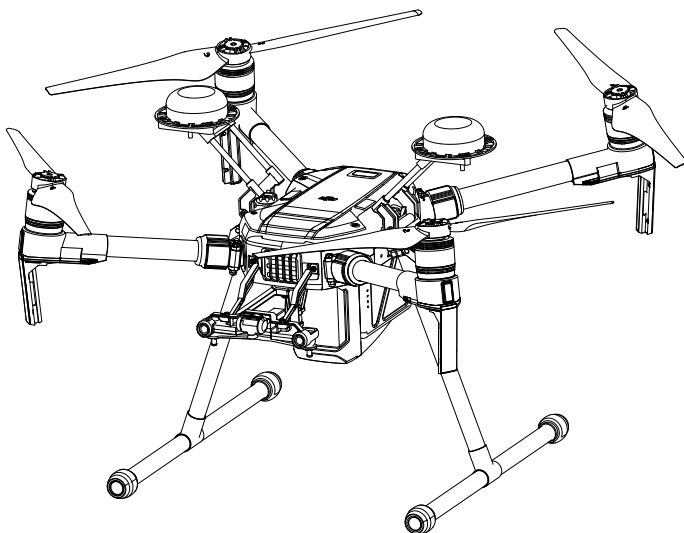

Searching for Keywords

Search for keywords such as “battery” and “install” to find a topic. If you are using Adobe Acrobat Reader to read this document, press Ctrl+F on Windows or Command+F on Mac to begin a search.

Navigating to a Topic

View a complete list of topics in the table of contents. Click on a topic to navigate to that section.

Printing this Document

This document supports high resolution printing.

Using this manual

Legends

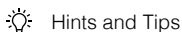

Before Flight

The following materials have been produced to help users make full use of the MATRICE™ 210/210 RTK.

1. In the Box
2. Safety Guidelines and Disclaimer
3. Quick Start Guide
4. Intelligent Flight Battery Safety Guidelines
5. User Manual

Watching all the tutorial videos and reading the Disclaimer before flight is recommended. Afterwards, prepare for your first flight by using the Quick Start Guide. Refer to this manual for more comprehensive information.

Watch the video tutorials

Please watch the tutorial video below to learn how to use Matrice 210/210 RTK correctly and safely:

<http://www.dji.com/matrice-200-series/info#video>



Download the DJI GO 4 app

Be sure to use the DJI GO™ 4 app or other apps compatible with DJI aircraft during flight.

Scan the QR code or visit

“<https://m.dji.net/djigo4>” to download the app.



For the best experience possible, use mobile devices running Android v4.4 or iOS v9.0 or above.

* For increased safety, the flight is restricted to a height of 30 m and distance of 50 m when not connected or logged into the app during flight, including DJI GO 4 and all apps compatible with DJI aircraft.

Download the DJI Assistant 2

Download and install the ASSISTANT™ 2 before use.

<http://www.dji.com/matrice-200-series/info#downloads>

Contents

Using this manual	2
Legends	2
Before Flight	2
Watch the video tutorials	2
Download the DJI GO 4 app	2
Download the DJI Assistant 2	2
Product Profile	6
Introduction	6
Feature Highlights	6
Assemble the Aircraft	7
Preparing the Remote Controller	9
Aircraft Diagram	11
Remote Controller Diagram	12
Aircraft	15
Flight Controller	15
Flight Mode	15
Flight Status Indicator	16
Vision System and Infrared Sensing System	17
Return-to-Home (RTH)	21
Intelligent Flight Modes	26
Flight Recorder	31
Attaching and Detaching the Propellers	31
DJI Intelligent Flight Battery	31
D-RTK and Datalink Pro	37
DJI AirSense	40
Expansion Ports	41
Remote Controller	44
Remote Controller Profile	44
Preparing the Remote Controller	44
Mounting the Monitor to the Remote Controller	46
Remote Controller Operations	47
Dual Remote Controller Mode	52
Linking the Remote Controller	54

Gimbal and Camera	57
Camera	57
Gimbal	58
DJI GO 4	61
Equipment	61
Editor	65
SkyPixel	65
Me	65
Flight	67
Flight Environment Requirements	67
GEO (Geospatial Environment Online) System	67
Flight Restrictions	68
GEO Unlocking	71
Preflight Checklist	71
Calibrating the Compass	71
Auto Takeoff and Auto Landing	73
Starting/Stopping the Motors	73
Stop the Motor Mid-flight	74
Flight Test	74
Appendix	77
Specifications	77
Aircraft Status Indicator Description	80
Upgrading the Firmware	80
Using the Zenmuse XT Gimbal and Camera	81
Single Downward Gimbals	82
Dual Downward Gimbals	84
Mounting the Upward Gimbal and GPS Module	87
Carrying Box Descriptions	89
After-Sales Information	89

Product Profile

This chapter describes the features of the Matrice 210/Matrice 210 RTK, shows how to assemble the aircraft, and contains diagrams of the aircraft and remote controller with component explanations.

Product Profile

Introduction

The Matrice 210/Matrice 210 RTK (M210/M210 RTK) is a powerful aerial imaging system with class-leading agility and speed, redundant components for maximum reliability, and new smart features that make performing complex tasks easy. Gimbal cameras can be easily exchanged to suit your application's needs. Dual frequency remote controller transmission makes HD video downlink more stable and efficient. Upgraded With TapFly™ and ActiveTrack™ flight modes, the aircraft can fly anywhere you tap on screen and track moving subjects effortlessly.

Feature Highlights

The aircraft's mechanical design, along with quick-release landing gears and folding arms, makes it easy to transport, store, and prepare for flight. The drone's new airframe design gives it an IP43 Ingress Protection Rating, in accordance with the global IEC 60529 standard.

Flight Controller: The flight controller has been updated to provide a safer, more reliable flight experience. A new flight recorder stores critical data from each flight. A system of visual sensors enhance hovering precision when flying indoors or in environments where GPS is unavailable. Dual IMUs and barometers design provides redundancy.

HD Video Downlink: The low-latency long range (up to 4.3mi (7km)) HD downlink is powered by an enhanced version of DJI LIGHTBRIDGE™. Support of 2.4 GHz and 5.8 GHz ensures a more reliable connection in environments with more interference.

Camera and Gimbal: The camera unit is now independent from image processor so that you have the flexibility to choose the perfect gimbal and camera system (including ZENMUSE™ X5S/X4S/XT*/XT 2, and Z30) for each of your application. This means that regardless of which camera you choose, you have the same powerful processing backing it. The M210/M210 RTK can support a single upward gimbal or dual downward gimbals.* It is equipped with many expansion ports to broaden its applications. The M210 RTK has a built-in DJI D-RTK™, which provides more accurate heading data for positioning.

Intelligent Flight Battery: The Intelligent Flight Battery features upgraded battery cells and an advanced power management system. Without a payload, the M210 provides up to 27 minutes of flight with TB50-M200 batteries and 38 minutes with high-capacity batteries (TB55). The M210 RTK offers up to 23-minute and 32-minute no-payload flight times with TB50-M200 and high-capacity batteries, respectively.

* The Zenmuse XT Gimbal Adapter is required when mounting the Zenmuse XT gimbal to the Matrice 200 series aircraft.

Both DJI GO 4 and DJI Pilot support the Zenmuse X5S, X4S, and Z30. DJI Pilot is required if using the Zenmuse XT and XT 2.

Gimbals can be purchased separately from the official DJI Online Store.

A GPS module is required when using a single upward gimbal. DO NOT use an upward and downward gimbal simultaneously.

DJI Pilot is required if using the dual downward gimbals.

Assemble the Aircraft

This manual uses the M210 RTK and Zenmuse Z30 as an example to demonstrate setup and usage.

Unfolding the D-RTK Antennas

For the M200 series, only mount the D-RTK antennas to the M210 RTK.
 Unfold the D-RTK antennas and tighten the screws.

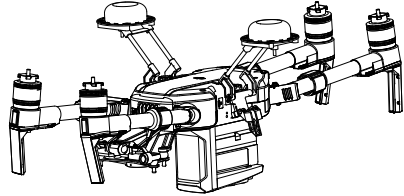
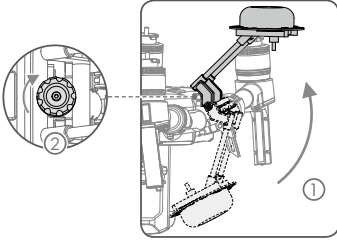

Installing the Landing Gears

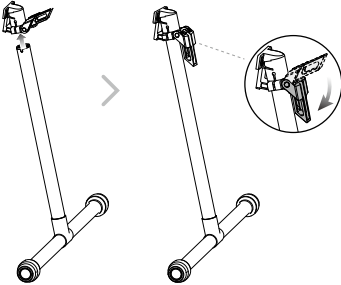

Unfolding the Aircraft

Unfold the frame arm, slide the arm lock to the end of the frame arm, then rotate it about 90° until the silver line lies within the range of the ⇄ icon.

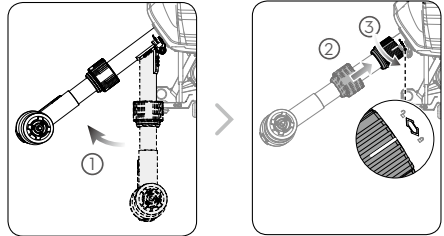

Mounting the Propellers

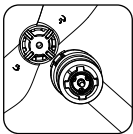

Propellers without silver rings go on motors without any marks.

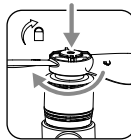

Press the propeller down onto the mounting plate and rotate in the lock direction (⤵) until secure.

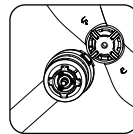

Propellers with silver rings go on motors with the same color marks.

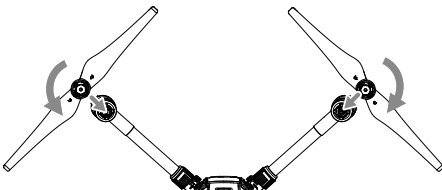

⚠ Check that the propellers are secure before each flight.

Mounting the Gimbal and Camera

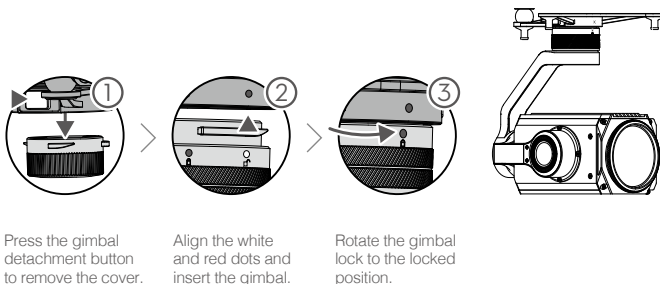

⚠ Make sure to press down the gimbal detachment button when rotating the gimbal lock to remove the gimbal and camera. The gimbal lock should be fully rotated when removing the gimbal for the next installation.

Mounting the Intelligent Flight Batteries

Insert the battery pair.
Press once to check the battery level.
Press once, again, and hold to turn on/off.

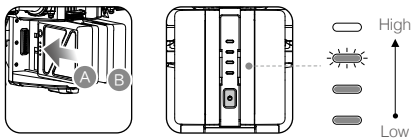

⚠ Only use battery slot B when using one battery to supply power.

Removing the Intelligent Flight Battery

Make sure to press the battery removal button when removing the battery.

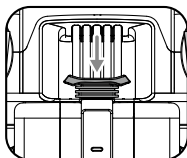

Mounting the D-RTK Ground System

For the M200 series, only mount the D-RTK Ground System to the M210 RTK.

1. Rotate the screws to secure the antenna bracket, and install the battery.
2. Rotate the clamp to secure the battery, and install the Datalink Pro antenna.
3. Install the D-RTK Ground System onto an appropriate tripod.

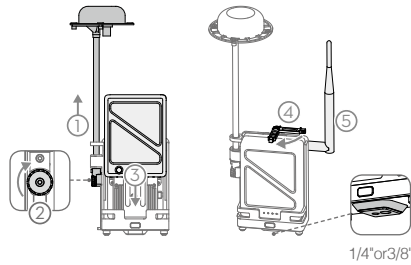

⚠ This manual uses the Datalink Pro 900 as an example. Please refer to the D-RTK and Datalink Pro user guides for more details.

Preparing the Remote Controller

Mounting Monitor and Remote Controller Batteries

CrystalSky monitors and the Cendence remote controller use the same batteries. Put the battery into the Battery Slot, then slide it to the end until you hear a click.

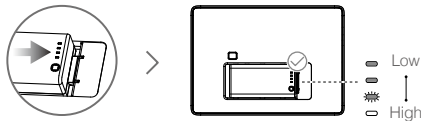

- ⚠**
- Press the Battery Release Button before removing the battery.
 - Press the Battery Level Button once to check the battery level.

Mounting the Monitor to the Remote Controller

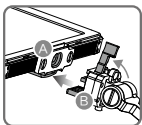

Ensure that Part B is unlocked. Connect Part B to Part A.

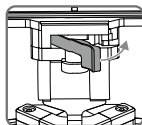

Lock the Mounting Bracket.

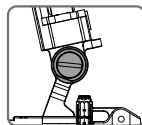

Use a coin to adjust the tightness of the tilt axis.

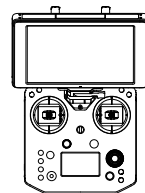

Mounting the Datalink Pro Air System to the Remote Controller

For the M200 series, only mount the Datalink Pro Air System to the M210 RTK remote controller.

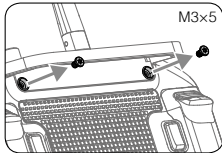

Remove the screws.

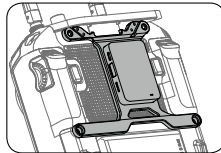

Affix the Datalink Pro Air System onto the mounting board with the double-sided adhesive, then attach the mounting board onto the back of the remote controller.

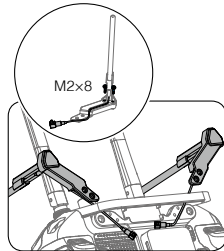

Thread the Datalink Pro antennas through the clips. Make sure that the lines of the antennas lie in the grooves of the mounting board where the clips attach to prevent the antennas from being damaged.

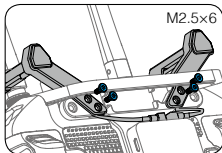

Attach the clips onto the mounting board, then connect the antennas to the Datalink Pro Air System.

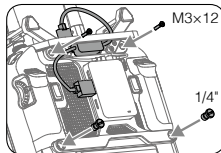

Affix the CAN Hub module to the mounting board with the double-sided adhesive, then secure the mounting board using screws.

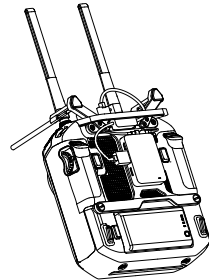

Aircraft Diagram

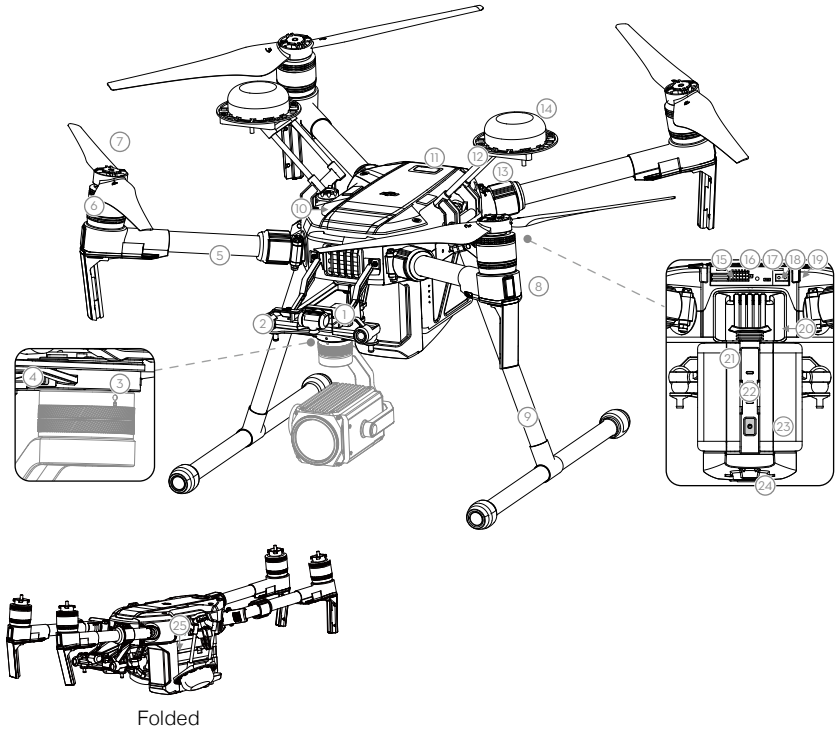

- | | |
|---------------------------------------|--|
| 1. FPV Camera | 14. D-RTK Antennas** |
| 2. Forward Vision System | 15. USB Port |
| 3. DJI Gimbal Connector v2.0 (DGC2.0) | 16. Expansion Ports |
| 4. Gimbal Detachment Button | 17. RC/Aircraft Linking Button and Indicator |
| 5. Frame Arms | 18. USB Mode Switch |
| 6. Motors | 19. Extended Power Port (XT30) |
| 7. Propellers | 20. Battery Removal Button |
| 8. ESC LEDs | 21. Intelligent Flight Batteries |
| 9. Landing Gears | 22. Battery Level Indicators |
| 10. Upward Gimbal Mounting Position | 23. Power Button |
| 11. Upward Infrared Sensor | 24. Downward Vision System |
| 12. Aircraft Status Indicator | 25. Micro SD Card Slot |
| 13. D-RTK Mounting Bracket | |

Remote Controller Diagram

- [1] **HDMI Port**
Output HDMI video signal.
- [2] **USB Port**
Supported extended device, e.g. U disk.
- [3] **Micro SD Card Slot**
Provides extra storage space for the display device, maximum card size is 128 GB.
- [4] **Micro USB Port**
Use a Micro USB cable to connect to the remote controller when in use, or to the PC to configure parameters via DJI Assistant 2. To update aircraft firmware, please use the USB OTG cable.
- [5] **Headphone Jack**
- [6] **Light-sensitive Port**
Built-in light-sensitive sensor.
- [7] **Power Button**
- [8] **Custom Button**
- [9] **Setting Button**
- [10] **Custom Button**
- [11] **Back Button**
- [12] **Battery Release Button**
- [13] **WB37 Intelligent Battery**
- [14] **Antennas**
Relay aircraft control and video signal.
- [15] **Monitor Mounting Bracket**
Used to mount the DJI CrystalSky monitor.
- [16] **Control Sticks**
Control the orientation and movement of the aircraft.
- [17] **Strap Hood**
- [18] **Focus Adjustment Knob**
Rotate to set the focal length.
- [19] **Return-to-Home (RTH) Button**
Press and hold to initiate Return to Home (RTH).

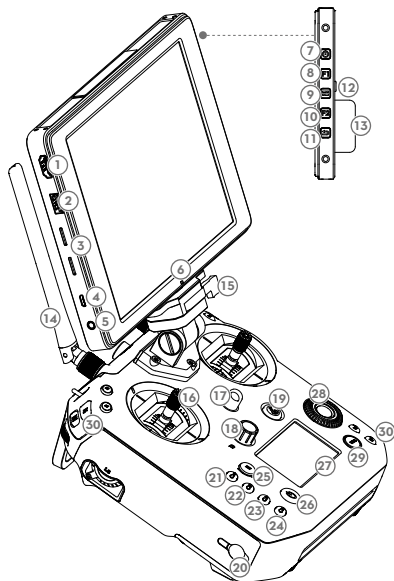

- [20] **Power Port**
Connect to the Charger to charge the battery of the remote controller.
- [21] **EV Setting Button**
Press and rotate the Camera Setting Dial to set the EV.
- [22] **Shutter Setting Button**
Press and rotate the Camera Setting Dial to set the shutter speed.
- [23] **Aperture Setting Button**
Press and rotate the Camera Setting Dial to set the Aperture.
- [24] **ISO Setting Button**
Press and rotate the Camera Setting Dial to set the ISO.
- [25] **Pause Button**
Press once to exit TapFly, ActiveTrack, or other Intelligent Flight Modes.

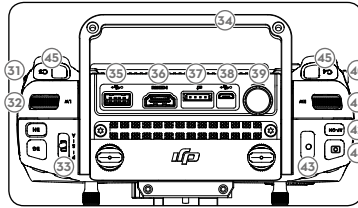

- [26] **Power Button**
Used to turn the Remote Controller on and off.
- [27] **Remote Controller Display**
Shows information about the aircraft and camera.
- [28] **Camera Setting Dial**
Works with the EV, Shutter, Aperture and ISO Settings Buttons to adjust their values.
- [29] **Customizable Button Settings Menu**
Press to set Customizable Button functions in the DJI GO 4 app.
- [30] **Customizable Buttons (BA-BH)**
Customizable through the DJI GO 4 app.
- [31] **Left Lever**
Customizable through the DJI GO 4 app.
- [32] **Left Dial**
Controls gimbal tilt.
- [33] **Flight Mode Switch**
Switch between P-mode, S-mode, and A-mode.
- [34] **Handle Bar**
- [35] **USB Port**
Connection to mobile device for DJI GO 4 app if used a third party mobile device.
- [36] **HDMI A Port**
HDMI A Port is for video output.
- [37] **CAN Bus**
Used to connect external devices.
- [38] **Micro USB Port**
Used to update firmware.
- [39] **SDI Port (for Video Output)**
Used for video output.
- [40] **Right Lever**
Customizable through the DJI GO 4 app.
- [41] **Right Dial**
Used to control gimbal pan.
- [42] **Auto Focus Button**
Press to focus automatically.
- [43] **Record Button**
Press to start recording video. Press again to stop recording.
- [44] **Shutter Button**
Press to take a photo. Photos can also be captured during video recording.
- [45] **Customizable Buttons (C1-C4)**
Customizable through the DJI GO 4 app.

Aircraft

This section describes the features of the Flight Controller, Vision System, and the Intelligent Flight Battery.

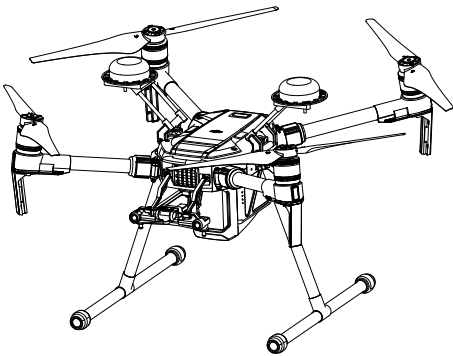

Aircraft

Flight Controller

The M210/M210 RTK flight controller features several important upgrades. Safety modes include Failsafe and Return-to-Home. These features ensure the safe return of your aircraft if control signal is lost. The flight controller can also save critical flight data from each flight to the on-board storage device. The new flight controller also provides increased stability and a new air braking feature.

Flight Mode

The following flight modes are available for the aircraft:

P-mode (Positioning) :

P-mode works best when the GPS signal is strong. The aircraft utilizes the GPS and Forward and Downward Vision Systems to locate itself, automatically stabilize, and navigate between obstacles. Intelligent Flight Modes such as TapFly and ActiveTrack are enabled in this mode.

When the Forward Vision System is enabled and lighting conditions are sufficient, the maximum flight attitude angle is 25°. When forward obstacle sensing is disabled, the maximum flight attitude angle is 30°.

When the GPS signal is weak and lighting conditions are too dark for the Forward and Downward Vision Systems, the aircraft will only use its barometer for positioning to control altitude.

Note: P-mode requires larger stick movements to achieve higher speeds.

S-mode (Sport):

The aircraft uses GPS for positioning. As Forward and Downward Vision Systems are disabled, the aircraft will not be able to sense and avoid obstacles when in Sport Mode. Ground Station and the Intelligent Flight functions are also not available in Sport Mode.

Note: Aircraft responses are optimized for agility and speed making it more responsive to stick movements.

A-mode (Attitude):

When neither the GPS nor the Vision Systems are available, the aircraft will only use its barometer for positioning to control the altitude. Ground Station and the Intelligent Flight functions are also not available in A-mode.



• The Forward Vision System is disabled in S-mode (Sport), which means the aircraft will not be able to automatically avoid obstacles in its flight path. Be vigilant and stay clear of nearby obstacles.

- The aircraft's maximum speed and braking distance are significantly increased in S-mode (Sport). A minimum braking distance of 164 feet (50 meters) is required in windless conditions.
- The aircraft's responsiveness is significantly increased in S-mode (Sport), which means a small stick movement on the remote controller will translate into a large travel distance of the aircraft. Be vigilant and maintain adequate maneuvering space during flight.
- The aircraft's descent speed is significantly increased in S-mode (Sport). A minimum braking distance of 164 feet (50 meters) is required in windless conditions.



Use the Flight Mode switch on the remote controller to select aircraft flight modes.

Atti Mode Warning

The aircraft will enter A-mode in the following two instances:

Passive: When there is weak GPS signal or when the compass experiences interference where the Vision System is unavailable.

Active: Users toggle the flight mode switch to A-mode.

In A-mode, the Vision System and some advanced features are disabled. Therefore, the aircraft cannot position or auto-brake in this mode and is easily affected by its surroundings, which may result in horizontal shifting. Use the remote controller to position the aircraft.

Maneuvering the aircraft in A-mode can be difficult. Before switching the aircraft into A-mode, make sure you are comfortable flying in this mode. DO NOT fly the aircraft too far away as you might lose control and cause a potential hazard.

Avoid flying in areas where GPS signal is weak, or in confined spaces. The aircraft will otherwise be forced to enter A-mode, leading to potential flight hazards, please land it in a safe place as soon as possible.



Flight Status Indicator

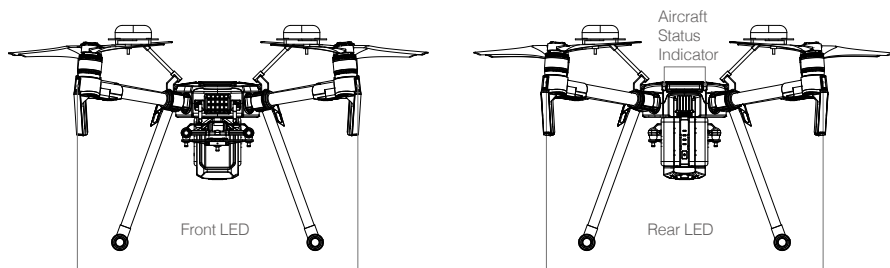





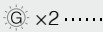

The aircraft features Front LEDs, a Rear LED, and Aircraft Status Indicators. The positions of these LEDs are shown in the figure below:



The Front LEDs show the orientation of the aircraft. Front LEDs glow solid red when the aircraft is turned on to indicate the front (or nose) of the aircraft. Front and rear LEDs can be turned off in the DJI GO 4 app. The Aircraft Status Indicators communicate the system status of the flight controller. Refer to the table below for more information about the Aircraft Status Indicators.

Aircraft Status Indicator Description

Normal		
	Red, yellow, green, blue, and purple flashes	Turning On and Self Diagnostic Testing
	Four yellow flashes	Warming Up
	Slow green flashing	P-mode with GPS*
	Two green flashes	P-mode with Forward and Downward Vision Systems*

	Slow yellow flashing	No GPS and Forward and Downward Vision Systems
	Fast green flashing	Braking
Warning		
	Fast yellow flashing	Remote Controller Signal Lost
	Slow red flashing	Low Battery Warning
	Fast red flashing	Critical Low Battery Warning
	Red flashing	IMU Error
 —	Solid Red	Critical Error
	Fast alternating red and yellow flashing	Compass Calibration Required

* Slow green flashes indicate P-mode, and fast green flashes indicate S-mode.

Vision System and Infrared Sensing System

The main components of the Vision System are located on the front and bottom of the aircraft, including [1] [3] stereo vision sensors and [2] two ultrasonic sensors. The Vision System uses ultrasound and image data to help the aircraft maintain its current position, enabling precision hovering indoors or in environments where a GPS signal is not available. The Vision System constantly scans for obstacles, allowing the aircraft to avoid them by going over, going around, or hovering.

The Infrared Sensing System consists [4] of two infrared modules on top of the aircraft. These scan for obstacles on top side of the aircraft and is active in certain flight modes.

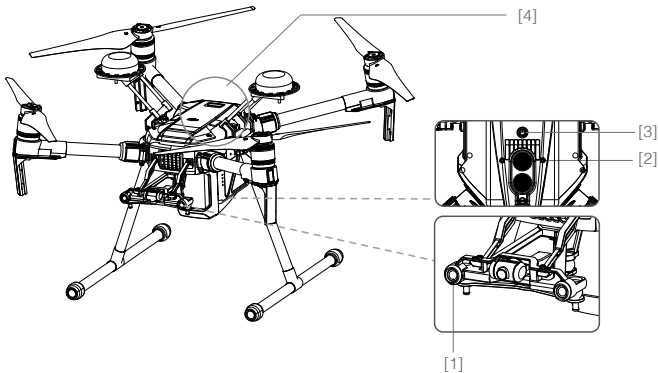

Detection Range

The detection range of the Vision System is depicted below. Note that the aircraft cannot sense and avoid obstacles that are not within the detection range.

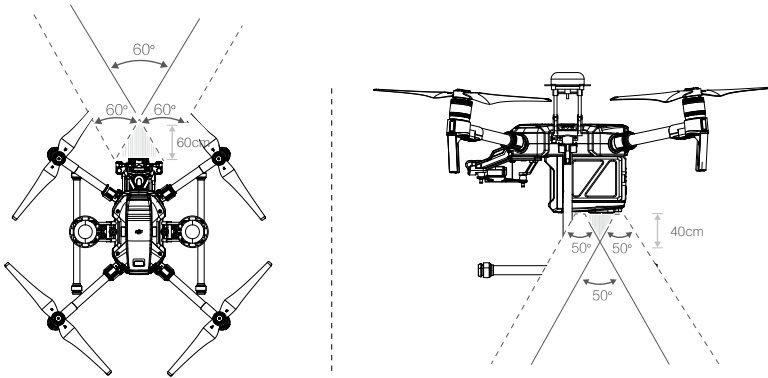

 The aircraft cannot detect objects in low-light conditions. Please fly with caution.

Ultrasonic sensor detection range is depicted below.

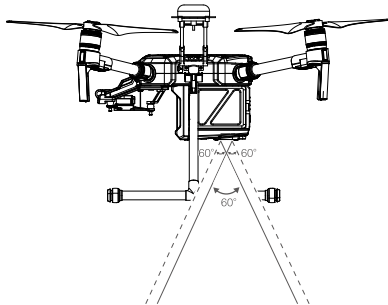

Infrared Sensing System detection range is depicted below.

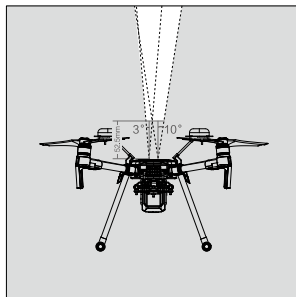

Calibration

The Forward and Downward Vision System cameras are calibrated prior to delivery. However, these cameras are vulnerable to impact and will require occasional calibration via DJI Assistant 2.

Calibration with the included Visual Calibration Plate.

1. Power on the Intelligent Flight Battery and toggle the USB Mode Switch left.
2. Connect the aircraft and the PC with a male to male USB cable.
3. Launch DJI Assistant 2 and log in with a DJI account.
4. Click M200SERIES and the calibration button.

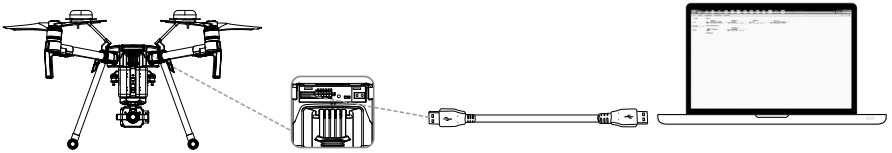

5. Place the side of visual calibration plate with the dots facing the Forward Vision System, and follow the instructions in the DJI Assistant 2 to complete calibration.
6. Place the aircraft straight, and ensure the dotted side of the visual calibration plate faces the Downward Vision System. Follow the instructions in DJI Assistant 2 to complete calibration.

Calibrating with a Screen

Follow the steps below to calibrate the camera.

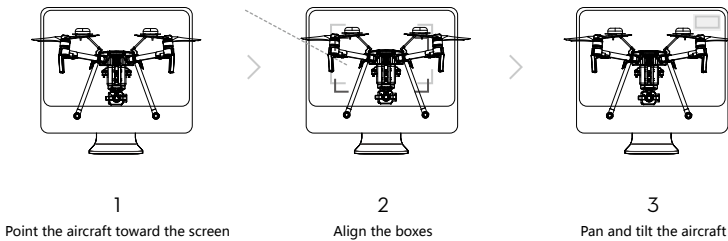

⚠ DO NOT power off or unplug the USB cable after calibration. Wait for data calculation.

Using the Vision System

The Vision System is activated automatically when the aircraft is turned on. No further action is required. The Vision System enables precision hovering indoors or in environments where GPS signal isn't available.

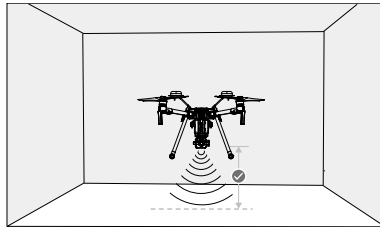

Follow the steps below to use the Vision System:

1. Ensure the aircraft is in P-mode and place the aircraft on a flat surface. Note that the Vision System cannot work properly on surfaces without clear pattern variations.
2. Turn on the aircraft. The aircraft will hover in place after takeoff. The aircraft status indicators will flash green twice, which indicates the Vision System is working. Gently push the left stick up to lift off and the aircraft will hover in place.



Assisted Braking from Obstacle Sensing

Powered by the Forward Vision System, the aircraft is able to actively brake when obstacles are detected in front. Obstacle Sensing works best when lighting is adequate and the obstacle is clearly textured. The aircraft must fly at no more than 31 mph (50 kph) to allow for sufficient braking distance.

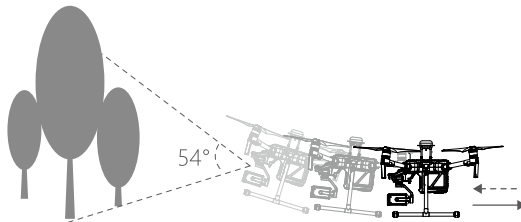

Using Infrared Sensing System

The Infrared Sensing System can only be used to avoid large, diffuse, and reflective obstacles (reflectivity >10%). Please be mindful of blind spots (Grey) of the Infrared Sensing System.

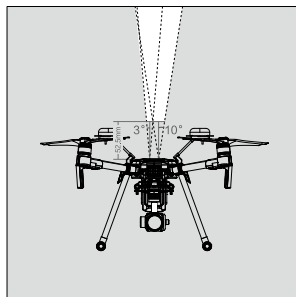

-  • The performance of your Vision System and Infrared Sensing System is affected by the surface being flown over. Ultrasonic sensors may not be able to accurately measure distances when operating above sound-absorbing materials and the cameras may not function correctly in suboptimal environments. The aircraft will switch from P-mode to A-mode automatically if neither GPS nor Vision System and Infrared Sensing System are available. Operate the aircraft with great caution in the following situations.

The Vision System will be disabled when:

- a) Flying over monochrome surfaces (e.g. pure black, pure white, pure red, pure green).
- b) Flying over highly reflective surfaces.
- c) Flying over water or transparent surfaces.
- d) Flying over moving surfaces or objects.
- e) Flying in an areas where the lighting changes frequently or drastically.
- f) Flying over extremely dark (lux < 10) or bright (lux > 100,000) surfaces.
- g) Flying over surfaces without clear patterns or texture.
- h) Flying over surfaces with identical repeating patterns or textures (e.g. tiling).
- i) Flying at high speeds of over 31 mph (50 kph) at 2 meters or over 11 mph (18 kph) at 1 meter.

The Ultrasonic sensors will be disabled when:

- a) Flying over surfaces that can absorb sound waves (e.g. thick carpet).
- b) Flying over inclined surfaces that will deflect sound waves away from the aircraft.

The Infrared be disabled when:



- a) Flying over obstacles with too small effective infrared reflective surface.
- b) DO NOT cover the protective glass of the infrared module. Keep it clean and undamaged.

-  • Keep sensors clean at all times. Dirt or other debris may adversely affect their effectiveness.
- Vision System is only effective when the aircraft is at altitudes of 0.3 to 10 meters.
 - The Vision System may not function properly when the aircraft is flying over water.
 - The Vision System may not be able to recognize pattern on the ground in low light conditions (less than 100 lux).
 - Do not use other ultrasonic devices with frequency of 40 KHz when Vision System is in operation.

-  Keep away from animals while operating the aircraft, as the ultrasonic sensors emit high-frequency sounds which may disturb them.

Return-to-Home (RTH)

The Return-to-Home (RTH) function brings the aircraft back to the last recorded Home Point. There are three types of RTH: Smart RTH, Low Battery RTH, and Failsafe RTH. This section describes these three RTH types in detail.

	GPS	Description
Home Point		If a strong GPS signal was acquired before takeoff, the Home Point is the location from which the aircraft launched. The GPS signal strength is indicated by the GPS icon  . Less than 4 bars is considered a weak GPS signal. The aircraft status indicator will blink rapidly when the home point is recorded.

⚠ The aircraft can sense and avoid obstacles when the Forward Vision System is enabled and lighting conditions are sufficient. The aircraft will automatically ascend to avoid obstacles and descend slowly as it returns to the home point. To ensure the aircraft returns home while facing forward, it cannot rotate or fly left and right during RTH while the Forward Vision System is enabled.

Smart RTH

Use the RTH button on the remote controller or tap the RTH button in the DJI GO 4 app and follow the on-screen instructions when GPS is available to initiate Smart RTH. The aircraft will then automatically return to the last recorded Home Point. Use the remote controller to control the aircraft's speed or altitude to avoid a collision during the Smart RTH process. As the aircraft returns, it will use the primary camera to identify obstacles as far as 300m in front, allowing it to plan a safe route home. Press and hold the Smart RTH button once to start the process, and press the Smart RTH button again to terminate the procedure and regain full control of the aircraft.

Low Battery RTH (Can be turned off in DJI GO 4 app)

The low battery level failsafe is triggered when the DJI Intelligent Flight Battery is depleted to a point that may affect the safe return of the aircraft. Users are advised to return home or land the aircraft immediately when prompted. The DJI GO 4 app will display a notice when a low battery warning is triggered. The aircraft will automatically return to the Home Point if no action is taken after a ten-second countdown. The user can cancel the RTH procedure by pressing the RTH button on the remote controller. The thresholds for these warnings are automatically determined based on the aircraft's current altitude and distance from the Home Point. If the RTH procedure is cancelled following a low battery level warning the Intelligent Flight Battery may not have enough charge for the aircraft to land safely, which may lead to the aircraft crashing or being lost.

The aircraft will land automatically if the current battery level can only support the aircraft long enough to descend from its current altitude. The user cannot cancel the auto landing but can use the remote controller to alter the aircraft's orientation during the landing process.

The Battery Level Indicator is displayed in the DJI GO 4 app, and is described below:

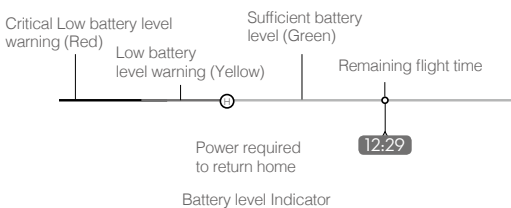

Battery Level Warning	Remark	Aircraft Status Indicator	DJI GO 4 App	Flight Instructions
Low battery level warning	Battery power is low. Land the aircraft.	Aircraft status indicator blinks RED slowly.	Tap "Go-home" to have the aircraft return to the Home point and land automatically, or "Cancel" to resume normal flight. If no action is taken, the aircraft will automatically go home and land after 10 seconds. Remote controller will sound an alarm.	Fly the aircraft back and land it as soon as possible, then stop the motors and replace the battery.
Critical Low battery level warning	The aircraft must land immediately.	Aircraft status indicator blinks RED quickly.	The DJI GO 4 app display will flash red and the aircraft will start to descend. The remote controller will sound an alarm.	Allow the aircraft to descend and land automatically.
Estimated remaining flight time	Estimated remaining time is based on current battery level.	N/A	N/A	N/A



- When the Critical Low battery level warning is triggered and the aircraft begins to land automatically, push the left stick upward to make the aircraft hover at its current altitude, giving you an opportunity to navigate to a more appropriate landing location.
- The colored zones and markers on the battery level indicator bar reflect the estimated remaining flight time. They are automatically adjusted according to the aircraft's current location and status.

Failsafe RTH

If the Home Point was successfully recorded and the compass is functioning normally, Failsafe RTH will be automatically activated if the remote controller signal is lost for more than three seconds. The aircraft will plan its return route and retrace its original flight route home. The user may cancel Failsafe RTH to regain control when connection is reestablished.

RTH Procedure

1. Home Point is recorded automatically.
2. RTH procedure is triggered i.e., Smart RTH, Low-Battery RTH, and Failsafe RTH.
3. Home Point is confirmed and the aircraft adjusts its orientation.
4. a. The aircraft will ascend to the pre-set RTH attitude and then fly to the Home Point when the aircraft is further than 20 m from the Home Point.
 b. The aircraft will land automatically if RTH is triggered and the aircraft is less than 20 m from the home point.
5. The aircraft will hover 0.7 m above ground and wait for confirmation from the user. The aircraft will land and stop its motors after user confirmation.

Use the Failsafe RTH for example:

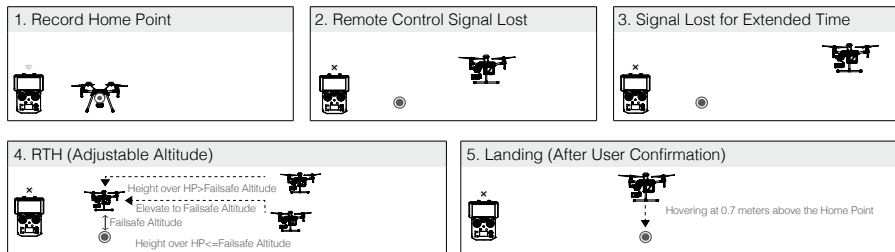

- ⚠ Aircraft cannot return to the Home Point when GPS signal is weak ([📶] Less than 4 bars is considered a weak GPS signal) or unavailable.
- User cannot control the aircraft while the aircraft is ascending to 65 feet (20 meters) from the current altitude. However, users can press the RTH button once to exit ascending and regain control.
- The aircraft will automatically descend and land if RTH is triggered when the aircraft flies within a 65 feet (20 meters) radius of the Home Point. The aircraft will stop ascending and will return to the Home Point if the aircraft reaches 65 feet (20 meters) in altitude or beyond during Failsafe.
- The aircraft cannot avoid obstacles during Failsafe RTH if the Forward Vision System is disabled. It is important to set a suitable RTH Altitude before each flight. Launch DJI GO 4, enter camera and tap 📷 to set Failsafe Altitude.

Failsafe Safety Notices

	<p>The aircraft cannot avoid obstacles during Failsafe RTH when the Forward Vision System is disabled. Therefore, it is important to set a suitable Failsafe altitude before each flight. Launch the DJI GO 4 app, enter Camera and tap 📷 to set the Failsafe Altitude.</p>
	<p>If the aircraft is flying under 65 feet (20 meters) and Failsafe (including Smart RTH, Lower Battery RTH) is triggered, the aircraft will first automatically ascend to 65 feet (20 meters) from the current altitude. You can only cancel the ascending by exiting the Failsafe.</p>
	<p>The aircraft automatically descends and lands if RTH is triggered when the aircraft flies within a 65 foot (20 meter) radius of the Home Point. The aircraft will stop ascending and immediately return to the Home Point if you move the left stick when the aircraft is flying at an altitude of 65 feet (20 meters) or higher and Failsafe is triggered.</p>
	<p>The aircraft cannot return to the Home Point when GPS signal is weak ([📶] displaying less than four bars) or is unavailable.</p>



If you move the left stick when the aircraft is flying above 65 feet (20 meters) but below the pre-set Failsafe RTH altitude, the aircraft will stop ascending and immediately return to the Home Point.

Obstacle Avoidance During RTH

The aircraft can sense and actively attempt to avoid obstacles during RTH, provided that lighting conditions are adequate for the Forward Vision System. Upon detecting an obstacle, the aircraft will act as follows:

1. The aircraft will use the primary camera to identify obstacles as far away as 984 feet (300 meters) in front, allowing it to plan a safe route home.
2. The aircraft decelerates when an obstacle is sensed at 49 feet (15 meters) ahead.
3. The aircraft stops and hovers then starts ascending vertically to avoid the obstacle. Eventually, the aircraft will stop climbing when it is at least 16 feet (5 meters) above the detected obstacle.
4. RTH procedure resumes. The aircraft will continue flying to the Home Point at the current altitude.

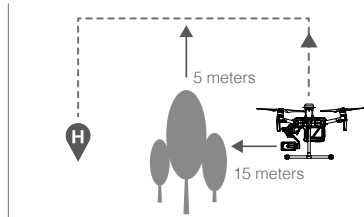
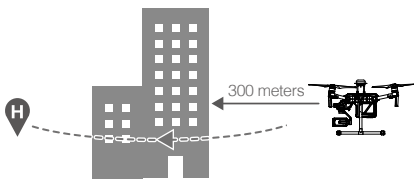

- ⚠**
- Obstacle Sensing is disabled during RTH descent. Proceed with care.
 - To ensure the aircraft returns home forwards, it cannot rotate during RTH while the Forward Vision System is enabled.
 - The aircraft cannot avoid obstacles beside or behind it.

Landing Protection Function

Landing Protection will activate during auto-landing.

1. Landing Protection determines whether the ground is suitable for landing. If so, the aircraft will land smoothly.
2. If Landing Protection determines that the ground is not suitable for landing, the aircraft will hover and wait for pilot confirmation. The aircraft will hover if it detects the ground is not appropriate for landing even with a critically low battery warning. Only when the battery level decreases to 0% will the aircraft land. Users retain control of aircraft flight orientation.
3. If Landing Protection is inactive, the DJI GO 4 app will display a landing prompt when the aircraft descends below 0.7 meters. Tap to confirm or pull down the control stick for 2 seconds to land when the environment is appropriate for landing.

- ⚠ Landing Protection will not be active in the following circumstances:
- When the user is controlling the pitch/roll/throttle sticks (Landing Protection will re-activate when the control sticks are not in use)
 - When the positioning system is not fully functional (e.g. drift position error)
 - When the downward vision system needs re-calibration
 - When light conditions are not sufficient for the downward vision system
 - If an obstacle is within one meter of the aircraft, the aircraft will descend to 0.7m above the ground and hover. The aircraft will land after user confirmation.

Intelligent Flight Modes

The aircraft supports Intelligent Flight Modes, including TapFly, ActiveTrack*, and Tripod Mode. Tap  in DJI GO 4 or press the Function button on the remote controller to enable an Intelligent Flight Mode.

* Zenmuse X4S or X5S is required when using the ActiveTrack. ActiveTrack is not supported when using the Z30, XT and XT 2.

ActiveTrack is not supported to use with the dual downward gimbals.

TapFly

Introduction

With the TapFly feature, users can now tap on the mobile device screen to fly in the designated direction without using the remote controller. The aircraft will automatically avoid obstacles it sees or brake and hover in front of them, provided that there is sufficient light between (< 300 lux) and (> 10,000 lux).

Using TapFly

Ensure that the Intelligent Flight Battery is fully charged and the aircraft is in P-mode. Follow the steps below to use TapFly:

1. Take off and ensure the aircraft is hovering at least 6 ft (2 m) above ground.

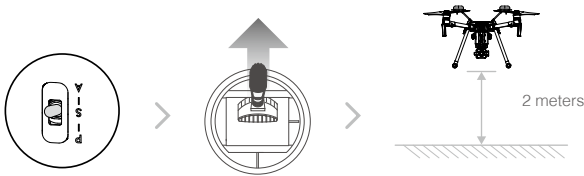

2. Launch DJI GO 4 and tap , Select TapFly, then follow the prompts.

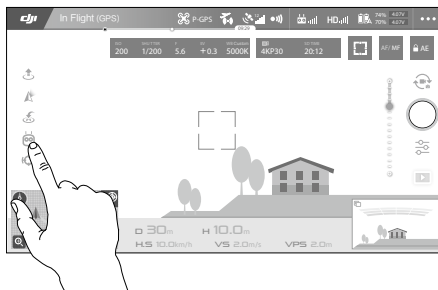

3. Tap once on the target and wait for the “GO” icon to appear. Tap the “GO” icon to confirm the selection and the aircraft will automatically fly toward the target.

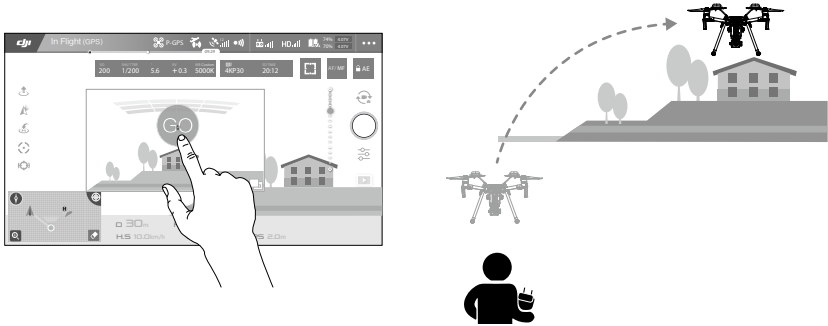

- ⚠️ • DO NOT fly the aircraft over people, animals, small or fine objects (e.g. tree branches and power lines) or transparent objects (e.g. glass or water). TapFly may not work properly when the aircraft is flying over water or snow covered areas.
- Watch for obstacles in the flight path and steer clear of them.
- There may be deviations between expected and actual flight paths selected in TapFly.
- The selectable range for target direction is limited. You cannot make a selection in Direction close to the upper or lower edge of the screen.
- Be extra cautious when flying in too dark (< 300 lux) or too bright (> 10,000 lux) environments.

☀️ Enable control stick control of the gimbal inside DJI GO 4 to control gimbal orientation using the remote controller. When using the control sticks, the gimbal will automatically switch to Free mode. In this situation, the control stick used to control pitch on the aircraft now controls gimbal pitch, and the control stick used to control aircraft roll now controls gimbal pan. The left dial now controls flight speed.

After confirming your TapFly selection, the aircraft will fly in the direction marked by the  icon. Note that you can still use the control stick to control the movement of the aircraft during the flight.

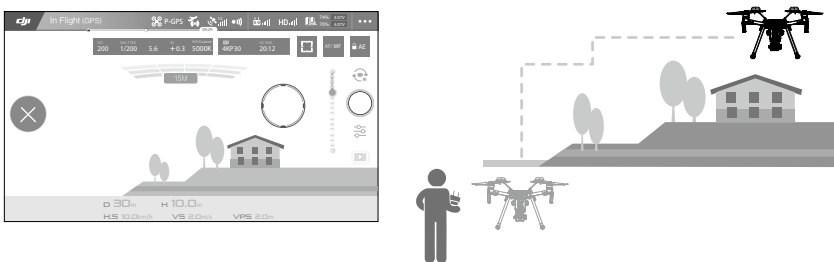

The aircraft automatically adjusts its speed when it senses an obstacle in front, or if it flies too close to the ground. The DJI GO 4 app will show a prompt if the aircraft flies over an obstacle or to the left or right of the obstacle. However, this feature should not be relied upon for navigation between obstacles. Failsafe procedures will override TapFly. If the GPS signal weakens, the aircraft will exit autonomous flight and return to home.

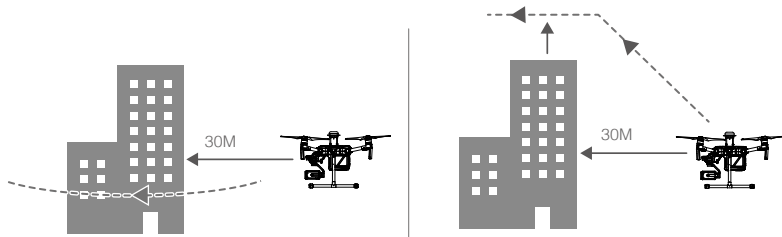

Exit TapFly

Use the following methods to exit TapFly:

1. Tap the "✕" icon on the screen.
2. Pull back the pitch stick on the remote controller and hold for three seconds or more..
3. Press the Intelligent Flight Pause button on the remote controller.

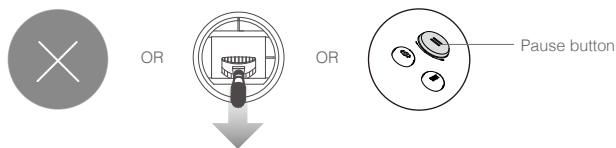

The aircraft will stop and hover after exiting from TapFly. Tap a new target direction to continue flying or begin manual flight.

ActiveTrack

ActiveTrack allows you to mark and track a moving object on your mobile device's screen. The aircraft will automatically avoid obstacles in its flight path. No external tracking device is required. The aircraft will automatically identify and trace bicycles and other vehicles, people, and animals, using different tracking strategies for each.

Using ActiveTrack

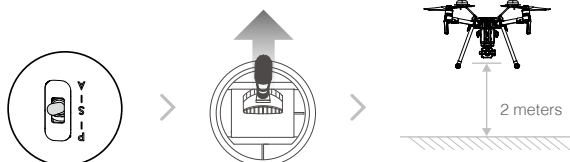

Ensure the Intelligent Flight Battery is fully charged and the aircraft is in P Mode. Follow the steps below to use ActiveTrack:

1. Take off and hover at least 6 feet (2 meters) above the ground.

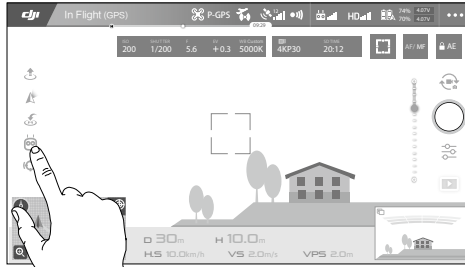

2. In DJI GO 4, tap  to bring up the flight modes and select ActiveTrack.



3. Tap on the subject you want to track, then tap  to confirm your selection. If the subject is not automatically recognized, drag a box around it. The box  will turn green when tracking is in progress. If the box turns red, the object was not identified and you should try again.

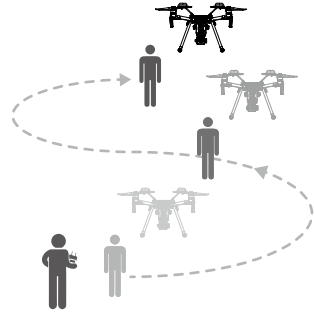
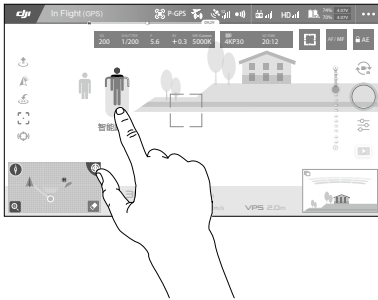

ActiveTrack includes the following functions:

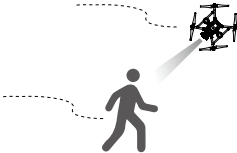
Trace	Profile
	
<p>The aircraft tracks the subject at a fix distance. Use the roll stick on the remote controller or the slider in DJI GO 4 to circle the subject.</p>	<p>The aircraft tracks the subject at fix angle and distance from the side. Use the roll stick on the remote control to circle the subject. The aircraft will not be able to avoid obstacles while in Profile Mode. Use this mode in open areas.</p>

- ⚠ • DO NOT select an area with people, animals, small or fine objects (e.g. trees and power lines), or transparent objects (e.g. glass or water).
- Stay clear of obstacles near the flight path, particularly when the aircraft is flying backward.
- Be extra vigilant when using ActiveTrack in any of the following situations:
 - a) The tracked subject is not moving on a level plane.
 - b) The tracked subject changes shape drastically while moving.
 - c) The tracked subject could be blocked or out of sight for a long time.
 - d) The tracked subject is moving on a snowy surface.
 - e) Available light is too low (< 300 lux) or too high (> 10,000 lux).
 - f) The tracked subject has a similar color or pattern as its surrounding environment.
- You must follow local privacy laws and regulations when using ActiveTrack.
- Aircraft will not be able to avoid obstacles while in Profile or Spotlight Mode. Use these modes in open areas.

Exiting ActiveTrack

Use the following methods to exit ActiveTrack:

1. Tap the “✖” button on the screen.
2. Press the Intelligent Flight Pause button on the remote controller.



After exiting ActiveTrack, the aircraft will hover in place, at which point you may choose to fly manually, track another subject, or return to home.

Tripod Mode

Tap the icon in DJI GO 4 to enable Tripod Mode. Tripod Mode reduces the aircraft's maximum speed (this can be adjusted in DJI GO 4 app), and the control stick sensitivity of the remote controller is dulled to give you the precision you need for accurate framing. Tripod Mode allow the aircraft to be used as a rocker arm or slide rail, shooting smoother, more stable footage.

- ⚠ Only use Tripod mode when GPS signal is strong or in ideal light conditions for the Vision System. If GPS signal is lost and the Vision System does not function, it will automatically switch to ATTI mode. In this case, flight speed will increase and the aircraft will not hover in place. Use Tripod mode carefully.

Spotlight Pro

Spotlight Pro is a powerful new tracking mode that allows a single pilot to capture complex, dramatic images. The gimbal will automatically adjust to keep the camera pointing at the subject. Lock onto a subject in Spotlight Pro mode and the gimbal will capture the locked subject regardless of the directions that the aircraft flies.

Quick Mode: Use your finger to draw a square around the object in to begin tracking.

Composition Mode: Use your finger to draw a square. When the subject enters the square, press the C2 button to begin tracking. Press the C2 button again to stop tracking.

In Free mode, you can control the aircraft's heading independently of the camera.

In Follow mode, the aircraft heading will be the same as that of the camera.

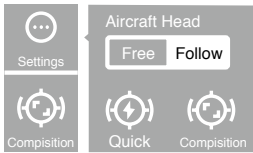

- ⚠ • You can drag on a subject in DJI GO 4 or move the gimbal control sticks to change the subject's position in the shot.
- Spotlight Pro can be used in S-mode, A-mode, TapFly and Tripod mode.

Flight Recorder

Flight data is automatically recorded to the internal storage of the aircraft. You can connect the aircraft to a computer via the USB port and export this data via DJI Assistant 2.

Attaching and Detaching the Propellers

Attaching the Propellers

Refer to "Mounting the Propellers" for details.

Detaching the Propellers

Press the propeller down onto the mounting plate and rotate it in the unlock direction.

- ⚠ • Propeller blades are sharp; please handle with care.
- Only use DJI approved propellers. DO NOT mix propeller types.
- Stay clear of spinning motors. DO NOT touch the propellers when they are spinning.
- Ensure to check that the propellers and motors are installed firmly and correctly before each flight.
- Ensure that all propellers are in good condition before each flight. DO NOT use aged, chipped, or broken propellers.
- To avoid injury, stand clear of and DO NOT touch propellers or motors when they are spinning.
- Please use original DJI propellers for a better and safer flight experience.

DJI Intelligent Flight Battery

Matrice 210/210 RTK provides two types of Intelligent Flight Battery, which have the same functions. The main difference between TB50-M200 and TB55 is that the TB55 is a high-capacity battery. This manual uses the TB50-M200 as an example to demonstrate setup and usage.

The TB50-M200 Intelligent Flight Battery has a capacity of 4280 mAh, a voltage of 22.8 V, and a smart charge/discharge functionality. It should only be charged using appropriate DJI approved chargers.

DJI Intelligent Flight Battery Functions

1. Battery Level Display: The LED indicators display the current battery level.
2. Auto-Discharging: To prevent swelling, the battery automatically discharges to below 70% of the total power when it is idle (press the power button to check that the battery level will cause the battery to exit idle state) for more than 10 days to prevent swelling. It takes around 3 days to discharge the battery to 65%. It is normal to feel moderate heat emitting from the battery during the discharge process. Discharge thresholds can be set in DJI GO 4.
3. Balanced Charging: Automatically balances the voltage of each battery cell when charging.
4. Overcharge Protection: Charging automatically stops when the battery is fully charged.
5. Temperature Detection: The battery will only charge when the temperature is between 5 °C (41°F) and 45°C (113°F).
6. Over Current Protection: The battery stops charging when a high amperage (more than 10 A) is detected.
7. Over Discharge Protection: Over-discharging can seriously damage the battery. Current output will be cut off when the battery cell is discharged to 2.8 V when not in flight mode. For extended flight times, over-charging protection is disabled as batteries discharge during flight. In this instance, a battery voltage below 2 V may cause a safety hazard such as a fire when charged. To prevent this, the battery will not be able to charge if the voltage of a single battery cell is below 2 V. Avoid using any batteries matching this description and avoid serious over-discharging to prevent permanent battery damage.
8. Short Circuit Protection: Automatically cuts the power supply when a short circuit is detected.
9. Battery Cell Damage Protection: DJI GO 4 displays a warning message when a damaged battery cell is detected.
10. Sleep Mode: Sleep mode is entered to save power when the aircraft is not flying.
11. Communication: Information pertaining to the battery's voltage, capacity, current, etc. is transmitted to the aircraft's main controller.
12. Pairing Batteries: Powered by two batteries (with battery cells connected in parallel), the aircraft requires the two batteries to have similar properties, e.g. internal resistance. Pairing batteries in the beginning is recommended. Pairing can be done using DJI GO 4. DJI GO 4 will also prompt you when batteries that are not paired are not in use. The Intelligent Flight Battery Charging Hub will charge paired batteries simultaneously. Stickers are provided for marking paired batteries.
13. Heating: Batteries are able to work even in cold weather, ensuring a safe flight. Refer to "Using the Battery" section for details.
14. Waterproof and Dustproof: The vehicle's new airframe design improves the Ingress Protection Rating to IP43 in accordance with the global IEC 60529 standards.

 Refer to the *Disclaimer* and *Intelligent Flight Battery Safety Guidelines* before use. Users take full responsibility for all operations and usage.

Charging the Intelligent Flight Battery

The Intelligent Flight Battery Charging Hub is designed for use with the Battery Charger. It charges up to four Intelligent Flight Batteries simultaneously. The battery pair with more stored power will be charged first. The Charging Hub will intelligently charge batteries in sequence according to battery power levels from high to low, if batteries are not paired. Pairing can be carried out using the DJI GO 4 app. The Micro USB port is used for firmware updates.

Overview

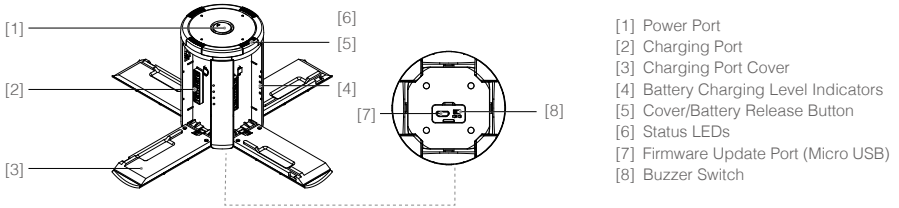

Connecting to a Power Source

Connect the standard Battery Charger to a power outlet (100-240 V, 50/60 Hz), then uncover the rubber cover on the power port to connect the Charging Hub to the Battery Charger*.

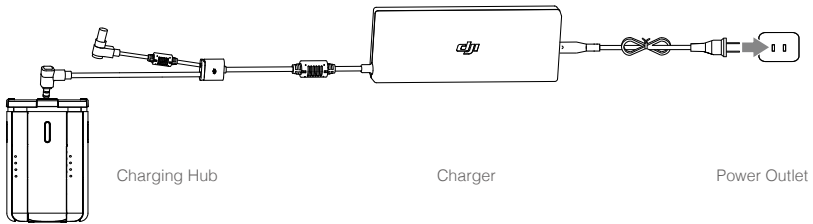

* It will take approximately 1.5 hours to fully charge the TB50-M200 Intelligent Flight Battery, and 3 hours for the remote controller. It will take a longer time to charge the Intelligent Flight Battery and remote controller together.

Connecting Batteries

Press the release button and open the corresponding charging port cover. Insert the Intelligent Flight Battery into the charging port to begin charging. The battery pair with more stored power will be charged first. The Charging Hub will intelligently charge batteries in sequence according to battery power levels from high to low, if batteries are not paired. Pairing can be carried out using the DJI GO 4 app. Refer to the "Status LED Description" section for more information about Status LED blinking patterns. The buzzer will begin beeping when charging is complete. Refer to the "Buzzer Beeping Description" for more information about buzzer beeping patterns.

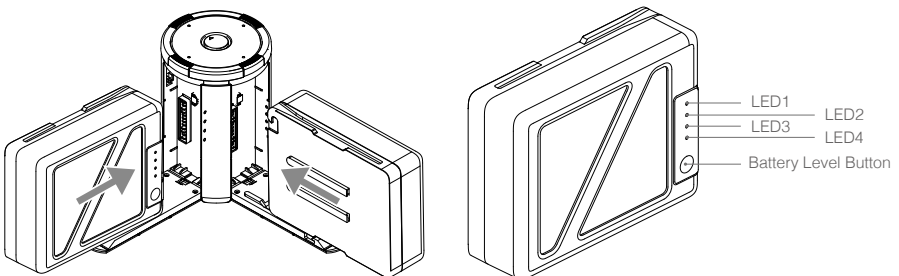

- ⚠ • Always align the grooves on the Intelligent Flight Battery with the battery slot tracks.
- Press the release button to detach batteries after charging is complete.
- DO NOT leave metal terminals exposed to open air when not in use.

Status LED Descriptions

Status LED (Charging Hub)	Description
Blinks Green	Charging
Solid Green	Fully charged
Blinks Red	Battery Charger Error. Retry with an official battery charger.
Solid Red	Intelligent Flight Battery error
Blinks Yellow	Battery temperature too high/low. Temperature must be within operating range (5°-40°C)
Solid Yellow	Ready to charge
Alternating Green Blinks	Intelligent Flight Battery not detected

Battery Level Indicators while Charging (Battery)				
LED1	LED2	LED3	LED4	Battery Level
				0%~50%
				50%~75%
				75%~100%
				Fully Charged

Charging Protection LED Display

The table below shows battery protection mechanisms and corresponding LED patterns.

Battery Level Indicators for Battery Protection					
LED1	LED2	LED3	LED4	Blinking Pattern	Battery Protection Item
				LED2 blinks twice per second	Over current detected
				LED2 blinks three times per second	Short circuit detected
				LED3 blinks twice per second	Over charge detected
				LED3 blinks three times per second	Over-voltage charger detected
				LED4 blinks twice per second	Charging temperature is too low (<0°C)
				LED4 blinks three times per second	Charging temperature is too high (>40°C)

After any of the above mentioned protection issues are resolved, press the button to turn off the Battery Level Indicator. Unplug the Intelligent Flight Battery from the charger and plug it back in to

resume charging. Note that you do not need to unplug and plug the charger in the event of a room temperature error, the charger will resume charging when the temperature falls within the normal range.

 DJI does not take any responsibility for damage caused by third-party chargers.

 **How to discharge the Intelligent Flight Battery before transporting the batteries for a trip:**
Fly the aircraft outdoors until there is low battery power left, or until the battery can no longer be turned on.

Buzzer Beeping Description

Toggle the buzzer switch to turn on/off the warning sound.

Descriptions	Beeping Pattern
Toggle the buzzer switch to turn it on	Quick beeping
Connect to the Battery Charger	Quick beeping
A battery pair is fully charged	Quick beeping
Four Intelligent Flight Batteries are fully charged	Alternating between two short and one long beep, lasting for about 1 hour

Updating the Firmware

DJI will release firmware updates when available. Refer to the official DJI website and follow the instructions below to update the firmware.

1. Download the latest firmware update program from the official DJI website.
(<http://www.dji.com/matrice-200-series/info#downloads>)
2. Turn on the Charging Hub, then connect it to a computer using a Micro USB cable.

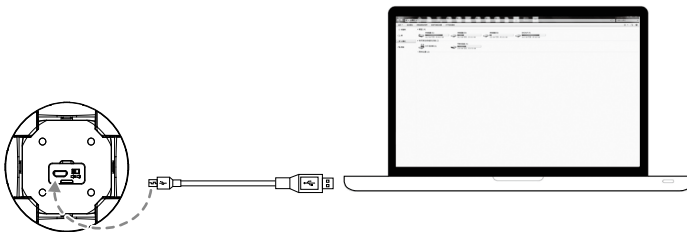

3. Run the firmware update program. Press the update button and wait for the process to finish.
4. The Charging Hub will automatically restart when the update has been successfully completed.
5. Repeat this process if the firmware update fails for any reason.

Using the Battery

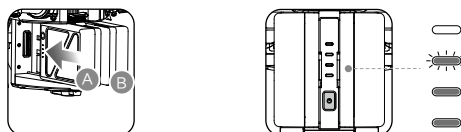

Turning ON/OFF

Turning On: Press the Power button once, then press again and hold for two seconds to power on. The Power LED will turn red and the Battery Level Indicators will display the current battery level.

Turning Off: Press the Power button once, then press again and hold for two seconds to power off.

Heating the Battery

Manual Heating: Make sure the battery is powered off. Press and hold the Power button for three seconds to initiate battery warm up manually.

The battery will warm up if the temperature is below 59°F (15°C). As it warms, LEDs 1 & 2 and LEDs 3 & 4 will blink alternately. The battery will stop warming when it reaches 68°F (20°C). The temperature of the battery will remain between 59-68°F (15-20°C) when alternating LED 1 and LED 4 blinking indicates that it is above 59°F (15°C). This will last for approximately 30 minutes, powering off automatically.

Auto Heating: Insert the batteries into the aircraft and power it on. When the temperature of the battery is below 59°F (15°C), it will warm up automatically. Check the LEDs for the current power level.



Low Temperature Notice:













1. The performance of the intelligent Flight Battery is significantly reduced when flying in low temperature environments (temperatures below 5°C). Ensure that the battery is fully charged and the cell voltage is at 4.35 V before each flight.
2. End the flight as soon as DJI GO 4 displays the “Low Battery Level Warning” in low temperature environments. You will still be able to control the aircraft’s movement when this warning is triggered.
3. In extremely cold weather, the battery temperature may not be high enough even after warming up. In these cases, insulate the battery as required.
4. To ensure optimal performance of the battery, keep the battery temperature above 15°C.
5. Battery insulation paste is available for you to use.

Checking Battery Levels

Battery Level Indicators display how much power remains. When the battery is turned off, press the Power button once and the Battery Level Indicators LEDs will display the current battery level. See below for details.

 The Battery Level Indicators will also show the current battery level during discharging. The indicators are defined below.

-  : LED is on.  : LED is flashing.
-  : LED is off.

Battery Level				
LED1	LED2	LED3	LED4	Battery Level
				88%~100%
				75%~88%
				63%~75%

				50%~63%
				38%~50%
				25%~38%
				13%~25%
				0%~13%

D-RTK and Datalink Pro

Introduction

For the M200 series, you can only activate D-RTK and Datalink Pro with the M210 RTK. Be sure to activate both with DJI Assistant 2 before first time use.

Using dual antennas, D-RTK provides more accurate heading data than a traditional single antenna system, and it can withstand magnetic interference from metal structures. Depending on the region of purchase, the D-RTK uses either GPS and BeiDou or GPS and GLONASS to perform at the highest standards. The Datalink Pro is used to transmit the real-time data wirelessly.

Both D-RTK and Datalink Pro are composed with the air system and ground system. It is recommended to use them in an open environment free from radio interference. Ensure the antennas are unobstructed when in use. This manual uses the Datalink Pro 900 as an example. Please refer to the D-RTK and Datalink Pro user guides for more details.

Activating D-RTK and Datalink Pro

IMPORTANT: The Ground System and Air System of both D-RTK and Datalink Pro should be connected to the computer separately and activated. Be sure to configure parameters with DJI Assistant 2 for first time use.

1. Download DJI Assistant 2 from www.dji.com and install it on your computer.
2. Connect the aircraft to the computer and toggle the USB Mode Switch to the RTK position to activate the D-RTK air system.

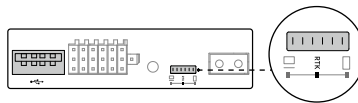

3. Connect the D-RTK Ground System to the computer with DJI Assistant 2 launched for activation.

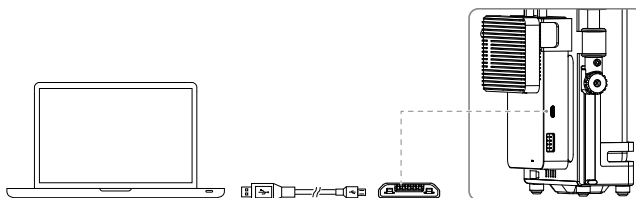

4. Connect the Datalink Pro Ground System to the computer and toggle the 4-position Switch to the COMBO position to activate the Datalink Pro Ground System.

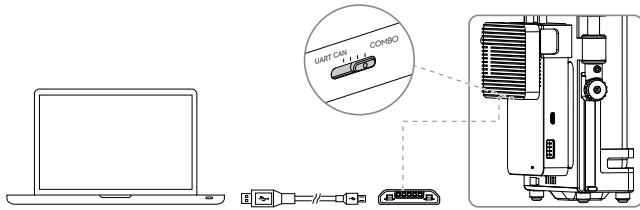

5. Connect the Datalink Pro Air System to the computer and toggle the 4-position Switch to the COMBO position to activate the Datalink Pro Air System.

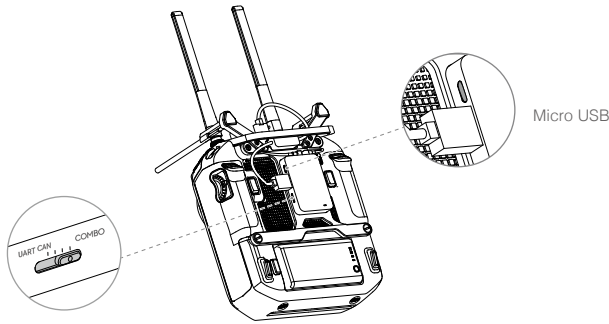

Using the D-RTK

Use the D-RTK in an open environment free from radio interference and follow the procedures below:

1. Power on the Ground System, and wait for the Working Status LED to turn solid green.
2. Power on the Air System, and wait for the aircraft Flight Status LED blinks green and blue alternately.

-
- ⚠ • Ensure that the D-RTK Ground System is powered on first. **DO NOT** power on the aircraft before the D-RTK Ground System's Working Status LED is solid green.
 - Set the Flight Mode Switch to P mode or S mode.
 - The Datalink Pro Ground System's 4-position Switch should be toggled to the UART position and the Air System should be toggled to the CAN position when used.
-

Updating the Ground System's Position

Each time it is used, the Ground System automatically detects the offset distance from its previous position. If the offset distance is > 50 meters, the Ground System will update the new position coordinates automatically. If the position has changed but the Ground System does not update automatically, you will need to update manually. Press the Update button and hold for five seconds until the Ground System recalculates the position coordinates. The DJI GO 4 app will prompt you once the Ground System's position has been updated successfully.

- ⚠ • DO NOT move the Ground System during positioning.
- The Ground System's position coordinates can be set in DJI Assistant 2.

Firmware Updates

The Ground System and Air System of both D-RTK and Datalink Pro can be connected to a computer separately to check if a firmware update is necessary using DJI Assistant 2.

Updating D-RTK

1. Connect the aircraft to the computer and toggle the USB Mode switch to the RTK position.

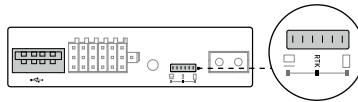

2. Launch DJI Assistant 2 and click the D-RTK icon to enter the D-RTK settings page.
3. Select the firmware update page (with the applicable aircraft type indicated after the firmware).
4. Connect the D-RTK Ground System to the computer (with DJI Assistant 2 already launched).

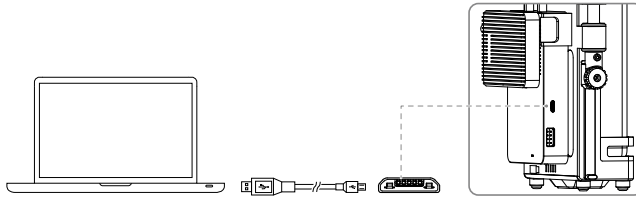

Updating Datalink Pro

1. Connect the Datalink Pro Ground System to the computer and move the 4-position switch to the COMBO position.

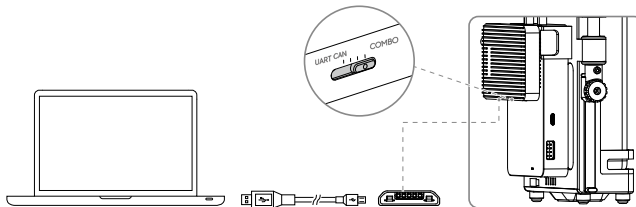

2. Launch DJI Assistant 2 and click the Datalink Pro icon to enter the Datalink Pro settings page.
3. Click M210 RTK Datalink Pro-Ground displayed on the Datalink Pro settings page and follow the prompts.

4. Connect the Datalink Pro Air System to the computer and move the 4-position switch to the COMBO position (with DJI Assistant 2 already launched). Click M210 RTK Datalink Pro-Sky displayed on the Datalink Pro settings page and follow the prompts.

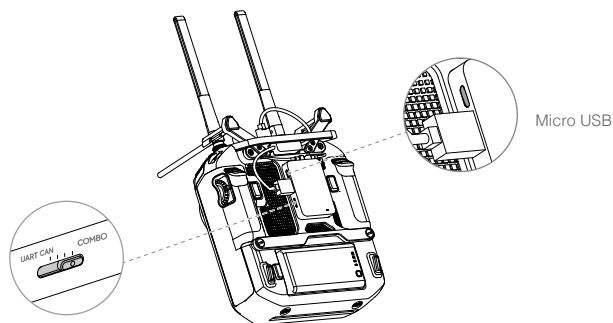

DJI AirSense

Manned aircraft with an ADS-B transceiver will actively broadcast flight information including location, flight path, speed, and altitude. DJI AirSense receives this by ADS-B transceivers via an on-board receiver or internet connection. UAVs installed DJI AirSense can obtain the position, orientation and velocity information from the manned airplane built-in ADS-B transmitter (1090 ES and UAT standard supported), calculate the collision risk level real time and send the warning to user. The system will analyze the potential risk of collision by comparing the location of a manned aircraft, sending timely warnings to pilots via the DJI GO or DJI GO 4 app.

DJI AirSense provides users with information about nearby manned aircraft to ensure flight safety. The system doesn't actively control the drone to avoid incoming aircraft. Always fly your aircraft within a visual line of sight and be cautious at all times. Lower your altitude when you receive warnings. Please be aware that DJI AirSense has the following limitations:

1. It can only receive messages sent by manned aircraft installed with an ADS-B out device and in accordance with 1090ES (RTCA DO-260) or UAT (RTCA Do-282) standards. DJI devices will not receive related broadcast messages or send out warnings for manned aircraft without ADS-B outs or with malfunctioning ADS-B outs.
2. If there is an obstacle or steel structure between civil and DJI aircraft, the system won't be able to receive ADS-B messages sent by manned aircraft or send out warnings. Keenly observe your surroundings and fly with caution.
3. Warnings may be sent with delay when the DJI AirSense is interfered by the surrounding. Keenly observe your surroundings and fly with caution.
4. Warnings are not sent when a DJI aircraft is unable to determine its location.
5. It cannot receive ADS-B messages sent by manned aircraft or send out warnings when disabled or misconfigured.

On the precondition that connection between a DJI aircraft and the pilot remote controller is stable, when the system confirms the possibility of a collision, it will send a series of warnings based on the distance between drone and manned aircraft. We recommended that the operator descend altitude immediately after the first warning to avoid a collision, choosing another flight path where necessary.

Warning Escalation:

The first (or "lowest") level warning occurs three minutes away from the manned aircraft. The second (or "middle") level warning occurs two minutes away from the manned aircraft. The third (or "highest") level warning occurs one minute away from the manned aircraft.



Blue: The first level warning



Yellow: The second level warning



Red: The third level warning

Expansion Ports

M210/M210 RTK provides several I/O ports, which can be customized in DJI Pilot app.

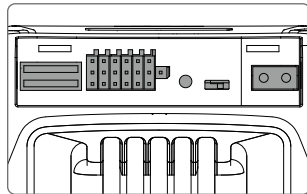

USB Port

USB port is used to connect other devices, without power supply during flight.

Expansion Ports

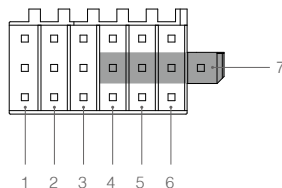
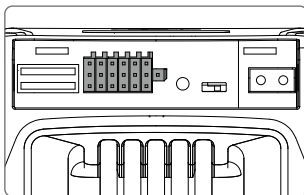

Pins Descriptions

PWM power level is 3.3V and all pins can be configured in DJI Pilot app.

Number	1	2	3	4	5	6	
Name	OSDK port	I/O port	I/O port	I/O port	I/O port	I/O port	
Pins (from up to down)	SDK_Tx	IO/PWM5	IO/PWM4	IO/PWM3	IO/PWM2	IO/PWM1	
	SDK_Rx	NC	NC	CANL	CANH	GND	5V
	GND	GND	GND	GND	GND	GND	

*Coming soon.

CAN Bus Port can be used to connect to an expansion GPS module.

CANL	CANH	GND	5V
------	------	-----	----

RC/Aircraft Linking Button and Indicator

Used to link between aircraft and Remote Controller, and the built-in LED will display the linking status during linking procedure.

USB Mode Switch

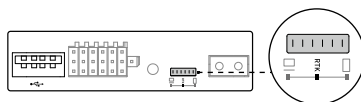

Power on the Intelligent Flight Battery and toggle the USB Mode Switch left, and connect the aircraft and the PC via a double A port USB cable for aircraft parameters configuration and firmware update.

Toggle the USB Mode Switch to the middle RTK position, and connect the aircraft and the PC via a double A port USB cable for the built-in D-RTK Air system activation and firmware update.

Toggle the USB Mode Switch right and connect the aircraft and mobile device via a Micro USB cable.

Extended Power Port (XT30)

Used to supply power for other device, whose voltage range is from 18 V to 26 V with a current of 2 A. Make sure your device is satisfied with the voltage and current requirement.

Remote Controller

This section describes the features of the remote controller that includes aircraft and remote controller operations and dual remote controller mode.

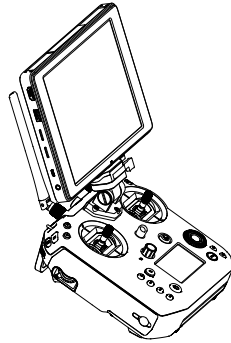

Remote Controller

Remote Controller Profile

The Cendence™ remote controller features DJI's Lightbridge technology for a maximum transmission distance of up to 4.3 mi (7 km).* Equipped with a DJI CrystalSky™ 7.85 inch monitor, which offers an HD live camera view with its built-in DJI Pilot app or DJI GOTM 4 app for a precise and responsive flying experience. Dual transmission frequency support makes HD video downlink stable and reliable. In Dual Remote Controller mode, two remote controllers can control the aircraft and camera separately and simultaneously. Dual Remote Controller mode even works when users are up to 328 ft (100 m) apart.

The remote controller works with a WB37 intelligent battery, which can be charged via the charging port (in about 2 hours and 24 minutes with a 180W charger) or with the WCH2 Intelligent Battery Charging Hub (in about 1 hour and 11 minutes). The maximum operation time of the remote controller is approximately four hours without supplying power to a monitor and with the Dual Remote Controller mode disabled.*

With various customizable buttons, you can adjust a number of flight controller, camera, and gimbal parameters with just your hands. The Cendence Patch Antenna also allows for high-gain signal transmission and improved reception.

* The remote controller can reach its maximum transmission distance (FCC) in a wide open area with no electro-magnetic interference at an altitude of about 400 feet (120 meters).

To comply with local regulations, the 5.8 GHz frequency is not available in some countries and regions.

Maximum run time is estimated without supplying power to a smart device or monitor.

-
- ☰ • **Compliance Standards:** The remote controller is compliant with local laws and regulations.
 - **Stick Mode:** Controls can be set to Mode 1, Mode 2, or to a custom mode.
 - **Mode 1:** The right stick serves as the throttle.
 - **Mode 2:** The left stick serves as the throttle.
 - Please refer to the CrystalSky User Guide for more CrystalSky details.
-

- ⚠ Do not operate more than three aircraft within the same area (roughly the size of a soccer field) to prevent transmission interference.
-

Preparing the Remote Controller

Mounting/Removing the Intelligent Battery

Put the battery into the Battery Slot, then slide it to the end until you hear a click.

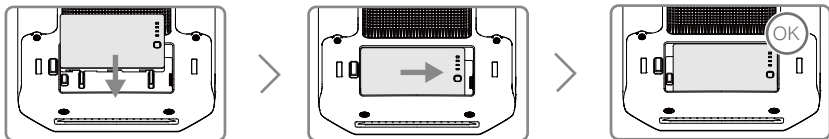

-
- ⚠ • Press the Battery Release Button before removing the battery.
 - Press the Battery Level Button once to check the battery level.
-

Charging the Battery

The remote controller is powered by a WB37 intelligent battery, which can be charged via the charging port or by the WCH2 Intelligent Battery Charging Hub.

Using the Charging Port

Place the battery into the remote controller, and connect connector B of the battery power port, then connect the battery charger to a power outlet (100-240V, 50/60Hz). When charging is complete, the display on the remote controller will show 100%.

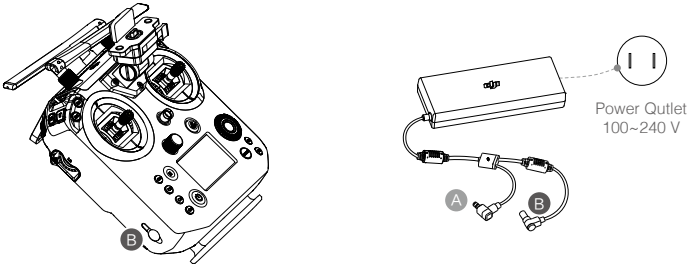

Charging Time: 2 hours and 24 minutes

Using the Charging Hub

Place the battery into the Charging Hub, and connect connector B of the battery charger to the charging hub, then connect the battery charger to a power outlet (100-240V, 50/60Hz). The Charging Hub will intelligently charge batteries in sequence according to battery power levels from high to low. The buzzer will begin beeping when charging is complete. Remove the battery or turn off the Buzzer Switch to stop it.

The charging hub blinks green while charging and turns solid green when charging is finished.

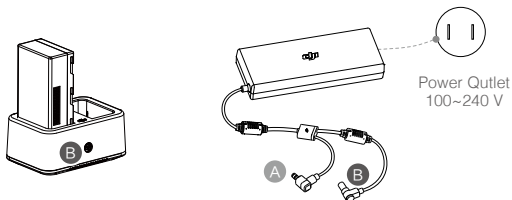

Using the WCH2 Charging Hub, charging time is approximately 1 hour and 11 minutes (for one battery).

⚠ Place the battery into the Charging Hub, and connect connector B of the battery charger to the charging hub, then connect the battery charger to a power outlet (100-240V, 50/60Hz).

- ☀** • USB power supply port can be used to charge the mobile device of 5V/2A.
- Refer to the WCH2 Charging Hub User Guide for more details.

Mounting the Monitor to the Remote Controller

Mounting the DJI CrystalSky Monitor

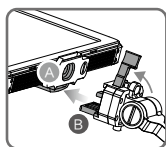

Ensure that Part B is unlocked. Install Part B into Part A.

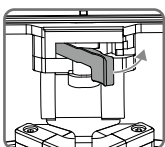

Lock the Mounting Bracket.

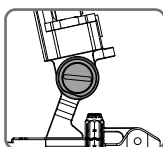

Use a coin to adjust the tightness of the pitch axis.

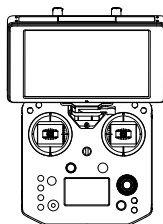

Mounting the Other Mobile Devices

For other mobile devices (e.g. iPhones, iPads), the Cendence Mobile Device Holder and an appropriate USB cable are required.

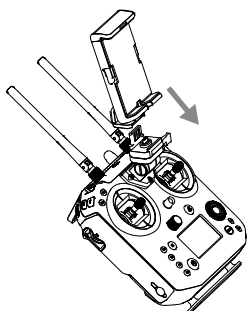

Unlock the Mounting Bracket and mount the Mobile Device Holder.

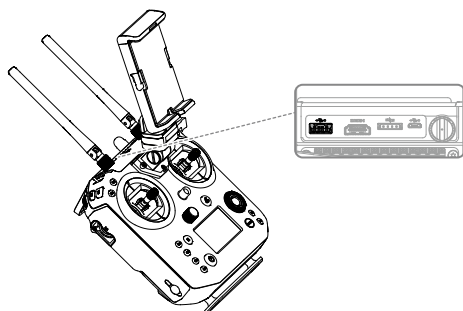

Lock the Mounting Bracket.

Attach your mobile device, then tighten the clamp to secure it. Connect your mobile device to the remote controller with a USB cable. Plug one end of the cable into your mobile device, and the other end into the USB port on the back of the remote controller.

Remote Controller Operations

Button Types

Users can use the preconfigured buttons to control the aircraft and the camera and can also assign functions to the customizable buttons through the DJI GO 4 app. There are three types of button:

1. Preconfigured buttons for aircraft control, e.g. the Pause Button, RTH Button, etc.
2. Preconfigured buttons for camera control, e.g. the Shutter Button, Recording Button, Focus Adjustment Knob, etc.
3. Customizable buttons and knobs that you can set through the DJI GO 4 app.

Turning the Remote Controller On and Off

Follow the steps below to turn the remote controller on and off.

1. Press the power button once to check the current battery level. Charge the remote controller if the battery is too low.
2. Next, press and hold the Power button to power on the remote controller.
3. Repeat step 2 to power off the remote controller after you finish using it.

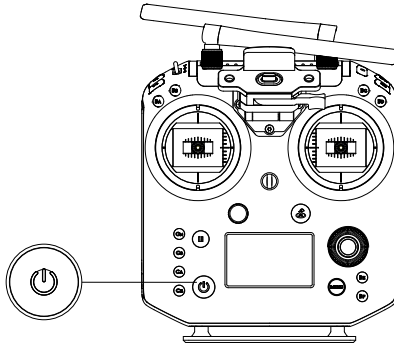

Operating the Aircraft

Controlling the Aircraft

This section explains how to control the orientation of the aircraft through the remote controller. Control can be set to Mode 1, Mode 2 or Mode 3, or to a custom mode.

Mode 1

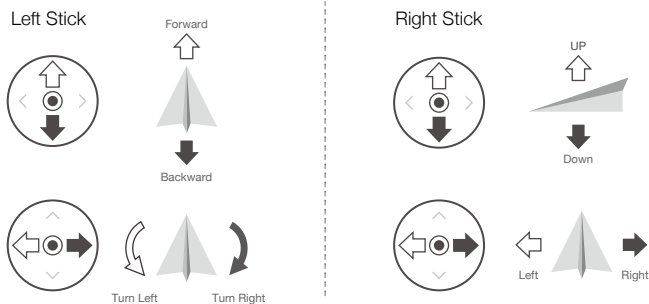

Mode 2

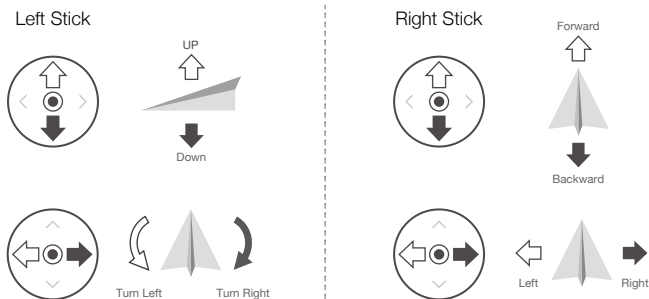

Mode 3

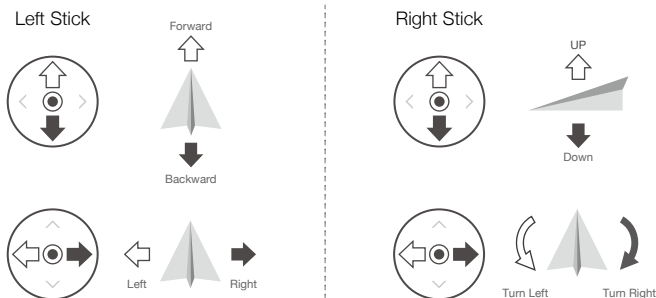







The Stick Mode is set to Mode 2 by default.

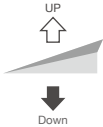

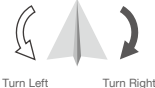
Stick Neutral/Mid-Point: Control sticks are centered.

Moving the Control Stick: Control sticks are pushed away from the center.

Remote Controller (Mode 2)	Aircraft	Remarks
<p>Left Stick</p> 		<p>Moving the left stick up and down changes the aircraft's elevation. Push the stick up to ascend and down to descend. When both sticks are centered, the aircraft will hover in place. The more the stick is pushed away from the center position, the faster the aircraft will change elevation. Always push the stick gently to prevent sudden and unexpected elevation changes.</p>
		<p>Moving the left stick to the left or right controls the rudder and rotation of the aircraft. Push the sick left to rotate the aircraft counter clockwise, and push the stick right to rotate the aircraft clockwise. If the stick is centered, the aircraft will maintain its current orientation. The more the stick is pushed away from the center position, the faster the aircraft will rotate.</p>
<p>Right Stick</p> 		<p>Moving the right stick up and down changes the aircraft's forward and backward pitch. Push the stick up to fly forward and down to fly backward. The aircraft will hover in place if the stick is centered. Push the stick further away from the center position for a larger pitch angle and faster flight.</p>
		<p>Moving the right stick control left and right changes the aircraft's left and right pitch. Push left to fly left and right to fly right. The aircraft will hover in place if the stick is centered. Push the stick further away from the center position for a larger pitch angle and faster flight.</p>

Flight Mode Switch

Toggle the switch to select the desired flight mode. Choose between; P-mode, S-mode, and A-mode.

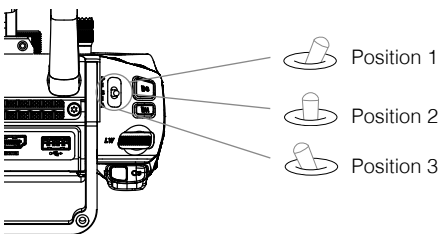

Position	Figure	Flight Mode
Position 1		P-mode
Position 2		S-mode
Position 3		A-mode

P-mode (Positioning): P-mode works best when the GPS signal is strong. The aircraft utilizes GPS, stereo Vision Systems, and an Infrared Sensing System to stabilize, avoid obstacles or track moving subjects. Advanced features such as TapFly and ActiveTrack are enabled in this mode.

S-mode (Sport): The handling gain values of the aircraft are adjusted to enhance aircraft maneuverability. Note that Obstacle Sensing systems are disabled in this mode.

A-mode (Attitude): When neither the GPS nor the Vision System is available, the aircraft will only use its barometer for positioning to control the altitude.

The Flight Mode Switch is locked to P-mode, regardless of the Flight Mode Switch's position. To change flight modes, go to the Camera View in DJI GO 4 and enable Multiple Flight Modes in Main Controller Settings. After enabling multiple flight modes, toggle the switch to P for Position mode and S for Sport Mode.

RTH Button

Press and hold the RTH button to start the Return to Home (RTH) procedure. The aircraft will then return to the last recorded Home Point. Press this button again to cancel the RTH procedure and regain control of the aircraft.

Determine RTH status by sound:

Single beep... Request to return, but not receive the respond from the aircraft yet.

Double beep... RTH in progress.

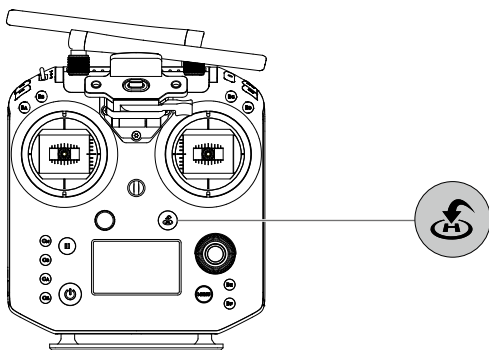

Controlling the Gimbal

Use the left dial and right dial to adjust the gimbal tilt.

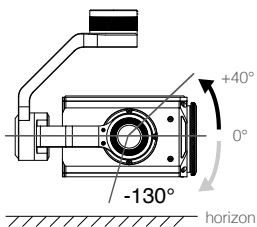
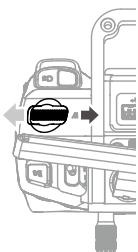

The left dial controls the gimbal tilt. Turn the dial to the right, and the gimbal will shift to point upwards. Turn the dial to the left, and the gimbal will shift to point downwards. The camera will remain in its current position when the dial is static.

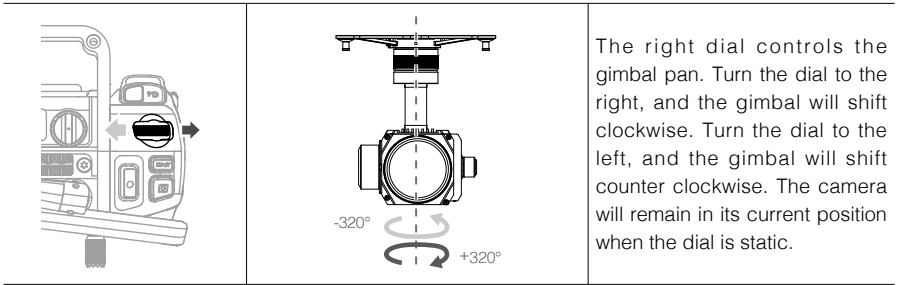

The right dial controls the gimbal pan. Turn the dial to the right, and the gimbal will shift clockwise. Turn the dial to the left, and the gimbal will shift counter clockwise. The camera will remain in its current position when the dial is static.

Operating the Camera

Shoot videos/photos with the Shutter Button and Video Recording Button on the remote controller.

1. Shutter Button

Press to take a photo. If Burst mode is selected, multiple photos will be taken with a continuous press. Photos can be taken even while recording video.

2. Video Recording Button

Press once to start recording video, then press again to stop recording.

3. Autofocus button

Press once to focus automatically.

Setting the Camera

1. EV Setting

Press EV Setting Button and rotate the Camera Setting Dial at the same time to set the EV value.

2. Shutter Setting

Press Shutter Setting Button and rotate the Camera Setting Dial at the same time to set the shutter speed.

3. Aperture Setting

Press Aperture Setting Button and rotate the Camera Setting Dial at the same time to set the aperture value.

4. ISO Setting

Press ISO Setting Button and rotate the Camera Setting Dial at the same time to set the ISO value.



5. Focus Adjustment

Rotate Focus Adjustment Knob to set the focal length.

Configuring the Customizable Buttons

Go to the Customizable Button Settings Menu in DJI GO 4. Here you can set functions for the left lever, right lever, C1-C4 buttons, and BA-BH buttons.



Dual Remote Controller Mode

More than one remote controller can connect to the same aircraft in Dual Remote Controller mode. The Master remote controller operator controls the orientation of the aircraft, while the Slave remote controller controls the movement of the gimbal and camera operation. Master and Slave remote controllers communicate each other via Wi-Fi.

- ⚠ • In Dual Controller Mode, when the Master remote controller is primary, it can control gimbal pitch and pan. When the Slave remote controller is primary, it can control gimbal pitch, pan, and roll.
- Dual Remote Controller mode is not available in Russia and Israel.

Setting Up Dual Remote Controller Mode

Dual Remote Controller mode is disabled by default. Users must enable this feature on the Master remote controller via DJI GO 4. Follow the steps below to setup:

Master Remote Controller:

1. Connect the remote controller to your mobile device and launch DJI GO 4.
2. Go to the Camera View and tap to enter the remote controller settings window.
3. Select Master and set the remote controller as the Master remote controller.
4. Enter the connection password for the Slave remote controller.

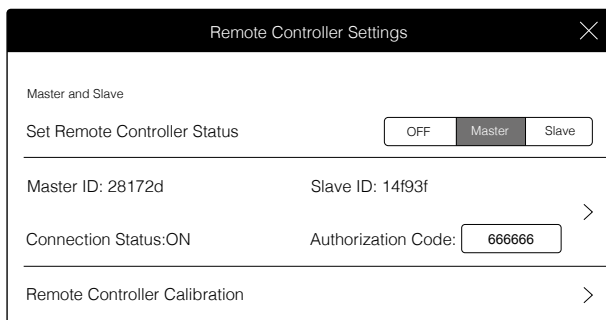

“Slave” Remote Controller:

1. Select Slave to set the remote controller to Slave.

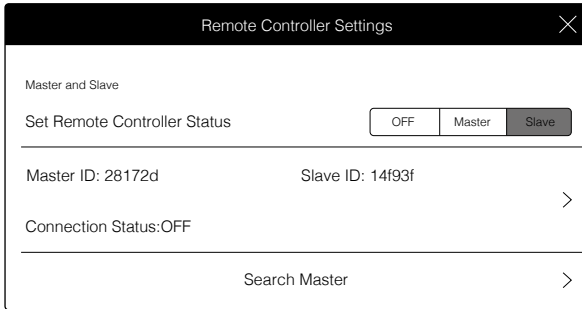

⚠ When in Slave, the remote controller cannot link to the aircraft nor control aircraft orientation. Select Master in DJI GO 4 if you wish to connect and control the aircraft with the remote controller.

2. Search the “Master” remote controller in the surrounding area.

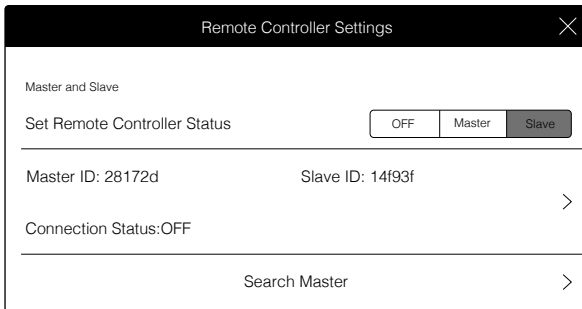

3. Select the Master remote controller from the Master list and input the password to connect.

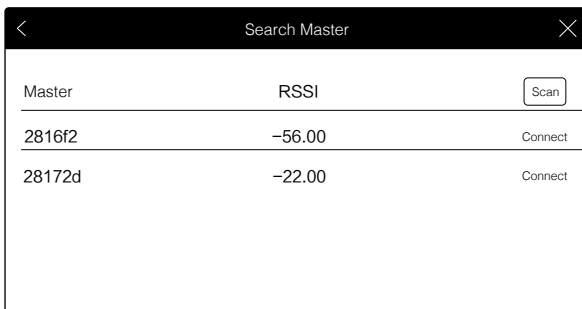

Linking the Remote Controller

The remote controller comes linked to your aircraft before delivery. Linking is only required when using for the remote controller for the first time. Follow these steps to link a remote controller:

1. Power on the remote controller, connect to your mobile device, and launch DJI GO 4.
2. Power on the Intelligent Flight Battery.
3. Enter the Camera View and tap the Linking Remote Controller button shown below.

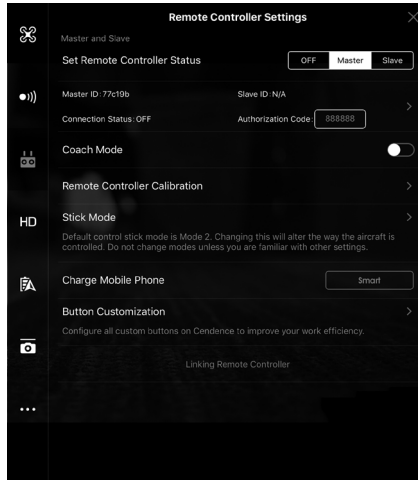

4. The DJI GO 4 app will display a countdown box, the remote controller will be ready to link, with its display showing Connecting and a beeping sound being emitted.
5. Locate the Linking button on the aircraft and press the Linking button to start linking. The remote controller display shows the current status information. The master remote controller shows the aircraft status, and the slave remote controller shows the camera settings.

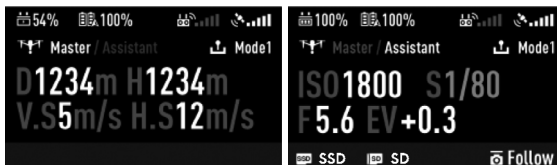
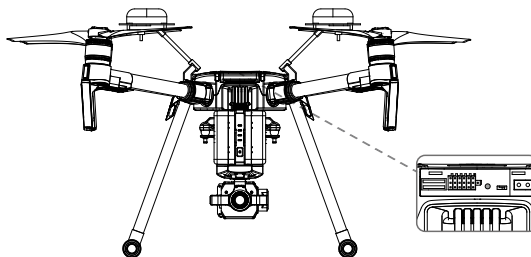

 A Slave remote controller cannot link to the aircraft and so therefore cannot control the orientation of the aircraft. Select Master in DJI GO 4 if you wish to link a remote controller it to the aircraft.

-  • A remote controller will disconnect from the linked aircraft if a new remote controller is linked to the same aircraft.
- Press the C1 and C2 buttons and the Start/Stop button for fast linking.
-

Gimbal and Camera

This section focuses on the technical specifications of the camera and explains how to use the gimbal.

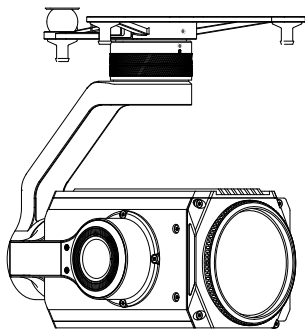

Gimbal and Camera

Camera

Camera Profile

Using the Zenmuse Z30 as an example, this section will demonstrate the technical specifications of the camera while explaining how to use the gimbal.

Camera Micro SD Card Slot

To store photos and videos, plug the Micro SD card into the slot shown below before powering on the aircraft. The aircraft comes with a 16 GB Micro SD card and can support card sizes of up to 128 GB. We recommend you use a UHS-3 type Micro SD card because the fast read and write capability of these cards enables you to store high-resolution video data.

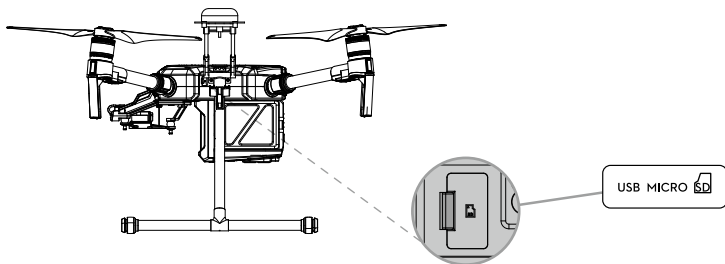

⚠ The Matrice 210/210 RTK currently supports the following Micro SD cards, and will continue to support more cards in future.

- SanDisk Extreme 32GB UHS-3 microSDHC
- SanDisk Extreme 64GB UHS-3 microSDXC
- Panasonic 32GB UHS-3 microSDHC
- Panasonic 64GB UHS-3 microSDXC
- Samsung PRO 32GB UHS-3 microSDHC
- Samsung PRO 64GB UHS-3 microSDXC
- Samsung PRO 128GB UHS-3 microSDXC

-
- ⊘
- Do not remove Micro SD card from the aircraft when it is powered on.
 - To ensure the stability of the camera system, single video recordings are capped at 30 minutes.
-

Camera Operation

Remote Controller

Use the Shutter and Record buttons on the remote controller to shoot photos or videos. For more information on how to use these buttons, please refer to Controlling the Camera.

DJI GO 4

Use DJI GO 4 to shoot photos or videos. For more information, refer to the camera and gimbal User Manual.

Gimbal

Gimbal Profile

The 3-axis gimbal provides a steady platform for the attached camera, allowing you to capture stabilized images and video.

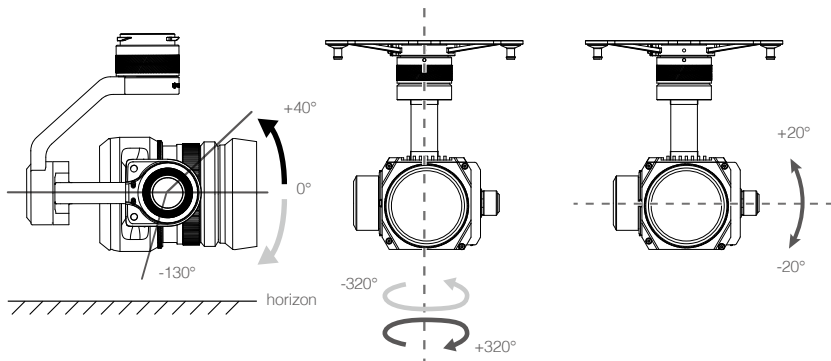

Using the DJI GO 4 App to Control Gimbal

Follow the steps below to use the DJI GO 4 app to control gimbal orientation:

1. Launch DJI GO 4 and enter the Camera View.
2. Tap and press on the screen until a blue circle is shown.
3. Slide to control the gimbal's orientation within the Camera View as shown below.

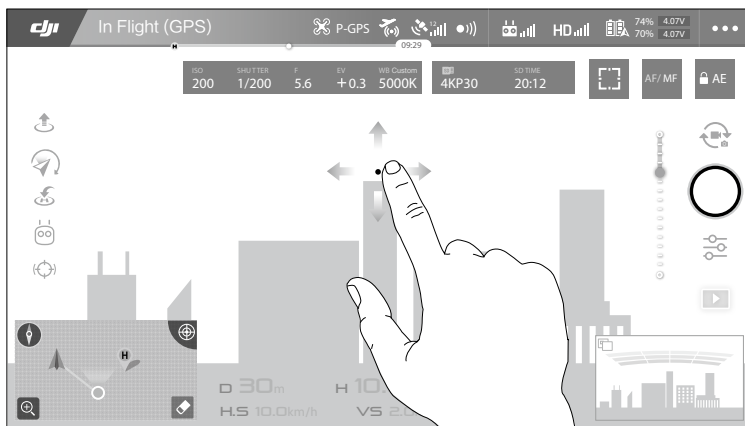

Gimbal Operation Modes

Three gimbal operation modes are available. Switch between the different operation modes in DJI GO 4's Camera View. Note that your mobile device must be connected to the remote controller for changes to take effect. Refer to the table below for details:

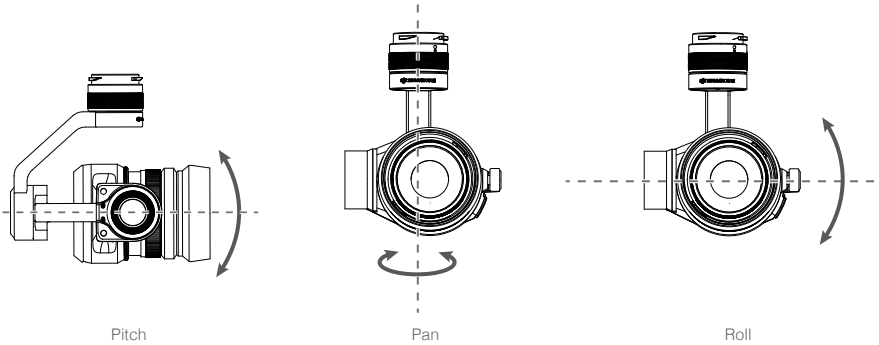

	Follow Mode	Gimbal pan cannot be controlled in this mode.
	Free Mode	The Gimbal's motion is independent of the aircraft's orientation.
	Reset	Tap and the gimbal will pan to realign with the aircraft's nose. The tilt angle will remain unchanged during re-alignment.

- ⚠ • Gimbal pan cannot be controlled in Follow Mode. In Free Mode, press and hold the C1 Button while rotating the control dial to adjust gimbal yaw.
- The gimbal will be in free mode when the Slave remote controller controls the gimbal in Dual Remote Controller Mode.

DJI GO 4

This section introduces the main functions of the DJI GO 4 app.

DJI GO 4

Use the DJI GO 4 app to control the gimbal, camera, and other aircraft functions. The app features Equipment, Editor, SkyPixel, and Me sections, which are used for configuring your aircraft, editing, and sharing your photos and videos with others. It is recommended that you use a tablet for the best possible experience.



Both DJI GO 4 and DJI Pilot support the Zenmuse X5S, X4S, and Z30. DJI Pilot is required if using the Zenmuse XT and XT 2. This manual uses DJI GO 4 as an example. Please refer to the actual user interface.

Equipment

Enter the Camera View by tapping the GO FLY icon on the Equipment page when your mobile device is connected to the aircraft.

Camera View

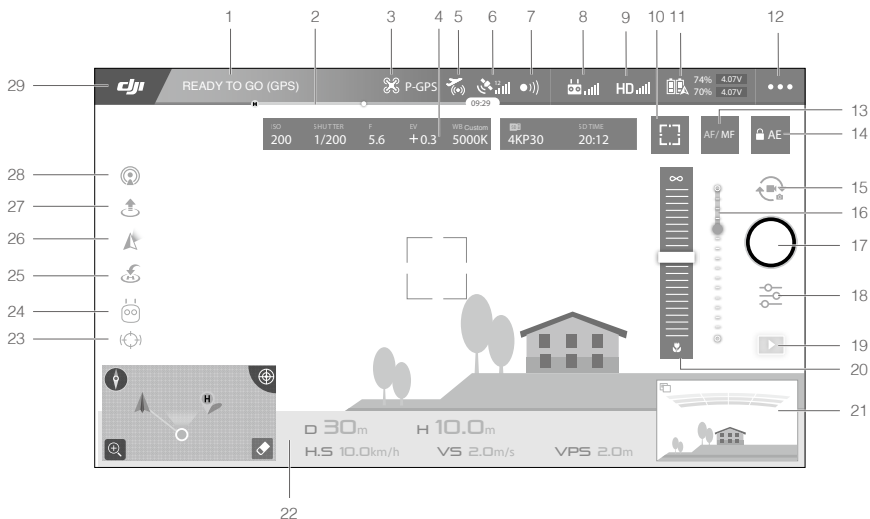

1. System Status

 : This icon indicates aircraft flight status and displays various warning messages.

2. Battery Level Indicator

 : The battery level indicator provides a dynamic display of the battery level. The colored zones on the battery level indicator represent the power levels needed to carry out different functions.



3. Flight Mode

 : The text next to this icon indicates the current flight mode. Tap to configure the Flight Controller Settings. These settings allow you to modify flight limits and set gain values.

4. Camera Parameters

Displays camera settings parameters and capacity of the Micro SD card.



- (1) Tap  to set white balance parameters.
- (2) Tap  to set photo and video parameters.

5. AirSense Status

 : AirSense Status displays information about nearby manned aircraft to ensure flight safety, including the distance between DJI aircraft and manned aircraft. AirSense will instruct users to land if nearby aircraft are detected.



6. GPS Signal Bars

 : Shows current GPS signal strength. Four GPS signal bars indicates sufficient GPS strength to return to home.

7. Obstacle Sensing Function Status

 : Tap this icon to enable or disable features provided by the Vision System.

8. Remote Controller Signal Bars

 : This icon shows the strength of the remote controller signal.

9. HD Video Link Signal Bars

 : This icon shows the strength of the HD video downlink connection between the aircraft and remote controller.

10. Focus/Metering Button

 : Tap to switch between the focus and metering modes. Tap to select an object for focusing or metering.

11. Battery Level

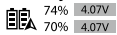
 : This icon shows current battery level.

Tap to view the battery information menu, set various battery warning thresholds, and view battery warning history.

12. General Settings

••• : Tap to enter the General Settings menu to set metrics to enable live streaming, display flight routes, and so on.

13. AF/MF

AF / MF : Tap to switch the focus mode.

14. Auto Exposure Lock

 AE : Tap to lock the exposure value.

15. Photo/Video Toggle

 : Tap to switch between photo and video recording modes.

16. Gimbal Slider

 : Displays the pitch of the gimbal.

17. Shoot / Record Button

 : Tap to start shooting photos or recording video.

18. Camera Settings

 : Tap to set ISO, shutter and auto exposure values of the camera.

19. Playback

 : Tap to enter the playback page and preview photos and videos as soon as they are captured.

20. Manual Focus

Only effective in MF mode.

21. FPV

FPV is only available on tablets. Pinch to zoom in or out of the window.

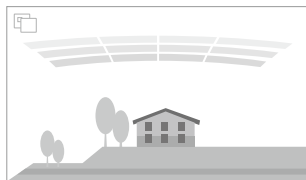

 : Red bars are displayed when obstacles are close to the aircraft. Orange bars are displayed when obstacles are in detection range.

 : Tap to zoom in on the FPV window and move it to the middle of the screen.

22. Flight Telemetry

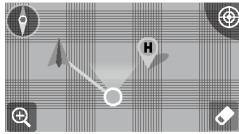

D 30m H 10.0m
H.S 10.0km/h VS 2.0m/s VPS 2.0m

- (1) Tap to switch to map view.
- (2) Flight Attitude and Radar Function:

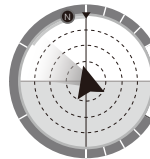

- The red arrow shows which direction the aircraft is facing.
- The ratio of gray area to blue area indicates the aircraft's pitch.
- The horizontal level of the gray area indicates the aircraft's roll angle.
- A blue line indicates the current position of the gimbal's tilt motor.
- The outermost gray circle displays the current power capacity.

- (3) Flight Parameters:

Altitude: Vertical distance from the Home Point.
Distance: Horizontal distance from the Home Point.
Vertical Speed: Movement speed across a vertical distance.
Horizontal Speed: Movement speed across a horizontal distance.

- (4) Aircraft Distance:

The horizontal distance between the aircraft and the operator.

23. Spotlight Pro

 : Tap to use the Spotlight Pro function.

24. Intelligent Flight Mode

 : Displays the current mode. Tap to select Intelligent Flight Mode.

25. Smart RTH

 : Initiate RTH procedure. Tap to have the aircraft return to the last recorded home point.

26. Gimbal Working Modes

Follow mode, free mode and reset mode are included.

27. Auto Takeoff/Landing

 : Tap to initiate auto takeoff or landing.

28. Livestream

 : This icon indicates that the current video feed is being broadcast live on YouTube. Ensure a mobile data service is available on your mobile device.

29. Back

 : Tap this icon to return to the main menu.

Editor

A dedicated video editor is built into the DJI GO 4 app. After recording several video clips and downloading them to your mobile device, go to Editor on the home screen. You can then select a template and a specified number of clips that automatically combine, creating a short film for sharing.

SkyPixel

View and share photos and videos on the SkyPixel page.

Me

If you already have a DJI account, you will be able to participate in forum discussions, and share your creations with the community.

Flight

This section describes safe flight practices and flight restrictions.

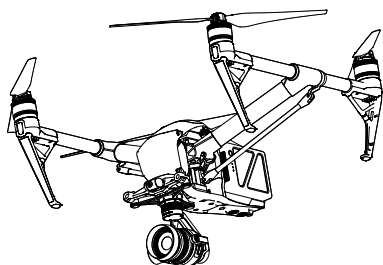

Flight

Ensure that all flights are carried out in an open area. It is important to understand basic flight guidelines for the safety of both you and those around you. Refer to the Disclaimer and Safety Guidelines for more information.

Flight Environment Requirements

1. Do not use the aircraft in severe weather conditions. These include wind speeds exceeding 10 m/s, snow, rain, and fog.
2. When flying in open areas, tall and large metal structures may affect the accuracy of the onboard compass and GPS system.
3. Avoid obstacles, crowds, high voltage power lines, trees, and bodies of water.
4. Minimize interference by avoiding areas with elevated levels of electromagnetism, including base stations and radio transmission towers.
5. Aircraft and battery performance is subject to environmental factors such as air density and temperature. Be very careful when flying at high altitudes, as battery and aircraft performance may be affected.
6. The compass and GPS will not work in Polar Regions. The aircraft will have to auto switch to A-mode, using the Vision System for positioning.

GEO (Geospatial Environment Online) System

Introduction

DJI's Geospatial Environment Online (GEO) System is a global information system committed to providing real-time airspace information within the scope of international laws and regulations. GEO provides flight information, flight times and location information to assist Unmanned Aerial Vehicle (UAV) users in making the best decisions related to their personal UAV use. It also includes a unique Regional Flight Restrictions feature which provides real-time flight safety and restriction updates and blocks UAVs from flying in restricted airspace. While safety and obeying air traffic control laws is a paramount concern, DJI recognizes the need for exceptions to be made under special circumstances. To meet this need, GEO also includes an Unlocking feature that enables users to unlock flights within restricted areas. Prior to making their flight, users must submit an unlock request based on the current level of restrictions in their area.

GEO Zones

DJI's GEO System designates safe flight locations, provides risk levels and safety concerns for individual flights, and offers restricted airspace information, which can be viewed by users in real time on the DJI GO 4 app. The locations designated by GEO are called GEO Zones. GEO Zones are specific flight areas that are categorized by flight regulations and restrictions. GEO Zones that prohibit flight are implemented around locations such as airports, power plants, and prisons. They can also be temporarily implemented around major stadium events, forest fires, or other emergency situations. Certain GEO Zones do not prohibit flight but do trigger warnings informing users of potential risks. All restricted flight areas are referred to as GEO Zones, and are further divided into Warning Zones, Enhanced Warning Zones, Authorization Zones, Altitude Zones, and Restricted Zones. By default, GEO limits flights into or taking off within zones that may result in safety or security concerns. There is a GEO Zone Map, which contains comprehensive global GEO Zone information on the official DJI website: <https://www.dji.com/flysafe>.

The GEO System is for advisory purposes only. Individual users are responsible for checking official sources and determining which laws or regulations may apply to their flight. In some instances, DJI has selected widely-recommended general parameters (such as a 1.5-mile radius at airports) without making any determination as to whether these guidelines match regulations that apply to specific users.

GEO Zone Definitions

Warning Zones: Users receive a warning message with information relevant to their flight.

Enhanced Warning Zones: Users receive a prompt from the GEO System at the time of flight. They are required to submit an unlock request to fly in the zone, for which they must confirm their flight path.

Authorization Zones: Users receive a warning message and the flight is prohibited by default. Authorization Zones can be unlocked by authorized users with a DJI-verified account. Self-Unlocking privileges must be applied for online.

Altitude Zones: Flights are limited to a specific altitude.

Restricted Zones: Flights are completely prohibited. UAVs cannot fly in these zones. If you have obtained permission to fly in a Restricted Zone, please go to <https://www.dji.com/flysafe> or contact flysafe@dji.com to unlock the zone.

DJI GEO Zones aim to ensure the user's flight safety, but it cannot be guaranteed to be in full compliance with local laws and regulations. Users should check local laws, regulations, and regulatory requirements before each flight and are responsible for the flight safety.

All intelligent flight features will be affected when DJI aircraft fly nearby or into GEO Zones. Such interference includes, but is not limited to, decreased speed, takeoff failure, and flight termination.

Flight Restrictions

Introduction

UAV operators should abide by all flight regulations established by the relevant government and regulatory agencies, including the ICAO and the FAA. For safety reasons, flights are restricted by default, which helps users operate DJI products safely and legally. Flight restrictions include altitude and distance limits, and GEO Zones.

When Global Navigation Satellite Service (GNSS) is available, altitude limits, distance limits, and GEO Zones are all taken into account to ensure flight safety. Otherwise, only altitude limits take effect.

Maximum Altitude & Radius Restrictions

Maximum flight altitude restricts an aircraft's flight altitude, while maximum radius restricts its distance. These limits can be set using the DJI GO 4 app.

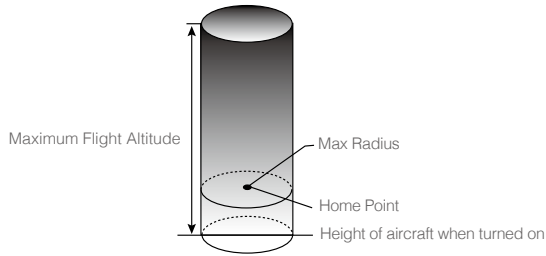

Strong GPS Signal

Restriction	Description	DJI GO 4 App Message
Max Altitude	Aircraft's altitude cannot exceed the specified value.	Maximum Flight Altitude reached. Adjust your altitude using FC Settings if required.
Max Radius	Flight distance cannot exceed the specified value.	Maximum Flight Distance reached. Adjust your distance using FC Settings if required.

Weak GPS Signal

Restriction	Description	DJI GO 4 App Message
Max Altitude	Altitude is restricted to 26 ft (8 m) when GPS signal is weak and the Vision System is activated. Altitude is restricted to 98 ft (30 m) when GPS signal is weak and the Vision System is deactivated.	Maximum Flight Altitude reached. Adjust your altitude using MC Settings if required.
Max Radius	No limit.	N/A

- When an aircraft exceeds a specified limit, the pilot can still control the aircraft but it will be unable to fly any farther.
- ⚠ • When an aircraft exceeds the max radius it automatically flies back within range when GPS signal is strong.
- For safety reasons, do not fly near airports, highways, railway stations, railway lines, city centers, or other sensitive areas. Only fly aircraft in areas that are within your direct line of sight.

GEO Zone Flight Restrictions

GEO Zone	Description
Restricted Zone	Takeoff: The aircraft's motors cannot be started.
	In-flight: When GPS signal changes from weak to strong, DJI GO 4 starts a 20-second countdown. Once the countdown is over, the aircraft immediately lands in semi-automatic descent mode and turns off its motors after landing.
	In-flight: When the aircraft approaches the boundary of the Restricted Zone, it automatically decelerates and hovers.
Authorization Zone	Takeoff: The aircraft's motors cannot be started. Takeoff is only available after submitting an unlock request with the user's phone number.
	In-flight: When GPS signal changes from weak to strong, DJI GO 4 starts a 20-second countdown. Once the countdown is over, the aircraft immediately lands in semi-automatic descent mode and turns off its motors after landing.
Enhanced Warning Zone	The aircraft flies normally but the user is required to confirm the flight path.
Warning Zone	The aircraft flies normally but the user receives warning messages.
Altitude Zone	When GPS signal is strong, the aircraft cannot exceed the specified altitude. In-flight: When GPS signal changes from weak to strong, the aircraft will descend and hover below the altitude limit.
	When the GPS signal is strong, the aircraft approaches the boundary of the Altitude Zone. If it is higher than the altitude limit, the aircraft decelerates and hovers in place.
	When the GPS signal changes from weak to strong, DJI GO 4 app starts a 20-second countdown. Once the countdown is over, the aircraft will descend and hover below the altitude limit.
Free Zone	The aircraft flies normally with no restrictions.



Semi-Automatic Descent: All stick commands are available except the throttle command and RTH button during descent and landing. The aircraft's motors turn off automatically after landing. It is recommended to fly the aircraft to a safe location to land immediately.

GEO Unlocking

Due to differing laws and regulations between countries and regions, and differing flight restrictions between GEO Zones, DJI provides users with two methods for unlocking GEO Zones: Self-Unlocking and Custom Unlocking.

Self-Unlocking is used for Authorization Zones, where the user is required to submit an unlock request by authenticating their phone number for a registered DJI account. This feature is only available in certain countries. Users can choose whether to submit their unlock request via the website at <https://www.dji.com/flysafe> (Scheduled Self-Unlocking), or through the DJI GO 4 app (Live Self-Unlocking).

Custom Unlocking is based on special requirements for individual users. It sets a special flight area that users can unlock by providing flight permission files according to their specific GEO Zone and other requirements. It is available in all countries and can be applied for on the website: <https://www.dji.com/flysafe>.

For more information about unlocking, please visit <https://www.dji.com/flysafe> or contact flysafe@dji.com.

Preflight Checklist

1. Remote controller, Intelligent Flight Battery, and mobile device are fully charged.
2. Propellers are mounted correctly and firmly.
3. Micro SD card has been inserted, if necessary.
4. Gimbal is functioning normally.
5. Motors can start and are functioning normally.
6. The DJI GO 4 app is successfully connected to the aircraft.
7. Ensure that the sensors for the Obstacle Sensing System are clean.

Calibrating the Compass

Only calibrate the compass when the DJI GO 4 app or the status indicator prompts you to do so. Observe the following rules when calibrating your compass:



- DO NOT calibrate your compass where there is a chance of strong magnetic interference, such as near magnets, parking structures, or steel reinforcements underground.
- DO NOT carry ferromagnetic materials with you during calibration such as cellular phones.
- The DJI GO 4 app will notify you if the compass is affected by strong interference after calibration is complete. Follow the prompts to resolve the compass issue.

Calibration Procedures

Choose an open area to carry out the following procedures.

1. Tap the Aircraft Status Bar in the app and select Calibrate, then follow the on-screen instructions.
2. Hold the aircraft horizontally and rotate it 360 degrees. The Aircraft Status Indicators will go solid green.

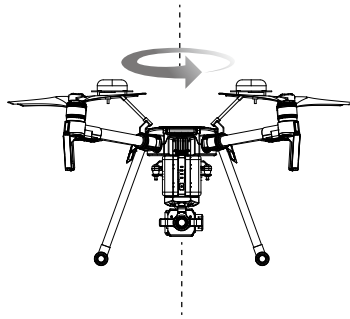

3. Hold the aircraft vertically, with the nose pointing downward, and rotate it 360 degrees around the center axis. Re-calibrate the aircraft if the aircraft status indicators blink red.

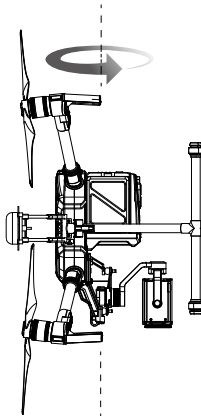

 If the Aircraft Status Indicator blinks red and yellow after the calibration procedure, move your aircraft to a different location and try again.

-
-  • DO NOT calibrate the compass near metal objects such as a metal bridge, cars, scaffolding.
- If the aircraft status indicators are blinking red and yellow alternately after placing the aircraft on the ground, the compass has detected magnetic interference. Please change your location.
-

Auto Takeoff and Auto Landing

Auto Takeoff



Use auto takeoff only if the Aircraft Status Indicators are blinking green. Follow the steps below to use the auto takeoff feature:

1. Launch the DJI GO 4 app and tap GO FLY to enter Camera View.
2. Complete all steps on the pre-flight checklist.
3. Tap “”, and confirm that conditions are safe for flight. Slide the icon to confirm and takeoff.
4. Aircraft takes off and hovers at (1.2 meters) above ground.

 Aircraft Status Indicator blinks rapidly when it is using the Vision System for stabilization. The aircraft will automatically hover below 10 meters. It is recommended to wait until there is sufficient GPS lock before using the Auto Takeoff feature.

Auto-Landing

Use auto-landing only if the Aircraft Status Indicator is blinking green. Follow the steps below to use the auto-landing feature:

1. Tap , to ensure that landing conditions are ideal. Slide to confirm.
2. Abort landing process immediately by tapping  on the screen.
3. a. When Landing Protection determines that the ground is suitable for landing, the aircraft will land gently.
 b. If Landing Protection determines that the ground is not suitable for landing, the aircraft will hover and wait for pilot confirmation.
 c. If Landing Protection is not operational, the DJI GO 4 app will display a landing prompt when the aircraft descends below 0.7 meters. Pull down on the throttle or use the auto landing slider to land.
4. The aircraft will land and turn off automatically.

Starting/Stopping the Motors



Starting Motors

The Combination Stick Command (CSC) is used to start the motors. Push both sticks to the bottom inner or outer corners to start the motors. Once the motors start spinning, release both sticks simultaneously.



Stopping the Motors

There are two ways to stop the motors:

1. When aircraft has landed, push the left stick down , then conduct the same CSC that was used to start the motors, as shown above . Motors will stop immediately. Release both sticks once motors stop.

2. When the aircraft has landed, push and hold the left stick down. The motors will stop after three seconds.

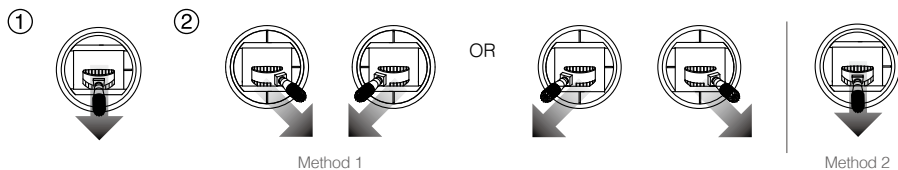

Stop the Motor Mid-flight

Pull the left stick to the bottom right inside corner and press the RTH button at the same time. **Only stop the motors mid-flight in emergency situations when doing so reduces the risk of damage or injury.**

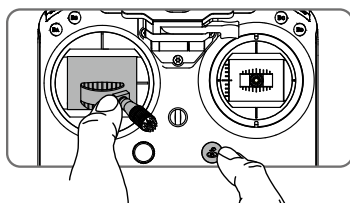

⚠ Please check that CSC is activated inside DJI GO 4 app, then the user can stop the aircraft mid-air.

Flight Test

Takeoff/Landing Procedures

1. Place the aircraft in an open, flat area with the battery level indicators facing towards you.
2. Turn on the remote controller and your mobile device, then turn on the Intelligent Flight Battery.
3. Launch DJI GO 4 and enter the Camera View.
4. Wait until the Aircraft Indicators blink green. This means the Home Point has been recorded and it is now safe to fly. If they flash yellow, the Home Point has not been recorded.
5. Turn on the motors using CSC and push the left stick up slowly or use Auto Takeoff to take off.
6. Shoot photos and videos using the DJI GO 4 app.
7. To land, hover over a level surface and gently pull down on the left stick to descend.
8. After landing, execute the CSC command or hold the left stick at its lowest position until the motors stop.
9. Turn off the Intelligent Flight Battery first, then the remote controller..



- When the Aircraft Status Indicators blink yellow rapidly during flight, the aircraft has entered Failsafe mode.
- A low battery level warning is indicated by the Aircraft Status Indicators blinking red slowly or rapidly during flight.
- Watch our video tutorials for more flight information.

Video Suggestions and Tips

1. Go through the full pre-flight checklist before each flight.
2. Select the desired gimbal operation mode in the DJI GO 4 app.
3. Only shoot video when flying in P-mode.
4. Always fly in good weather and avoid flying in rain or heavy wind.
5. Choose the camera settings that suit your needs. Settings include photo format and exposure compensation.
6. Perform flight tests to establish flight routes and preview scenes.
7. Push the control sticks gently to keep the aircraft's movement smooth and stable.



- It is important to understand basic flight guidelines for the safety of both you and those around you.
- Refer to the Disclaimer and Safety Guidelines for more information.

IP43 Protection Rating

Under stable laboratory conditions, the Matrice 200 Series achieves an IP43 protection rating by IEC60529 standards when equipped with standard TB50-M200 or TB55 Intelligent Flight Batteries. However, this protection rating is not permanent and may reduce over time after long-term use.

- DO NOT fly when the amount of rainfall exceeds 10 mm/h.
- DO NOT fold the frame arms in the rain.
- The angle of inclination of the aircraft body and the ground should not exceed $\pm 60^\circ$ when fly the aircraft in rainy days.
- Make sure the battery ports, battery compartment ports, battery surfaces, and battery compartment surfaces are dry before inserting the batteries.
- Make sure the battery ports and battery surfaces are free from any liquid before charging the batteries.
- Before packing the aircraft into the carrying case, ensure that it is free from any liquid by wiping it carefully.
- Product warranty does not cover water damage.

The aircraft does not achieve IP43 protection rating in the following circumstances:

- (1) Folded frame arms.
- (2) Turn the aircraft upside down.
- (3) You use batteries other than the M200 Series' TB50-M200 or TB55 Intelligent Flight Batteries.
- (4) The cover for the ports and buttons on the rear of the aircraft are not attached correctly.
- (5) The external GPS module is in use.
- (6) The weatherproofing top shell plug is not firmly attached to the top shell.
- (7) The Micro SD card slot cover is not firmly attached.
- (8) The aircraft is broken due to various reasons, such as broken aircraft shell, failure of the waterproof adhesive, etc.

Appendix

Appendix

Specifications

Aircraft	
Model	M210/M210 RTK
Dimensions	M210: Unfolded, 887×880×378 mm Folded, 716×220×236 mm M210 RTK: Unfolded, 887×880×408 mm Folded, 716×242×236 mm
Diagonal Wheelbase	643 mm
Max Takeoff Weight	6.14 kg
Max Payload	M210: 2.3 kg (with TB50-M200 batteries) 1.57 kg (with TB55 batteries) M210 RTK: 1.87 kg (with TB50-M200 batteries) 1.14 kg (with TB55 batteries)
Hovering Accuracy (P-mode with GPS)	Vertical: ±1.64 feet (0.5 m) or ±0.33 feet (0.1 m, Downward Vision System enabled) Horizontal: ±4.92 feet (1.5 m) or ±0.98 feet (0.3 m, Downward Vision System enabled)
Max Angular Velocity	Pitch: 300°/s, Yaw: 150°/s
Max Pitch Angle	P-mode: 25° (Forward Vision System enabled: 25°) S-mode: 30°, A-mode: 25°
Max Ascent Speed	16.4 ft/s (5 m/s)
Max Descent Speed (Vertical)	9.8 ft/s (3 m/s)
Max Speed	S-mode: 64.8 kph (40.3 mph) P-mode/A-mode: 57.6 kph (35.8 mph)
Max Service Ceiling Above Sea Level	9842 feet (3000 m, with 1760S propellers)
Max Wind Resistance	39.36 ft/s (12 m/s)
Max Flight Time (with standard batteries)	M210: 27 min (no payload) 13 min (takeoff weight: 6.14 kg) M210 RTK: 23 min (no payload) 13 min (takeoff weight: 6.14 kg)
Max Flight Time (with optional batteries)	M210: 38 (no payload), 24 min (takeoff weight: 6.14 kg) M210 RTK: 32 (no payload), 24 min (takeoff weight: 6.14 kg)
Motor Model	DJI 3515
Propeller Model	1760S
Supported DJI Gimbals	Zenmuse X4S/X5S/XT/Z30/XT 2
Supported Gimbal Mounting	Single Downward Gimbal, Dual Downward Gimbals, Single Upward Gimbal
Waterproof Level	IP43
GNSS	GPS+GLONASS
Operating Temperature	-4° to 113° F (-20° to 45° C)

Gimbal	
Angular Vibration Range	±0.01°
Controllable Range	Pitch: -130° to +40°; Roll: ±20°; Pan: ±320°
Max Controllable Speed	Pitch: 180°/s; Roll: 180°/s; Pan: 270°/s
Interface Type	DGC2.0
Mechanical Range	Pitch: -140° to +50°; Roll: -50° to +90°; Pan: ±330°
Remote Controller	
Model	GL800A
Operating Frequency	2.400-2.483 GHz; 5.725-5.825 GHz
Max Transmitting Distance	2.4 GHz: 4.3 miles (7 km, FCC); 2.2 miles (3.5 km, CE); 2.5 miles (4 km, SRRC) 5.8 GHz: 4.3 miles (7 km, FCC); 1.2 miles (2 km, CE); 3.1 miles (5 km, SRRC)
EIRP	2.4 GHz: 26 dBm (FCC); 17 dBm (CE); 20 dBm (SRRC) 5.8 GHz: 28 dBm (FCC); 14 dBm (CE); 20 dBm (SRRC)
Video Output Ports	USB, HDMI, SDI
Power Supply	Extended Intelligent Battery (Model: WB37-4920mAh-7.6V)
Charging	DJI charger or DJI charging hub
Dual User Capability	Host-and-Slave connection
Output Power	12 W (without supplying power to a monitor)
Operating Temperature	-4° to 104° F (-20° to 40° C)
Storage Temperature	Less than 3 months: -4° to 113° F (-20° to 45° C) More than 3 months: 72° to 82° F (22° to 28° C)
Charging Temperature	32° to 104° F (0° to 40° C)
DJI CrystalSky	DJI CrystalSky 7.85inch, Resolution: 2048×1536; Brightness: 1000 cd/m ² ; Operating System: Android 5.1; Storage: ROM 64GB
USB Supply Power	iOS: 1 A = 5.2 V (Max); Android: 1.5 A = 5.2 V (Max)
Downward Vision System	
Velocity Range	<32.8 ft/s (10 m/s) at height of 6.56 feet (2 m)
Altitude Range	<32.8 feet (10 m)
Operating Range	<32.8 feet (10 m)
Operating Environment	Surfaces with clear patterns and adequate lighting (> 15 lux)
Ultrasonic Sensor Operating Range	0.33-16.4 feet (10-500 cm)
Ultrasonic Sensor Operating Environment	Non-absorbing material, rigid surface (thick indoor carpeting will reduce performance)
Forward Vision System	
Obstacle Sensing Range	2.3-98.4 feet (0.7-30 m)
FOV	Horizontal: 60°; Vertical: 54°
Operating Environment	Surfaces with clear patterns and adequate lighting (> 15 lux)

Upward Infrared Sensing System

Obstacle Sensing Range	0-16.4 feet (0-5 m)
FOV	±5°
Operating Environment	Large, diffuse and reflective obstacles (reflectivity >10%)

Charger

Model	IN2C180
Voltage	26.1 V
Rated Power	180 W

Battery (TB50-M200)

Name	Intelligent Flight Battery
Model	TB50-4280mAh-22.8V
Capacity	4280 mAh
Voltage	22.8 V
Battery Type	6S LiPo
Energy	97.58 Wh
Net Weight	515 g
Operating Temperature	-4° to 104° F (-20° to 40° C)
Storage Temperature	Less than 3 months: -4° to 113° F (-20° to 45° C) More than 3 months: 72° to 82° F (22° to 28° C)
Charging Temperature	41° to 104° F (5° to 40° C)
Max Charging Power	180 W

Charging Hub (Model: IN2CH)





Input Voltage	26.1 V
Input Current	6.9 A

Battery (TB55)







Name	Intelligent Flight Battery
Model	TB55-7660 mAh-22.8V
Capacity	7660 mAh
Voltage	22.8 V
Battery Type	6S LiPo
Energy	176.93 Wh
Net Weight	885 g
Operating Temperature	-4° to 104° F (-20° to 40° C)
Storage Temperature	Less than 3 months: -4° to 113° F (-20° to 45° C) More than 3 months: 72° to 82° F (22° to 28° C)
Charging Temperature	41° to 104° F (5° to 40° C)
Max Charging Power	180 W

Aircraft Status Indicator Description

Normal

	Red, yellow, green, blue, and purple flashes	Power on and self-check
	Green and Yellow Flash Alternatively	Aircraft warming up
	Green Flashes Slowly	Safe to Fly (P-mode with GPS and Vision System)
	Green Flashes Twice	Safe to Fly (P-mode with Vision System but without GPS)
	Yellow Flashes Slowly	Safe to Fly (A-mode but No GPS and Vision System)

Warning

	Fast Yellow Flashing	Remote Controller Signal Lost
	Slow Red Flashing	Low Battery Warning
	Fast Red Flashing	Critical Low Battery Warning
	Red Flashing Alternatively	IMU Error
	Solid Red	Critical Error
	Red and Yellow Flash Alternatively	Compass Calibration Required

Upgrading the Firmware

Use DJI Assistant 2 or the DJI GO 4 app to upgrade the aircraft and remote controller.

Upgrading the Aircraft Firmware

For the Zenmuse X5S and X4S, the aircraft and gimbal firmware will be updated simultaneously via DJI Assistant 2 or the DJI GO 4 app.

For the Zenmuse Z30, XT and XT 2, only aircraft firmware can be updated via DJI Assistant 2 or the DJI GO 4 app. Gimbal firmware must be updated via a Micro SD card.

Method 1: Using DJI Assistant 2

1. Power on the Intelligent Flight Battery and toggle the USB Mode Switch left.
2. Connect the aircraft and the PC via the USB cable (with Double A ports).
3. Launch DJI Assistant 2 and login with a DJI account.
4. Click M200SERIES and the firmware update button.
5. Select the firmware version required.
6. DJI Assistant 2 will download and upgrade the firmware automatically.
7. Restart the aircraft after the firmware upgrade is complete.

Method 2: Using the DJI GO 4 App

1. Power on the Intelligent Flight Battery and toggle the USB Mode Switch right.
2. Connect the aircraft and your mobile device via an appropriate USB cable.
3. Follow the on-screen instructions in the DJI GO 4 app to upgrade. Ensure to connect to the Internet when downloading the firmware.

4. Restart the aircraft after the firmware update is complete.

- ⚠ • The firmware update will take around 15 minutes. It is normal that the gimbal will go limp, the aircraft status indicator blinks abnormally when the aircraft reboots. Wait patiently until the update is complete.
- During an update, the aircraft will sound a quick single beep continuously. The warning sound will then alternate between a longer beep and a quick double beep once the update is complete. Restart the aircraft after the firmware update is complete.
- If the warning sound turns into a long beep, retry the update.
- The battery level should be above 30% for the firmware update process.
- When using DJI GO 4 to update, you may disconnect the aircraft and the mobile device once the update is more than 30% completed. No Internet connection is required.

Upgrading the Remote Controller Firmware

Method 1: Using the DJI GO 4 App

Power on the remote controller and connect it with the DJI GO 4 app. A prompt will appear if a new firmware upgrade is available. To start upgrading, connect a mobile device to the Internet and follow the on-screen instructions.

- 💡 • Ensure the battery level is adequate for the remote controller.
- Do not disconnect the aircraft from the computer during a firmware upgrade.

Using the Zenmuse XT Gimbal and Camera

The Zenmuse XT Gimbal Adapter is required when mounting the Zenmuse XT gimbal to the Matrice 200 series aircraft. DJI Pilot is required if used with the Zenmuse XT.

1. Attach the Zenmuse XT gimbal adapter onto the Zenmuse XT gimbal.

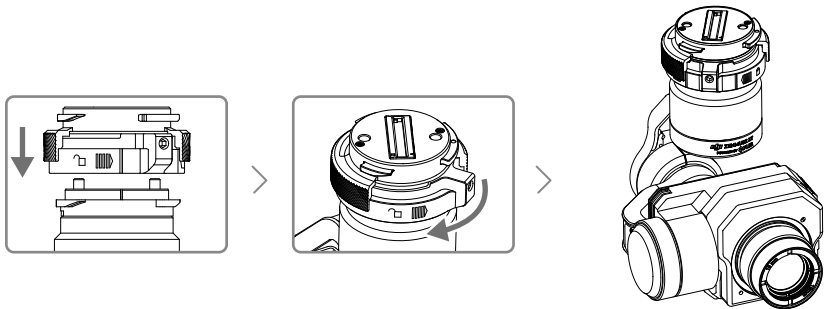

2. Mount the Zenmuse XT onto the aircraft by securing the gimbal adapter.

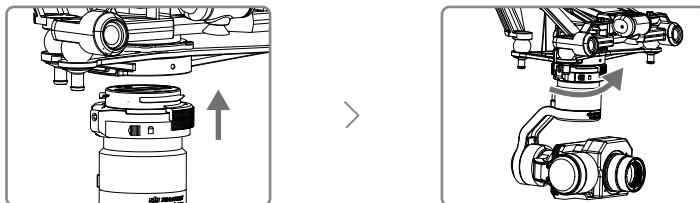

Single Downward Gimbals

The dual downward gimbal connector is mounted onto the aircraft at the factory. To use the M210 or M201 RTK's single downward gimbals it is necessary to first remove the dual downward gimbal connector and mount the single downward gimbal connector.

1. Detach the dual downward gimbal connector from the aircraft by gently removing the three damping balls from their sockets.

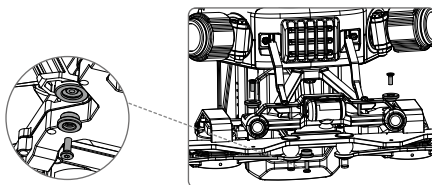

2. Remove the four screws on the top of the dual downward gimbal connector.

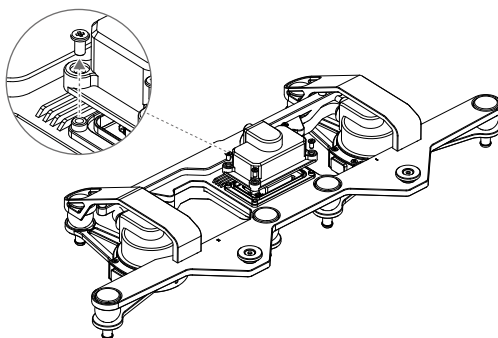

3. Disconnect the gimbal signal control cable and gimbal video cable from the dual downward gimbal connector.

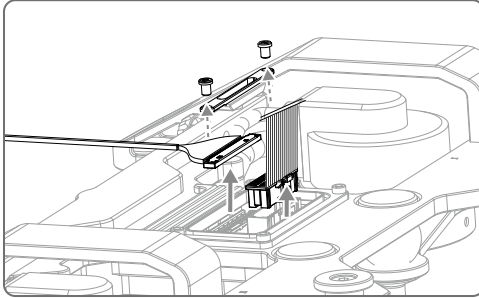

4. Remove the three screws on the top of the single downward gimbal connector.

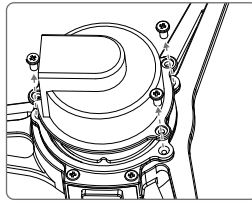

5. Connect the gimbal signal control cable and gimbal video cable to the single downward gimbal connector.

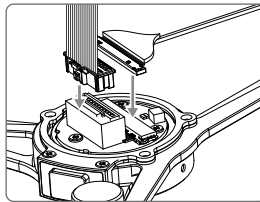

6. Tighten the cover onto the single downward gimbal connector with screws.

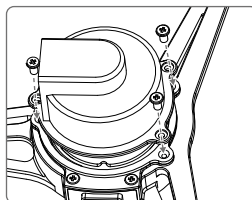

7. Mount the single downward gimbal connector to the aircraft using the three damping balls.

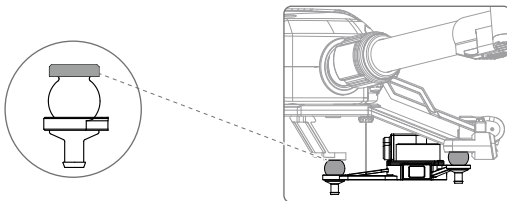

Dual Downward Gimbals

A dual downward gimbal connector is required to use the M210 or M210 RTK's dual downward gimbals.

Mounting the Dual Downward Gimbal Connector

1. Detach the three damping balls. Make sure to carefully pull them from the connector by hand, not forcefully with tools.

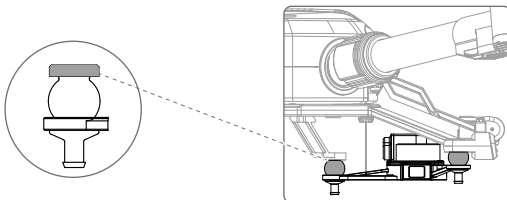

2. Remove the three screws on the top of the single downward gimbal connector.
3. Disconnect the gimbal signal control cable and gimbal video coaxial cable from the single downward gimbal connector.

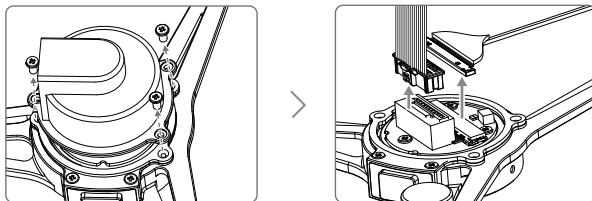

4. Remove the four screws on the top of the dual downward gimbal connector.

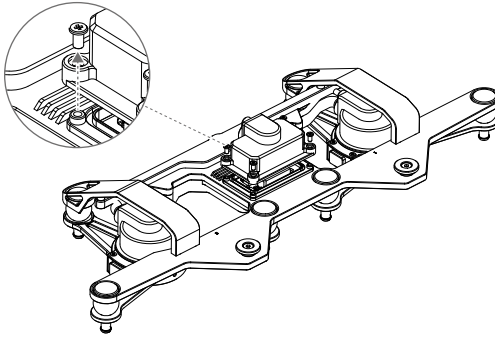

5. Connect the gimbal signal control cable and gimbal video coaxial cable to the dual downward gimbal connector accordingly. Tighten the spring pad with screws to secure the gimbal video coaxial cable.

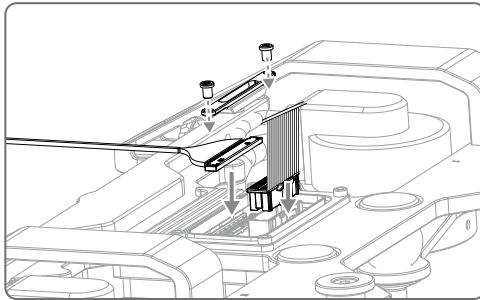

6. Tighten the cover onto the dual downward gimbal connector with screws.

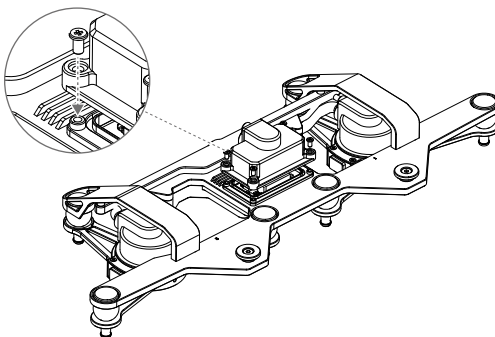

 Keep the cables neat and orderly to prevent interference from the cover.

7. Mount the dual downward gimbal connector to the aircraft.

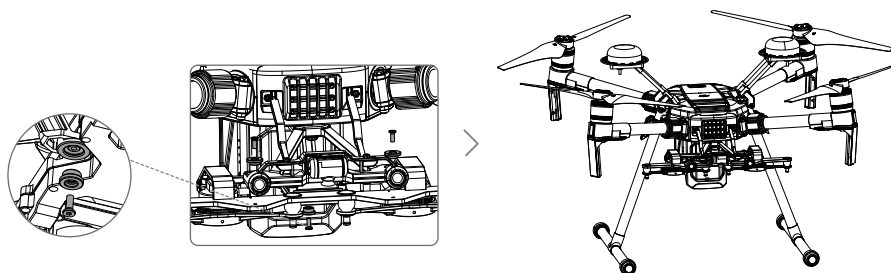

Using the Dual Downward Gimbals

All Zenmuse X5S, X4S, XT, XT 2, and Z30 gimbals are supported. You can mount them to the Gimbal Connector I and Gimbal Connector II as shown below:

Gimbal Connector II	Gimbal Connector I
Zenmuse XT	Zenmuse X4S/X5S/Z30/XT 2
Zenmuse Z30	Zenmuse X4S/X5S/XT/XT 2

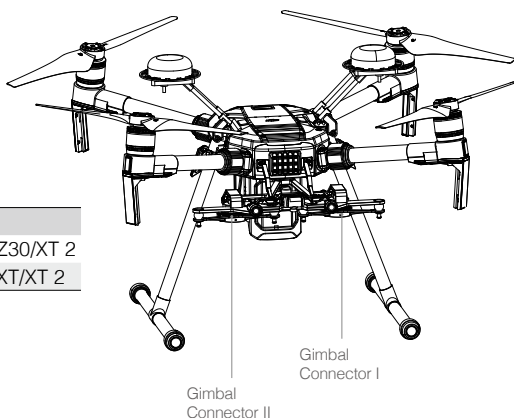

Please note that Gimbal Connector II can be mounted with the Zenmuse XT and Z30 only. Gimbal Connector I and Gimbal Connector II cannot be mounted with two of the same Zenmuse gimbals.

Gimbal Connector I's camera view will show on the main interface in the DJI Pilot app, while Gimbal Connector II's camera view will show on the assistant interface. You can switch between them.

- ⚠ • If using only one camera be sure to install the gimbal and camera on Gimbal Connector I and not on Gimbal Connector II.
- Single upward gimbal connector and dual downward gimbal connector should be used separately. DO NOT use them at the same time.

Mounting the Upward Gimbal and GPS Module

The built-in compass and GPS will fail to work if a single upward gimbal is in use. And the D-RTK antennas cannot receive the GPS signal when the aircraft is flying under a bridge or other tall buildings. It is recommended to mount the extended GPS module when a single upward gimbal is in use in situations like this.

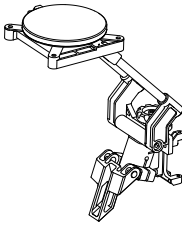

External GPS Module

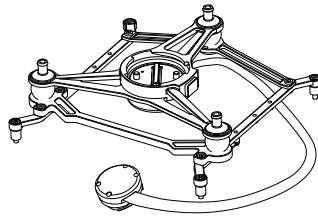

Single Upward Gimbal Connector

On the M210 the GPS module can be mounted on either side of the aircraft. On the M210 RTK the GPS module must be installed on the aircraft's left side (your right hand side when you are facing the aircraft's nose). Before installing the GPS module on the aircraft's left side it is necessary to re-orient the GPS antenna so that the arrow on the antenna is pointing forward. Re-orient the GPS antenna as follows:

1. Remove the four screws (highlighted in the figure below) that secure the antenna in place.
2. Rotate the GPS antenna 180°.
3. Re-insert and tighten the four screws.

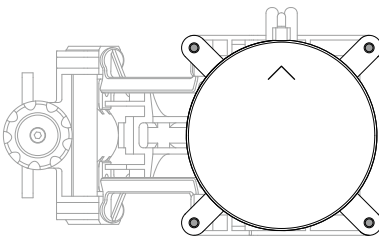

Before

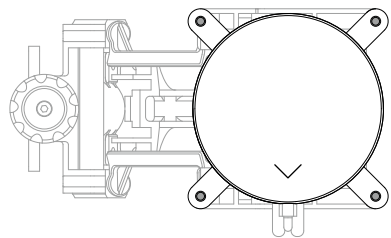

After

DO NOT try to remove the GPS antenna without first removing the four screws that hold it in place as doing so could damage the antenna.

Follow the steps below to mount the Upward Gimbal and GPS Module on the M210:

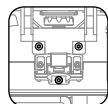

Mount the GPS module.

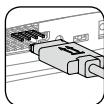

Connect the GPS module to the CAN Bus Port (in the expansion ports) ensuring that the side with the arrows is facing upward.

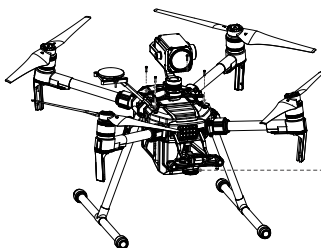

Mount the upward gimbal, and connect it to the DGC2.0 port.



Follow the steps below to mount the Upward Gimbal and GPS Module on the M210 RTK:

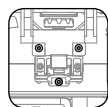

Remove the D-RTK antenna from the aircraft's left side and mount the GPS module.

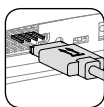

Connect the GPS module to the CAN Bus Port (in the expansion ports) ensuring that the side with the arrows is facing upward.

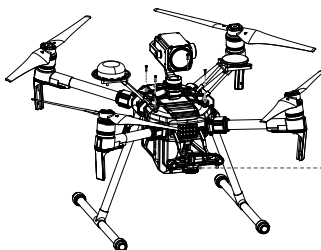

Mount the upward gimbal, and connect it to the DGC2.0 port.



- Make sure you secure the GPS module and upward gimbal's cables with the cable clamps for safety.
- Note that the whole aircraft will not retain its IP43 rating if the GPS module is installed.
- Single upward gimbal connector and dual downward gimbal connector should be used separately. DO NOT use them at the same time.

Carrying Box Descriptions

1. Landing gear x2
2. Propeller pair x4

1. Aircraft
2. Remote controller
3. CrystalSky monitor/iPAD
4. Intelligent flight battery
5. WB37 intelligent flight battery
6. IN2CH charging hub
7. WCH2 charging hub
8. Charger
9. Gimbal and camera (X5S/XT)
10. Gimbal and camera (only X4S)

After-Sales Information

Visit the following pages to learn more about our After-sales Service Policy and warranty information:

1. After-sales Policy: <http://www.dji.com/service>
2. Refund Policy: <http://www.dji.com/service/refund-return>
3. Paid Repair Service: <http://www.dji.com/service/repair-service>
4. Warranty Service: <http://www.dji.com/service/warranty-service>



DJI incorporates HDMI™ technology.
The terms HDMI and HDMI High-Definition Multimedia Interface, and the
HDMI Logo are trademarks or registered trademarks of HDMI Licensing LLC
in the United States and other countries

This content is subject to change.

Download the latest version from
<http://www.dji.com/matrice-200-series>

If you have any questions about this document, please contact DJI by sending a message to DocSupport@dji.com.

© 2018 DJI All Rights Reserved.

