

# MC1210

## Reference Manual



<b>1. Introduction</b>	<b>.3</b>
1.1 Customer Service	.3
1.2 Standard Equipment	.3
1.3 Safety information	.4
<b>2. Calibrator Interface</b>	<b>.6</b>
2.1 Main Display	.7
2.2 Menu Bar	.8
2.3 Cursor control / Setpoint control	.11
<b>3. Using Measure Modes (Lower Display)</b>	<b>.12</b>
3.1 Measuring volts and frequency	.12
3.2 Measuring mA	.12
3.3 Measuring Temperature	.13
3.4 Measuring Pressure	.14
<b>4. Using Source Modes (Lower Display)</b>	<b>.16</b>
4.1 Setting 0% and 100% Output Parameters	.16
4.2 Using the Automatic Output Functions	.16
4.3 Sourcing mA	.16
4.4 Simulating a Transmitter	.18
4.5 Sourcing volts	.18
4.6 Sourcing frequency	.19
4.7 Sourcing a pulse train	.19
4.8 Sourcing Thermocouples	.20
4.9 Sourcing Ohms/RTDs	.21
<b>5. Using Isolated Measure Modes (Upper Display)</b>	<b>.22</b>
5.1 Measuring volts and mA	.22
5.2 Measuring current with loop power	.22
5.3 Measuring Pressure	.23
<b>6. Using the Upper and the Lower Display for Calibration and Testing</b>	<b>.25</b>
6.1 Testing an Input or Indicating Device	.25
6.2 Calibrating an I/P Device	.25
6.3 Calibrating a Transmitter	.26
6.4 Calibrating a Pressure Transmitter	.26
<b>7. Performing a Switch Test</b>	<b>.27</b>
7.1 Performing an Temperature Switch Test:	.27
7.2 Performing a pressure switch test:	.29
<b>8. Remote Operation</b>	<b>.31</b>
8.1 Setting up the RS-232 Port for Remote Control	.31
8.2 Changing Between Remote and Local Operation	.32
8.3 Using Commands	.32
8.4 Remote Commands and Error Codes	.36
8.5 Entering Commands	.39
<b>9. Specifications</b>	<b>.49</b>
<b>10. Maintenance / Warranty</b>	<b>.52</b>
10.1 Replacing Batteries	.52
10.2 Cleaning the Unit	.52
10.3 Service Center Calibration or Repair	.52
10.4 Replacement Parts & Accessories	.52
10.5 Warranty	.52

# 1. Introduction

The Martel MC1210 Multifunction Process Calibrator is a handheld, battery-operated instrument that measures and sources electrical and physical parameters. The calibrator has the following features and functions:

- A dual display. The upper display is used for the measurement of volts, current, and pressure. The lower display can be used to measure volts, current, pressure, resistance temperature detectors (RTDs), thermocouples, frequency, and resistance, and to source pulse trains.
- A thermocouple (TC) input/output terminal with automatic reference-junction temperature compensation
- Five setpoints in each range for increasing/decreasing output
- An interactive menu
- Complete RS232 interface for remote control
- Isolated read back for transmitter calibration
- Switchtest capability

## 1.1 Customer Service

**Corporate Office:**

[www.martelcorp.com](http://www.martelcorp.com)

e-mail: [sales@martelcorp.com](mailto:sales@martelcorp.com)

Tel: (603) 434-1433 800-821-0023 Fax: (603) 434-1653

**Martel Electronics**

3 Corporate Park Dr.

Derry, NH 03038

## 1.2 Standard Equipment















Check to see if your calibrator is complete. It should include:

MC1210 Calibrator, Instruction Manual, Test Leads, Rubber Boot, NIST Certificate

## 1.3 Safety information

### **Symbols Used**

The following table lists the International Electrical Symbols. Some or all of these symbols may be used on the instrument or in this manual.

Symbol	Description
	AC (Alternating Current)
	AC-DC
	Battery
	CE Complies with European Union Directives
	DC
	Double Insulated
	Electric Shock
	Fuse
	PE Ground
	Hot Surface (Burn Hazard)
	Read the User's Manual (Important Information)
	Off
	On
	Canadian Standards Association

The following definitions apply to the terms “Warning” and “Caution”.

- “Warning” identifies conditions and actions that may pose hazards to the user.
- “Caution” identifies conditions and actions that may damage the instrument being used.

Use the calibrator only as specified in this manual, otherwise injury and damage to the calibrator may occur.

## **Warning**

### **To avoid possible electric shock or personal injury:**

- Do not apply more than the rated voltage. See specifications for supported ranges.
- Follow all equipment safety procedures.
- Never touch the probe to a voltage source when the test leads are plugged into the current terminals.
- Do not use the calibrator if it is damaged. Before you use the calibrator, inspect the case. Look for cracks or missing plastic. Pay particular attention to the insulation surrounding the connectors.
- Select the proper function and range for your measurement.
- Make sure the battery cover is closed and latched before you operate the calibrator.
- Remove test leads from the calibrator before you open the battery door.
- Inspect the test leads for damaged insulation or exposed metal. Check test leads continuity. Replace damaged test leads before you use the calibrator.
- When using the probes, keep your fingers away from the probe contacts. Keep your fingers behind the finger guards on the probes.
- Connect the common test lead before you connect the live test lead. When you disconnect test leads, disconnect the live test lead first.
- Do not use the calibrator if it operates abnormally. Protection may be impaired. When in doubt, have the calibrator serviced.
- Do not operate the calibrator around explosive gas, vapor, or dust.
- When using a pressure module, make sure the process pressure line is shut off and depressurized before you connect it or disconnect it from the pressure module.
- Disconnect test leads before changing to another measure or source function.
- When servicing the calibrator, use only specified replacement parts.
- To avoid false readings, which could lead to possible electric shock or personal injury, replace the battery as soon as the battery indicator appears.
- To avoid a violent release of pressure in a pressurized system, shut off the valve and slowly bleed off the pressure before you attach the pressure module to the pressure line.

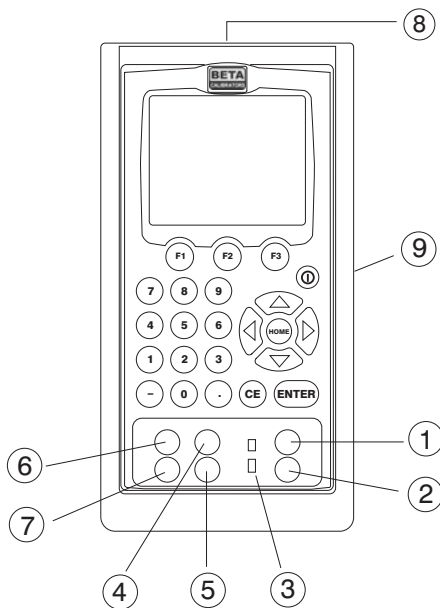
## **Caution**

### **To avoid possible damage to calibrator or to equipment under test:**

- Use the proper jacks, function, and range for your measurement or sourcing application.
- To avoid mechanically damaging the pressure module, never apply more than 10 ft-lb. of torque between the pressure module fittings, or between the fittings and the body of the module.
- To avoid damaging the pressure module from overpressure, never apply pressure above the rated maximum printed on the module.
- To avoid damaging the pressure module from corrosion, use it only with specified materials. Refer to the pressure module documentation for material compatibility.

## 2. Calibrator Interface

Figure 1 shows the location of the input and output connections on the calibrator, while Table 1 describes their use.

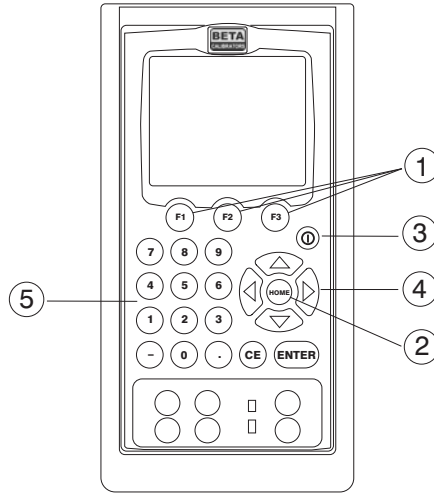


**Figure 1. Input/Output Terminals**

**Table 1: Input and Output Terminals**

No.	Name	Description
1, 2	Measure Isolated V, mA terminals, switchtest	Input terminals for measuring current, voltage, switchtest, and supplying loop power.
3	TC input/output	Terminal for measuring, or simulating thermocouples. Accepts miniature polarized thermocouple plugs with flat in-line blades spaced 7.9 mm (0.312 in) center to center.
4,5	Source/Measure V,RTD 2W, Hz,	Terminals for sourcing and measuring voltage, frequency, pulse train, and RTDs
6,7	Source/Measure mA terminals, 3W 4W	Terminals for sourcing and measuring current, and performing RTD measurements with 3-wire or 4-wire setups.
8	Pressure module connector	Connects calibrator to a pressure module for pressure measurements.
9	Serial port	Connects calibrator to a PC for remote control.

Figure 2 shows the location of the keys on the calibrator. Table 2 lists the functions of each key.

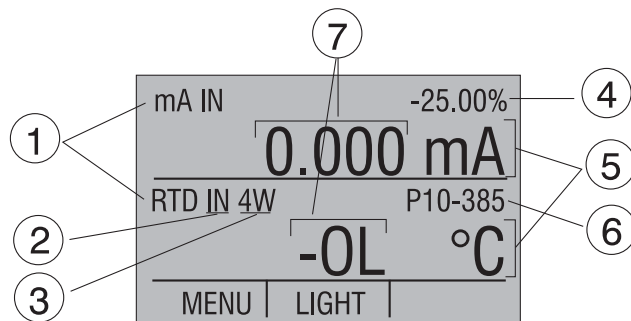


**Figure 2. Keypad**

**Table 2. Key Functions**

No.	Name	Function
1	Function Keys F1, F2, F3	Used to operate the menu bar at the bottom of the calibrator display. F1 is used for selecting options in the left box, F2 for the center box, and F3 for the right box.
2	Home	Returns to home menu on the menu bar.
3	Power	Turns calibrator on and off.
4	Cursor Control Key	Left and right arrow keys are used to select which decade to be changed in output value. Up and down arrow keys are used to increase, decrease, or ramp output value.
5	Numeric Keypad	Allows user to enter Numeric values.

## 2.1 Main Display



**Figure 3. Display**

The display of the calibrator, shown in Figure 3, is divided into three main sections: the upper display, the lower display, and the menu bar.

The upper display is used for measuring dc voltage, dc current with and without loop power, and pressure.

The lower display can be used for both measuring and sourcing.

The menu bar is used to setup both the upper and the lower display to perform the desired function.

Table 3 explains the different parts of the display:

**Table 3: Display Functions**

No.	Name	Description
1	Primary Parameters	Determine what parameter is going to be measured or sourced. The available options for the upper display are: VOLTS IN, PRESSURE, mA IN, and mA LOOP. The available options for the lower display are: VOLTS, TC (thermocouple), RTD, FREQ (frequency), PULSE, PRESSURE, mA, and mA 2W SIM.
2	Input/Output control	Switches the lower display between input mode (read), and output mode (source).
3	Additional Settings	Available only for TC (thermocouple), and RTD measurements. For TC this setting turns the CJC (Cold Junction Connection) on and off. For RTD measure [RTD IN], this setting sets the number of wires used in the measurement (2-wire, 3-wire, or 4-wire)
4	Span Indicator	Available only for mA and mA LOOP. Shows where in the preset span the measured value falls. Fixed for mA at 4 (0%) and 20 (100%).
5	Units	Shows what unit the measurement or source value is in. Available options are for RTD and TC (°C or °F), and for FREQ and PULSE (CPM, Hz, or KHz)
6	Sensor Types	Allow for measurements to be made for different types of RTDs and TCs. All types are shown in the Specifications. Also, displays the amplitude of the pulse and frequency source, and pressure units.
7	Numeric Displays	Display the numeric values of the signal being measured, or sourced. An "OL" reading indicates an out of range or overload condition.

## 2.2 Menu Bar

The parameters on the display are controlled by the menu bar, which is located at the bottom of the LCD. The function keys (F1, F2, and F3) are used to navigate through all the levels and choices of the menu bar. Refer to the menu tree for a clarification on the layout of all the levels.

The top level of the menu is the home menu. It can be accessed anytime by pressing the HOME key. There are three variations of the home menu: the input home menu, the output home menu, and the pulse home menu.



In the input home menu the only active options are [MENU] and [LIGHT]. The [MENU] option is used to enter the next level of the menu bar, the main menu. Press the corresponding function key (F1) to enter the main menu. The [LIGHT] option is used to turn on the LCD back light. Press the corresponding function key (F2) to turn on the back light.



In the output home menu there are three active options, [MENU], [LIGHT] and [STEP] or [RAMP]. The first two options work the same as in the input home menu. The third option is selectable in the Auto Function Menu and is used to turn on and off the selected auto function. See Section 4.2, Using the Automatic Output Functions. Also leaving this menu or pressing the Home button will stop the auto functions.



The pulse home menu also has three active options, [MENU], [TRIG], and [COUNTS]. The [TRIG] and [COUNTS] options are used for pulse simulation. The function of these options is explained in Section 4.2-6 (Sourcing a Pulse).



The next level of the menu bar is the main menu. The levels under the main menu depend on what mode the calibrator is in.

The main menu has three active options [UPPER], [LOWER], and [MORE].

Choosing [UPPER] calls up the parameter selection menu for the upper display. Choosing [LOWER] calls up the parameter selection menu for the lower display. [MORE] enters the next menu level.



The Auto Function Menu is the next menu if you are in source mode. Its options are [AUTO FUNC], [NEXT] and [DONE]. [AUTO FUNC] allows you to adjust the Automatic Output Function parameters. [NEXT] proceeds to the next menu level and [DONE] returns to the home menu. See Section 4.2, Using the Automatic Output Functions.



The contrast menu is usually the next menu level. Its options are [CONTRAST], [NEXT], and [DONE]. The [CONTRAST] option is used to adjust contrast. [NEXT] proceeds to the auto off main menu, and [DONE] returns to home menu. Contrast is adjusted using the arrow options, which are available after choosing [CONTRAST].

**NOTE:** The MC1210 calibrator offers a wide range contrast adjustment feature to accommodate operation in extreme temperatures.

In certain cases making large changes in contrast may render the display difficult to read under normal conditions. If this occurs and the display is too dim or dark to read, proceed with the following process to set the contrast back to a default setting.

1. Turn on the unit while holding down the “HOME” key.
2. Hold the key down for a count of 10 seconds to restore contrast default settings.

If the display is so dim that you cannot tell if the unit is on or off, use the backlight key to determine if the power is on or off.

CONTRAST	NEXT	DONE
----------	------	------

The auto off main menu contains the options [AUTO OFF], [NEXT], and [DONE].

The [AUTO OFF] option is used to turn the automatic shutoff on and off and set the amount of time the unit needs to stay dormant to shut off. [NEXT] and [DONE] both return to home menu.

AUTO OFF	NEXT	DONE
----------	------	------

When the lower display is in the frequency or pulse mode, the frequency level menu is added after the main menu. The options available in this menu are [FREQ LEVEL], [NEXT], and [DONE]. The [FREQ LEVEL] option is used to adjust the amplitude of the wave. [NEXT] is used to access the contrast main menu, and [DONE] returns to the home menu.

FREQ LEVEL	NEXT	DONE
------------	------	------

When the calibrator is in RTD CUSTOM mode, the RTD custom setup menu, is inserted after the main menu. Options [SET CUSTOM], [NEXT], and [DONE] are available. [SET CUSTOM] is used to enter a custom PRT into the calibrator. Refer to Section 4.1-8a for instructions. [NEXT] is used to enter the contrast main menu, and [DONE] to return to the home menu.

SET CUSTOM	NEXT	DONE
------------	------	------

The pressure zeroing main menu is the final variation to choosing [MORE] in the main menu.

It has the options [ZERO  $\frac{\oplus}{\ominus}$ ], used to zero pressure, [NEXT] and [DONE], which have the same function as above. Refer to the Section 5.3 for instructions on zeroing.

ZERO $\frac{\oplus}{\ominus}$	NEXT	DONE
-------------------------------	------	------

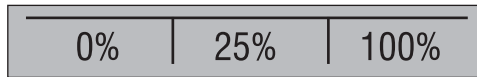
The parameter selection menu is called up when [UPPER] or [LOWER] is selected from the main menu. It contains the following options: [SELECT], [NEXT], and [DONE]. When the display is selected, a parameter will start to flash. Use the [SELECT] option to change the parameter, and the [NEXT] option to switch to another variable. [DONE] returns to the home menu and enables the selected mode.

SELECT	NEXT	DONE
--------	------	------

## 2.3 Cursor control / Setpoint control

The output value can be controlled by the four cursor control arrows on the keypad. By pressing one of the arrows a cursor will be added to the display under the last digit of the output value. The left and right arrow keys are used to select which decade to be changed in the output value. The up and down arrow keys are used to increase, decrease, or ramp the output value.

The menu bar will change to the setpoint menu with the touch of any one of the four arrow keys.



The three function keys are associated with 0, 25, and 100% values, respectively. 0 and 100% values can be stored by entering a value and then holding down the corresponding function key. The 25% key will then automatically step through the 25% values.

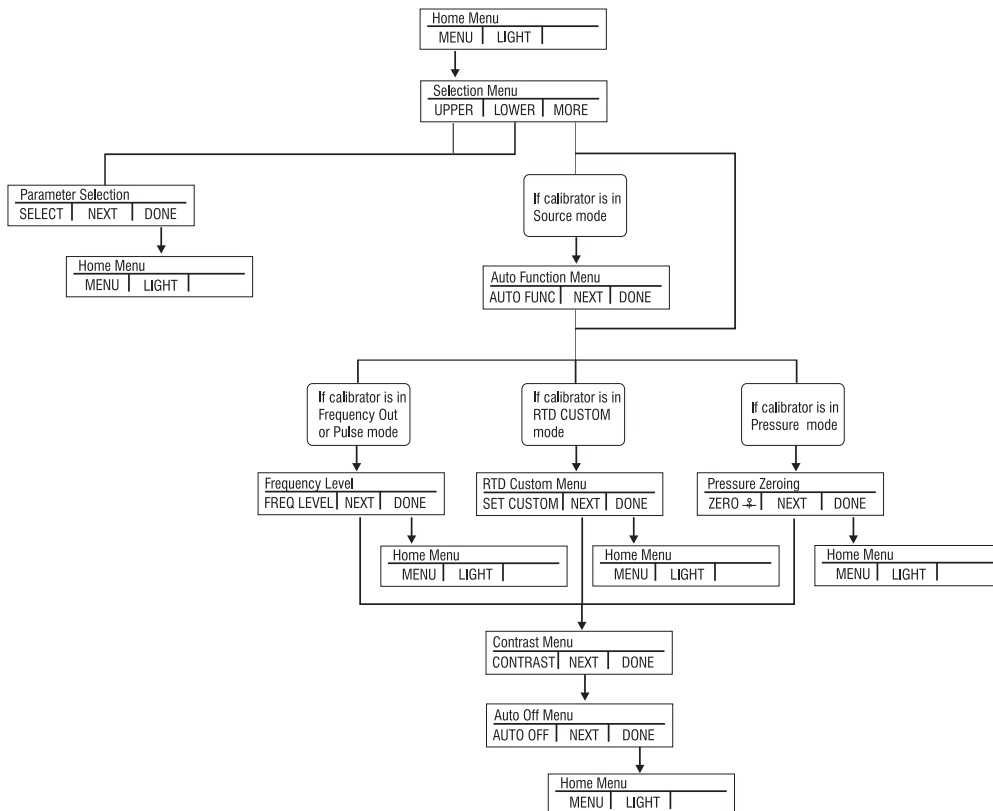


Figure 4. The Menu Tree

### 3. Using Measure Modes (Lower Display)

#### 3.1 Measuring volts and frequency

Electrical parameters volts and frequency can be measured using the lower display. To make the desired measurements, follow these steps:

1. Switch to the lower display [LOWER] from Main Menu.
2. Select the desired parameter for measurement.
3. Connect leads as shown in Figure 5.

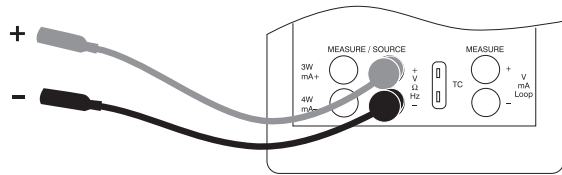
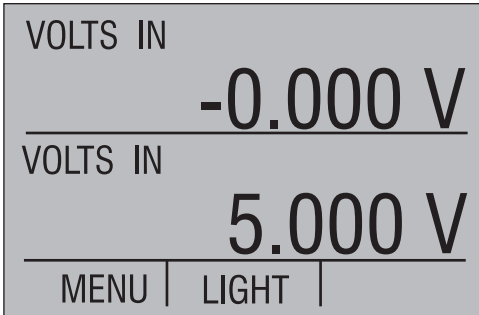


Figure 5. Measuring Volts and Frequency with Input/Output Terminals

#### 3.2 Measuring mA

To measure mA follow these steps:

1. Switch to lower display and select mA.
2. Make sure the input/output control is set to IN.
3. Connect leads as shown in Figure 6.

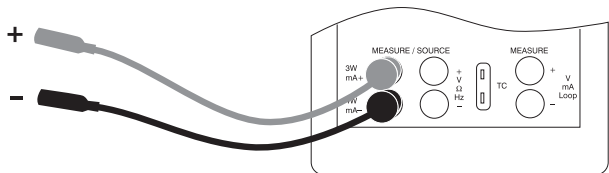
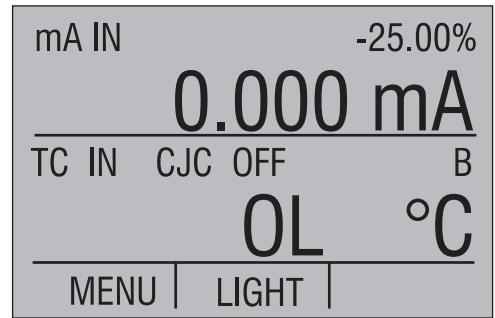


Figure 6. Measuring mA with Input/Output Terminals

### 3.3 Measuring Temperature

#### 3.3-1 Using Thermocouples

The calibrator supports the following thermocouple types: B, C, E, J, K, L, N, R, S, T, U, BP, and XK. The characteristics of all the types are described in Specifications section. The calibrator also has a Cold Junction Compensation (CJC) function. Normally this function should be ON and the actual temperature of the thermocouple will be measured. With CJC OFF, the calibrator will measure the difference between the thermocouple at the junction and at its TC input terminal.



**Note:** CJC off mode should only be used when calibration is being done using an external ice bath.

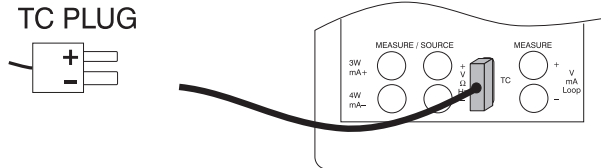
To use the thermocouple to measure temperature, follow these steps:

1. Attach the thermocouple leads to the TC miniplug, and insert the plug into the input/output of the calibrator, as in Figure 7.

**Note:** For best accuracy wait 2 to 5 minutes for the temperature between the miniplug and the calibrator to stabilize before any measurements are taken.

2. Switch to lower display from Main Menu.
3. Select TC from the primary parameters. Choose [IN] in the input/output control, and then the thermocouple type from the sensor types. The temperature unit may also be changed from Celsius to Fahrenheit.

The calibrator can also measure the mV of a Thermocouple, which can be used along with a table in case the corresponding TC type is not supported by the calibrator. To do so, proceed as above and choose mV from sensor types.



**Note:** The TC wire used must match the thermocouple type being calibrated.

**Figure 7. Measuring Temperature Using Thermocouple Terminals**

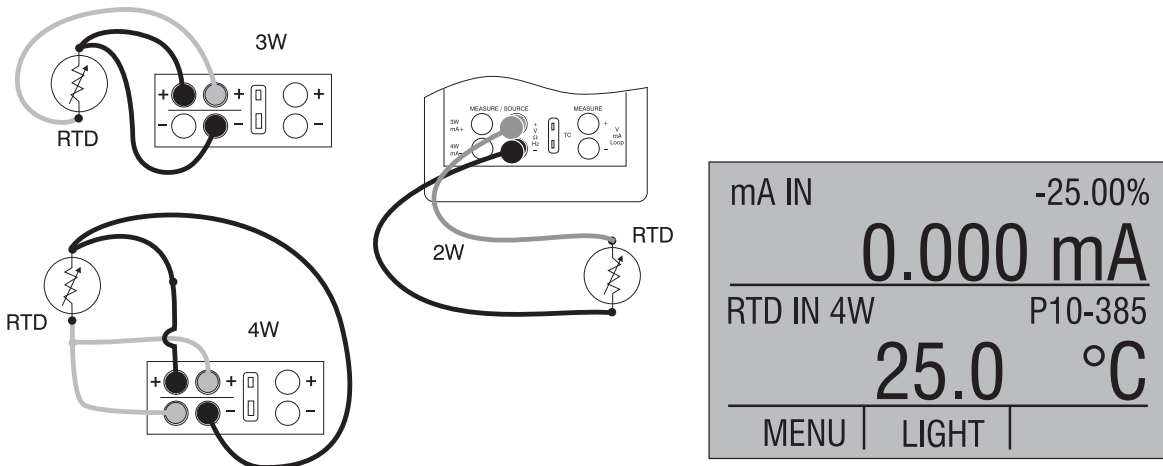
#### 3.3-2 Using Resistance-Temperature-Detectors (RTDs)

The supported types of RTDs are shown in Section 8. Specifications. RTDs are characterized by their 0°C resistance, R0. The calibrator accepts two, three, and four wire inputs, with four wire input being the most accurate.

To use the RTD option, apply the following steps:

1. Switch to lower display [LOWER] from Main Menu.
2. Select RTD from the primary parameters. Select [IN] from input/output control.

3. Choose 2, 3, or 4-wire connection [2W, 3W, 4W]. (4-wire allows for the most precise measurement)
4. Select RTD type from the sensor types.
5. Attach RTD leads as shown in Figure 8.



**Figure 8. Measuring Temperature with RTD Connection**

Resistance can also be measured using this function. To do so, use the above procedure and choose OHMS from the sensor types. This option can be used along with a table to measure an RTD which is not programmed into the calibrator.

### 3.4 Measuring Pressure

**Note:** The MC1210 is compatible with BETA Calibrator Pressure Modules. The accessory BPPA-100 is required for pressure measurement.

**Note:** Pressure is not read from modules with frequency or pulse train mode enabled.

**Note:** On high pressure modules engineering units normally associated with low pressure ranges such as, inH<sub>2</sub>O, cmH<sub>2</sub>O, etc. are not valid selections. Selecting one of this units with a high pressure module attached will cause the display to read "----".

#### **Warning!**

To avoid a violent release of pressure in a pressurized system, shut off the valve and slowly bleed off the pressure before you attach the pressure module to the pressure line.

#### **Caution**

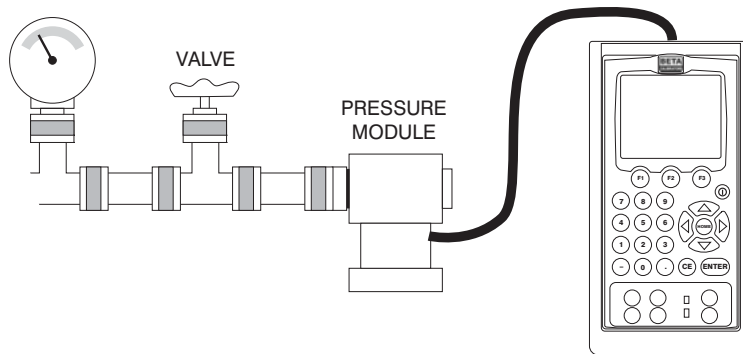
To avoid mechanically damaging the pressure module, never apply more than 10 ft-lb. of torque between the pressure module fittings, or between the fittings and the body of the module.

To avoid damaging the pressure module from overpressure, never apply pressure above the rated maximum printed on the module.

To avoid damaging the pressure module from corrosion, use it only with specified materials. Refer to the pressure module documentation for material compatibility.

To measure pressure, follow these steps:

1. Connect the pressure module to the calibrator as shown in Figure 9.  
The calibrator can measure pressure on both the upper and the lower display. This makes it possible to measure pressure in two different units at the same time.  
**Note:** Make sure the calibrator is on before you plug in the pressure module.
2. Switch to either upper or lower display from the Main Menu.
3. Select [PRESSURE] from the primary parameters.
4. Select the desired measuring unit.
5. Zero the pressure module. The zero function on the calibrator can be found in the pressure zeroing menu.



**Figure 9. Connections for Measuring Pressure**

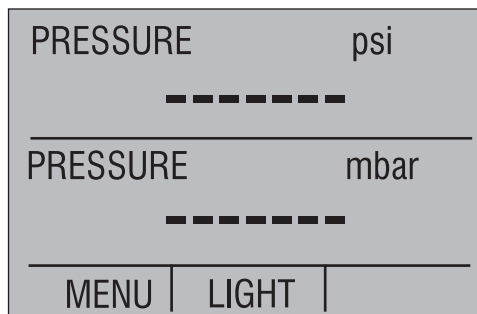
### **3.4-1 Zeroing with Absolute Pressure Modules.**

To zero, adjust the calibrator to read a known pressure, such as barometric pressure.

To adjust the calibrator, follow these steps:

1. Enter the pressure zeroing menu.
2. Select [ZERO  $\varnothing$ ]. [SET REFERENCE ABOVE] will appear. Enter the pressure using the keypad.
3. The calibrator stores the Barometric zero offset in non-volatile memory.

The zero offset is stored for one absolute pressure module at a time. If a new absolute module is connected this process must be repeated.



## 4. Using Source Modes (Lower Display)

The calibrator can generate calibrated signals for testing and calibrating process instruments. It can source voltages, currents, resistances, frequencies, pulses, and the electrical output of RTD and thermocouple temperature sensors.

### 4.1 Setting 0% and 100% Output Parameters

To set the 0% and 100% points, use the following steps:

1. Select the lower display [LOWER] from Main Menu, and choose the desired primary parameter.
2. Select output [OUT] from the input/output control, and enter the desired value. For example select [VOLTS OUT].
3. Enter 5V with the keypad and press Enter.
4. Press any one of the four cursor control arrows to display the setpoint control menu.
5. Hold down the Function Key that corresponds to 0% [F1]. 0% will flash and the setpoint is stored.
6. Repeat these steps, entering 20V and holding the Function Key that corresponds to 100% [F3].
7. Use the [F2] key to step in either 25% or 10% increments.

#### 4.1-1 Stepping the current output

To use the 25% function with mA output, follow these steps:

1. Select the lower display from the Main Menu, and choose mA.
2. Use the 25% key to cycle between 4 mA and 20 mA in 25 % intervals.

### 4.2 Using the Automatic Output Functions

There are two automatic output functions, step and ramp. The selected function can be turned on and off using the Output Home Menu. The Automatic Output Function parameters can be set in the Auto Function Menu.

Parameters include:

1. Which auto function will be available (Step or Ramp).
2. The Auto Function Time, time between steps for step and time to get from over one limit to the next for ramp.
3. Step Size, the step size can be set to either 10% or 25%

The limits for the ramp and step functions are set to the 0% and 100% values. See Section 4.1 Setting 0% and 100% Output Parameters. Steps are in either 10% or 25% increments from the 0% value to the 100% value.

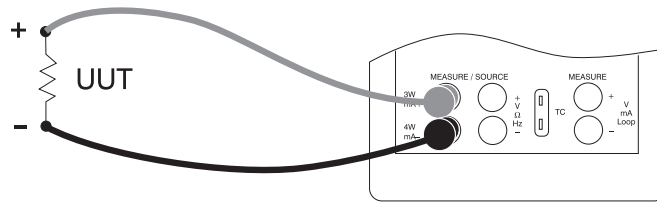
### 4.3 Sourcing mA

To source a current, follow these steps:

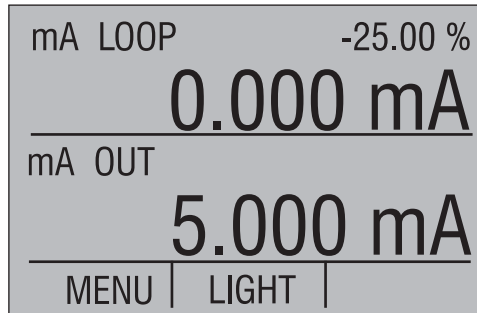
1. From the Main Menu select lower display [LOWER]. Choose [mA] from the primary parameters.
2. Switch to input/output control, and select output [OUT].
3. Connect the leads to the mA terminals, as shown in Figure 10.
4. Enter the desired current using the keypad.



1000 ohms max.



**Figure 10. Connections for Sourcing Current**



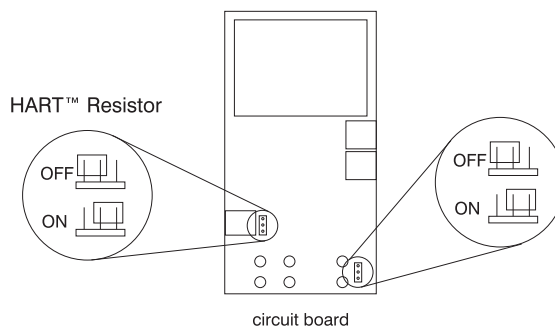
#### **4.3-1 HART™ Resistor Selection**

The MC1210 can be set-up so that the 250 ohm resistor required for Hart™ configuration devices resides inside the MC1210. Enabling the MC1210's internal 250 ohm resistor eliminates the need to manually add a series resistor during a Hart™ calibration process.

**NOTE:** When the MC1210's internal 250 resistor is enabled, maximum load driving capability drops from 1000 ohms @ 20mA to 750 ohms @20mA.

#### **Enable/Disable Procedure**

1. Remove the battery cover and remove the 2 screws that are at the top of the case.
2. Remove the 2 screws on the bottom or lower portion of the case.
3. Gently remove the top half of the case from the bottom.
4. Figure 10a. shows the location of the Hart™ jumpers.

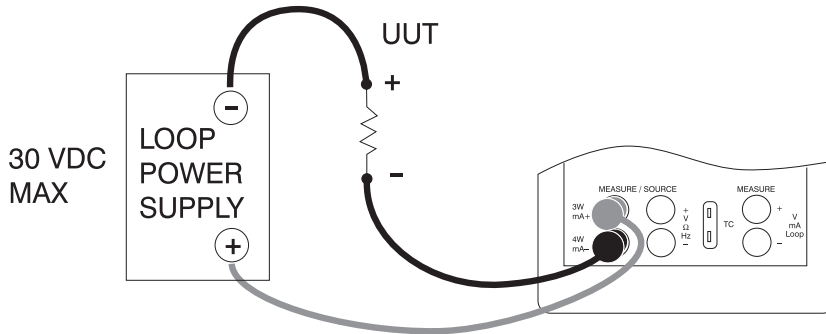


**Figure 10a.**

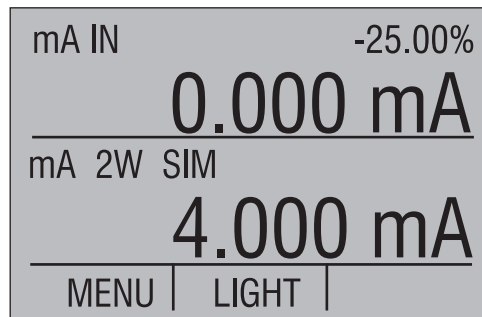
## 4.4 Simulating a Transmitter

To have the calibrator supply a variable test current to a loop in place of a transmitter, follow these steps:

1. Select lower display from the Main Menu.
2. Choose mA simulation from the primary parameters [mA 2W SIM], and enter the desired current.
3. Connect the 24V loop as shown in Figure 11.



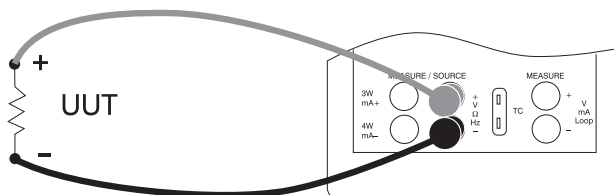
**Figure 11. Connections for Simulating a Transmitter**



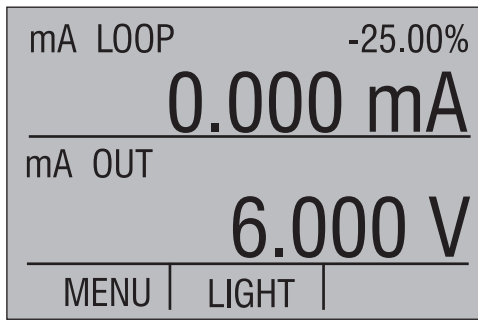
## 4.5 Sourcing volts

To source volts follow these steps:

1. Select lower display from the Main Menu.
2. Choose [VOLTS] from the primary parameters. Switch to input/output control and select output [OUT].
3. Connect the leads for the voltage source terminals, as shown in Figure 12.
4. Enter the voltage using the keypad.



**Figure 12. Connections for Sourcing Voltage and Frequency**



#### 4.6 Sourcing frequency

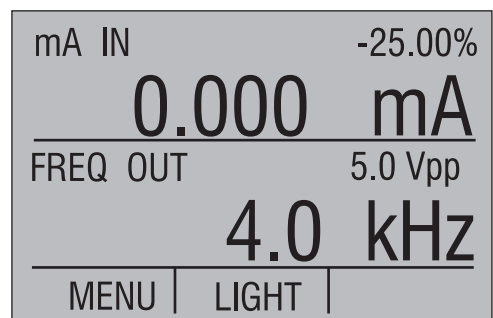
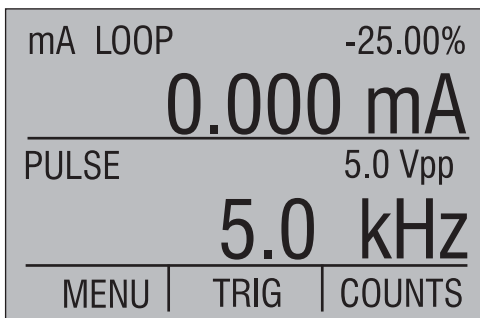
To source a signal use these steps:

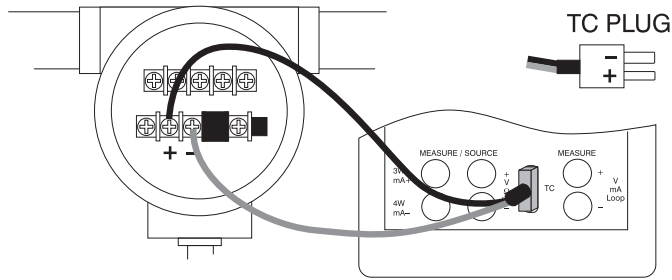
1. Switch to the lower display and select frequency from the primary parameters.
2. Select output, and then choose the frequency units.
3. Connect the leads to the frequency output terminals as shown in Figure 12.
4. Enter the desired frequency using the keypad.
5. To change the amplitude, select [FREQ LEVEL] from frequency level menu.
6. Enter the amplitude.

#### 4.7 Sourcing a pulse train

The calibrator can produce a pulse train with an adjustable number of pulses at a desired frequency. For example, setting the frequency to 60Hz and the number of pulses to 60 would produce 60 pulses for a period of 1 second. To source a pulse, use the same connection as for frequency, and proceed as follows:

1. Switch to the lower display and select pulse from the primary parameters.
2. Choose the desired unit and enter the frequency using the keypad.
3. Select the [COUNTS] function from the home menu to enter the number of pulses. Use [TRIG] to start and stop the signal.
4. The amplitude of the pulse can be adjusted in the same manner as for frequency.





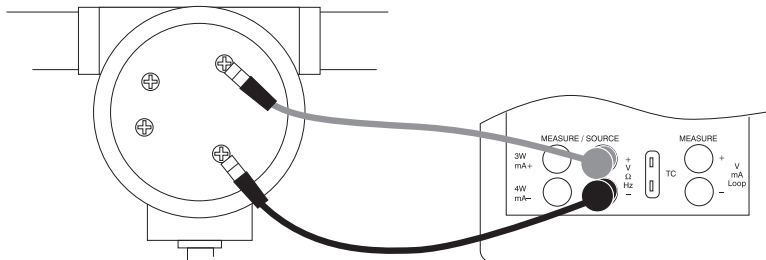
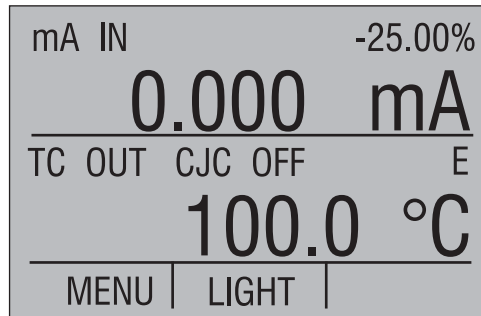
Note: TC wire used must match the thermocouple type being calibrated.

**Figure 13. Connections for Outputting Thermocouples**

## 4.8 Sourcing Thermocouples

To source a thermocouple use the following steps:

1. Connect the thermocouple leads to the appropriate polarized TC miniplug, and insert the plug into the TC terminals on the calibrator, as shown in Figure 13.
2. Select lower display from the Main Menu, and choose thermocouple [TC] from the primary parameters.
3. Choose output [OUT] from the input/output control.
4. Select the desired thermocouple type from the sensor types.
5. Enter the temperature using the keypad.

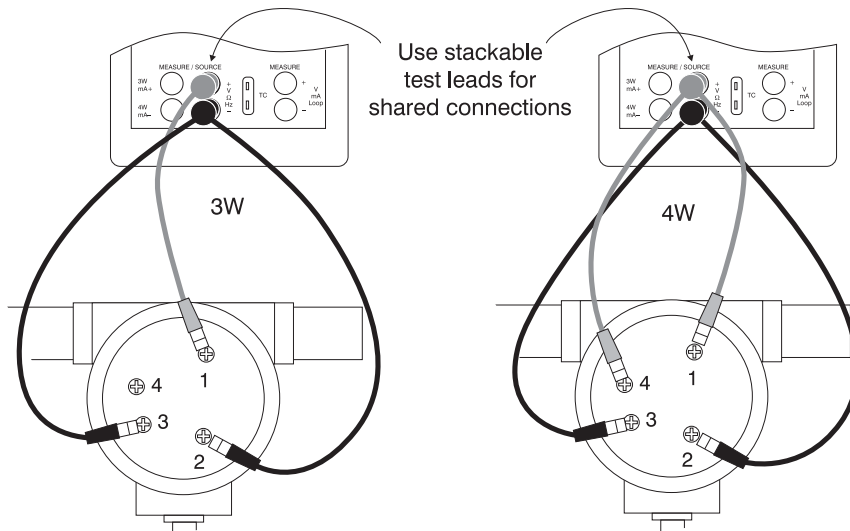


**Figure 14. Connections for Outputting RTDs**

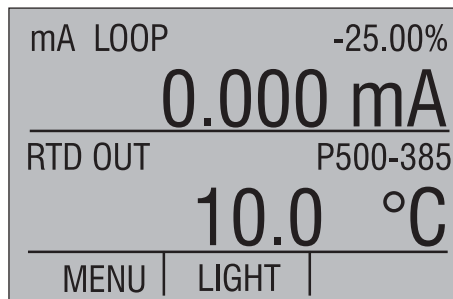
## 4.9 Sourcing Ohms/RTDs

To source an RTD, follow these steps:

1. Select lower display from the Main Menu, and choose [RTD] from the primary parameters.
2. Choose output [OUT] from the input/output control, and select RTD type from the sensor types.
3. Connect the calibrator to the instrument being tested, as in Figure 14.
4. Enter the temperature or resistance using the keypad.



**Figure 15. Using a 3- or 4-wire Connection for RTDs**



**Note:** The calibrator simulates a 2-wire RTD. To connect 3- or 4-wire transmitter, use stacking cables, as shown in Figure 15.

### 4.9-1 Custom RTD

A custom curve-fit PRT may be entered into the calibrator for sourcing and measuring. To do so follow these steps:

1. Switch to lower display. Select RTD and set sensor type to CUSTOM.
2. Enter the RTD custom setup main menu, and select [SET CUSTOM].
3. Using the keypad, enter the values that the calibrator prompts for: minimum

temperature, maximum temperature, R0, and the values for each of the temperature coefficients.

The custom function uses the Calendar-Van Dusen equation for outputting and measuring custom RTDs. The coefficient C is only used for temperatures below 0°C. Only A and B coefficients are needed for the range above 0°C, so coefficient C should be set to 0. The R0 is the resistance of the probe at 0°C. The coefficients for PT385, PT3926, and PT3616 are shown in Table 4 below.

**Table 4. RTD Coefficients**

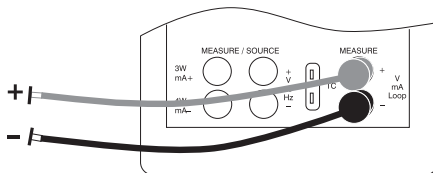
RTD	Range(°C)	R0	Coefficient A	Coefficient B	Coefficient C
PT385	-260 - 0	100	3.9083x10-3	-5.775x10-7	-4.183x10-12
PT385	0 - 630	100	3.9083x10-3	-5.775x10-7	---
PT3926	Below 0	100	3.9848x10-3	-5.87x10-7	-4x10-12
PT3926	Above 0	100	3.9848x10-3	-5.87x10-7	---
PT3916	Below 0	100	3.9692x10-3	-5.8495x10-7	-4.2325x10-12
PT3916	Above 0	100	3.9692x10-3	-5.8495x10-7	---

## 5. Using Isolated Measure Modes (Upper Display)

### 5.1 Measuring volts and mA

Use the following steps to measure the voltage or current output of a transmitter.

1. Select the upper display from the Main Menu.
2. Select the desired primary parameter to be measured. Connect the leads to the isolated inputs of the calibrator, as in Figure 16.

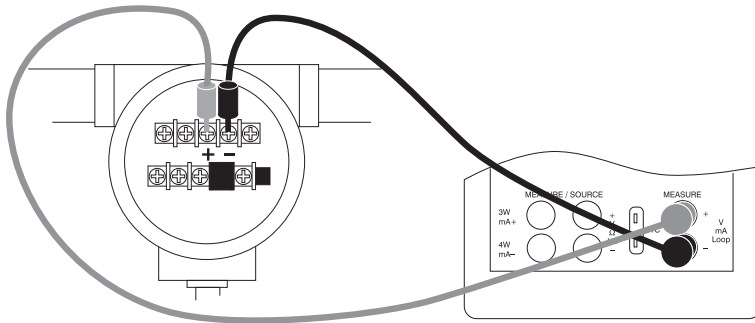


**Figure 16. Isolated Input Connection**

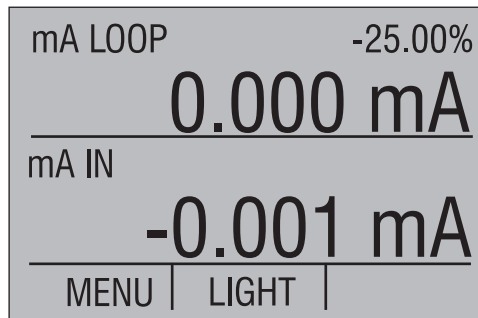
### 5.2 Measuring current with loop power

To test a 2-wire, loop powered transmitter that is disconnected from wiring, use the loop power function. This function activates a 24V supply in series with the current measuring circuit. To use this option proceed as follows:

1. Select [mA LOOP] as primary parameter in the upper display.
2. Connect the calibrator to transmitter current loop terminals, as shown in Figure 17.



**Figure 17. Connection Using Current Loop**



### 5.2-1 HART™ Resistor Selection

The MC1210 can be set-up so that the 250 ohm resistor required for Hart™ configuration devices resides inside the MC1210. Enabling the MC1210's internal 250 ohm resistor eliminates the need to manually add a series resistor during a Hart™ calibration process.

**NOTE:** When the MC1210's internal 250 resistor is enabled, maximum load driving capability drops from 1000 ohms @ 20mA to 750 ohms @20mA.

#### Enable/Disable Procedure

1. Remove the battery cover and remove the 2 screws that are at the top of the case.
2. Remove the 2 screws on the bottom or lower portion of the case.
3. Gently remove the top half of the case from the bottom.
4. Figure 10a. shows the location of the Hart™ jumpers.

### 5.3 Measuring Pressure

**Note:** The MC1210 is compatible with BETA Calibrator Pressure Modules. The accessory BPPA-100 is required for pressure measurement.

**Note:** Pressure is not read from modules with frequency or pulse train mode enabled.

#### **Warning!**

To avoid a violent release of pressure in a pressurized system, shut off the valve and slowly bleed off the pressure before you attach the pressure module to the pressure line.

## Caution

To avoid mechanically damaging the pressure module, never apply more than 10 ft-lb. of torque between the pressure module fittings, or between the fittings and the body of the module.

To avoid damaging the pressure module from overpressure, never apply pressure above the rated maximum printed on the module.

To avoid damaging the pressure module from corrosion, use it only with specified materials. Refer to the pressure module documentation for material compatibility.

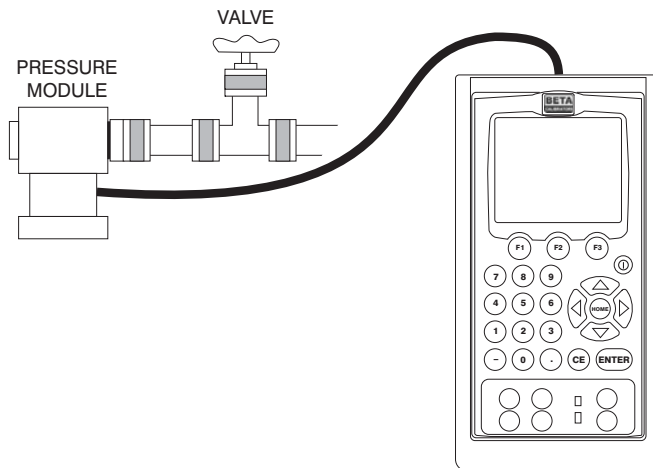
To measure pressure, follow these steps:

1. Connect the pressure module to the calibrator as shown in Figure 18.

The calibrator can measure pressure on both the upper and the lower display. This makes it possible to measure pressure in two different units at the same time.

**Note:** Make sure the calibrator is on before you plug in the pressure module.

2. Switch to either upper or lower display from the Main Menu.
3. Select [PRESSURE] from the primary parameters.
4. Select the desired measuring unit.
5. Zero the pressure module. The zero function on the calibrator can be found in the pressure zeroing menu.



**Figure 18. Measuring Pressure Transmitter**

**Note:** On high pressure modules engineering units normally associated with low pressure ranges such as, inH<sub>2</sub>O, cmH<sub>2</sub>O, etc. are not valid selections. Selecting one of this units with a high pressure module attached will cause the display to read "----".

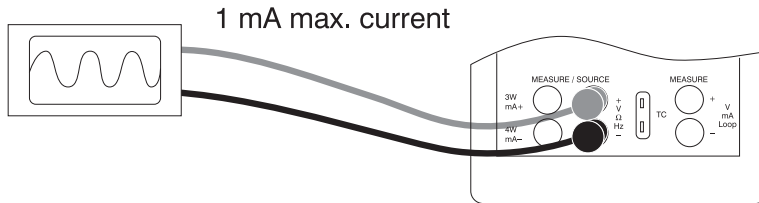


## 6. Using the Upper and the Lower Display for Calibration and Testing

### 6.1 Testing an Input or Indicating Device

To test and calibrate actuators, recording, and indicating devices using the source functions, follow these steps:

1. Select the lower display and choose the correct primary parameter.
2. Switch to [OUT] in the input/output control.
3. Connect the leads to the instrument and the calibrator as shown in Figure 19.

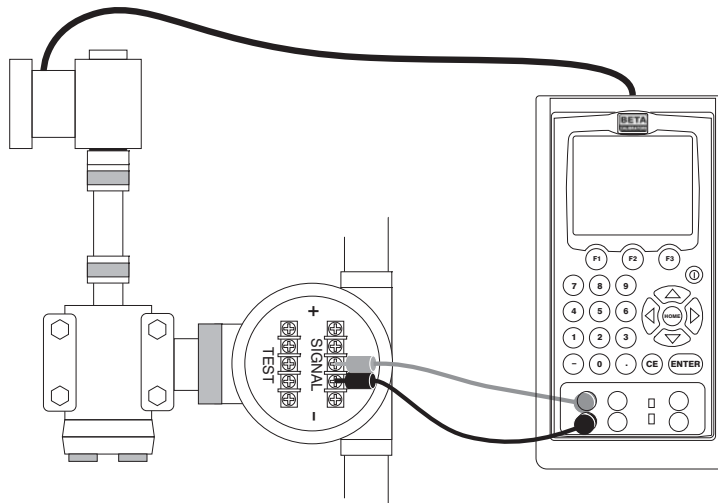


**Figure 19. Connections for Testing an Output Device**

### 6.2 Calibrating an I/P Device

The following steps show how to calibrate a device that controls pressure:

1. Select upper display from the Main Menu, and select pressure from the primary parameters.
2. Switch to lower display from the Main Menu, and select current source [mA out] from the primary parameters.
3. Connect the calibrator to the device as shown in Figure 20. The calibrator will simulate the transmitter current and measure the output pressure.
4. Enter a current using the keypad.



**Figure 20. Calibrating an I/P Device**

### 6.3 Calibrating a Transmitter

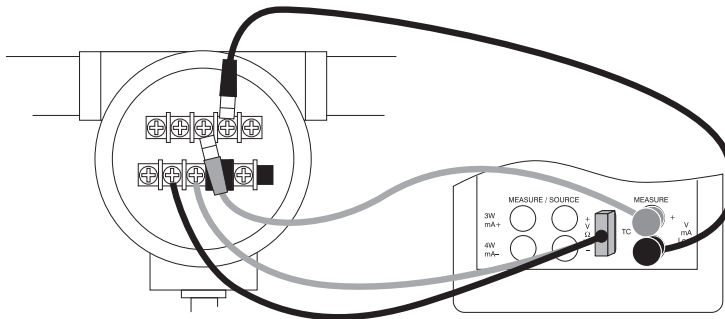
To calibrate a transmitter both the upper and the lower displays will be used; one for measuring and the second a source. This section covers all but the pressure transmitters. A thermocouple temperature transmitter is used in this example.

The following steps show how to calibrate a temperature transmitter:

1. From the Main Menu select upper display, and choose current loop [mA LOOP].
2. Switch to lower display from the Main Menu, and select [TC] from the primary parameters. Choose output [OUT] from the input/output control, and select TC type.
3. Set the 0 % and 100 % span points using the keypad and the 0% and 100% keys (refer to Setting 0 % and 100 % Parameters section).
4. Connect the calibrator to the transmitter as shown in Figure 21.
5. Test transmitter at 0- 25- 50- 75- 100 % using the 25 % step function (25% key).

Adjust the transmitter as necessary.

To calibrate a different transmitter, follow the above steps with the exception of choosing TC on the lower display. Replace TC with the correct parameter for the transmitter.

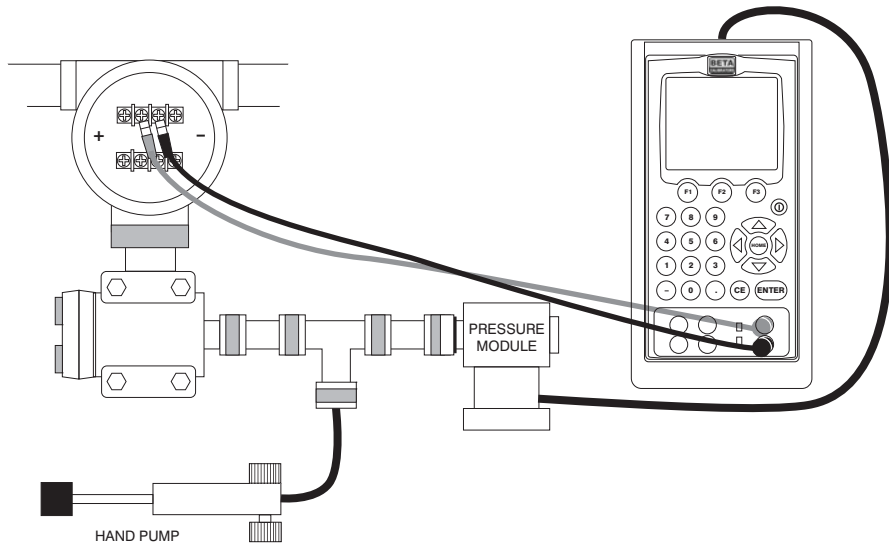


**Figure 21. Calibrating a Transmitter**

### 6.4 Calibrating a Pressure Transmitter

To calibrate a pressure transmitter, use these steps:

1. Select upper display from the Main Menu, and choose current [mA LOOP] from the primary parameters. Return to Main Menu.
2. Select lower display, and choose [PRESSURE] from the primary parameters.
3. Connect the calibrator to the transmitter and the pressure module as in Figure 22.
4. Zero the pressure module.
5. Test the transmitter at 0 % and 100 % of the span, and adjust as necessary.

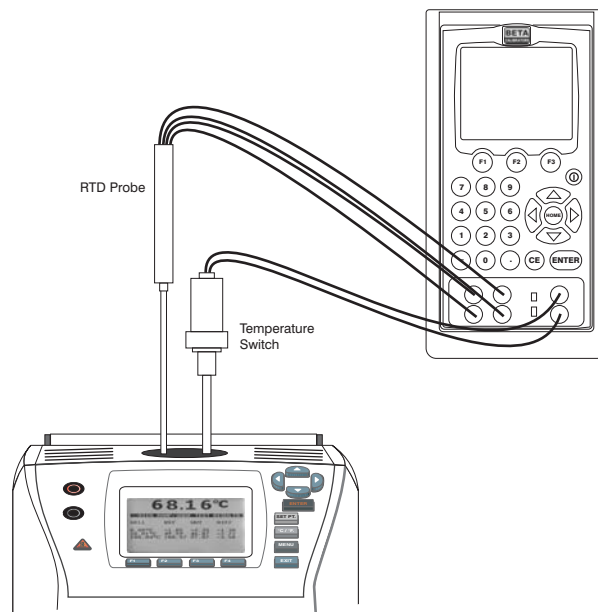


**Figure 22. Calibrating a Pressure Transmitter**

## 7. Performing a Switch Test

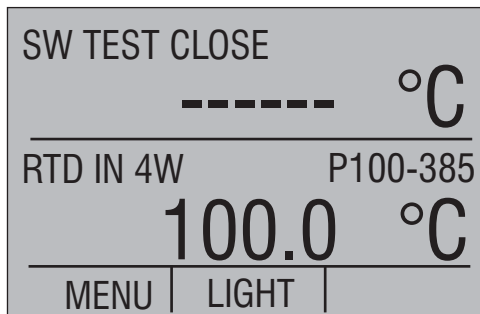
The calibrator can stimulate a switch and capture the results in any source/simulate mode (except pulse) and the calibrator can also monitor a switch and capture the results in any read mode based on the input requirements of the switch. Examples are given below for a temperature switch with an external temperature source and a pressure switch.

### 7.1 Performing an Temperature Switch Test:

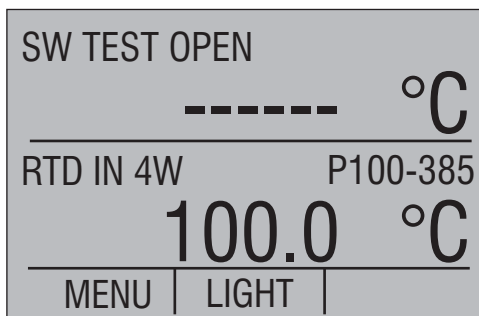


**Figure 23. Temperature Switch Test**

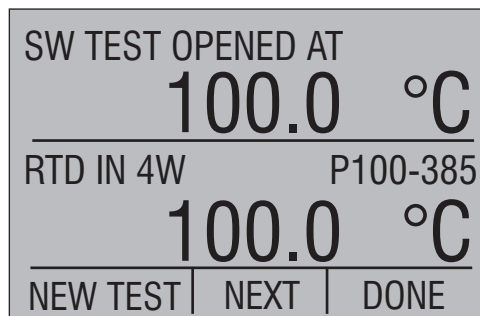
1. Use the menu to select SW TEST on the upper display.
2. Connect the calibrator to the switch using the switch terminals. The polarity of the terminals does not matter.
3. The top of the display will read “CLOSE”.



4. Raise the temperature slowly until the switch opens.
5. Once the switch is open, “OPEN” will be displayed, lower the temperature slowly until the switch closes.



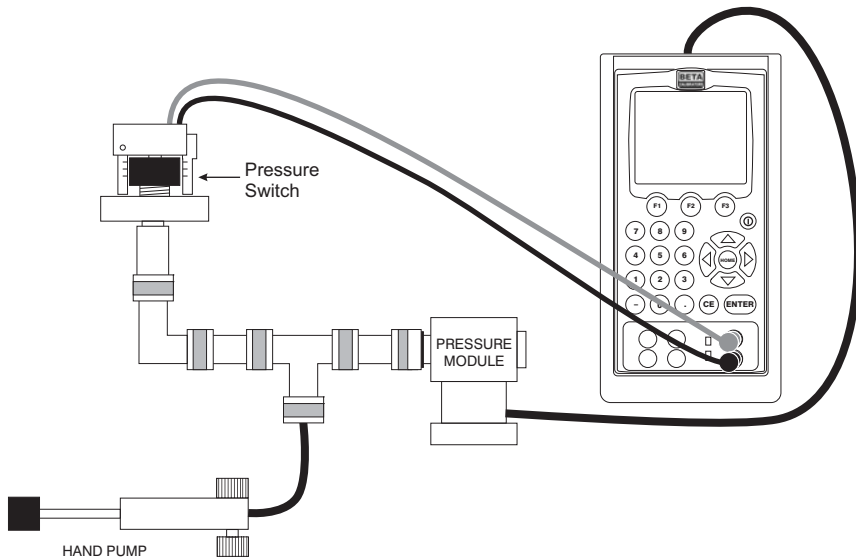
6. At the top of the display it will now read, “SW OPENED AT” and give you the temperature that the switch opened at.



7. Press the “NEXT” option to view when the switch closed, and the dead band.
8. Press the “NEW TEST” option to get back to the main menu, clear the data and perform another test.

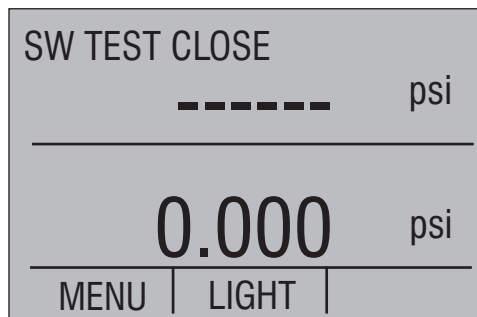
**Important NOTE:** The previous example uses a normally closed switch. The basic procedure is still the same for a normally open switch, the display will just read “OPEN” instead of “CLOSE”.

## 7.2 Performing a pressure switch test:



**Figure 24. Pressure Switch Test**

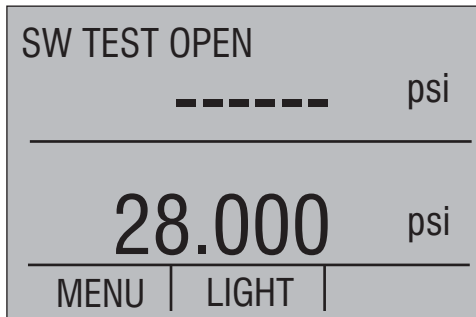
1. Use the menu to select SW TEST on the upper display.
2. Connect the calibrator to the switch using the pressure switch terminals. The polarity of the terminals does not matter. Then connect the pump to the calibrator and the pressure switch.
3. Make sure the vent on the pump is open. Zero the calibrator if necessary. Close vent after zeroing the calibrator.
4. The top of the display will read “CLOSE”.



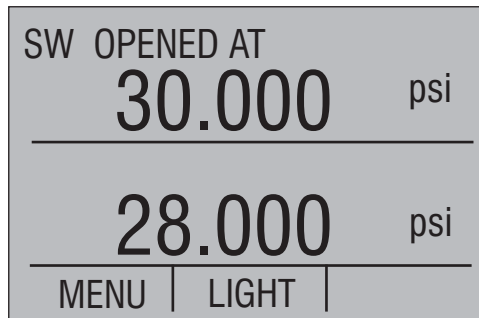
5. Apply pressure with the pump slowly until the switch opens.

**Important NOTE:** In the switch test mode the display update rate is increased to help capture changing pressure inputs. Even with this enhanced sample rate pressurizing device under test should be done slowly to ensure accurate readings.

6. Once the switch is open, “OPEN” will be displayed, bleed the pump slowly until the pressure switch closes.



7. At the top of the display it will now read, “SW OPENED AT” and give you the pressure that the switch opened at.

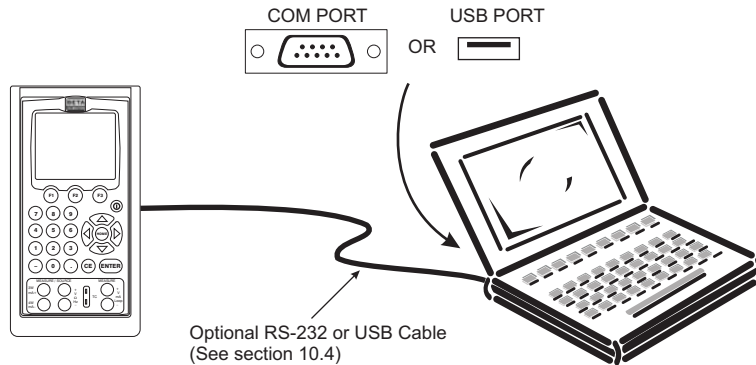


8. Press the “NEXT” option to view when the switch closed, and the dead band.

**Important NOTE:** The previous example uses a normally closed switch. The basic procedure is still the same for a normally open switch, the display will just read “OPEN” instead of “CLOSE”.

## 8. Remote Operation

The calibrator can be remotely controlled using a PC terminal, or by a computer program running the calibrator in an automated system. It uses an RS-232 serial port connection for remote operation. With this connection the user can write programs on the PC, with Windows languages like Visual Basic to operate the calibrator, or use a Windows terminal, such as Hyper Terminal, to enter single commands. Typical RS-232 remote configurations are shown in Figure 25.



**Figure 25. Calibrator-to-Computer Connection**

### 8.1 Setting up the RS-232 Port for Remote Control

**Note:** The RS-232 connection cable should not exceed 15m unless the load capacitance measured at connection points is less than 2500pF.

Serial parameter values:

9600 baud

8 data bits

1 stop bit

no parity

Xon/Xoff

EOL (End of Line) character or CR (Carriage Return) or both

To set up remote operation of the calibrator on the Windows Hyper Terminal, connected to a COM port on the PC as in Figure 23, use the following procedure:

1. Start Hyper Terminal (located in Accessories/Communications of the Windows Start menu)
2. Select New Connection.
3. For Name enter MC1210. Select the serial port that the unit is connected to.
4. Enter the above information for port settings.
5. Select ASCII setup from File/Properties/Settings and mark these choices:
  - Echo typed characters locally
  - Wrap lines that exceed terminal width

6. Select Ok
7. To see if the port works enter \*IDN?. This command will return information on the unit.

## 8.2 Changing Between Remote and Local Operation

There are three modes of operation of the calibrator, Local, Remote, and Remote with Lockout. Local mode is the default mode. Commands may be entered using the keypad on the unit or using a computer. In Remote mode the keypad is disabled, and commands may only be entered using a computer, but choosing [GO TO LOCAL] from the menu on the calibrator display will restore keypad operation. In Remote with Lockout, the keypad can not be used at all. To switch modes proceed as follows:

1. To enable Remote mode, type in the serial command REMOTE at the computer terminal.
2. To enable Remote with Lockout, type in REMOTE and LOCKOUT in either order.
3. To switch back to local operation enter LOCAL at the terminal. This command also turns off LOCKOUT if it was on. For more information on commands refer to the Remote Commands section.

## 8.3 Using Commands

### 8.3-1 Command types

Refer to the Section on Remote Commands for all available commands.

The calibrator may be controlled using commands and queries. All commands may be entered using upper or lower case. The commands are divided into the following categories:

#### Calibrator Commands

Only the calibrator uses these commands. For example

```
LOWER_MEAS DCV
```

tells the calibrator to measure voltage on the lower display.

#### Common Commands

Standard commands used by most devices. These commands always begin with an "\*". For example

```
*IDN?
```

tells the calibrator to return its identification.

#### Query Commands

Commands that ask for information. They always end with a "?". For example:

```
FUNC?
```

Returns the current modes of the upper and lower displays.



## Compound Commands

Commands that contain more than one command on one line. For example:

```
LOWER_MEAS RTD; RTD_TYPE CU10
```

Sets the calibrator to measure RTD in the lower display and sets RTD type to Cu 10.

## Overlapped Commands

Commands that require more time to execute than normal. The command \*WAI can be used after the overlapped command to tell the calibrator to wait until the command finishes before executing the next command. For example:

```
TRIG; *WAI
```

Triggers the pulse train. Once the pulse train has been triggered, the calibrator can proceed to the next command.

## Sequential Commands

Commands that are executed immediately after the are entered. This type includes most of the commands.

### 8.3-2 Character Processing

The data entered into the calibrator is processed as follows:

- ASCII characters are discarded if their decimal equivalent is less than 32 (space), except 10 (LF) and 13 (CR):
- Data is taken as 7-bit ASCII
- The most significant data bit is ignored.
- Upper or lower case is acceptable.

### 8.3-3 Response Data Types

The data returned by the calibrator can be divided into four types:

#### Integer

For most computers and controllers they are decimal numbers ranging from -32768 to 32768. For example:

```
*ESE 140; *ESE? returns 140
```

#### Floating

Numbers that have up to 15 significant figures and exponents. For example:

```
CPRT_COEFA? returns 3.908000E-03
```

#### Character Response Data (CRD)

Data returned as keywords. For example:

```
RTD_TYPE? returns PT385_10
```

## **Indefinite ASCII (IAD)**

Any ASCII characters followed by a terminator. For example:

\*IDN? returns MARTEL, MC1210, 250, 1.00

## **8.3-4 Calibrator Status**

Status registers, enable registers, and queues provide status information on the calibrator. Each status register and queue has a summary bit in the Serial Poll Status Byte. Enable registers generate summary bits in the Serial Poll Status Byte. The following is a list of registers and queues along with their function.

### **Serial Poll Status Byte (STB)**

The STB is sent when the calibrator responds to the \*STB? command. Figure 24 demonstrates how it functions. Cleared when power is reset.

### **Service Request Enable Register (SRE)**

Enables or disables the bits of the STB. Cleared when power is reset. Setting bits to 0 disables them in the STB. Setting the bits to 1 enables them. Bit assignments for the SRE and the STB are shown below.

7	6	5	4	3	2	1	0
0	MSS	ESB	0	EAV	0	0	0

#### **MSS**

Master Summary Status. Set to 1 when ESB or EAV are 1 (enabled). Read using the \*STB? command.

#### **ESB**

Set to 1 when at least one bit in ESR is 1.

#### **EAV**

Error Available. An error has been entered into the error queue, and may be read using the Fault? command.

### **Event Status Register (ESR)**

A two-byte register, in which the lower bits represent conditions of the Calibrator. Cleared when read and when power is reset.

### **Event Status Enable Register (ESE)**

Enables and disables bits in the ESR. Setting a bit to 1 enables the corresponding bit in the

ESR, and setting it to 0 disables the corresponding bit. Cleared at power reset. Bit assignments for the ESR and the ESE respectively are shown below.

15	14	13	12	11	10	9	8
0	0	0	0	0	0	0	0

7	6	5	4	3	2	1	0
PON	0	CME	EXE	DDE	QYE	0	OPC

### **PON**

Power On. Set to 1 if power was turned on and off before the Event Status Register was read.

### **CME**

Command Error. Set to 1 when the calibrator receives an invalid command. Entering an unsupported RTD type may cause such an error.

### **EXE**

Execution Error. Set to 1 when the calibrator runs into an error while executing its last command. A parameter that has too significant figures may cause such an error.

### **DDE**

Device-dependent Error. Set to 1 when, for example, the output of the calibrator is overloaded.

### **QYE**

Query Error.

### **OPC**

Operation Complete. Set to 1 when the calibrator has finished executing all commands before the command \*OPC was entered.

## **Error Queue**

If an error occurs due to invalid input or buffer overflow, its error code is sent to the error queue. The error code can be read from the queue with the command FAULT?. The error queue holds 15 error codes. When it is empty, FAULT? returns 0. The error queue is cleared when power is reset or when the clear command \*CLS is entered.

## Input Buffer

Calibrator stores all received data in the input buffer. The buffer holds 250 characters. The characters are processed on a first in, first out basis.

## 8.4 Remote Commands and Error Codes

The following tables list all commands, and their descriptions, that are accepted by the calibrator.

**Table 5: Common Commands**

Command	Description
*CLS	*CLS (Clear status.) Clears the ESR, the error queue, and the RQS bit in the status byte. Terminates pending Operation Complete commands
*ESE	Loads a byte into the Event Status Enable register.
*ESE?	Returns the contents of the Event Status Enable register.
*ESR?	Returns the contents of the Event Status register and clears the register.
*IDN?	Identification query. Returns the manufacturer, model number, and firmware revision level of the Calibrator.
*OPC	Enables setting of bit 0 (OPC for "Operation Complete") in the Event Status Register to 1 when all pending device operations are complete.
*OPC?	Returns a 1 after all pending operations are complete. This command causes program execution to pause until all operations are complete.
*RST	Resets the state of the instrument to the power-up state. This command holds off execution of subsequent commands until it is complete.
*SRE	Loads a byte into the Service Request Enable register.
*SRE?	Returns the byte from the Service Request Enable register.
*STB?	Returns the status byte.
*WAI	Prevents further remote commands from being executed until all previous remote commands have been executed.

**Table 6: Calibrator Commands**

Command	Description
CAL_START	Puts the calibrator in calibration mode
CJC_STATE	Turns CJC on or off.
CJC_STATE?	Returns the state of the CJC
CPRT_COEFA	Sets the custom RTD coefficient A
CPRT_COEFA?	Returns the custom RTD coefficient A
CPRT_COEFB	Sets the custom RTD coefficient B
CPRT_COEFB?	Returns the custom RTD coefficient B

<b>Command</b>	<b>Description</b>
CPRT_COEFC	Sets the custom RTD coefficient C
CPRT_COEFC?	Returns the custom RTD coefficient C
CPRT_MIN_T	Sets the custom RTD minimum temperature
CPRT_MIN_T?	Returns the custom RTD minimum temperature
CPRT_MAX_T	Sets the custom RTD maximum temperature
CPRT_MAX_T?	Returns the custom RTD maximum temperature
CPRT_R0	Sets the custom RTD R0 resistance
CPRT_R0?	Returns the custom RTD R0 resistance
FAULT?	Returns the error code of an error that has occurred
FREQ_LEVEL	Sets the frequency and pulse amplitude
FREQ_LEVEL?	Returns the frequency and pulse amplitude
FREQ_TYPE	Set the frequency output to continuous (frequency) or pulse.
FREQ_TYPE?	Returns frequency output type, continuous or pulse
FREQ_UNIT	Sets the unit for frequency and pulse
FREQ_UNIT?	Returns the unit for frequency and pulse
FUNC?	Returns the current mode of the upper and lower display
LOCAL	Returns user to manual operation of the calibrator
LOCKOUT	Locks out the keypad of the calibrator, and allows for remote operation only
LOWER_MEAS	Sets the mode for measuring on the lower display.
L_PRES_UNIT	Sets the pressure unit on the lower display
OUT	Sets the output of the calibrator
OUT?	Returns the output of the calibrator
PRES?	Returns the model and serial number of the attached pressure module
PRES_UNIT?	Returns the pressure unit for the upper and lower display
PULSE_CNT	Sets the number of pulses for the pulse train
PULSE_CNT?	Returns the number of pulses in the pulse train
REMOTE	Puts the calibrator in remote mode
RTD_TYPE	Sets the RTD type
RTD_TYPE?	Returns the RTD type
RTD_WIRE	Sets the number of wires used by the RTD mode.
RTD_WIRE?	Returns the wire number setting used in the RTD mode
SIM	Sets the output for mA simulation
SIM?	Returns the output of the mA simulation
ST_CLOSE?	Returns value at which the switch closed
ST_DEAD?	Returns value of the deadband of the switch
ST_OPEN	Returns value of the deadband of the switch
ST_START	Starts a switch test
TC_TYPE	Sets the thermocouple type

<b>Command</b>	<b>Description</b>
TC_TYPE?	Returns the thermocouple type
TEMP_UNIT	Sets input/output temperature unit for RTD and TC
TEMP_UNIT?	Returns the temperature unit for RTD and TC
TRIG	Starts and stops the pulse train in pulse mode
TRIG?	Returns TRIGGERED when a pulse train is on. Returns UNTRIGGERED when the pulse train is off.
TSENS_TYPE	Sets temperature sensor type.
TSENS_TYPE?	Returns temperature sensor type
UPPER_MEAS	Sets the measuring mode for the upper display.
U_PRES_UNIT	Sets the upper pressure unit
VAL?	Returns the measured values
ZERO_MEAS	Zeros the pressure module
ZERO_MEAS?	Returns the zero offset of the pressure module

**Table 7: Parameter units**

<b>Units</b>	<b>Meaning</b>
MA	milliamps of current
MV	Voltage in millivolts
V	Voltage in volts
CPM	Frequency in cycles per minute
Hz	Frequency in Hertz
KHz	Frequency in kiloHertz
Ohms	Resistance in Ohms
Cel	Temperature in Celsius
Far	Temperature in Fahrenheit
PSI	Pressure in pounds per square-inch
INH2O4C	Pressure in inches of water at 4°C
INH2O20C	Pressure in inches of water at 20°C
INH2O60F	Pressure in inches of water at 60°F
CMH2O4C	Pressure in centimeters of water at 4°C
CMH2O20C	Pressure in centimeters of water at 20°C
BAR	Pressure in bars
MBAR	Pressure in millibars
MPAL	Pressure in MegaPascals
KPAL	Pressure in kiloPascals
INHG	Pressure in inches of mercury at 0°C
MMHG	Pressure in millimeters of mercury at 0°C
KG/CM2	Pressure in kilograms per square-centimeter

<b>Units</b>	<b>Meaning</b>
MMH2O4C	Pressure in millimeters of water at 4°C
MMH2O20C	Pressure in millimeters of water at 20°C
FTH2O60F	Pressure in feet of water at 60°F

**Table 8: Error codes**

<b>Error Number</b>	<b>Error Description</b>
100	A non-numeric entry was received where it should be a numeric entry
101	Too many significant digits entered
102	Invalid units or parameter value received
103	Entry is above the upper limit of the allowable range
104	Entry is below the lower limit of the allowable range
105	A required command parameter was missing
106	An invalid pressure unit was received
107	An invalid CJC_STATE was received
108	An invalid TSENS_TYPE was received
109	Pressure module not connected
110	An unknown command was received
111	An invalid RTD or TC parameter value was received
112	The serial input buffer overflowed
113	Too many entries in the command line
114	The serial output buffer overflowed
115	Output is overloaded
116	Calibrator not in pulse train mode when TRIG was received
117	An invalid FREQ_TYPE was received

## **8.5 Entering Commands**

Commands for the calibrator may be entered in upper or lower case. There is at least one space required between the command and parameter, all other spaces are optional. Almost all commands for the calibrator are sequential, any overlapped commands will be indicated as such. This section will briefly explain each of the commands and describe their general use, which will include any parameters that may be entered with the command as well as what the output of the command is.

### **8.5-1 Common Commands**

#### **\*CLS**

Clears the ESR, the error queue and the RQS bit. Also terminates all pending operations. When writing programs, use before each procedure to avoid buffer overflow.

### **\*ESE**

Loads a byte into the Event Status Enable register. The command is entered with a decimal number that, when converted to binary, enables the right bits in the Event Status Register. For example:

\*ESE 133

When 133 is converted to binary it is 1000101. Bits 7, 2, and 0 will be enabled.

### **\*ESE?**

Returns the contents of the Event Status Enable register. The value returned is a decimal. For example, if the register has the following settings:

1000101      than the value returned will be 133.

### **\*ESR?**

Returns the contents of the Event Status Register in decimal form. For example:

If the ESR contains 10111001, \*ESR? will return 185.

### **\*IDN?**

Returns the manufacturer, model number, and firmware revision of the Calibrator. For example:

\*IDN? will return MARTEL, MC1210, 250, 1.00

### **\*OPC**

Enables the Operation Complete setting in the ESR. This setting makes it possible to check if an operations is complete after it has been initialized.

For example this operation could be used with the command TRIG.

### **\*OPC?**

Returns 1 when all operations are complete, and causes program execution to pause until all the operations are complete. For example:

TRIG ; \*OPC? will return a 1 when the pulse train initiated by TRIG is complete.

### **\*RST**

Resets the state of calibrator to the power-up state. All subsequent commands are held off until the execution of the command is complete.

### **\*SRE**

Loads a byte into the Service Request Enable register. A decimal number must be entered, which when converted to binary, corresponds to the correct settings.

For example:

\*SRE 8 enters the binary number 00001000 to the SRE. This enables bit 3. Bit 6 is not used.



### **\*SRE?**

Returns a byte from the SRE. The byte is returned in decimal format. For example:

If 40 is returned, bits 5 and 3 are enabled.

### **\*STB**

Returns the status byte in decimal form from the Serial Poll Status Byte. For example;

If 72 is returned, bits 6 and 3 are enabled.

### **\*WAI**

Prevents further remote commands from being executed until all previous commands are executed. For example:

OUT 10 MA ; \*WAI ; OUT 5 V will output 10mA and wait until output settles, then volts command will be processed.

## **8.5-2 Calibrator Commands**

### **CAL\_START**

Puts the calibrator in calibration mode. The main display will say CALIBRATION MODE and a calibration menu will be displayed on the terminal.

### **CJC\_STATE**

Turns Cold Junction Compensation (CJC) on or off, when the calibrator is in thermocouple (TC) mode. The command is used by adding ON or OFF after it.

For example:

CJC\_STATE OFF      turns CJC off.

### **CJC\_STATE?**

Tells whether the Cold Junction Compensation in thermocouple mode is turned on or turned off. The calibrator returns OFF if CJC is off, and ON if CJC is on.

### **CPRT\_COEFA**

This command is used for entering a custom RTD into the calibrator. The numeric value entered after the command will be set as the first coefficient of the polynomial used by the custom RTD.

For example:

CPRT\_COEFA 3.908E-03      enters 3.908e-3 as coefficient A.

### **CPRT\_COEFA?**

Returns the number which was entered for the first coefficient of the polynomial used in the custom RTD. Using the example above CPRT\_COEFA? Would return:

3.908000E-03

### **CPRT\_COEFB**

This command is used for entering a custom RTD into the calibrator. The numeric value entered after the command will be set as the second coefficient of the polynomial used by the custom RTD.

For example:

CPRT\_COEFB -5.8019E-07 enters -5.8019e-7 as coefficient B.

### **CPRT\_COEFB?**

Returns the number, which was entered for the first coefficient of the polynomial used in the custom RTD. Using the example above, CPRT\_COEFB? Would return:

-5.801900E-07

### **CPRT\_COEFC**

This command is used for entering a custom RTD into the calibrator. The numeric value entered after the command will be set as the first coefficient of the polynomial used by the custom RTD.

For example:

CPRT\_COEFC -5.8019E-12 enters -5.8019e-12 as coefficient A.

### **CPRT\_COEFC?**

Returns the number which was entered for the first coefficient of the polynomial used in the custom RTD. Using the example above CPRT\_COEFC? Would return:

-5.801900E-12

### **CPRT\_MIN\_T**

Sets the minimum temperature of the custom RTD range. The temperature value must be entered with a degrees label, CEL for Celsius and FAR for Fahrenheit.

For example:

CPRT\_MIN\_T -260 CEL enters -260°C as the minimum temperature.

### **CPRT\_MIN\_T?**

Returns the value entered for minimum temperature in the range for a custom RTD. Note that the Calibrator always returns numbers in scientific notation. The above example would return:

-2.600000E+02, CEL

### **CPRT\_MAX\_T**

Sets the maximum temperature of the custom RTD range. The temperature value must be entered with a degrees label, CEL for Celsius and FAR for Fahrenheit.

For example:

CPRT\_MAX\_T 0.0 CEL enters 0.0°C as the maximum temperature.

### **CPRT\_MIN\_T?**

Returns the value entered for minimum temperature in the range for a custom RTD. The above example would return:

0.000000E+00, CEL

### **CPRT\_R0**

Sets the 0° resistance, R0, in the custom RTD. The value must be entered with a units label. Refer to the Parameter Units table for assistance.

For example:

CPRT\_R0 100 OHM sets R0 to 100 ohms.

CPRT\_R0?

Returns the value for the resistance in custom RTD. The above example would return:

1.000000E+02, OHM

### **FAULT?**

Returns the error code number of an error that has occurred. The command may be entered when the previous command did not do what it was meant to do.

For example, if a value for current output is entered that is bigger than the supported range (0-24mA) FAULT? Would return:

103 which is the code number for an entry over range.

Refer to the Error Codes table for more information on error code numbers.

### **FREQ\_LEVEL**

Sets the amplitude of the wave used in the Frequency Out and Pulse modes. The range for amplitude entered may be found in the Specifications section.

For example:

FREQ\_LEVEL 5 V sets the amplitude at 5Vpp.

### **FREQ\_LEVEL?**

Returns the amplitude of the wave used in Frequency Out and Pulse modes.

FREQ\_LEVEL? with the above example would return:

5.000000E+00, V

## **FREQ\_TYPE**

When in frequency mode, sets the calibrator to output a continuous wave (Frequency Out), or a pulse train. To set the calibrator to continuous wave enter CONT after the command. To set the calibrator to pulse enter PULSE after the command. For example:

FREQ\_TYPE CONT will set the calibrator to FREQ OUT.

**Note:** This command does not put the calibrator in frequency mode. Use the OUT command to put the calibrator in frequency mode.

## **FREQ\_TYPE?**

Tells whether calibrator is sourcing a pulse or a continuous wave. The command will return CONT if the calibrator is in FREQ OUT mode, and PULSE if the calibrator is in PULSE mode.

## **FREQ\_UNIT**

Sets the unit for frequency. There are three ranges of frequencies for frequency and pulse modes, CPM (cycles per minute), Hz, and kHz. Use this command to select the right range. For example:

FREQ\_UNIT HZ sets the frequency to Hz range

## **FREQ\_UNIT?**

Returns the frequency unit currently being used by the frequency and pulse modes.

## **FUNC?**

Returns the current mode of the upper and lower displays. For example if the calibrator is set to volts on the upper display, and pressure on the lower display, FUNC? Would return:

DCV, PRESSURE

## **LOCAL**

Restores the calibrator to local operation if it was in remote mode. Also clears LOCKOUT if the unit was in lockout mode.

## **LOWER\_MEAS**

Sets the lower display to measure mode. The command is followed by any of the parameters except for pulse and mA sim, which are source only. Enter DCI for mA, DCV for volts, TC for thermocouple, RTD for RTD, FREQUENCY for frequency, and PRESSURE for pressure. For example:

LOWER\_MEAS DCV sets the lower display mode to VOLTS IN

## **L\_PRES\_UNIT**

Sets the unit for measuring pressure on the lower display. Add the unit after the command. The available pressure units and their syntax are shown in the Table 7. (Parameter Units). For example:

L\_PRES\_UNIT KPAL sets the pressure unit to kiloPascals

## **OUT**

Sets the output of the calibrator. This command may be used to output mA, volts, frequency, temperature, and ohms. Frequency output, which is set by the command FREQ\_TYPE, is either continuous or pulse. The calibrator is automatically set to source mode when OUT is entered. A number and its unit must follow the command. See Table 7. (Parameter Units) for a list of available units. For example:

OUT 10 MA sets the calibrator to mA OUT mode and sets the output to 10mA.

## **OUT?**

Returns the output of the calibrator. Using the above example, OUT? Would return:

1.000000E-02, A

## **PRES?**

Returns the model and serial number of the attached pressure unit. Returns NONE if no pressure unit is attached. For example:

PRES? Will return MARTEL,001PNS,3,0

## **PRES\_UNIT?**

Returns the pressure units of both the upper and the lower display. For example if the unit on the upper display is bars, and on the lower it is psi, the command will return:

BAR, PSI

## **PULSE\_CNT**

Sets the number of pulses the calibrator will produce when it is triggered while in pulse mode. For example;

PULSE\_CNT 3000 will set the number of pulses to 3000.

## **PULSE\_CNT?**

Returns the number of pulses in the pulse train. Using the above example, the returned value would be:

3000

## **REMOTE**

Puts the calibrator in remote mode. From the remote mode the user can still use the keypad to get back to local unless the command LOCKOUT was entered before REMOTE. Then the keypad is totally locked out, and the user has to send the LOCAL command to get back to local operation.

## **RTD\_TYPE**

Sets the RTD type. The following is a list of RTD types they way they should be entered after the command:

PT385\_10;      PT385\_50;      PT385\_100;      PT385\_200;      PT385\_500;  
PT385\_1000;      PT392\_100;      PTJIS\_100;      Ni120;      Cu10;      Cu50;  
Cu100;      YSI\_400;      OHMS;      CUSTOM;

For example:

RTD\_TYPE PT385\_10 sets RTD type to Pt385-10

## **RTD\_TYPE?**

Returns the RTD type.

## **RTD\_WIRE**

Sets the number of wires used for connection in measuring RTDs. The calibrator measures RTDs using 2-, 3-, and 4-wire connections. After the command, enter 2W for 2- wire, 3W for 3-wire, and 4W for 4-wire. For example:

RTD\_WIRE 4W sets the connection to 4-wire

## **RTD\_WIRE?**

Returns the number of wires used in the RTD connection.

## **SIM**

Sets the output for current simulation. This command also switches the calibrator into mA simulation mode. A number and a unit must be entered after the command. For example:

SIM 5 MA sets the current simulation at 5 mA

## **SIM?**

Returns the output of the current simulation. With the example above, the output would be:

5.000000E-03, A

## **ST\_CLOSE?**

Returns the value that the switch closed at in the current units.

## **ST\_DEAD?**

Returns deadband of the switch in the current units.

## **ST\_OPEN?**

Returns the value that the switch opened at in the current units.

## **ST\_START**

Starts a switch test.

## **TC\_TYPE**

Sets the type of the thermocouple. All available types are shown in the TC Types table in Section 8. (Specifications). For example:

TC\_TYPE B sets thermocouple type to B

## **TC\_TYPE?**

Returns the type of thermocouple the calibrator is set to.

## **TEMP\_UNIT**

Sets the temperature unit for sourcing and measuring RTD and TC. Add CEL after the command for Celsius, and FAR for Fahrenheit. For example:

TEMP\_UNIT CEL sets the temperature to be measured or sourced to Celsius.

## **TEMP\_UNIT?**

Returns the temperature unit that is currently used for measuring and sourcing RTD and TC.

## **TRIG**

Starts and stops the pulse train when the calibrator is in pulse mode. The parameters of the pulse train are set by commands PULSE\_CNT, and FREQ\_LEVEL. Entering TRIG initializes the train. Entering the command while the pulse train is running stops it.

## **TRIG?**

Returns TRIGGERED if the pulse train is running, and returns UNTRIGGERED when the pulse train is not running. Returns NONE when the calibrator is not in pulse mode.

## **TSENS\_TYPE**

Sets the temperature sensor type to thermocouple, or to RTD for temperature measurement. After the command add TC for thermocouple, or RTD for RTDs. For example:

TSENS\_TYPE TC sets the sensor type to thermocouple

## **TSENS\_TYPE?**

Returns the type of sensor that is currently set to measure temperature, either TC or RTD.

## **UPPER\_MEAS**

Sets the measuring mode for the upper display. After the command enter DCI for mA, DCI\_LOOP for mA with loop power, DCV for volts, and PRESSURE for pressure. For example:

UPPER\_MEAS DCV sets the upper display to measure volts

## **U\_PRES\_UNIT**

Sets the unit for measuring pressure on the upper display. Add the unit after the command. The available pressure units and their syntax are shown in Table 7. (Parameter Units). For example:

U\_PRES\_UNIT MMHG sets the pressure unit to millimeters of mercury at 0°C

## **VAL?**

Returns the value of any measurement taking place on the upper and lower display. For example, if the upper display is measuring 5mA, and the lower display is measuring 10V, then VAL? will return:

5.000000E-03, A, 1.000000E+01, V

## **ZERO\_MEAS**

Zeroes the attached pressure module. Enter the zeroing value in PSI after the command when zeroing an absolute pressure module.

## **ZERO\_MEAS?**

Returns the zero offset or the reference value for absolute pressure modules.



## 9. Specifications

All measurements apply at  $23^{\circ}\text{C} \pm 5^{\circ}\text{C}$ . unless specified otherwise. Outside of this range the stability of the measurements is  $\pm 0.005\%$  of reading/ $^{\circ}\text{C}$ .

**Table 9: General Specifications**

Operating Temperature	-10°C to 50°
Storage Temperature	-20°C to 70°C
Power	4 X AA batteries; Alkaline or optional rechargeable
Low battery warning	Yes
Serial Communications	Yes, ASCII
CE - EMC	EN61326: 2006, ANNEX B Criterion A
Safety	CSA C22.2 No. 1010.1: 1992

**Table 10: DC Voltage Measurement/Source**

	Range	Accuracy (% of reading $\pm$ floor)
Read: Isolated(Upper Display)	0.000V- 30.000V	0.015% $\pm$ 2mV
Read: non-Isolated(Lower Display)	0.000V - 20.000V	0.015% $\pm$ 2mV
Source	0.000V - 20.000V	0.015% $\pm$ 2mV
Maximum current output in voltage ranges is 3mA with an output impedance of $\leq 1\Omega$ .		

**Table 11: DC mA Measurement/Source**

	Range	Accuracy(% of reading $\pm$ floor)
Read: Isolated(Upper Display)	0.000mA - 24.000mA	0.015% $\pm 2\mu\text{A}$
Read: non-Isolated(Lower Display)	0.000mA - 24.000mA	0.015% $\pm 2\mu\text{A}$
Source	0.000mA - 24.000mA	0.015% $\pm 2\mu\text{A}$
Maximum load on mA source is 1000 $\Omega$ . Voltage input range on simulate mode 5V - 30V.		

**Table 12: Frequency Measurement/Source**

	Range	Accuracy(% of reading $\pm$ floor)
Read	2.0CPM - 600.0CPM	0.05% $\pm$ 0.1CPM
	1.0Hz - 1000.0Hz	0.05% $\pm$ 0.1Hz
	1.00KHz - 10.00KHz	0.05% $\pm$ 0.01KHz
Source	2.0CPM - 600.0CPM	0.05%
	1.0Hz - 1000.0Hz	0.05%
	1.00KHz - 10.00KHz	0.125%

Input voltage amplitude range on frequency is 1V to 20V zero based square wave only. Output amplitude is adjustable from 1V to 20V, and is a square wave with 50% duty cycle. For output frequency, a slight negative offset of approximately -0.1V is present to assure zero crossing.

**Table 13: Resistance Measurement**

	<b>Range</b>	<b>Accuracy(% of reading ± floor)</b>
Ohms low	0.00Ω - 400.0Ω	0.025% ± 0.05Ω
Ohms high	401.0Ω - 4000.0Ω	0.025% ± 0.5Ω

**Table 14: Resistance Source**

	<b>Range</b>	<b>Excitation Current</b>	<b>Accuracy(% of reading ± floor)</b>
Ohms low	5.0Ω - 400.0Ω	0.1mA - 0.5mA	0.025% ± 0.1Ω
	5.0Ω - 400.0Ω	0.5mA - 3mA	0.025% ± 0.05Ω
Ohms high	400Ω - 1500Ω	0.05mA - 0.8mA	0.025% ± 0.5Ω
	1500Ω - 4000Ω	0.05mA - 0.4mA	0.025% ± 0.5Ω

Note: Unit is compatible with smart transmitters and PLCs. Frequency response is <= 5ms.

**Table 15: Thermocouple Measurement/Source**

	<b>Range</b>	<b>Accuracy(% of reading ± floor)</b>
Read (mV)	-10.000mV - 75.000mV	0.02% ± 10μV
Source (mV)	-10.000mV - 75.000mV	0.02% ± 10μV

Maximum current output in voltage ranges is 1mA with an output impedance of <= 1Ω

**Table 16: Thermocouple Read and Source (errors in °C)**

<b>TC Type</b>	<b>Range (°C)</b>	<b>Accuracy</b>
J	-210.0 - 0.0	0.4
	0.0 - 800.0	0.2
	800.0 - 1200.0	0.3
K	-200.0 - 0.0	0.6
	0.0 - 1000.0	0.3
	1000.0 - 1372.0	0.5
T	-250.0 - 0.0	0.6
	0.0 - 400.0	0.2
E	-250.0 - -100.0	0.6
	-100.0 - 1000.0	0.2
R	-20.0 - 1767.0	1.2
S	-20.0 - 1767.0	1.2
B	600.0 - 800.0	1.2
	800.0 - 1000.0	1.3
	1000.0 - 1820.0	1.5
C	0.0 - 1000.0	0.6
	1000.0 - 2316.0	2.3
XK	-200.0 - 800.0	0.2
BP	0.0 - 800.0	0.9
	800.0 - 2500.0	2.3
L	-200.0 - 0.0	0.25
	0.0 - 900.0	0.2

<b>TC type</b>	<b>Range (°C)</b>	<b>Accuracy</b>
U	-200.0 - 0.0	0.5
	0.0 - 600.0	0.25
N	-200.0 - 0.0	0.8
	0.0 - 1300.0	0.4

All TC errors include CJC errors  
CJC error outside of  $23 \pm 5^{\circ}\text{C}$  is  $0.05^{\circ}\text{C}/^{\circ}\text{C}$   
(In  $^{\circ}\text{C}$  add .2 for cold junction compensation error.)

**Table 17: RTD Read and Source**

<b>RTD Type</b>	<b>Range (°C)</b>	<b>Accuracy</b>
Ni120 (672)	-80.0 - 260.0	0.2
Cu10	-100.0 - 260.0	1.4
Cu50	-180.0 - 200.0	0.4
Cu100	-180.0 - 200.0	0.3
YSI400	15.00 - 50.00	0.1
Pt100 (385)	-200.0 - 100.0	0.2
	100.0 - 300.0	0.3
	300.0 - 600.0	0.4
	600.0 - 800.0	0.5
Pt200 (385)	-200.0 - 100.0	0.8
	100.0 - 300.0	0.9
	300.0 - 630.0	1.0
Pt500 (385)	-200.0 - 100.0	0.4
	100.0 - 300.0	0.5
	300.0 - 630.0	0.6
Pt1000 (385)	-200.0 - 100.0	0.2
	100.0 - 300.0	0.3
	300.0 - 630.0	0.4
Pt385-10	-200.0 - 100.0	1.4
	100.0 - 300.0	1.6
	300.0 - 600.0	1.8
	600.0 - 800.0	2.0
Pt385-50	-200.0 - 100.0	0.4
	100.0 - 300.0	0.5
	300.0 - 600.0	0.6
	600.0 - 800.0	0.7
Pt100 (3926)	-200.0 - 100.0	0.2
	100.0 - 300.0	0.3
	300.0 - 630.0	0.4
Pt100 (3916)	-200.0 - 100.0	0.2
	100.0 - 300.0	0.3
	300.0 - 630.0	0.4

Read Accuracy is based on 4-wire input. For 3-wire input add  $\pm 0.05\Omega$  assuming all three RTD leads are matched.

## 10. Maintenance / Warranty

### 10.1 Replacing Batteries

Replace batteries as soon as the battery indicator turns on to avoid false measurements. If the batteries discharge too deeply the MC1210 will automatically shut down to avoid battery leakage.

**Note:** Use only AA size alkaline batteries or optional rechargeable battery pack.

### 10.2 Cleaning the Unit

#### **Warning**

To avoid personal injury or damage to the calibrator, use only the specified replacement parts and do not allow water into the case.

#### **Caution**

To avoid damaging the plastic lens and case, do not use solvents or abrasive cleansers. Clean the calibrator with a soft cloth dampened with water or water and mild soap.

### 10.3 Service Center Calibration or Repair

Only qualified service personnel should perform calibration, repairs, or servicing not covered in this manual. If the calibrator fails, check the batteries first, and replace them if needed.

Verify that the calibrator is being operated as explained in this manual. If the calibrator is faulty, send a description of the failure with the calibrator. Be sure to pack the calibrator securely, using the original shipping container if it is available. To return the product to Martel go to [www.martelcalibrators.com](http://www.martelcalibrators.com) and click on the Customer Service link. Download the RMA form and follow the instructions. Calibration procedures and other related documents can also be found on the website.

### 10.4 Replacement Parts & Accessories

BPPA-100	BETA Pressure Module Adapter
80029	JKTE T/C Wire Kit, Mini Plugs
80036	RSNB T/C Wire Kit, Mini Plugs
CC572	Carrying Case
C232SJ	RS232 Cable with Miniature Plug
1919896	USB/RS232 Converter Cable with Miniature Plug
5353050	48" Stackable Testleads
1001-9V	Battery Adapter/Charger

### 10.5 Warranty

Martel Electronics Corporation warrants all products against material defects and workmanship for a period of twelve (12) months after the date of shipment. Problems or defects that arise from misuse or abuse of the instrument are not covered. If any product is to be returned, a "Return Material Authorization" number must be obtained from our Customer Service Department. This number must be indicated on the return package as notice to our Receiving Department to accept the shipment. Any package not so marked will not be accepted and will be returned to the shipper. Martel will not be responsible for damage as a result of poor return packaging. Out of warranty repairs and recalibration will be subject to

specific charges. Under no circumstances will Martel Electronics be liable for any device or circumstance beyond the value of the product.



[www.martelcorp.com](http://www.martelcorp.com)

e-mail: [sales@martelcorp.com](mailto:sales@martelcorp.com)

Tel: (603) 434-1433 800-821-0023

Fax: (603) 434-1653

**Martel Electronics**

3 Corporate Park Dr.

Derry, NH 03038