



UFC 400 Supplementary instructions

Signal converter for ultrasonic flowmeters

Description of Modbus interface

Electronic Revision: ER 2.2.0_

Modbus version: 2.1.0_

1	General information	4
<hr/>		
1.1	Scope of the document	4
1.2	Scope of delivery	4
1.3	Modbus protocol interface	4
2	Technical data	5
<hr/>		
2.1	General technical data	5
2.2	Technical data of the Modbus interface (acc. to EIA/TIA standards)	5
3	Electrical connections	6
<hr/>		
3.1	Modbus connection	6
3.2	Connection to Modbus bus	6
4	Establish RS485 connection	7
<hr/>		
5	Modbus protocol	8
<hr/>		
5.1	RTU frame format	8
5.2	Data representation	9
5.2.1	8-bit values	9
5.2.2	16-bit values	9
5.2.3	32-bit values	9
5.2.4	64-bit values	10
5.3	Modbus Register Addresses	11
5.4	Supported Function Codes	11
5.5	Error messages	11
5.6	Device identification	12
5.7	Diagnostics	13
5.8	Parameters	13
5.8.1	Device Control	14
5.8.2	Device Status	14
5.8.3	Measurement values	15
5.8.4	Measurement Status compliant with NAMUR NE 107	15
5.8.5	Auxiliary Values	16
5.8.6	Totaliser	17
5.8.7	Zero Calibration	19
5.8.8	Process Input Parameters	20
5.8.9	Modbus RS485 Communication Settings	21
5.8.10	NAMUR NE 107 Variable Event Group(s)	22
6	Application sequences	23
<hr/>		
6.1	Saving and restoring the configuration setting	23
6.2	Zero Calibration	24

7 Troubleshooting	25
7.1 No response to Modbus requests	25
7.2 Communication errors	25
7.3 Responding with exception "Illegal Function"	25
7.4 Responding with exception "Illegal Data Address"	26
7.5 Responding with exception "Illegal Data Value"	26
8 Appendix	27
8.1 NAMUR NE 107 Event Group(s)	27
8.2 NAMUR NE 107 status signals	28
8.3 Supported Modbus function codes	28
8.4 Number format	31
8.5 Glossary	31

1.1 Scope of the document

These instructions are supplementary to the signal converter handbook. For all other data, use the relevant chapters of the handbook. If you do not have this document, please contact the nearest office or download them from the manufacturer's internet site.

1.2 Scope of delivery

The information in this supplementary manual only contains the data applicable to MODBUS communication.

The technical data in the handbook shall be valid in its current version, provided that it is not rendered invalid or replaced by this supplement.

1.3 Modbus protocol interface

The Modbus interface to the signal converter is implemented in the Modbus RTU communications protocol and is done in accordance with the specification and requirements of the "Modbus Protocol Specification V1.1b".

The physical electrical parameters of the Modbus specification are defined by the EIA/TIA-485 (RS485) standard and the "Modbus over Serial Line - Specification and Implementation Guide V1.02".

Both specifications can be obtained on the official website of the Modbus organisation:
<http://www.modbus.org>

2.1 General technical data

Interface	RS485, galvanically isolated
Baud rate	1200, 2400, 3600, 4800, 9600, 19200, 38400, 57600 or 115200 bps
Protocol	Modbus RTU (available as a separate document on request)
Maximum participants on bus	32 per line, master included (may be extended by repeaters)
Coding	NRZ bit coding
Address range	1...247
Transmission procedure	Half duplex, asynchronous
Bus access	Master / slave
Cable	Screened twisted pair
Distances	Maximum 1.2 km / 3937 ft without repeater (dependant on baud rate and cable specifications)

2.2 Technical data of the Modbus interface (acc. to EIA/TIA standards)

Kind of signal transmission	Differential, 2-wire topology
Maximum number of transmitter/receivers	32
Voltage range on converter input	-7...+12 V
Maximum voltage on converter output	5 V
Minimum voltage on driver output, max. load	$U_{diff} > 1.5 \text{ V}$
Maximum input current (off state)	-20...+20 μA
Receiver input voltage	-7...+12 V
Sensitivity of the receiver	-200...+200 mV
Receiver input resistance	> 12 k Ω
Short circuit current	< 250 mA
Termination / polarization resistors (if activated by factory)	120 Ω / 560 Ω

3.1 Modbus connection

The signal converter is hooked up onto the bus using terminals C and D:

Terminals	Description
D-	Signal A (D 0)
D	Signal B (D 1)
C-	Common 0 V
C	Not connected

Terminals A and B of the signal converter are dependant on the options selected at order. Refer to the standard handbook of the signal converter for connection details.

3.2 Connection to Modbus bus

The signal converter is designed to be connected as a slave device onto the 2-wire bus implementation of the Modbus serial physical layer definition.

In addition to the D0 and D1 signal lines the bus **MUST** include a "Common" signal line to act as a ground reference point for the data signals.

For proper operation of Modbus in half duplex mode in single or multi-drop communication, it is recommended that a termination resistor is applied to both ends of the data line. The simplest form of termination is line-to-line resistor across the differential input.

In RTU mode the Modbus protocol requires quiet periods on the communications bus for synchronisation. It is therefore important that the Modbus is not allowed to "float", i.e. unreferenced to 0 V, as this could lead to spurious signals due to noise pick-up. It is therefore necessary to employ biasing resistors at one point on the bus network.

To establish a RS485 connection with the signal converter, prepare the master device with the appropriate default settings or use custom parameters specified via display of the signal converter.

The Modbus RS485 settings can be found in the menu C5.8 of the display. The following parameters can be configured:

Parameter	Legal values	Default values	Display Fct. No.
Slave address	1...247	1	C5.8.1
"Baud rate"	1200, 2400, 3600, 4800, 9600, 19200, 38400, 57600, 115200 bps	19200 bps	C5.8.2
Parity	Even, Odd, No	Even Parity	C5.8.3
Data format	Big Endian, Little Endian	Big Endian	C5.8.4
Transmission delay	0...0.04 [s]	0 s	C5.8.5
Stop Bits	1 Stop Bit, 2 Stop Bits	1 Stop Bit	C5.8.6

These settings can be changed via Modbus too. For further information refer to *Modbus RS485 Communication Settings* on page 21.

All devices connected to the bus, must have the same baud rate.



INFORMATION!

It is of great importance to ensure at the time of the procedure of devices addressing, that there are not two devices with the same address. In such a case, an abnormal behaviour of the whole serial bus can occur. It is then impossible for the master to communicate with all present slaves on the bus.

5.1 RTU frame format

Using RTU (Remote Terminal Unit) format, data is transmitted as 8 bit binary characters. There are no special characters to determine the start and end of a message frame. Synchronization is achieved by a minimum silent period of at least 3.5 character times before the start of each frame transmission and a maximum silent period of 1.5 character times between characters in the same frame.

The format of the query and response frames vary slightly depending upon the function code. The basic form is outlined below.

Command function	Frame format	Description
Silent period	3.5 x T	All transmissions must be preceded by a minimum silent period of 3.5 x T, where T is the transmission time of a single character. This can be calculated from the baud rate, e.g. T = 572 µs at 19.2 kbps.
Slave address	8 bits	This is a single byte slave address which is transmitted first and must be in the range of 1...247. Address 0 is reserved for a broadcast address which all slaves should recognise, and therefore requires no response.
Function code	8 bits	This is an eight bit code in the range of 1...255 although only 126 functions exist as the codes 129...255 represent an error condition. An error condition occurs when the addressed slave does not accept the command, in which case it responds with the function code + 128, i.e. with its msb set to 1.
Register start address or byte count when required	8 bit byte count 16 bit address	<p>Register start address: for a query command that requires data to be returned, this field will contain the 16 bit start address of the register (or data) to be returned. Note that the signal converter uses protocol addresses. Therefore the register address listed is the actual number required in the Modbus command.</p> <p>E.g.: to access input register 30006, the register start address is 30006 = 0x7536.</p> <p>Byte count: In general this is only present in frames that are transferring data, and has a value equal to the number of bytes contained in the data field. The data field is limited to a maximum of 250 bytes.</p>
Number of points or data bytes when required	n x 8 bits	<p>Number of points: for a query command that requires data to be returned, this field will contain the number of registers to be returned regardless of their bit size.</p> <p>Data bytes: contains the data requested. The signal converter can use Big Endian format (MSB first) or Little Endian format (LSB first).</p>
CRC	16 bits	This field contains a 16 bit CRC which is calculated on all the data bits of the message bytes.

5.2 Data representation

There are two data types used to transmit information on a Modbus data bus, the "Bit" and the "Register". The "Bit" represents a single binary state, whether as an output or an input condition. The "Register" is a 16-bit integer transmitted as two 8-bit characters. Using multiple "Registers" the Modbus interface can transmit higher accuracy values such as "Floating Point" and "Double Precision Floating Point" numbers.

"Bit" variables are packed into a byte containing 8 bit, so each character, sent or received, can contain up to 8 "Bit" variables. The master and slave devices use only as many 8 bit data characters as are required to transmit the information. Any unused bits in the data characters are ignored. The bit that is requested by the start address is transmitted in the LSB at bit 0. The next "Bit" value is transmitted in the next bit (bit 1). This continues until the last bit location (bit 7) of the LSB is reached. The next "Bit" value is then transmitted in the next data byte (LSB+1/MSB) at bit 0. This continues until all of the requested values have been transmitted. Any unused bits in the MSB are filled out with "0"s.

For simple single register variables the MSB of the register is transmitted first, with the LSB following immediately after. However, for variables that require multiple registers, i.e. the "Floating Point" and "Double Precision Floating Point" variables, the transmission order can be selected in the RS485 settings. By default, those values will be transmitted in Big Endian.

5.2.1 8-bit values

Register	Hi	Lo
N	0x00	Byte

5.2.2 16-bit values

Register	Hi	Lo
N	MSB	LSB

5.2.3 32-bit values

Little Endian		
Register	Hi	Lo
N	LSB + 1	LSB
N + 1	MSB	LSB + 2

Big Endian		
Register	Hi	Lo
N	MSB	LSB + 2
N + 1	LSB + 1	LSB

Float (single precision, IEEE 754)			
MSB	LSB + 1	LSB + 1	LSB
SEEEEEEE	EMMMMMMM	MMMMMMMM	MMMMMMMM

With S = sign, E = exponent, M = mantissa/fraction

5.2.4 64-bit values

Little Endian		
Register	Hi	Lo
N	LSB + 1	LSB
N + 1	LSB + 3	LSB + 2
N + 2	LSB + 5	LSB + 4
N + 3	MSB	LSB + 6

Big Endian		
Register	Hi	Lo
N	MSB	LSB + 6
N + 1	LSB + 5	LSB + 4
N + 2	LSB + 3	LSB + 2
N + 3	LSB + 1	LSB

Double (double precision, IEEE 754)			
MSB	LSB + 6	LSB + 5	LSB + 4
SEEEEEEE	EEEEMMMM	MMMMMMMM	MMMMMMMM
LSB + 3	LSB + 2	LSB + 1	LSB
MMMMMMMM	MMMMMMMM	MMMMMMMM	MMMMMMMM

With S = sign, E = exponent, M = mantissa/fraction

5.3 Modbus Register Addresses

The signal converter supports four types of data references, which are associated to a range of Modbus registers.

Address range	Primary tables	Access rights
0...9999	Coils	read + write
10000...19999	Discrete Inputs	read
20000...39999	Input Registers	read
40000...65535	Holding Registers	read + write



INFORMATION!

- Sometimes register numbers are asked for. The register numbers can be calculated by adding a 1 to the register address.
- Some systems cannot use addresses above 9999. For these systems there is the possibility to use the listed addresses but
 - for Input Registers omit the leading 3 of 3xxxx;
 - for Holding Registers omit the leading 4 of 4xxxx.

5.4 Supported Function Codes

Function code		Name
dec	hex	
01	01	Read Single Coil
02	02	Read Discrete Inputs
03	03	Read Holding Register
04	04	Read Input Register
05	05	Write Single Coil
08	08	Diagnostics
16	10	Write Multiple Register
43	2B	Encapsulated Interface Transport

For detailed information about the telegrams structure of all function codes refer to *Supported Modbus function codes* on page 28.

5.5 Error messages

When the signal converter detects an error in the requests, received in a properly formatted telegram, it will respond with an error message. The error message response telegram is formatted as follows:

Address	Function Code	Error Code	CRC Lo	CRC Hi
---------	---------------	------------	--------	--------

The msb (most significant bit) of the requested function code is set (add 0d128 / 0x80) in the response telegram to indicate an error has been detected. For example, if an error were detected in a function 1 request, then the returned function code would be 0x81 (0d129).

The single data character in the response telegram will indicate the type of error detected. These are as follows:

Error Code	Name	Meaning
01	ILLEGAL FUNCTION	The requested function code is not supported or not valid due to the current settings of the device.
02	ILLEGAL DATA ADDRESS	The register requested is not valid or the quantity of requested registers hits invalid registers.
03	ILLEGAL DATA VALUE	The requested data is invalid for the register being written.
04	SLAVE DEVICE FAILURE	An unrecoverable error occurred while the slave was attempting to perform the requested action.
06	SLAVE DEVICE BUSY	The slave is unable to process the requested command because a long-duration command is in progress. The master should retransmit the message later.

Errors due to communications faults (CRC errors, Parity errors etc.) are logged but no response is returned because the data in the received telegram is deemed unreliable. The master system can read the error logs by using the diagnostics command (for details on Function Code 0x08 refer to *Diagnostics* on page 13).

5.6 Device identification

Retrieve all of the identification information from the signal converter.

Modbus Function Code "Encapsulated Interface Transport" (0x2B).

Modbus Encapsulated Interface (MEI) type (0x0E).

Category	Object Id	Object name	Type	Content
Basic	0x00	VendorName	16 byte ASCII String	KROHNE
	0x01	ProductCode	10 byte ASCII String	CG number; order code for the signal converter assembly
	0x02	MajorMinorRevision	7 byte ASCII String	Electronic Revision number
Regular	0x03	Vendor URL	32 byte ASCII String	www.krohne.com
	0x04	ProductName	16 byte ASCII String	UFC400
	0x05	ModelName	16 byte ASCII String	Modbus
	0x06	UserApplicationName	16 byte ASCII String	User tag, displayed on the header of the local screen

5.7 Diagnostics

This command function permits the user to perform one of several diagnostics operations, such as retrieving the error and event logs. For further details on this command function, refer to the Modbus Application Protocol Specification V1.1b.

Modbus Function Code "Diagnostics" (0x08)

Sub function code		Name
dec	hex	
00	00	Return Query Data
01	01	Restart Communication Option
04	04	Force Listen Only Mode
10	0A	Clear Counters
11	0B	Return Bus Message Count
12	0C	Return Bus Communication Error Count
13	0D	Return Bus Exception Count
14	0E	Return Slave Message Count
15	0F	Return Slave No Response Count
18	12	Return Bus Character Overrun Count

5.8 Parameters

The functions of the Modbus interface are arranged in groups of thematically coherent parameters.

Large gaps have been left between these groups of data types in order to permit expansion of the signal converter interface and compatibility with further high performance signal converters.

The configuration of the signal converter can be changed via Modbus Holding Registers. Writing data to those registers does not take effect immediately. In order to apply the new configuration it is necessary to perform "Apply Changes". Parameters that require "Apply Changes" are indicated by the  symbol. Changes that are not applied can be discarded via "Discard Changes" (details on page 14). For further information refer to *Application sequences* on page 23.

5.8.1 Device Control

The "Device Control" offers some basic functionality to operate with the signal converter. Therefore, the Modbus interface provides five coils that can be accessed via Modbus Function Code "Write Single Coil" (0x05).

Write a coil to **value 1** (ON) to initiate the action.

Modbus Function Code "Write Single Coil" (0x05)			
Coil Address	Name	Description	Display Fct. No.
1000 (0x03E8)	Restart Device	Restart entire signal converter	D4.1
1001 (0x03E9)	Reset Errors	Clears the system error flags	A3.1
1002 (0x03EA)	Apply Changes	Apply latest changes of configuration	-
1003 (0x03EB)	Discard Changes	Discard all of the configuration changes made since the last "Apply Changes"	-
1004 (0x03EC)	Reset to Factory Data	Resets the signal converter to factory configuration	C5.6.3

5.8.2 Device Status

Modbus Function Codes "Read Discrete Inputs" (0x02)					
Discrete Inputs	Name	Description	Type	No. of registers	Values
10001 (0x2711)	Unsaved changes pending	Indicates if there are unsaved changes. "Apply Changes" to save them, "Discard Changes" to work with previous settings	Bit	1	0 = no changes made 1 = unsaved changes detected

Modbus Function Codes "Read Input Registers" (0x04)					
Input Register	Name	Type	No. of registers	Values / Units	Display Fct. No.
39002 (0x985A)	Device Operation Time	Float	2	[s]	B2.8
39004 (0x985C)	NE 107 Status Groups	Long	2	For further information refer to <i>NAMUR NE 107 Event Group(s)</i> on page 27.	-
39100 (0x98BC)	NE 107 Device Status	Byte	1	Bit 7 = Failure (F) Bit 6 = reserved Bit 5 = Out of Specification (S) Bit 4 = Function Check (C) Bit 3 = reserved Bit 2 = Maintenance required (M) Bit 1 = reserved Bit 0 = Information (I)	-

5.8.3 Measurement values

Modbus Function Codes "Read Input Registers" (0x04)				
Input Register	Name	Type	No. of registers	Units
30000 (0x7530)	Flow Velocity	Float	2	[m/s]
30002 (0x7532)	Volume Flow	Float	2	[m ³ /s]
30004 (0x7534)	Mass Flow	Float	2	[kg/s]
30006 (0x7536)	Velocity Of Sound	Float	2	[m/s]
30008 (0x7538)	Gain	Float	2	[dB]
30010 (0x753A)	Signal Noise Ratio (SNR)	Float	2	[dB]
30012 (0x753C)	Diagnosis 1	Float	2	[m/s]
30014 (0x753E)	Diagnosis 2	Float	2	[dB]

5.8.4 Measurement Status compliant with NAMUR NE 107

Modbus Function Codes "Read Input Registers" (0x04)				
Input Register	Name	Type	No. of registers	Values
30500 (0x7724)	NE 107 Status of Flow Velocity	Byte	1	Bit 7 = Failure (F) Bit 6 = reserved Bit 5 = Out of Specification (S) Bit 4 = Function Check (C) Bit 3 = Initial Value Bit 2 = Maintenance required (M) Bit 1 = Value is too large and limited Bit 0 = Value is too small and limited If none of these bits is set, there is no status message.
30501 (0x7725)	NE 107 Status of Volume Flow	Byte	1	
30502 (0x7726)	NE 107 Status of Mass Flow	Byte	1	
30503 (0x7727)	NE 107 Status of Velocity Of Sound	Byte	1	
30504 (0x7728)	NE 107 Status of Gain Ratio	Byte	1	
30505 (0x7729)	NE 107 Status of Signal Noise Ratio	Byte	1	
30506 (0x772A)	NE 107 Status of Diagnosis 1	Byte	1	
30507 (0x772B)	NE 107 Status of Diagnosis 2	Byte	1	

5.8.5 Auxiliary Values

Modbus Function Codes "Read Input Registers" (0x04)					
Input Register	Name	Type	No. of registers	Units	Display Fct. No.
31000 (0x7918)	Velocity Of Sound – Path 1	Float	2	[m/s]	B2.3.1
31002 (0x791A)	Velocity Of Sound – Path 2	Float	2	[m/s]	B2.3.2
31004 (0x791C)	Velocity Of Sound – Path 3	Float	2	[m/s]	B2.3.3
31006 (0x791E)	Flow Speed – Path 1	Float	2	[m/s]	B2.4.1
31008 (0x7920)	Flow Speed – Path 2	Float	2	[m/s]	B2.4.2
31010 (0x7922)	Flow Speed – Path 3	Float	2	[m/s]	B2.4.3
31012 (0x7924)	Gain – Path 1	Float	2	[dB]	B2.5.1
31014 (0x7926)	Gain – Path 2	Float	2	[dB]	B2.5.2
31016 (0x7928)	Gain – Path 3	Float	2	[dB]	B2.5.3
31018 (0x792A)	SNR – Path 1	Float	2	[dB]	B2.6.1
31020 (0x792C)	SNR – Path 2	Float	2	[dB]	B2.6.2
31022 (0x792E)	SNR – Path 3	Float	2	[dB]	B2.6.3
31024 (0x7930)	Reynolds Number	Float	2	-	-
31026 (0x7932)	Reynolds Correction	Float	2	-	-



5.8.6 Totaliser

Modbus Function Codes "Read Coils" (0x01) and "Write Single Coil" (0x05)					
Coil Address	Name	Function	Action	Values	Display Fct. No.
3000 (0x0BB8)	Totaliser 1	Start / Stop	Write	0 = stop totaliser 1 = start totaliser	C3.1.8 / C3.1.9
		Status	Read	0 = totaliser stopped 1 = totaliser running	-
3001 (0x0BB9)	Totaliser 2	Start / Stop	Write	0 = stop totaliser 1 = start totaliser	C3.2.8 / C3.2.9
		Status	Read	0 = totaliser stopped 1 = totaliser running	-
3002 (0x0BBA)	Totaliser 3 ①	Start / Stop	Write	0 = stop totaliser 1 = start totaliser	C3.3.8 / C3.3.9
		Status	Read	0 = totaliser stopped 1 = totaliser running	-
3003 (0x0BBB)	Totaliser 1 Reset	set totaliser value to zero	Write	1 = reset totaliser	C3.1.6
3004 (0x0BBC)	Totaliser 2 Reset	set totaliser value to zero	Write	1 = reset totaliser	C3.2.6
3005 (0x0BBD)	Totaliser 3 Reset ①	set totaliser value to zero	Write	1 = reset totaliser	C3.3.6



① Only available in signal converters with "modular carrier"

Modbus Function Code "Read Input Registers" (0x04)				
Input Register	Name	Type	No. of registers	Units
32000 (0x7D00)	Totaliser 1 value (double precision)	Double	4	[m³] or [kg]
32004 (0x7D04)	Totaliser 2 value (double precision)	Double	4	
32008 (0x7D08)	Totaliser 3 value (double precision) ①	Double	4	
32100 (0x7D64)	Totaliser 1 value (single precision)	Float	2	
32102 (0x7D66)	Totaliser 2 value (single precision)	Float	2	
32104 (0x7D68)	Totaliser 3 value (single precision) ①	Float	2	

① Only available in signal converters with "modular carrier"

Modbus Function Codes "Read Holding Registers" (0x03) and "Write Multiple Registers" (0x10)						
Holding Register	Name	Action	Type	No. of registers	Values	Display Fct. No.
40000 (0x9C40)	Totaliser 1 	Function	Byte	1	0 = Off 1 = Absolute total 2 = Increment 3 = Decrement	C3.1.1
40001 (0x9C41)		Measurement	Byte	1	0 = Volume Flow 2 = Mass Flow	C3.1.2
40002 (0x9C42)	Totaliser 2 	Function	Byte	1	0 = Off 1 = Absolute total 2 = Increment 3 = Decrement	C3.2.1
40003 (0x9C43)		Measurement	Byte	1	0 = Volume Flow 2 = Mass Flow	C3.2.2
40004 (0x9C44)	Totaliser 3  ①	Function	Byte	1	0 = Off 1 = Absolute total 2 = Increment 3 = Decrement	C3.3.1
40005 (0x9C45)		Measurement	Byte	1	0 = Volume Flow 2 = Mass Flow	C3.3.2

① Only available in signal converters with "modular carrier"

Modbus Function Codes "Read Holding Registers" (0x03) and "Write Multiple Registers" (0x10)						
Holding Register	Name	Action	Type	No. of registers	Units	Display Fct. No.
40500 (0x9E34)	Totaliser 1 	Low Flow Cut-Off Value	Float	2	[m³/s] or [kg/s]	C3.1.3
40502 (0x9E36)		Time Constant			0...100 [s]	C3.1.4
40504 (0x9E38)		Set or Read Value			[m³] or [kg]	C3.1.7
40506 (0x9E3A)		Preset			[m³] or [kg]	C3.1.5
40508 (0x9E3C)	Totaliser 2 	Low Flow Cut-Off Value	Float	2	[m³/s] or [kg/s]	C3.2.3
40510 (0x9E3E)		Time Constant			0...100 [s]	C3.2.4
40512 (0x9E40)		Set or Read Value			[m³] or [kg]	C3.2.7
40514 (0x9E42)		Preset			[m³] or [kg]	C3.2.5
40516 (0x9E44)	Totaliser 3  ①	Low Flow Cut-Off Value	Float	2	[m³/s] or [kg/s]	C3.3.3
40518 (0x9E46)		Time Constant			0...100 [s]	C3.3.4
40520 (0x9E48)		Set or Read Value			[m³] or [kg]	C3.3.7
40522 (0x9E4A)		Preset			[m³] or [kg]	C3.3.5

① Only available in signal converters with "modular carrier"

5.8.7 Zero Calibration

















A zero calibration is not necessary for normal operation. It's recommended that only trained service engineers should perform a zero calibration.

The Coils and Registers below are required to perform a zero calibration. For further information refer to *Zero Calibration* on page 24.







Modbus Function Codes "Read Coils" (0x01) and "Write Single Coil" (0x05)					
Coil Address	Name	Function	Action	Values	Display Fct. No.
2000 (0x07D0)	Zero Calibration Control	Start	Write	1 = start zero calibration	C1.2.1
		Status	Read	0 = zero calibration not running / complete 1 = zero calibration in progress	-

Modbus Function Code "Read Input Registers" (0x04)					
Input Register	Name	Type	No. of registers	Values	
20000 (0x4E20)	Zero Calibration Result	Byte	1	1 = OK 0 = NOK	

5.8.8 Process Input Parameters

Modbus Function Codes "Read Holding Registers" (0x03) and "Write Multiple Registers" (0x10)					
Holding Register	Name	Type	No. of registers	Units	Display Fct. No.
41000 (0xA028)	Flow Direction 	Byte	1	0 = Normal 1 = Reverse	C1.3.2
41001 (0xA029)	Linearization 	Byte	1	0 = Off 1 = On	C1.7.1
41002 (0xA02A)	Diagnostics 1 Selector 	Integer	1	0 = Off 415 = Velocity Of Sound – Path 1 416 = Velocity Of Sound – Path 2 417 = Velocity Of Sound – Path 3 421 = Flow Speed – Path 1 422 = Flow Speed – Path 2 423 = Flow Speed – Path 3	C1.10.1
41003 (0xA02B)	Diagnostics 2 Selector 	Integer	1	0 = Off 402 = Gain – Path 1 403 = Gain – Path 2 404 = Gain – Path 3 409 = Signal Noise Ratio – Path 1 410 = Signal Noise Ratio – Path 2 411 = Signal Noise Ratio – Path 3	C1.10.2
41004 (0xA02C)	Plausibility Counter Decrease 	Integer	1	1...99	C1.4.2
41005 (0xA02D)	Plausibility Counter Limit 	Integer	1	0...999	C1.4.3
41502 (0xA21E)	GK 	Float	2	-	C1.2.2
41504 (0xA220)	Limitation Min 	Float	2	[m/s]	C1.3.1
41506 (0xA222)	Limitation Max 	Float	2	[m/s]	C1.3.1
41508 (0xA224)	Time Constant 	Float	2	[s]	C1.3.3
41510 (0xA226)	Low Flow Cutoff Threshold 	Float	2	[m/s]	C1.3.4
41512 (0xA228)	Low Flow Cutoff Hysteresis 	Float	2	[m/s]	C1.3.4
41514 (0xA22A)	Plausibility Error Limit 	Float	2	[%]	C1.4.1
41516 (0xA22C)	Dynamic Viscosity 	Float	2	[kg/ms]	C1.7.2
41518 (0xA22E)	Pipe Temperature 	Float	2	[K]	C1.8
41520 (0xA230)	Density 	Float	2	[kg/m ³]	C1.9







5.8.9 Modbus RS485 Communication Settings

Modbus Function Codes "Read Holding Registers" (0x03) and "Write Multiple Registers" (0x10)						
Holding Register	Name	Description	Type	No. of registers	Values	Display Fct. No.
50000 (0xC350)	Baud rate 	Baud rate for the RS485 Modbus Communication in [bps]	Long	2	1200, 2400, 3600, 4800, 9600, 19200 (default), 38400, 57600, 115200	C5.8.2
50002 (0xC352)	Transmission Delay 	Select transmission delay between Modbus request and Modbus response in [ms]	Float	2	0 (default)...0.04	C5.8.5
50004 (0xC354)	Slave Address 	Modbus Slave Address	Byte	1	1 (default)...247	C5.8.1
50005 (0xC355)	Parity 	Parity for the RS485 Modbus Communication	Byte	1	0 = Even (default) 1 = Odd 3 = Off	C5.8.3
50006 (0xC356)	Register Format 	Switch Register Format Little Endian or Big Endian	Byte	1	0 = Little Endian 1 = Big Endian (default)	C5.8.4
50007 (0xC357)	Stop Bits 	Number of Stop Bits	Byte	1	1 = 1 Stop Bit (default) 2 = 2 Stop Bits	C5.8.6

5.8.10 NAMUR NE 107 Variable Event Group(s)

The following eight event groups can be mapped to any status signal.

For further information refer to the signal converter standard manual.

Modbus Function Codes "Read Holding Registers" (0x03) and "Write Multiple Registers" (0x10)						
Holding Register	Description	Status Group	Type	No. of registers	Default Value	Display Fct. No.
52017 (0xCB31)	Status Signal of Event Group 14 	Electr: IO Connection	Byte	1	32 Out Of Specification (S)	C1.10.7
52018 (0xCB32)	Status Signal of Event Group 13 	Proc: Empty Pipe	Byte	1	32 Out Of Specification (S)	C1.10.3
52019 (0xCB33)	Status Signal of Event Group 12 	Proc: Signal Lost	Byte	1	32 Out Of Specification (S)	C1.10.4
52020 (0xCB34)	Status Signal of Event Group 11 	Proc: Signal Unreliable	Byte	1	32 Out Of Specification (S)	C1.10.5
52021 (0xCB35)	Status Signal of Event Group 10 	Config: Totaliser	Byte	1	32 Out Of Specification (S)	C1.10.6
52022 (0xCB36)	Status Signal of Event Group 9 	reserved	Byte	1	0	-
52023 (0xCB37)	Status Signal of Event Group 8 	Electr: Power Failure	Byte	1	1 Information (S)	C1.10.8

Legal values for those registers:

- 128: Failure (F)
- 32: Out Of Specification (S)
- 16: Function Check (C)
- 4: Maintenance Request (M)
- 1: Information (I)
- 0: Off

6.1 Saving and restoring the configuration setting

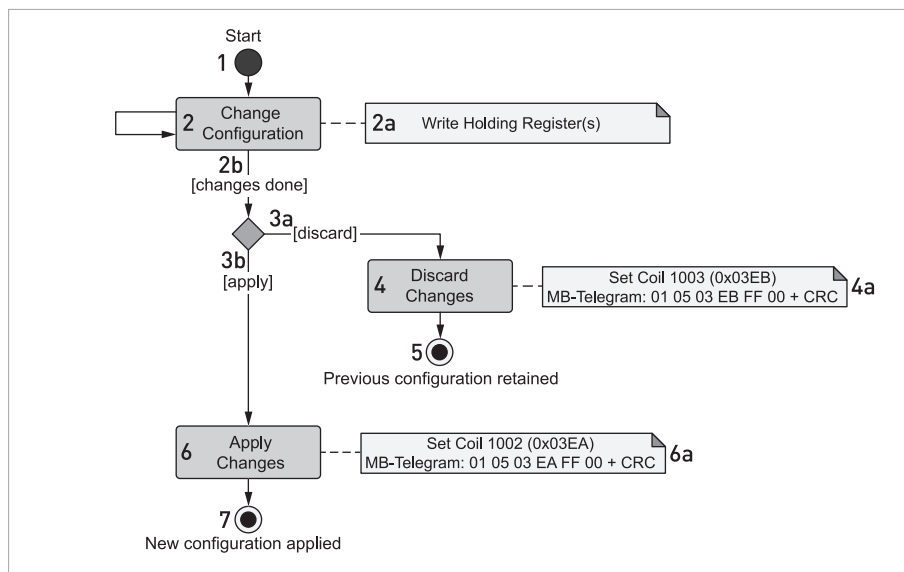

- 1 Start
- 2 Change Configuration
- 2a Write Holding Register(s)
- 2b [changes done]
- 3a [discard]
- 3b [apply]
- 4 Discard Changes
- 4a Set Coil 1003 (0x03EB)
MB-Telegram: 01 05 03 EB FF 00 + CRC
- 5 Previous configuration retained
- 6 Apply Changes
- 6a Set Coil 1002 (0x03EA)
MB-Telegram: 01 05 03 EA FF 00 + CRC
- 7 New configuration applied

The example assumes slave address 1 for Modbus telegram.

6.2 Zero Calibration

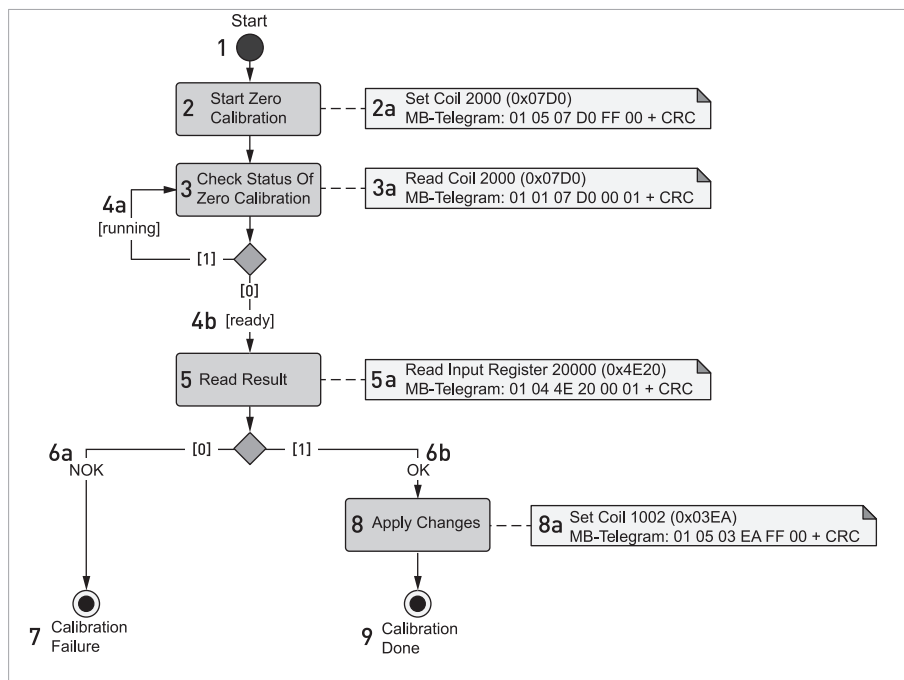

- 1 Start
- 2 Start Zero Calibration
- 2a Set Coil 2000 (0x07D0)
MB-Telegram: 01 05 07 D0 FF 00 + CRC
- 3 Check Status Of Zero Calibration
- 3a Read Coil 2000 (0x07D0)
MB-Telegram: 01 01 07 D0 00 01 + CRC
- 4a running
- 4b ready
- 5 Read Result
- 5a Read Input Register 20000 (0x4E20)
MB-Telegram: 01 04 4E 20 00 01 + CRC
- 6a NOK
- 6b OK
- 7 Calibration Failure
- 8 Apply Changes
- 8a Set Coil 1002 (0x03EA)
MB-Telegram: 01 05 03 EA FF 00 + CRC
- 9 Calibration Done

- The example assumes slave address 1 for Modbus telegram.

7.1 No response to Modbus requests

There are a number of possibilities why no response would be received from the signal converter. Here is a list of some of the more obvious things to check:

- Check that there is an appropriate voltage input on the V+ and V- terminals of the signal converter.
- Ensure that there is continuity between the A and B input terminals and their associated terminals at the master device. Check that A and B are connected correctly (details on page 6). Ensure that there is a proper "Common" connection between the master device and the signal converter.
- The signal converter will ignore messages that are not addressed to it, or any message that contains fundamental formatting errors. So, check that the Address ID that is being requested is correct, the default value is 1. Check that the transmission rate (default = 19200 Baud) and format (default = 8 data bits, even parity and 1 stop bit) are correct.

7.2 Communication errors

Intermittent communication errors can have a number of causes, almost all of which can be attributed to the quality of the connection between the master device and the signal converter, such as:

- Low quality connections at the terminals of the signal converter or master device. Ensure that good contact is being made and that the connections are not frayed or corroded.
- Cable lengths and/or cable capacitance are too great for the data rates being used.
- Powerful sources of electromagnetic interference in close proximity to the path of the cable route.
- It is common to use converter devices to connect the Modbus RS485 output of the signal converter to the serial RS232 port or USB port of a host PC using off-the-shelf protocol converters. Many of these, especially USB based converters will have problems operating the Modbus interface as it is a timing critical protocol. Where possible, a dedicated RS485 interface PC card should be used.

7.3 Responding with exception "Illegal Function"

The function being requested is not valid for the signal converter; check the list of valid Modbus functions. For further information refer to *Supported Function Codes* on page 11.

7.4 Responding with exception "Illegal Data Address"

There are four reasons why the signal converter will return an "Illegal Data Address" error message when the master device makes a request.

- a) The register address being requested is not supported by the signal converter, check the requested register against the registers specified in the section "Parameters".
- b) Although the start address is valid, when accessing multiple registers the number of registers requested may extend beyond the end of the valid address range for that group of variables. Check the number of variables requested and ensure that the last register address is valid.
- c) The number of registers requested is not correct for the data type being requested. For example, if registers containing floating point variables are requested then the number of requested registers must be a multiple of 2 as the floating point variables are held in two consecutive registers. For double precision floating point variables the number of registers requested must be a multiple of 4.
- d) From c) above, the system will respond with an "Invalid Address" error when an attempt is made to access the associated registers of a multi-register variable, for example when access to the second register of a floating point variable is attempted. i.e. if an attempt is made to access Input register 30001, which contains the second half of the variable accessed by Input register 30000.

7.5 Responding with exception "Illegal Data Value"

When the signal converter responds with an "Illegal Data Value", it is because the value being written to a holding register in the signal converter is beyond the permitted limits for that register. The limits for each holding register are indicated in the section "Parameters".

8.1 NAMUR NE 107 Event Group(s)

Modbus Input Register			
39004		39005	
Byte 0	Byte 1	Byte 2	Byte 3

Byte	Bit	Status signal	Event group
3	7	-	reserved
	6	-	reserved
	5	-	reserved
	4	-	reserved
	3	-	reserved
	2	-	reserved
	1	I	Electr: Operation Info
	0	-	reserved
2	7	-	reserved
	6	S	Electr: IO Connection ①
	5	S	Proc: Empty Pipe ①
	4	S	Proc: Signal Lost ①
	3	S	Proc: Signal Unreliable ①
	2	S	Config: Totaliser ①
	1	-	reserved
	0	I	Electr: Power Failure ①
1	7	S	Sensor
	6	S	Electronics
	5	S	Configuration
	4	S	Process
	3	M	Sensor
	2	M	Electronics
	1	M	Configuration
	0	M	Process
0	7	F	Sensor
	6	F	Electronics
	5	F	Configuration
	4	F	Process
	3	C	Sensor
	2	C	Electronics
	1	C	Configuration
	0	C	Process

① Those event groups can be mapped to any status signals.

8.2 NAMUR NE 107 status signals

F	Failure Output signal invalid due to malfunction in the signal converter.
C	Function Check Output signal temporarily invalid due to ongoing work on the signal converter.
S	Out of specification <ul style="list-style-type: none"> • Deviations from the permissible ambient or process conditions determined by the signal converter itself through self-monitoring. • Faults in the signal converter itself indicate that the measuring uncertainty of flow sensors or deviations from the set value in actuators is probably greater than expected under operating conditions.
M	Maintenance required Although the output signal is valid, the wear reserve is nearly exhausted or a function will soon be restricted due to operational conditions.

8.3 Supported Modbus function codes

Function Code 0x01: Read Coils

Request		Response		Error	
Function	0x01	Function	0x01	Function	0x81
Starting Address Hi	0x00 to 0xFF	Byte Count	n	Exception Code	0x01 / 0x02 / 0x03 / 0x04
Starting Address Lo	0x00 to 0xFF	Coil n Status			
Quantity of Coils Hi	n (0x00 to 0x07)		
Quantity of Coils Lo	n (0x01 to 0xFF) max Quantity: 0x07D0				

Function Code 0x02: Read Discrete Inputs

Request		Response		Error	
Function	0x02	Function	0x02	Function	0x82
Starting Address Hi	0x00 to 0xFF	Byte Count	n	Exception Code	0x01 / 0x02 / 0x03 / 0x04
Starting Address Lo	0x00 to 0xFF	Input n Status			
Quantity of Registers Hi	n (0x00 to 0x07)		
Quantity of Registers Lo	n (0x01 to 0xFF) max Quantity: 0x07D0				

Function Code 0x03: Read Holding Registers

Request		Response		Error	
Function	0x03	Function	0x03	Function	0x83
Starting Address Hi	0x00 to 0xFF	Byte Count	2 * n	Exception Code	0x01 / 0x02 / 0x03 / 0x04
Starting Address Lo	0x00 to 0xFF	Register n Value Hi			
Quantity of Registers Hi	0x00	Register n Value Lo			
Quantity of Registers Lo	n (0x01 to 0x7D)		

Function Code 0x04: Read Input Register

Request		Response		Error	
Function	0x04	Function	0x04	Function	0x84
Starting Address Hi	0x00 to 0xFF	Byte Count	2 * n	Exception Code	0x01 / 0x02 / 0x03 / 0x04
Starting Address Lo	0x00 to 0xFF	Input Register n Hi			
Quantity of Input Registers Hi	0x00	Input Register n Lo			
Quantity of Input Registers Lo	n (0x01 to 0x7D)		

Function Code 0x05: Write Single Coil

Request		Response		Error	
Function	0x05	Function	0x05	Function	0x85
Output Address Hi	0x00 to 0xFF	Output Address Hi	0x00 to 0xFF	Exception Code	0x01 / 0x02 / 0x03 / 0x04
Output Address Lo	0x00 to 0xFF	Output Address Lo	0x00 to 0xFF		
Output Value Hi	0x00 or 0xFF	Output Value Hi	0x00 or 0xFF		
Output Value Lo	0x00	Output Value Lo	0x00		

Function Code 0x08: Diagnostics

Request		Response		Error	
Function	0x08	Function	0x08	Function	0x88
Sub-function Hi	0x00 to 0xFF	Sub-function Hi	0x00 to 0xFF	Exception Code	0x01 / 0x03 / 0x04
Sub-function Lo	0x00 to 0xFF	Sub-function Lo	0x00 to 0xFF		
Data n Hi	0x00 to 0xFF	Data n Hi	0x00 to 0xFF		
Data n Lo	0x00 to 0xFF	Data n Lo	0x00 to 0xFF		
...		

Function Code 0x10: Write Multiple Registers

Request		Response		Error	
Function	0x10	Function	0x10	Function	0x90
Starting Address Hi	0x00 to 0xFF	Starting Address Hi	0x00 to 0xFF	Exception Code	0x01 / 0x02 / 0x03 / 0x04
Starting Address Lo	0x00 to 0xFF	Starting Address Lo	0x00 to 0xFF		
Quantity of Registers Hi	0x00	Quantity of Registers Hi	0x00		
Quantity of Registers Lo	0x01 to 0x7B	Quantity of Registers Lo	0x01 to 0x7B		
Byte Count	2 * n (0x02 to 0xFF)				
Register n Value Hi	0x00 to 0xFF				
Register n Value Lo	0x00 to 0xFF				
...	...				

Function Code 0x2B: Encapsulated Interface Transport 0x0E Read Device Identification

Request		Response		Error	
Function	0x2B	Function	0x2B	Function	0xAB
MEI Type	0x0E	MEI Type	0x0E	Exception Code	0x01 / 0x02 / 0x03 / 0x04
Read Device ID Code	0x01 / 0x02 (0x03 / 0x04)	Read Device ID Code	0x01 / 0x02 (0x03 / 0x04)		
Object ID	0x00 to 0xFF	Conformity Level	0x02 (0x01 / 0x03 / 0x04)		
		More Follows	0x00 (or 0xFF)		
		Next Object ID	0x00 to 0xFF		
		Number of Objects	0x01 to 0x07 (0xFF)		
		Object n ID	0x00 to 0xFF		
		Object n length	0x00 to 0xFF		
		Object n value	n (1...254 bytes)		
			

8.4 Number format

- Hexadecimal values are written in the format 0xNNNN, where NNNN is the hexadecimal value.
- Decimal values are written in the format 0dNNNN or NNNN, where NNNN is the decimal value.

8.5 Glossary

RTU	Remote Terminal Unit mode is a Modbus serial transmission mode
RS232	TIA/EIA-232 Standard
RS485	TIA/EIA-485 Standard
Master/Client	A device that polls one or more slave devices and always initiates communication
Slave/Server	A device that responds to requests from a master and never initiates communication
CRC	Cyclic Redundancy Checksum
Register	A Modbus data object corresponding to a word (16 bits)
Coil	A Modbus data object corresponding to a single bit
LSB	Least Significant Byte
MSB	Most Significant Byte
lsb	least significant bit
msb	most significant bit



KROHNE product overview

- Electromagnetic flowmeters
- Variable area flowmeters
- Ultrasonic flowmeters
- Mass flowmeters
- Vortex flowmeters
- Flow controllers
- Level meters
- Temperature meters
- Pressure meters
- Analysis products
- Products and systems for the oil & gas industry
- Measuring systems for the marine industry

Head Office KROHNE Messtechnik GmbH
Ludwig-Krohne-Str. 5
47058 Duisburg (Germany)
Tel.: +49 (0)203 301 0
Fax: +49 (0)203 301 10389
info@krohne.de

The current list of all KROHNE contacts and addresses can be found at:
www.krohne.com

KROHNE