

Conductivity, pH/ORP + Disinfection



Intuition-9™ Series Water Treatment Controllers

Enjoy unparalleled versatility and a collection of sensors and powerful built-in algorithms for control of chemical metering pumps and valves in a broad range of water treatment applications

KEY BENEFITS

- Email, alarm messages, datalog, graph, or system summary reports
- Datalogging
- Ethernet or WiFi for remote access via the Internet, LAN, or optional BACnet or Modbus/TCP
- Large, full-color touchscreen display with icon based programming makes setup easy
- Universal sensor input provides extraordinary flexibility; the same controller can be used with almost any type of sensor needed
- Four I/O slots allow complete flexibility in adding sensors, analog outputs and Linear Polarization Resistance (LPR) corrosion sensors
- Multiple language support allows simple setup
- Three to twelve relay control outputs allow the controller to be used in more applications
- Sixteen virtual inputs and sixteen virtual outputs
- Economical wall-mount package for easy installation
- On-screen and web page graphing of sensor values and control output status
- Complete flexibility in the function of each relay



W A L C H E M

IWAKI America Inc.

SPECIFICATIONS

MEASUREMENT PERFORMANCE

	Range	Resolution	Accuracy
0.01 Cell Contacting Conductivity	0-300 $\mu\text{S/cm}$	0.01 $\mu\text{S/cm}$, 0.0001 mS/cm, 0.001 mS/m, 0.0001 S/m, 0.01 ppm	$\pm 1\%$ of reading
0.1 Cell Contacting Conductivity	0-3,000 $\mu\text{S/cm}$	0.1 $\mu\text{S/cm}$, 0.0001 mS/cm, 0.01 mS/m, 0.0001 S/m, 0.1 ppm	$\pm 1\%$ of reading
1.0 Cell Contacting Conductivity	0-30,000 $\mu\text{S/cm}$	1 $\mu\text{S/cm}$, 0.001 mS/cm, 0.1 mS/m, 0.0001 S/m, 1 ppm	$\pm 1\%$ of reading
10.0 Cell Contacting Conductivity	0-300,000 $\mu\text{S/cm}$	10 $\mu\text{S/cm}$, 0.01 mS/cm, 1 mS/m, 0.001 S/m, 10 ppm	$\pm 1\%$ of reading
pH	-2 to 16 pH units	0.01 pH units	$\pm 0.01\%$ of reading
ORP/Ion Selective Electrode	-1500 to 1500 mV	0.1 mV	± 1 mV
Disinfection sensors	-2000 to 1500 mV	0.1 mV	± 1 mV
	0 - 2 ppm to 0 - 20,000 ppm	Varies with range and slope	Varies with range and slope
Electrodeless Conductivity	500 - 12,000 $\mu\text{S/cm}$	1 $\mu\text{S/cm}$, 0.01 mS/cm, 0.1 mS/m, 0.001 S/m, 1 ppm	$\pm 1\%$ of reading
	3,000-40,000 $\mu\text{S/cm}$	1 $\mu\text{S/cm}$, 0.01 mS/cm, 0.1 mS/m, 0.001 S/m, 1 ppm	$\pm 1\%$ of reading
	10,000-150,000 $\mu\text{S/cm}$	10 $\mu\text{S/cm}$, 0.1 mS/cm, 1 mS/m, 0.01 S/m, 10 ppm	$\pm 1\%$ of reading
	50,000-500,000 $\mu\text{S/cm}$	10 $\mu\text{S/cm}$, 0.1 mS/cm, 1 mS/m, 0.01 S/m, 10 ppm	$\pm 1\%$ of reading
	200,000-2,000,000 $\mu\text{S/cm}$	100 $\mu\text{S/cm}$, 0.1 mS/cm, 1 mS/m, 0.1 S/m, 100 ppm	$\pm 1\%$ of reading
Temperature	23 to 500°F (-5 to 260°C)	0.1°F (0.1°C)	$\pm 1\%$ of reading within range

Temp. °C	Range Multiplier%	Temp. °C	Range Multiplier%
0	181.3	80	43.5
10	139.9	90	39.2
15	124.2	100	35.7
20	111.1	110	32.8
25	100.0	120	30.4
30	90.6	130	28.5
35	82.5	140	26.9
40	75.5	150	25.5
50	64.3	160	24.4
60	55.6	170	23.6
70	48.9	180	22.9



Note: Conductivity ranges above apply at 25°C. At higher temperatures, the range is reduced per the range multiplier chart.

DIMENSIONS

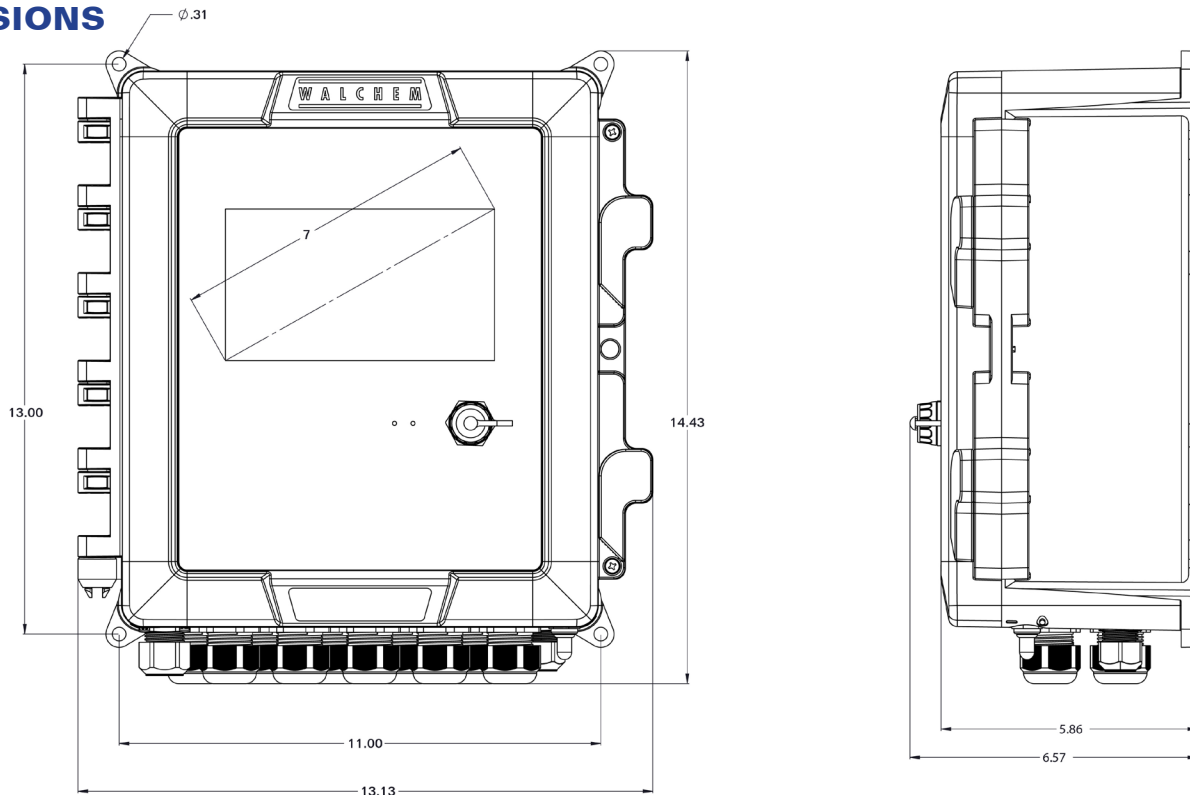

SPECIFICATIONS

INPUTS

Power

(model code dependent)

Relay Board Option 9: 100 to 240 VAC, 50 or 60 Hz, 20A max

All other options: 100 to 240 VAC, 50 or 60 Hz, 15 A maximum

Optional Auxiliary DC Power

12V or 24V, 10 Watts, fully isolated with short circuit protection

Sensor Input Signals (0-8 depending on model code)

Contacting Conductivity: 0.01, 0.1, 1.0, or 10.0 cell constant, or Electrodeless Conductivity or

Disinfection or

Amplified pH, ORP, or Ion Selective Electrode which requires a preamplified signal. ± 5 VDC power available for external preamps.

Walchem WEL or WDS series pH/ORP sensors recommended.

Each sensor input card contains a temperature input.

Temperature: 100 or 1000 ohm RTD, 10K or 100K Thermistor

Analog (4-20 mA) Sensor Input

(0-24 depending on model code)

2-wire loop powered and self-powered transmitters supported

3-wire and 4-wire transmitters supported

All Channels fully isolated, input and power

Channel 1, 130 ohm input resistance, Channel 2-6, 280 ohm input resistance

Available Power: Isolated 24 VDC $\pm 15\%$ supply per channel. 1.5 W (62.5 mA maximum for each channel)

Digital Input Signals (12):

State-Type Digital Inputs

Electrical: Optically isolated and providing an electrically isolated 12V power with a nominal 2.5 mA current when the digital input switch is closed. Typical response time: < 2 seconds. Devices supported: Any isolated dry contact (i.e. relay, reed switch). Types: DI State

Low Speed Counter-Type Digital Inputs

Electrical: Optically isolated and providing an electrically isolated 12V power with a nominal 2.5 mA current when the digital input switch is closed, 0-20 Hz, 25 msec minimum width. Devices supported: Any device with isolated open drain, open collector, transistor or reed switch.

Types: Contacting Flowmeter

High Speed Counter-Type Digital Inputs

Electrical: Optically isolated and providing an electrically isolated 12V power with a nominal 2.5 mA current when the digital input switch is closed, 0-500 Hz, 1.0 msec minimum width. Devices supported: Any device with isolated open drain, open collector, transistor or reed switch.

Types: Paddlewheel Flowmeter

AGENCY CERTIFICATIONS

Safety: UL 61010-1:2012, 3rd Edition
CSA C22.2 No.61010-1:2012, 3rd Edition
IEC 61010-1:2010 3rd Edition
EN 61010-1:2010 3rd Edition

EMC: IEC 61326-1:2012
EN 61326-1:2013

Note: For EN61000-4-6, EN61000-4-3 the controller met performance criteria B. This equipment is suitable for use in establishments other than domestic and those directly connected to a low voltage (100-240 VAC) power supply network which supplies buildings used for domestic purposes.

*Class A equipment: Equipment suitable for use in establishments other than domestic, and those directly connected to a low voltage (100-240 VAC) power supply network which supplies buildings used for domestic purposes.

OUTPUTS

Powered Mechanical Relays

(0-12 model code dependent)

Pre-powered on circuit board switching line voltage

Two, three or four relays are fused together

(depending on model code) as one group,

total current must not exceed 6.A (resistive),

1/8 HP (93W)

Dry Contact Mechanical Relays

(0-12 model code dependent)

6 A (resistive), 1/8 HP (93W)

Dry contact relays are not fuse protected.

Pulse Outputs

(0-12 model code dependent)

Opto-isolated, solid-state relay, 200mA, 40V DC

VLOWMAX = 0.05V @ 18mA

4 - 20 mA

(0-16 model code dependent)

Internally powered, 15VDC, Fully isolated

600 ohm max resistive load

Resolution 0.0015% of span

Accuracy $\pm 0.5\%$ of reading

Ethernet

10/100 802.3-2005

Auto MDIX support

Auto Negotiation

WiFi

Radio Protocol: IEEE 802.11 b/g/n

Security Protocols (Ad-Hoc Mode): WPA2-Personal

Security Protocols (Infrastructure Mode): WPA/WPA2-

Personal, WEP Certifications and Compliance: FCC, IC TELEC,

CE/ETSI, RoHS, WiFi Certified

NOTE on WiFi:

This equipment has been tested and found to comply with the limits for a Class A digital device, pursuant to part 15 of the FCC Rules. These limits are designed to provide reasonable protection against harmful interference when the equipment is operated in a commercial environment. This equipment generates, uses, and can radiate radio frequency energy and, if not installed and used in accordance with the instruction manual, may cause harmful interference to radio communications. Operation of this equipment in a residential area is likely to cause harmful interference in which case the user will be required to correct the interference at his own expense.

USB

Connector: Type A receptacle

Speed: High speed (480 Mbit)

Power: 0.5 A maximum

Battery (Real-Time Clock)

Model BR2032, 3-volt Lithium Coin Cell 20 mm diameter

MECHANICAL (PERFORMANCE)

Enclosure Material	Polycarbonate
Enclosure Rating	NEMA 4X (IEC 60529 IP66)
Dimensions	13.13"W x 14.43"H x 6.7"D (333 mm x 367mm x 167 mm)
Display	7.0" TFT Color Display 1024x3 (RGB) x 600 pixels with capacitive touchscreen
Ambient Temperature	-4 to 122°F (-20 to 50°C)
Storage Temperature	-4 to 176°F (-20 to 80°C)
Humidity	10 to 90%, non-condensing

SPECIFICATIONS

MECHANICAL (SENSORS) (*see graph)

Sensor	Pressure	Temperature	Materials	Process Connections
Electrodeless conductivity	0-150 psi (0-10 bar)*	CPVC: 32-158°F (0 to 70°C)* PEEK: 32-190°F (0 to 88°C)	CPVC, FKM in-line o-ring PEEK, 316 SS in-line adapter	1" NPTM submersion 2" NPTM in-line adapter
pH	0-100 psi (0-7 bar)*	50-158°F (10-70°C)*	CPVC, Glass, FKM o-rings, HDPE, Titanium rod, glass-filled PP tee	1" NPTM submersion 3/4" NPTF in-line tee
ORP	0-100 psi (0-7bar)*	32-158°F (0-70°C)*		
Contacting conductivity (Condensate)	0-200 psi (0-14 bar)	32-248°F (0-120°C)	316SS, PEEK	3/4" NPTM
Contacting conductivity Graphite (Cooling Tower)	0-150 psi (0-10 bar)*	32-158°F (0-70°C)*	Graphite, Glass-filled PP, FKM o-ring	3/4" NPTM
Contacting conductivity SS (Cooling Tower)	0-150 psi (0-10 bar)*	32-158°F (0-70°C)*	316SS, Glass-filled PP, FKM o-ring	3/4" NPTM
Contacting conductivity (Boiler)	0-250 psi (0-17 bar)	32-401°F (0-205°C)	316SS, PEEK	3/4" NPTM
Contacting conductivity (High Pressure Tower)	0-300 psi (0-21 bar)*	32-158°F (0-70°C)*	316SS, PEEK	3/4" NPTM
pH (High Pressure)	0-300 psi (0-21 bar)*	32-275°F (0-135°C)*	Glass, Polymer, PTFE, 316SS, FKM	1/2" NPTM gland
ORP (High Pressure)	0-300 psi (0-21 bar)*	32-275°F (0-135°C)*	Platinum, Polymer, PTFE, 316SS, FKM	1/2" NPTM gland
Free Chlorine/Bromine	0-14.7 psi (0-1 bar)	32-113°F (0-45°C)	PVC, Polycarbonate silicone rubber, SS PEEK, FKM, Isoplast	1/4" NPTF Inlet 3/4" NPTF Outlet
Extended pH Range Free Chlorine/Bromine	0-14.7 psi (0-1 bar)	32-113°F (0-45°C)		
Total Chlorine	0-14.7 psi (0-1 bar)	32-113°F (0-45°C)		
Chlorine Dioxide	0-14.7 psi (0-1 bar)	32-122°F (0-50°C)		
Ozone	0-14.7 psi (0-1 bar)	32-131°F (0-55°C)		
Peracetic Acid	0-14.7 psi (0-1 bar)	32-131°F (0-55°C)		
Hydrogen Peroxide	0-14.7 psi (0-1 bar)	32-113°F (0-45°C)		
Corrosion	0-150 psi (0-10 bar)	32-158°F (0-70°C)*		
Flow switch manifold	0-150 psi (0-10 bar) up to 100°F (38°C)* 0-50 psi (0-3 bar) at 140°F (60°C)	32-140°F (0-60°C)*	GFRPP, PVC, FKM, Isoplast	3/4" NPTF
Flow switch manifold (High Pressure)	0-300 psi (0-21 bar)*	32-158°F (0-70°C)*	Carbon steel, Brass, 316SS, FKM	3/4" NPTF
Little Dipper 2	0-100 psi (0-7 bar)*	32-122°F (0-50°C)*	PVC, GRFP, FKM	3/4" NPTF in-line tee
Pyxis	0-100 psi (0-7 bar)*	40-104°F (4-40°C)*	CPVC, Quartz, FKM	3/4" NPTF in-line tee

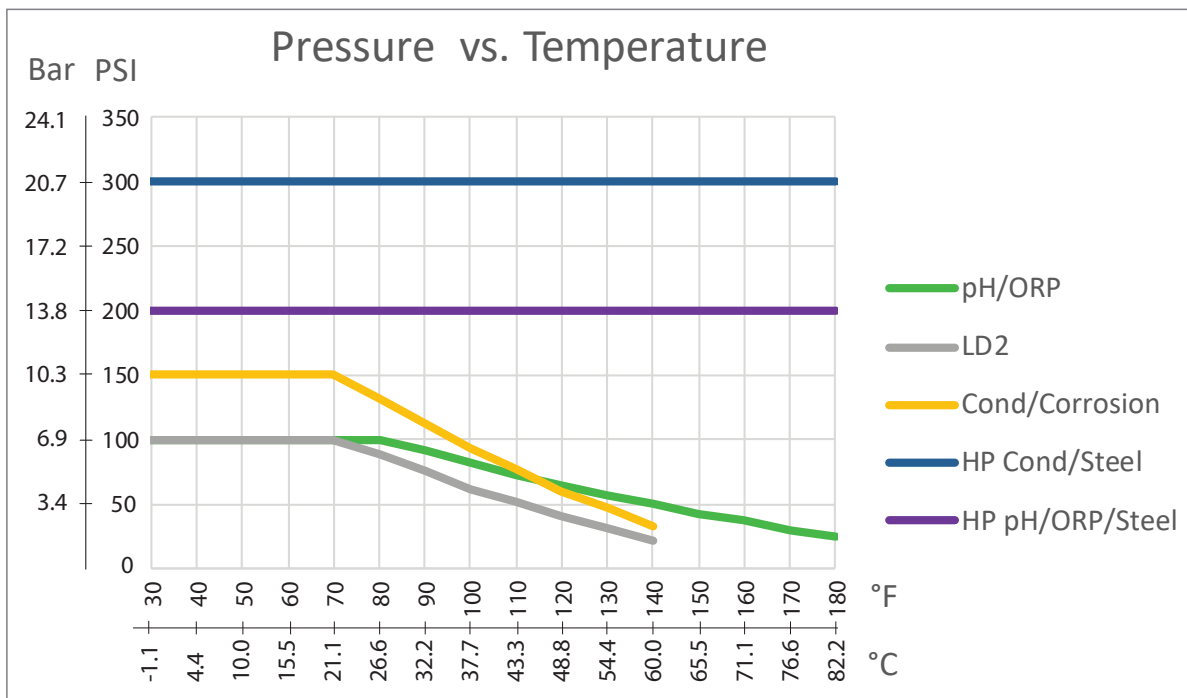

MODEL CODES FOR FIXED RELAYS

W	CT9	0000	P	AADE	W	M	H	S	ANNNN
Label	Base	Relay Board/Pigtails	Power Cord	I/O Module#1-4	WiFi	Protocol	Auxiliary Power	Sensor Mounting	Sensor Option
W	IN9	0000	P	AADE	W	M	H	S	ANNNN
Label	Base	Relay Board/Pigtails	Power Cord	I/O Module#1-4	WiFi	Protocol	Auxiliary Power	Sensor Mounting	Sensor Option
W	BL9	0000	P	AADE	W	M	H	ANNNNN	
Label	Base	Relay Board/Pigtails	Power Cord	I/O Module#1-4	WiFi	Protocol	Auxiliary Power	Sensor Option	

LABEL

W	Walchem
---	---------

BASE

CT9	Cooling Tower
BL9	Boiler
IN9	pH, Disinfection, Conductivity

RELAY BOARD/PIGTAILS

0000	8 Powered Relays
1000	7 Powered 1 Dry Relays
2000	2 Opto 6 Dry Relays
3000	4 Powered 4 Dry Relays
4000	4 Opto 4 Dry Relays
5000	4 Opto 4 Powered Relays
6000	2 Opto 6 Powered Relays
7000	8 Dry Relays
A000	8 Powered Relays with USA Pigtails Prewired
B000	7 Powered Relays with USA Pigtails Prewired, 1 Dry Relay
C000	4 Powered Relays with USA Pigtails Prewired, 4 Dry Relays
D000	4 Powered Relays with USA Pigtails Prewired, 4 Opto Relays with 20ft Pulse Cables
E000	6 Powered Relays with USA Pigtails Prewired, 2 Opto Relays with 20ft Pulse Cables
F000	4 Dry Relays, 4 Opto Relays with 20 ft Pulse Cables
G000	6 Dry Relays, 2 Opto Relays with 20 ft Pulse Cables

POWER CORD

B	Brazil Power Cord, 15 Amp
D	DIN Power Cord, 15 Amp
H	Hardwired - No Power Cord
P	USA Power Cord, 15 Amp

I/O MODULES #1-4 (MUST BE IN ALPHABETICAL ORDER)

N	No Input Output Module
A	Dual Sensor Inputs
B	Dual Analog Inputs
C	Four Analog Inputs
D	Six Analog Inputs
E	Dual Analog Inputs + Four Analog Outputs
F	Dual Analog Outputs
G	Four Analog Outputs
H	Dual Corrosion Inputs

WiFi

N	None
W	Single Connection, WiFi only
D	Dual Connection, Ethernet and WiFi

COMMUNICATIONS PROTOCOL

N	None
M	Modbus TCP and BACnet

AUXILIARY POWER

N	No Auxiliary Power
L	12 VDC Auxiliary Power Board
H	24 VDC Auxiliary Power Board

SENSOR MOUNTING

N	None
S	Submersion
I	Inline
L	Loose flow switch manifold
P	Flow switch manifold on panel
F	Loose high pressure flow switch manifold
H	High Pressure flow switch manifold on panel*
S	Submersion
I	Inline
L	Loose flow switch manifold
P	Flow switch manifold on panel

SENSORS #1-5 (must be in alphabetical order)

Only one sensor of the same type can be selected for any manifold mounting style.

N	None
A	Graphite/PP cooling tower contacting conductivity
B	316SS/PP cooling tower contacting conductivity
C	Cooling tower, electrodeless conductivity
D	High pressure conductivity
E	Makeup conductivity
F	Flat pH
G	High pressure pH
H	Rod ORP
I	Flat ORP
J	High pressure ORP
K	Chlorine**
L	ClO ₂ **
M	Little Dipper**
O	One Corrosion Sensor (electrodes purchased separately)**
P	Pyxis PTSA**
R	Two Corrosion Sensors (electrodes purchased separately)**
S	Disinfection, No Sensor
T	Pyxis Polymer**
U	Pyxis PTSA+Polymer**
A	External Preamp
B	Flat pH with ATC
C	Disinfection, no sensor
D	PEEK electrodeless
E	CPVC electrodeless
F	CCond, K=1.0, 100psi
G	CCond, K=0.1, 100psi
H	CCond, K=10, 100psi
I	CCond, K=0.01, 100psi
J	CCond, K=1.0, 200psi
K	CCond, K=0.1, 200psi
L	CCond, K=10, 200psi
M	CCond, K=0.01, 200psi

SENSORS #1-6 (must be in alphabetical order)

* If a high pressure manifold is selected, only Hi P sensors and Makeup available.

** Dipper, Pyxis, Chlorine, ClO₂, Corrosion sensors NOT available with Submersion mounting

N	None
A	Boiler sensor with ATC, 250 psi, K=1.0, 20ft.cable
B	Boiler sensor no ATC, 250 psi, K=1.0, 20ft.cable
C	Condensate sensor with ATC, 200 psi, K=0.1, 10ft.cable
D	Boiler sensor with ATC, 250 psi, K=10, 20ft.cable

MODEL CODES FOR FIELD CONFIGURABLE RELAYS

W	CT9	8	CGH	P	AADE	W	M	H	S	ANNNN
Label	Base	Relay Board	Relay Board/Pigtails #1-3	Power Cord	I/O Module#1-4	WiFi	Protocol	Auxiliary Power	Sensor Mounting	Sensor Option
W	IN9	8	CGH	P	AADE	W	M	H	S	ANNNN
Label	Base	Relay Board	Relay Board/Pigtails #1-3	Power Cord	I/O Module#1-4	WiFi	Protocol	Auxiliary Power	Sensor Mounting	Sensor Option
W	BL9	8	CGH	P	AADE	W	M	H	ANNNNN	
Label	Base	Relay Board	Relay Board/Pigtails #1-3	Power Cord	I/O Module#1-4	WiFi	Protocol	Auxiliary Power	Sensor Option	

LABEL

W	Walchem
---	---------

BASE

CT9	Cooling Tower
BL9	Boiler
IN9	pH, Disinfection, Conductivity

FIELD CONFIGURABLE RELAYS

Relay Board	
8	Flexible relay board with 3 relay slots, 15 Amp
9	Flexible relay board with 3 relay slots, 20 Amp
Relay Module/Pigtail Options #1-#3 (must be in alphabetical order)	
Example, CGH for three modules: a 4-opto, a 3-Form C, and a 4-Powered with USA pigtails	
A	4 Powered Relays
B	4 Dry Relays
C	4 Opto Relays
D	2 Powered and 2 Dry Relays
E	2 Powered and 2 Opto Relays
F	2 Dry and 2 Opto Relays
G	3 Form C Dry Relays
H	4 Powered Relays with USA Pigtails Prewired
I	2 Powered Relays with USA Pigtails Prewired and 2 Dry Relays
J	2 Powered Relays with USA Pigtails Prewired and 2 Opto Relays with 20ft Pulse Cables
K	4 Opto Relay with 20ft Pulse Cables
L	2 Dry Relays, 2 Opto Relays with 20ft Pulse Cables
N	No Relay Module

POWER CORD

B	Brazil Power Cord, 15 Amp, Not Avail. for Relay Board 9
D	DIN Power Cord, 15 Amp, Not Avail. for Relay Board 9
H	Hardwired - No Power Cord
P	USA Power Cord, 15 Amp, Not Avail. for Relay Board 9
T	USA Power Cord, 20 Amp, ONLY Avail. for Relay Board 9

I/O MODULES #1-4 (MUST BE IN ALPHABETICAL ORDER)

N	No input output module
A	Dual Sensor Inputs
B	Dual Analog Inputs
C	Four Analog Inputs
D	Six Analog Inputs
E	Dual Analog Inputs + Four Analog Outputs
F	Dual Analog Outputs
G	Four Analog Outputs
H	Dual Corrosion Inputs

WiFi

N	None
W	Single Connection, WiFi only
D	Dual Connection, Ethernet and WiFi

COMMUNICATIONS PROTOCOL

N	None
M	Modbus TCP and BACnet

AUXILIARY POWER

N	No Auxiliary Power
L	12 VDC Auxiliary Power Board
H	24 VDC Auxiliary Power Board

SENSOR MOUNTING

N	None
S	Submersion
I	Inline
L	Loose flow switch manifold
P	Flow switch manifold on panel
F	Loose high pressure flow switch manifold
H	High Pressure flow switch manifold on panel*
S	Submersion
I	Inline
L	Loose flow switch manifold
P	Flow switch manifold on panel

SENSORS #1-5 (must be in alphabetical order)

Only one sensor of the same type can be selected for any manifold mounting style.

N	None
A	Graphite/PP cooling tower contacting conductivity
B	316SS/PP cooling tower contacting conductivity
C	Cooling tower, electrodeless conductivity
D	High pressure conductivity
E	Makeup conductivity
F	Flat pH
G	High pressure pH
H	Rod ORP
I	Flat ORP
J	High pressure ORP
K	Chlorine**
L	ClO ₂ **
M	Little Dipper**
O	One Corrosion Sensor (electrodes purchased separately)**
P	Pyxis PTSA**
R	Two Corrosion Sensors (electrodes purchased separately)**
S	Disinfection, No Sensor
T	Pyxis Polymer**
U	Pyxis PTSA+Polymer**
A	External Preamp
B	Flat pH with ATC
C	Disinfection, no sensor
D	PEEK electrodeless
E	CPVC electrodeless
F	CCCond, K=1.0, 100psi
G	CCCond, K=0.1, 100psi
H	CCCond, K=10, 100psi
I	CCCond, K=0.01, 100psi
J	CCCond, K=1.0, 200psi
K	CCCond, K=0.1, 200psi
L	CCCond, K=10, 200psi
M	CCCond, K=0.01, 200psi

SENSORS #1-6 (must be in alphabetical order)

* If a high pressure manifold is selected, only Hi P sensors and Makeup available.

** Dipper, Pyxis, Chlorine, ClO₂, Corrosion sensors NOT available with Submersion mounting

N	None
A	Boiler sensor with ATC, 250 psi, K=1.0, 20ft.cable
B	Boiler sensor no ATC, 250 psi, K=1.0, 20ft.cable
C	Condensate sensor with ATC, 200 psi, K=0.1, 10ft.cable
D	Boiler sensor with ATC, 250 psi, K=10, 20ft.cable

Cloud-based water treatment management software tool that amplifies the value of Walchem controllers



Key Benefits

- Real-Time Access to Your Process
- Mobile Device Friendly
- Alarm Notification with Escalation
- Data Graphing and Storage

Customer + Facilities Management

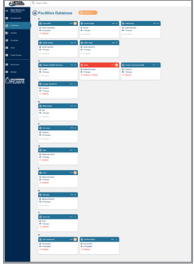

- Full management of customers and their facilities to access the information you need as quickly as possible
- Flag priority customers and facilities for quick access to help plan your upcoming work week

Process Monitoring + Control

- Anywhere access to customer's real-time controller data
- Link directly to LiveConnect to make changes on your controllers remotely

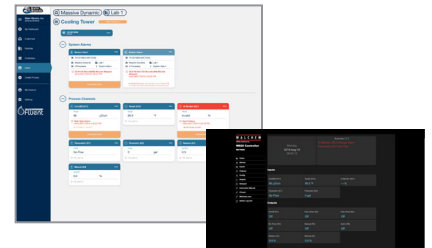

Data Management + Visualizations



- Assess key parameters at-a-glance with customizable Dashboard
- Easy-access to alarms organized by priority levels with acknowledgment features
- Bookmark customers, facilities and controllers for a user-customized Dashboard experience
- Visualize recent and historical controller data trends on easy-to-read, interactive graphs
- Compare graphs across multiple controller channels
- Access historical data and export your graphs to PDF and CSV file for your reporting needs

Alarms + Custom Notifications

- Manage workflow by notifying workers of triggered alarms
- Customize the escalation process including first party notified
- Notify two unique groups of users
- Manage alarm settings by controller channel
- Set alarm levels to quickly identify the most critical issues
- Alarm email summaries

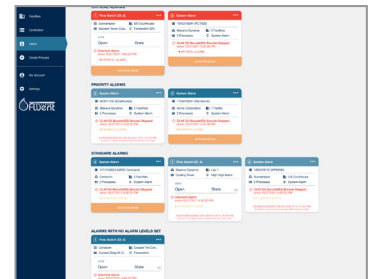

Team Management

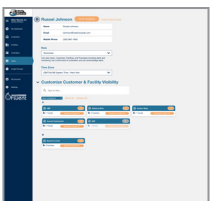

- Create Admin, Technician, and View-Only user roles
- Set custom visibility permissions for users so they only see the customers they need to access

Sensors + Accessories

High quality accessories for cooling tower, boiler, potable water, and wastewater applications

Carefully designed accessories and selected for compatibility with our pumps and controllers to enable our customers to provide a complete system solution. Here is just a sampling of the sensors and accessories available from Walchem:

Disinfection Sensors

Amperometric disinfection sensors offer a cost effective and reliable solution to your disinfection control requirements. We offer sensors, in varying ranges of concentration, for free chlorine/bromine, total chlorine, chlorine dioxide, ozone, peracetic acid and hydrogen peroxide. Whether the application is cooling tower, food and beverage, drinking water, wastewater or swimming pool, these sensors are the ideal solution.

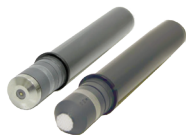

Fluorometers

The Little Dipper 2 and Pyxis in-line fluorometers are rugged, 24/7 sampling devices that provide maximum performance, minimal maintenance and solid state reliability. They can be used with data collection systems to monitor and control the level of treatment chemicals for cooling tower and boiler applications. The handheld Little Dipper is a small, lightweight and highly durable fluorometer ideal for quick measurements in the field.



Contacting Conductivity Sensors

Contacting conductivity sensors are ideal for use in cooling towers and boilers, reverse osmosis equipment, and other non-oily applications. A variety of cell constants are available to handle a range of conductivities.



pH/ORP Sensors

Cost-effective differential pH/ORP electrodes for industrial and municipal applications.



Electrodeless Conductivity Sensors

Electrodeless conductivity sensors may be installed in a variety of very harsh chemical control applications, including oily cleaner baths, chromates, rinse tanks, fume scrubbers and other concentrated chemicals up to a conductivity of 1000 mS/cm (range varies with solution temperature).



Water Meters

WFM Series water meters have earned a reputation for design simplicity, wide range of applications and accuracy in low-quality water. The WFM Series uses the widely recognized multi-jet principle, which has been accepted as an international standard for many years. These meters are available with either a two-wire reed switch, or a solid state, three-wire Hall effect sensor.



Contacting Conductivity Sensors

Contacting conductivity sensors are ideal for use in cooling towers and boilers, reverse osmosis equipment, and other non-oily applications. A variety of cell constants are available to handle a range of conductivities.



pH/ORP Sensors

Cost-effective differential pH/ORP electrodes for industrial and municipal applications.

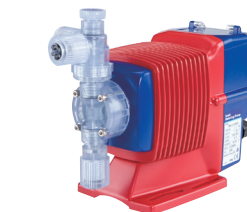

Metering Pumps

The E-Class is the most innovative and comprehensive metering pump product line in the world. Over 50 years of pump experience and a commitment to superior mechanical design has led to development of many industry firsts, including 360 stroke-per-minute technology, and the world's highest capacity solenoid metering pumps.

Accessories

To complete your system, Walchem provides high quality accessories that are required for cooling tower, boiler, potable water, and wastewater applications. All of Walchem's accessories are carefully designed and selected for compatibility with our pumps and controllers to enable our customers to provide a complete system solution.



walchem.com

180901.A September 2021