

USER'S GUIDE

Installation & Operation
Instructions

Portable Area-Velocity Flow
Meter

Model MantaRay

Manual Series A.1.1

Note: This page has been left blank intentionally.

INDEX

CONNECTIONS 4
KEYPAD SYSTEM..... 5
BATTERY 5
CALIBRATION MENU 6
ICONS..... 6
MESSAGE ICON 8
STATUS 8
PASSWORD 9
UNITS/MODE 10
CALIBRATION..... 11
RELAY PARAMETERS 14
DATA LOGGING 15
SPECIAL FUNCTIONS 17
INSTALLATION - SENSOR LOCATION 19
APPLICATIONS HOTLINE 22
PRODUCT RETURN PROCEDURE..... 23
AREA-VELOCITY FLOW DATA SHEET 24
SPECIFICATIONS 28

IMPORTANT NOTE: This instrument is manufactured and calibrated to meet product specifications. Please read this manual carefully before installation and operation. Any unauthorized repairs or modifications may result in a suspension of the warranty.

Available in Adobe Acrobat pdf format

CONNECTIONS

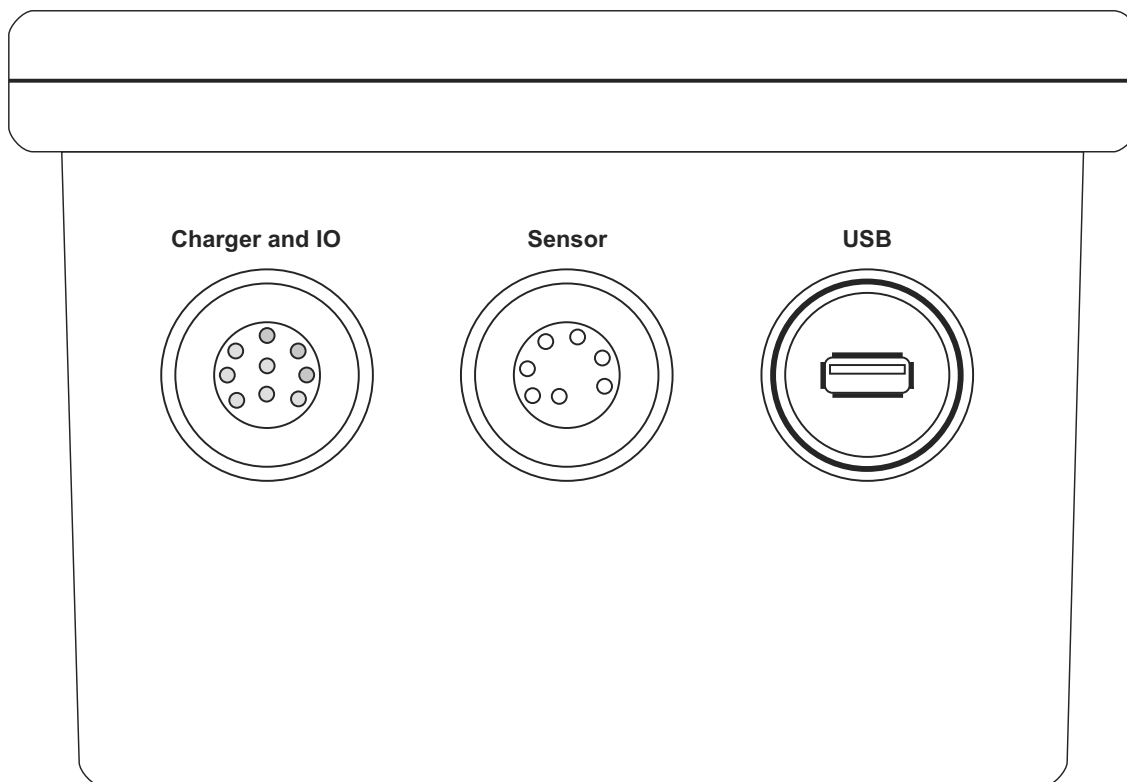

Plug Connector

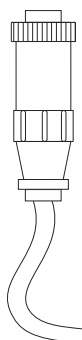

**Charger
or optional
Break-out Box
pg. 27**

QZ02L

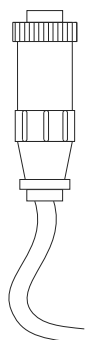

see pg. 28

Thumbdrive



**not
supplied**

KEYPAD SYSTEM

The MantaRay uses a menu system. Arrows show the four directions to leave a menu box. Pressing a corresponding keypad arrow will move to the next item in the direction shown. Move the cursor (underline) under numerals and increase or decrease numerals with the **↑** and **↓** keys.

To store calibration values permanently (even through power interruptions), press **✓**.

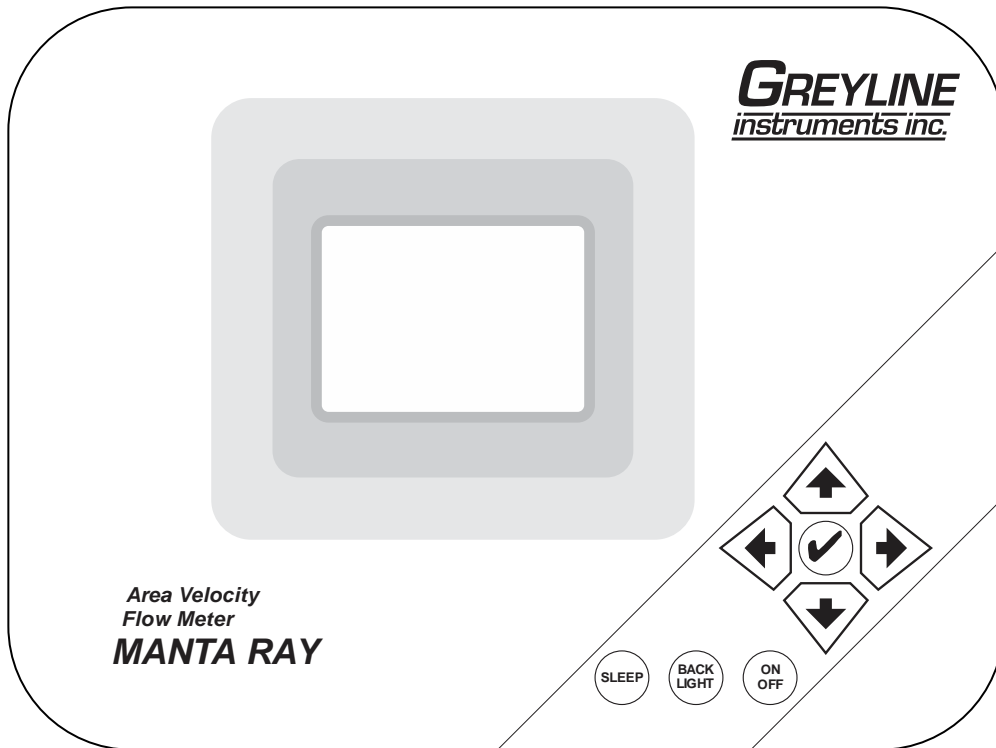

BATTERY

- A built-in rechargeable NiMH battery supplies power for 48 hours continuous operation when fully charged.
- Display brightness is adjustable to conserve power.
- The MantaRay will switch off automatically when the battery is fully discharged.
- Full charge requires approximately 6 to 9 hours charging.
- Sleep mode extends battery life for long term data logging (30 days for 5 minute logging).

CHARGING BATTERY

A 16V AC-DC power module is supplied for battery charging and continuous use. Full charge requires 6-9 hours when fully drained. Solid battery icon and/or full charge adapter icon indicates when battery is fully charged.

CALIBRATION MENU

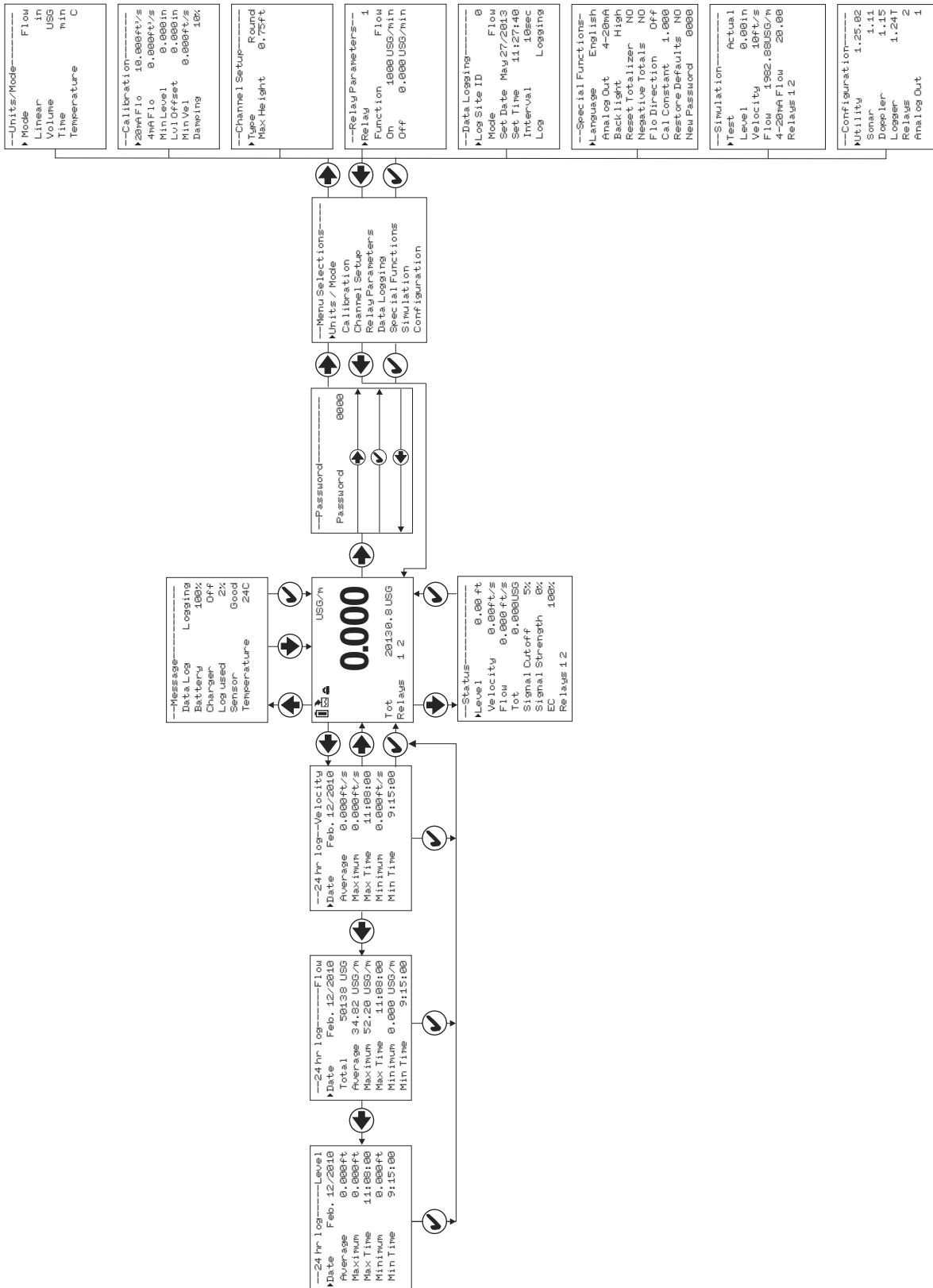

ICONS



1.



2.

Message waiting. Press .



Data logging off.



1.



2.

Data logging on.



1.



2.



3.



4.

USB file download.



File download completed.



Download Error.



1.



2.



3.

Echo OK.



No Echo.

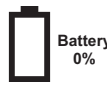

Battery
0%

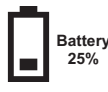

Battery
25%

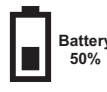

Battery
50%

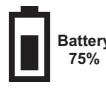

Battery
75%



Battery
100%

Battery status / charging icon.



External Battery Source.



Full charge powered by 16V adapter.



Z



Z Z



Z Z Z

Sleep mode icon indicates that MantaRay is running in sleep mode. The icon appears only during the wake cycle when the display is fully lit.

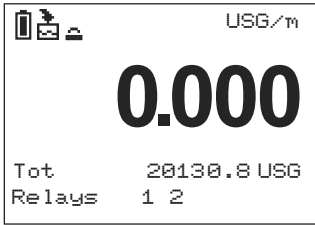

MAIN DISPLAY

The main display shows the units selected from the `Units/Mode` menu, Flow or Velocity rate being measured, TOTALIZER and RELAY states. The MantaRay will start-up with this display.

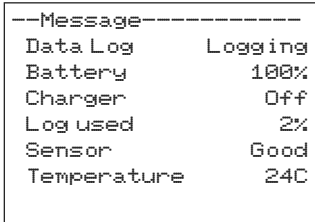

MESSAGE ICON

Press `↑` from the main display to view temperature measurement, status of the data logger battery and error/warning messages provided by the instrument. The Message Icon will appear on the main display if error messages are being generated by the instrument. Press `✓` to return to the main display.

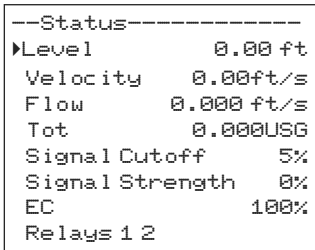

STATUS

Press `↓` from the MAIN display to view instrument status.

- Velocity** Will be displayed in `ft/sec` or `m/sec`.
- Level** Is displayed in the selected units.
- Tot** Displays the current totalizer reading.
- Signal Cutoff** Adjust the setting in percent to suppress flow readings at zero flow when fluid swirling or pipe vibration may cause the instrument to continue reading. Example: `Signal Cutoff` at `5%` will force the display and outputs to zero when signal strength drops below 5%.
- Signal Strength** Displays percentage of signal being received by the ultrasonic sensor.
- EC** Displays level measurement Echo Confidence
- Relays 1 2** Energized relays will display with reversed font eg: `2`

```
--24 hr log-----Flow
▶Date   Feb. 12/2010
Total   50138 USG
Average 34.82 USG/m
Maximum 52.20 USG/m
Max Time 11:08:00
Minimum 0.000 USG/m
Min Time 9:15:00
```

24 HR LOG

Press **←** from the MAIN display to view a formatted flow report from instruments with a built-in data logger. Press **←** to pan through **Level**, **Velocity** and **Flow** summaries. Press **↓** to scroll down one day or repeatedly to scroll to a specific date. Up to 365 days can be stored. Newest date will overwrite the oldest. Press **✓** to return to the main display.

```
--Password-----
Password   0000
  ◀────────▶
  ◀────────▶
  ◀────────▶
  ◀────────▶
```

PASSWORD

The **Password** (a number from 0000 to 9999) prevents unauthorized access to the **Calibration** menu.

From the Main display press **➡** to get to **Password**. Factory default password is 0000 and if it has not been changed press **✓** to proceed to the **Menu Selections** screen.

If a password is required, press **➡** to place the cursor under the first digit and **↓** or **↑** to set the number, then **➡** to the second digit, etc. Press **➡** or **✓** to proceed to the **Menu Selections** screen.

A new password can be stored by going to **Special Functions/New Password**.

```

--Units/Mode-----
▶Mode                Flow
Linear              in
Volume             USG
Time               min
Temperature        C
  
```

UNITS/MODE

From ▶Mode press the → and then the ↑ or ↓ to select Flow, Velocity or Level. Flow mode displays the flow rate in engineering units (e.g. gpm, litres/sec, etc.) Press the ✓ to store your selection then the ↓ to the next menu item.

```

--Units/Mode-----
Mode                Flow
▶Linear             in
                  ft
                  m
                  mm
  
```

From ▶Linear press the → key and then the ↑ or ↓ to select your units of measurement. Press the ✓ to store your selection.

Press the ↓ key to move the ▶ symbol to each subsequent menu item and the ✓ to save your selections.

Note: the volume selection "bbl" denotes U.S. barrels.

```

--Units/Mode-----
Mode
Linear
▶Volume             USG
                  ft3
                  bbl
                  L
                  m3
                  IMG
                  IG
                  USMG
  
```

▶ Temperature press → then ↑ ↓ to select C or F.

Press ← or ✓ to return to the Menu Selections screen.

```

--Units/Mode-----
Mode                Flow
Linear              in
Volume             USG
▶Time              sec
                  day
                  hr
                  min
  
```

```

--Units/Mode-----
Mode                Flow
Linear              in
Volume             USG
Time               min
▶Temperature        C
                  F
  
```

```

--Calibration-----
▶20mA Flo  10.000ft/s
4mA Flo    0.000ft/s
Min Level  0.000in
Lvl Offset 0.000in
Min Vel    0.000ft/s
Damping    10%
  
```

CALIBRATION

Press **↓** to **Calibration** and **→** to enter. Use **↓** or **↑** to position **▶** before each menu item and **→** to enter. When settings are completed press **✓** to store and return to the Calibration menu.

20mA Flo Press **→** and enter the flow rate value for 20mA.
 [5V Flo]
 [OFF]

Note: Analogue output can be selected as 4-20mA or 0-5V in Special Functions.

4mA Flo Press **→** and enter the flow rate value for 4mA.
 [0V Flo]
 [OFF]

Lvl Offset Optional for QZ02L sensor (use for mud or silt conditions). Press **→** and enter an offset to level measurement. Set to 0.00 when sensor mounted on floor of channel. When sensor is mounted above the floor of the channel enter the distance between channel floor and bottom of sensor. Maximum offset is $\pm 36"$ (914 mm).

Note: 4mA is not affected by **Lvl Offset** settings. 4mA is the bottom of the channel or pipe.

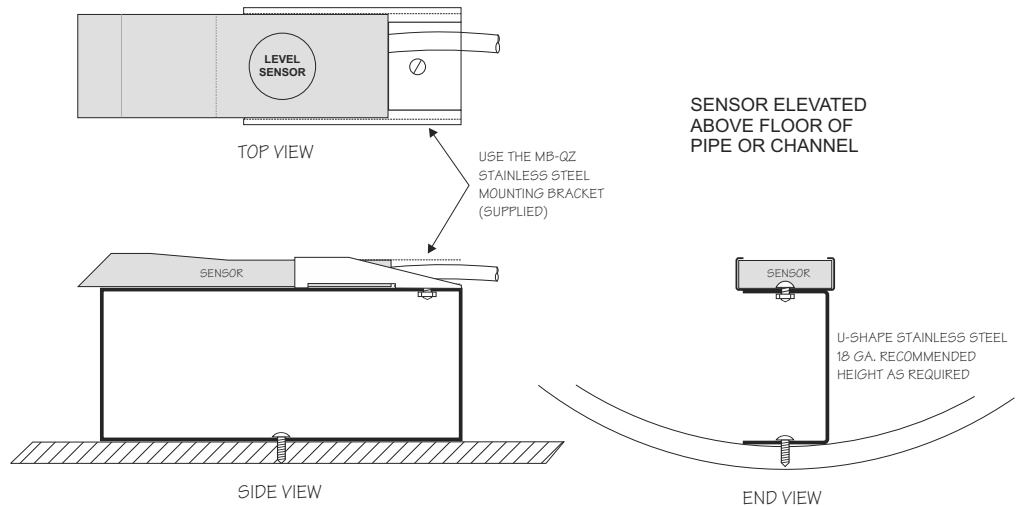

Min Vel Press **→** and enter a minimum velocity cutoff. Forward and reverse velocities less than **Min Vel** will be forced to zero.

Damping Increase damping to stabilize readings under turbulent flow readings or to reject spurious level readings. Decrease for faster response to changes in flow.

Press **✓** from the **Calibration** display to return to Menu Selections.

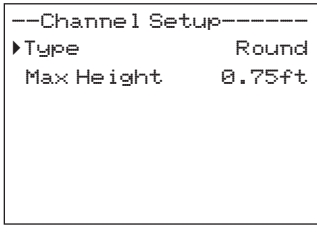

CHANNEL SETUP

Round Select **Round** for open pipes. Set **Max Height** to the inner diameter of the pipe.

Rectangle Select **Rectangle** for rectangular channels. Enter the channel width.

Trapezoid Select **Trapezoid** for trapezoidal shaped channels. Specify the **Width** and **Slope** of the channel as shown in the following illustration.

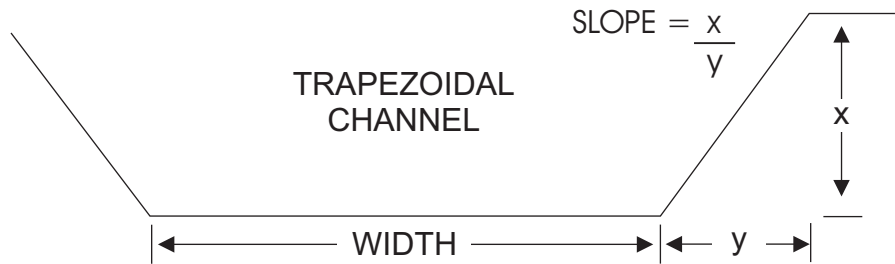

Egg Select **Egg** for Egg shaped channels. Enter the **Max Height** of the channel.

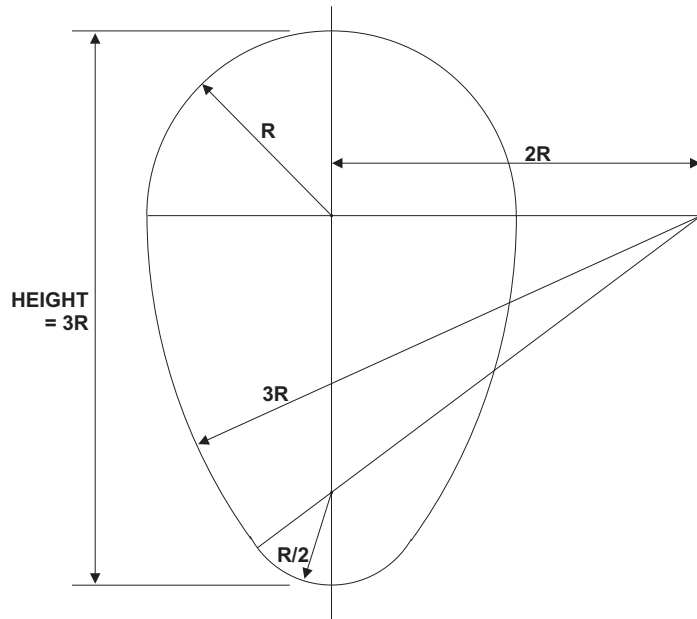

```

--Custom Channel-----
▶Type           Custom
Reset Data      No
Max Height      0.75 ft
Division        0.05 ft
Increment #     0
Width           0.000 ft
Level          0.000 ft
  
```

CUSTOM CHANNELS

- Reset Data** Old data MUST be removed before entering data for a new channel. Press **➡** then press **⬆** to **Yes** and press **✓** to clear old data.
- Max Height** Enter the maximum height of the channel.
- Division** Divide the maximum height into equal increments (maximum of 40) and enter this division value (example 1", 1 cm etc.)
- Increment #** Enter the increment number if you want to edit a previous entry or to skip entering widths for some levels (Note: The custom channel will interpolate widths between entry points).
- Width** Enter the measured width of the channel at the level shown (Note: To enter 0 width you must press **➡** and then **✓** to store a 0 width data point).
- Level** Displays the level of the channel for each increment and width entry.

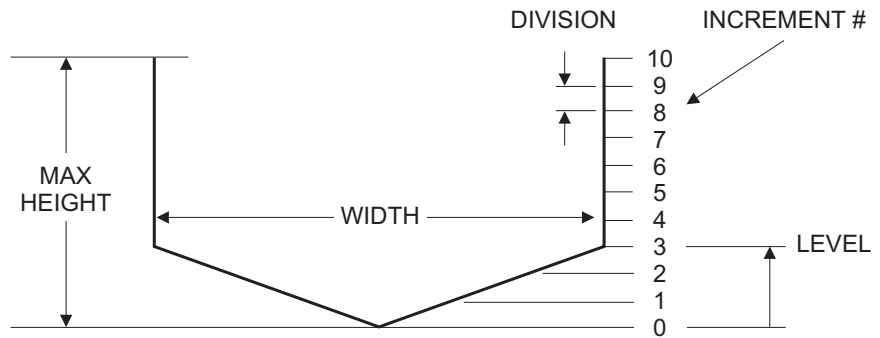

Note:

Custom channel data in equal width increments with variable height measurements must be converted to the format shown above using the "Channel Data Translator" PC software.

```
--Relay Parameters--
▶Relay              1
Function            Flow
On                  1000 USG
Off                 0.000 USG
```

RELAY PARAMETERS

Relay Press **➡** and **⬇** or **⬆** to select a relay (2 relays).

Function Press **⬇** or **⬆** to select **Off**, **Pulse**, **Flow**, **Velocity** or **Level**.

Flow

On Position the cursor under the numerals and press **⬇** or **⬆** to set digits to the relay **On** set point.

Off set digits to the **Off** set point.

Pulse Press **⬇** and set digits to the flow volume per relay pulse. Use this feature for remote samplers, chlorinators or totalizers. Minimum time between pulses is 2.25 seconds and pulse duration is 350 milliseconds.

Return to **Relay** and enter settings for each relay.

Velocity

On Position the cursor under the numerals and press **⬇** or **⬆** to set digits to the relay **On** set point.

Off set digits to the **Off** set point.

Level

On Position the cursor under the numerals and press **⬇** or **⬆** to set digits to the relay **On** set point.

Off set digits to the **Off** set point.

LOE mode Specify the state of the relay for loss of echo condition: **Off**, **On** or **Hold**.

Press **✓** to return to **Menu Selections**

```
--Data Logging-----
Log Site ID      00
                 99
Mode             Flow
                 Velocity
Set Date        Feb 18/2008
                 Mar 19/2009
Set Time        11:27:40
                 12:28:41
Interval        10sec
                 60min
                 30min
                 15min
                 10min
                 5min
                 2min
                 1min
                 30sec
Log             Stop
                 Start
                 Delete
```

DATA LOGGING

Setup

Select **Data Logging** from Menu Selections.

Log Site ID Enter a number from **00** to **99**. The site ID will become part of the downloaded file name to help distinguish downloads from different instruments. Press **✓** to store the setting.

Mode Select **Velocity**, **LVT**, **Level** or **Flow**. Press **✓** to store the setting.

Set Date Press **↑** or **↓** to scroll and select Month, Day and Year. Press **✓** to store the setting.

Set Time Press **↑** or **↓** to select the current time in Hours, Minutes and Seconds. Press **✓** to store the setting.

Interval Press **↑** or **↓** to select the logging interval. Press **✓** to store the setting.

Log **Stop**, **Start** or **Delete** the log file. Press **↑** or **↓** to **Delete** and **✓** to delete the log file. Press **↑** or **↓** to **Start** and **✓** to start the logger.

Note: You **MUST** delete old log and start a new log **AFTER** having set changes to **Log Site ID**, **Mode** and/or **Interval** for those changes to be applied to the log file.

View 24-hr formatted Reports on the MantaRay display. Press **←** from the MAIN display to view a formatted flow report from instruments with a built-in data logger. Press **←** to pan through **Level**, **Velocity** and **Flow** summaries. Press **↓** to scroll down one day or repeatedly to scroll to a specific date. Up to 365 days can be stored. Newest date will overwrite the oldest. Press **✓** to return to the main display.

RETRIEVE LOG FILE

Plug a USB Flash Memory Drive (not supplied by Greyline) into the USB output cable from the instrument. The instrument display will show the USB file download icon until the log file is transferred to the memory card and then display file download completed icon. The USB flash drive may be removed.

Download file names will appear in this format:

AVFM_ _00A.LOG
↑ ↑ ↑
MODEL TAG DOWNLOAD

Tag is set according to the `Log Site ID` entered in the instrument Data Logging menu.

Download letter will be A for the first download from an instrument. B for the second, then C etc. At the letter Z a - character will appear indicating that the maximum number of downloads for that instrument are on the USB flash drive. Older files can be erased or moved from the flash memory drive or a new memory drive can be used.

OPENING LOG FILES

Install Greyline Logger on your PC or laptop. Refer to the Help menu in the program for detailed instructions.

Select File/Open/Instrument Log (.log) to open the log file from your USB flash drive.

SPECIAL FUNCTIONS

```
--Special Functions--
▶Language      English
Analog Out    4-20mA
Backlight     High
Reset Totalizer NO
Negative Totals NO
Flo Direction Off
Cal Constant  1.000
Restore Defaults NO
New Password  0000
```

```
--Special Functions--
Language      English
▶Backlight    High
              Medium
              Low
              Key Hi/Lo
              Key High
              Key Med
              Key Low
              Off
```

- Language** Select English, French or Spanish
- Analog Out** Select 4-20mA, 0-5V or OFF mode for the analog output.
- Backlight** Select High, Medium or Low for continuous backlight.

 Select **Key Hi/Lo** for high backlight (for 1 minute) after a keypress and then **Lo** backlight until a key is pressed again.

 Select **Key High, Med** or **Low** for backlight after a keypress and then backlight off until a key is pressed again.
- Reset Totalizer** Press **▶** and select **Yes** to erase and restart the totalizer at zero.
- Negative Totals** Select **Yes** to have reverse flow readings deducted from the totalizer. Select **No** to totalize forward flow only and ignore reverse flow.
- Flo Direction** Select **On** to enable flow direction measurement. Select **Off** to disable flow direction measurement. Select **Invert** to invert the sense of the flow measurement.
- Cal Constant** Scales the velocity (& Flow) reading. Set to 1.000 for QZ02L sensor.
- Restore Defaults** Select **Yes** and press **✓** to erase all user settings and return the instrument to factory default settings.
- New Password** Select any number from **0000** to **9999** and press **✓**. Default setting of **0000** will allow direct access to the calibration menus. Setting of any password greater than **0000** will require the password to be entered to access the calibration menus.

Press **✓** to return to **Menu Selections**.

```
--Simulation-----  
▶Test      Actual  
Level      0.00in  
Velocity    10ft/s  
Flow       1982.88USG/m  
4-20mA Flow 20.00  
Relays 1 2
```

SIMULATION

Exercises the 4-20mA (0-5V) outputs, digital display and control relays.

Test Select **Maximum** and press ✓ to simulate maximum Flow, Level and Velocity and to output 20mA (5V) to the analog channels.

Select **Minimum** and press ✓ to simulate minimum Flow, Level and Velocity and to output 4mA (0V) to the analog channels.

To simulate an intermediate Flow, Level and Velocity set **Test** to **Actual** and then enter a value for the **Level** and **Velocity**. The Flow calculation, analog outputs and control relays will respond to the simulated values.

INSTALLATION - SENSOR LOCATION

1. Choose a sensor mounting location where silt or deposits are least likely to accumulate.
2. For best results flow should be evenly distributed across the channel and relatively free of turbulence. (The MantaRay is very effective at averaging level and velocity readings in turbulent conditions, but best accuracy and response time is achieved with evenly distributed flow.)
3. Avoid vertical drops, obstructions or elbows immediately up and downstream from the sensor. Locate the QZ02L sensor at least 10 times maximum Head (level) and 10 times the channel width from these flow disturbances.
4. The QZ02L submerged level-velocity sensor requires a minimum water level of 1 in. (25.4 mm).

QZ02L VELOCITY-LEVEL SENSOR MOUNTING

Mount the QZ02L sensor with the stainless steel bracket and hardware supplied. Ensure that the sensor is parallel to the water surface (check with a level). Mount with the tapered end of the sensor pointing upstream and the sensor cable pointing downstream.

Clip or tie wrap the sensor cable securely to the pipe or channel wall.

Note: The mounting bracket is designed to release the sensor if weeds or rags are caught by the sensor.

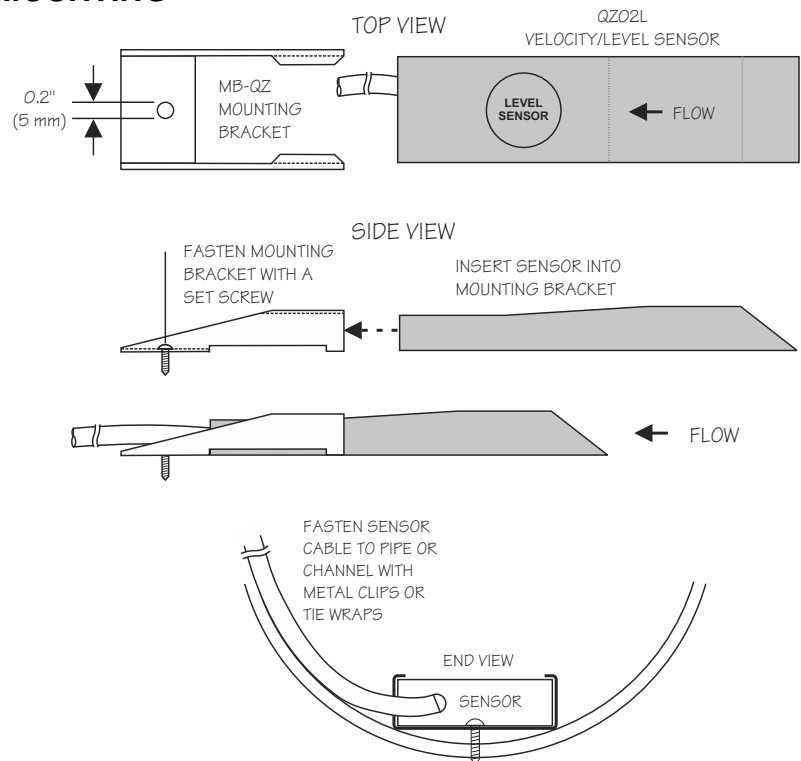

GOOD

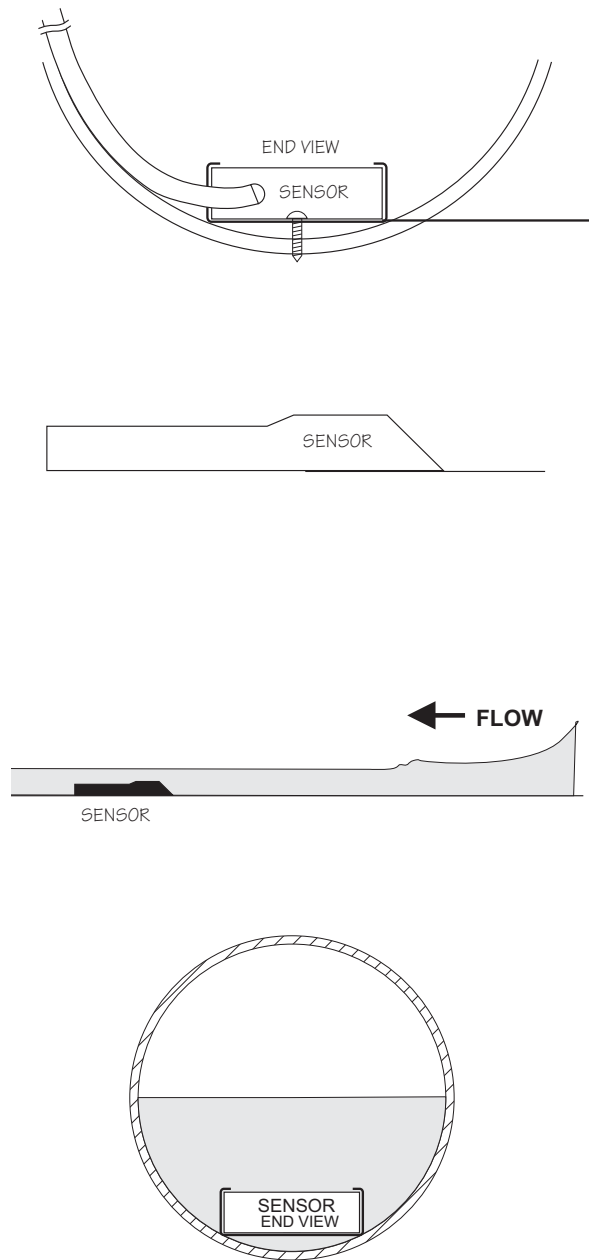

BAD

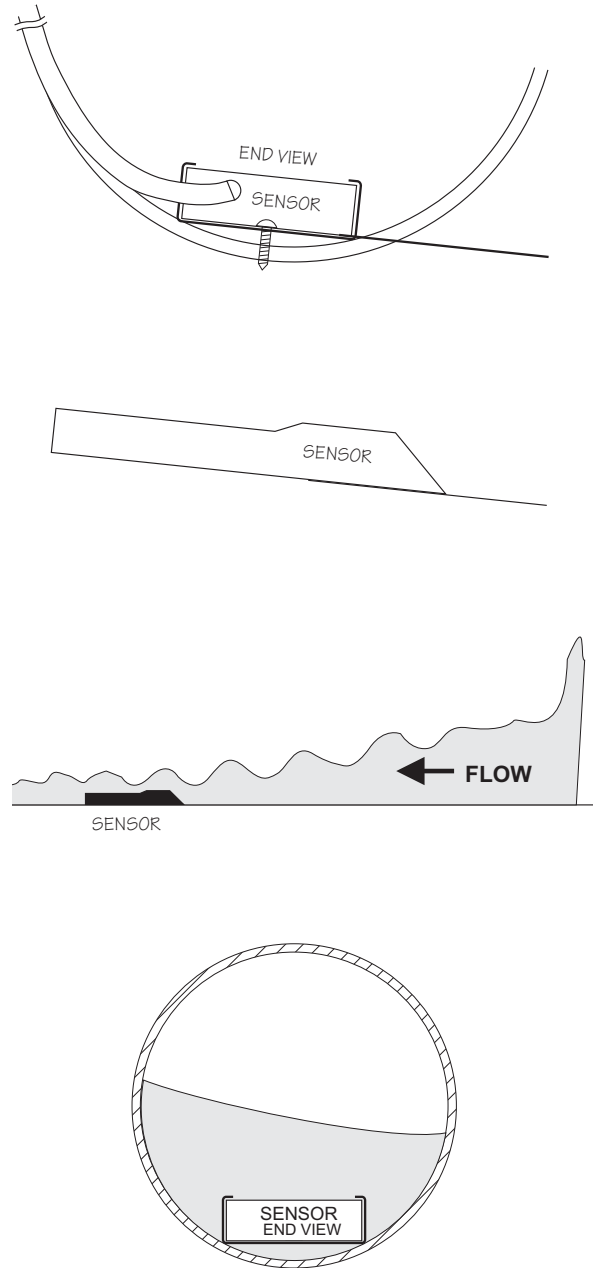

OPTIONAL PIPE BAND MOUNTING WITH QZ02L SENSOR

Install the stainless steel pipe band with the sensor mounting bracket at the invert (bottom) of the pipe. Ensure that the sensor bracket is parallel to the water surface (check with a level). Mount so the tapered end of the sensor will point upstream and the sensor cable will point downstream. (Turn the 1/4" adjustment nut clockwise to expand the bracket and secure to the pipe wall by friction fit.)

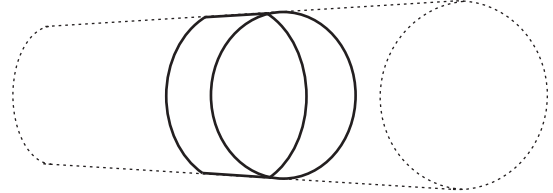

Insert the sensor into the mounting bracket and tie-wrap the sensor cable securely to the pipe band using the holes provided.

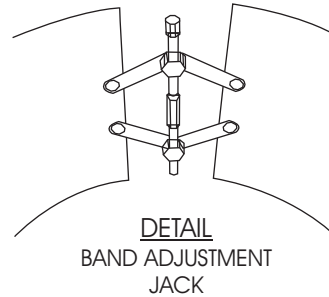
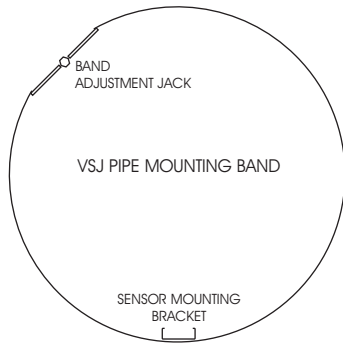

OPTIONAL QZ02L-DP VELOCITY SENSOR MOUNTING

Mount the velocity sensor at or near the bottom of the channel or pipe in a position where it will be continuously submerged. The QZ02L-DP velocity sensor does not have to be parallel to the water surface. Position where silt or solids will not build-up on the sensor.

CLEANING

Cleaning is not required as a part of normal maintenance.



MantaRay Portable Area-Velocity Flow Meter

APPLICATIONS HOTLINE

For applications assistance, advice or information on any Greyline Instrument contact your Sales Representative, write to Greyline or phone the Applications Hotline below:

United States:	Tel: 315-788-9500	Fax: 315-764-0419
Canada:	Tel: 613-938-8956	Fax: 613-938-4857
Toll Free:	888-473-9546	
Email:	info@greyline.com	
Web Site:	www.greyline.com	

Greyline Instruments Inc.

Canada
16456 Sixsmith Drive
Long Sault, Ont. K0C 1P0

USA:
105 Water Street
Massena, NY 13662

PRODUCT RETURN PROCEDURE

Instruments may be returned to Greyline for service or warranty repair.

1 Obtain an RMA Number from Greyline -

Before shipping a product to the factory please contact Greyline by telephone, fax or email to obtain an RMA number (Returned Merchandise Authorization). This ensures fast service and correct billing or credit.

When you contact Greyline please have the following information available:

1. Model number / Software Version
2. Serial number
3. Date of Purchase
4. Reason for return (description of fault or modification required)
5. Your name, company name, address and phone number

2 Clean the Sensor/Product -

Important: unclean products will not be serviced and will be returned to the sender at their expense.

1. Rinse sensor and cable to remove debris.
2. If the sensor has been exposed to sewage, immerse both sensor and cable in a solution of 1 part household bleach (Javex, Clorox etc.) to 20 parts water for 5 minutes. Important: do not immerse open end of sensor cable.
3. Dry with paper towels and pack sensor and cable in a sealed plastic bag.
4. Wipe the outside of the enclosure to remove dirt or deposits.
5. Return to Greyline for service.

3 Ship to Greyline -

After obtaining an RMA number please ship the product to the appropriate address below:

Canadian and International
Customers:

Greyline Instruments Inc.
16456 Sixsmith Drive
Long Sault, Ont. K0C 1P0

RMA#

USA
Customers:

Greyline Instruments Inc.
204 150th Avenue
Madeira Beach, FL 33708

RMA#

AREA-VELOCITY FLOW DATA SHEET

<p>Greyline Instruments Inc. 16456 Sixsmith Dr., Long Sault, Ont. K0C 1P0 Tel: 613-938-8956 / Fax: 613-938-4857 105 Water Street, Massena NY 13662 Tel: 315-788-9500 / Fax: 315-764-0419</p>	<p><i>Please complete and return this form to Greyline. It is important. We use this information to check our database for performance of Greyline flow meters in similar applications, and to provide advice and recommendations to you. Thanks for your cooperation.</i></p>
<p>Contact: _____ Title/Dept.: _____ Company: _____ Project: _____ Address: _____ Tel: _____ Fax: _____</p>	
<p>SENSOR: Model/Type: _____ Cable Length: _____ Elec. Class: _____ Type of Pump: _____ Distance from nearest Pump, Controlling Valve, Orifice or open Discharge: _____</p>	
<p>INSTRUMENT: Model/Type: _____ Power Input: _____ Calibrated Range: _____ Indication: _____ Operating Temp.: _____ Alarm: _____ Enclosure Class: _____ Pulse/Unit: _____ Elec. Class: _____ Output: _____</p>	
<p>SERVICE CONDITIONS: Pipe ID: _____ <input type="checkbox"/> Vertical <input type="checkbox"/> Horizontal Pipe Mat'l: _____ % Solids: _____ Fluid: _____ Material Build-up: _____ Oper. Flow: _____ Vibration: _____ Max. Flow: _____ Max. Pressure: _____ Min. Flow: _____ Max. Temp: _____</p>	
<p>Notes / Sketch Pipe Run:</p>	
<p>By: _____ Date: _____</p>	

LIMITED WARRANTY

Greyline Instruments warrants, to the original purchaser, its products to be free from defects in material and workmanship for a period of one year from date of invoice. Greyline will replace or repair, free of charge, any Greyline product if it has been proven to be defective within the warranty period. This warranty does not cover any expenses incurred in the removal and re-installation of the product.

If a product manufactured by Greyline should prove defective within the first year, return it freight prepaid to Greyline Instruments along with a copy of your invoice.

This warranty does not cover damages due to improper installation or handling, acts of nature, or unauthorized service. Modifications to or tampering with any part shall void this warranty. This warranty does not cover any equipment used in connection with the product or consequential damages due to a defect in the product.

All implied warranties are limited to the duration of this warranty. This is the complete warranty by Greyline and no other warranty is valid against Greyline. Some states do not allow limitations on how long an implied warranty lasts or limitation of incidental or consequential damages, so the above limitations or exclusions may not apply to you.

This warranty gives you specific legal rights, and you may also have other rights which vary from state to state.

Greyline Instruments Inc.

SS PIPE MOUNTING BAND – OPTION VSJ

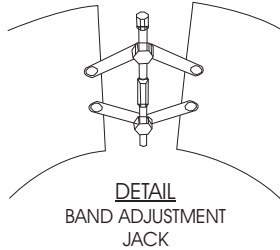

Use optional VSJ stainless steel Pipe Mounting Bands for easy Sensor installation in round pipes.

Each Pipe Band includes:

- ✎ Band Adjustment Jack allowing $\pm 0.5"$ (13 mm) adjustment from the nominal band size
- ✎ Stainless steel bracket for Sensor mounting
- ✎ Pre-drilled for tie wraps (included) to secure Sensor cable

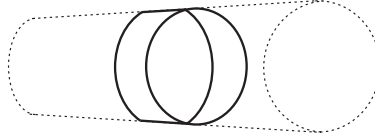
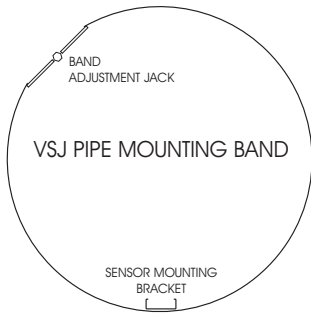

CODE BAND SIZE

VSJ6	6"/150 mm ID pipes
VSJ8	8"/200 mm ID pipes
VSJ10	10"/250 mm ID pipes
VSJ12	12"/300 mm ID pipes
VSJ14	14"/350 mm ID pipes
VSJ15	15"/375 mm ID pipes
VSJ16	16"/400 mm ID pipes
VSJ18	18"/450 mm ID pipes
VSJ20	20"/500 mm ID pipes
VSJ24	24"/600 mm ID pipes
VSJ30	30"/750 mm ID pipes

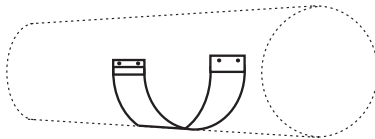
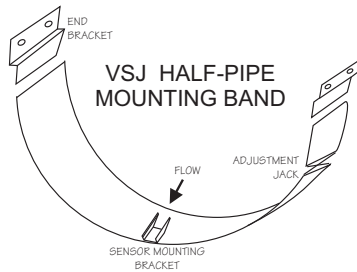

VSJ32-40	32-40" / 800-1000 mm ID pipes
VSJ42-54	42-54" / 1100-1375 mm ID pipes
VSJ56-72	56-72" / 1400-1800 mm ID pipes

Mounting Instructions:

Install the stainless steel pipe band with the sensor mounting bracket at the invert (bottom) of the pipe. Ensure that the sensor bracket is parallel to the water surface (check with a level). Mount so the tapered end of the sensor will point upstream and the sensor cable will point downstream. Turn the $\frac{1}{4}"$ adjusting nut clockwise to expand the bracket and secure to the pipe wall by friction fit.

Insert the sensor into the mounting bracket and tie wrap the sensor cable securely to the stainless steel pipe band.

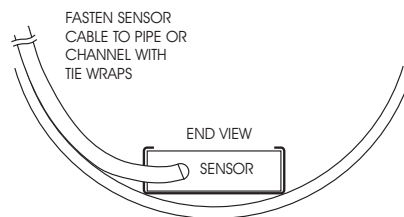

BREAK-OUT BOX

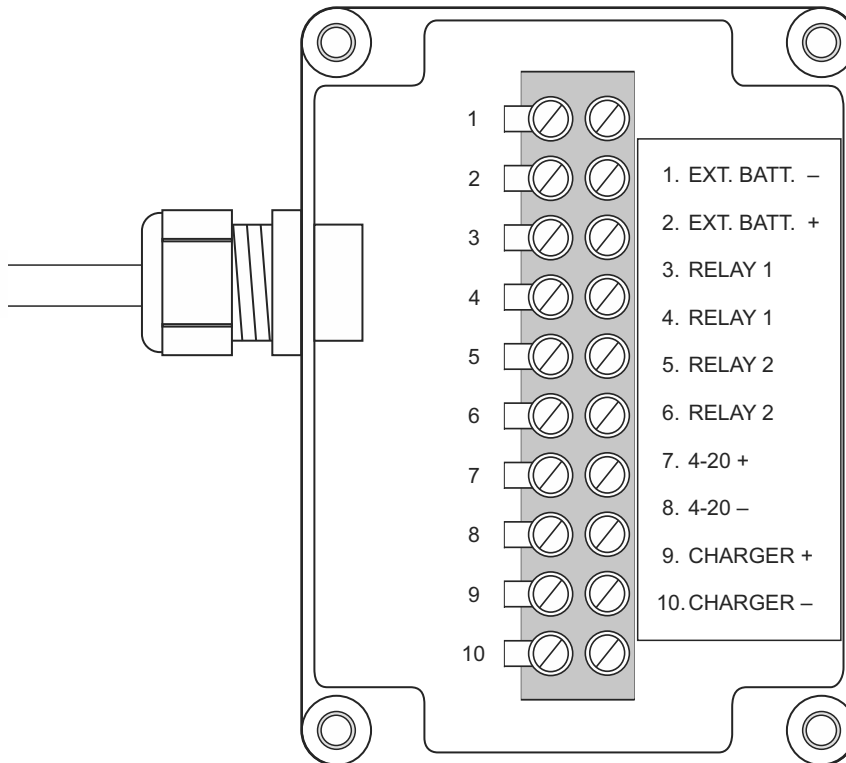

**NEMA 4X / IP66
DUST TIGHT / SPLASH PROOF**

SPECIFICATIONS

Channel Types:	Round pipe, Rectangular, trapezoid, egg or custom shapes
Electronics Enclosure:	Watertight, airtight, dust proof (IP 67) polycarbonate
Operating Temp. (Electronics):	-5° to 140°F (-20° to 60°C)
Accuracy:	Level: ±0.25% of Range. Velocity: ±2% of Reading. Repeatability and Linearity: ±0.1%
Display:	White, backlit matrix - displays flow rate, totalizer, relay states, operating mode and calibration menu
Programming:	built-in 5-key calibrator with English, French or Spanish language selection
Battery:	internal rechargeable NiMH, 12VDC, 10,000 mAh
Battery Charger:	4.2A (70W Max), 100-240VAC 50/60Hz input, UL and CE listed
Outputs/Communications:	4-20mA, 500 ohm or 0-5VDC (100 mA) by menu selection 2 solid-state Relays, 32V AC/DC max., rated 400mA; programmable for flow proportional pulse (sampler/totalizer), flow and/or level alarm
Breakout Box:	Connections for charger input, external battery input, 2 relays, 4-20mA (0-5V)
Electrical Surge Protection:	Sensor, 4-20mA outputs and AC power input
Data Logger:	Programmable 2-million point data capacity, time and date stamped plus formatted flow reports including Total, Average, Minimum, Maximum and times of occurrence. Includes USB output to Flash Drives
Logger Intervals:	programmable 10, 30 sec, 1, 2, 5, 10, 15, 30, 60 min
Software:	Greyline Logger for Windows. Graph and data table presentation, level/velocity to flow conversion, exports data to Excel™, exports graphs
Approximate Shipping Weight:	15 lbs. (6.8 kg)

Velocity/Level Sensor QZ02L

Velocity Measurement Range:	0.1 to 10 ft/sec (0.03 to 3.05 m/sec)
Level Measurement Range:	Minimum Head: 1 in (25.4 mm). Maximum Head: 15 ft. (4.5 m)
Operating Temperature:	5 to 150°F (-15 to 65°C)
Exposed Materials:	PVC, polyurethane, epoxy
Sensor Cable:	25 ft. (7.6 m) submersible polyurethane jacket, shielded, 3 coaxial
Sensor Mounting:	includes MB-QZ stainless steel mounting bracket
Temperature Compensation:	Automatic, continuous

