

Electrically Actuated Wafer Butterfly Valve Type 145



General

- **Size:** 2"–12"
- **Outer Body:** Glass-filled PP
- **Material:** PVC, CPVC, PROGEF® Standard PP, ABS, SYGEF® Standard PVDF
- **Seals:** EPDM, FPM, PTFE/FPM
- **Stem:** 316 stainless steel
- **Voltage:** 100-230VAC, 24VAC/DC
- **Connection:** Both ANSI 150 and DIN 2501
- **Actuator Housing:** Glass-filled PP
- **Manual Override:** Integrated
- **End Stops:** Open, close, programmable middle position
- **Position Indicator:** LED, optical, integrated
- **Position Feedback:** Open, close, middle
- **Heater:** 10 position adjustable

Specification

The Type 145 Electrically Actuated Butterfly Valve shall be wafer style compatible with both ANSI B16.5 150 lb and DIN 2501 flange patterns. The disk operation shall utilize double eccentric design principles. The shaft shall be non-wetted by a bushing assembly with double O-ring seals and fixed at both ends. The face seal shall be a Q-ring compatible with flat and serrated flange adapters. The face, disk and shaft seals shall operate independently. The wetted body and disk shall be of like materials. Valves shall be rated for bidirectional use. The operator mounting flange shall comply with ISO standards. All valves shall be tested in accordance to ISO9393 and designed to ISO16136 standards. All valves shall be manufactured under ISO9001 for Quality and ISO14001 for Environmental Management. Following assembly, every valve shall be tested and certified bubble tight exceeding Class VI standards.

Material Specification

PVC valves shall meet ASTM D1784 cell classification 12454 standards. CPVC valves shall meet ASTM D1784 cell classification 23447-B standards. PP valves shall meet ASTM D5847-14 cell classification PP0510B66851 standards. ABS valves shall meet ASTM D3965 cell classification 42222 standards. PVDF valves shall be type 1, grade 2 according to ASTM D3222 standards. Valves of all materials shall be RoHS compliant.

Key Valve Certifications

- **NSF 61:** PVC and CPVC
- **FDA CFR 21 177.1520:** PP and PVDF
- **FDA CFR 21 177.2600:** EPDM and FPM
- **FDA CFR 21 177.1550:** PTFE
- **ABS:** All materials
- **USP Class VI (physiological non-toxic):** EPDM, FPM, PTFE, PP and PVDF

Components

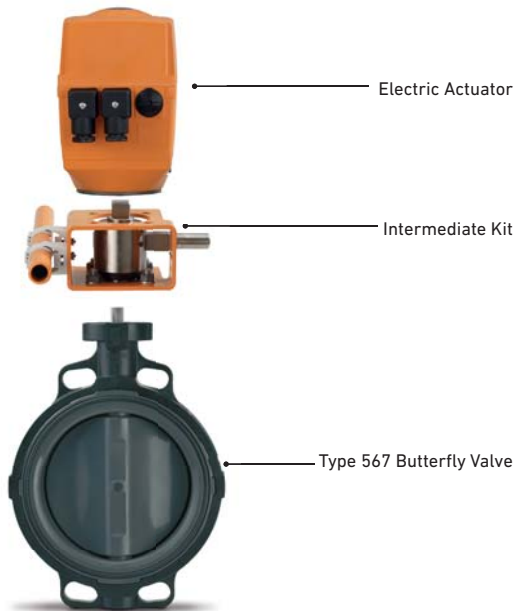

Optional Features

- **Positioner:** Current, voltage
- **Network:** Profibus DP
- **Fail Safe Return:** Battery back up, externally powered board
- **Smart Module:** Cycle monitoring, cycle counter, cycle extension, motor current monitoring
- **Manual Loading Station:** Local control box
- **Protection Class:** IP67 with conduit connection
- **Stem Extension:** Two piece stainless steel
- **Shaft:** Titanium, Hastelloy-C
- **Hardware:** Alternatives available upon request
- **Cleaned:** Silicone free/oil free

Actuator Certifications/Compliance

- **Machinery Directive 2006/42/EC, Annex II B**
- **EMV Directive CE 2004/108/CE**
- **EMV VDE 0843 Section 20**
- **Low Voltage Directive CE 2006/95/CE**
- **Vibration Testing EN 60068-2-6**
- **Interface ISO 5211**
- **Actuators for Industrial Valves EN 15714-2**

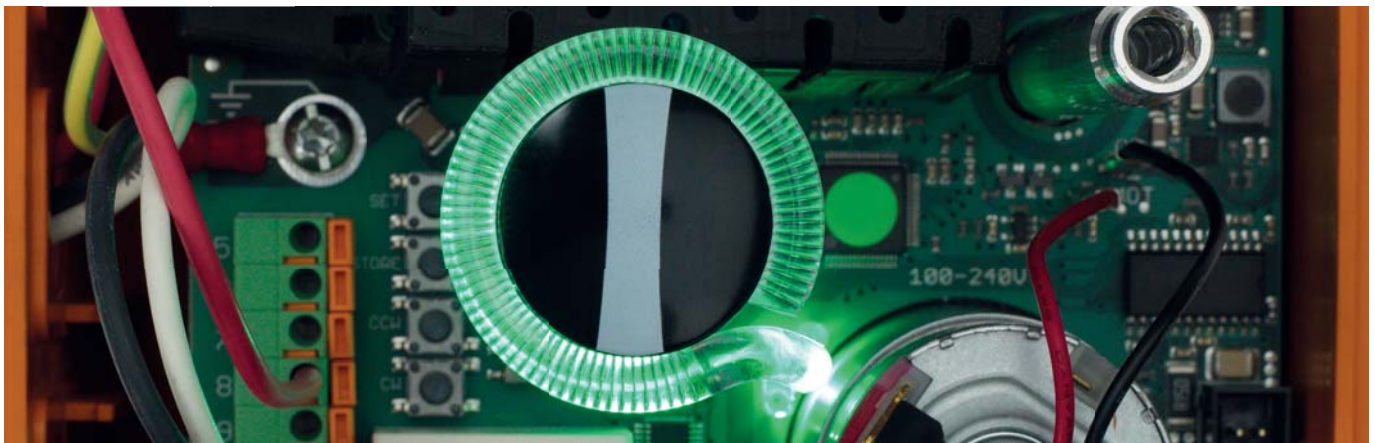

Actuator Technical Data

	EA 45	EA 120	EA 250
Valve Size	2"-2½"	3"-8"	10"-12"
Cycle Time	6s/90°	15s/90°	20s/90°
Rated Cycles at 70°F	100,000	100,000	75,000
Actuating Angle	Standard set at 90°, max. 355°		
Housing Material	Glass-filled PP		
Position Feedback	230V, 6 Amp		
Emergency Manual Override	Integrated		
Rated Voltage	100- 230V, 50/60 Hz 24V, AC/DC, 50/60Hz		
Rated Voltage Tolerance	+/- 15%		
Rated Output	55VA @ 100-230VAC 60VA @ 24VAC/DC	50VA @ 100-230VAC 55VA @ 24VAC/DC	60VA @ 100-230VAC 65VA @ 24VAC/DC
Duty Cycle	50%	50%	35%
Protection Class	IP 65 per EN 60529 (3) UL/CSA: For interior use Nema 4X		
Overload Protection	Resetting, current-time dependant (1)		
Overvoltage Category	Category II according to DIN EN 61010-1		
Power Connection	Connector plug 3 P+ E per DIN EN 175301-03		
Pollution Grade	Grade 2 according to DIN EN 61010-1		
Maximum Elevation	6561 feet		
Ambient Temperature	14° to 122°F (2)		
Allowable Humidity	90% relative humidity, non condensing		

(1) Overload protection of the motor is dimensioned so that the motor and the power supply board are protected. As soon as the load is within the torque range, the actuator will begin operating again.

(2) At temperatures below 14°F and if there is condensation, the heating element should be activated.

(3) Protection class IP67 for use of cable glands and vertical installation.

Technical Data

Flow

The following information is based on water applications at 68° F

Cv Value

Size (inch)	d (mm)	Cv (gal/min)
2	63	103
2½	75	154
3	90	210
4	110	455
5	140	805
6	160	1162
8	225	2772
10	280	3570
12	315	5110

Flow Characteristics

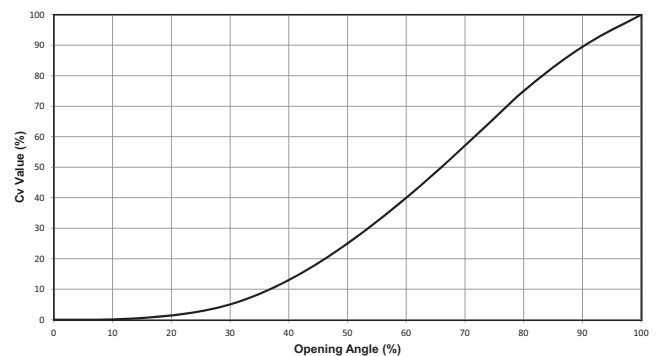

Technical Data

Pressure Temperature Curves

The following graphs are based on a 25 year lifetime water or similar media application

PVC

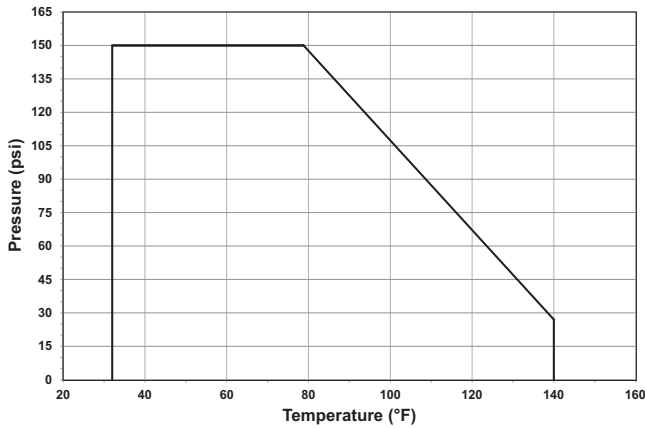

CPVC

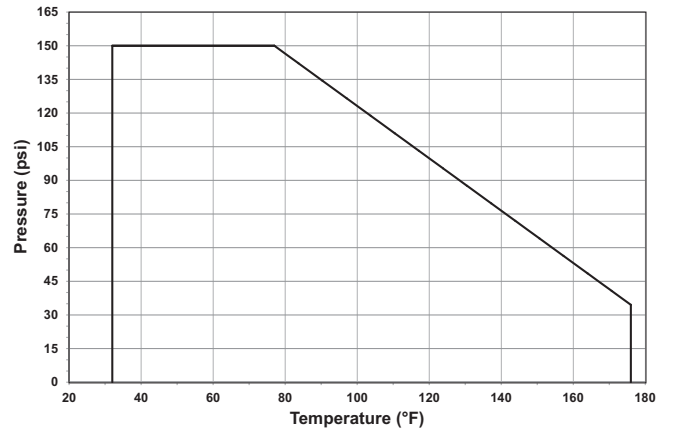

PP

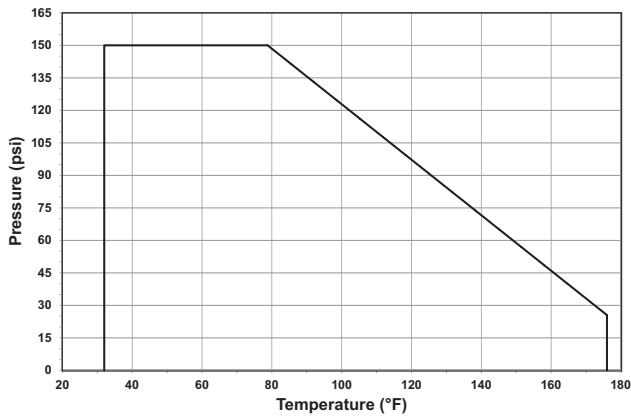

ABS

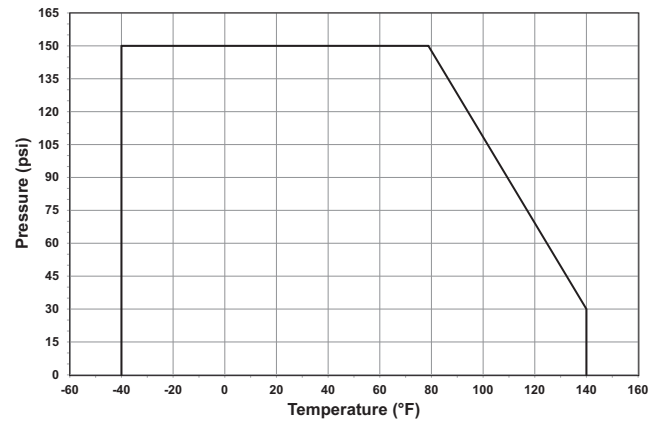

PVDF

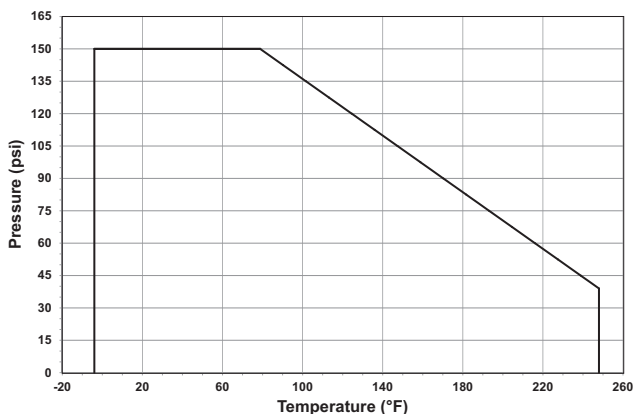

Pressure-Temperature

Material	Temperature Range (°F)	Max Pressure (psi)
PVC	32 to 140	150
CPVC	32 to 176	150
PP	32 to 176	150
ABS	-40 to 140	150
PVDF	-4 to 284	150

Vacuum Service

The Type 145 is rated for full vacuum service. Maximum differential pressure of 15psi at 122°F.

Dimensions

The following tables are shown in inches unless otherwise specified

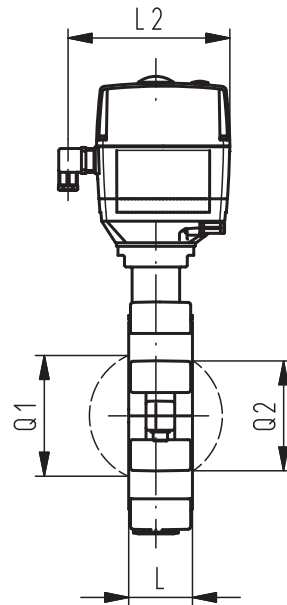
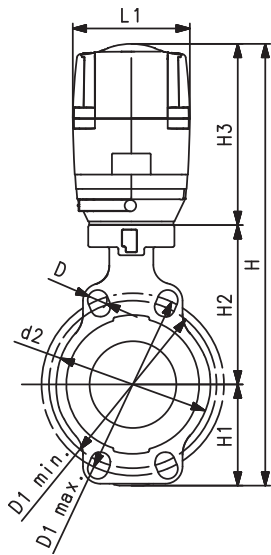

All Materials without Manual Override

inch	d2	D	D1	H	H1	H2	H3	L	L1	L2	L3	Q1	Q2
2	6.3	0.75	4.75	15.71	3.03	5.28	7.4	1.77	4.8	7.09	6.5	1.57	-
2½	7.09	0.75	5.5	16.18	3.27	5.51	7.4	1.81	4.8	7.09	7.17	2.13	1.38
3	7.68	0.75	6	16.65	3.5	5.75	7.4	1.93	4.8	7.09	8.27	2.64	1.97
4	8.9	0.75	7.5	18.15	4.17	6.57	7.4	2.2	4.8	7.09	9.45	3.46	2.91
5	10.16	0.9	8.5	19.29	4.76	7.13	7.4	2.52	4.8	7.09	10.71	4.45	3.82
6	11.18	0.9	9.5	20.08	5.24	7.44	7.4	2.83	4.8	7.09	11.81	5.47	4.84
8	13.43	0.9	11.75	22.72	6.26	8.27	8.19	2.87	4.8	7.09	14.17	7.01	6.65
10	16.22	1.0	14.25	26.65	8.07	10.39	8.19	4.45	4.8	7.09	17.32	8.27	8.15
12	18.98	1.0	17	28.62	9.21	11.22	8.19	4.45	4.8	7.09	20.08	10.08	9.96

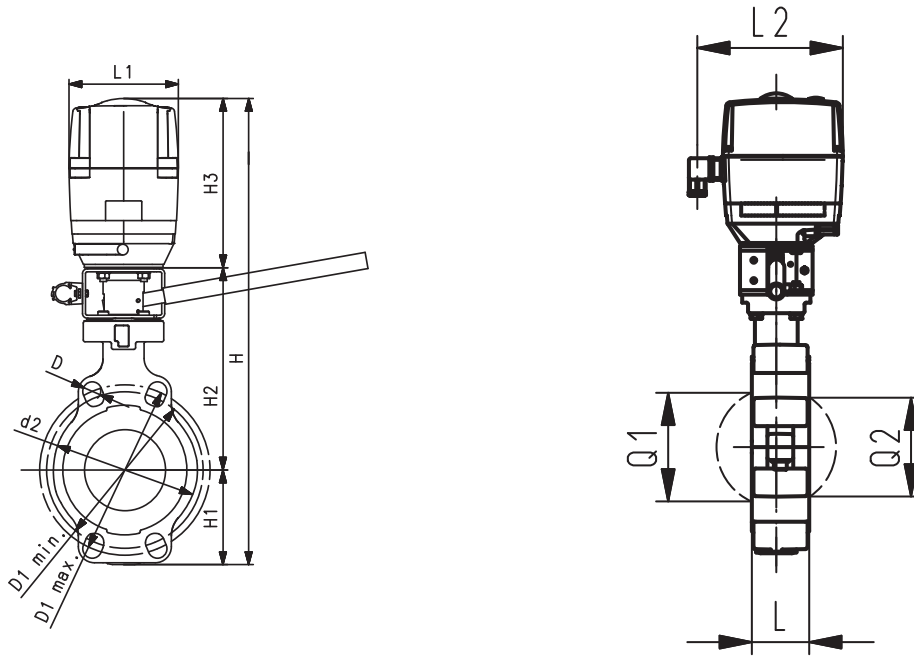

All Materials with Manual Override

inch	d2	D	D1	H	H1	H2	H3	H4	L	L1	L2	L3	L4	Q1	Q2
2	6.3	0.75	4.75	15.71	3.03	5.28	7.4	2.36	1.77	4.8	7.09	6.5	7.87	1.57	-
2½	7.09	0.75	5.5	16.18	3.27	5.51	7.4	2.36	1.81	4.8	7.09	7.17	7.87	2.13	1.38
3	7.68	0.75	6	16.65	3.5	5.75	7.4	2.36	1.93	4.8	7.09	8.27	7.87	2.64	1.97
4	8.9	0.75	7.5	18.15	4.17	6.57	7.4	2.36	2.2	4.8	7.09	9.45	9.84	3.46	2.91
5	10.16	0.9	8.5	19.29	4.76	7.13	7.4	2.36	2.52	4.8	7.09	10.71	9.84	4.45	3.82
6	11.18	0.9	9.5	20.08	5.24	7.44	7.4	2.36	2.83	4.8	7.09	11.81	9.84	5.47	4.84
8	13.43	0.9	11.75	22.72	6.26	8.27	8.19	2.36	2.87	4.8	7.09	14.17	9.84	7.01	6.65

GF Piping Systems

Tel. (714) 731-8800, Toll Free (800) 854-4090, Fax (714) 731-6201

us.ps@georgfischer.com, www.gfpiping.com

