

PanaFlow Z3

User's Manual



PanaFlow Z3

Panametrics Ultrasonic Flowmeter for Liquids

User's Manual

910-311 Rev. A
February 2014



www.ge-mcs.com

©2014 General Electric Company. All rights reserved.
Technical content subject to change without notice.

[no content intended for this page]

Chapter 1. Introduction

1.1 Overview..... 1
 1.2 Theory of Operation..... 2
 1.2.1 Transit-Time Flow Measurement..... 2

Chapter 2. Installation

2.1 Introduction..... 3
 2.2 Unpacking the PanaFlow Z3 System..... 4
 2.2.1 Identification..... 4
 2.2.2 Lifting the PanaFlow Z3 System..... 5
 2.3 Site Considerations..... 6
 2.3.1 Meter Body Location..... 6
 2.4 Making Electrical Connections..... 7
 2.4.1 Preparing for Wiring..... 8
 2.4.2 Wiring Analog Outputs..... 9
 2.4.3 Wiring Digital Outputs..... 10
 2.4.4 Wiring the Modbus/Service Port..... 15
 2.4.5 Wiring the Calibration Port..... 16
 2.4.6 Wiring the Line Power..... 17

Chapter 3. Initial Setup and Programming

3.1 Introduction..... 19
 3.2 PanaFlow Z3 Enclosure Magnetic Keypad..... 20
 3.3 Display Programming..... 22
 3.3.1 Changing Value for One- or Two-Variable Screens..... 22
 3.3.2 Changing Measurement Type for One or Two-Variable Screens..... 23
 3.3.3 Changing Measurement Type or Value for Totalizer Screens..... 26
 3.3.4 Starting or Stopping Totalizer Measurement..... 28
 3.3.5 Resetting the Totalizer..... 28
 3.4 Entering the Main Menu (Lock Button)..... 29
 3.4.1 Display Format..... 30
 3.4.2 Keypad Lockout..... 30
 3.4.3 Program/Program Review..... 31
 3.4.4 Program..... 32
 3.5 User Preferences..... 33
 3.5.1 Settings..... 34
 3.5.2 Flow Units..... 36
 3.5.3 Meter Setup..... 40
 3.5.4 Password..... 42
 3.5.5 Display..... 43

3.6	Input/Output.....	44
3.6.1	Analog Output A.....	44
3.6.2	Analog Output B.....	47
3.6.3	Programming Digital Outputs.....	50
3.6.4	Modbus/Service Port A.....	62
3.7	Test Menu.....	65
3.7.1	Accessing the Test Menu.....	65
3.7.2	Testing the Min/Max Output.....	66
3.7.3	Testing the Output Analog Switch.....	66
3.7.4	Viewing the On Board Temperature.....	66
3.7.5	Performing a Watchdog Test.....	66

Chapter 4. Error Codes and Troubleshooting

4.1	User Restrictions.....	67
4.2	Error Display in the User Interface.....	67
4.2.1	Error Header.....	67
4.2.2	Communication Error String.....	68
4.2.3	Flow Error String.....	68
4.2.4	System Error String.....	70
4.3	Diagnostics.....	70
4.3.1	Introduction.....	70
4.3.2	Meter Body Problems.....	71

Appendix A. Specifications

A.1	Operation and Performance.....	73
A.2	Meter Body/Transducer.....	74
A.3	Electronics.....	75

Appendix B. Menu Maps

Appendix C. Modbus Map

C.1	Frequently Used Modbus Addresses.....	87
C.2	User Group Definitions.....	88
C.3	Modbus Map.....	89
C.4	Modbus Unit Codes.....	111
C.5	Modbus Protocol.....	114

Appendix D. HART® Menu Maps

D.1	HART Connection.....	115
D.1.1	Wiring to the HART Circuit.....	115
D.1.2	Write Mode Switch.....	115
D.1.3	Use Force High with HART.....	116
D.2	Root Menu.....	116
D.3	HART Service Map for General Users.....	117
D.4	HART Service Menu for Service Users.....	118
D.5	Review Menu.....	119

Appendix E. Data Records

E.1 Service Record 121
 E.1.1 Data Entry 121
E.2 Initial Settings 123
E.3 Diagnostic Parameters 126

Appendix F. CE Mark Compliance

F.1 Introduction 127
F.2 Wiring 127

[no content intended for this page]

Information Paragraphs

Note: *These paragraphs provide information that provides a deeper understanding of the situation, but is not essential to the proper completion of the instructions.*

IMPORTANT: *These paragraphs provide information that emphasizes instructions that are essential to proper setup of the equipment. Failure to follow these instructions carefully may cause unreliable performance.*



CAUTION! These paragraphs provide information that alerts the operator to a hazardous situation that can cause damage to property or equipment.



WARNING! These paragraphs provide information that alerts the operator to a hazardous situation that can cause injury to personnel. Cautionary information is also included, when applicable.

Safety Issues



WARNING! It is the responsibility of the user to make sure all local, county, state and national codes, regulations, rules and laws related to safety and safe operating conditions are met for each installation.

Auxiliary Equipment

Local Safety Standards

The user must make sure that he operates all auxiliary equipment in accordance with local codes, standards, regulations, or laws applicable to safety.

Working Area



WARNING! Auxiliary equipment may have both manual and automatic modes of operation. As equipment can move suddenly and without warning, do not enter the work cell of this equipment during automatic operation, and do not enter the work envelope of this equipment during manual operation. If you do, serious injury can result.



WARNING! Make sure that power to the auxiliary equipment is turned OFF and locked out before you perform maintenance procedures on the equipment.

Qualification of Personnel

Make sure that all personnel have manufacturer-approved training applicable to the auxiliary equipment.

Personal Safety Equipment

Make sure that operators and maintenance personnel have all safety equipment applicable to the auxiliary equipment. Examples include safety glasses, protective headgear, safety shoes, etc.

Unauthorized Operation

Make sure that unauthorized personnel cannot gain access to the operation of the equipment.

Environmental Compliance

Waste Electrical and Electronic Equipment (WEEE) Directive

GE Measurement & Control is an active participant in Europe's *Waste Electrical and Electronic Equipment (WEEE)* take-back initiative, directive 2012/19/EU.

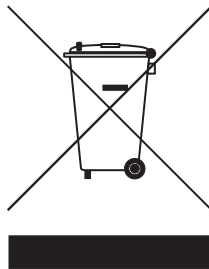

The equipment that you bought has required the extraction and use of natural resources for its production. It may contain hazardous substances that could impact health and the environment.

In order to avoid the dissemination of those substances in our environment and to diminish the pressure on the natural resources, we encourage you to use the appropriate take-back systems. Those systems will reuse or recycle most of the materials of your end life equipment in a sound way.

The crossed-out wheeled bin symbol invites you to use those systems.

If you need more information on the collection, reuse and recycling systems, please contact your local or regional waste administration.

Visit <http://www.ge-mcs.com/en/about-us/environmental-health-and-safety/1741-weee-reg.Z3ml> for take-back instructions and more information about this initiative.

Chapter 1. Introduction

1.1 Overview

Thank you for purchasing the PanaFlow Z3 ultrasonic flow meter. The PanaFlow Z3 represents the latest generation of Panametrics ultrasonic flow meters. It is a three-path meter designed specifically for dependable, accurate and repeatable measurement of process liquids. With a sleek industrial design and ultra-reliable electronics, it provides operators a cost effective top-of-the-line choice.

Unlike other flow measurement technologies, the PanaFlow Z3 does not require maintenance since it does not have any obstruction in the flow path that could clog the line, nor does it have any moving parts that could be damaged by the flowing fluid. Also, due to the inherent nature of our ultrasonic flow measurement, the PanaFlow Z3's measurement is not affected by changing process conditions (temperature, pressure, and conductivity) and does not drift over time that would require periodic calibration. With no periodic maintenance and calibration required, PanaFlow Z3 couples lower overall cost with superb reliability and performance.

The PanaFlow Z3 consists of the new XMT910 electronics, the LX transducers system, and a meter body (see *Figure 1* below).

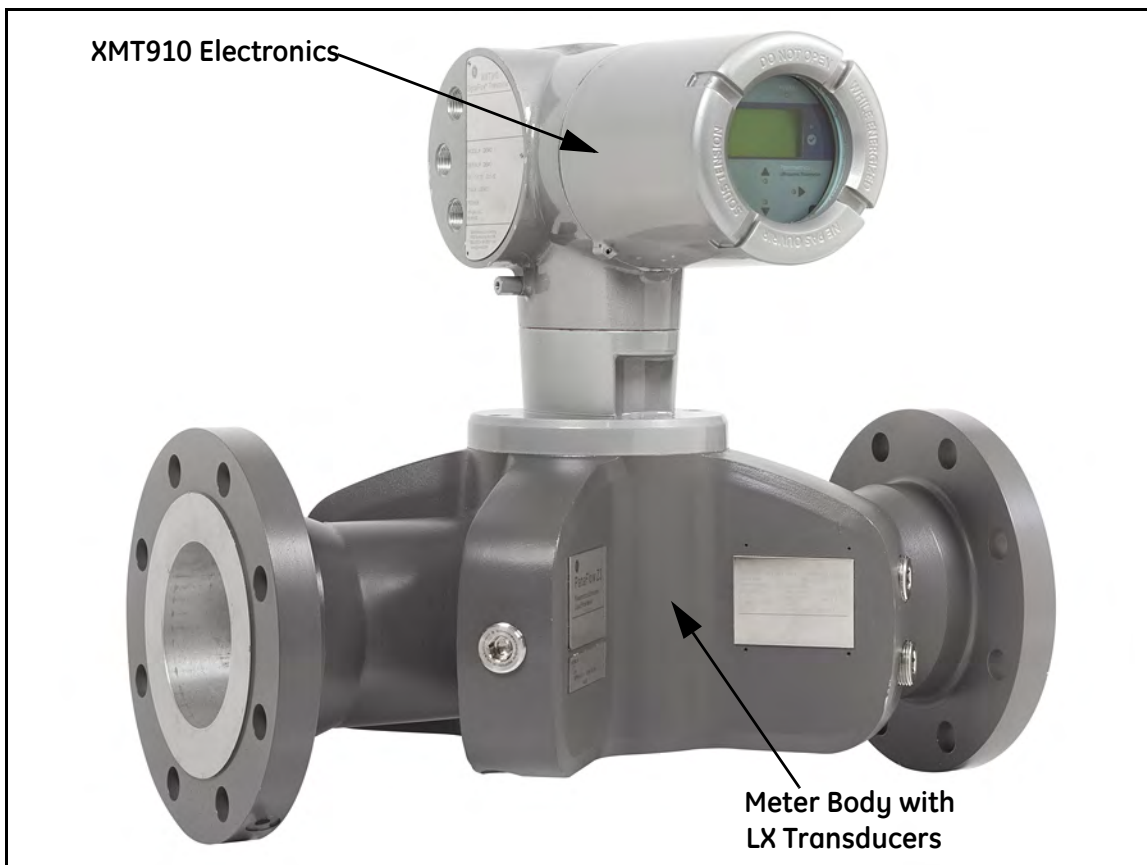

Figure 1: The PanaFlow Z3 Flowmeter

1.2 Theory of Operation

1.2.1 Transit-Time Flow Measurement

In this method, two transducers serve as both ultrasonic signal generators and receivers. They are in acoustic communication with each other, meaning the second transducer can receive ultrasonic signals transmitted by the first transducer and vice versa (see *Figure 2* below).

In operation, each transducer functions as a transmitter, generating a certain number of acoustic pulses, and then as a receiver for an identical number of pulses. The time interval between transmission and reception of the ultrasonic signals is measured in both directions. When the liquid in the pipe is not flowing, the transit-time downstream equals the transit-time upstream. When the liquid is flowing, the transit-time downstream is less than the transit-time upstream.

The difference between the downstream and upstream transit times is proportional to the velocity of the flowing liquid, and its sign indicates the direction of flow.

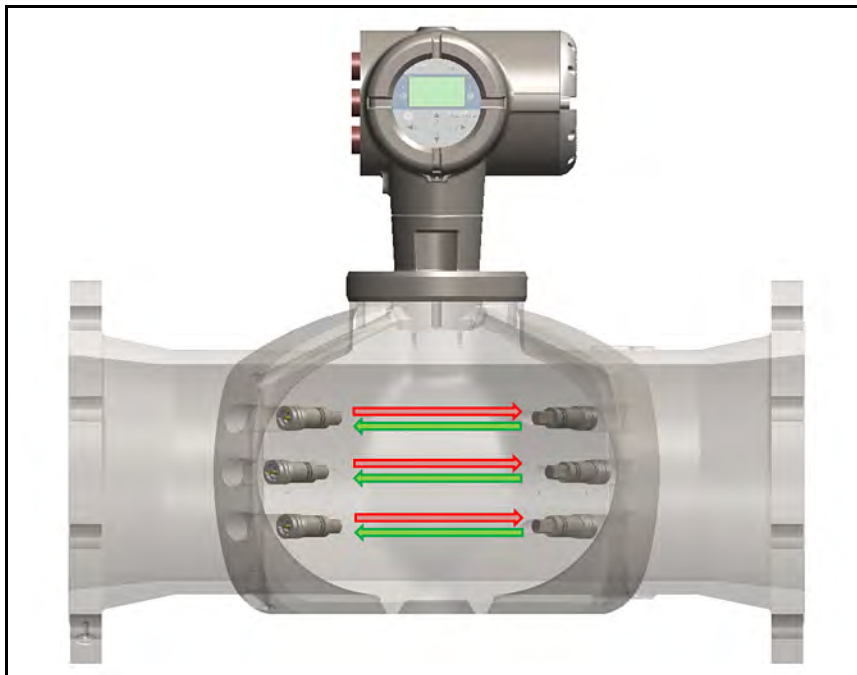

Figure 2: Flow and Transducer Paths

Chapter 2. Installation

2.1 Introduction

To ensure safe and reliable operation of the PanaFlow Z3, the system must be installed in accordance with the established guidelines. Those guidelines, explained in detail in this chapter, include the following topics:

- Unpacking the PanaFlow Z3 System (see *page 4*)
- Installing the Meter Body (see *page 5*)
- Site Considerations (see *page 6*)
- Making Electrical Connections (see *page 7*)



WARNING! The PanaFlow Z3 flow meter can measure the flow rate of many fluids, some potentially hazardous. The importance of proper safety practices cannot be overemphasized.



WARNING! Be sure to follow all applicable local safety codes and regulations for installing electrical equipment and working with hazardous fluids or flow conditions. Consult company safety personnel or local safety authorities to verify the safety of any procedure or practice.



Attention European Customers! To meet CE Mark requirements, all cables must be installed as described in Appendix F, *CE Mark Compliance*.

2.2 Unpacking the PanaFlow Z3 System

Before removing the PanaFlow Z3 system from the crate, please inspect the flow meter. Each instrument manufactured by GE Measurement & Control is warranted to be free from defects in material and workmanship. Before discarding any of the packing materials, account for all components and documentation listed on the packing slip. The discarding of an important item along with the packing materials is all too common. If anything is missing or damaged, contact GE Customer Care immediately for assistance.

2.2.1 Identification

The PanaFlow Z3 meter has up to three separate labels for identification, depending on configuration (see *Figure 3* and *Figure 4* below). The system is mounted as a single unit.

2.2.1a XMT910 Transmitter Identification

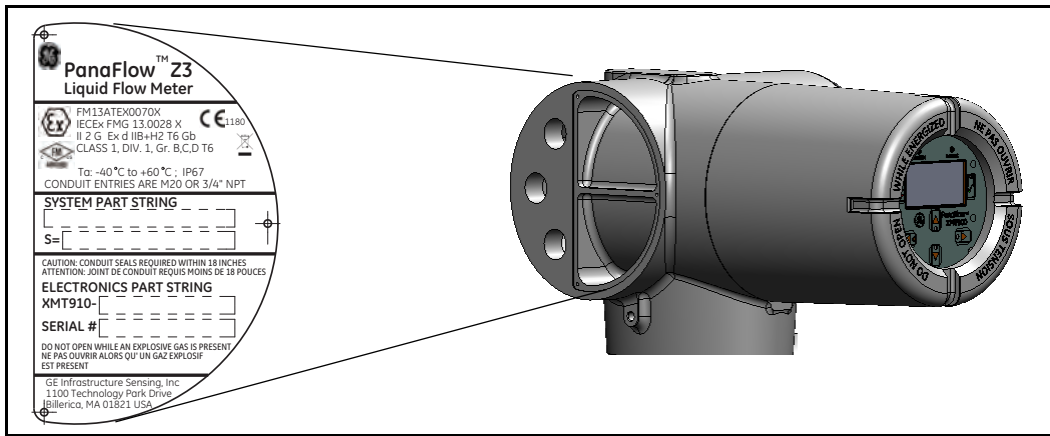

Figure 3: Typical XMT Transmitter Label

2.2.1b Meter Body Identification

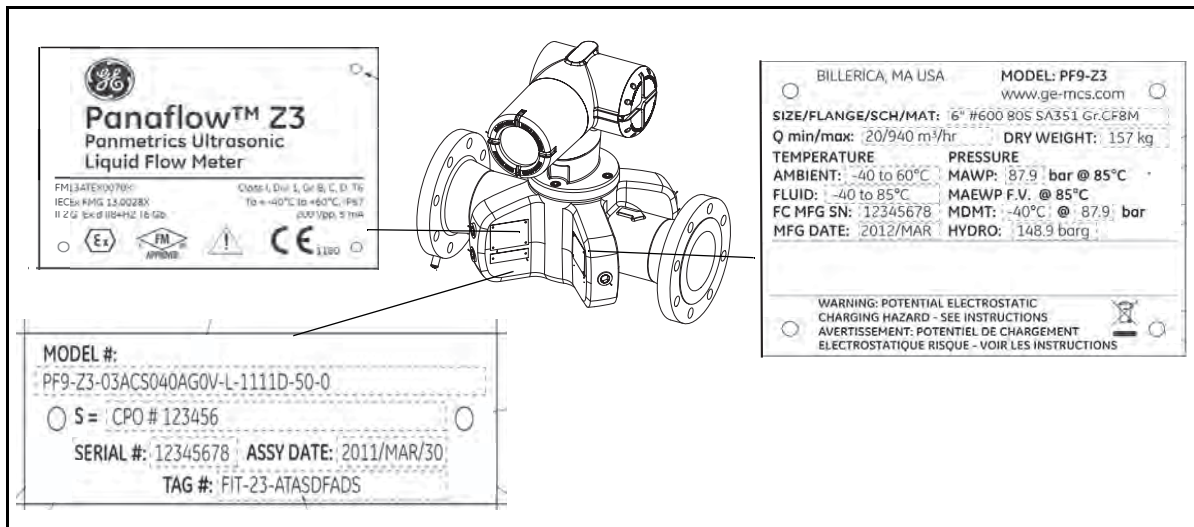

Figure 4: Typical Flowcell Identification

2.2.2 Lifting the PanaFlow Z3 System

Figure 5 below indicates the proper way to attach the lifting straps to the flow meter.



WARNING! This is the only approved way to lift the flow meter into position in the pipeline.



Figure 5: Lifting the PanaFlow Z3 System

2.3 Site Considerations

Because the relative location of the meter body and the electronics enclosure is important, use the guidelines in this section to plan the PanaFlow Z3 installation.

2.3.1 Meter Body Location

Ideally, choose a section of pipe with unlimited access; for example, a long stretch of pipe that is above ground. However, if the meter body is to be mounted on an underground pipe, dig a pit around the pipe to facilitate installation or removal of the transducers.

2.3.1a Transducer Location

For a given fluid and pipe, the PanaFlow Z3's accuracy depends on the location and alignment of the transducers. In addition to accessibility, when planning meter location, adhere to the following guidelines:

- Locate the meter body so that there are at least 10 pipe diameters of straight, undisturbed flow upstream and 5 pipe diameters of straight, undisturbed flow downstream from the measurement point (see *Figure 6* below). Undisturbed flow means avoiding sources of turbulence in the fluid such as valves, flanges, expansions, and elbows; avoiding swirl; and avoiding cavitation.

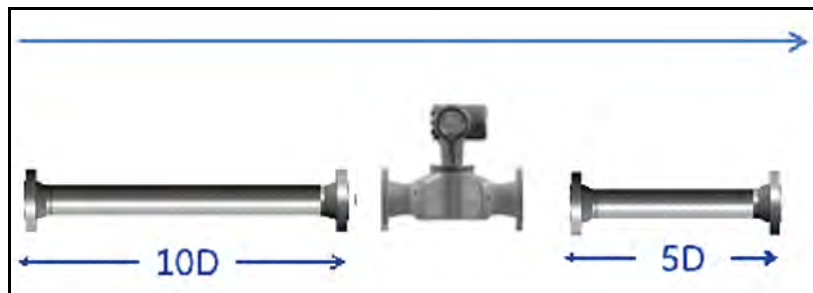

Figure 6: Flow Direction

- Locate the transducers on a common axial plane along the pipe (see *Figure 7* below). Locate the transducers on the side of the pipe, rather than the top or bottom, since the top of the pipe tends to accumulate gas and the bottom tends to accumulate sediment. Either condition will cause increased attenuation of the ultrasonic signal. There is no similar restriction with vertical pipes as long as the flow of fluids is upward to prevent free falling of fluids or a less than full pipe.

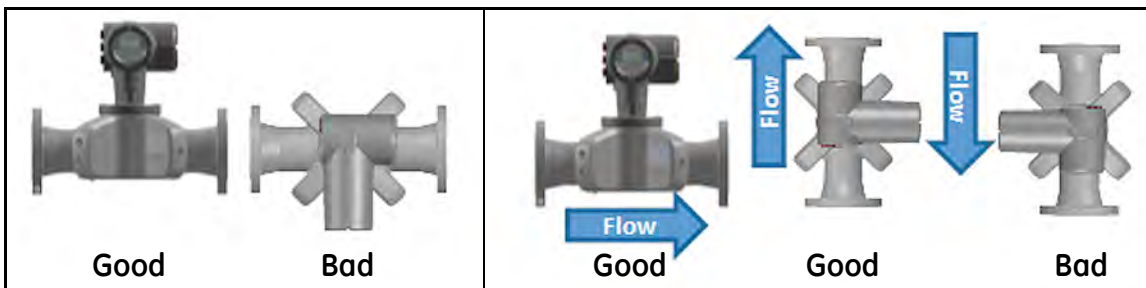

Figure 7: Good and Bad Transducer Locations



CAUTION! If insulating the meter body, the maximum process temperature is 80°C and maximum ambient temperature is 50°C.

2.4 Making Electrical Connections

This section contains instructions for making all the necessary electrical connections to the XMT910 flow transmitter. Refer to *Figure 8* below for a complete wiring diagram.



WARNING! To meet CE Mark requirements, all cables must be installed as described in Appendix F, *CE Mark Compliance*.

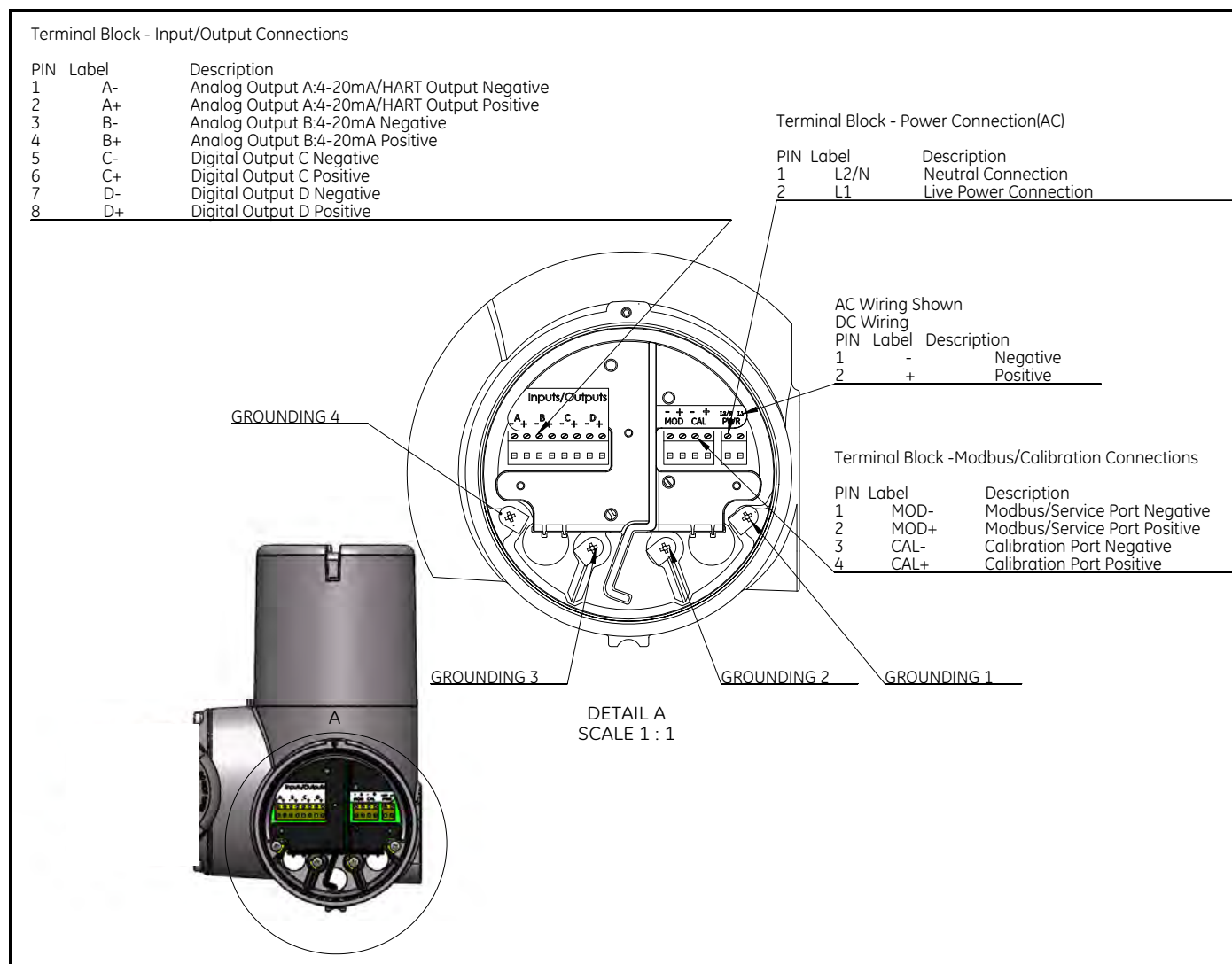

Figure 8: Wiring Diagram



WARNING! Proper grounding of the PanaFlow Z3 chassis is required to prevent the possibility of electric shock. See *Figure 8* above to locate the chassis grounding screw. All ground screws should be hand tightened only. Do not over-torque. Maximum torque is 2.5 N-m (22 in-lb).

2.4 Making Electrical Connections (cont.)

Refer to *Figure 8 on page 7* and prepare the XMT910 for wiring by completing the following steps:



WARNING! Always disconnect the line power from the PanaFlow Z3 before removing either the front cover or the rear cover. This is especially important in a hazardous environment.

1. Disconnect any previously wired power line from the unit.
2. Loosen the set screw on the wiring cover.
3. Place a rod or long screwdriver across the cover in the slots provided, and rotate the cover counterclockwise until it comes free from the enclosure.
4. Install any required cable clamps in the appropriate conduit holes on the opposite side of the enclosure.
5. Note the labels inside the rear cover to assist in wiring the power and option connections.

Proceed to the appropriate section of this chapter to make the desired wiring connections.

2.4.1 Preparing for Wiring



WARNING! To meet CE Mark requirements, all cables must be installed as described in Appendix F, *CE Mark Compliance*.

Wiring any option set requires completion of the following general steps:

1. Disconnect the main power to the unit and remove the wiring cover.
2. Install a cable clamp in the chosen conduit hole on the side of the electronics enclosure and feed a standard twisted-pair cable through this conduit hole.
3. Locate the terminal block shown in *Figure 8 on page 7* and wire the option as indicated on the label inside the wiring cover. Secure the cable clamp.
4. If wiring of the unit has been completed, reinstall the wiring cover on the enclosure and tighten the set screw.

For more specific instructions on particular output configuration, proceed to the appropriate sections.

2.4.2 Wiring Analog Outputs

The standard configuration of the PanaFlow Z3 flow transmitter includes one isolated 4-20 mA analog output with HART[®]. Connections to these outputs may be made with standard twisted-pair wiring, but the current loop impedance for these circuits must not exceed 600 ohms. A second analog output is available as an option.

To wire the analog outputs, complete the following steps:

1. Disconnect the main power to the unit and remove the wiring cover.
2. Install the required cable clamp in the chosen conduit hole on the side of the electronics enclosure.
3. Refer to *Figure 8 on page 7* for the location of the terminal block and wire the analog output as shown. Secure the cable clamp.



WARNING! To meet CE Mark requirements, all cables must be installed as described in Appendix F, CE Mark Compliance.

Note: *Analog Output A carries a HART signal. Whenever this becomes an open circuit or the load exceeds specifications, the output will go to 0 mA and the HART signal will be lost. This can happen if one disconnects the HART communicator while the circuit is live (hot swap). To restore HART communication, one must reset the unit. This can be done by power cycling the instrument, or by entering Configure mode and then exiting without making a change. (Select **No** at the “Save Changes?” prompt.)*



CAUTION! Analog Output A carries an active HART signal. Do not supply a 24 V supply to this circuit. The circuit is powered by the flow meter.

4. If wiring of the unit has been completed, reinstall the wiring cover on the enclosure and tighten the set screw.



WARNING! Make sure all covers, with their o-ring seals, are installed and the set screws tightened before applying power in a hazardous environment.

Note: *Prior to use, the analog output must be set up and calibrated. Proceed to the next section to continue the initial wiring of the unit.*

Note: *Upon applying power to the instrument, the analog outputs will go to 24 mA before settling on a measurement value. This initial state of 24 mA is intended to signal to the operator that the instrument is powered up and executing the initial self-test routines. The 24 mA state normally lasts only for a few seconds until the meter starts measuring flow.*

Note: *See Appendix A, Specifications, for the load and voltage requirements.*

2.4.3 Wiring Digital Outputs



WARNING! To meet CE Mark requirements, all cables must be installed as described in Appendix F, *CE Mark Compliance*.

Wiring any option set requires completion of the following general steps:

1. Disconnect the main power to the unit and remove the wiring cover.
2. Install a cable clamp in the chosen conduit hole on the side of the electronics enclosure and feed a standard twisted-pair cable through this conduit hole.
3. Locate the terminal block shown in *Figure 8 on page 7* and wire the digital outputs (C and D) as indicated on the label inside the wiring cover. Secure the cable clamp.
4. If wiring of the unit has been completed, reinstall the wiring cover on the enclosure and tighten the set screw.

Note: *Prior to use, the option must be set up and calibrated.*

Note: *Digital outputs can be configured as a totalizer pulse, frequency, alarms or control output.*

For more specific instructions on particular output configuration, proceed to the appropriate sections.

2.4.3a Wiring As a Totalizer (Pulse) Output

Wire this option in accordance with the connections shown on the label in the rear cover (see *Figure 8 on page 7*). *Figure 9* below shows a sample wiring diagram of a totalizer output circuit. Refer to Appendix A, *Specifications*, for the load and voltage requirements.

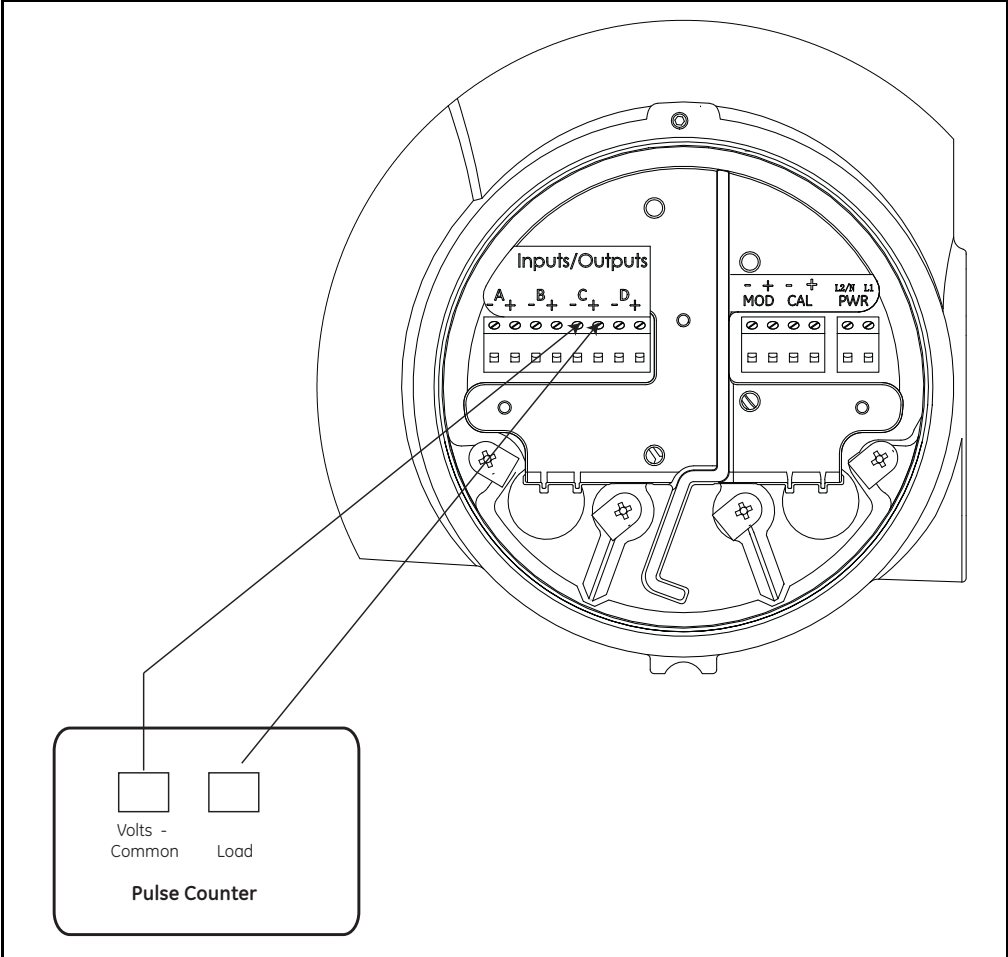

Figure 9: Wiring a Totalizer (Pulse) Output

2.4.3b Wiring As a Frequency Output

Wire this option in accordance with the connections shown on the label in the rear cover (see *Figure 8 on page 7*). *Figure 10* below shows a sample wiring diagram of a frequency output circuit. Refer to Appendix A, *Specifications*, for the load and voltage requirements.

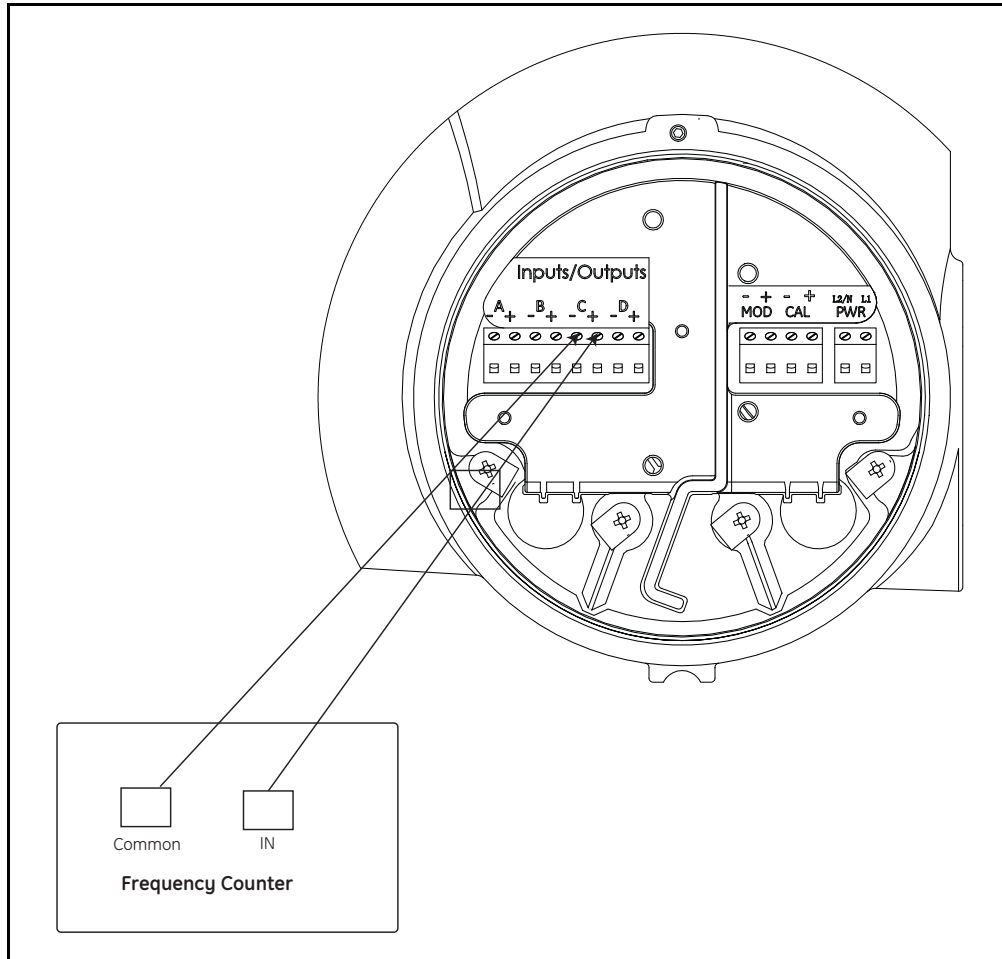

Figure 10: Wiring a Frequency Output

2.4.3c Wiring As Alarms

When configured as Alarms, the Digital output acts as an active, two state output. The Alarm toggles from one state to the other based on a measurement condition. The “open” condition is 0 VDC and the “closed” condition is 5 VDC. The maximum electrical ratings for the relays are listed in Appendix A, *Specifications*. Each of the alarm relays can be programmed as either *Normally Open* (NO) or *Normally Closed* (NC).

In setting up an alarm relay, it may be programmed for either *conventional* or *fail-safe* operation. In fail-safe mode, the alarm relay is held at “closed” (5 VDC), except when it is triggered or a power failure or other interruption occurs. Connect each alarm relay in accordance with the wiring instructions shown in *Figure 11* below (see *Figure 8* on page 7). Refer to Appendix A, *Specifications*, for the load and voltage requirements.

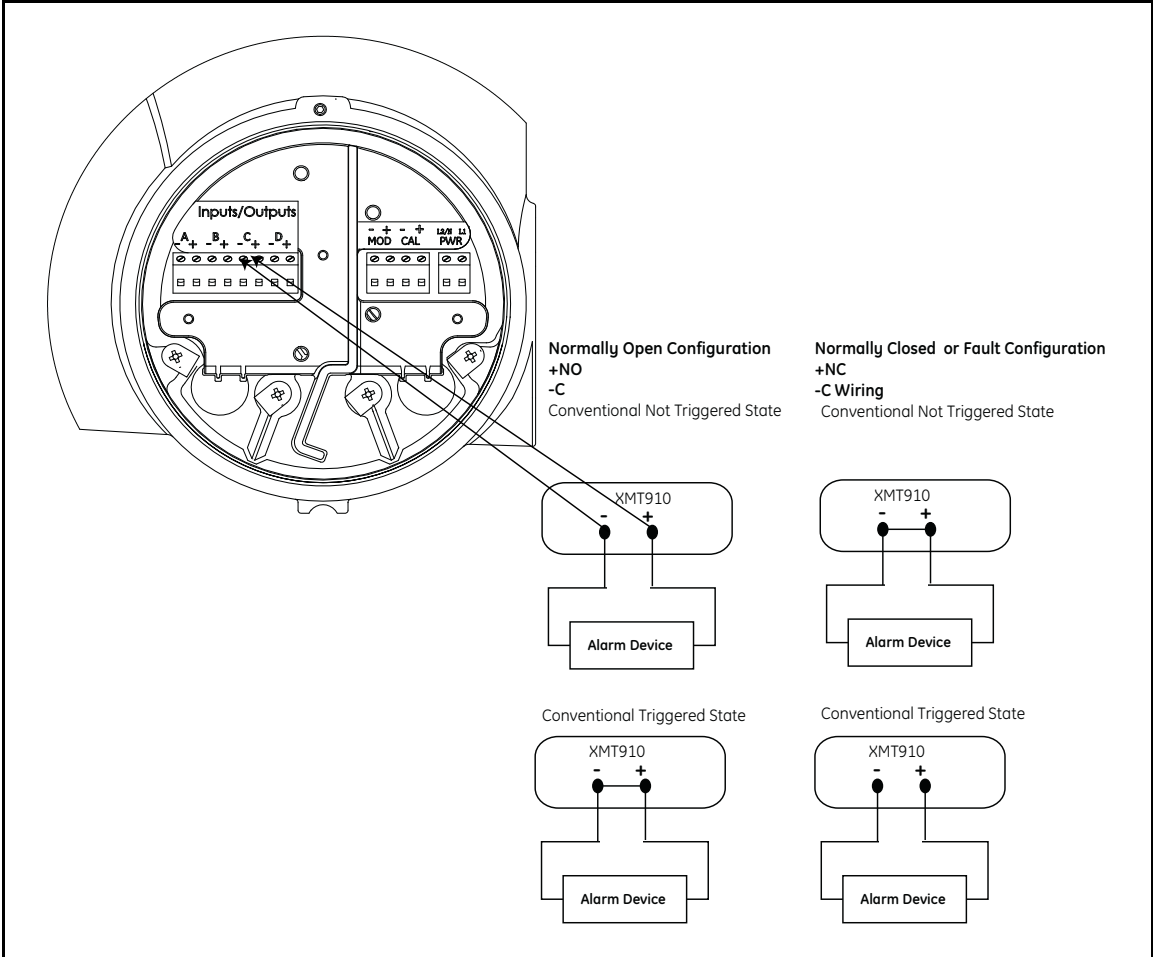

Figure 11: Wiring the Alarm Outputs

2.4.3d Wiring the Control Output

The purpose of the control output is to generate a signal that can be used to control an external device based on a totalized measurement in the flow meter. The Control State can be set to Normally Open or Normally Closed. The setting depends on the device being connected to the control output. The Control State indicates whether the Operator wants that switch to be Open or Closed until the point where the measured total threshold is reached. Once the flow totals reach the threshold level, the meter will switch the Control Output to the opposite state. If the system calls for the Control to be Open (0 VDC) until a certain flow level is reached, the Operator should set the Control to Normally Open. At the measured threshold, the flow meter will change the Control to Closed (5 VDC). If the system calls for the Control to be closed until a certain flow level is reached, the Operator should set the Control to Normally Closed. At the measured threshold, the flow meter will change the Control to Open.

Connect each control output in accordance with the wiring instructions shown on the label inside of the rear cover and in *Figure 12* below.

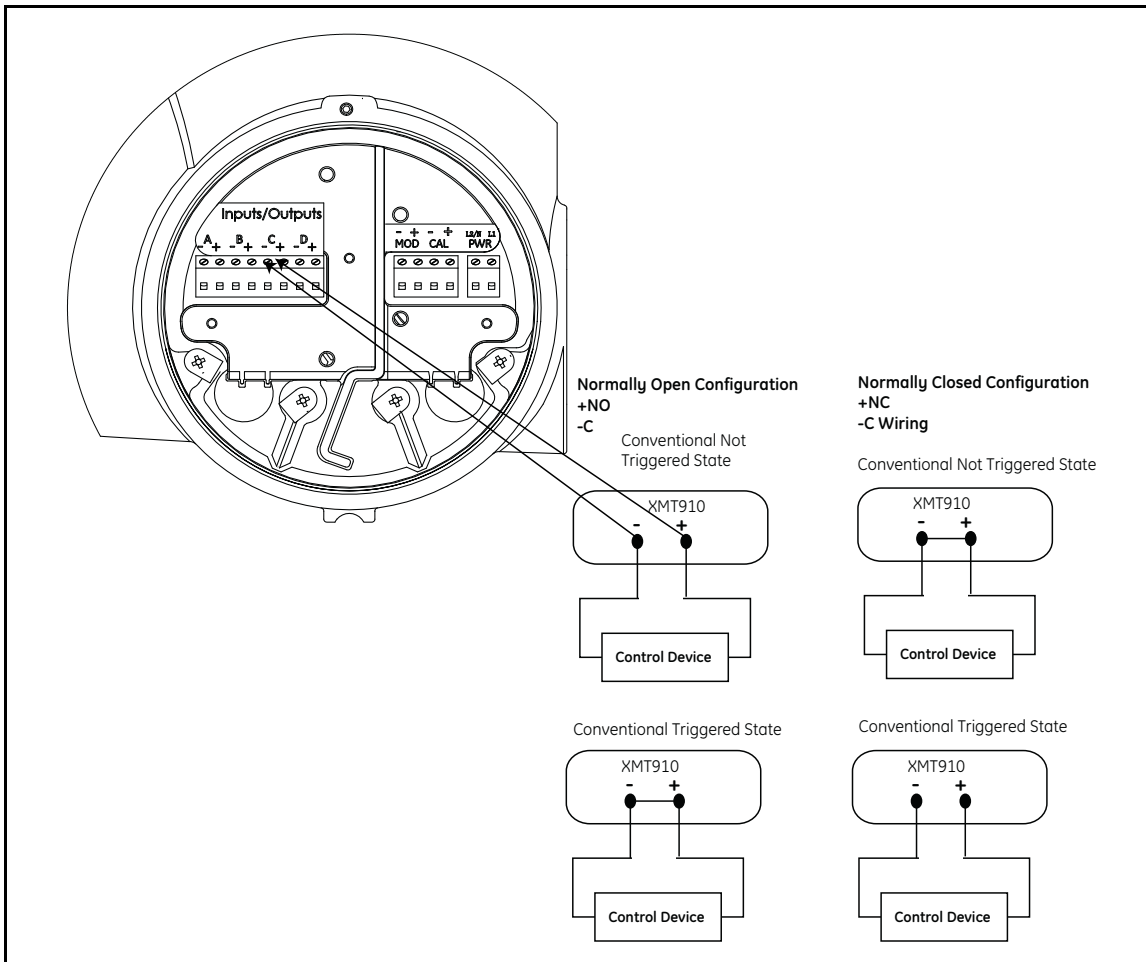

Figure 12: Wiring the Control Output

2.4.4 Wiring the Modbus/Service Port

The XMT910 flow transmitter is equipped with a Modbus communication port for either a connection to Vitality (PC software) or to a separate control system. The port is an RS485 interface.

IMPORTANT: *The maximum cable length for RS485 is 4000 ft (1200 m).*

To wire to this RS485 serial port, refer to *Figure 8 on page 7* and complete the following steps:

- 1. Disconnect the main power to the unit and remove the rear cover.
- 2. Install the required cable clamp in the chosen conduit hole on the side of the electronics enclosure.
- 3. Feed one end of the cable through the conduit hole, wire it as shown in *Figure 13* below.
- 4. If wiring of the unit has been completed, reinstall the wiring cover on the enclosure and tighten the set screw.

Note: *Prior to use, the serial port must be programmed.*



WARNING! Make sure all covers, with their o-ring seals, are installed and the set screws tightened before applying power in a hazardous environment.

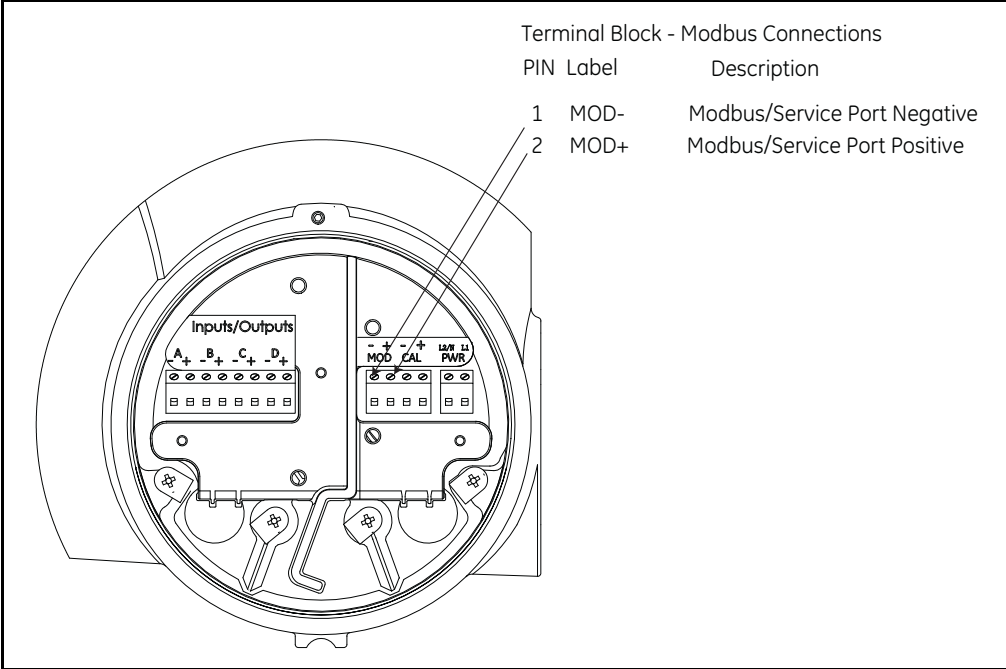

Figure 13: Modbus Connections

2.4.5 Wiring the Calibration Port

The XMT910 flow transmitter is equipped with a calibration port specifically designed for calibrating the PanaFlow Z3. It is wired for a frequency output.

Note: *Performing calibration of the meter requires entering a service-level password.*

To wire to this port, refer to *Figure 14* shown below and complete the following steps:

1. Disconnect the main power to the unit and remove the rear cover.
2. Install the required cable clamp in the chosen conduit hole on the side of the electronics enclosure.
3. Feed one end of the cable through the conduit hole, wire it to the terminal block.
4. If wiring of the unit has been completed, reinstall the wiring cover on the enclosure and tighten the set screw.



WARNING! Make sure all covers, with their o-ring seals, are installed and the set screws tightened before applying power in a hazardous environment.

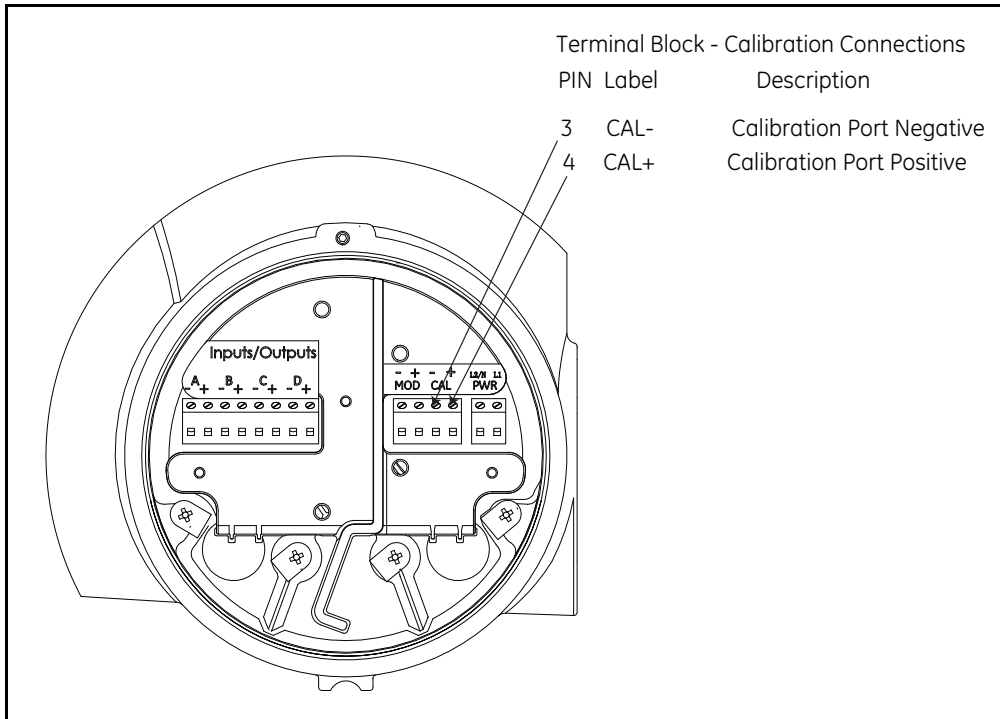

Figure 14: Calibration Connections

2.4.6 Wiring the Line Power

The PanaFlow Z3 may be ordered for operation with power inputs of 100-240 VAC or 15-30 VDC. The label on the side of the electronics enclosure lists the meter's required line voltage and power rating. The fuse size is listed in Appendix A, *Specifications*. Be sure to connect the meter to the specified line voltage only.

Note: *For compliance with the European Union's Low Voltage Directive, this unit requires an external power disconnect device such as a switch or circuit breaker. The disconnect device must be marked as such, clearly visible, directly accessible, and located within 1.8 m (6 ft) of the unit.*

Refer to *Figure 8 on page 7* to locate the terminal blocks and connect the line power as follows:



WARNING! Improper connection of the line power leads or connecting the meter to the incorrect line voltage may damage the unit. It may also result in hazardous voltages at the flowcell and associated piping as well as within the electronics enclosure.

1. Prepare the line power leads by trimming the line and neutral AC power leads (or the positive and negative DC power leads) to a length 0.5 in (1 cm) shorter than the ground lead. This ensures that the ground lead is the last to detach if the power cable is forcibly disconnected from the meter.
2. Install a suitable cable clamp in the conduit hole. If possible, avoid using the other conduit holes for this purpose, to minimize any interference in the circuitry from the AC power line.



WARNING! To meet CE Mark requirements, all cables must be installed as described in Appendix F, *CE Mark Compliance*.

3. Route the cable through the conduit hole and connect the line power leads to the power terminal, using the pin number assignments shown in *Figure 8 on page 7*.
4. Leaving a bit of slack, secure the power line with the cable clamp.
5. If the wiring has been completed, reinstall the wiring cover on the enclosure and tighten the set screw.



WARNING! Make sure all covers, with their o-ring seals, are installed and the set screws tightened before applying power in a hazardous environment.



CAUTION! The transducers must be properly wired before applying power to the meter.

[no content intended for this page]

Chapter 3. Initial Setup and Programming

3.1 Introduction

This chapter provides instructions for programming the PanaFlow Z3 flow meter to place it into operation. Before the PanaFlow Z3 can begin taking measurements, the User Preferences, Inputs/Outputs, and the Test menu must be entered and programmed.

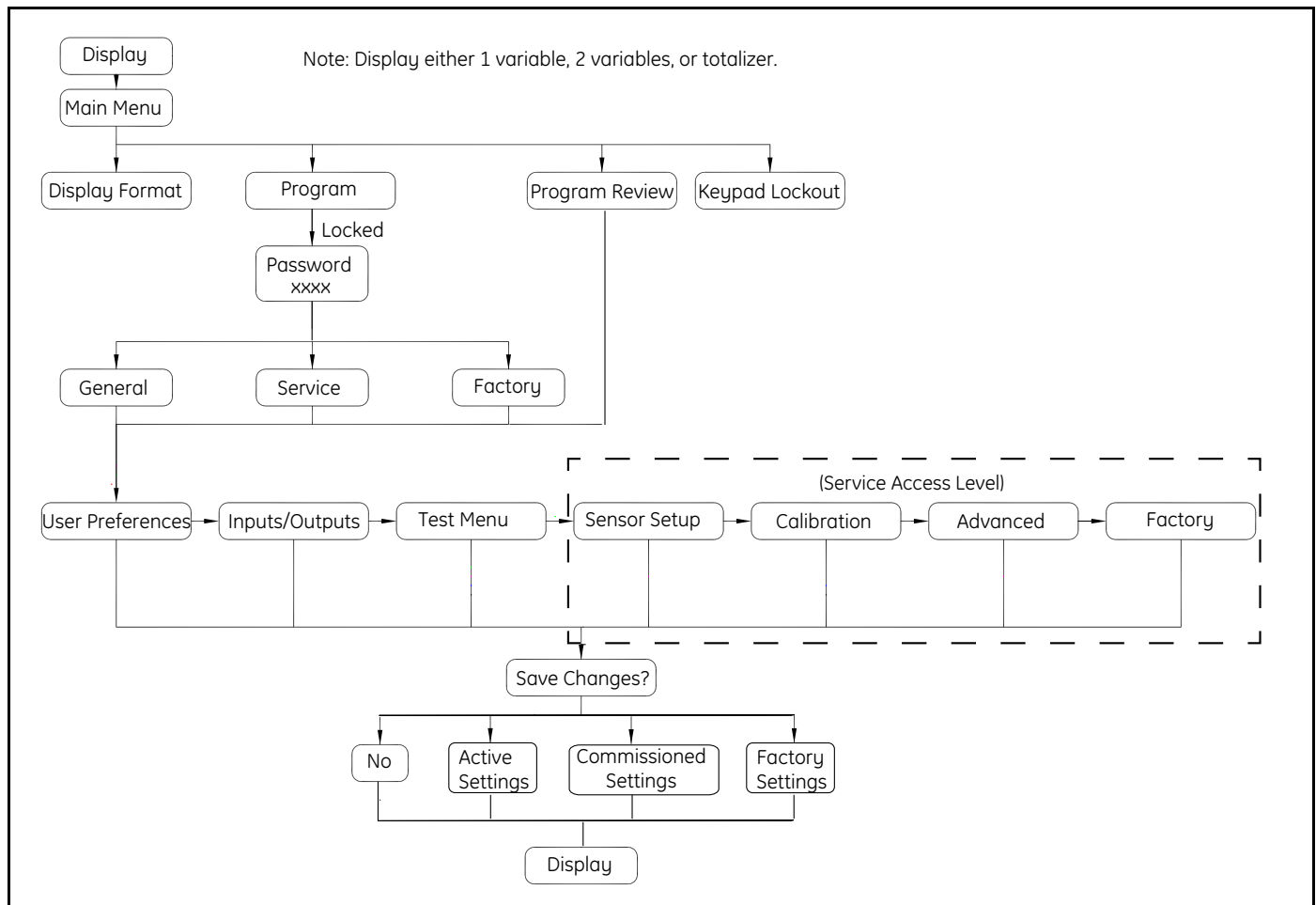

Figure 15: High Level Menu Map

Notice that at the bottom of *Figure 15* above there are four options for *Save Changes*. Selecting *No* will discard any program changes and reset the instrument and restart *Measure* mode. The other three options are *Active Settings*, *Commissioned Settings*, and *Factory Settings*. They allow the instrument to store three complete sets of program data.

Note: *The option to save as Commissioned Settings is only available if the operator has Service or Factory access level. The option to save as Factory Settings is only available from the Factory access level.*

3.1 Introduction (cont.)

The purpose of these extra data sets is to allow the instrument to be restored to those saved settings as a troubleshooting measure. If at any point there is an error in the Active Data Set (the set of parameters used in Measure mode), the Authorized User may revert the Active Data Set to the Commissioned Data Set. This will return the flow meter to a known working condition, the way it was programmed when a GE Service professional first commissioned the product on site. As a secondary redundant measure, the Authorized User may revert the Active Data Set to the Factory Data Set if there is an issue with the Commissioning Data Set. This returns the instrument to the way it was programmed when it was calibrated. The flow meter maintains all three data sets in memory as a backup in case of error.

3.2 PanaFlow Z3 Enclosure Magnetic Keypad

The window at the top of the PanaFlow Z3 enclosure includes the components shown in *Figure 16* below.



Figure 16: The Enclosure Window

IMPORTANT: *The PanaFlow Z3's magnetic keypad enables programming of the instrument through the glass faceplate without removing the cover. Thus, all programming procedures may be performed while the unit is installed in a hazardous area.*

3.2 PanaFlow Z3 Enclosure Magnetic Keypad (cont.)

Above the display, the red light is for power indication and the green light is for system health indication. Once system power is applied, the red light will stay on until power is lost. The green light will only be on when system is measuring without error. If the instrument detects any error, the green light will turn off. Also, when the operator enters Configure mode, the instrument stops measuring, so the green light will be off.

Six keys on the magnetic keypad enable users to program the PanaFlow Z3:

- [$\sqrt{\quad}$] - confirms the choice of a specific option and data entry within the option
- [\times] - enables users to exit from a specific option without entering unconfirmed data
- [Δ] and [∇] - enable users to highlight a specific window in the display option or to scroll through a list of options (parameters, letters, and numbers, 0-9 as well as the negative sign and decimal point) in a menu
- [\triangleleft] and [\triangleright] - enable users to scroll to a specific option, among choices in an option, or to a character in a text entry.

When the PanaFlow Z3 is powered up, the initial screen display appears, followed by meter boot up, then by a display of measurement parameters.

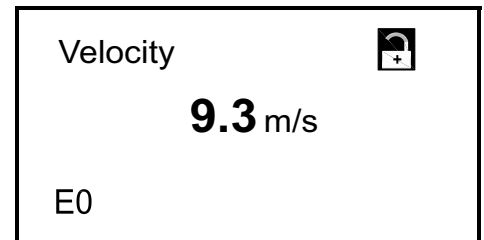

As a guide to help follow the programming instructions in this chapter, the relevant portions of the PanaFlow Z3 menu map have been reproduced in *Figure 25 on page 83* and *Figure 26 on page 84*.

IMPORTANT: *If the keypad has not been pressed for 10 minutes, the PanaFlow Z3 exits the Keypad Program and returns to displaying measurements. The meter discards any configuration changes. Changes can only be retained after the user confirms them.*

3.3 Display Programming

The XMT910 has three types of displays: one variable, two variables, and totalizer as shown below. From this display, you can scroll to and change either the measurement type or value decimals with either the [◀] or [▶] buttons.

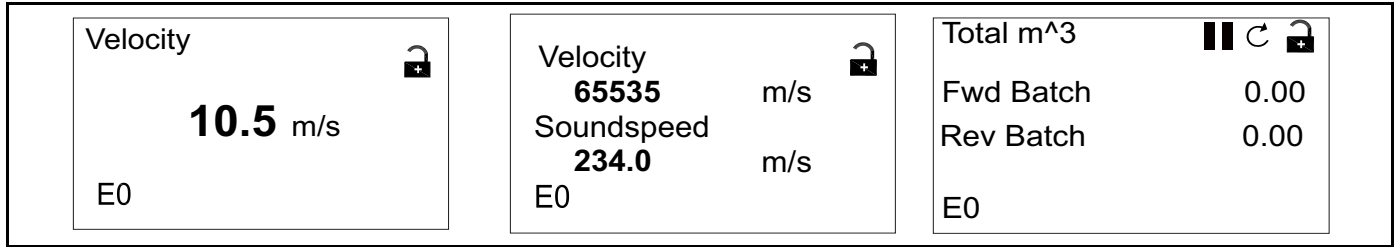

3.3.1 Changing Value for One- or Two-Variable Screens

An outline of a typical one- or two-variable screen appears in *Figure 17* below.

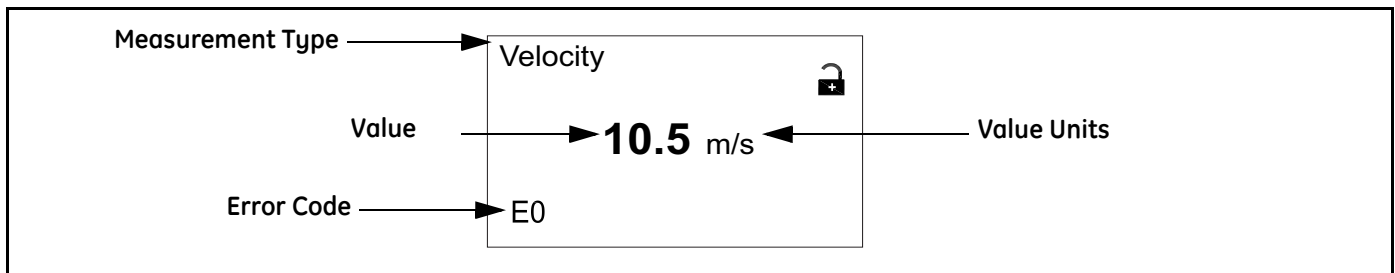
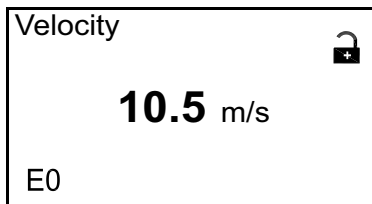
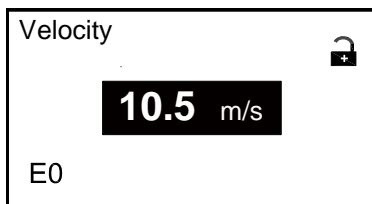

Figure 17: One-Variable Screen

To change the number of decimal places in the value:



From the display screen, press either the [◀] or [▶] buttons until the value is highlighted



Once the value is highlighted, press [√] to open the Display/Decimal option.

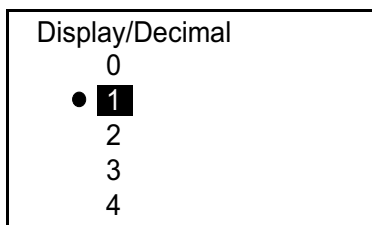

Use the [△] and [▽] buttons to scroll to the appropriate value. (Available options include 0, 1, 2, 3, 4, and Sci (Scientific Notation)). Press [√] to select the value, and then [√] again to confirm the selection or [✕] to cancel the selection.

3.3.2 Changing Measurement Type for One or Two-Variable Screens

To change the measurement type:

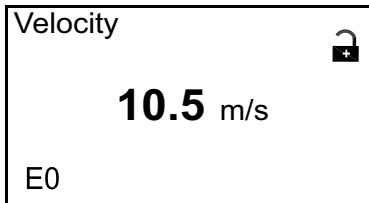

From the display screen, press either the [\triangleleft] or [\triangleright] buttons until the measurement type is highlighted.

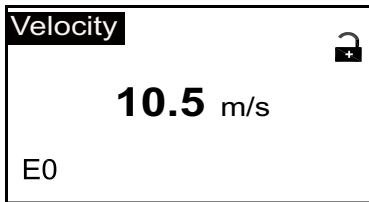

Once the value is highlighted, press [$\sqrt{\quad}$] to open the Display/Measurement Type option.

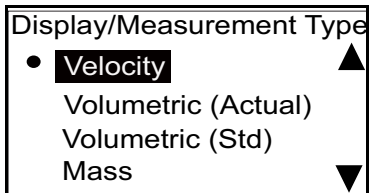

The screen changes to Display/Measurement Type. Press the [\triangle] and [∇] buttons to scroll to the appropriate parameter. The available parameters are shown in *Table 1* below. After you have chosen the type, press [$\sqrt{\quad}$] to select the value, and then [$\sqrt{\quad}$] again to confirm the selection or [\times] to cancel the selection.

Note: To select a particular measurement unit, go to “Flow Units” on page 36.

Table 1: Available Parameters and Units

Parameter	Units	Metric	Unit	Imperial
Velocity	m/s	meters/sec	ft/s	feet/sec
Volumetric (Actual)	L/S	Liters per Second	GAL/S	Gallons per Second
	L/M	Liters per Minute	GAL/M	Gallons per Minute
	L/H	Liters per Hour	GAL/H	Gallons per Hour
	ML/D	Mega Liters per Day	GAL/D	Gallons per Day
	m ³ /S	Cubic Meter per Second	ft ³ /S	Cubic Feet per Second
	m ³ /M	Cubic Meter per Minute	ft ³ /M	Cubic Feet per Minute
	m ³ /H	Cubic Meter per Hour	ft ³ /H	Cubic Feet per Hour
	m ³ /D	Cubic Meter per Day	ft ³ /D	Cubic Feet per Day
	BBL/S	Barrels per Second	BBL/S	Barrels per Second
	BBL/M	Barrels per Minute	BBL/M	Barrels per Minute
	BBL/H	Barrels per Hour	BBL/H	Barrels per Hour
	BBL/D	Barrels per Day	BBL/D	Barrels per Day
	KGAL/M	Kilo gallons per Minute	KGAL/M	Kilo gallons per Minute
KGAL/H	Kilo gallons per Hour	KGAL/H	Kilo gallons per Hour	
KGAL/D	Kilo gallons per Day	KGAL/D	Kilo gallons per Day	

Table 1: Available Parameters and Units (cont.)

Parameter	Units	Metric	Unit	Imperial
Volumetric (Actual) (cont.)	KBBL/M	Kilobarrels per Minute	KBBL/M	Kilobarrels per Minute
	KBBL/H	Kilobarrels per Hour	KBBL/H	Kilobarrels per Hour
	KBBL/D	Kilobarrels per Day	KBBL/D	Kilobarrels per Day
Volumetric (Standard)	SL/S	Standard Liters per Second	SCFH	standard cubic feet per hour
	SL/M	Standard Liters per Minute	SCFM	standard cubic feet per minute
	SL/H	Standard Liters per Hour		
	SML/D	Standard Mega Liters per Day		
	Sm3/S	Standard Cubic Meter per Second		
	Sm3/M	Standard Cubic Meter per Minute		
	Sm3/H	Standard Cubic Meter per Hour		
	Sm3/D	Standard Cubic Meter per Day		
Mass Flow	KG/S	Kilograms per Second	LB/S	Pounds per Second
	KG/M	Kilograms per Minute	LB/M	Pounds per Minute
	KG/H	Kilograms per Hour	LB/H	Pounds per Hour
	KG/D	Kilograms per Day	LB/D	Pounds per Day
	TNE/S	Metric Tons (1000 KG) per Second	KLB/S	KiloPounds per Second
	TNE/M	Metric Tons (1000 KG) per Minute	KLB/M	KiloPounds per Minute
	TNE/H	Metric Tons (1000 KG) per Hour	KLB/H	KiloPounds per Hour
	TNE/D	Metric Tons (1000 KG) per Day	KLB/D	KiloPounds per Day
			S3N/S	short tons per second
			S3N/M	short tons per minute
			S3N/H	short tons per hour
			S3N/D	short tons per day
	Volumetric (Actual) Totals	L	Liters	MGAL
ML		Mega Liters	ft3	Cubic Feet
m3		Cubic Meter	BBL	Barrels
BBL		Barrels	MBBL	Mega Barrels
MBL		Mega Barrels	AC-IN	Acre-inches

Table 1: Available Parameters and Units (cont.)

Parameter	Units	Metric	Unit	Imperial
Volumetric (Actual) Totals (cont.)	KG	Kilograms	AC-FT	Acre-feet
	Tonnes	Metric Tons (1000 KG)	LB	Pounds
Volumetric (Std) Totals	SL	Standard Liters	Sft3	Standard Cubic Feet
	Sm3	Standard Cubic Meter		
Mass Totals	kg	kilograms	LB	pounds
	t	Tonnes		
Density	kg/m3	kilograms per cubic meter	LB/ft3	pounds per cubic foot
Temperature	K	Kelvin	F	degree Fahrenheit
	C	degree Celsius	R	degree Rankine
Dimension	m	meter	ft	feet
	mm	millimeter	in	inch
Time	s	second		
	ms	Milli second		
	us	Micro second		
	h	Hour		
Frequency	Hz	Hertz		
	MHz	Mega Hertz		
	kHz	Kilo Hertz		
Current	amp	Ampere		
	ma	Milli ampere		

3.3.3 Changing Measurement Type or Value for Totalizer Screens

The totalizer screen appears similar to *Figure 18* below.

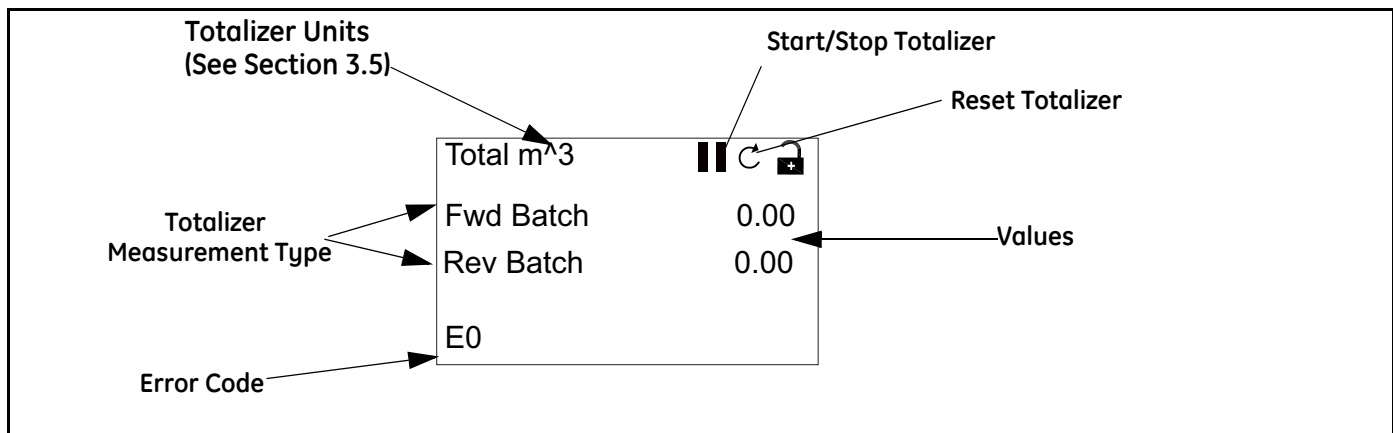
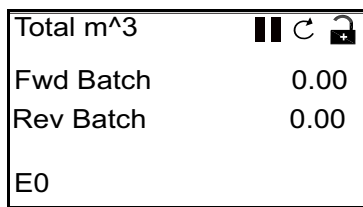
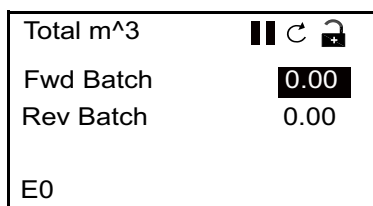

Figure 18: The Totalizer Screen

To change the number of decimal places in the value of a totalizer screen:



From the display screen, press either the [\triangleleft] or [\triangleright] buttons until the value is highlighted.



Once the value is highlighted, press [$\sqrt{\quad}$] to open the Display/Decimal option.

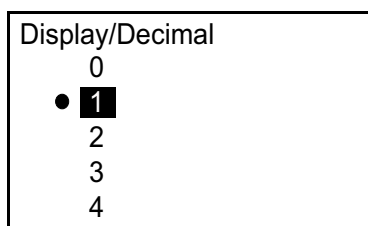

Use the [\triangle] and [∇] buttons to scroll to the appropriate value. (Available options include 0, 1, 2, 3, 4, and Sci (Scientific Notation)). Press [$\sqrt{\quad}$] to select the value, and then [$\sqrt{\quad}$] again to confirm the selection or [\times] to cancel the selection.

3.3.3 Changing Measurement Type or Value for Totalizer Screens (cont.)

To change the totalizer measurement type:

Total m ³	C
Fwd Batch	0.00
Rev Batch	0.00
E0	

From the display screen, press either the [\triangleleft] or [\triangleright] buttons until the measurement type is highlighted.

Total m ³	C
Fwd Batch	0.00
Rev Batch	0.00
E0	

Once the value is highlighted, press [$\sqrt{}$] to open the Display/Measurement Type option.

Display/Measurement Type	
• Forward Batch	
Reverse Batch	
Net Batch	
Batch Time	

The screen changes to Display/Measurement Type. Press the [\triangle] and [∇] buttons to scroll to the appropriate parameter. Available parameters include: Forward Batch (Fwd Batch), Reverse Batch (Rev Batch), Mass Batch and Batch Time. Once you have chosen the type, press [$\sqrt{}$] to select the value, and then [$\sqrt{}$] again to confirm the selection or [\times] to cancel the selection.

If you select Batch Time, you can also select the time measurement units: seconds, minutes, hours or days. To choose the appropriate unit, from the highlighted measurement type, press the [\triangleleft] or [\triangleright] buttons until the measurement unit is highlighted.

Total m³	C
Batch Time	0.00
Rev Batch	0.00
E0	



Once the unit is highlighted, press [$\sqrt{}$] to open the Display/Measurement Unit option.

Display/Unit	
• m³	
ft ³	
GAL	
MGAL	



Press the [\triangle] and [∇] buttons to scroll to the appropriate unit, and press [$\sqrt{}$] to select the unit, and then [$\sqrt{}$] again to confirm the selection or [\times] to cancel the selection.

3.3.4 Starting or Stopping Totalizer Measurement



To start or stop totalizer measurements:

Total m ³			
Fwd Batch	0.00		
Rev Batch	0.00		
E0			

From the display screen, press either the [\triangleleft] or [\triangleright] buttons until the Start/Stop icon (either an arrow icon for Start or a two-bar icon for Stop) is highlighted.

Total m ³			
Fwd Batch	0.00		
Rev Batch	0.00		
E0			



Once the value is highlighted, press [$\sqrt{\quad}$] to start or stop totalizing.

Total m ³			
Fwd Batch	0.00		
Rev Batch	0.00		
E0			



The icon then changes to the other alternative (start or stop).

3.3.5 Resetting the Totalizer

To reset the totalizer:

Total m ³			
Fwd Batch	0.00		
Rev Batch	0.00		
E0			

From the display screen, press either the [\triangleleft] or [\triangleright] buttons until the Reset icon (a partial circle with an arrow) is highlighted.

Total m ³			
Fwd Batch	0.00		
Rev Batch	0.00		
E0			

Once the Reset icon is highlighted, press [$\sqrt{\quad}$] to reset the totalizer to 0.

3.4 Entering the Main Menu (Lock Button)

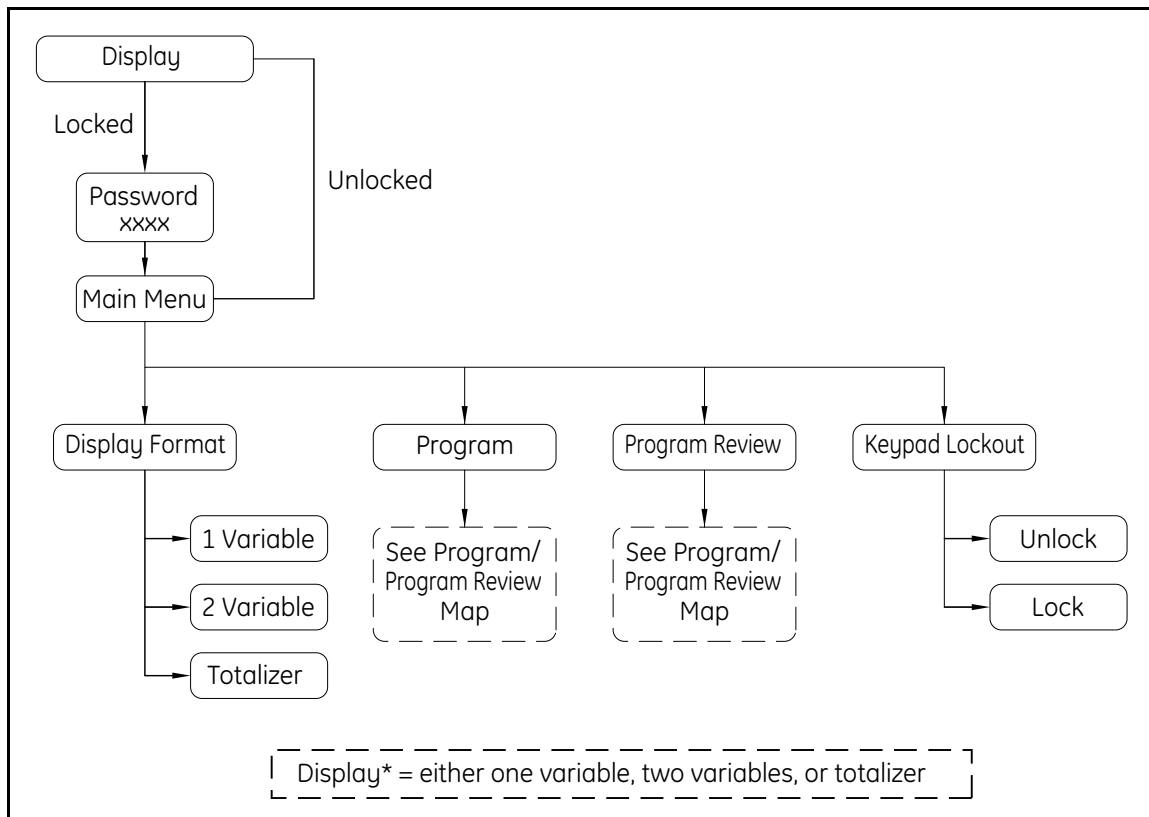
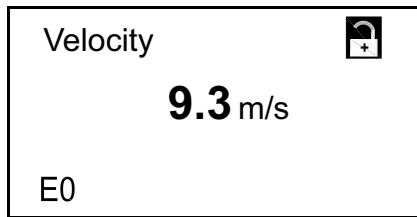

Figure 19: Main Menu Map

3.4.1 Display Format

To begin programming your meter, you must select the system units as discussed below. Refer to *Figure 25 on page 83* and remember to record all programming data in Appendix E, *Data Records*.

The Display Format submenu is used to set up the type of format to be used in representing information.



On the initial screen, use the arrow keys to highlight the lock symbol and press [√]. The following screen appears.

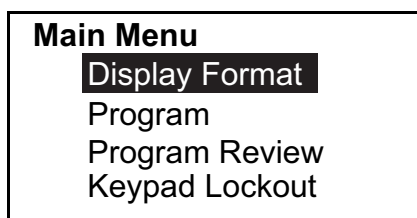

Use the arrow keys to highlight Display Format and press [√]. The following screen appears.

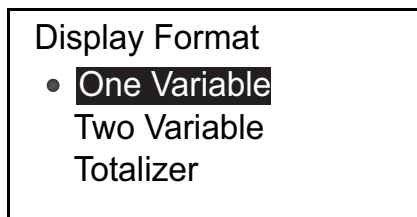

Use the [△] and [▽] arrow keys to highlight the desired format setup and press [√]. The window returns to the previous screen.

3.4.2 Keypad Lockout

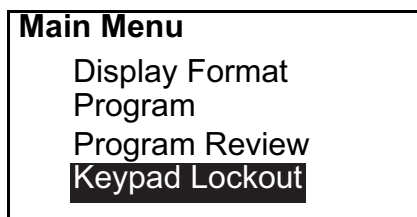

To lock or unlock the keypad for security, on the Main menu, select Keypad Lockout and press [√]. A screen similar to the following appears.

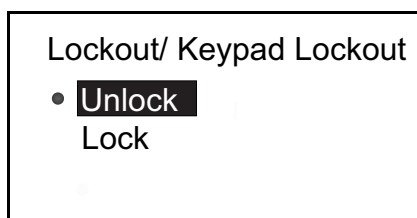

To lock the display, press [△] or [▽] to highlight **Lock** and press [√] and the screen returns to the previous display.

To unlock the display, press [△] or [▽] to highlight **Unlock** and press [√] and the screen returns to the previous display.

Note: When the keypad is locked, press [✕], [√], [✕] to open the password screen. Then enter either a General User, Service or Factory password to unlock.

3.4.3 Program/Program Review

The Program and Program Review menus enable the setting up or viewing of several categories of information at different security levels (see *Figure 20* below). As discussed previously, the ability to edit parameters will depend on the access level. The next section will explicitly state which access is required to edit parameters. To view all parameters without editing, select Program Review.

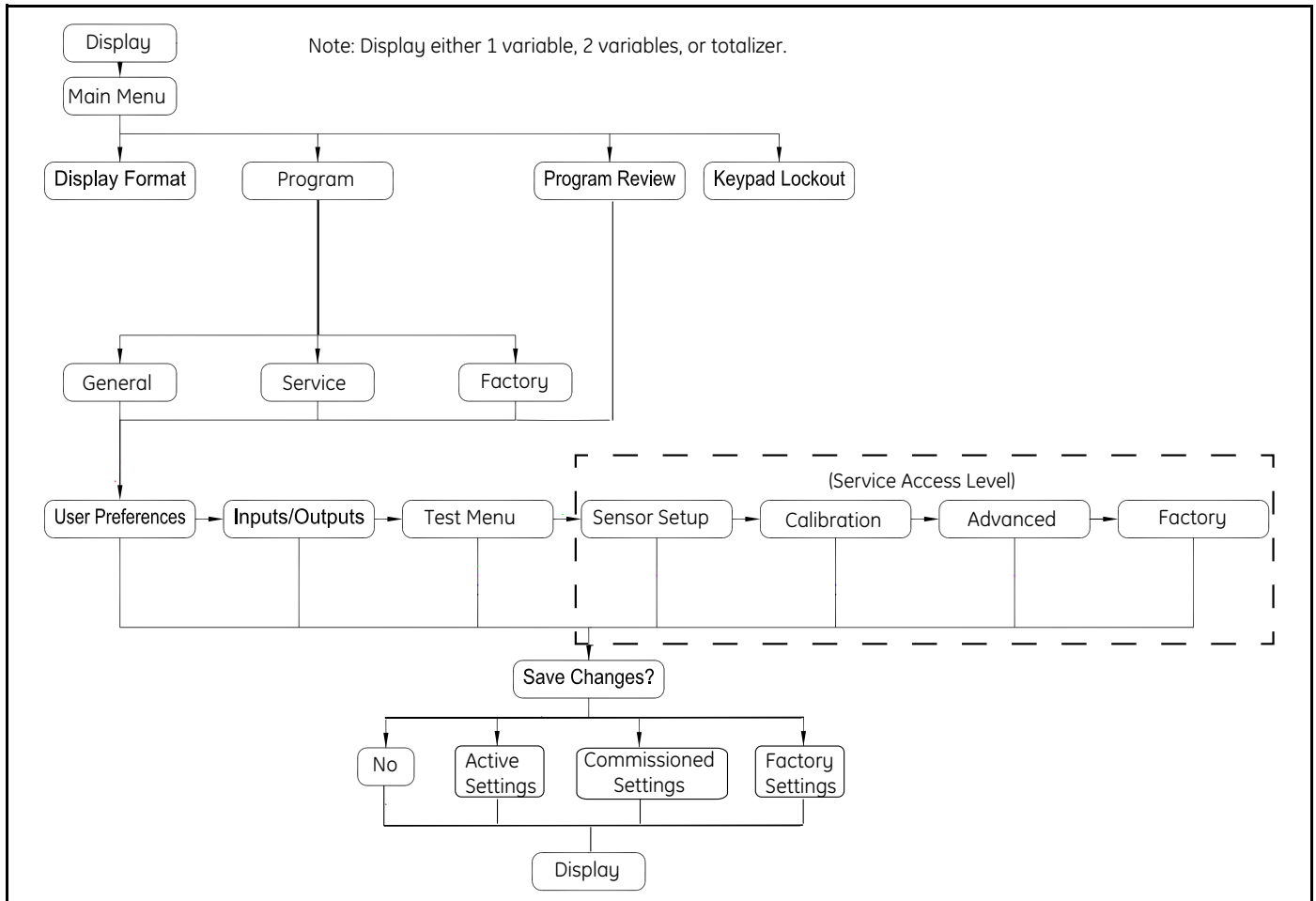

Figure 20: Programming/Program Review Menu Map

The Program Review menu requires no user password. However, it provides view-only access to the screens. To change any setting or parameter, you must enter the Program Menu and supply a password at the appropriate level.

3.4.4 Program

IMPORTANT: *The measurement will stop and the analog output will go to dangerous detected level (error level) when you enter Program (configure) mode.*

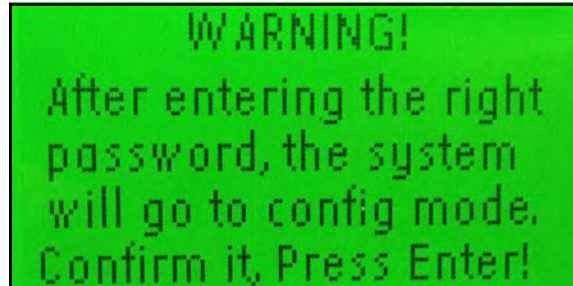
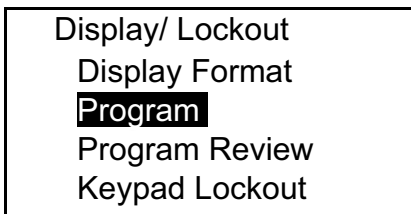

Figure 21: Warning Screen

3.4.4a Enter Programming



To enter the Programming menu, on the Display/Lockout menu, use the arrow keys to highlight Programming and press [√]. The following screen appears.

3.4.4b Access Levels

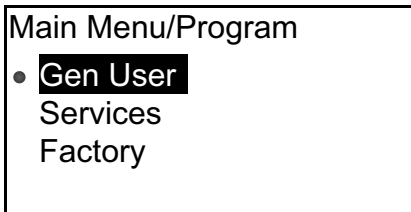

There are three levels of information access: General, Service and Factory. Each level requires that a password be entered. Use the arrow keys to highlight the appropriate level and press [√]. The following screen appears.

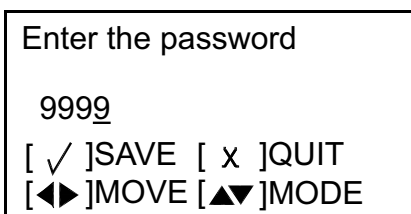

To enter the password, use the [◀] or [▶] arrow key to select each digit to be changed and the [△] or [▽] arrow keys to change the value of each number. When the password number is correct, press [√]. The following screen appears.

Note: *If you enter an incorrect password, the meter will not respond when you press the check mark.*

3.5 User Preferences



CAUTION! Changing program parameters could result in an inaccuracy in the flow measurement. Always use caution when changing parameters at the Service User Level. These parameters shall be entered and validated by a suitably skilled and qualified person (Authorized User).

1. Review parameter changes before committing them to the flow meter. This process happens automatically by the programming interface (display/keypad, Vitality software, or HART). Be sure program parameters are correct before issuing the Commit command.
2. After returning to Measure mode, review the measurement parameters in *Table 2* below to verify they are in an acceptable range. This completes the validation process.

Table 2: Criteria for Requirements

Measurement	Expected	Actual	Criteria	Verdict (P/F)
Ch1 Sound Speed			< 0.5% difference	
Ch1 Velocity			< 0.5% difference	
Ch1 Up Amp Discriminator			> 14 and < 32	
Ch1 Dn Amp Discriminator			> 14 and < 32	
Ch1 SNR Up	> 10		> 5	
Ch1 SNR Dn	> 10		> 5	
Ch1 Active TWup			Within $\pm 15\%$ of the static TW value.	
Ch1 Active TWdn			Within $\pm 15\%$ of the static TW value.	
Ch1 Error Status	0x00000000		0x00000000	
Ch1 Error #	0		< 8	
Ch2 Sound Speed			< 0.5% difference	
Ch2 Velocity			< 0.5% difference	
Ch2 Up Amp Discriminator			> 14 and < 32	
Ch2 Dn Amp Discriminator			> 14 and < 32	
Ch2 SNR Up	> 10		> 5	
Ch2 SNR Dn	> 10		> 5	
Ch2 Active TWup			Within $\pm 15\%$ of the static TW value.	
Ch2 Active TWdn			Within $\pm 15\%$ of the static TW value.	
Ch2 Error Status	0x00000000		0x00000000	
Ch2 Error #	0		< 8	
Composite Velocity			< 0.5% difference	
Composite Volumetric			< 0.5% difference	
Output mA			4 mA \leq x \leq 20 mA	

3.5.1 Settings

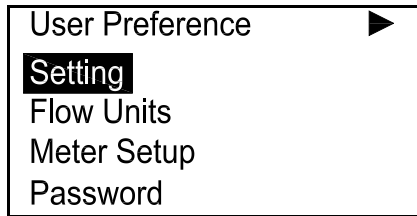

To check and/or change the desired settings, under User Preference, select Settings and press [√]. The following screen appears.

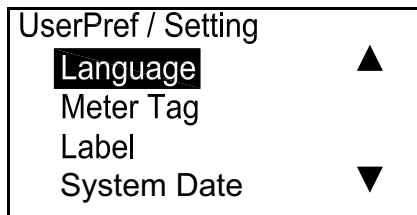

To change the language being used, highlight Language and press [√]. The following screen appears.

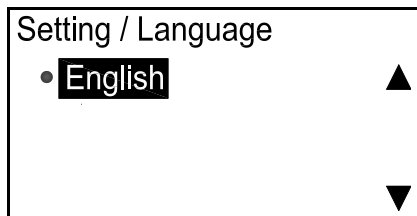

Use the [△] or [▽] arrow keys to select the desired language and press [√] twice. (Only English is currently available.) The screen returns to the previous display.

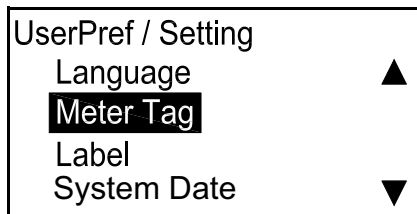

To check the Meter Tag and/or Label, highlight your choice on the UserPref/Setting menu and press [√]. Press [✕] to return to the previous screen.

Note: You can only change the Meter Tag and Label data using Vitality software.

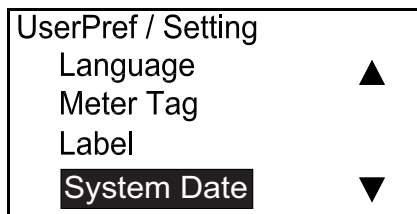
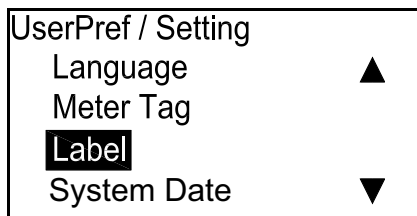

To check and/or change the date/time, highlight System Date and press [√]. The following screen appears.

3.5.1 Settings (cont.)

```

Set System Time...
Date: 11 / 21 / 2011
Time: 08 : 45 : 09
[ x ]QUIT [ ✓ ]SAVE
[ ◀ ]MOVE [ ▲▼ ]MODF
  
```

Use the arrow keys to select the correct response and press [✓]. The screen returns to the previous display.

```

UserPref / Setting
  Meter Tag      ▲
  Label
  System Date
  Limits        ▼
  
```

The next option is for Limits. There are four flow limits related to functional safety that the operator may choose to set. In most cases, the default values for these limits do not need to be changed.

To enter the Limits option, highlight Limits and press [✓].

Note: To enter this option, you must enter a General User or higher level password.

```

Limits
Low Func -12.2000m/s
Low Warn -12.2000m/s
Up Warn  12.2000 m/s
Up Func  12.2000 m/s
  
```

Use the arrow keys to enter the limits and press [✓]. The four limits are the Lower Functional Limit (LFL), Lower Warning Limit (LWL), Upper Warning Limit (UWL), and Upper Functional Limit (UFL). The LFL and UFL are defaulted to the design limits of the system and do not need to be changed unless the operator chooses to set an upper and lower flow rate that is critical to the safety of the system. The LWL and UWL only need to be set if the LFL and UFL are used.

```

UserPref/ Setting
  System Date      ▲
  Limits
  Density          ▼
  Kinematic Viscosity
  
```

After Limits, select Density to set static and reference density. Mass Flow is calculated by multiplying the measured value of Volumetric Flow by the static density. Standardized Volumetric Flow is calculated by multiplying the measured value of Volumetric Flow by the ratio of static density to reference density.

Finally, enter a static value for Kinematic Viscosity, in centistokes. This value is used to determine the Reynolds number correction factor for the flow measurement.

3.5.2 Flow Units

User Preference	▶
Setting	
Flow Units	
Meter Setup	
Password	

To check and/or change flow units, under User Preference, use the [△] or [▽] arrow key to select Flow Units and press [√]. The following screen appears.

3.5.2a Velocity

UserPref / Flow Units	
Velocity	▲
Volumetric (Actual)	
Volumetric (Std)	
Mass	▼

To check and/or change velocity flow units, under UserPref/Flow Units, use the [△] or [▽] arrow key to select Velocity and press [√]. The following screen appears.

Note: *If a flow unit is not selectable in this section, it will not appear later in the programming.*

FlowUnits / Velocity
• No
Yes

If you don't want Velocity, select No, press [√]. If you want to display Velocity, select Yes, press [√] twice, and the following screen appears.

Vel /
• English
Metric

If no change is desired, press [✕] twice and the screen returns to the UserPref/Flow Units menu. To change the measurement type, select the desired option, press [√] twice, and a screen similar to the following appears.

Vel /
• Ft/s

Confirm the units, press [✕] three times and return to the UserPref/Flow Units menu.

3.5.2b Volumetric and Mass

UserPref / Flow Units	
Velocity	▲
Volumetric (Actual)	
Volumetric (Std)	
Mass	▼

To check and/or change actual volumetric flow units, under UserPref/Flow Units, use the [▲] or [▼] arrow key to select Volumetric (Actual) and press [√]. The following screen appears.

FlowUnits / Avol	
• No	
Yes	

To remove Volumetric from the display menus, select No, press [√]. If change is desired, select Yes, press [√] twice, and the following screen appears.

Avol /	
• English	
Metric	

If no change is desired, press [√] and a screen similar to the following appears. To change the measurement type, select the desired option, press [√] twice, and a screen similar to the following appears.

Avol /	
• Ft³/s	▲
Ft ³ /m	
Ft ³ /h	
Ft ³ /d	▼

If the highlighted units are correct, press [×] three times and return to the UserPref/Flow Units menu. To change the units, use the [▲] or [▼] arrow key to select the desired option, press [√] twice, and the display returns to the previous screen. Press the [×] key twice to return to the UserPref/Flow Units screen.

Note: Use the above procedure to check and/or change the standard volumetric (Volumetric (Std)) flow units and the mass (Mass) flow units.

3.5.2c Totalizer

UserPref / Flow Units	
Volumetric (Actual)	▲
Volumetric (Std)	
Mass	
Totalizer	▼

To check and/or change totalizer measurement units, under UserPref/Flow Units, use the [△] or [▽] arrow key to select Totalizer and press [√]. A screen similar to the following appears.

FlowUnits / Totalizer	
• No	
Yes	

To remove Totals from display menus, use the [△] or [▽] arrow key to select No and press [√]. The screen returns to the previous display. To continue setting up the Totalizer, select Yes, press Enter, and a screen similar to the following appears.

Totalizer / Totalizer	
• Volumetric (Act)	
Volumetric (Std)	
Mass	

Use the [△] or [▽] arrow key to select Actual, Standard or Mass totals, press [√] twice, and a screen similar to the following appears.

Totalizer /	
• English	
Metric	

If no change is required, press [√]. If change is required, select the appropriate measurement category, and press [√] twice. A screen similar to the following appears.

Avol /	
• GAL	▲
M GAL	
Ft^3	
MFt^3	▼

If no change is required, press [√]. If change is required, select the appropriate measurement type, press [√], and the display returns to the previous screen. Press the [X] key twice to return to the UserPref/Flow Units screen.

3.5.2d Density

UserPref / Flow Units	
Volumetric(Std)	▲
Mass	
Totalizer	
Density	▼

To calculate Mass Flow, you must enter Actual Density. To measure Volumetric (Std.), you must enter Actual Density and the Reference Density. To check and/or change density values, under UserPref/Flow Units, use the [△] or [▽] arrow key to select Density and press [√]. The following screen appears.

FlowUnits / Density	
• No	
Yes	

To exit the Totalizer setup procedure, use the [△] or [▽] arrow key to select No and press [√]. The screen returns to the previous display. To continue setting up the Totalizer, select Yes, press [√] and a screen similar to the following appears.

FlowUnits / Density	
• English	
Metric	

If no change is required, press [×]. If change is required, select the appropriate measurement category, and press Enter. A screen similar to the following appears.

Density / Density	
• Lb/Ft^3	

If no change is required, press [√]. If change is required, select the appropriate measurement type, press [√], and the display returns to the previous screen. Press the [×] key twice to return to the UserPref/Flow Units screen.

3.5.3 Meter Setup

Note: *The Meter Setup category is accessed by all user passwords.*

3.5.3a Zero Cutoff

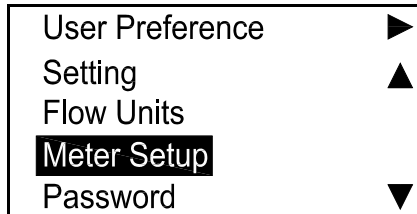

To set up the meter, under User Preference, use the [△] or [▽] arrow key to select Meter Setup and press [√]. The following screen appears.

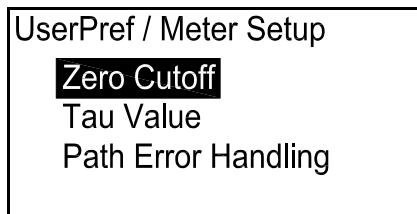

Select Zero Cutoff, press [√], and a screen similar to the following appears.

Note: *Zero cutoff is based on velocity.*

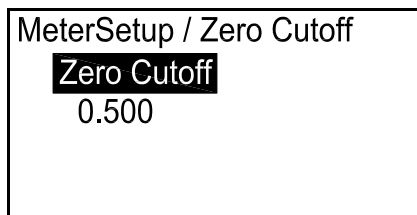

To set the zero cutoff, press [√] and a screen similar to the following appears. When the flow rate drops below the zero cutoff level, the flow will be forced to 0.00. This is to avoid measurement fluctuations near the zero point.

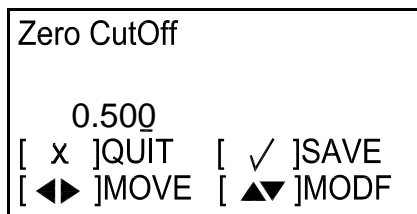

Use the [◀] and [▶] arrow keys to select each digit to be changed and the [△] or [▽] arrow keys to change the digit value, then press [√]. Press the [×] key to return to the Meter Setup screen.

3.5.3 Meter Setup (Cont.)

Note: The Meter Setup category is accessed by all user passwords.

3.5.3b Tau Value

```
UserPref / Meter Setup
  Zero CutOff
  Tau Value
  Path Error Handling
```

The Tau value determines how quickly the meter responds to a change in flow rate. A small Tau responds quickly to flow changes, but is very erratic. A high Tau value dampens a response to changes for a smooth transition, but a slower one. Under Meter Setup, use the [Δ] or [∇] arrow key to select Tau Value. Press [$\sqrt{}$] and a screen similar to the following appears. The default Tau value is 0.001 sec or 1 msec.

```
MeterSetup / Tau Value
  Tau Value
  0.040
```

To set the Tau value, press [$\sqrt{}$] and a screen similar to the following appears.

```
Tau Value
  0.001
  [ x ]QUIT [ ✓ ]SAVE
  [ ◀▶ ]MOVE [ ▲▼ ]MODE
```

Use the[\leftarrow] and [\rightarrow] arrow keys to select each digit to be changed and the [Δ] or [∇] arrow keys to change the digit values, then press [$\sqrt{}$]. Press [\times] twice to return to the Meter Setup screen.

3.5.3c Path Error Handling

```
UserPref / Meter Setup
  Zero CutOff
  Tau Value
  Path Err Handling
```

Under Meter Setup, use the [Δ] or [∇] arrow key to select Path Err Handling.

```
MeterSetup/Path Error Handling
  • OFF
  ON
```

To turn the Path Err Handling ON or OFF, select the desired status and press [$\sqrt{}$]. The screen returns to the previous display.

3.5.4 Password

3.5.4a General User

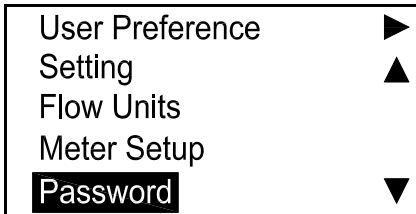

This option is used to change the General User password to a custom value. To set up a password, under User Preference, use the [△] or [▽] arrow key to select Password and press [√]. The following screen appears.

Note: *If the password used to access programming was Gen User (for General User), only Gen User will appear on the next screen.*



To provide a general user password, select Gen User, press [√], and a screen similar to the following appears.

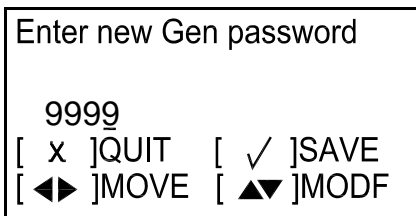

Use the [△] or [▽] arrow key to change the digit value and press [√]. Press the [×] key to return to the UserPref/Password screen.

3.5.5 Display

3.5.5a Backlight

User Preference	▶
Flow Units	▲
Meter Setup	
Password	
Display	▼

To turn the backlight OFF or ON, under User Preference, use the [△] or [▽] arrow key to select Display and press [√]. The following screen appears.

UserPref / Display
Backlight
Timeout

Select Backlight, press [√], and a screen similar to the following appears.

Display / Backlight
• OFF
ON

Select OFF or ON, press [√] twice and the screen returns to the previous display.

3.5.5b Timeout

UserPref / Display
Backlight
Timeout

To provide a timeout, under Display, select Timeout and press [√]. A screen similar to the following appears.

Display / Timeout
Timeout
10 Second:

Press [√] again and a screen similar to the following appears.

Timeout
10 Second:
[x]QUIT [√]SAVE
[◀▶]MOVE [▲▼]MODF

Use the [△] or [▽] arrow key to change the digit value and press [√]. Press [×] three times to return to the User Preference screen.

3.6 Input/Output

3.6.1 Analog Output A

3.6.1a Accessing the Analog Output Menu

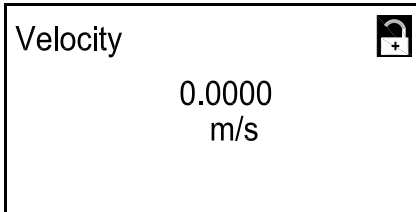

To access the Analog Output menu, on the initial screen, highlight the lock symbol and press [√]. The following screen appears.

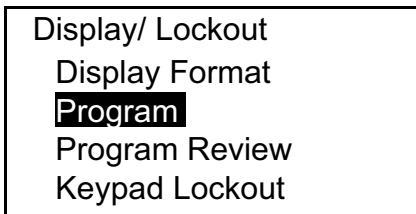

Select Program and press [√]. The following screen appears.

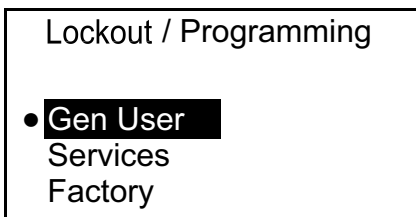

Select a password level (Gen User, Service or Factory) other than General User from the Program Menu and press [√]. The following screen appears.

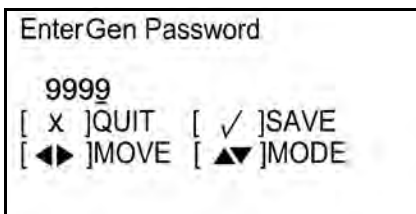

To enter the password, use the Left and Right arrow keys to select the digit to be changed, use the [△] or [▽] arrow keys to change the value of each digit, and press [√]. The following screen appears.

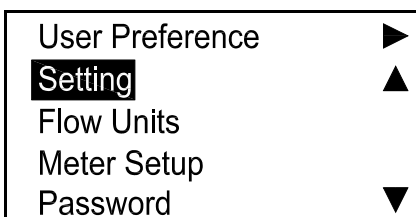

In the User Preference menu, select Setting, then press the **right arrow key**. A screen similar to the following appears.



The screen shows what option is installed. Select Option D and press [√]. The following screen appears.

3.6.1 Analog Output A (cont.)

3.6.1b Setting Analog Measurements

```

I/O Out
  Analog Output (HART)
  Analog Output B
  Digital Output
  Modbus/Service Port
  
```

To set up the analog output, select Analog Output A and press [√]. The following screen appears.

```

Option D / Analog Output
  Measurement ▲
  Base Value
  Full Value
  Calibrate ▼
  
```

Select Measurement and press [√]. The following screen appears.

```

Measurement
  Velocity
  • Volumetric (Act)
  Volumetric (Std)
  Mass
  
```

In the Analog Output A menu, select the type of analog output to be used, and press [√]. The screen returns to the previous display.

3.6.1c Setting Base Value and Full Value

```

Option D / Analog Output
  Measurement ▲
  Base Value
  Full Value
  Calibrate ▼
  
```

Base Value is the flow rate represented by 4 mA, and Full Value is the flow rate represented by 20 mA. In the Analog Output menu, select Base Value or Full Value and press [√]. A screen similar to the following appears.

```

Analog Output / Base
  Base Value
  0.00000 m^3/s
  
```

Press [√] again and a screen similar to the following appears.

Note: The units that appear will be the units selected in “Flow Units” on page 36.

```

Base Value
  0.00000 m^3/s
  [ x ]QUIT [ √ ]SAVE
  [ ◀▶ ]MOVE [ ▲▼ ]MODF
  
```

Use the [◀] and [▶] arrow key to select the digit to be changed, use the [△] or [▽] arrow key to change the Base Value or Full Value setting, and press [√]. Repeat these steps to set the Full Value setting. Press [✕] to return to the Analog Output menu.

3.6.1 Analog Output A (cont.)

3.6.1d Calibrate the Output

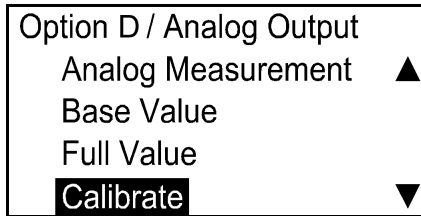

Use the **Calibrate** menu to trim Output A to your measurement system. In the Analog Output menu, select Calibrate and press [√]. The following screen appears.

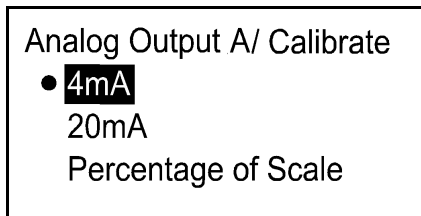

Select 4 mA to trim the 4 mA level, 20 mA to trim the 20 mA level, or Percentage of Scale to test linearity. Select the appropriate option and press [√]. A screen similar to the following appears.

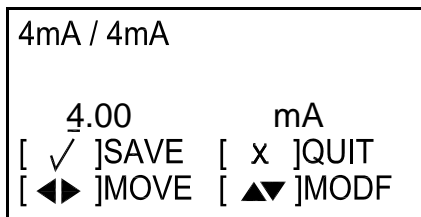

Use the [△] or [▽] arrow key to change the Calibrate setting value and press [√]. Press [x] to return to the Analog Output menu.

If you do not see 4 mA at your measurement system, enter the value that you see. Press [√] and the meter will make an adjustment. Then continue until you see 4 mA at your measurement input.

Repeat the above process to set and/or change other options.

3.6.1e Setting Error Handling

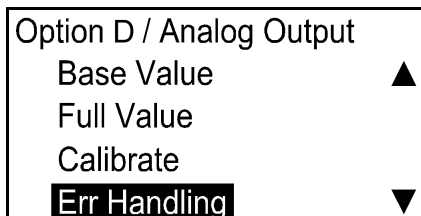

To specify the error handling status, in the Analog Output menu select Err Handling and press [√]. The following screen appears.

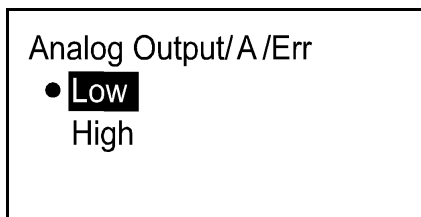

Selecting Low will force the A\Output to 3.6 mA, while High will force it to 21.0 mA. Select the appropriate status and press [√].

3.6.2 Analog Output B

3.6.2a Accessing the Analog Output Menu

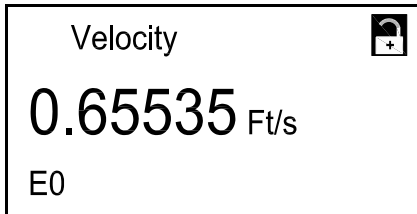

To access the Analog Output Menu, on the initial screen, highlight the lock symbol and press [√]. The following screen appears.

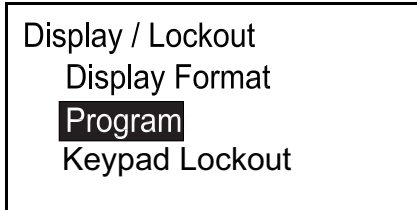

Select Program and press [√]. The following screen appears.

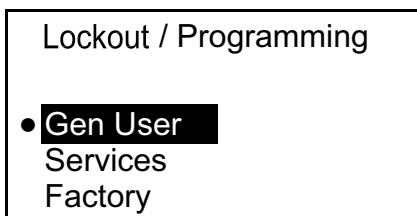

Select any password level from the Program Menu and press [√]. The following screen appears.

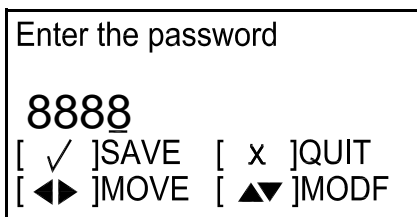

To enter the password, use the Left and Right arrow keys to select the digit to be changed, use the Up and Down arrow keys to change the value of each digit, and press [√]. The following screen appears.

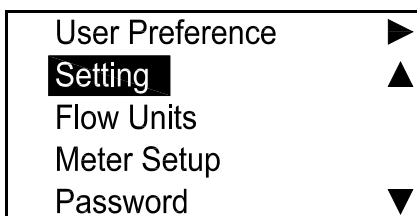

In the User Preference Menu, select Setting, then press the **right arrow key**. A screen similar to the following appears.

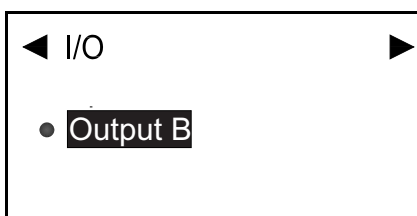

Output B appears. Press [√]. The following screen appears.

3.6.2 Analog Output B (cont.)

3.6.2b Setting the Analog Measurements

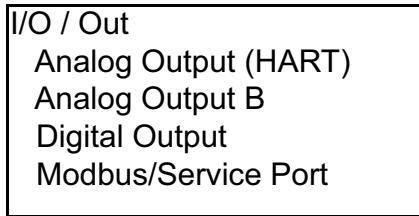

To set up the analog B output, select Analog Output B and press [√]. The following screen appears.

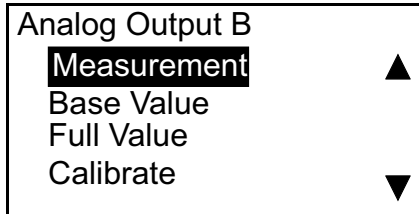

Select Measurement and press [√]. The following screen appears.

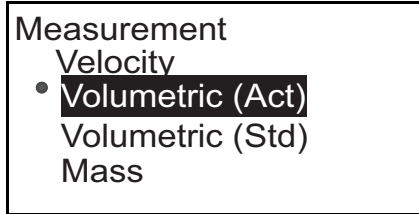

In the Output Analog menu, select the type of analog output to be used, and press [√]. The screen returns to the previous display.

3.6.2c Setting the Base Value and Full Value

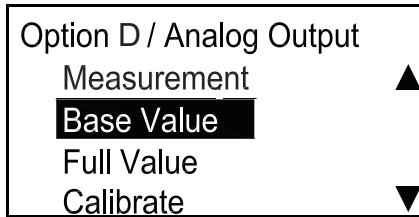

Base Value is the flow rate represented by 4 mA, and Full Value is the flow rate represented by 20 mA. In the Analog Output menu, select Base Value or Full Value and press [√]. A screen similar to the following appears.

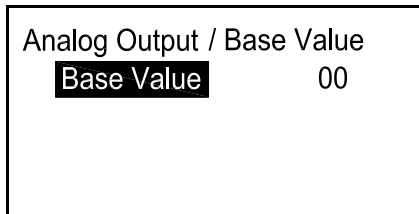

Press [√] again and a screen similar to the following appears.

Note: The units that appear will be the units selected in “Flow Units” on page 36.

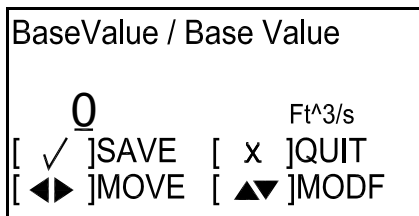

Use the [◀] and [▶] arrow key to select the digit to be changed, use the [▲] or [▼] arrow key to change the Base Value or Full Value setting, and press [√].

Repeat these steps to set the Full Value setting. Press [✕] to return to the Analog Output menu.

3.6.2 Analog Output B (cont.)

3.6.2d Selecting the Calibration Value

```

Option D / Analog Output
  Analog Measurement ▲
  Base Value
  Full Value
  Calibrate ▼
  
```

Use the Calibrate menu to trim the output to your measurement system. In the Analog Output menu, select Calibrate and press [√]. The following screen appears.

```

Analog Output / Calibrate
  ● Calibrate 4mA
  Calibrate 20mA
  Percentage of Scale
  
```

Select 4 mA to trim the 4 mA level, 20 mA to trim the 20 mA level, or Percentage of Scale to test linearity. Select the appropriate option and press [√]. A screen similar to the following appears.

```

4mA / 4mA
  0
  [ √ ]SAVE [ x ]QUIT
  [ ◀▶ ]MOVE [ ▲▼ ]MODF
  
```

Use the [△] or [▽] arrow key to change the Calibrate setting value and press [√]. Press [×] to return to the Analog Output menu.

If you do not see 4 mA at your measurement system, enter the value that you see. Press [√] and the meter will make an adjustment. Then continue until you see 4 mA at your measurement input. Repeat the above process to set and/or change

other options.

3.6.2e Setting the Error Handling

```

Option D / Analog Output
  Base Value ▲
  Full Value
  Calibrate
  Err Handling ▼
  
```

To specify the error handling status, in the Analog Output menu select Err Handling and press [√]. The following screen appears.

```

Error Handling
  ● Low
  High
  Hold
  Other
  
```

Selecting Low will force Output B to 4.0 mA in case of Error. High will force it to 20.0 mA. Hold will cause the analog output to remain at whatever mA level it is when the error occurs. Other allows the Operator to select a mA value to represent a fault condition, allowing the Operator to force the output to Namur error levels or another custom value. Select the appropriate status and press [√].

```

Other
  0.0
  [ √ ]SAVE [ x ]QUIT
  [ ◀▶ ]MOVE [ ▲▼ ]MODE
  
```

If you select Other, use the [△] or [▽] arrow key to change the Other setting value and press [√]. Press [×] to return to the Analog Output menu.

Note: An “Error” state is any state that produces an error code on the LCD screen. Please see Chapter 4 for more details on errors.

3.6.3 Programming Digital Outputs

Digital Outputs are output circuits that are designed to be used as Pulse Outputs, Frequency Outputs, Alarms, or Control Outputs. They have a flexible circuit design that can be modified by programming commands to perform these different functions.

The sections that follow describe how to set up each type of function.

Note: *In each function area, there is a way to change behavior based on an Error Condition. Chapter 4 mentions several types of error conditions in the flow meter. It may not be clear which errors will trigger the Error Handling function. The guideline is that when an error message appears on the LCD, the Error Handling circuit will trip.*

3.6.3a Accessing the Digital Output Menu

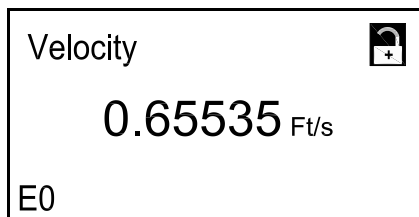

To access the Digital Outputs menu from the initial screen, use the arrow keys to highlight the lock symbol and press [√]. A screen similar to the following appears.

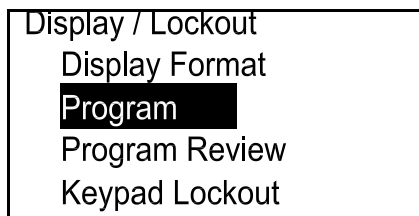

Use the arrow keys to select Program and press [√]. The following screen appears.

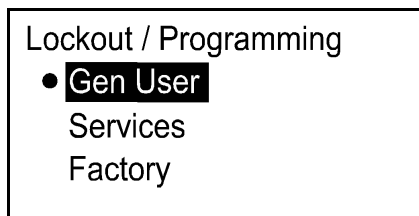

Select a security level and press [√]. The following screen appears.

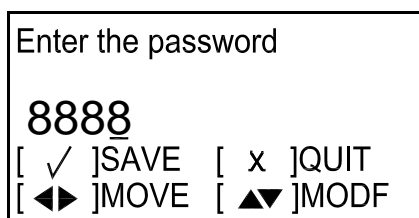

Enter the appropriate password. Use the [◀] or [▶] arrow key to select each digit to be changed, and the [▲] or [▼] arrow key to change the digit value. Then press [√]. The following screen appears.

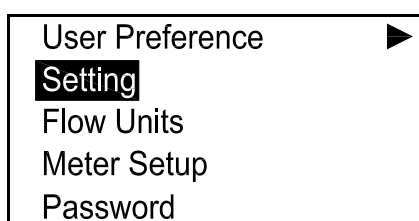

Select Setting and press the **right arrow key**. The following screen appears.

3.6.3a Accessing the Digital Output Menu (cont.)



The screen now indicates the installed option card, either A or B. Press [√] and a screen similar to the following appears.

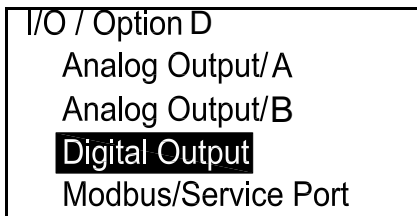

To set up the Digital Output, select it on the screen and press [√]. A screen similar to the following appears.

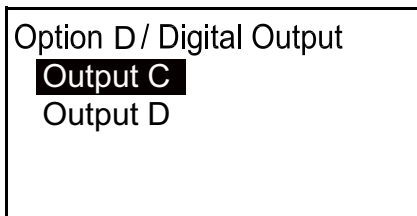

Select the desired Digital Output number and press [√]. The following screen appears.

3.6.3b Setting the Pulse Output

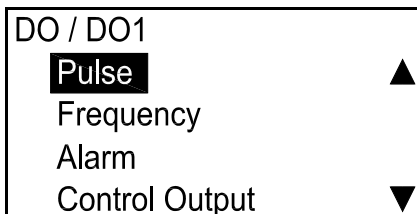

Digital Outputs can be programmed as Pulse, Frequency, Alarm or Control Outputs, or turned off. The Pulse output will put out a square wave pulse for each unit of flow that passes through the pipeline. Select Pulse and press [√]. The following screen appears.

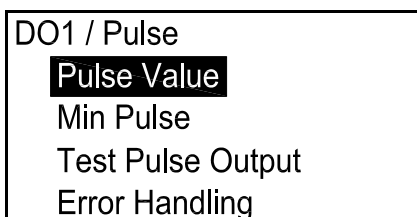

Select Pulse Value and press [√]. A screen similar to the following appears.

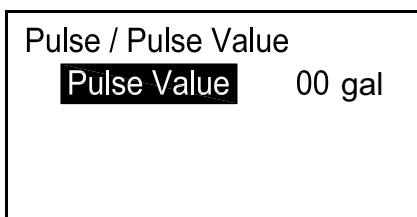

The Pulse Value, the amount of flow represented by one pulse, is displayed. (For example, 1 pulse = 10 gallons.) To change the existing number, press [√] and a screen similar to the following appears.

Note: *The units that appear will be the units selected in “Flow Units” on page 36.*

3.6.3b Setting the Pulse (cont.)

PulseValue / Pulse Value

0 m/s

[✓]SAVE [x]QUIT

[◀▶]MOVE [▲▼]MODF

To change the Pulse Value, use the [△] or [▽] arrow key to provide a new number and press [√] to save. Press [✕] to return to the Pulse menu.

DO1 / Pulse

Pulse Value

Min Pulse

Test Pulse Output

Error Handling

To view and/or change another Pulse characteristic, select the desired sub-category and follow the procedure:

- To enter the Minimum Pulse ON Time (Min Pulse), you set the width of the pulse in seconds.
- To test the pulse output, enter a number of pulses and the instrument will send that many out. Note on your measurement system that the right number of pulses were received.
- If Error Handling is selected, a different procedure is required. See the next below.

DO1 / Pulse

Pulse Value

Min Pulse

Test Pulse Output

Error Handling

To change the Error Handling status, select it on the screen and press [√]. The following screen appears.

Pulse / Error Handling

- **Hold**
- Stop

Select Hold or Stop. Hold directs the meter, in case of a flow measurement error, to keep sending the pulses sent at the last good reading. Stop directs the meter, in case of measurement error, to stop pulsing. Press [√], and the screen returns to the previous display. Press [✕] to return to the Digital Output Menu.

3.6.3c *Setting the Frequency*

DO / DO1	
Pulse	▲
Frequency	
Alarm	
Control Output	▼

Frequency sends out a continuous square wave, with the frequency proportional to a measured value. To set the Digital Output as a frequency output, in the Digital Output Menu select Frequency and press [√]. The following screen appears.

DO / Frequency	
Measurement	▲
Frequency Value	
Base Value	
Full Value	▼

To set the measurement type, select Measurement and press [√]. The following screen appears.

Freq / Measurement	
Velocity	▲
Avol	
Svol	
Mass	▼

Select the type of measurement to be used and press [√]. The screen returns to the Frequency display. Two examples are shown below.

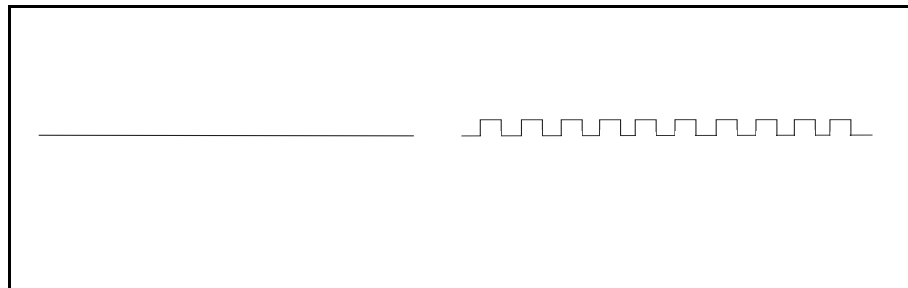
**Example 1**

Base: 0 m/s = 0 Hz

Full: 10 m/s = 100 Hz

Then: $y \text{ Hz} = x \text{ (m/s)} \bullet 10 \text{ Hz}$

Example 2

Base: 10 kg = 0 Hz

Full: 20 kg = 10 Hz

Then: $y \text{ Hz} = (x \text{ kg} - 10) \bullet 1000 \text{ Hz}$

3.6.3c Setting the Frequency (cont.)

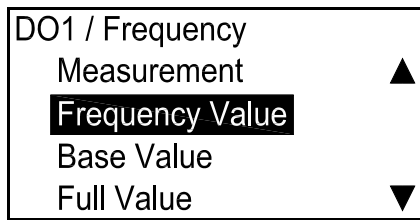

To check the current frequency value, on the Frequency display select Frequency Value and press [√]. A screen similar to the following appears.

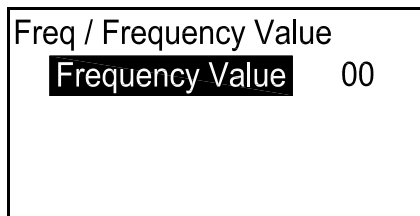

To change the current value, press [√] and proceed as in “Setting the Pulse Output” on page 51.

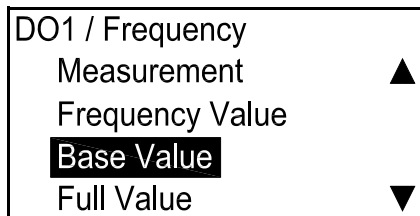

The Base Value is the measurement value represented by 0 Hz. To check the current base value, on the Frequency display select Base Value and press [√]. A screen similar to the following appears.

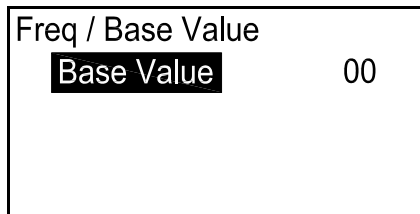

To change the current value, press [√] and proceed as in “Setting the Pulse Output” on page 51.

Note: The units that appear will be the units selected in “Flow Units” on page 36.

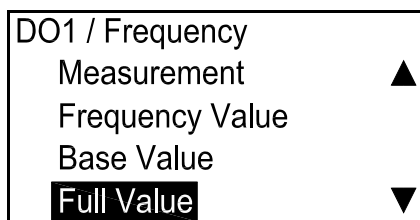

The Full Value is the measurement value represented by the full frequency. To check the current full value, on the Frequency display select Full Value and press [√]. A screen similar to the following appears.

Note: The units that appear will be the units selected in “Flow Units” on page 36.

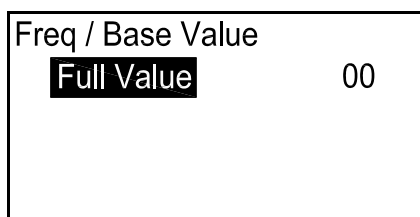

To change the current value, press [√] and proceed as in “Setting the Pulse Output” on page 51.

3.6.3c Setting the Frequency (cont.)

DO1 / Frequency	
Frequency Value	▲
Base Value	
Full Value	
Full Frequency	▼

The Full Frequency is the maximum Hz, which represents the Full Value of measurement. To check the current full frequency, on the Frequency display select Full Frequency and press [√]. A screen similar to the following appears.

Freq / Full Frequency	
Full Frequency	00 Hz

To change the current full frequency, press [√] and proceed as in “Setting the Pulse Output” on page 51.

DO1 / Frequency	
Base Value	▲
Full Value	
Full Frequency	
Test Frequency	▼

To check the current test frequency status, on the Frequency display select Test Frequency and press [√]. A screen similar to the following appears.

TestFreq / Test Frequency	
Test Frequency	00

To change the current test frequency, press [√]. Set a Hz value. The meter will set the digital output to this value. Then verify at your measurement system that you see the frequency you entered. You can repeat this procedure with several frequencies.

DO1 / Frequency	
Full Value	▲
Full Frequency	
Test Frequency	
Err Handling	▼

To check the current error handling status, on the Frequency display select Err Handling and press [√]. A screen similar to the following appears.

3.6.3c Setting the Frequency (cont.)

Freq / Error Handling	
• Hold	
Low	
High	
Other	

To change the current error handling status, select the option desired and press [√]. The screen returns to the previous display. You have four options for error handling in case of a measurement error:

- Hold — hold last good value.
- Low — show 0 Hz.
- High — show Full Frequency.

Note: *If Other is selected, a screen similar to the following appears.*

Err Handling / Other	
Other	00

Enter the Hz value you want to appear for error. (For example, if Full = 10 kHz, you may want to set Error to 2 kHz.) Press [√] again, and a screen similar to the following appears.

Other / Other	
0	Hz
[√]SAVE	[x]QUIT
[◀▶]MOVE	[▲▼]MODF

Use the [△] or [▽] arrow key to change the Other value and press [√] to save the number. Press [✕] to return to the previous screen.

3.6.3d *Setting the Alarm*

DO / DO1	
Pulse	▲
Frequency	
Alarm	
Control Output	▼

The alarm can be an open or a short circuit, depending on the error condition. To check the alarm and/or change its settings, in the Digital Output menu select Alarm and press [√]. The following screen appears.

DO1 / Alarm	
Alarm State	▲
Alarm Type	
Measurement	
Alarm Value	▼

To check and/or change the alarm status, select Alarm State and press [√]. A screen similar to the following appears.

Alarm / Alarm State	
● Close	
Open	
Fail safe	

Three alarm states are available:

- Close — Short circuit when no error, open when alarm
- Open — Normally open, close for alarm
- Fail Safe — Close

To change the state of the alarm, select the desired status and press [√]. The screen returns to the previous display.

DO1 / Alarm	
Alarm State	▲
Alarm Type	
Measurement	
Alarm Value	▼

To check and/or change the type of alarm, select Alarm Type and press [√]. A screen similar to the following appears.

3.6.3d Setting the Alarm (cont.)

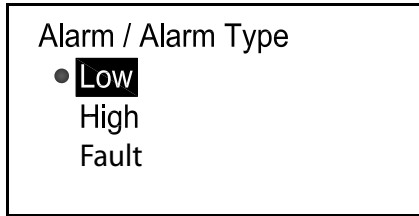

You can choose from three alarm types:

- Low — No alarm if measurement is greater than the threshold, alarm if measurement is less than or equal to the threshold
- High — No alarm if measurement is less than the threshold, alarm if measurement is greater than or equal to the threshold
- Fault — No alarm if no errors, alarm if errors.

To change the type of alarm, select the appropriate type and press [√]. The screen returns to the previous display.

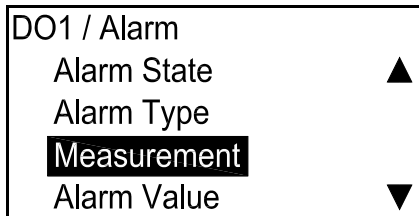

To check and/or change the type of alarm measure, select Measurement and press [√]. A screen similar to the following appears.

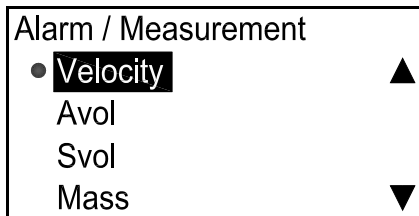

Select the type of measure desired, press [√], and the screen returns to the previous display.

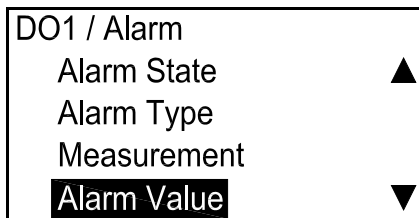

The Alarm Value is the threshold that trips the alarm. (This parameter does not apply to Fault Alarms.) To check and/or change the alarm value, select Alarm Value and press [√]. A screen similar to the following appears.

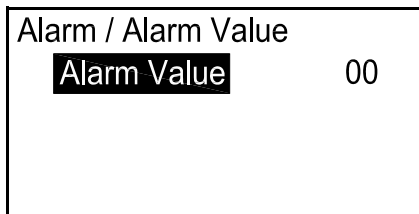

Press [√] again, and a screen similar to the following appears.

Note: *The units that appear will be the units selected in “Flow Units” on page 36.*

3.6.3d Setting the Alarm (cont.)

Alarm Value / Alarm Value	
0	Ft/s
[<input checked="" type="checkbox"/>]SAVE	[x]QUIT
[<input type="checkbox"/>]MOVE	[<input type="checkbox"/>]MODF

Use the [Δ] or [∇] arrow key to change the Alarm Value setting. Press [\surd] to save the number and press [\times] to return to the previous screen.

DO1 / Alarm	
Alarm Type	▲
Measurement	
Alarm Value	
Test Alarms	▼

To test the alarms, in the Alarm menu select Test Alarms and press [\surd]. A screen similar to the following appears.

OFF	
ON	
[<input checked="" type="checkbox"/>]TEST	[x]QUIT

Select OFF to turn the alarm off, or ON to turn it on. To begin testing, select ON and press [\surd]. To stop testing, press [\times].

Note: *Be sure to select OFF when you end the test.*

3.6.3e Setting the Control Output

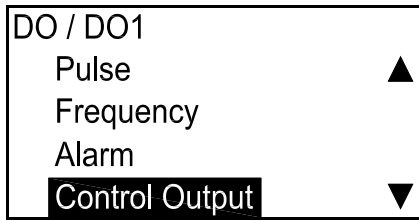

The Control Output can drive an actuator to control a process. It deactivates until a threshold is reached, and activates when it is reached. To check the control output and/or change its settings, in the Digital Output menu select Control Output and press [√]. The following screen appears.

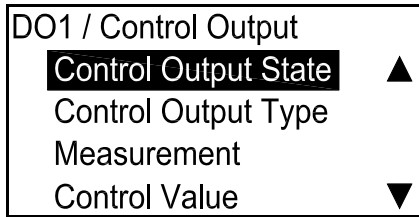

To check and/or change the control output status, select Control Output State and press [√]. A screen similar to the following appears.

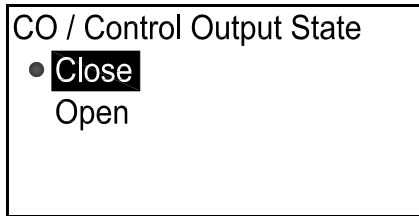

The Close option is 0 V when deactivated, 3.3 V when activated. Open is 3.3 V when deactivated, 0 V when activated. To change the state of the control output, select the desired status and press [√]. The screen returns to the previous display.

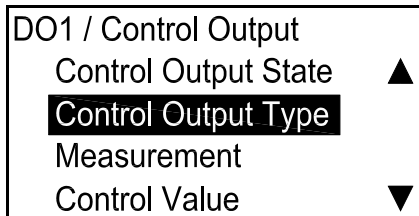

To check and/or change the type of control output, in the Control Output menu, select Control Output Type and press [√]. The following screen appears.

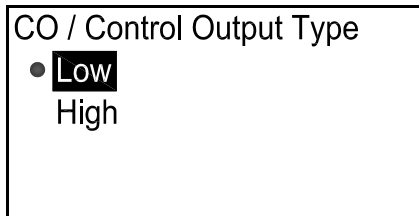

The Low control output activates when the measurement is less than or equal to a threshold, while the High control output activates when the measurement is greater than or equal to a threshold. Low is useful for draining applications, and High for filling applications. To change the type of control output, select the desired type and press [√]. The screen returns to the previous display.

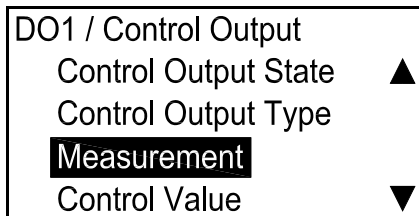

To check and/or change the measurement setup, in the Control Output menu, select Measurement and press [√]. The following screen appears.

3.6.3e Setting the Control Output (cont.)

CO / Measurement
• Batch Total
Inventory Total

Batch Total supports fill and reset operations. The Inventory Total activates after a user-specified number of kg of usage: for example, at 1000 kg, then 2000 kg, etc. To change the measurement style, select the desired style and press [√]. The following screen appears.

Measure /
• Forward
Reverse
Net

Select Forward or Reverse totalizer, depending on the flow direction, or Net for both filling and draining. To change the measurement direction, select the desired direction and press [√]. The screen returns to the previous display.

DO1 / Control Output
Control Output State ▲
Control Output Type
Measurement
Control Value ▼

To check and/or change the control value, in the Control Output menu, select Control Value and press [√]. A screen similar to the following appears.

CO / Control Value	
Control Value	00

Press [√] again, and a screen similar to the following displays the threshold value to activate.

ContValue / Control Value	
0	GAI
[√]SAVE	[x]QUIT
[◀▶]MOVE	[▲▼]MODF

Use the [△] or [▽] arrow key to change the Control Value setting. Press [√] to save the number and press [✕] to return to the previous screen.

Note: The units that appear will be the units selected in “Flow Units” on page 36.

3.6.3e Setting the Control Output (cont.)

DO1 / Control Output
Control Output Type ▲
Measurement
Control Value
Test Control ▼

To test the actuator, in the Control Output menu select Test Control and press [√]. A screen similar to the following appears.

OFF
ON
[√]TEST [x]QUIT

To begin testing, select ON and press [√]. To stop testing, select OFF and press [√]. Press [x] to return to the Control Output menu.

Note: Be sure to select OFF when you end the test.

3.6.4 Modbus/Service Port A

I/O / Option D
Digital Output
Modbus/Service Port

To set up the Modbus/Service Port, select it on the Option A screen and press [√]. The following screen appears.

3.6.4a Selecting the Baud Rate

Option A / Modbus / Service
Baud Rate ▲
Modbus Parity
UART Bits
Address ▼

To set the baud rate, in the Modbus/Service menu select Baud Rate and press [√]. A screen similar to the following appears.

Modbus / Service Port / Baud
● 2400
4800
9600
19200 ▼

The default baud rate is 115200. Select the appropriate baud rate and press [√]. The screen returns to the previous display.

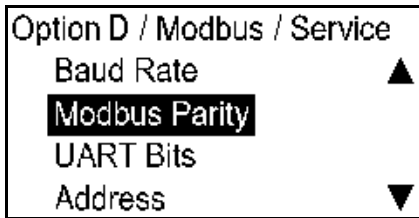
3.6.4b *Setting the Modbus Parity*

To set the modbus parity, in the Modbus/Service menu select Modbus Parity and press [√]. A screen similar to the following appears.

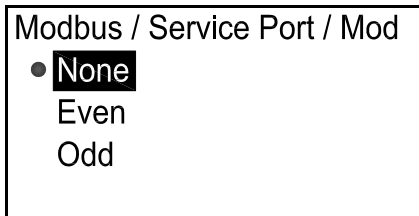

Select the appropriate characteristic and press [√]. The screen returns to the previous display.

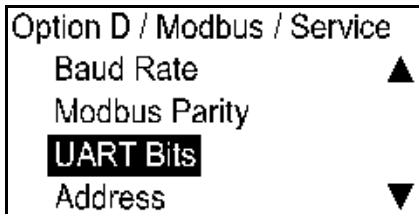
3.6.4c *Selecting the UART Bits*

To set the UART bits, in the Modbus/Service menu select UART Bits and press [√]. A screen similar to the following appears.

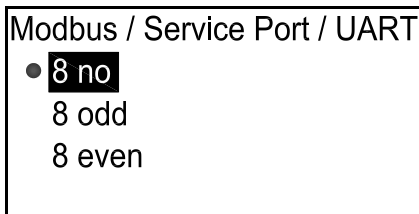

Select the appropriate description and press [√]. The screen returns to the previous display.

3.6.4d *Setting the Modbus/Service Port Address*

```

Option D / Modbus / Service
  Baud Rate      ▲
  Modbus Parity
  UART Bits
  Address        ▼
  
```

To set the address, in the Modbus/Service menu select Address and press [√]. A screen similar to the following appears.

```

Modbus / Service Port / Addr
  Address        00
  
```

Press [√] again, and a screen similar to the following appears.

```

Address / Address
  1
  [ √ ]SAVE [ x ]QUIT
  [ ◀▶ ]MOVE [ ▲▼ ]MODF
  
```

Use the [△] or [▽] arrow key to change the address number (from 1 to 256, but not 0) and press [√]. Press [✕] to return to the previous screen.

3.6.4e *Setting the Number of Modbus Stop Bits*

```

Option D / Modbus / Service
  Modbus Parity  ▲
  UART Bits
  Address
  Modbus Stop Bits ▼
  
```

To set the number of stop bits, in the Modbus/Service menu select Modbus Stop Bits and press [√]. A screen similar to the following appears.

```

Modbus / Service Port / Mod
  ● 1
  2
  
```

Select the appropriate number and press [√]. The screen returns to the previous display.

3.7 Test Menu

Note: To enter the Test menu, you must enter a password.

3.7.1 Accessing the Test Menu

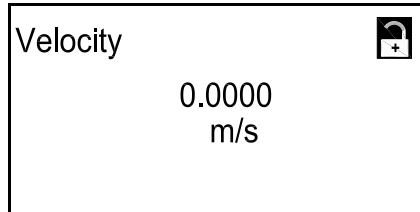

To access the Analog Output menu, on the initial screen, highlight the lock symbol and press [√]. The following screen appears.

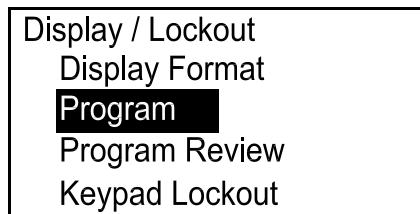

Select Program and press [√]. The following screen appears.

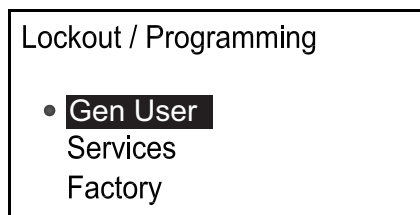

Select a password level from the Program Menu and press Enter. The following screen appears.

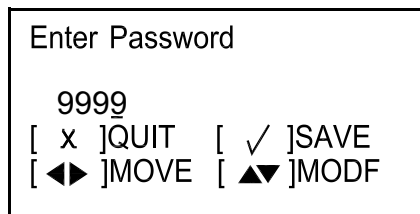

To enter the password, use the Left and Right arrow keys to select the digit to be changed, use the [△] or [▽] arrow keys to change the value of each digit, and press [√]. The following screen appears.

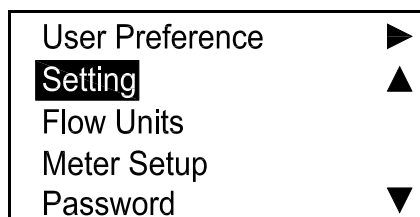

In the User Preference menu, select Setting, then press the **right arrow key twice**. A screen similar to the following appears.

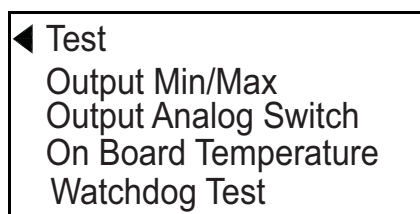

The screen shows the four option selections. Select Output Min/Max and press [√]. The following screen appears

3.7.2 Testing the Min/Max Output

```

Output Min/Max
  Fire Low
  Fire High
  • Percentage of Scale
  
```

To test the minimum or maximum output, use the arrow keys to select Fire Low (minimum), Fire High (maximum) or enter a Percentage of Scale, and press [√]. If you have selected Percentage of Scale, the following screen appears:

```

Percentage of Scale
UNIT: %
      0.00
[ √ ]SAVE  [ x ]QUIT
[ ◀▶ ]MOVE [ ▲▼ ]MODF
  
```

Use the arrow keys to enter the desired percentage, and press [√]. Press [✕] to return to the Test menu.

3.7.3 Testing the Output Analog Switch

```

Output Analog Switch
  Open Switch
  • Close Switch
  
```

From the Test menu, select Output Analog Switch and press [√]. Use the arrow keys to select Open Switch or Close Switch, and press [√]. Press [✕] to return to the Test menu.

3.7.4 Viewing the On Board Temperature

```

On Board Temperature

28.75      C
  
```

To check the on board temperature, select On Board Temperature and press [√]. The screen displays the current temperature.

3.7.5 Performing a Watchdog Test



CAUTION! The *Watchdog Test* will reset the flow meter and discard any program parameter changes. Do not execute this test if you have changed parameter settings.

```

Watchdog Test
  • No
  Yes
  
```

To conduct a watchdog test, select Watchdog Test and press [√]. Use the arrow keys to select Yes and press [√]. The program runs the Watchdog Test, and displays the results on the screen. Press [√] to return to the active display.

Chapter 4. Error Codes and Troubleshooting

4.1 User Restrictions

If a system error state occurs, the flow meter will put the Analog Output in the DD state and remain that way until an Authorized User intervenes. The DD state can be cleared by executing a reset of the flow meter. There are two methods for clearing the DD state:

1. Enter the Program menu at any user access level. Then exit without making any changes. The flow meter will execute a soft reset.
2. Turn off power, wait 1 minute, turn power back on.

4.2 Error Display in the User Interface

The bottom line of the LCD displays a single, top priority error message during Measurement Mode. This line, called the Error Line, includes two parts: Error Header and Error String. The Error Header indicates the error pattern and error number, while the Error String gives a detailed description of the error information.

4.2.1 Error Header

Table 3: Error Header

Error Pattern	Error Header
Communication error	Cn(n is error number)
Flow error	En(n is error number)
System error	Sn (n is error number)

4.2.2 Communication Error String

The PanaFlow Z3 flow meter electronics includes two independent sub-systems. The purpose of the Communication Error String (see *Table 4* and *Figure 22* below) is to convey to the operator an issue with communication between these two sub-systems.

Table 4: Communication Error String

Error Header	Error Message
C1	UMPU Comm error



Figure 22: Communications Error String

4.2.3 Flow Error String

Flow errors are errors detected by the UMPU (Ultrasonic Measurement Processing Unit) in the course of making a flow measurement. These errors can be caused by disturbances in the fluid, such as excessive particles in the flow stream or extreme temperature gradients. The errors could also be caused by an empty pipe or other such issue with the fluid itself. Flow errors are typically not caused by a malfunction of the flow meter, but by an issue with the fluid itself. See *Table 5* below for a list of possible flow error messages.

Table 5: Flow Error String

Error Header	Error Message	Explanation
E29	VelocityWarning	E29 indicates that the flow rate has exceeded the range of the LWL (lower warning limit) or UWL (upper warning limit). The purpose of this warning is to alert the operator that the flow rate is approaching the LFL (lower functional limit) or the UFL (upper functional limit). At the Warning Limit threshold, the flow meter will continue to measure flow and drive the analog output, but if the flow rate reaches the Functional Limit threshold the output will go to the Dangerous Detected state until an Authorized User intervenes. E29 gives the operator a chance to correct the situation before going to the DD state.
E22	SingleChAccuracy	E22 indicates that an error was detected on one of the flow channels. This applies to multiple channel systems only. For example, there may be an issue in the channel 1 measurement but not the channel 2 measurement.
E23	MultiChAccuracy	E23 indicates an error on multiple channels.
E15	ActiveTw	E15 indicates an error with the active Tw measurement. This may be caused by a transducer error, a parameter programming error, or extreme process temperatures. The error means that the measurement of how long it is taking the ultrasonic signal to pass through the bundled waveguide is outside reasonable limits.

Table 5: Flow Error String (cont.)

Error Header	Error Message	Explanation
E6	CycleSkip	E6 indicates that a cycle skip has occurred in the signal processing measurement. This is usually due to poor signal integrity, possibly because of bubbles in the pipeline, sound absorption by very viscous fluids, or cavitation.
E5	Amplitude	E5 indicates an amplitude error in the signal processing measurement. The signal amplitude is either excessively high or low. This is also due to poor signal integrity, much like an E6 error.
E4	SignalQuality	E4 indicates a Signal Quality error. This means the signal shape, upstream to downstream reciprocity, or signal correlation value is poor. The cause is usually the same as E6 or E5.
E3	VelocityRange	E3 is a velocity range error, meaning that the calculated velocity is outside the velocity limits defined for this application. The velocity we are measuring is not reasonable for the fluid and pipe size programmed in the data set. This could be a programming error, a poor signal, or an actual flow condition that is unexpectedly high in the positive or negative direction.
E2	SoundSpeed	E2 is a sound speed error. One benefit of ultrasonic flow measurement is that the process can determine the sound speed of the fluid. If this sound speed is beyond the limits set for the programmed application, an E2 error is set. This can alert the operator that the wrong fluid is in the pipe, or that the program parameters are out of date. It may also occur if signal quality is poor.
E1	SNR	E1 indicates a low signal to noise ratio (SNR). This means the flow meter is not getting very much acoustic signal from the process. This could be due to bubbles or other fluid conditions, an empty pipe, or other possible causes that are listed in the Diagnostics section.
E31	NotCalibrated	E31 is an indication that the flow meter has not been calibrated. This means we cannot be sure of flow measurement accuracy.

Note: *The flow errors in Table 4 above are listed in order of increasing priority. For troubleshooting tips, see “Diagnostics” on page 70.*

4.2.4 System Error String

System errors are faults detected during internal device monitoring of the flow measurement circuitry. These errors show that there may be a failure of a hardware component of the flow meter. The user should attempt to clear the error by completing the steps in “*User Restrictions*” on page 67. If these actions do not clear the error, contact Technical Support at 978-437-1000.

Under normal operation, only S1 - “*In Config Mode*” is likely to appear on the error line. This is an indication that the instrument is currently not measuring flow, because the instrument is in the Configuration mode. It also warns the Operator that the Analog Output is not to be used as part of the SIS while in this mode of operation.

For troubleshooting details and more information on “S” errors, consult the *Safety Manual*.

Note: *Few of these errors will appear on the LCD. The LCD only shows the top priority error at any time.*

Vitality software will list these error conditions in addition to the top priority error, as the PC display can show more information.

4.3 Diagnostics

4.3.1 Introduction

This section explains how to troubleshoot the PanaFlow Z3 if problems arise with the electronics enclosure, the flowcell, or the transducers. Indications of a possible problem include:

- Display of an error message on the LCD display screen, Vitality PC software, or HART.
- Erratic flow readings
- Readings of doubtful accuracy (i.e., readings that are not consistent with readings from another flow measuring device connected to the same process).

If any of the above conditions occurs, proceed with the instructions presented in this chapter.

4.3.2 Meter Body Problems

If preliminary troubleshooting with the *Error Code Messages* and/or the *Diagnostic Parameters* indicates a possible flowcell problem, proceed with this section. Read the following sections carefully to determine if the problem is indeed related to the flowcell. If the instructions in this section fail to resolve the problem, contact GE for assistance.

Most fluid-related problems result from a failure to observe the flow meter system installation instructions. Refer to Chapter 2, *Installation*, to correct any installation problems.

If the physical installation of the system meets the recommended specifications, it is possible that the fluid itself may be preventing accurate flow rate measurements. The fluid being measured must meet the following requirements:

1. *The fluid must be homogeneous, single-phase, relatively clean and flowing steadily.* Although a low level of entrained particles may have little effect on the operation of the PanaFlow Z3, excessive amounts of solid or gas particles will absorb or disperse the ultrasound signals. This interference with the ultrasound transmissions through the fluid will cause inaccurate flow rate measurements. In addition, temperature gradients in the fluid flow may result in erratic or inaccurate flow rate readings.
2. *The fluid must not cavitate near the flowcell.* Fluids with a high vapor pressure may cavitate near or in the flowcell. This causes problems resulting from gas bubbles in the fluid. Cavitation can usually be controlled through proper installation design.
3. *The fluid must not excessively attenuate ultrasound signals.* Some fluids, particularly those that are very viscous, readily absorb ultrasound energy. In such a case, an error code message will appear on the display screen to indicate that the ultrasonic signal strength is insufficient for reliable measurements.
4. *The fluid sound speed must not vary excessively.* The PanaFlow Z3 will tolerate relatively large changes in the fluid sound speed, as may be caused by variations in fluid composition and/or temperature. However, such changes must occur slowly. Rapid fluctuations in the fluid sound speed, to a value that is considerably different from that programmed into the PanaFlow Z3, will result in erratic or inaccurate flow rate readings. Refer to Chapter 3, *Initial Setup*, and make sure that the appropriate sound speed is programmed into the meter.
5. *The inside of the meter body must be relatively clean.* The inside of the pipe or flowcell must be relatively clean. Excessive build up of scale, rust or debris will interfere with flow measurement. Generally, a thin coating or a solid well-adhered build up on the pipe wall will not cause problems. Loose scale and thick coatings (such as tar or oil) will interfere with ultrasound transmission and may result in incorrect or unreliable measurements.
6. *Corrosion damage to the meter body* If the meter body materials (meter body, o-rings, and buffer) were not properly chosen for the intended application, they may suffer corrosion damage. If corrosion is suspected, remove the meter body from service. Contact GE for additional information.

[no content intended for this page]

Appendix A. Specifications

A.1 Operation and Performance

Fluid Types

Liquids: Acoustically conductive fluids, including most clean liquids, and many liquids with limited amounts of entrained solids or gas bubbles.

Flow Measurement

Patented Correlation Transit-Time™ mode.

Accuracy

±0.5% of reading for velocities above 1.6 ft/s (0.5 m/s)
±2.5 mm/s of reading for velocities below 1.6 ft/s (0.5 m/s)

Accuracy statement assumes measurement of a single phase homogenous liquid with a fully developed symmetrical flow profile passing through the meter. Applications with piping arrangements that create an asymmetrical flow profile may require extended piping straight runs and/or flow conditioning for the meter to perform to this specification.

Calibration

All meters are calibrated and include a calibration certificate.

Repeatability

±0.2% of reading

Range (Bidirectional)

0.1 to 40 ft/s (0.03 to 12.19 m/s)

Rangeability (Overall)

400:1

Classifications

US/CAN - Explosion-proof Class 1, Division 1, Groups B, C, and D, IP67
ATEX - Flameproof II 2 G Ex d IIB+H2 T6 Gb Ta = -40°C to +60°C; IP67
IECEX - Flameproof Ex d IIB+H2 T6 Gb Ta = -40°C to +60°C; IP67
Exempted from ROHS compliance (Category 9)
WEEE Compliance

A.2 Meter Body/Transducer

Meter Sizes

Standard: 3 to 8 in (80 to 200 mm)

Meter Body Materials

Carbon steel (ASTM SA216 Gr. WCB)

Stainless steel (ASTM SA351 Gr. CF8M)

Transducer System and Material

LX transducers with inserts (patent pending)

316L SS

Seals: FKM or EPDM

Process Temperature Ranges

-40°F to 185°F (-40°C to 85°C)*

* Carbon steel material has -20°F (-28.9°C) minimum operating temperature; if insulating the meter body, the maximum process temperature is 80°C and maximum ambient temperature is 50°C.

Pressure Range

Up to maximum allowable flange operating pressure at temperature

A.3 Electronics

Enclosures

Epoxy coated, copper-free, aluminum, weatherproof (IP67)

Electronics Mounting

Local mounting (on meter body)

Paths

Three paths

Display Languages

English

Keypad

Built-in magnetic, six-button keypad, for full functionality operation

Inputs/Outputs

One analog output with HART**; one additional analog output**; two digital* outputs, service/Modbus (RS485) output, calibration output (see *Table 6* below and *Table 7 on page 76*).

*Digital outputs are programmable as either pulse, frequency, alarm, or control outputs

Table 6: I/O Terminal Block

Output	I/O Type	Connection	Specifications
Output A	Analog Output + HART	Active Output	Output current: 0-22 mA Max load: 600 Ω
Output B (Option B only)	Analog Output	Active Output	Output current: 0-22 mA Max load: 600 Ω
Output C	Pulse, Frequency, Alarm or Control	Active Output	Output voltage: 5 VDC Max voltage with light load: 7 VDC Includes integrated current limit resistor. Customer current limitation not required.
Output D	Pulse, Frequency, Alarm or Control	Active Output	Output voltage: 5 VDC Max voltage with light load: 7 VDC Includes integrated current limit resistor. Customer current limitation not required.

A.3 Electronics (cont.)

Table 7: Modbus/Cal Terminal Block

Output	I/O Type	Connection	Specifications
Modbus	RS485	RS485 Communications	Standard RS485 communications port
Cal Out	Frequency Output	Passive Output	Max customer supply voltage: 30 VDC Max current draw: 200 mA Recommended load: 300 Ω

Power Supplies

Standard: 100 to 240 VAC (50/60 Hz)

Optional: 12 to 28 VDC

Power Consumption

10 watts maximum

Wiring Connection

All conduit entries are M20

3/4 in NPT can be ordered (with adapter)

Operating Temperature

-40° to 140°F (-40° to +60°C)

Storage Temperature

-40° to 158°F (-40° to +70°C)

Data Logging

Requires Vitality software

XMT910 logging

Appendix B. Menu Maps

The following menu maps are included in this appendix:

- Figure 23, “Display Measurement Menu Map,” on page 81
- Figure 24, “Meter Programming Overview,” on page 82
- Figure 25, “Display Menu Map,” on page 83
- Figure 26, “Input / Output Menu Map,” on page 84
- Figure 27, “Testing Menu Map,” on page 85

[no content intended for this page]

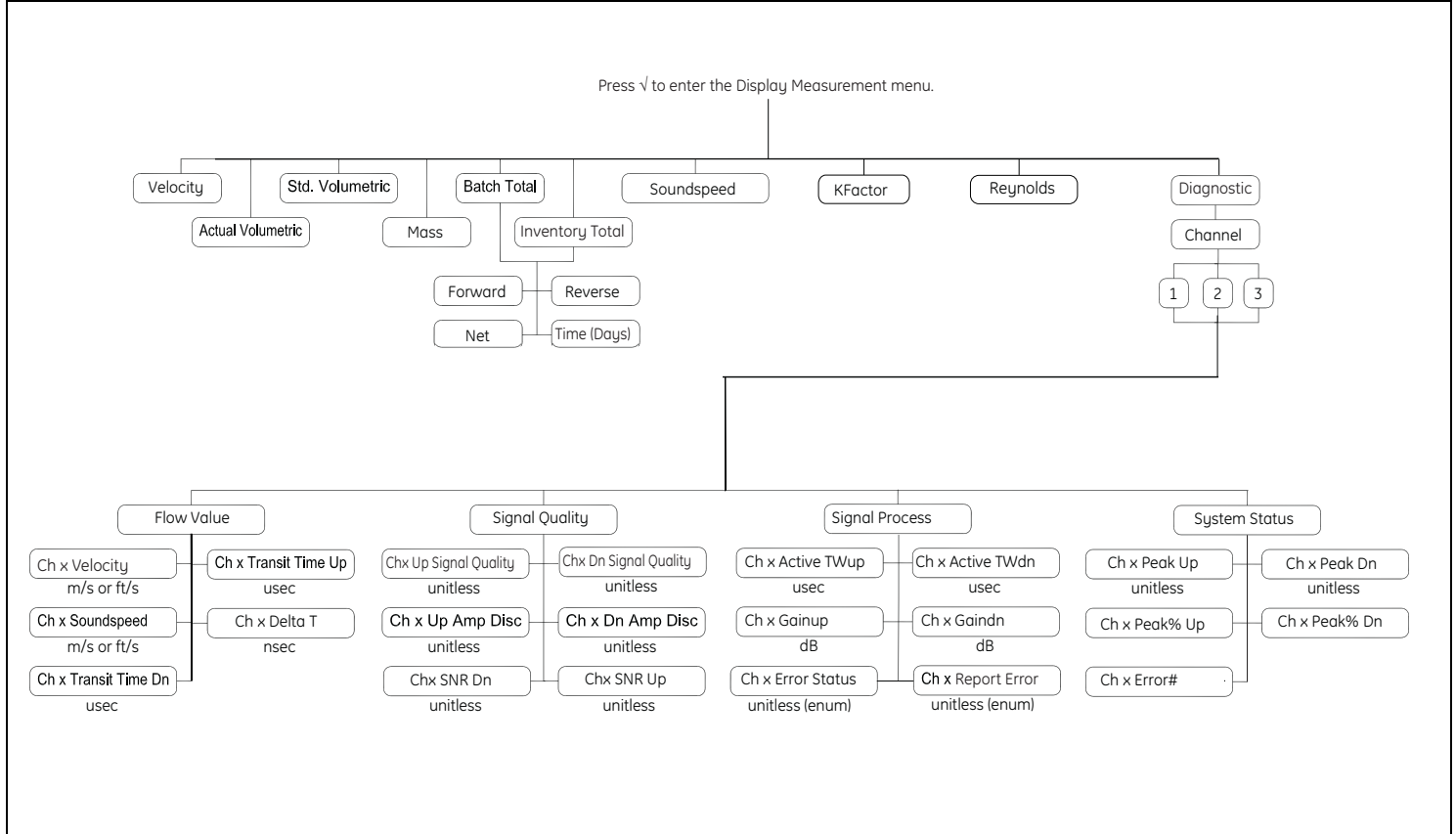

Figure 23: Display Measurement Menu Map

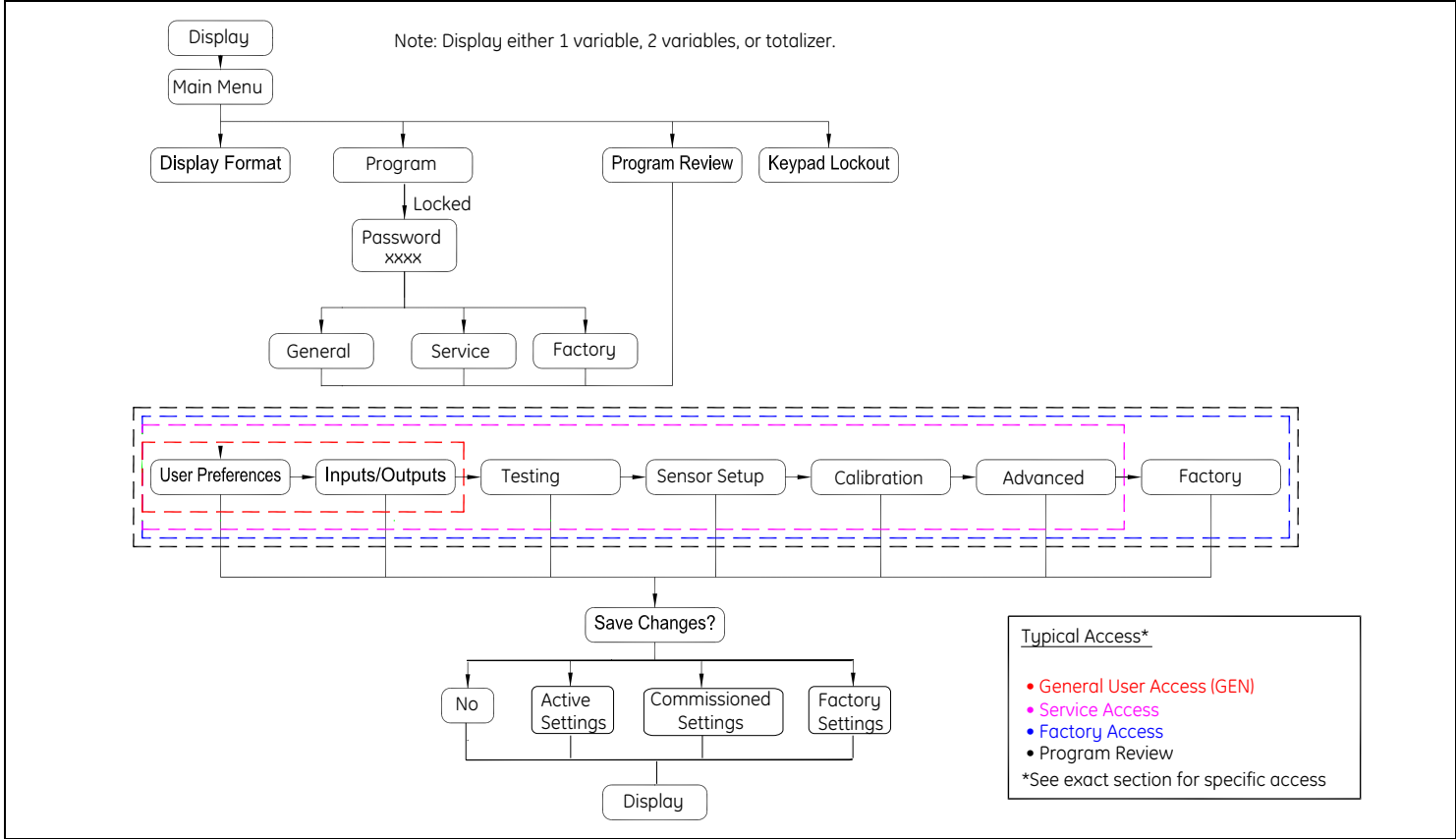

Figure 24: Meter Programming Overview

- Typical Access*
- General User Access (GEN)
 - Service Access
 - Factory Access
 - Program Review
- *See exact section for specific access

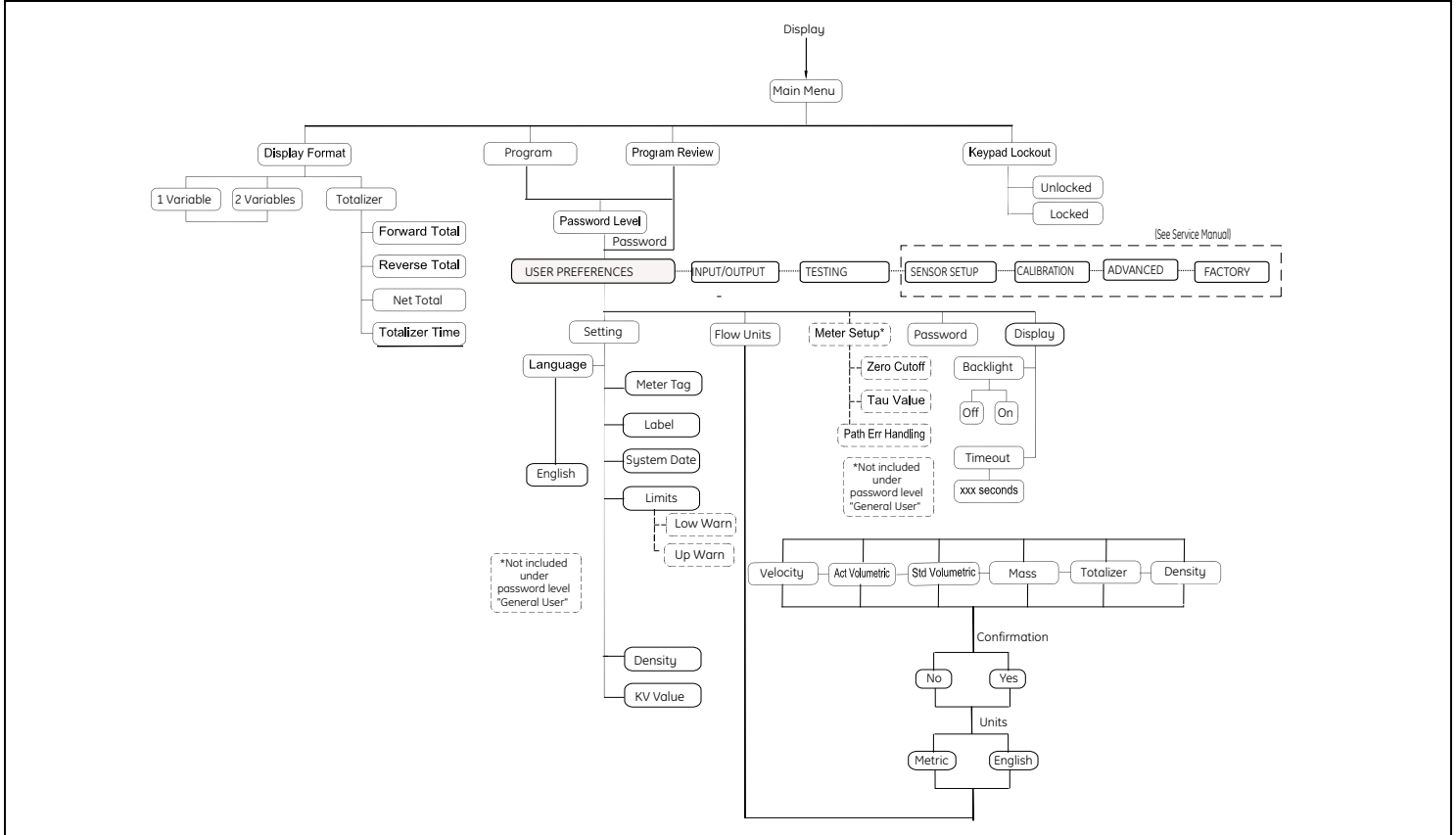

Figure 25: Display Menu Map

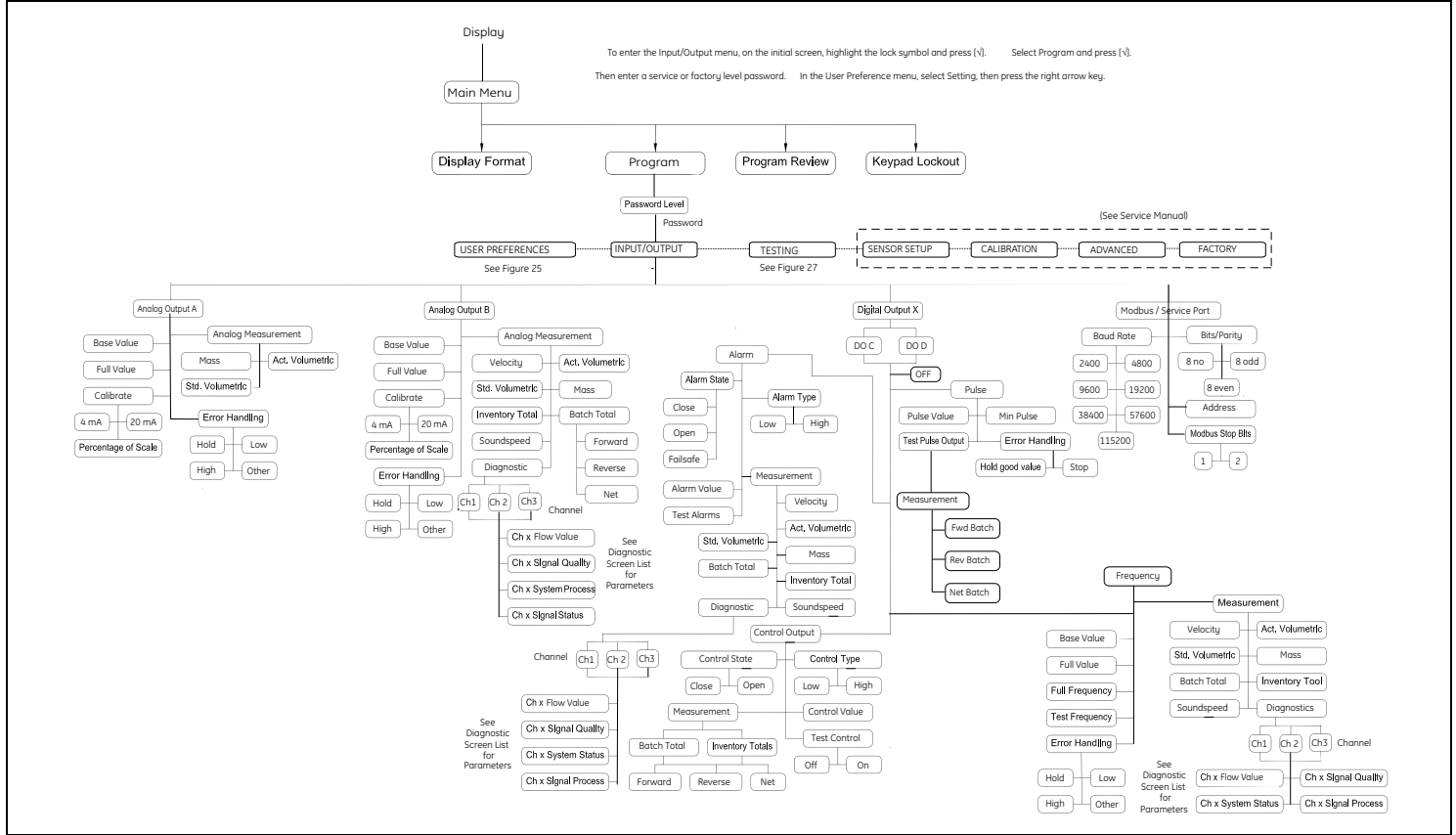

Figure 26: Input / Output Menu Map

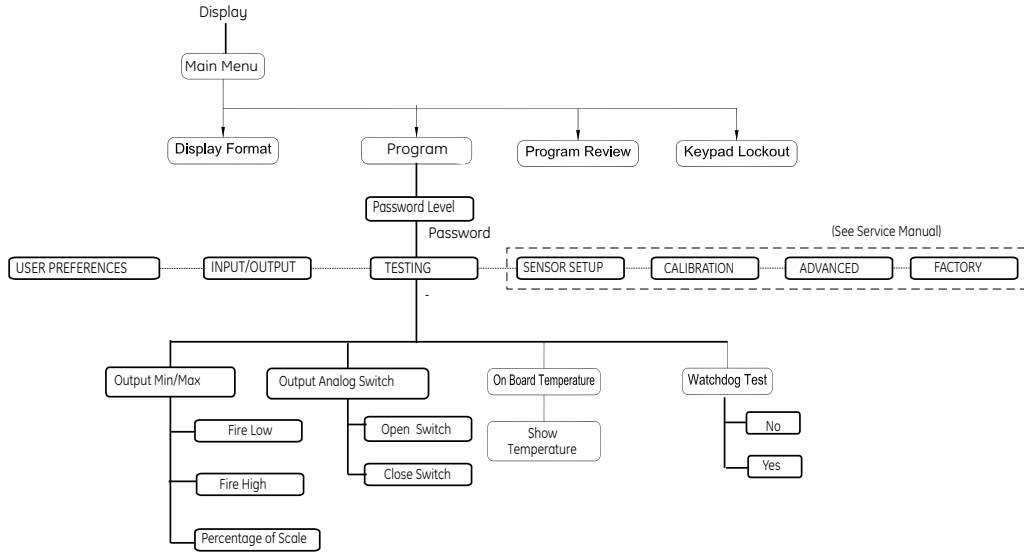

Figure 27: Testing Menu Map

[no content intended for this page]

Appendix C. Modbus Map

C.1 Frequently Used Modbus Addresses

Table 8: Frequently Used Modbus Addresses

Register (in Hex)	Register (in Decimal)	Access Level	Variable	Units	Read Only/ Read Write	Format
5C0	1472	Gen User	Meter Tag	18	RW	CHAR * 16
5C8	1480	Gen User	Long Tag	18	RW	CHAR * 32
740	1856	VIEWER	Master Error (See error code tables)	18	RO	INT32
8200	33280	VIEWER	Composite Velocity	20	RO	(IEEE 32 bit)
8202	33282	VIEWER	Composite Volumetric	1	RO	(IEEE 32 bit)
8204	33284	VIEWER	Composite Mass Flow	9	RO	(IEEE 32 bit)
8206	33286	VIEWER	Composite Fwd Batch Totals	17	RO	(IEEE 32 bit)
8208	33288	VIEWER	Composite Rev Batch Totals	17	RO	(IEEE 32 bit)
820A	33290	VIEWER	Composite Totalizer Time	16	RO	(IEEE 32 bit)
821A	33306	VIEWER	Composite Standard Volumetric	14	RO	(IEEE 32 bit)
821C	33308	VIEWER	Composite Net Batch Totals	17	RO	(IEEE 32 bit)
604	1540	VIEWER	Composite Net Inventory Totals	17	RO	(IEEE 32 bit)
8220	33312	VIEWER	Composite Analog Out Drive Current	8	RO	(IEEE 32 bit)
8302	33538	VIEWER	Composite Errors: ep_Value_Health_Code_I: Use dropdown	18	RO	INT32
8304	33540	VIEWER	Composite Most Significant Error (see Error Tables)	18	RO	INT32
820C	33292	VIEWER	Composite Sound Speed	20	RO	(IEEE 32 bit)
8602	34306	VIEWER	Ch_1 Sound Speed	20	RO	(IEEE 32 bit)
8A02	35330	VIEWER	Ch_2 Sound Speed	20	RO	(IEEE 32 bit)
8618	34328	VIEWER	Ch_1_SNR on UP channel	18	RO	(IEEE 32 bit)
861A	34330	VIEWER	Ch_1_SNR on DOWN channel	18	RO	(IEEE 32 bit)
8A18	35352	VIEWER	Ch_2_SNR on UP channel	18	RO	(IEEE 32 bit)
8A1A	35354	VIEWER	Ch_2_SNR on DOWN channel	18	RO	(IEEE 32 bit)

C.2 User Group Definitions

Table 9: User Group Definitions

Unit Group	Group Name	Valid Unit Codes (See "Unit Codes for XMT910" on page 111)
1	Actual Volumetric	1347, 1348, 1349, 1350, 1351, 1352, 1353, 1354, 1356, 1357, 1358, 1359, 1362, 1363, 1364, 1365, 1371, 1371, 1372, 1372, 1373, 1373, 1374, 1374, 1454, 1454, 1462, 1462, 1485, 1485, 1489, 1489, 1493, 1493, 1548, 1548
2	Day	1060
3	dB	1383
4	Density	1097, 1100, 1103, 1104, 1106, 1107, 1108
5	Dimension	1013, 1019
6	Hz	1077
7	Viscosity	1160, 1164
8	mA	1211
9	Mass	1322, 1323, 1324, 1325, 1326, 1327, 1328, 1329, 1330, 1331, 1332, 1333, 1334, 1335, 1336, 1337, 1641, 1642, 1643, 1644
10	Milliseconds	1056
11	Nanoseconds	nsec (pending)
12	Percent	1342
13	Seconds	1054
14	Standard Volumetric	1361, 1360, 1537, 1538, 1539, 1540, 1527, 1528, 1529, 1530
15	Thermal	1001, 1002
16	Totalizer time	1054, 1058, 1059, 1060
17	Totalizer	1034, 1038, 1043, 1051, 1051, 1053, 1088, 1092, 1094, 1526, 1536, 1645, 1664, 1664, 1665, 1666, 1667
18	Unitless	1615
19	Microseconds	1057
20	Velocity	1061, 1067
21	Reynolds number	1615

C.3 Modbus Map

Table 10: Transmitter Modbus Map

Register (in Hex)	Register (in Decimal)	Access Level	Variable	Unit Group	Read Only/Read Write	Format
Health Check and Identification Registers						
20	512		System Error Bits	18	RO	INT32
202	514		Live Runtime	18	RO	INT32
204	516		Transmitter Status 0: Measurement; 1: Calibration;	18	RO	INT32
210	528	NONE	Product Type	18	RO	INT32
212	530	NONE	Product Code	18	RO	CHARx16
222	546	NONE	MPU Serial Number	18	RO	CHARx16
22A	554	NONE	Analog Board Revision	18	RO	CHARx16
232	562	NONE	Application Software Version	18	RO	CHARx16
23A	570	NONE	Boot Loader Software Version	18	RO	CHARx16
242	578	NONE	I/O Board Type	18	RO	INT32
250	592	SERVICE	MPU Baud Rate (Fixed)	18	RW	INT32
252	594	SERVICE	MPU pArity (Fixed) 0: Even, 1: Odd, 2: No	18	RW	INT32
254	596	SERVICE	MPU Number Of Stop Bits (Fixed) 0: No Stop Bits, 1: One Stop Bits, 2: Two Stop Bits	18	RW	INT32
256	598	SERVICE	MPU Modbus node ID (fixed)	18	RW	INT32
258	600	SERVICE	MPU Number Of Bits Per Character (Fixed)	18	RW	INT32
25A	602	SERVICE	MPU is this a termination node? (fixed) 0: Not a termination, 1: Is a termination	18	RW	INT32
System Integer Read/Write						
500	1280	Gen User	Global Unit group 1 for Actual Volumetric	18	RW	INT32
502	1282	Gen User	Global Unit group 2 for Day	18	RW	INT32
504	1284	Gen User	Global Unit group 3 for dB	18	RW	INT32
506	1286	Gen User	Global Unit group 4 for Density	18	RW	INT32
508	1288	Gen User	Global Unit group 5 for Dimension	18	RW	INT32
50A	1290	Gen User	Global Unit group 6 for Hz	18	RW	INT32
50C	1292	Gen User	Global Unit group 7 for Viscosity	18	RW	INT32
50E	1294	Gen User	Global Unit group 8 for mA	18	RW	INT32
510	1296	Gen User	Global Unit group 9 for Mass	18	RW	INT32
512	1298	Gen User	Global Unit group 10 for Milli Second	18	RW	INT32
514	1300	Gen User	Global Unit group 11 for Nano Second	18	RW	INT32
516	1302	Gen User	Global Unit group 12 for Percent	18	RW	INT32
518	1304	Gen User	Global Unit group 13 for Second	18	RW	INT32
51A	1306	Gen User	Global Unit group 14 for Standard Volumetric	18	RW	INT32
51C	1308	Gen User	Global Unit group 15 for Therm	18	RW	INT32
51E	1310	Gen User	Global Unit group 16 for Totalizer time	18	RW	INT32
520	1312	Gen User	Global Unit group 17 for Totalizer	18	RW	INT32

Table 10: Transmitter Modbus Map (cont.)

Register (in Hex)	Register (in Decimal)	Access Level	Variable	Unit Group	Read Only/ Read Write	Format
522	1314	Gen User	Global Unit group 18 for Unitless	18	RW	INT32
524	1316	Gen User	Global Unit group 19 for Micro Second	18	RW	INT32
526	1318	Gen User	Global Unit group 20 for Velocity	18	RW	INT32
528	1320	Gen User	Global Unit group 21 for Reynolds	18	RW	INT32
52A	1322	Gen User	Reserved Global Unit group 22	18	RW	INT32
52C	1324	Gen User	Reserved Global Unit group 23	18	RW	INT32
52E	1326	Gen User	Reserved Global Unit group 24	18	RW	INT32
540	1344	VIEWER	System Request Level	18	RW	INT32
580	1408	SERVICE	PC MODBUS Baud Rate	18	RW	INT32
582	1410	SERVICE	PC MODBUS Parity	18	RW	INT32
584	1412	SERVICE	PC MODBUS Stop Bits	18	RW	INT32
586	1414	SERVICE	PC MODBUS Meter Addr	18	RW	INT32
588	1416	SERVICE	PC MODBUS Bits Per Character	18	RW	INT32
58A	1418	SERVICE	PC MODBUS Termination	18	RW	INT32
5C0	1472	Gen User	Meter Tag	18	RW	CHAR * 16
5C8	1480	Gen User	Long Tag	18	RW	CHAR * 32
5D8	1496	FACTORY	Option Board Type	18	RW	INT32
System Real Read Only						
600	1536	VIEWER	Inventory Fwd Totals	17	RO	(IEEE 32 bit)
602	1538	VIEWER	Inventory Rev Totals	17	RO	(IEEE 32 bit)
604	1540	VIEWER	Inventory Net Totals	17	RO	(IEEE 32 bit)
606	1542	VIEWER	Inventory Totals Time	16	RO	(IEEE 32 bit)
System Integer Read Only						
700	1792	VIEWER	NetworkID_Max	18	RO	INT32
702	1794	VIEWER	NetworkID_Min	18	RO	INT32
704	1796	VIEWER	General User Password	18	RO	INT32
706	1798	VIEWER	MCU Serial Number	18	RO	INT32
708	1800	VIEWER	MCU Bootloader Version	18	RO	INT32
70A	1802	VIEWER	MCU Software Version	18	RO	INT32
70C	1804	VIEWER	MCU Hardware Version	18	RO	INT32
70E	1806	VIEWER	Option Software Version	18	RO	INT32
710	1808	VIEWER	Option Hardware Version	18	RO	INT32
712	1810	VIEWER	MCU Flash CRC	18	RO	INT32
740	1856	VIEWER	Master Error Master Error: See error code tables.	18	RO	INT32
742	1858	VIEWER	MCU Error MCU error: See error code tables.	18	RO	INT32
744	1860	VIEWER	Option Error Option error: See error code tables.	18	RO	INT32
746	1862	VIEWER	MCU Startup Error MCU startup error: See error code tables.	18	RO	INT32

Table 10: Transmitter Modbus Map (cont.)

Register (in Hex)	Register (in Decimal)	Access Level	Variable	Unit Group	Read Only/ Read Write	Format
748	1864	VIEWER	Option Startup Error Option startup error: See error code tables.	18	RO	INT32
Display Integer Read Write						
900	2304	Gen User	Display Language	18	RW	INT32
902	2306	VIEWER	Display Variable_1 Register Address	18	RW	INT32
904	2308	VIEWER	Display Variable_1 Unit Code Address	18	RW	INT32
906	2310	VIEWER	Display Variable_2 Register Address	18	RW	INT32
908	2312	VIEWER	Display Variable_2 Unit Code Address	18	RW	INT32
90A	2314	VIEWER	Display Totalizer_1 Register Address	18	RW	INT32
90C	2316	VIEWER	Display Totalizer_1 Unit Code Address	18	RW	INT32
90E	2318	VIEWER	Display Totalizer_2 Register Address	18	RW	INT32
910	2320	VIEWER	Display Totalizer_2 Unit Code Address	18	RW	INT32
912	2322	VIEWER	Display Graph_1 Register Address	18	RW	INT32
914	2324	VIEWER	Display Graph_1 Unit Code Address	18	RW	INT32
916	2326	Gen User	Select The Velocity	18	RW	INT32
918	2328	Gen User	Select The Actual Volumetric	18	RW	INT32
91A	2330	Gen User	Select The Standardized Volumetric	18	RW	INT32
91C	2332	Gen User	Select Mass	18	RW	INT32
91E	2334	Gen User	Select Totalizer	18	RW	INT32
920	2336	Gen User	Select Density	18	RW	INT32
922	2338	VIEWER	Select Decimal	18	RW	INT32
924	2340	VIEWER	The Type Of DISPLAY	18	RW	INT32
926	2342	Gen User	TimeOut for DISPLAY	13	RW	INT32
928	2344	Gen User	Backlight Control	18	RW	INT32
92A	2346	VIEWER	Lock Menu	18	RW	INT32
92C	2348	Gen User	Unit type for velocity 0: for Metric, 1: for English	18	RW	INT32
92E	2350	Gen User	Unit type for actual volumetric 0: for Metric, 1: for English	18	RW	INT32
930	2352	Gen User	Unit type for standard volumetric 0: for Metric, 1: for English	18	RW	INT32
932	2354	Gen User	Unit type for mass 0: for Metric, 1: for English	18	RW	INT32
934	2356	Gen User	Unit type for totalizer 0: Avol, 1: Svol, 2:Mass	18	RW	INT32
936	2358	Gen User	Unit type for Actual volumetric of totalize 0: for Metric, 1: for English	18	RW	INT33
938	2360	Gen User	Unit type for Standard volumetric of totalizer 0: for Metric, 1: for English	18	RW	INT34
93A	2362	Gen User	Unit type for Mass of totalizer 0: for Metric, 1: for English	18	RW	INT35
93C	2364	Gen User	Unit type for Density 0: for Metric, 1: for English	18	RW	INT32

Table 10: Transmitter Modbus Map (cont.)

Register (in Hex)	Register (in Decimal)	Access Level	Variable	Unit Group	Read Only/ Read Write	Format
Display Integer Read Only						
B00	2816	VIEWER	Maximum TimeOut for DISPLAY	18	RO	INT32
B02	2818	VIEWER	Minimum TimeOut for DISPLAY	18	RO	INT32
Log Integer Read Write						
D00	3328	Gen User	Log Control / Status	18	RW	INT32
D02	3330	Gen User	Log Interval	13	RW	INT32
D04	3332	Gen User	Logging Time	13	RW	INT32
D06	3334	Gen User	Number Of Variables To Log	18	RW	INT32
D40	3392	Gen User	Variable Address Array	18	RW	INT32
D80	3456	Gen User	Variable Unit Code Array	18	RW	INT32
Log Integer Read Only						
F00	3840	N/A	Number of Records	18	RO	INT32
Analog Out 2 Real Read Write						
1000	4096	Gen User	Analog Out 2 Error Handling Value	8	RW	(IEEE 32 bit)
1002	4098	Gen User	Analog Out 2 Zero	8	RW	(IEEE 32 bit)
1004	4100	Gen User	Analog Out 2 Span	8	RW	(IEEE 32 bit)
1006	4102	Gen User	Analog Out 2 Test Value (Percent of Span)	12	RW	(IEEE 32 bit)
1008	4104	Gen User	Analog Out 2 Base Value	18	RW	(IEEE 32 bit)
100A	4106	Gen User	Analog Out 2 Full Value	18	RW	(IEEE 32 bit)
Analog Out 2 Integer Read Write						
1180	4480	Gen User	Analog Out 2 Operating Mode	18	RW	INT32
1182	4482	Gen User	Analog Out 2 Type	18	RW	INT32
1184	4484	Gen User	Analog Out 2 Measurement Register Address	18	RW	INT32
1186	4486	Gen User	Analog Out 2 Error Handling	18	RW	INT32
1188	4488	Gen User	Analog Out 2 Unit Code	18	RW	INT32
Analog Out 2 Max Real Read Only						
1600	5632	VIEWER	Maximum Analog Out 2 Error Handling Value	8	RO	(IEEE 32 bit)
1602	5634	VIEWER	Maximum Analog Out 2 Zero	8	RO	(IEEE 32 bit)
1604	5636	VIEWER	Maximum Analog Out 2 Span	8	RO	(IEEE 32 bit)
1606	5638	VIEWER	Maximum Analog Out 2 Test Value (Percent of Span)	12	RO	(IEEE 32 bit)
1608	5640	VIEWER	Maximum Analog Out 2 Base Value	18	RO	(IEEE 32 bit)
160A	5642	VIEWER	Maximum Analog Out 2 Full Value	18	RO	(IEEE 32 bit)
Analog Out 2 Min Real Read Only						
1A00	6656	VIEWER	Minimum Analog Out 2 Error Handling Value	8	RO	(IEEE 32 bit)
1A02	6658	VIEWER	Minimum Analog Out 2 Zero	8	RO	(IEEE 32 bit)
1A04	6660	VIEWER	Minimum Analog Out 2 Span	8	RO	(IEEE 32 bit)
1A06	6662	VIEWER	Minimum Analog Out 2 Test Value (Percent of Span)	12	RO	(IEEE 32 bit)
1A08	6664	VIEWER	Minimum Analog Out 2 Base Value	18	RO	(IEEE 32 bit)
1A0A	6666	VIEWER	Minimum Analog Out 2 Full Value	18	RO	(IEEE 32 bit)

Table 10: Transmitter Modbus Map (cont.)

Register (in Hex)	Register (in Decimal)	Access Level	Variable	Unit Group	Read Only/Read Write	Format
Digital Out 1 Real Read Write						
2000	8192	Gen User	Output_1 Pulse Value	18	RW	(IEEE 32 bit)
2002	8194	Gen User	Output_1 Pulse Time	10	RW	(IEEE 32 bit)
2004	8196	Gen User	Output_1 Frequency Base Value	18	RW	(IEEE 32 bit)
2006	8198	Gen User	Output_1 Frequency Full Value	18	RW	(IEEE 32 bit)
2008	8200	Gen User	Output_1 Alarm Value	18	RW	(IEEE 32 bit)
200A	8202	Gen User	Output_1 Control Output Value	18	RW	(IEEE 32 bit)
Digital Out 1 Integer Read Write						
2100	8448	Gen User	Output_1 Test Pulse Value	18	RW	INT32
2102	8450	Gen User	Output_1 Frequency Full Frequency	6	RW	INT32
2104	8452	Gen User	Output_1 Test Frequency Value	6	RW	INT32
2106	8454	Gen User	Output_1 Frequency Error Handling Value	6	RW	INT32
2180	8576	Gen User	Output_1 type	18	RW	INT32
2182	8578	Gen User	Output_1 Pulse Value Unit Code	18	RW	INT32
2184	8580	Gen User	Output_1 Pulse Error Handling	18	RW	INT32
2186	8582	Gen User	Output_1 Frequency Measurement Register Address	18	RW	INT32
2188	8584	Gen User	Output_1 Frequency Error Handling	18	RW	INT32
218A	8586	Gen User	Output_1 Frequency Unit code	18	RW	INT32
218C	8588	Gen User	Output_1 Alarm State	18	RW	INT32
218E	8590	Gen User	Output_1 Alarm Type	18	RW	INT32
2190	8592	Gen User	Output_1 Alarm Measurement Register Address	18	RW	INT32
2192	8594	Gen User	Output_1 Alarm Unit code	18	RW	INT32
2194	8596	Gen User	Output_1 Test Alarm	18	RW	INT32
2196	8598	Gen User	Output_1 Control Output State	18	RW	INT32
2198	8600	Gen User	Output_1 Control Output Type	18	RW	INT32
219A	8602	Gen User	Output_1 Control Output Measurement Register Address	18	RW	INT32
219C	8604	Gen User	Output_1 Control Output Unit code	18	RW	INT32
219E	8606	Gen User	Output_1 Test Control Output	18	RW	INT32
21A0	8608	Gen User	Output_1 Reserved	18	RW	INT32
21A2	8610	Gen User	Output_1 Test Mode 0: Test Off; 1: Test On	18	RW	INT32
21A4	8612	Gen User	Output_1 Pulse Measurement Register Address	18	RW	INT32
Digital Out 2 Real Read Write						
2400	9216	Gen User	Output_2 Pulse Value	18	RW	(IEEE 32 bit)
2402	9218	Gen User	Output_2 Pulse Time	10	RW	(IEEE 32 bit)
2404	9220	Gen User	Output_2 Frequency Base Value	18	RW	(IEEE 32 bit)
2406	9222	Gen User	Output_2 Frequency Full Value	18	RW	(IEEE 32 bit)
2408	9224	Gen User	Output_2 Alarm Value	18	RW	(IEEE 32 bit)
240A	9226	Gen User	Output_2 Control Output Value	18	RW	(IEEE 32 bit)

Table 10: Transmitter Modbus Map (cont.)

Register (in Hex)	Register (in Decimal)	Access Level	Variable	Unit Group	Read Only/ Read Write	Format
Digital Out 2 Integer Read Write						
2500	9472	Gen User	Output_2 Test Pulse Value	18	RW	INT32
2502	9474	Gen User	Output_2 Frequency Full Frequency	6	RW	INT32
2504	9476	Gen User	Output_2 Test Frequency Value	6	RW	INT32
2506	9478	Gen User	Output_2 Frequency Error Handling Value	6	RW	INT32
2580	9600	Gen User	Output_2 type	18	RW	INT32
2582	9602	Gen User	Output_2 Pulse Value Unit Code	18	RW	INT32
2584	9604	Gen User	Output_2 Pulse Error Handling	18	RW	INT32
2586	9606	Gen User	Output_2 Frequency Measurement Register Address	18	RW	INT32
2588	9608	Gen User	Output_2 Frequency Error Handling	18	RW	INT32
258A	9610	Gen User	Output_2 Frequency Unit code	18	RW	INT32
258C	9612	Gen User	Output_2 Alarm State	18	RW	INT32
258E	9614	Gen User	Output_2 Alarm Type	18	RW	INT32
2590	9616	Gen User	Output_2 Alarm Measurement Register Address	18	RW	INT32
2592	9618	Gen User	Output_2 Alarm Unit code	18	RW	INT32
2594	9620	Gen User	Output_2 Test Alarm	18	RW	INT32
2596	9622	Gen User	Output_2 Control Output State	18	RW	INT32
2598	9624	Gen User	Output_2 Control Output Type	18	RW	INT32
259A	9626	Gen User	Output_2 Control Output Measurement Register Address	18	RW	INT32
259C	9628	Gen User	Output_2 Control Output Unit code	18	RW	INT32
259E	9630	Gen User	Output_2 Test Control Output	18	RW	INT32
25A0	9632	Gen User	Output_2 Phase Shift	18	RW	INT32
25A2	9634	Gen User	Output_2 Test Mode 0: Test Off; 1: Test O	18	RW	INT32
25A4	9636	Gen User	Output_2 Pulse Measurement Register Address	18	RW	INT32
Digital Out Max Real Read Only						
2A00	10752	VIEWER	Maximum Output_1 Pulse Value	18	RO	(IEEE 32 bit)
2A02	10754	VIEWER	Maximum Output_1 Pulse Time	10	RO	(IEEE 32 bit)
2A04	10756	VIEWER	Maximum Output_1 Frequency Base Value	18	RO	(IEEE 32 bit)
2A06	10758	VIEWER	Maximum Output_1 Frequency Full Value	18	RO	(IEEE 32 bit)
2A08	10670	VIEWER	Maximum Output_1 Alarm Value	18	RO	(IEEE 32 bit)
2A0A	10762	VIEWER	Maximum Output_1 Control Output Value	18	RO	(IEEE 32 bit)
2A80	10880	VIEWER	Maximum Output_2 Pulse Value	18	RO	(IEEE 32 bit)
2A82	10882	VIEWER	Maximum Output_2 Pulse Time	10	RO	(IEEE 32 bit)
2A84	10884	VIEWER	Maximum Output_2 Frequency Base Value	18	RO	(IEEE 32 bit)
2A86	10886	VIEWER	Maximum Output_2 Frequency Full Value	18	RO	(IEEE 32 bit)
2A88	10888	VIEWER	Maximum Output_2 Alarm Value	18	RO	(IEEE 32 bit)
2A8A	10890	VIEWER	Maximum Output_2 Control Output Value	18	RO	(IEEE 32 bit)

Table 10: Transmitter Modbus Map (cont.)

Register (in Hex)	Register (in Decimal)	Access Level	Variable	Unit Group	Read Only/Read Write	Format
Digital Out Max Integer Read Only						
2B00	11008	VIEWER	Maximum Output_1 Test Pulse Value	18	RO	INT32
2B02	11010	VIEWER	Maximum Output_1 Frequency Full Frequency	6	RO	INT32
2B04	11012	VIEWER	Maximum Output_1 Test Frequency Value	6	RO	INT32
2B06	11014	VIEWER	Maximum Output_1 Frequency Error Handling Value	6	RO	INT32
2B80	11136	VIEWER	Maximum Output_2 Test Pulse Value	18	RO	INT32
2B82	11138	VIEWER	Maximum Output_2 Frequency Full Frequency	6	RO	INT32
2B84	11140	VIEWER	Maximum Output_2 Test Frequency Value	6	RO	INT32
2B86	11142	VIEWER	Maximum Output_2 Frequency Error Handling Value	6	RO	INT32
Digital Out Min Real Read Only						
2E00	2	VIEWER	Minimum Output_1 Pulse Value	18	RO	(IEEE 32 bit)
2E02	512	VIEWER	Minimum Output_1 Pulse Time	10	RO	(IEEE 32 bit)
2E04	131072	VIEWER	Minimum Output_1 Frequency Base Value	18	RO	(IEEE 32 bit)
2E06	33554432	VIEWER	Minimum Output_1 Frequency Full Value	18	RO	(IEEE 32 bit)
2E08	8589934592	VIEWER	Minimum Output_1 Alarm Value	18	RO	(IEEE 32 bit)
2E0A	11786	VIEWER	Minimum Output_1 Control Output Value	18	RO	(IEEE 32 bit)
2E80		VIEWER	Minimum Output_2 Pulse Value	18	RO	(IEEE 32 bit)
2E82		VIEWER	Minimum Output_2 Pulse Time	10	RO	(IEEE 32 bit)
2E84		VIEWER	Minimum Output_2 Frequency Base Value	18	RO	(IEEE 32 bit)
2E86		VIEWER	Minimum Output_2 Frequency Full Value	18	RO	(IEEE 32 bit)
2E88		VIEWER	Minimum Output_2 Alarm Value	18	RO	(IEEE 32 bit)
2E8A	11914	VIEWER	Minimum Output_2 Control Output Value	18	RO	(IEEE 32 bit)
Digital Out Min Integer Read Only						
2F00	12032	VIEWER	Minimum Output_1 Test Pulse Value	18	RO	INT32
2F02	12034	VIEWER	Minimum Output_1 Frequency Full Frequency	6	RO	INT32
2F04	12036	VIEWER	Minimum Output_1 Test Frequency Value	6	RO	INT32
2F06	12038	VIEWER	Minimum Output_1 Frequency Error Handling Value	6	RO	INT32
2F80	12160	VIEWER	Minimum Output_2 Test Pulse Value	18	RO	INT32
2F82	12162	VIEWER	Minimum Output_2 Frequency Full Frequency	6	RO	INT32
2F84	12164	VIEWER	Minimum Output_2 Test Frequency Value	6	RO	INT32
2F86	12166	VIEWER	Minimum Output_2 Frequency Error Handling Value	6	RO	INT32
HART Integer Read Write						
3100	12544	VIEWER	Hart unit code	18	RW	INT32
Files						
3000	12288	VIEWER	Flow Monitoring log	18	RO	
3001	12289	VIEWER	Error log	18	RO	

Table 10: Transmitter Modbus Map (cont.)

Register (in Hex)	Register (in Decimal)	Access Level	Variable	Unit Group	Read Only/ Read Write	Format
Flow Measurement Registers						
Configurations (Holding Registers)						
Composite Channel Real - FF Terminal Block 2						
8000	32768	SERVICE	Composite Span value for frequency output	1, 14 or 20	RW	(IEEE 32 bit)
8002	32770	SERVICE	Composite Pipe Inner Diameter	5	RW	(IEEE 32 bit)
8004	32772	SERVICE	Composite Pipe Outer Diameter	5	RW	(IEEE 32 bit)
8006	32774	SERVICE	Composite Pipe Wall Thickness	5	RW	(IEEE 32 bit)
8008	32776	SERVICE	Composite Velocity Warn High limit - Alarm limits-Normal operation	20	RW	(IEEE 32 bit)
800A	32778	Gen User	Composite Analog out percent scale	12	RW	(IEEE 32 bit)
800C	32780	Gen User	Composite Static Density	4	RW	(IEEE 32 bit)
800E	32782	SERVICE	Composite Acceleration Limit	18	RW	(IEEE 32 bit)
8010	32784	SERVICE	Composite Amplitude discriminator min limit	18	RW	(IEEE 32 bit)
8012	32786	SERVICE	Composite Amplitude discriminator max limit	18	RW	(IEEE 32 bit)
8014	32788	Gen User	Composite Kinematic Viscosity	7	RW	(IEEE 32 bit)
8016	32790	SERVICE	Composite Calibration Factor	18	RW	(IEEE 32 bit)
8018	32792	Gen User	Composite Zero Cutoff	20	RW	(IEEE 32 bit)
801A	32794	Gen User	Composite Response Time	13	RW	(IEEE 32 bit)
801C	32796	Gen User	Composite Analog Output Low Limit point as entered in the system	1, 9, 14	RW	(IEEE 32 bit)
801E	32798	Gen User	Composite Analog Output High Limit as entered in the system	1, 9, 14	RW	(IEEE 32 bit)
8020	32800	Gen User	Composite Zero Set point as entered into the system by user	8	RW	(IEEE 32 bit)
8022	32802	Gen User	Composite Span Set point as entered into the system by user	8	RW	(IEEE 32 bit)
8024	32804	Gen User	Composite Velocity Low limit - Used for Volumetric low limit calculation	20	RW	(IEEE 32 bit)
8026	32806	Gen User	Composite Velocity High limit - Used for Volumetric High limit calculation	20	RW	(IEEE 32 bit)
8028	32808	Gen User	Composite Velocity Warn Low limit - Alarm limits-Normal operation	20	RW	(IEEE 32 bit)
802A	32810	Gen User	Composite Velocity Warn High limit - Alarm limits-Normal operation	20	RW	(IEEE 32 bit)
802C	32812	Gen User	Composite Reference Density for Standard volumetric calculation	4	RW	(IEEE 32 bit)
802E	32814	Gen User	Composite Base value for frequency output	1, 14, 20	RW	(IEEE 32 bit)
8030	32816	Gen User	Composite Analog Input Zero Set point as entered into the system by user	8	RW	(IEEE 32 bit)
8032	32818	Gen User	Composite Analog Input Span Set point as entered into the system by user	8	RW	(IEEE 32 bit)
9000	36864	SERVICE	Composite MultiK VelRey_1	18, 20	RW	(IEEE 32 bit)
9002	36866	SERVICE	Composite MultiK VelRey_2	18, 20	RW	(IEEE 32 bit)
9004	36868	SERVICE	Composite MultiK VelRey_3	18, 20	RW	(IEEE 32 bit)

Table 10: Transmitter Modbus Map (cont.)

Register (in Hex)	Register (in Decimal)	Access Level	Variable	Unit Group	Read Only/ Read Write	Format
9006	36870	SERVICE	Composite MultiK VelRey_4	18, 20	RW	(IEEE 32 bit)
9008	36872	SERVICE	Composite MultiK VelRey_5	18, 20	RW	(IEEE 32 bit)
900A	36874	SERVICE	Composite MultiK VelRey_6	18, 20	RW	(IEEE 32 bit)
9400	37888	SERVICE	Composite MultiK KFactor_1	18	RW	(IEEE 32 bit)
9402	37890	SERVICE	Composite MultiK KFactor_2	18	RW	(IEEE 32 bit)
9404	37892	SERVICE	Composite MultiK KFactor_3	18	RW	(IEEE 32 bit)
9406	37894	SERVICE	Composite MultiK KFactor_4	18	RW	(IEEE 32 bit)
9408	37896	SERVICE	Composite MultiK KFactor_5	18	RW	(IEEE 32 bit)
940A	37898	SERVICE	Composite MultiK KFactor_6	18	RW	(IEEE 32 bit)
Composite Channel Integer - FF Terminal Block 2						
8100	33024	SERVICE	Composite Reynolds Correction: 0: Off, 1: On	18	RW	INT32
8102	33026	VIEWER	Composite Command to capture a new set of signal files: 0: Write - ERROR, Read - Not Ready, 1: Write - Capture, Read - Ready	18	RW	INT32
8104	33028	SERVICE	Composite Path Configuration: 0: single path diameter, 1: single path mid radius, 2: two path diameter, 3: two path mid radius, 4: three path	18	RW	INT32
8106	33030	FACTORY	Composite Hardware revision	18	RW	INT32
8108	33032	FACTORY	Composite Software revision	18	RW	INT32
810A	33034	FACTORY	Composite UMPU board serial number	18	RW	INT32
810C	33036	VIEWER	Composite Totalizer Command: 0: Batch Reset 1: Batch Start, 2: Batch Stop, 3: Inventory Reset	18	RW	INT32
810E	33038	SERVICE	Composite Command: 0: Off, 1: Commissioned, 2: Factory	18	RW	INT32
8110	33040	Gen User	Composite Which test to run: 0: None, 1: Watchdog Test, 2: Open Output switch, 3: Close Output switch	18	RW	INT32
8112	33042	Gen User	Composite Service	18	RW	INT32
8114	33044	Gen User	Composite Factory	18	RW	INT32
8116	33046	Gen User	Composite User	18	RW	INT32
8118	33048	Gen User	Composite AnalogOut Command (for trim): 0: Trim Off, 1: Low Set, 2: High Set, 3: Zero trim 4: Span trim 5: Percent Set	18	RW	INT32
811A	33050	FACTORY	Composite Sensor serial number 1	18	RW	INT32
811C	33052	FACTORY	Composite Sensor serial number 2	18	RW	INT32
811E	33054	SERVICE	Composite Tracking Windows: 0: Off, 1: On	18	RW	INT32
8120	33056	SERVICE	Composite MultiK Active: 0: Off, 1: On	18	RW	INT32
8122	33058	SERVICE	Composite MultiK Type: 0: Velocity, 1: Reynolds	18	RW	INT32
8124	33060	SERVICE	Composite MultiK Pairs	18	RW	INT32
8126	33062	SERVICE	Composite KV Input Selection	18	RW	INT32
8128	33064	Gen User	Composite System Command (such as commit, accept, halt): 0: Init, 1: Halt, 2: Cancel, 3: Submit, 4: Commit, 5: Commit as Factory, 6: Commit as Commissioned, 7: Password Change request	18	RW	INT32
812A	33066	SERVICE	Composite Active TW: 0: Disabled, 1: Enabled	18	RW	INT32

Table 10: Transmitter Modbus Map (cont.)

Register (in Hex)	Register (in Decimal)	Access Level	Variable	Unit Group	Read Only/Read Write	Format
812C	33068	Gen User	Composite Selection for FireLow/ Fire High during fault: 0: Fire-Low, 1: Fire-High	18	RW	INT32
812E	33070	Gen User	Composite Analog Output Selection: 0: Mass Flow, 1: Actual Volumetric, 2: Standard Volumetric	18	RW	INT32
8130	33072	SERVICE	Composite Calibration Mode Selection: 0: Off 1: Gate Input, 2: Frequency Output	18	RW	INT32
8132	33074	SERVICE	Composite Base Frequency for frequency Output	6	RW	INT32
8134	33076	SERVICE	Composite Span Frequency for frequency Output	6	RW	INT32
8136	33078	SERVICE	Composite Frequency Output Unit Selection: 0: Velocity, 1: Volumetric, 2: Mass Flow	18	RW	INT32
8138	33080	SERVICE	Composite Frequency Output Error State Selection: 0: Force Low, 1: Force High, 2: Hold Last	18	RW	INT32
813A	33082	SERVICE	Composite Path Error Handling: 0: Off, 1: On	18	RW	INT32
813C	33084	Gen User	Composite Unit Type Dimension (see Unit Table, C.2)	18	RW	INT32
813E	33086	Gen User	Composite Unit Type Density (see Unit Table, C.2)	18	RW	INT32
8140	33088	Gen User	Composite Unit Type Mass Flow (see Unit Table, C.2)	18	RW	INT32
8142	33090	Gen User	Composite Unit Type Volumetric (see Unit Table, C.2)	18	RW	INT32
8144	33092	Gen User	Composite Unit Type Velocity (see Unit Table, C.2)	18	RW	INT32
8146	33094	SERVICE	Composite Test Frequency for Frequency Output	6	RW	INT32
8148	33096	FACTORY	Composite Sensor serial number 3	18	RW	INT32
814A	33098	FACTORY	Composite Sensor serial number 4	18	RW	INT32
814C	33100	FACTORY	Composite Sensor serial number 5	18	RW	INT32
814E	33102	FACTORY	Composite Sensor serial number 6	18	RW	INT32
8150	33104	FACTORY	Composite Flow meter/System serial number	18	RW	INT32
8152	33106	Gen User	Composite Unit Type Time (see Unit Table, C.2)	18	RW	INT32
8154	33108	Gen User	Composite Unit Type Viscosity (see Unit Table, C.2)	18	RW	INT32
8156	33110	Gen User	Composite Unit Type Standard Volumetric (see Unit Table, C.2)	18	RW	INT32
8158	33112	FACTORY	Composite Standard BWT buffer 1 serial number	18	RW	INT32
815A	33114	FACTORY	Composite Standard BWT buffer 2 serial number	18	RW	INT32
815C	33116	FACTORY	Composite Standard BWT buffer 3 serial number	18	RW	INT32
815E	33118	FACTORY	Composite Standard BWT buffer 4 serial number	18	RW	INT32
8160	33120	FACTORY	Composite Standard BWT buffer 5 serial number	18	RW	INT32
8162	33122	FACTORY	Composite Standard BWT buffer 6 serial number	18	RW	INT32
8164	33124	FACTORY	Composite UMPU receiver serial number	18	RW	INT32
Channel 1 Real - FF Terminal Block 4						
8400	33792	SERVICE	Ch_1 Chord Wt Factor	18	RW	(IEEE 32 bit)
8402	33794	SERVICE	Ch_1 Time Buffer Offset	19	RW	(IEEE 32 bit)
8404	33796	SERVICE	Ch_1 Time in wedge	19	RW	(IEEE 32 bit)
8406	33798	SERVICE	Ch_1 Path Length P	5	RW	(IEEE 32 bit)

Table 10: Transmitter Modbus Map (cont.)

Register (in Hex)	Register (in Decimal)	Access Level	Variable	Unit Group	Read Only/ Read Write	Format
8408	33800	SERVICE	Ch_1 Axial Length L	5	RW	(IEEE 32 bit)
840A	33802	SERVICE	Ch_1 Delay Between Successive Transmits	19	RW	(IEEE 32 bit)
840C	33804	SERVICE	Ch_1 DeltaT Offset	19	RW	(IEEE 32 bit)
Channel 1 Integer - FF Terminal Block 4						
8500	34048	SERVICE	Ch_1 Pct of Peak	12	RW	INT32
8502	34050	SERVICE	Ch_1 Min Peak%	12	RW	INT32
8504	34052	SERVICE	Ch_1 Max Peak%	12	RW	INT32
8506	34054	SERVICE	Ch_1 Reynolds Correction Selection: 0: Off, 1: On	18	RW	INT32
8508	34056	SERVICE	Ch_1 enum of transducer type (ex. T5): 0: BWT, 1:LX	18	RW	INT32
850A	34058	SERVICE	Ch_1 Transducer Freq: 500000: 500kHz, 1000000: 1MHz, 2000000: 2MHz	6	RW	INT32
850C	34060	SERVICE	Ch 1 Errors Allowed	18	RW	INT32
Channel 2 Real - FF Terminal Block 5						
8800	34816	SERVICE	Ch_2 Composite Coefficient	18	RW	(IEEE 32 bit)
8802	34818	SERVICE	Ch_2 Time Buffer Offset	19	RW	(IEEE 32 bit)
8804	34820	SERVICE	Ch_2 Time in wedge	19	RW	(IEEE 32 bit)
8806	34822	SERVICE	Ch_2 Path Length P	5	RW	(IEEE 32 bit)
8808	34824	SERVICE	Ch_2 Axial Length L	5	RW	(IEEE 32 bit)
880A	34826	SERVICE	Ch_2 Delay Between Successive Transmits	19	RW	(IEEE 32 bit)
880C	34828	SERVICE	Ch_2 DeltaT Offset	19	RW	(IEEE 32 bit)
Channel 2 Integer - FF Terminal Block 5						
8900	35072	SERVICE	Ch_2 Pct of Peak	12	RW	INT32
8902	35074	SERVICE	Ch_2 Min Peak%	12	RW	INT32
8904	35076	SERVICE	Ch_2 Max Peak%	12	RW	INT32
8906	35078	SERVICE	Ch_2 Reynolds correction selection: 0: Off, 1: On, 1: LX	18	RW	INT32
8908	35080	SERVICE	Ch_2 enum of transducer type (ex. T5): 0: BWT, 2000000: 2MHz	18	RW	INT32
890A	35082	SERVICE	Ch_2 Transducer Freq: 500000: 500kHz, 1000000: 1MHz	6	RW	INT32
890C	35084	SERVICE	Ch_2 Errors Allowed	18	RW	INT32
Measurements (Input Registers)						
Composite Channel Real						
8200	33280	VIEWER	Composite Velocity	20	RO	(IEEE 32 bit)
8202	33282	VIEWER	Composite Volumetric	1	RO	(IEEE 32 bit)
8204	33284	VIEWER	Composite Mass Flow	9	RO	(IEEE 32 bit)
8206	33286	VIEWER	Composite Fwd Batch Totals	17	RO	(IEEE 32 bit)
8208	33288	VIEWER	Composite Rev Batch Totals	17	RO	(IEEE 32 bit)
820A	33290	VIEWER	Composite Totalizer Time	16	RO	(IEEE 32 bit)
820C	33292	VIEWER	Composite Sound Speed	20	RO	(IEEE 32 bit)

Table 10: Transmitter Modbus Map (cont.)

Register (in Hex)	Register (in Decimal)	Access Level	Variable	Unit Group	Read Only/Read Write	Format
8214	33300	VIEWER	Composite Current Correction Factor	18	RO	(IEEE 32 bit)
8216	33302	VIEWER	Composite Current Reynolds Number	18	RO	(IEEE 32 bit)
8218	33304	VIEWER	Composite Current operating temperature read from temperature sensor	15	RO	(IEEE 32 bit)
821A	33306	VIEWER	Composite Standard Volumetric	14	RO	(IEEE 32 bit)
821C	33308	VIEWER	Composite Net Batch Totals	17	RO	(IEEE 32 bit)
8220	33312	VIEWER	Composite Analog Out Drive Current	8	RO	(IEEE 32 bit)
8222	33314	VIEWER	Composite Analog Out Monitored Current	8	RO	(IEEE 32 bit)
Composite Channel Int						
8300	33536	VIEWER	Composite status bit map	18	RO	INT32
8302	33538	VIEWER	Composite errors: ep_Value_Health_Code_I: Use dropdown	18	RO	INT32
8304	33540	VIEWER	Composite most significant error (see Error Tables)	18	RO	INT32
8306	33542	VIEWER	Composite Gate Input State bitmap: 0: Open, 1: Closed	18	RO	INT32
Channel 1 Real - FF Terminal Block 4						
8600	34304	VIEWER	Ch_1 Velocity	20	RO	(IEEE 32 bit)
8602	34306	VIEWER	Ch_1 Sound Speed	20	RO	(IEEE 32 bit)
8604	34308	VIEWER	Ch_1 Transit Time Up	19	RO	(IEEE 32 bit)
8606	34310	VIEWER	Ch_1 Transit Time Dn	19	RO	(IEEE 32 bit)
8608	34312	VIEWER	Ch_1 DeltaT	19	RO	(IEEE 32 bit)
860A	34314	VIEWER	Ch_1 Time in buffer on Dn channel	19	RO	(IEEE 32 bit)
860C	34316	VIEWER	Ch_1 Up Signal Quality	18	RO	(IEEE 32 bit)
860E	34318	VIEWER	Ch_1 Dn Signal Quality	18	RO	(IEEE 32 bit)
8610	34320	VIEWER	Ch_1 Up Amp Disc	18	RO	(IEEE 32 bit)
8612	34322	VIEWER	Ch_1 Dn Amp Disc	18	RO	(IEEE 32 bit)
8614	34324	VIEWER	Ch_1 Signal Gain Up	3	RO	(IEEE 32 bit)
8616	34326	VIEWER	Ch_1 Signal Gain Down	3	RO	(IEEE 32 bit)
8618	34328	VIEWER	Ch_1_SNR on UP channel	18	RO	(IEEE 32 bit)
861A	34330	VIEWER	Ch_1_SNR on DOWN channel	18	RO	(IEEE 32 bit)
861C	34332	VIEWER	Ch_1 Time in buffer on Up channel	19	RO	(IEEE 32 bit)
Channel 1 Integer - FF Terminal Block 4						
8700	34560	VIEWER	Ch_1 Status Bit Map	18	RO	INT32
8702	34562	VIEWER	Ch_1 Most Significant Error (See Error Tables)	18	RO	INT32
8704	34564	VIEWER	Ch_1 Up +- Peak	18	RO	INT32
8706	34566	VIEWER	Ch_1 Dn +- Peak	18	RO	INT32
8708	34568	VIEWER	Ch_1 Dynamic Threshold On Up Channel	12	RO	INT32
870A	34570	VIEWER	Ch_1 Dynamic Threshold On Down Channel	12	RO	INT32
870C	34572	VIEWER	Ch_1 #Errors of Last 16	18	RO	INT32
Channel 2 Real - FF Terminal Block 5						
8A00	35328	VIEWER	Ch_2 Velocity	20	RO	(IEEE 32 bit)

Table 10: Transmitter Modbus Map (cont.)

Register (in Hex)	Register (in Decimal)	Access Level	Variable	Unit Group	Read Only/ Read Write	Format
8A02	35330	VIEWER	Ch_2 Sound Speed	20	RO	(IEEE 32 bit)
8A04	35332	VIEWER	Ch_2 Transit Time Up	19	RO	(IEEE 32 bit)
8A06	35334	VIEWER	Ch_2 Transit Time Dn	19	RO	(IEEE 32 bit)
8A08	35336	VIEWER	Ch_2 DeltaT	19	RO	(IEEE 32 bit)
8A0A	35338	VIEWER	Ch_2 Time in buffer on Dn channel	19	RO	(IEEE 32 bit)
8A0C	35340	VIEWER	Ch_2 Up Signal Quality	18	RO	(IEEE 32 bit)
8A0E	35342	VIEWER	Ch_2 Dn Signal Quality	18	RO	(IEEE 32 bit)
8A10	35344	VIEWER	Ch_2 Up Amp Disc	18	RO	(IEEE 32 bit)
8A12	35346	VIEWER	Ch_2 Dn Amp Disc	18	RO	(IEEE 32 bit)
8A14	35348	VIEWER	Ch_2 Signal Gain Up	3	RO	(IEEE 32 bit)
8A16	35350	VIEWER	Ch_2 Signal Gain Down	3	RO	(IEEE 32 bit)
8A18	35352	VIEWER	Ch_2_SNR on UP channel	18	RO	(IEEE 32 bit)
8A1A	35354	VIEWER	Ch_2_SNR on DOWN channel	18	RO	(IEEE 32 bit)
8A1C	35356	VIEWER	Ch_2 Time in buffer on Up channel	19	RO	(IEEE 32 bit)
Channel 2 Integer - FF Terminal Block 5						
8B00	35584	VIEWER	Ch_2 Status Bit Map	18	RO	INT32
8B02	35586	VIEWER	Ch_2 most significant error (see Error Tables)	18	RO	INT32
8B04	35588	VIEWER	Ch_2 Up +- Peak	18	RO	INT32
8B06	35590	VIEWER	Ch_2 Dn +- Peak	18	RO	INT32
8B08	35592	VIEWER	Ch_2 dynamic threshold on UP channel	12	RO	INT32
8B0A	35594	VIEWER	Ch_2 dynamic threshold on DOWN channel	12	RO	INT32
8B0C	35596	VIEWER	Ch_2 # Errors of Last 16	18	RO	INT32
Composite Channel Real Max						
A200	41472	VIEWER	Maximum Composite Velocity	20	RO	(IEEE 32 bit)
A202	41474	VIEWER	Maximum Composite Volumetric	1	RO	(IEEE 32 bit)
A204	41476	VIEWER	Maximum Composite Mass Flow	9	RO	(IEEE 32 bit)
A206	41478	VIEWER	Maximum Composite Fwd Batch Totals	17	RO	(IEEE 32 bit)
A208	41480	VIEWER	Maximum Composite Rev Batch Totals	17	RO	(IEEE 32 bit)
A20A	41482	VIEWER	Maximum Composite Totalizer Time	2	RO	(IEEE 32 bit)
A20C	41484	VIEWER	Maximum Composite Sound Speed	20	RO	(IEEE 32 bit)
A20E	41486	VIEWER	Maximum Composite Inventory Fwd Totals	17	RO	(IEEE 32 bit)
A210	41488	VIEWER	Maximum Composite Inventory Rev Totals	17	RO	(IEEE 32 bit)
A212	41490	VIEWER	Maximum Composite Inventory Totalizer Time	2	RO	(IEEE 32 bit)
A214	41492	VIEWER	Maximum Composite Current Correction Factor	18	RO	(IEEE 32 bit)
A216	41494	VIEWER	Maximum Composite Current Reynolds Number	18	RO	(IEEE 32 bit)
A218	41496	VIEWER	Maximum Composite acceptable operating temperature reading from temperature sensor	15	RO	(IEEE 32 bit)
A21A	41498	VIEWER	Maximum Composite Standard Volumetric	14	RO	(IEEE 32 bit)
A21C	41500	VIEWER	Maximum Composite Net Batch Totals	17	RO	(IEEE 32 bit)
A21E	41502	VIEWER	Maximum Composite Net Inventory Totals	17	RO	(IEEE 32 bit)

Table 10: Transmitter Modbus Map (cont.)

Register (in Hex)	Register (in Decimal)	Access Level	Variable	Unit Group	Read Only/Read Write	Format
A220	41504	VIEWER	Maximum Composite Analog Out Drive Current	8	RO	(IEEE 32 bit)
A222	41506	VIEWER	Maximum Composite Analog Out Monitored Current	8	RO	(IEEE 32 bit)
Composite Channel Integer Max						
A300	41728	VIEWER	Maximum Composite Status Bit Map	18	RO	INT32
A302	41730	VIEWER	Maximum Composite Errors	18	RO	INT32
A304	41732	VIEWER	Maximum Composite Most Significant Error	18	RO	INT32
A306	41734	VIEWER	Maximum Composite Gate Input State bitmap: 0: Open, 1: Closed	18	RO	INT32
Composite Channel Real Min						
A600	42496	VIEWER	Minimum Composite Velocity	20	RO	(IEEE 32 bit)
A602	42498	VIEWER	Minimum Composite Volumetric	1	RO	(IEEE 32 bit)
A604	42500	VIEWER	Minimum Composite Mass Flow	9	RO	(IEEE 32 bit)
A606	42502	VIEWER	Minimum Composite Fwd Batch Totals	17	RO	(IEEE 32 bit)
A608	42504	VIEWER	Minimum Composite Rev Batch Totals	17	RO	(IEEE 32 bit)
A60A	42506	VIEWER	Minimum Composite Totalizer Time	16	RO	(IEEE 32 bit)
A60C	42508	VIEWER	Minimum Composite Sound Speed	20	RO	(IEEE 32 bit)
A60E	42510	VIEWER	Minimum Composite Inventory Fwd Totals	17	RO	(IEEE 32 bit)
A610	42512	VIEWER	Minimum Composite Inventory Rev Totals	17	RO	(IEEE 32 bit)
A612	42514	VIEWER	Minimum Composite Inventory Totalizer Time	2	RO	(IEEE 32 bit)
A614	42516	VIEWER	Minimum Composite Current Correction Factor	18	RO	(IEEE 32 bit)
A616	42518	VIEWER	Minimum Composite Current Reynolds Number	18	RO	(IEEE 32 bit)
A618	42520	VIEWER	Minimum Composite Acceptable Operating Temperature Reading From Temperature Sensor	15	RO	(IEEE 32 bit)
A61A	42522	VIEWER	Minimum Composite Standard Volumetric	14	RO	(IEEE 32 bit)
A61C	42524	VIEWER	Minimum Composite Net Batch Totals	17	RO	(IEEE 32 bit)
A61E	42526	VIEWER	Minimum Composite Net Inventory Totals	17	RO	(IEEE 32 bit)
A620	42528	VIEWER	Minimum Composite Analog Out Drive Current	8	RO	(IEEE 32 bit)
A622	42530	VIEWER	Minimum Composite Analog Out Monitored Current	8	RO	(IEEE 32 bit)
Composite Channel Integer Min						
A700	42752	VIEWER	Minimum Composite Status Bit Map	18	RO	INT32
A702	42754	VIEWER	Minimum Composite Errors	18	RO	INT32
A704	42756	VIEWER	Minimum Composite Most Significant Error	18	RO	INT32
A706	42758	VIEWER	Minimum Composite Gate Input State bitmap: 0: Open, 1: Closed	18	RO	INT32
Composite Channel Real Max						
A000	40960	VIEWER	Maximum Composite Frequency Output Span Value	1, 14, 20	RO	(IEEE 32 bit)
A002	40962	VIEWER	Maximum Composite Pipe Inner Diameter	5	RO	(IEEE 32 bit)
A004	40964	VIEWER	Maximum Composite Pipe Outer Diameter	5	RO	(IEEE 32 bit)
A006	40966	VIEWER	Maximum Composite Pipe Wall Thickness	5	RO	(IEEE 32 bit)
A008	40968	VIEWER	Maximum Composite Velocity Warn High limit - Alarm limits- Normal operation	20	RO	(IEEE 32 bit)

Table 10: Transmitter Modbus Map (cont.)

Register (in Hex)	Register (in Decimal)	Access Level	Variable	Unit Group	Read Only/ Read Write	Format
A00A	40970	VIEWER	Maximum Composite Analog out percent scale	12	RO	(IEEE 32 bit)
A00C	40972	VIEWER	Maximum Composite Static Density	4	RO	(IEEE 32 bit)
A00E	40974	VIEWER	Maximum Composite Acceleration Limit	18	RO	(IEEE 32 bit)
A010	40976	VIEWER	Maximum Composite Amplitude discriminator min limit	18	RO	(IEEE 32 bit)
A012	40978	VIEWER	Maximum Composite Amplitude discriminator max limit	18	RO	(IEEE 32 bit)
A014	40980	VIEWER	Maximum Composite Kinematic Viscosity	7	RO	(IEEE 32 bit)
A016	40982	VIEWER	Maximum Composite Calibration Factor	18	RO	(IEEE 32 bit)
A018	40984	VIEWER	Maximum Composite Zero Cutoff	20	RO	(IEEE 32 bit)
A01A	40986	VIEWER	Maximum Composite Response Time	13	RO	(IEEE 32 bit)
A01C	40988	VIEWER	Maximum Composite Analog Output Low Limit point as entered in the system	1, 9, 14	RO	(IEEE 32 bit)
A01E	40990	VIEWER	Maximum Composite Analog Output High Limit as entered in the system	1, 9, 14	RO	(IEEE 32 bit)
A020	40992	VIEWER	Maximum Composite Zero Set point as entered into the system by user	8	RO	(IEEE 32 bit)
A022	40994	VIEWER	Maximum Composite Span Set point as entered into the system by user	8	RO	(IEEE 32 bit)
A024	40996	VIEWER	Maximum Composite Velocity Low limit	20	RO	(IEEE 32 bit)
A026	40998	VIEWER	Maximum Composite Velocity High limit	20	RO	(IEEE 32 bit)
A028	41000	VIEWER	Maximum Composite Velocity Warning Low limit	20	RO	(IEEE 32 bit)
A02A	41002	VIEWER	Maximum Composite Velocity Warning High limit	20	RO	(IEEE 32 bit)
A02C	41004	VIEWER	Maximum Composite Reference Density	4	RO	(IEEE 32 bit)
A02E	41006	VIEWER	Maximum Composite Frequency Output Base Value	1, 14, 20	RO	(IEEE 32 bit)
A030	41008	VIEWER	Maximum Composite Analog Input Zero Set point as entered into the system by user	8	RO	(IEEE 32 bit)
A032	41010	VIEWER	Maximum Composite Analog Input Span Set point as entered into the system by user	8	RO	(IEEE 32 bit)
A034	41012	VIEWER	Maximum Composite VelRey Individual Value	18, 20	RO	(IEEE 32 bit)
A036	41014	VIEWER	Maximum Composite KFact Individual Value	18	RO	(IEEE 32 bit)
Composite Channel Integer Max						
A100	41216	VIEWER	Maximum Composite Reynolds Correction	18	RO	INT32
A102	41218	VIEWER	Maximum Command to capture a new set of signal files	18	RO	INT32
A104	41220	VIEWER	Maximum Composite Path Configuration	18	RO	INT32
A106	41222	VIEWER	Maximum Composite Hardware Revision	18	RO	INT32
A108	41224	VIEWER	Maximum Composite Software revision	18	RO	INT32
A10A	41226	VIEWER	Maximum Composite UMPU board serial number	18	RO	INT32
A10C	41228	VIEWER	Maximum Composite max range of command	18	RO	INT32
A10E	41230	VIEWER	Maximum Composite Command	18	RO	INT32
A110	41232	VIEWER	Maximum Composite Which test to run	18	RO	INT32
A112	41234	VIEWER	Maximum Composite Service	18	RO	INT32

Table 10: Transmitter Modbus Map (cont.)

Register (in Hex)	Register (in Decimal)	Access Level	Variable	Unit Group	Read Only/ Read Write	Format
A114	41236	VIEWER	Maximum Composite Factory	18	RO	INT32
A116	41238	VIEWER	Maximum Composite User	18	RO	INT32
A118	41240	VIEWER	Maximum Composite AnalogOut Command (for trim)	18	RO	INT32
A11A	41242	VIEWER	Maximum Composite Sensor serial number 1	18	RO	INT32
A11C	41244	VIEWER	Maximum Composite Sensor serial number 2	18	RO	INT32
A11E	41246	VIEWER	Maximum Composite Tracking Windows	18	RO	INT32
A120	41248	VIEWER	Maximum Composite MultiK Active	18	RO	INT32
A122	41250	VIEWER	Maximum Composite MultiK Type	18	RO	INT32
A124	41252	VIEWER	Maximum Composite MultiK Pairs	18	RO	INT32
A126	41254	VIEWER	Maximum Composite KV Input Selection	18	RO	INT32
A128	41256	VIEWER	Maximum Composite System Command (such as commit, accept, halt)	18	RO	INT32
A12A	41258	VIEWER	Maximum Composite Enable Active TW	18	RO	INT32
A12C	41260	VIEWER	Maximum Composite FireLow/ Fire High during fault	18	RO	INT32
A12E	41262	VIEWER	Maximum Composite Analog output selection	18	RO	INT32
A130	41264	VIEWER	Maximum Composite Calibration Mode Selection	18	RO	INT32
A132	41266	VIEWER	Maximum Composite Base Frequency for frequency Output	6	RO	INT32
A134	41268	VIEWER	Maximum Composite Span Frequency for frequency Output	6	RO	INT32
A136	41270	VIEWER	Maximum Composite Frequency Output Unit Selection	18	RO	INT32
A138	41272	VIEWER	Maximum Composite Frequency Output Error State Selection	18	RO	INT32
A13A	41274	VIEWER	Maximum Composite Path Error Handling	18	RO	INT32
A13C	41276	VIEWER	Maximum Composite Unit Type Dimension	18	RO	INT32
A13E	41278	VIEWER	Maximum Composite Unit Type Density	18	RO	INT32
A140	41280	VIEWER	Maximum Composite Unit Type Mass Flow	18	RO	INT32
A142	41282	VIEWER	Maximum Composite Unit Type Volumetric	18	RO	INT32
A144	41284	VIEWER	Maximum Composite Unit Type Velocity	18	RO	INT32
A146	41286	VIEWER	Maximum Composite test frequency for frequency output	6	RO	INT32
A148	41288	VIEWER	Maximum Composite Sensor serial number 3	18	RO	INT32
A14A	41290	VIEWER	Maximum Composite Sensor serial number 4	18	RO	INT32
A14C	41292	VIEWER	Maximum Composite Sensor serial number 5	18	RO	INT32
A14E	41294	VIEWER	Maximum Composite Sensor serial number 6	18	RO	INT32
A150	41296	VIEWER	Maximum Composite Flow meter/System serial number	18	RO	INT32
A152	41298	VIEWER	Maximum Composite Unit Type Time	18	RO	INT32
A154	41300	VIEWER	Maximum Composite Unit Type Viscosity	18	RO	INT32
A156	41302	VIEWER	Maximum Composite Unit Type Standard Volumetric	18	RO	INT32

Table 10: Transmitter Modbus Map (cont.)

Register (in Hex)	Register (in Decimal)	Access Level	Variable	Unit Group	Read Only/Read Write	Format
A158	41304	VIEWER	Maximum Composite Standard Bwt Buffer 1 Serial Number	18	RO	INT32
A15A	41306	VIEWER	Maximum Composite Standard Bwt Buffer 2 Serial Number	18	RO	INT32
A15C	41308	VIEWER	Maximum Composite Standard Bwt Buffer 3 Serial Number	18	RO	INT32
A15E	41310	VIEWER	Maximum Composite Standard Bwt Buffer 4 Serial Number	18	RO	INT32
A160	41312	VIEWER	Maximum Composite Standard Bwt Buffer 5 Serial Number	18	RO	INT32
A162	41314	VIEWER	Maximum Composite Standard Bwt Buffer 6 Serial Number	18	RO	INT32
A164	41316	VIEWER	Maximum Composite Umpu Receiver Serial Number	18	RO	INT32
Composite Channel Real Min						
A400	41984	VIEWER	Minimum Composite Velocity Warn High limit - Alarm limits- Normal operation	1, 9, 20	RO	(IEEE 32 bit)
A402	41986	VIEWER	Minimum Composite Pipe Inner Diameter	5	RO	(IEEE 32 bit)
A404	41988	VIEWER	Minimum Composite Pipe Outer Diameter	5	RO	(IEEE 32 bit)
A406	41990	VIEWER	Minimum Composite Pipe Wall Thickness	5	RO	(IEEE 32 bit)
A408	41992	VIEWER	Minimum Composite Velocity Warn High limit - Alarm limits- Normal operation	20	RO	(IEEE 32 bit)
A40A	41994	VIEWER	Minimum Composite Analog out percent scale	12	RO	(IEEE 32 bit)
A40C	41996	VIEWER	Minimum Composite Static Density	4	RO	(IEEE 32 bit)
A40E	41998	VIEWER	Minimum Composite Acceleration Limit		RO	(IEEE 32 bit)
A410	42000	VIEWER	Minimum Composite Amplitude discriminator min limit	18	RO	(IEEE 32 bit)
A412	42002	VIEWER	Minimum Composite Amplitude discriminator max limit	18	RO	(IEEE 32 bit)
A414	42004	VIEWER	Minimum Composite Kinematic Viscosity	7	RO	(IEEE 32 bit)
A416	42006	VIEWER	Minimum Composite Calibration Factor	18	RO	(IEEE 32 bit)
A418	42008	VIEWER	Minimum Composite Zero Cutoff	20	RO	(IEEE 32 bit)
A41A	42010	VIEWER	Minimum Composite Response Time	13	RO	(IEEE 32 bit)
A41C	42012	VIEWER	Minimum Composite Analog Output Low Limit point as entered in the system	1, 9, 14	RO	(IEEE 32 bit)
A41E	42014	VIEWER	Minimum Composite Analog Output High Limit as entered in the system	1, 9, 14	RO	(IEEE 32 bit)
A420	42016	VIEWER	Minimum Composite Zero Set point as entered into the system by user	8	RO	(IEEE 32 bit)
A422	42018	VIEWER	Minimum Composite Span Set point as entered into the system by user	8	RO	(IEEE 32 bit)
A424	42020	VIEWER	Minimum Composite Velocity Low limit Min	20	RO	(IEEE 32 bit)
A426	42022	VIEWER	Minimum Composite Velocity High limit Min	20	RO	(IEEE 32 bit)
A428	42024	VIEWER	Minimum Composite Velocity Warning Low limit Min	20	RO	(IEEE 32 bit)

Table 10: Transmitter Modbus Map (cont.)

Register (in Hex)	Register (in Decimal)	Access Level	Variable	Unit Group	Read Only/ Read Write	Format
A42A	42026	VIEWER	Minimum Composite Velocity Warning High limit Min	20	RO	(IEEE 32 bit)
A42C	42028	VIEWER	Minimum Composite Static Density	4	RO	(IEEE 32 bit)
A42E	42030	VIEWER	Minimum Composite Velocity Warn High limit - Alarm limits- Normal operation	1, 14, 20	RO	(IEEE 32 bit)
A430	42032	VIEWER	Minimum Composite Analog Input Zero Set point as entered into the system by user	8	RO	(IEEE 32 bit)
A432	42034	VIEWER	Minimum Composite Analog Input Span Set point as entered into the system by user	8	RO	(IEEE 32 bit)
A434	42036	VIEWER	Minimum Composite VelRey individual value	18, 20	RO	(IEEE 32 bit)
A436	42038	VIEWER	Minimum Composite KFact individual value	18	RO	(IEEE 32 bit)
Composite Channel Integer Min						
A500	42240	VIEWER	Minimum Composite Reynolds Correction	18	RO	INT32
A502	42242	VIEWER	Minimum Command to capture a new set of signal files	18	RO	INT32
A504	42244	VIEWER	Minimum Composite Path Configuration	18	RO	INT32
A506	42246	VIEWER	Minimum Composite Hardware revision	18	RO	INT32
A508	42248	VIEWER	Minimum Composite Software revision	18	RO	INT32
A50A	42250	VIEWER	Minimum Composite UMPU board serial number	18	RO	INT32
A50C	42252	VIEWER	Minimum Composite Ceiling of the absolute value of correlation	18	RO	INT32
A50E	42254	VIEWER	Minimum Composite Command	18	RO	INT32
A510	42256	VIEWER	Minimum Composite Which test to run	18	RO	INT32
A512	42258	VIEWER	Minimum Composite Service Password	18	RO	INT32
A514	42260	VIEWER	Minimum Composite Factory Password	18	RO	INT32
A516	42262	VIEWER	Minimum Composite User Password	18	RO	INT32
A518	42264	VIEWER	Minimum Composite AnalogOut Command (for trim)	18	RO	INT32
A51A	42266	VIEWER	Minimum Composite Sensor serial number 1	18	RO	INT32
A51C	42268	VIEWER	Minimum Composite Sensor serial number 2	18	RO	INT32
A51E	42270	VIEWER	Minimum Composite Tracking Windows	18	RO	INT32
A520	42272	VIEWER	Minimum Composite MultiK Active	18	RO	INT32
A522	42274	VIEWER	Minimum Composite MultiK Type	18	RO	INT32
A524	42276	VIEWER	Minimum Composite MultiK Pairs	18	RO	INT32
A526	42278	VIEWER	Minimum Composite KV Input Selection	18	RO	INT32
A528	42280	VIEWER	Minimum Composite System Command (such as commit, accept, halt)	18	RO	INT32
A52A	42282	VIEWER	Minimum Composite Enable Active TW	18	RO	INT32
A52C	42284	VIEWER	Minimum Composite FireLow/ Fire High during fault	18	RO	INT32
A52E	42286	VIEWER	Minimum Composite Analog output selection	18	RO	INT32
A530	42288	VIEWER	Minimum Composite Calibration mode selection: 0:	18	RO	INT32
A532	42290	VIEWER	Minimum Composite Base Frequency for frequency	6	RO	INT32
A534	42292	VIEWER	Minimum Composite Span Frequency for frequency	6	RO	INT32

Table 10: Transmitter Modbus Map (cont.)

Register (in Hex)	Register (in Decimal)	Access Level	Variable	Unit Group	Read Only/ Read Write	Format
A536	42294	VIEWER	Minimum Composite Frequency Output Unit	18	RO	INT32
A538	42296	VIEWER	Minimum Composite Frequency Output Error State	18	RO	INT32
A53A	42298	VIEWER	Minimum Composite Path Error Handling	18	RO	INT32
A53C	42300	VIEWER	Minimum Composite Unit Type Dimension	18	RO	INT32
A53E	42302	VIEWER	Minimum Composite Unit Type Density	18	RO	INT32
A540	42304	VIEWER	Minimum Composite Unit Type Mass Flow	18	RO	INT32
A542	42306	VIEWER	Minimum Composite Unit Type Volumetric	18	RO	INT32
A544	42308	VIEWER	Minimum Composite Unit Type Velocity	18	RO	INT32
A546	42310	VIEWER	Minimum Composite test frequency for frequency output	6	RO	INT32
A548	42312	VIEWER	Minimum Composite Sensor serial number 3	18	RO	INT32
A54A	42314	VIEWER	Minimum Composite Sensor serial number 4	18	RO	INT32
A54C	42316	VIEWER	Minimum Composite Sensor serial number 5	18	RO	INT32
A54E	42318	VIEWER	Minimum Composite Sensor serial number 6	18	RO	INT32
A550	42320	VIEWER	Minimum Composite Flow meter/System serial number	18	RO	INT32
A552	42322	VIEWER	Minimum Composite Unit Type Time	18	RO	INT32
A554	42324	VIEWER	Minimum Composite Unit Type Viscosity	18	RO	INT32
A556	42326	VIEWER	Minimum Composite Unit Type Standard Volumetric	18	RO	INT32
A558	42328	VIEWER	Minimum Composite Standard BWT Buffer 1 Serial Number	18	RO	INT32
A55A	42330	VIEWER	Minimum Composite Standard BWT Buffer 2 Serial Number	18	RO	INT32
A55C	42332	VIEWER	Minimum Composite Standard BWT Buffer 3 Serial Number	18	RO	INT32
A55E	42334	VIEWER	Minimum Composite Standard BWT Buffer 4 Serial Number	18	RO	INT32
A560	42336	VIEWER	Minimum Composite Standard BWT Buffer 5 Serial Number	18	RO	INT32
A562	42338	VIEWER	Minimum Composite Standard BWT Buffer 6 Serial Number	18	RO	INT32
A564	42340	VIEWER	Minimum UMPU Receiver Serial Number	18	RO	INT32
CH Real Max						
A800	43008	VIEWER	Maximum Channel Composite Coefficient	18	RO	(IEEE 32 bit)
A802	43010	VIEWER	Maximum Channel Time Buffer Offset	19	RO	(IEEE 32 bit)
A804	43012	VIEWER	Maximum Channel Time in Wedge	19	RO	(IEEE 32 bit)
A806	43014	VIEWER	Maximum Channel Path Length P	5	RO	(IEEE 32 bit)
A808	43016	VIEWER	Maximum Channel Axial Length L	5	RO	(IEEE 32 bit)
A80A	43018	VIEWER	Maximum Channel Delay Between Successive Transmits	19	RO	(IEEE 32 bit)
A80C	43020	VIEWER	Maximum Channel DeltaT Offset	19	RO	(IEEE 32 bit)

Table 10: Transmitter Modbus Map (cont.)

Register (in Hex)	Register (in Decimal)	Access Level	Variable	Unit Group	Read Only/ Read Write	Format
CH Integer Max						
A900	43264	VIEWER	Maximum Channel Pct of Peak	12	RO	INT32
A902	43266	VIEWER	Maximum Channel Min Peak%	12	RO	INT32
A904	43268	VIEWER	Maximum Channel Max Peak%	12	RO	INT32
A906	43270	VIEWER	Maximum Channel Reynolds correction selection	18	RO	INT32
A908	43272	VIEWER	Maximum Channel enum of transducer type (ex. T5)	18	RO	INT32
A90A	43274	VIEWER	Maximum Channel Transducer Freq	6	RO	INT32
A90C	43276	VIEWER	Maximum Channel Errors Allowed	18	RO	INT32
CH Real Min						
AC00	44032	VIEWER	Minimum Channel Composite Coefficient	18	RO	(IEEE 32 bit)
AC02	44034	VIEWER	Minimum Channel Time Buffer Offset	19	RO	(IEEE 32 bit)
AC04	44036	VIEWER	Minimum Channel Time in Wedge	19	RO	(IEEE 32 bit)
AC06	44038	VIEWER	Minimum Channel Path Length P	5	RO	(IEEE 32 bit)
AC08	44040	VIEWER	Minimum Channel Axial Length L	5	RO	(IEEE 32 bit)
AC0A	44042	VIEWER	Minimum Channel delay between successive transmits	19	RO	(IEEE 32 bit)
AC0C	44044	VIEWER	Minimum Channel DeltaT Offset	19	RO	(IEEE 32 bit)
CH Integer Min						
AD00	44288	VIEWER	Minimum Channel Pct of Peak	12	RO	INT32
AD02	44290	VIEWER	Minimum Channel Min Peak%	12	RO	INT32
AD04	44292	VIEWER	Minimum Channel Max Peak%	12	RO	INT32
AD06	44294	VIEWER	Minimum Channel Reynolds Correction Selection	18	RO	INT32
AD08	44296	VIEWER	Minimum Channel enum of transducer type (ex. T5)	18	RO	INT32
AD0A	44298	VIEWER	Minimum Channel Transducer Freq	6	RO	INT32
AD0C	44300	VIEWER	Minimum Channel Errors Allowed	18	RO	INT32
CH Real Max						
AA00	43520	VIEWER	Maximum Channel Velocity	20	RO	(IEEE 32 bit)
AA02	43522	VIEWER	Maximum Channel Sound Speed	20	RO	(IEEE 32 bit)
AA04	43524	VIEWER	Maximum Channel Transit Time Up	19	RO	(IEEE 32 bit)
AA06	43526	VIEWER	Maximum Channel Transit Time Dn	19	RO	(IEEE 32 bit)
AA08	43528	VIEWER	Maximum Channel DeltaT	19	RO	(IEEE 32 bit)
AA0A	43530	VIEWER	Maximum Channel Time in buffer on DOWN channel	19	RO	(IEEE 32 bit)
AA0C	43532	VIEWER	Maximum Channel Up Signal Quality	18	RO	(IEEE 32 bit)
AA0E	43534	VIEWER	Maximum Channel Dn Signal Quality	18	RO	(IEEE 32 bit)
AA10	43536	VIEWER	Maximum Channel Up Amp Disc	18	RO	(IEEE 32 bit)
AA12	43538	VIEWER	Maximum Channel Dn Amp Disc	18	RO	(IEEE 32 bit)
AA14	43540	VIEWER	Maximum Channel Signal Gain Up	3	RO	(IEEE 32 bit)
AA16	43542	VIEWER	Maximum Channel Signal Gain Down	3	RO	(IEEE 32 bit)
AA18	43544	VIEWER	Maximum Channel_SNR on UP channel	18	RO	(IEEE 32 bit)
AA1A	43546	VIEWER	Maximum Channel_SNR on DOWN channel	18	RO	(IEEE 32 bit)

Table 10: Transmitter Modbus Map (cont.)

Register (in Hex)	Register (in Decimal)	Access Level	Variable	Unit Group	Read Only/ Read Write	Format
AA1C	43548	VIEWER	Maximum Channel Time in buffer on UP channel	19	RO	(IEEE 32 bit)
CH Integer Max						
AB00	43776	VIEWER	Maximum Channel status bit map	18	RO	INT32
AB02	43778	VIEWER	Maximum Channel Up +- Peak	18	RO	INT32
AB04	43780	VIEWER	Maximum Channel Dn +- Peak	18	RO	INT32
AB06	43782	VIEWER	Maximum Channel most significant error	18	RO	INT32
AB08	43784	VIEWER	Maximum Channel dynamic threshold on UP channel	12	RO	INT32
AB0A	43786	VIEWER	Maximum Channel dynamic threshold on DOWN channel	12	RO	INT32
AB0C	43788	VIEWER	Maximum Channel #Errors of Last 16	18	RO	INT32
CH Real Min						
AE00	44544	VIEWER	Minimum Channel Velocity	20	RO	(IEEE 32 bit)
AE02	44546	VIEWER	Minimum Channel Sound Speed	20	RO	(IEEE 32 bit)
AE04	44548	VIEWER	Minimum Channel Transit Time Up	19	RO	(IEEE 32 bit)
AE06	44550	VIEWER	Minimum Channel Transit Time Dn	19	RO	(IEEE 32 bit)
AE08	44552	VIEWER	Minimum Channel DeltaT	19	RO	(IEEE 32 bit)
AE0A	44554	VIEWER	Minimum Channel Time in buffer on DOWN channel	19	RO	(IEEE 32 bit)
AE0C	44556	VIEWER	Minimum Channel Up Signal Quality	18	RO	(IEEE 32 bit)
AE0E	44558	VIEWER	Minimum Channel Dn Signal Quality	18	RO	(IEEE 32 bit)
AE10	44560	VIEWER	Minimum Channel Up Amp Disc	18	RO	(IEEE 32 bit)
AE12	44562	VIEWER	Minimum Channel Dn Amp Disc	18	RO	(IEEE 32 bit)
AE14	44564	VIEWER	Minimum Channel Signal Gain Up	3	RO	(IEEE 32 bit)
AE16	44566	VIEWER	Minimum Channel Signal Gain Down	3	RO	(IEEE 32 bit)
AE18	44568	VIEWER	Minimum Channel_SNR on UP channel	18	RO	(IEEE 32 bit)
AE1A	44570	VIEWER	Minimum Channel_SNR on DOWN channel	18	RO	(IEEE 32 bit)
AE1C	44572	VIEWER	Minimum Channel Time in buffer on UP channel	19	RO	(IEEE 32 bit)
CH Integer Min						
AF00	44800	VIEWER	Minimum Channel status bit map	18	RO	INT32
AF02	44802	VIEWER	Minimum Channel Up +- Peak	18	RO	INT32
AF04	44804	VIEWER	Minimum Channel Dn +- Peak	18	RO	INT32
AF06	44806	VIEWER	Minimum Channel most significant error	18	RO	INT32
AF08	44808	VIEWER	Minimum Channel dynamic threshold on UP channel	12	RO	INT32
AF0A	44810	VIEWER	Minimum Channel dynamic threshold on DOWN channel	12	RO	INT32
AF0C	44812	VIEWER	Minimum Channel #Errors of Last 16	18	RO	INT32
Ultrasonic Files						
A000	40960	VIEWER	Channel 1 Raw Up	18	RO	signed short
A001	40961	VIEWER	Channel 1 Raw Down	18	RO	signed short
A002	40962	VIEWER	Channel 1 Correlate Up	18	RO	signed short
A003	40963	VIEWER	Channel 1 Correlate Down	18	RO	signed short

Table 10: Transmitter Modbus Map (cont.)

Register (in Hex)	Register (in Decimal)	Access Level	Variable	Unit Group	Read Only/Read Write	Format
A004	40964	VIEWER	Channel 1 CrossCorrelation	18	RO	signed short
A010	40976	VIEWER	Channel 2 Raw Up	18	RO	signed short
A011	40977	VIEWER	Channel 2 Raw Down	18	RO	signed short
A012	40978	VIEWER	Channel 2 Correlate Up	18	RO	signed short
A013	40979	VIEWER	Channel 2 Correlate Down	18	RO	signed short
A014	40980	VIEWER	Channel 2 CrossCorrelation	18	RO	signed short

C.4 Modbus Unit Codes

Many of the items in the Modbus map have a unit of measure. The codes for these unit types are listed in Table 11 below. These are the standard Foundation Fieldbus unit codes.

Table 11: Unit Codes for XMT910

Parameter	Unit Codes	Symbol	Description
Temperature	1000	K	Kelvin
	1001	C	Degree Celsius
	1002	F	Degree Fahrenheit
	1003	R	Degree Rankine
Dimension	1010	m	Meter (Default)
	1013	mm	Millimeter
	1018	ft	Feet
	1019	in	Inch
Volume	1034	m ³	Cubic Meter
	1038	L	Liter
	1042	in ³	Cubic Inch
	1043	ft ³	Cubic Feet
	1048	gal	Us Gallon
	1051	BBL	Barrel
	1667	MGAL	Mega Gallons
	1663	MFT ³	Mega Cubic Feet
	1664	MBBL	Mega Barrels
	1645	ML	Mega Liters
Mass/Weight	1088	k	Kilogram
	1092	t	Metric Ton
	1094	LB	Pound (Mass)
	1095	SZ ³ N	Short Ton
Density	1097	kg/m ³	Kilograms Per Cubic Meter (Default)
	1107	LB/ft ³	Pounds Per Cubic Foot

Table 11: Unit Codes for XMT910 (cont.)

Parameter	Unit Codes	Symbol	Description
Mass Flow	1322	KG/S	Kilogram Per Second (Default)
	1323	KG/M	Kilogram Per Minute
	1324	KG/H	Kilogram Per Hour
	1325	KG/D	Kilogram Per Day
	1326	TNE/S	Metric Ton Per Second
	1327	TNE/M	Metric Ton Per Minute
	1328	TNE/H	Metric Ton Per Hour
	1329	TNE/D	Metric Ton Per Day
	1330	LB/S	Pound Per Second
	1331	LB/M	Pound Per Minute
	1332	LB/H	Pound Per Hour
	1333	LB/D	Pound Per Day
	1334	SZ3N/S	Short Ton Per Second
	1335	SZ3N/M	Short Ton Per Minute
	1336	SZ3N/H	Short Ton Per Hour
	1337	SZ3N/D	Short Ton Per Day
	1644	KLB/S	Kilo Pound Per Second
	1643	KLB/M	Kilo Pound Per Minute
1642	KLB/H	Kilo Pound Per Hour	
1641	KLB/D	Kilo Pound Per Day	

Table 11: Unit Codes for XMT910 (cont.)

Parameter	Unit Codes	Symbol	Description
Volume Flow (also called Actual Volumetric Flow)	1347	m3/S	Cubic Meter Per Second (Default)
	1348	m3/M	Cubic Meter Per Minute
	1349	m3/H	Cubic Meter Per Hour
	1350	m3/D	Cubic Meter Per Day
	1351	L/S	Liter Per Second
	1352	L/M	Liter Per Minute
	1353	L/H	Liter Per Hour
	1354	L/D	Liter Per Day
	1356	ft3/S	Cubic Feet Per Second
	1357	ft3/M	Cubic Feet Per Minute
	1358	ft3/H	Cubic Feet Per Hour
	1359	ft3/D	Cubic Feet Per Day
	1362	GAL/S	US Gallon Per Second
	1363	GAL/M	US Gallon Per Minute
	1364	GAL/H	US Gallon Per Hour
	1365	GAL/D	US Gallon Per Day
	1371	BBL/S	Barrel Per Second
	1372	BBL/M	Barrel Per Minute
	1373	BBL/H	Barrel Per Hour
	1374	BBL/D	Barrel Per Day
	1454	KGAL/M	Kilo US Gallon Per Minute
	1458	KGAL/H	Kilo US Gallon Per Hour
1462	KGAL/D	Kilo US Gallon Per Day	
1485	KBBL/M	Kilobarrel Per Minute	
1489	KBBL/H	Kilobarrel Per Hour	
1493	KBBL/D	Kilobarrel Per Day	
Standard Volume Flow	1537	SL/S	Standard Liters per Second (default)
	1538	SL/M	Standard Liters per Minute
	1539	SL/H	Standard Liters per Hour
	1540	SML/D	Standard Mega Liters per Day
	1527	Sm3/S	Standard Cubic Meter per Second
	1528	Sm3/M	Standard Cubic Meter per Minute
	1529	Sm3/H	Standard Cubic Meter per Hour
	1530	Sm3/D	Standard Cubic Meter per Day
	1361	SCFH	Standard Cubic Feet Per Hour
	1360	SCFM	Standard Cubic Feet Per Minute
Velocity Units	1061	m/s	Meters Per Sec (Default)
	1067	ft/s	Feet per sec

Table 11: Unit Codes for XMT910 (cont.)

Parameter	Unit Codes	Symbol	Description
Time Units	1054	s	Second
	1056	ms	Millisecond
	1057	us	Microsecond
	1059	h	Hour
Frequency Units	1077	Hz	Hertz
	1080	MHz	Mega Hertz
	1081	kHz	Kilo Hertz
Current	1209	amp	Ampere
	1211	ma	Milliampere

C.5 Modbus Protocol

In general, the PanaFlow Z3 flow meter follows the standard Modbus communications protocol defined by the reference MODBUS APPLICATION PROTOCOL SPECIFICATION V1.1b. This specification is available at www.modbus.org on the Internet. With this reference as a guide, an operator could use any Modbus master to communicate with the flow meter.

Listed below are two limits of this implementation:

1. The PanaFlow Z3 supports only four of the standard function codes. These are Read Holding Registers (0x03), Read Input Registers (0x04), Write Multiple Registers (0x10), and Read File Record (0x14).
2. The flow meter needs a 15 msec gap between Modbus requests. The prime objective of the flow meter is to measure flow and drive the output, so the Modbus server has a low priority.

Appendix D. HART® Menu Maps

D.1 HART Connection

D.1.1 Wiring to the HART Circuit

When connecting a HART communicator to the wiring terminals on the PanaFlow Z3 electronics terminal board, the circuit must be terminated in an appropriate resistive load, as shown in *Figure 28* below. The HART communicator is connected in parallel with that load.

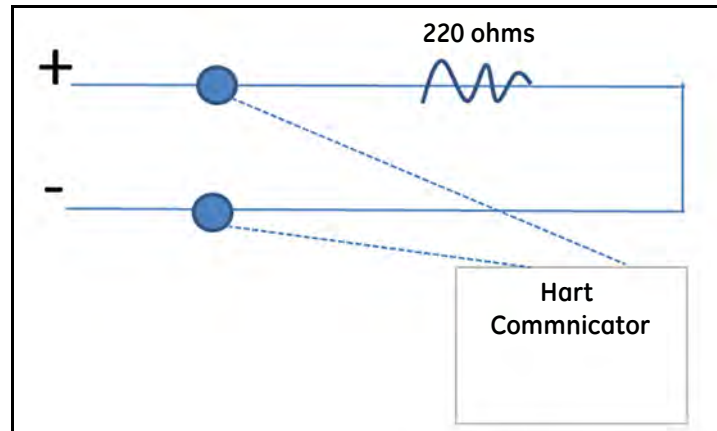

Figure 28: Wiring Diagram for HART Communication

D.1.2 Write Mode Switch

The PanaFlow Z3 HART circuit includes a slide switch that can be used to disable write access to the instrument via HART. This white slide switch (pictured in *Figure 29* below) is designed to lock out HART configuration access for those customers who require this extra level of security. With the *Write Mode* switch pushed toward the Display board as shown, the HART circuit is in write access mode.

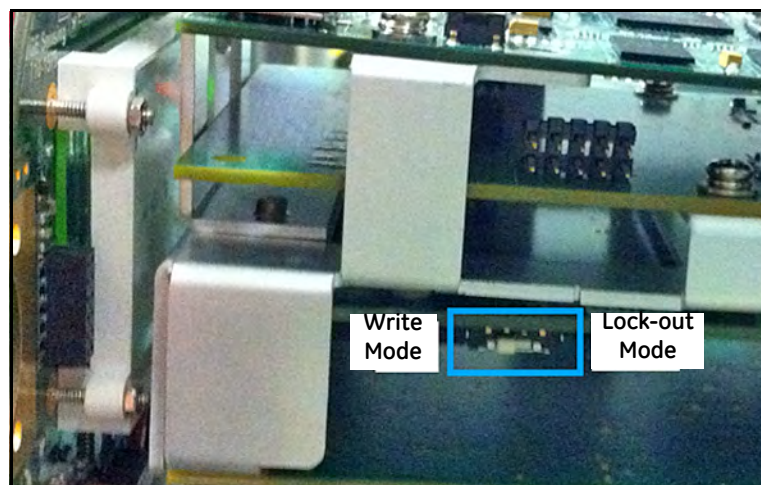

Figure 29: HART Circuit Write Mode Switch

D.1.2 Write Mode Switch (cont.)

Note: *The following sections of this Appendix provide a map to programming functions via HART communication. To make programming changes through HART, the HART circuit must be set to “write” mode. If your HART device cannot make program changes, inspect the switch to be sure your HART circuit is in “write” mode.*

D.1.3 Use Force High with HART

The Authorized User may select Force High or Force Low for the Dangerous Detected state, the mA level that the Output will go to in case of an error detection. If the HART signal is going to be used by the system for frequent communication, we recommend selecting Force High. The Force Low level, 3.6 mA, is marginally capable of carrying HART signals. By selecting Force High, 21.0 mA, the operator can be confident that in case of a fault condition, HART communication will be available to diagnose the cause of the fault.

D.2 Root Menu

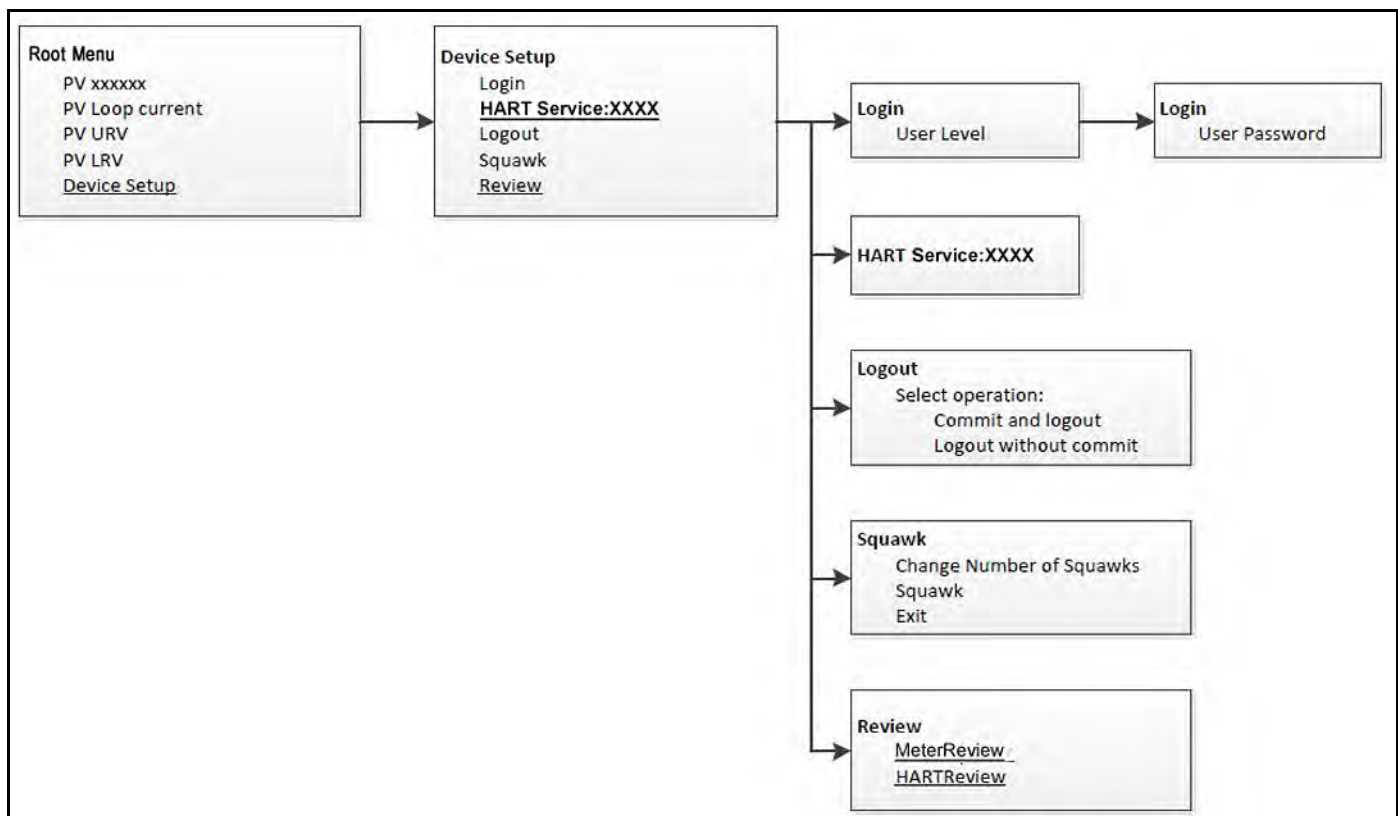

Figure 30: Root Menu

D.3 HART Service Map for General Users

If users log in the system with a *General User* password, they can edit the variables in the HART Service menu as shown in *Figure 31* below.

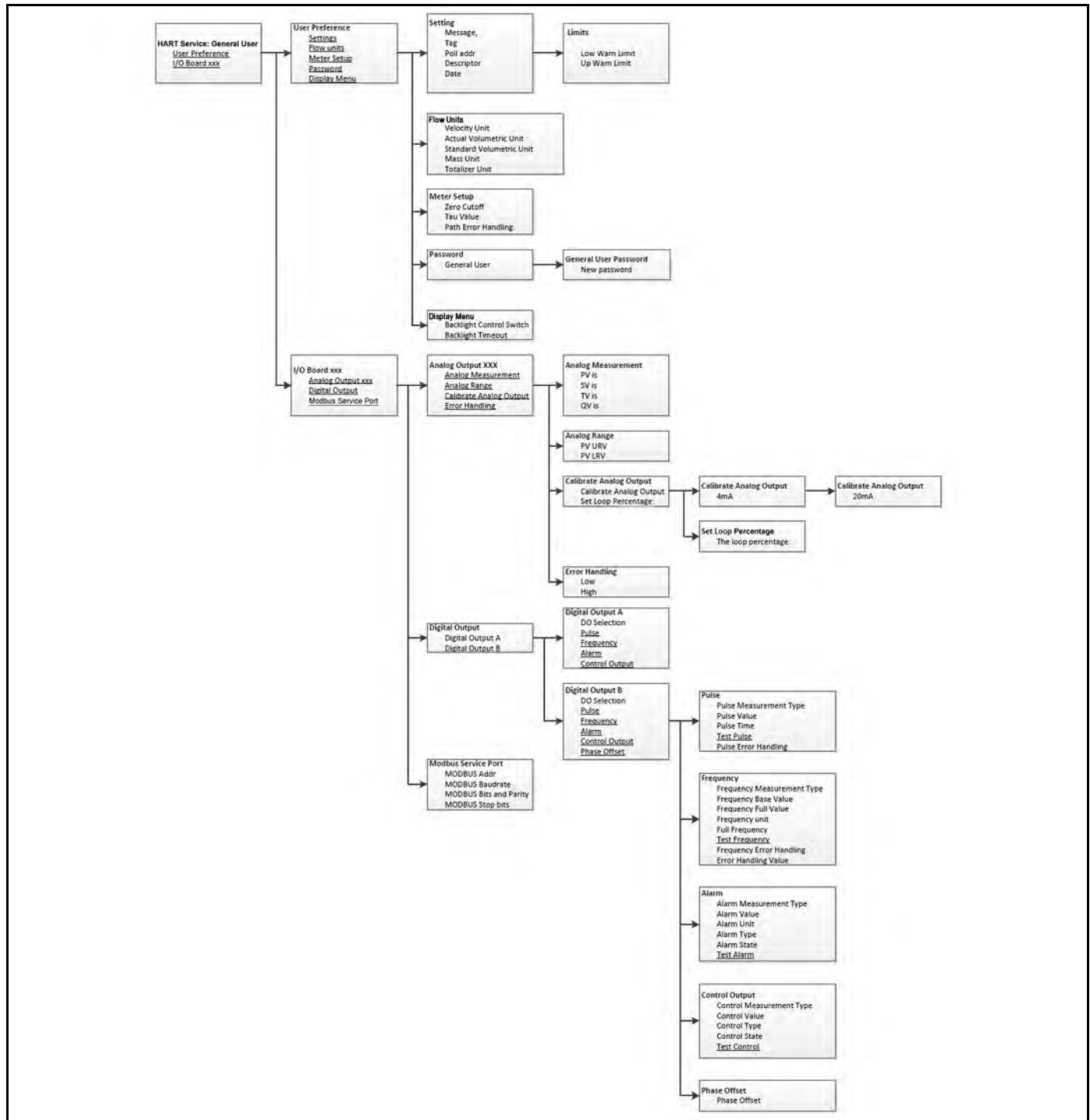

Figure 31: HART Service Menu for General User

D.4 HART Service Menu for Service Users

If users log in the system with a *Service User / Factory User* password, they can edit the variables in the HART Service menu as shown in *Figure 32* below.

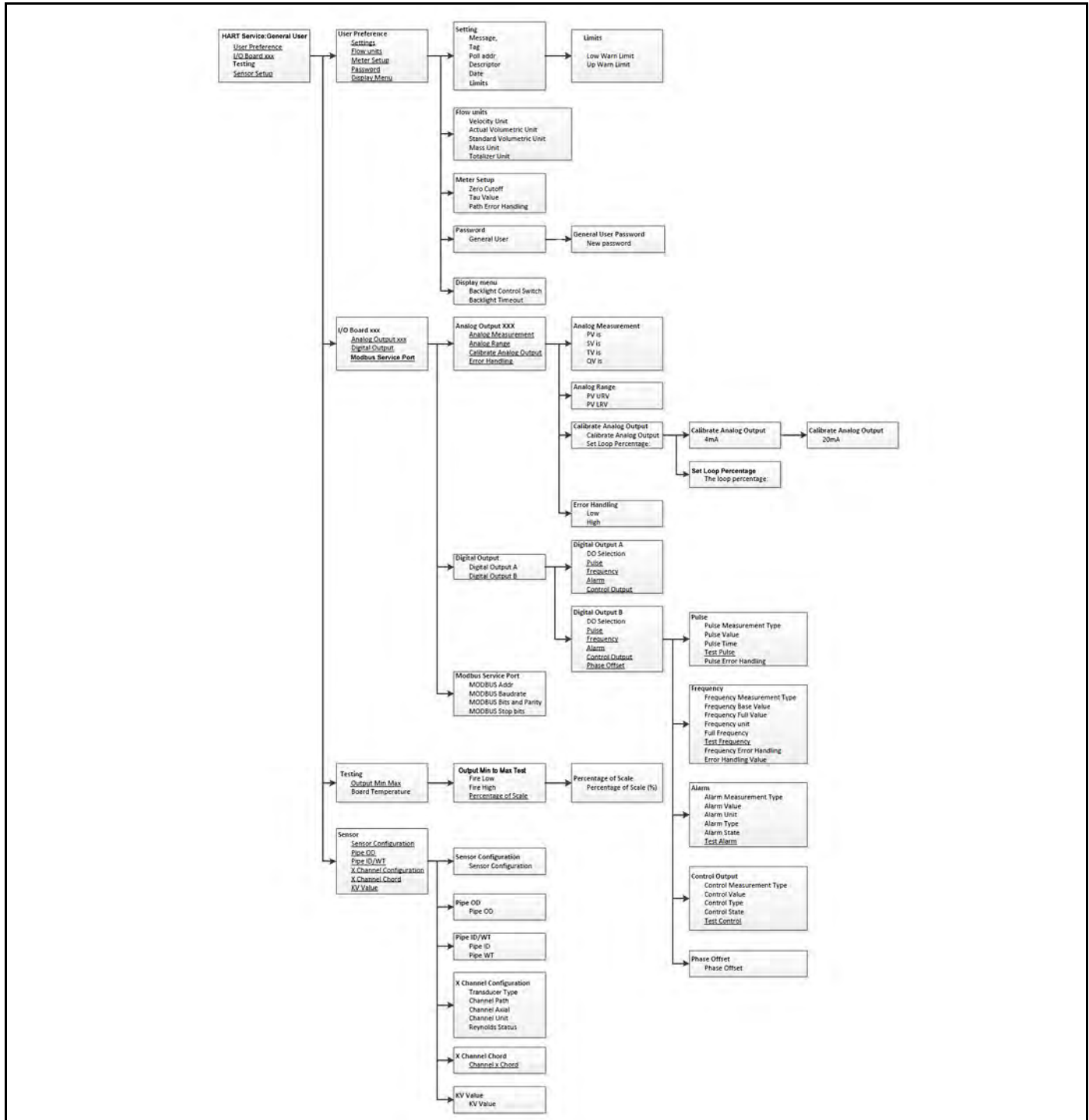

Figure 32: HART Service Menu for General User and Higher Levels

D.5 Review Menu

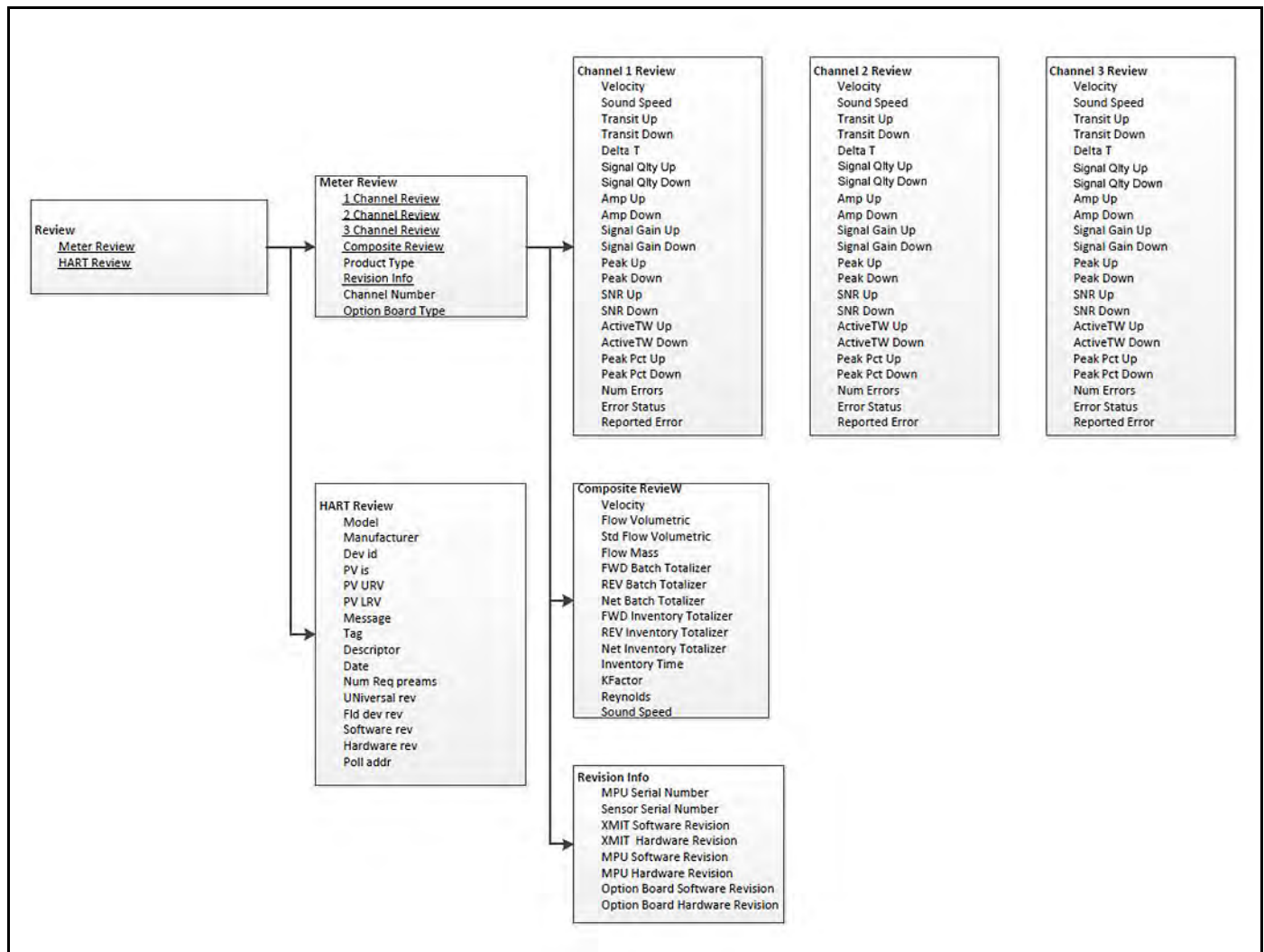

Figure 33: Review Menu

[no content intended for this page]

Appendix E. Data Records

E.1 Service Record

Whenever any service procedure is performed on the PanaFlow Z3 flow meter, the details of the service should be recorded in this appendix. An accurate service history of the meter can prove very helpful in troubleshooting any future problems.

E.1.1 Data Entry

Record complete and detailed service data for the PanaFlow Z3 in *Table 12* below. Make additional copies of the table as needed.

Table 12: Service Record

Date	Description of Service	Performed By

Table 12: Service Record (cont.)

Date	Description of Service	Performed By

E.2 Initial Settings

The values for the initial measurement settings immediately after initial installation of the meter and verification of proper operation should be entered in *Table 13* below.

Table 13: Initial Settings

Parameter	Initial Value
Velocity	
Volumetric	
Mass Flow	
Forward Batch Totals	
Reverse Batch Totals	
Totalizer Time	
Sound Speed	
Current Correction Factor	
Current Reynolds Number	
Current Operating Temperature	
Standard Volumetric	
Net Batch Totals	
Inventory Forward	
Inventory Reverse	
Inventory Net	
Inventory Time	
Channel 1 Velocity	
Channel 1 Sound Speed	
Channel 1 Transit Time Up	
Channel 1 Transit Time Down	
Channel 1 Delta T	
Channel 1 Up Signal Quality	
Channel 1 Down Signal Quality	

Table 13: Initial Settings (cont.)

Parameter	Initial Value
Channel 1 Up Amp Disc	
Channel 1 Down Amp Disc	
Channel 1 SNR on Up	
Channel 1 SNR on Down	
Channel 1 Time in Buffer on Up	
Channel 1 Time in Buffer on Down	
Channel 1 Signal Gain Up	
Channel 1 Signal Gain Down	
Channel 1 Up Peak	
Channel 1 Down Peak	
Channel 1 Dynamic Threshold Up	
Channel 1 Dynamic Threshold Down	
Channel 2 Velocity	
Channel 2 Sound Speed	
Channel 2 Transit Time Up	
Channel 2 Transit Time Down	
Channel 2 Delta T	
Channel 2 Up Signal Quality	
Channel 2 Down Signal Quality	
Channel 2 Up Amp Disc	
Channel 2 Down Amp Disc	
Channel 2 SNR on Up	
Channel 2 SNR on Down	
Channel 2 Time in Buffer on Up	
Channel 2 Time in Buffer on Down	
Channel 2 Signal Gain Up	

Table 13: Initial Settings (cont.)

Parameter	Initial Value
Channel 2 Signal Gain Down	
Channel 2 Up Peak	
Channel 2 Down Peak	
Channel 2 Dynamic Threshold Up	
Channel 2 Dynamic Threshold Down	
Channel 3 Velocity	
Channel 3 Sound Speed	
Channel 3 Transit Time Up	
Channel 3 Transit Time Down	
Channel 3 Delta T	
Channel 3 Up Signal Quality	
Channel 3 Down Signal Quality	
Channel 3 Up Amp Disc	
Channel 3 Down Amp Disc	
Channel 3 SNR on Up	
Channel 3 SNR on Down	
Channel 3 Time in Buffer on Up	
Channel 3 Time in Buffer on Down	
Channel 3 Signal Gain Up	
Channel 3 Signal Gain Down	
Channel 3 Up Peak	
Channel 3 Down Peak	
Channel 3 Dynamic Threshold Up	
Channel 3 Dynamic Threshold Down	

E.3 Diagnostic Parameters

The values for the diagnostic parameters immediately after initial installation of the meter and verification of proper operation should be entered in *Table 14* below. These initial values can then be compared to current values to help diagnose any future malfunction of the system.

Table 14: Diagnostic Parameters

Parameter	Initial	Current	Parameter	Initial	Current
Ch1 Velocity			Ch2 Velocity		
Ch1 Soundspeed			Ch2 Soundspeed		
Ch1 Transit Time Dn			Ch2 Transit Time Dn		
Ch1 Transit Time Up			Ch2 Transit Time Up		
Ch1 Delta T			Ch2 Delta T		
Ch1 Up Signal Quality			Ch2 Up Signal Quality		
Ch1 Dn Signal Quality			Ch2 Dn Signal Quality		
Ch1 Up Amp Disc			Ch2 Up Amp Disc		
Ch1 Dn Amp Disc			Ch2 Dn Amp Disc		
Ch1 SNR Up			Ch2 SNR Up		
Ch1 SNR Dn			Ch2 SNR Dn		
Ch1 Active TWup			Ch2 Active TWup		
Ch1 Active TWdn			Ch2 Active TWdn		
Ch1 Gainup			Ch2 Gainup		
Ch1 Gaindn			Ch2 Gaindn		
Ch1 Error Status			Ch2 Error Status		
Ch1 Report Error			Ch2 Report Error		
Ch1 Peak Up			Ch2 Peak Up		
Ch1 Peak Dn			Ch2 Peak Dn		
Ch1 Peak% Up			Ch2 Peak% Up		
Ch1 Peak% Dn			Ch2 Peak% Dn		
Ch1 Error			Ch2 Error		

Appendix F. CE Mark Compliance

F.1 Introduction

For CE Mark compliance, the PanaFlow Z3 flow meter must be wired in accordance with the instructions in this appendix.

IMPORTANT: *CE Mark compliance is required for all units intended for use in EU countries.*

F.2 Wiring

The PanaFlow Z3 must be wired with the recommended cable, and all connections must be properly shielded and grounded. Refer to *Table 15* below for the specific requirements.

Table 15: Wiring Requirements

Connection	Cable Type	Ground Termination
Transducer	Armored RG62 a/U	Grounded using a cable gland.
Input/Output	Armored 22 AWG shielded (e.g. Baystate #78-1197) with armored material added to outside of jacket	Grounded using a cable gland.
Power	Armored 14 AWG 3 conductor	Grounded using a cable gland.

Note: *If the PanaFlow Z3 is wired as described in this appendix, the unit will comply with the EMC Directive.*

[no content intended for this page]

A		Diagnostic Parameters
Access Levels	32	Initial Values 123, 126
Alarm, Setting	57	Table of Values 123, 126
Alarms	13	Diagnostics 70
Wiring.	13	Digital Outputs
Alarms Option Card		Wiring. 10
Fail-Safe Operation	13	Digital Outputs, Programming 50
Analog Measurements	48	Display Option 43
Analog Measurements, Setting	45	Display Programming 22
Analog Output A	44	Document Number i
Analog Output B	47	Down Arrow Key 21
Analog Output Menu	44, 47	
Analog Output, Setting Up.	48	E
Analog Outputs		Electrical Connections 7
Wiring.	9	Enter Key 21
Analog Outputs (Slot 0)		Environmental Compliance viii
Connecting	9	Error Display 67
Arrow Keys	21	Error Handling, Setting 46, 49
		Error Header 67
B		Error String, Communication 68
Backlight, Setting	43	Error String, Flow 68
Backlight, Timeout	43	Escape Key 21
Base Value, Setting	45, 48	
Baud Rate	62	F
		Flow Error String 68
C		Flowcell Problems 71
Calibrating Analog Output	46	Fluid 71
Calibration Port		Fluid
Wiring.	16	Physical Requirements 71
Calibration Value, Selecting	49	Problems 71
CE Mark Compliance	127	Soundspeed 71
Communication Error String	68	Fluid Problems 71
Connecting		Frequency Output
See Part Name		Wiring. 12
Control Output		Frequency, Setting 53
Wiring.	14	Full Value, Setting 45, 48
Control Output, Setting	60	
		G
D		Global
Decimal Places		Menu 30
Programming for Totalizer	26	Submenus 30
Density		Grounding. 7
Changing Flow Units	39	

H		Modbus/Service Port, Setting Up	62
HART Menu Maps	115	O	
I		On Board Temperature, Setting	66
Identification		Output A Option Board, Programming	44
Meter Body	4	Output Analog Switch, Testing	66
XMT Transmitter	4	Output B Option Card	47
Identification Labels	4	P	
Information Paragraphs	vii	PanaFlow Z3	
Input Voltage	17	Electrical Connections	7
Input/Output Menu	44	Identification	4
K		Lifting	5
Keypad Lockout	30	Magnetic Keypad	20
Keypad Program, Exiting if Unused	21	Unpacking	4
L		Wiring Diagram	7
Language Change	34	Password	42
Left Arrow Key	21	Path Error Handling	41
Lifting	5	Power	
Limits	35	Connecting	17
Line Power		Terminal Block	17
Wiring	17	Power Supplies	76
Locking Keypad	30	Program Menu	31
M		Programming	
Magnetic Keypad, Using	20	Display Parameters	22
Main Menu		Entering	32
Entering	29	Measurement Type	23
Main Menu Map	29	Pulse Output, Setting	51
Mass, Changing Flow Units	37	R	
Measurement Type		Return Policy	133
Programming	23	Right Arrow Key	21
Menu Map	19	S	
Meter Body		Safety	
Identification	4	Auxiliary Equipment	vii
Meter Setup Option	40	General Issues	vii
Meter Tag	34	Personal Equipment	viii
Min/Max Output, Testing	66	Safety Codes	3
Modbus		Service Record	121
Wiring	15	Settings	34
Modbus Parity	63	Slot 0	
Modbus Stop Bits	64	See Analog Outputs (Slot 0)	
Modbus/Service Port Address	64		

Soundspeed
 Fluid 71
 Specifications 73
 Starting or Stopping 28

T

Tau Value 41
 Terminal Block
 Analog Outputs - I/O 9
 Power - TB1 17
 Theory of Operation 2
 Totalizer
 Changing Measurement Units 38
 Resetting 28
 Totalizer Measurement 28
 Totalizer Net 61
 Totalizer Output
 Wiring 11
 Totalizer Programming
 Decimal Places 26
 Transducers
 Location 6
 Transit-Time Flow Measurement 2

U

UART Bits 63
 Unlocking Keypad 30
 Unpacking 4
 Up Arrow Key 21
 User Levels 32
 User Preferences 33

V

Velocity, Setting Flow Units 36
 Voltage, Input 17
 Volumetric, Setting Flow Units 37

W

Warranty 133
 Watchdog Test 66
 WEEE Directive viii

Wiring 13
 Analog Outputs 9
 Calibration Port 16
 CE Mark Compliance 127
 Control Output 14
 Digital Outputs 10
 Frequency Output 12
 Line Power 17
 Modbus/Service Port 15
 Option Card See Card Name
 Preparation 8
 Terminal Block See Block Name
 Totalizer (Pulse) Output 11
 Wiring Diagram 7

X

XMT910 Transmitter
 Identification 4

Z

Zero Cutoff 40

[no content intended for this page]

Warranty

Each instrument manufactured by GE Sensing is warranted to be free from defects in material and workmanship. Liability under this warranty is limited to restoring the instrument to normal operation or replacing the instrument, at the sole discretion of GE Sensing. Fuses and batteries are specifically excluded from any liability. This warranty is effective from the date of delivery to the original purchaser. If GE Sensing determines that the equipment was defective, the warranty period is:

- one year from delivery for electronic or mechanical failures
- one year from delivery for sensor shelf life

If GE Sensing determines that the equipment was damaged by misuse, improper installation, the use of unauthorized replacement parts, or operating conditions outside the guidelines specified by GE Sensing, the repairs are not covered under this warranty.

The warranties set forth herein are exclusive and are in lieu of all other warranties whether statutory, express or implied (including warranties or merchantability and fitness for a particular purpose, and warranties arising from course of dealing or usage or trade).

Return Policy

If a GE Sensing instrument malfunctions within the warranty period, the following procedure must be completed:

1. Notify GE Sensing, giving full details of the problem, and provide the model number and serial number of the instrument. If the nature of the problem indicates the need for factory service, GE Sensing will issue a RETURN AUTHORIZATION NUMBER (RAN), and shipping instructions for the return of the instrument to a service center will be provided.
2. If GE Sensing instructs you to send your instrument to a service center, it must be shipped prepaid to the authorized repair station indicated in the shipping instructions.
3. Upon receipt, GE Sensing will evaluate the instrument to determine the cause of the malfunction.

Then, one of the following courses of action will then be taken:

- If the damage is covered under the terms of the warranty, the instrument will be repaired at no cost to the owner and returned.
- If GE Sensing determines that the damage is not covered under the terms of the warranty, or if the warranty has expired, an estimate for the cost of the repairs at standard rates will be provided. Upon receipt of the owner's approval to proceed, the instrument will be repaired and returned.

[no content intended for this page]

Certification & Safety Statements for the PanaFlow Z3 Ultrasonic Liquid Flow Meter

When installing this apparatus in potentially hazardous areas, the following requirements must be met:

- Field wiring shall be rated at least 10°C above 85°C.
- Connecting cables shall be mounted securely and protected from mechanical damage, pulling and twisting.
- Cable entries are M20 or ¾" NPT.
- Cable glands of an approved flameproof design are required. These must be installed according to the manufacturer's instructions. Where the cable glands are provided by GE, the manufacturer's instructions, as supplied to GE, will be included in the documentation.
- The system is covered by the certificate numbers **FM13ATEX0070X** and **IECEX FMG 13.0028X** as shown on the labels on the next page. The system is certified as ATEX (and IECEx): II 2 G Ex d IIB +H2 T6 Gb in Ta = -40°C to +60°C ambient and IP67. The system temperature code is dependent upon the process fluid temperature with ranges of -20°C to +85°C when the flowcell material is ASME SA216 Gr.WCB and -40°C to +85°C when the flowcell material is ASME SA352 GR. LCB or SA351 Gr. CF8 or S351 Gr. CF8M. The surface temperature of the sensor body and electronics can approach the process fluid temperatures and all necessary precautions should be taken.
- Unused entries must be sealed using a suitably certified threaded plug.
- Modifications to the flameproof enclosure are not permitted.
- The apparatus should be de-energized before opening.
- Installation shall be in accordance with the installation instructions and the National Electrical Code® ANSI/NFPA 70, the Canadian Electrical Code C22.1, or IEC/EN 60079-14, as applicable.
- Equipment is of type flameproof "d" design and complies with: EN 60079-0:2012, EN 60079-1:2007, EN 60529:1991 +A1:2000, IEC 60079-0:2011, IEC 60079-1:2007, IEC 60529:2001.
- The product contains no exposed parts which produce surface temperature infrared, electromagnetic ionizing, or non-electrical dangers.
- The product must not be subjected to mechanical or thermal stresses in excess of those permitted in the certification documentation and the instruction manual.
- The product cannot be repaired by the user; it must be replaced by an equivalent certified product. Repairs should only be carried out by the manufacturer or by an approved repairer.
- Only trained, competent personnel may install, operate and maintain the equipment.
- The product is an electrical apparatus and must be installed in the hazardous area in accordance with the requirements of the EC Type Examination Certificate. The installation must be carried out in accordance with all the appropriate international, national and local standard codes and practices and site regulations for flameproof apparatus and in accordance with the instructions contained in the manual. Access to the circuitry must not be made during operation.



Special Conditions for Safe Use

- Consult the manufacturer if dimensional information on the flameproof joints is necessary.
- Follow the manufacturer's instructions to reduce the potential of an electrostatic charging hazard.
- Consult the manufacturer for genuine replacement flange fasteners. M10x35 hexagon socket cap screws of ISO 12.9 DIN912 grade steel (zinc-plated) or better with a minimum yield strength of 135,000 psi are acceptable alternatives.
- Consult the manufacturer for genuine replacement enclosure/adapter fasteners. M8x25 hexagon socket cap screws of ISO 12.9 DIN912 grade steel (zinc-plated) or better with a minimum yield strength of 135,000 psi are acceptable alternatives.

Markings

- Markings shall appear on the meter as shown below for the AC and DC powered versions:

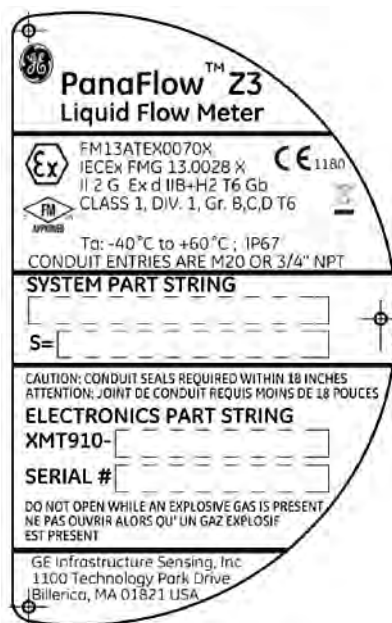

- Markings shall appear on the flowcell as shown below:

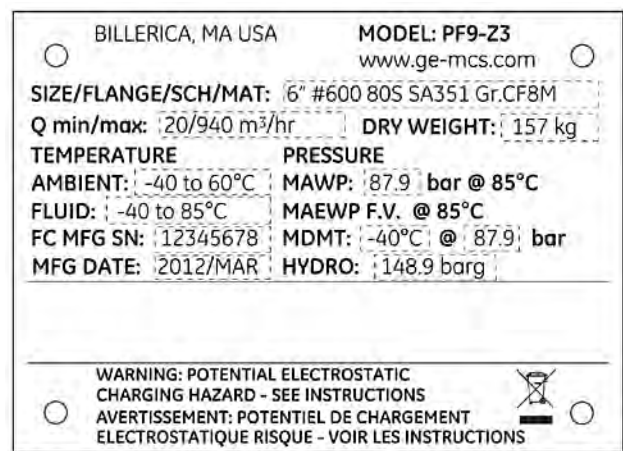

Connection & Wiring Diagram

- The connection & wiring diagram for the meter is shown below for the AC and DC powered versions:

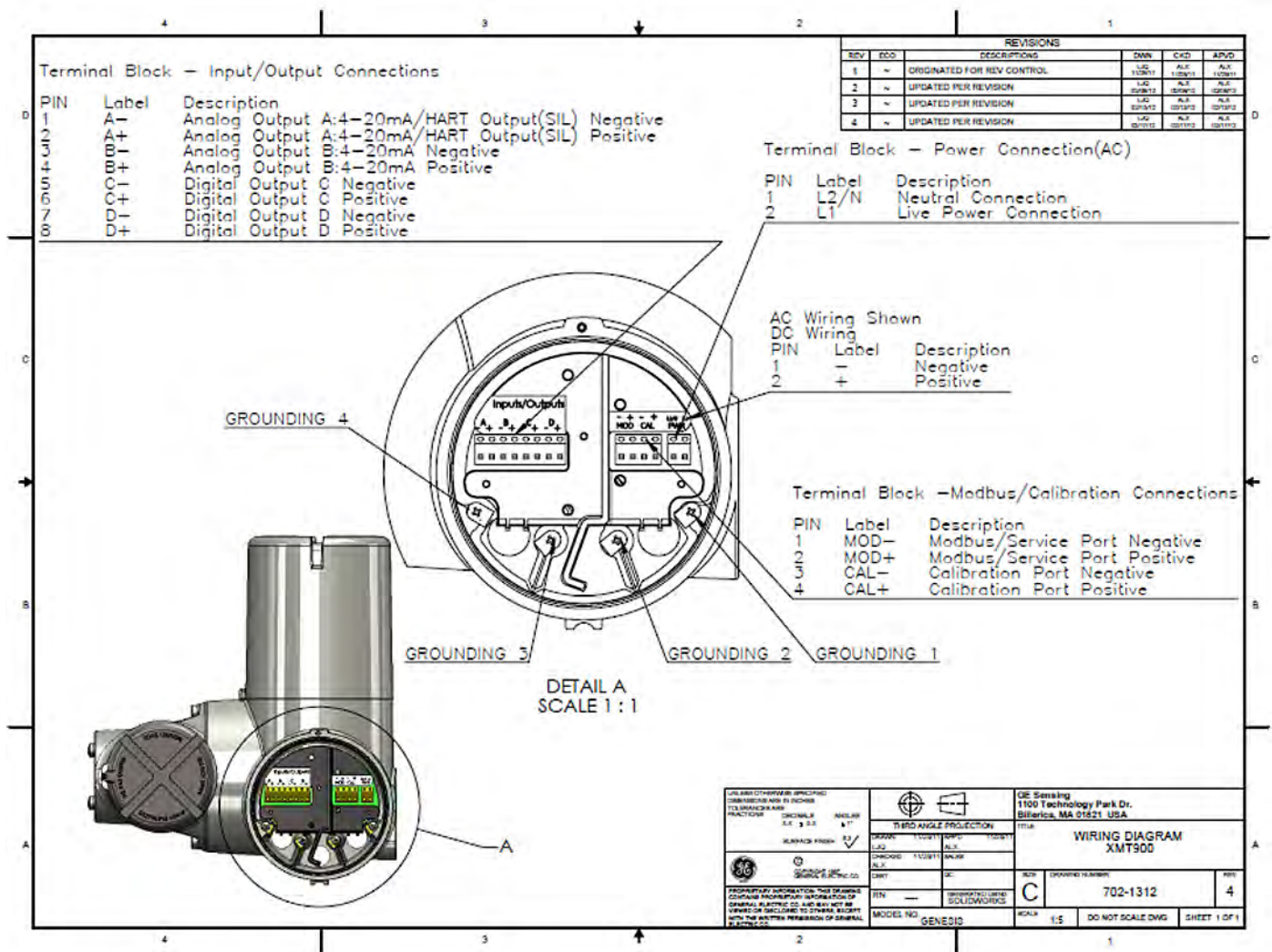

[no content intended for this page]

Customer Support Centers

U.S.A.

The Boston Center
1100 Technology Park Drive
Billerica, MA 01821
U.S.A.
Tel: 800 833 9438 (toll-free)
978 437 1000
E-mail: sensing@ge.com

Ireland

Sensing House
Shannon Free Zone East
Shannon, County Clare
Ireland
Tel: +353 (0)61 470200
E-mail: gesensingsnnservices@ge.com

An ISO 9001:2008 Certified Company

www.ge-mcs.com/en/about_us/quality.html

www.ge-mcs.com

©2014 General Electric Company. All rights reserved.
Technical content subject to change without notice.