

# Aurora H2O

## User's Manual





GE  
Oil & Gas

# Aurora H2O

## *Moisture Analyzer for Natural Gas*

**User's Manual**

910-284 Rev. I  
September 2016



[www.gemeasurement.com](http://www.gemeasurement.com)

©2016 General Electric Company. All rights reserved.  
Technical content subject to change without notice.

[no content intended for this page]

**Chapter 1. Features and Capabilities**

1.1 Overview..... 1

1.2 Features ..... 1

1.3 Theory of Operation ..... 2

1.4 Specifications ..... 9

    1.4.1 Power ..... 9

    1.4.2 Range ..... 9

    1.4.3 Accuracy ..... 9

    1.4.4 Response Time ..... 9

    1.4.5 Operating Pressure ..... 9

    1.4.6 Temperature ..... 10

    1.4.7 Flow Rate ..... 10

    1.4.8 Display ..... 10

    1.4.9 Inputs/Outputs ..... 10

    1.4.10 Enclosure ..... 10

    1.4.11 Laser Certification ..... 10

    1.4.12 User Interface ..... 11

    1.4.13 Weight and Dimensions ..... 11

    1.4.14 Hazardous Area Certification ..... 11

    1.4.15 European Certification ..... 11

    1.4.16 Software ..... 11

    1.4.17 Sampling System ..... 11

    1.4.18 Wetted Components ..... 11

**Chapter 2. Installation**

2.1 Introduction ..... 13

2.2 Bill of Materials ..... 13

2.3 Unpacking ..... 13

2.4 Choosing A Site for Installation ..... 14

2.5 Low Voltage Directive ..... 16

2.6 Mounting ..... 16

2.7 Optional Insertion Probe/Regulator ..... 17

    2.7.1 Description ..... 17

    2.7.2 Installation ..... 17

    2.7.3 Setting the Pressure ..... 25

2.8 Making Electrical Connections ..... 26

2.9 Specific Conditions of Use ..... 30

**Chapter 3. Operation and General Programming**

3.1 Using the Aurora H2O ..... 33

3.2	Sample System .....	33
3.2.1	Aurora H2O Startup.....	33
3.2.2	Aurora H2O Shut Down .....	34
3.2.3	Aurora H2O Purge Gas Connection .....	34
3.3	Keypad Features.....	36
3.3.1	Indicator Lights.....	37
3.3.2	The Magnetic Stylus .....	37
3.3.3	The Default Display.....	37
3.3.4	Unlocking the Keypad .....	38
3.3.5	Keypad Lock-Out Switch.....	38
3.3.6	Accessing the Menus .....	39
3.3.7	Entering Numeric Values.....	39
3.3.8	Starting Up.....	40
3.4	Setting Up the Display.....	40
3.4.1	Selecting Primary Units .....	40
3.4.2	Selecting Alt 1 and Alt 2 Units .....	41
3.4.3	Setting Decimal Places.....	41
3.4.4	Data/Scan.....	41
3.4.5	Adjust.....	42
3.4.6	Reverse .....	42
3.5	Setting Up the Outputs .....	42
3.5.1	Selecting an Output for Setup .....	42
3.5.2	Selecting Output Units .....	43
3.5.3	Selecting an Output Type .....	43
3.5.4	Changing the Upper Output Span .....	43
3.5.5	Changing the Lower Output Span .....	44
3.5.6	NAMUR Response .....	44
3.5.7	Testing the Output.....	45
3.5.8	Trimming the Outputs.....	46
3.6	Setting Up the Alarms .....	47
3.6.1	Selecting an Alarm Output .....	47
3.6.2	Selecting Alarm Status .....	48
3.6.3	Selecting Alarm Units .....	48
3.6.4	Selecting an Alarm Type .....	49
3.6.5	How the Alarm Types Work .....	49
3.6.6	Changing the Upper Alarm Span .....	50
3.6.7	Changing the Lower Alarm Span .....	50

**Chapter 4. Programming Advanced Features**

4.1 Comm Port Settings ..... 51

    4.1.1 Selecting a Comm Port ..... 51

    4.1.2 Setting the Baud Rate ..... 51

    4.1.3 Setting Parity ..... 52

    4.1.4 Selecting Protocol ..... 52

    4.1.5 Setting the Network ID ..... 52

4.2 Adjust Offset Values ..... 53

    4.2.1 Adjusting the PPMv Offset ..... 53

    4.2.2 Adjusting the Smoothing Filter ..... 53

    4.2.3 Adjusting the Scan Averaging ..... 54

    4.2.4 Setting the Dew Point Calculation Method ..... 55

4.3 Set Up the Background Gas ..... 56

    4.3.1 Selecting the Type of Gas ..... 56

    4.3.2 Setting the Z Factor ..... 57

    4.3.3 Entering a Label ..... 58

    4.3.4 Adjusting the Gas Offset ..... 60

4.4 Clock Settings ..... 61

    4.4.1 Resetting the Hour ..... 61

    4.4.2 Resetting the Minutes ..... 61

    4.4.3 Resetting the Month ..... 61

    4.4.4 Resetting the Date ..... 62

    4.4.5 Resetting the Year ..... 62

4.5 Pressure Settings ..... 63

    4.5.1 Setting Pressure Units ..... 63

    4.5.2 Setting the Source ..... 63

    4.5.3 Changing the Constant ..... 63

    4.5.4 Editing Pressure Calibration ..... 64

4.6 Regional Settings ..... 65

    4.6.1 Setting the Country Code ..... 65

    4.6.2 Setting the Decimal Format ..... 66

    4.6.3 Setting the Date Format ..... 66

    4.6.4 Setting the Unit System ..... 66

4.7 User Calibration ..... 67

4.8 Service Settings ..... 69

4.9	Aurora H2O Information .....	70
4.9.1	Checking the ID.....	70
4.9.2	Checking the System Status.....	70
4.9.3	Checking the Software.....	71
4.9.4	Checking the Gas Composition.....	71
4.9.5	Checking the Alternate Gas Composition .....	72
4.10	Locking/Unlocking the Display .....	73
<b>Chapter 5. AuroraView Interface Software</b>		
5.1	Capabilities .....	77
5.2	Requirements.....	77
5.3	Installing AuroraView.....	78
5.4	Starting AuroraView .....	85
5.5	Using the Main Menus.....	87
5.6	Datalogging with AuroraView.....	92
5.7	Working with Trend Plots, Trend Tabular Data and Scan Plots .....	93
<b>Chapter 6. Maintenance</b>		
6.1	Spare Parts .....	99
6.2	Cleaning the Mirror.....	99
6.2.1	Instructions for Optical Absorption Cell Style 1 .....	101
6.2.2	Instructions for Optical Absorption Cell Style 2 .....	106
6.3	Replacing the Filter Element .....	110
<b>Chapter 7. Troubleshooting</b>		
7.1	Introduction.....	113
7.2	Blank Display .....	113
7.3	Display Dim or Hard to Read.....	113
7.4	Status Messages and Indicators .....	113
7.5	No Flow Measurement Indicated on Aurora H2O Measurement Cell Outlet .....	115
7.6	Verifying Aurora H2O Performance in the Field .....	115
7.6.1	Using A Portable Hygrometer .....	115
7.6.2	Using a Moisture Standard .....	116
7.7	Background Selection Lockout.....	117
<b>Appendix A. MODBUS RTU/RS485 Communications</b>		
A.1	Introduction.....	119
A.2	Modbus Functions and Data Types.....	119
A.3	Modbus Registers .....	120
A.4	Modbus System Status Codes .....	125



---

## Information Paragraphs

**Note:** *These paragraphs provide information that provides a deeper understanding of the situation, but is not essential to the proper completion of the instructions.*

**IMPORTANT:** *These paragraphs provide information that emphasizes instructions that are essential to proper setup of the equipment. Failure to follow these instructions carefully may cause unreliable performance.*



**CAUTION!** This symbol indicates a risk of potential minor personal injury and/or severe damage to the equipment, unless these instructions are followed carefully.



**WARNING!** This symbol indicates a risk of potential serious personal injury, unless these instructions are followed carefully.

## Safety Issues



**WARNING!** It is the responsibility of the user to make sure all local, county, state and national codes, regulations, rules and laws related to safety and safe operating conditions are met for each installation.



**WARNING!** For installations in potentially hazardous areas, be sure to read the *Certification and Safety Statements* document at the end of this manual before beginning the installation.

## Auxiliary Equipment

### Local Safety Standards

The user must make sure that he operates all auxiliary equipment in accordance with local codes, standards, regulations, or laws applicable to safety.

### Working Area



**WARNING!** Auxiliary equipment may have both manual and automatic modes of operation. As equipment can move suddenly and without warning, do not enter the work cell of this equipment during automatic operation, and do not enter the work envelope of this equipment during manual operation. If you do, serious injury can result.



**WARNING!** Make sure that power to the auxiliary equipment is turned OFF and locked out before you perform maintenance procedures on the equipment.

## Qualification of Personnel

Make sure that all personnel have manufacturer-approved training applicable to the auxiliary equipment.

## Personal Safety Equipment

Make sure that operators and maintenance personnel have all safety equipment applicable to the auxiliary equipment. Examples include safety glasses, protective headgear, safety shoes, etc.

## Unauthorized Operation

Make sure that unauthorized personnel cannot gain access to the operation of the equipment.

## Environmental Compliance

### Waste Electrical and Electronic Equipment (WEEE) Directive

GE Measurement & Control Solutions is an active participant in Europe's *Waste Electrical and Electronic Equipment* (WEEE) take-back initiative, directive 2012/19/EU.

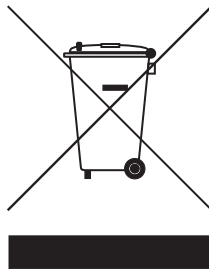

The equipment that you bought has required the extraction and use of natural resources for its production. It may contain hazardous substances that could impact health and the environment.

In order to avoid the dissemination of those substances in our environment and to diminish the pressure on the natural resources, we encourage you to use the appropriate take-back systems. Those systems will reuse or recycle most of the materials of your end life equipment in a sound way.

The crossed-out wheeled bin symbol invites you to use those systems.

If you need more information on the collection, reuse and recycling systems, please contact your local or regional waste administration.

Visit <https://www.gemeasurement.com/environmental-health-ehs> for take-back instructions and more information about this initiative.

## RoHS Compliance

The Aurora H2O is fully compliant with RoHS requirements.

# Chapter 1. Features and Capabilities

## 1.1 Overview

GE's **Aurora H2O Moisture Analyzer for Natural Gas** makes it possible for natural gas processing and transportation facilities to monitor moisture content in real-time with high precision and reliability.

The **Aurora H2O** analyzer uses tunable diode laser absorption spectroscopy (TDLAS) to measure moisture in natural gas at the speed of light. The analyzer is suitable for installation in hazardous areas and operates over a wide range of environmental conditions. **Aurora's** fast response quickly alerts and documents when moisture concentrations are out of compliance. Once process upsets are corrected and the gas dries out, the fast response quickly enables natural gas to be cleared for entry into the "energy grid".

### CLASS 1 LASER PRODUCT



**WARNING!** Use of controls or adjustments or the performance of procedures other than those specified herein may result in hazardous laser exposure.

## 1.2 Features

- Optical response: < 2 seconds after flow cell is purged.
- No cross sensitivity to glycols or amines.
- Direct readout in lbs/mmscf, mg/m<sup>3</sup> or ppm.
- Reads process pressure dew point (with user programmable constant or live auxiliary input for process pressure).
- Turnkey sampling system specifically designed for natural gas applications ensures measurement integrity.
- Magnetic Stylus enables through-glass programming – hot permit not required to field program.
- Explosion-proof/Flameproof design
- 4-20 mA signals and RS-232/485 MODBUS RTU for connection to SCADA or plant monitoring system.
- Supplied with **AuroraView** software for remote configuration, data logging and data retrieval capacity.
- NIST traceable calibration.
- In conformance with IEC 60825-1 Edition 2.0, Safety of Laser Products.

### 1.3 Theory of Operation

The GE **Aurora H2O** (Tunable Diode Laser Absorption Spectroscopy) hygrometer for natural gas is a system designed to continuously monitor the moisture content in natural gas. It fundamentally measures the partial pressure of water vapor (water in the gas state), and with the simultaneous measurement of pressure and temperature, provides readings and both analog and digital signal transmission of user-selectable moisture parameters including dew point temperature, volume ratio and absolute humidity (lbs/MMSCF or mg/m<sup>3</sup>) in addition to temperature and pressure.

The **Aurora H2O** is supplied with an integrated sampling system which includes an optional pipe-mounted liquid separator and pressure reducing valve/regulator, and the following components mounted within a stainless steel enclosure: isolation valve, coalescing filter, coalescer flow control valve, sample cell control valve, second pressure reducing valve/regulator, and flow indicator (rotameter), as well as an optional electrical heater and thermostat.

The fundamental water vapor pressure measurement is based on the *Beer-Lambert Law*:

$$A = \ln\left(\frac{I_0}{I}\right) = SLN$$

where: A = Absorbance

I = Light intensity transmitted through a sample gas

I<sub>0</sub> = Incident light intensity

S = Absorption coefficient\*

L = Absorption path length (a constant)

N = Concentration of the water vapor in the absorption cell

\* The absorption coefficient is a constant for a specific gas composition at a given pressure and temperature.

The concentration of the water is directly related to the partial pressure. At certain specific frequencies, light energy will be absorbed by water molecules. As the concentration of water increases, the absorption also increases. The **Aurora H2O** sweeps the diode laser output across a narrow band in the near infrared spectrum and, by measuring the light intensity with a photo detector, is able to provide a direct indication of the partial pressure of water. The partial pressure, multiplied by 10<sup>6</sup> and divided by the total pressure, yields the volume ratio in ppm<sub>v</sub> (parts per million by volume).

The laser diode is housed in a hermetically sealed and dry housing. The light is transmitted through a window made of proprietary transparent material. The light travels through a stainless steel cell and is reflected off a gold-plated mirror and returned to a photo detector, where the light intensity is measured.

### 1.3 Theory of Operation (cont.)

Since only light comes in contact with the sample of natural gas, and all of the wetted materials are made of non-corrosive and inert materials, this technology does not exhibit the drift associated with gas contacting sensor-based hygrometers. The diode laser emits low energy light, and therefore the system will not ignite the gas. The complete system is rated explosion-proof, and the **Aurora H2O** provides very fast response time. Once the absorption cell (see *Figure 1* below) is purged, the response time is a matter of a few seconds.

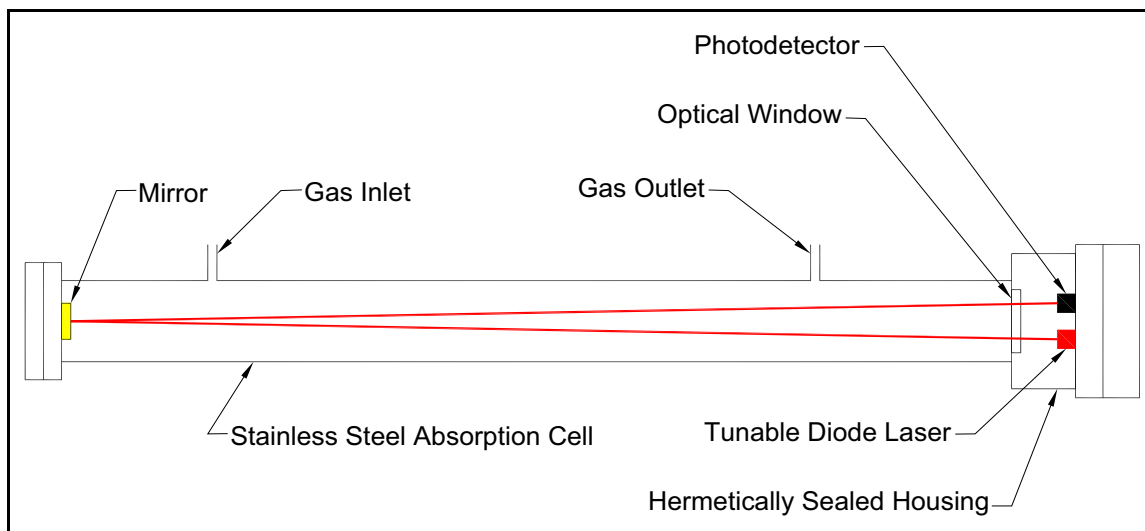

Figure 1: Laser Absorption Cell, Basic Elements

The control of the laser, power supply and signal conditioning circuitry are housed in an explosion-proof transmitter enclosure. A backlit, three-parameter, LCD display provides digital indication of user-programmable parameters. The **Aurora H2O** has three user-programmable (4-20 mA) analog outputs and two programmable digital ports that may be configured as either RS-485 or RS-232 with Modbus protocol. The analyzer has an auxiliary analog input (4-20 mA) input that is used for connection to an optional process pressure transmitter. Measurement of the process pressure enables the **Aurora H2O** to display and transmit the process dew point. **AuroraView** software is provided and enables remote readings, programming data logging and data logging with a personal computer.

The **Aurora H2O** hygrometer is calibrated against an NIST (or other national metrological institute) traceable reference dew/point generator and hygrometer. Each system is supplied with a certificate of calibration with functional test data.

### 1.3 System Components (cont.)

**Note:** Refer to Figure 2 below and Table 1 on page 6 to identify your Aurora components.

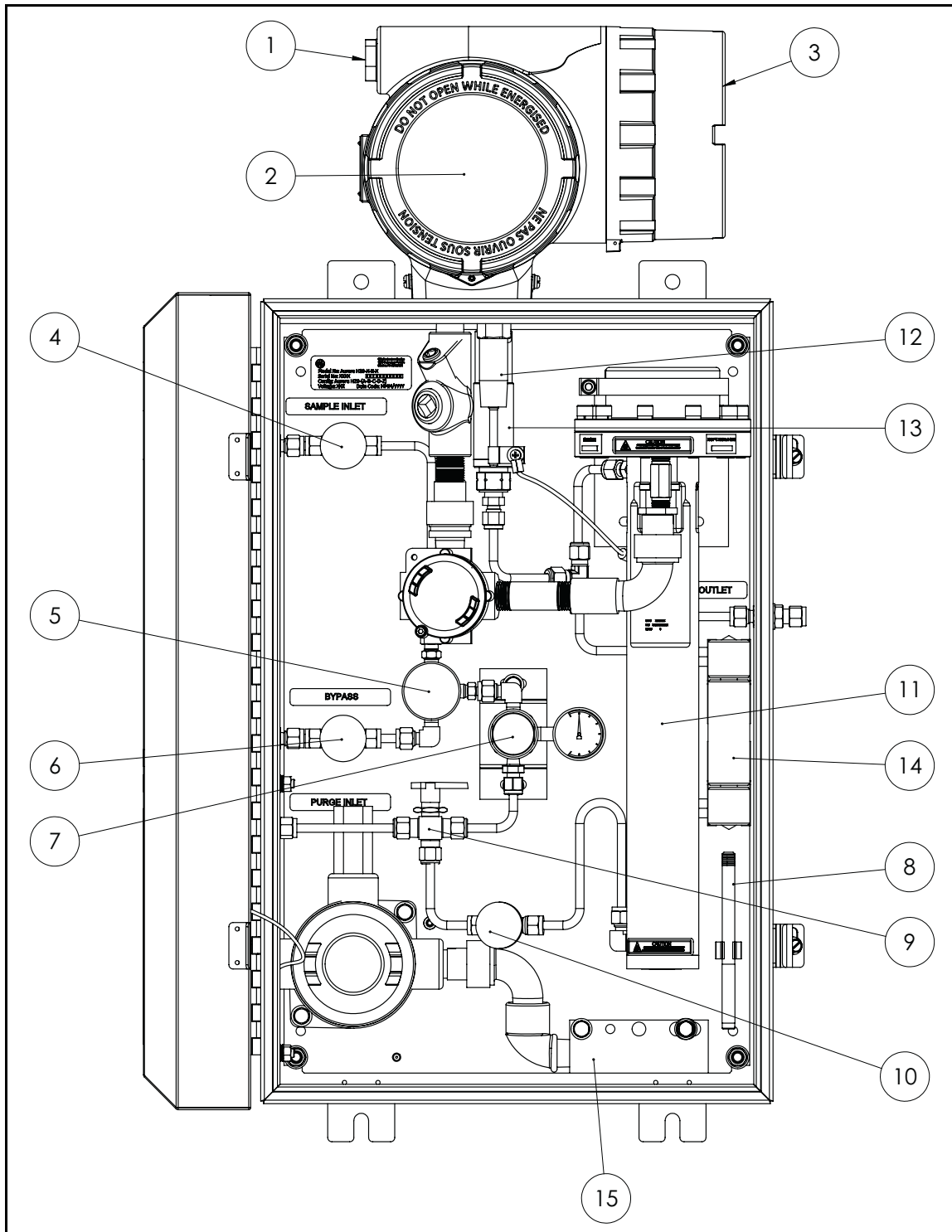

Figure 2: Aurora H2O System Assembly with Optional USA/CAN Heater

### 1.3 System Components (cont.)

**Note:** Refer to Figure 3 below and Table 1 on page 6 to identify your Aurora components.

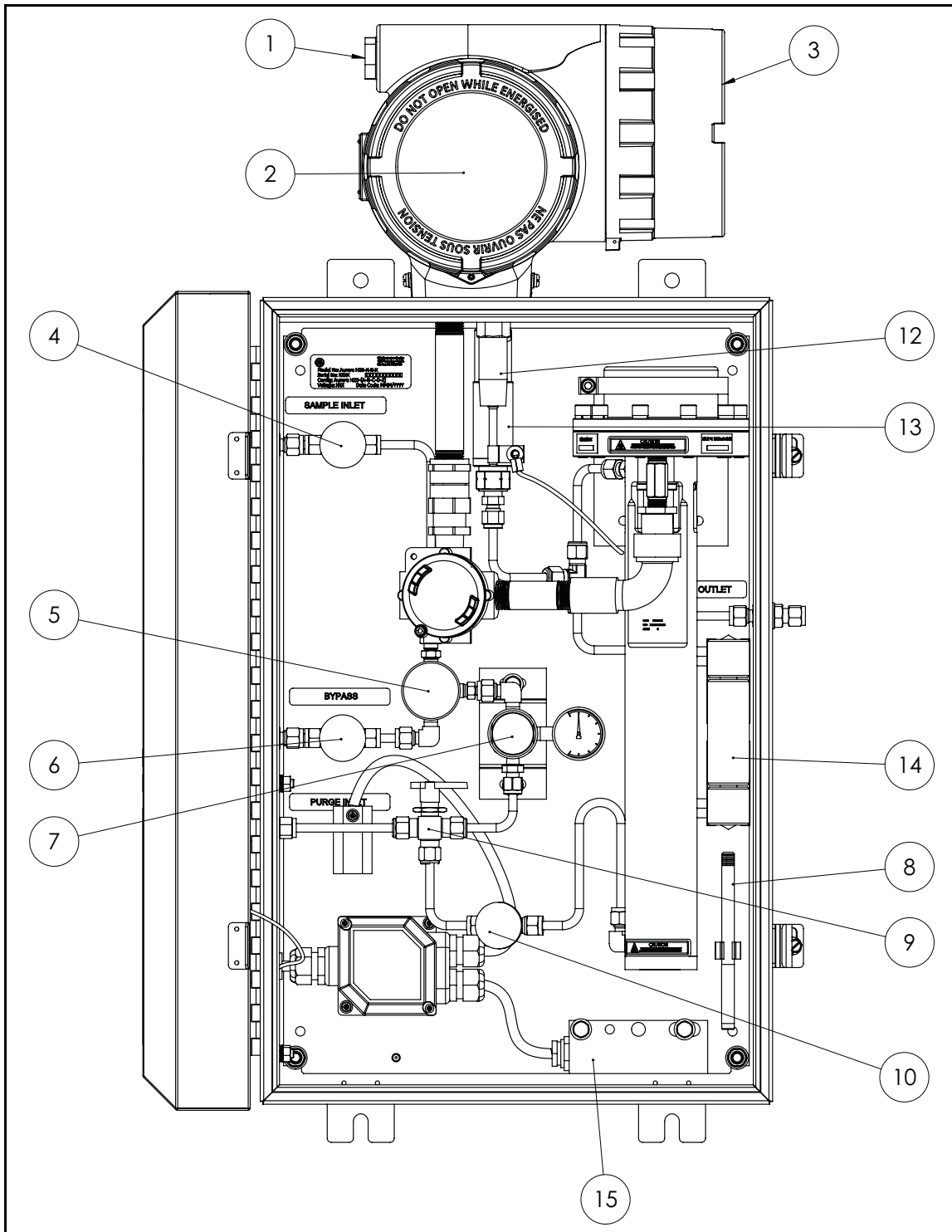

Figure 3: Aurora H2O System Assembly with Optional EU/ATEX Heater

### 1.3 System Components (cont.)

**Note:** Refer to Table 1 below and either Figure 2 on page 4 or Figure 3 on page 5 to identify your Aurora components.

**Table 1: Aurora H2O System Parts List**

No.	Description
1	Conduit I/O
2	Display and Magnetic Stylus Keypad
3	Wiring Terminals
4	Isolation Valve (needle valve)
5	Membrane Filter
6	Membrane Filter Drain & Fast Loop Vent
7	Pressure Regulator w/ 0-10 psig outlet pressure gauge
8	Magnetic Stylus
9	Process or Purge Gas Selector
10	Purge Gas Inlet Needle Valve
11	Absorption Cell
12	Temperature Sensor
13	Pressure Sensor
14	Rotameter
15	Optional Heater, thermostat, junction box



### 1.3 System Components (cont.)

**IMPORTANT:** *The filter installed within the Aurora is designed to function as a secondary filter. A primary filter or filter train should be used upstream of the analyzer. Do not sample directly from the process gas to the Aurora without the use of a primary filter and pressure reduction. The pressure inlet to the Aurora sample inlet should not exceed 500 psig.*

For natural gas, a pipeline insertion membrane filter is recommended as shown in *Figure 4* below. The installation of the insertion filter is described in this manual. The insertion filter also is equipped with a pressure regulator which functions to reduce the pressure. If it is not possible to install the insertion filter, consult GE application engineers for information about a sample conditioning system.

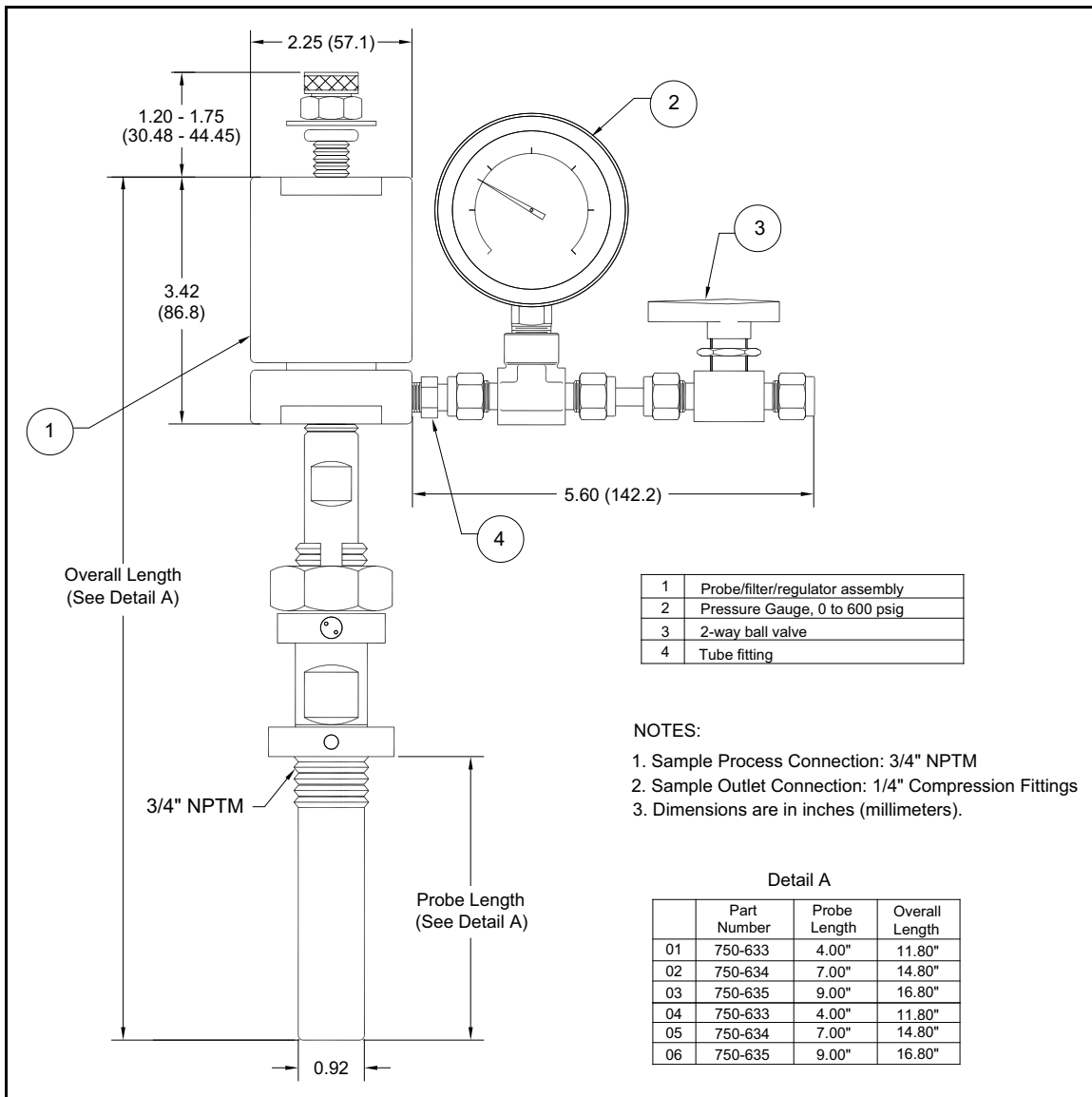

Figure 4: Sample System (ref. dwg #733-737)

### 1.3 System Components (cont.)

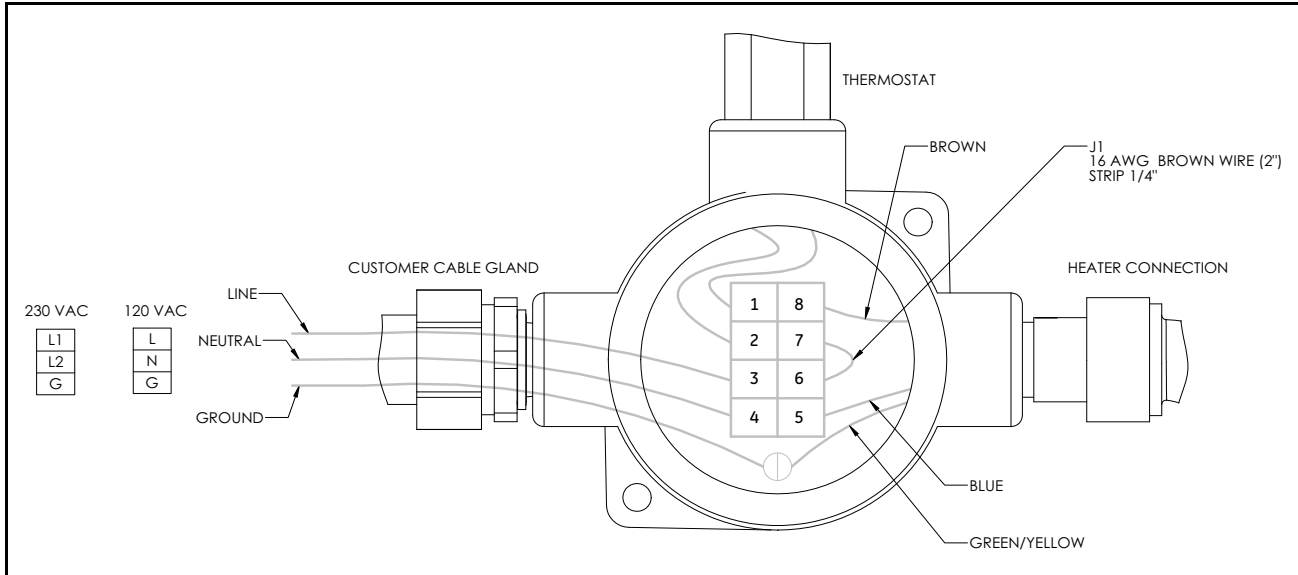

Figure 5: USA/CAN Heater Wiring Diagram

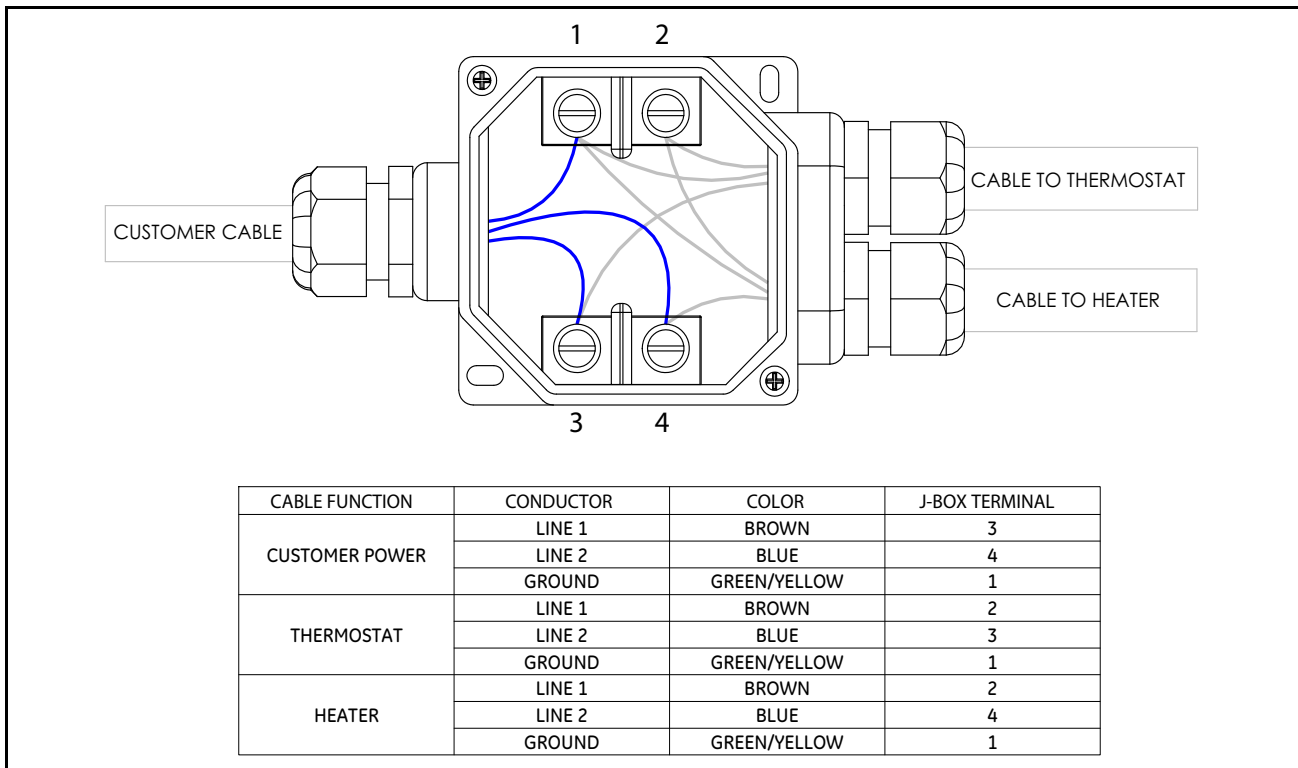

Figure 6: EU/ATEX Heater Wiring Diagram

## 1.4 Specifications

### 1.4.1 Power

**Analyzer:**

100-240 VAC, 50-60Hz, 10W

18-32 VDC (24 VDC nominal), 10W

**Optional Electrical Heater:**

120VAC, 120W

230VAC, 75W

### 1.4.2 Range

**Part Per Million by Volume**5 to 5000 ppm<sub>v</sub>**Dew/Frost Point\***

-65.5°C to -2.6°C (-85.9°F to 27.3°F)

**Process Dew/Frost Point\***

Process or equivalent dew point/frost point by calculation with process pressure signal (4-20 mA) or constant

**Absolute Humidity**3.8 to 3803 mg/m<sup>3</sup> (0.24 to 237 lbs/MMSCF)

\*Readings below 0°C (32°F) are in “frost point” temperature, and above 0°C (32°F) are in “dew point” temperature.

### 1.4.3 Accuracy

**Parts per Million by Volume**±2% of reading in ppm<sub>v</sub> or 4 ppm<sub>v</sub> (Accuracy of other parameters derived from ppm<sub>v</sub>)

### 1.4.4 Response Time

**Optical Response**

&lt;2 seconds

**System Response**

The system response is dependent upon the length of sample tubing, sample system components, flowrate and pressure, as well as the change in moisture concentration.

### 1.4.5 Operating Pressure

**Operating Sample Cell Pressure:**

69 to 172 kPa (10 to 25 psia)

**Maximum Pressure**

1380 kPa (200 psi)

**Process Pressure**

10,342 kPa (1500 psig) maximum [Higher pressure available using additional sampling system components]

## 1.4.6 Temperature

### Operating

-20° to +65°C (-4° to 149°F)

### Storage

-20° to +70°C (-4° to +158°C)

### Optional Heater/Thermostat Setpoint

20°±5°C (68°±9°F) for U.S. and Canada

10°±5°C (50°±9°F) for EU and elsewhere

## 1.4.7 Flow Rate

### Sample Cell Flowrate

10 to 60 SLH (0.4 to 2 SCFH); 30 SLH (1 SCFH) nominal

### Coalescer By-pass Fast Loop

5 to 10X of flowrate through sample cell

## 1.4.8 Display

Backlit LCD, three programmable simultaneous parameters, alphanumeric status and diagnostic display, LEDs for power, laser temperature stability, keypad lockout

## 1.4.9 Inputs/Outputs

### Analog Outputs

Three programmable 0/4-20 mA, 500 Ω maximum load

### Analog Input

Loop-powered 4-20 mA input for remote pressure transmitter (**Aurora H2O** supplies 24 VDC)

### Digital Interface

Two programmable digital communications ports

RS-232 and RS-485 with multi-drop capability and assignable address, Modbus RTU protocol

## 1.4.10 Enclosure

### Ingress Protection

IP-66

## 1.4.11 Laser Certification

Class 1 product, conforms to IEC 60825-1 Edition 2.0, Safety of Laser Products



**WARNING!** Use of controls or adjustments or the performance of procedures other than those specified herein may result in hazardous laser exposure.

### 1.4.12 User Interface

Programmable “through-the-glass” via magnetic stylus

### 1.4.13 Weight and Dimensions

#### Net Weight

45 kg (100 lb)

#### Overall Dimensions

34”H x 18”W x 14”D (87 cm x 46 cm x 36 cm) [see drawings]

### 1.4.14 Hazardous Area Certification

#### USA/Canada



Explosion-Proof for Class I, Division 1, Groups B, C&D

Dust-Ignitionproof for Class II/III, Division 1, Groups E, F&G (Canada only)

#### EU and Elsewhere



ATEX and IECEx: Ex d e IIB+H2 T6 Gb IP66; Tamb = -20°C to +65°C. Flameproof with increased safety compartment

Evaluated against standards EN 60079-0:2012, EN 60079-1:2007, EN 60079-7:2007, IEC 60079-0:2011, IEC 60079-1:2007, IEC 60079-7:2006.

### 1.4.15 European Certification

#### CE

Complies with EMC Directive 2004/108/EC, Low Voltage Directive 2006/95/EC and Pressure Directive 97/23/EC for DN<25

### 1.4.16 Software

Displays all key parameters. Provides time-base graphing, data logging ability, export data as ASCII text. Software has lockout/passcode.

### 1.4.17 Sampling System

Integrated sampling system to filter out physical contaminants, remove glycol carry over, control temperature condition, regulate pressure and flow rate. Optional thermostatically controlled heater.

### 1.4.18 Wetted Components

316/316L stainless steel for tubing and fittings. Other wetted components such as the optical window and mirror are proprietary materials and are compatible with natural gas and typical contaminants found in natural gas. Other sample system components wetted parts include PTFE, PFA, Inconel, Hastelloy, PVDF, glass, Viton.

[no content intended for this page]

## Chapter 2. Installation

### 2.1 Introduction

The **Aurora H2O** analyzer provides direct indication of moisture concentration in natural gas. Temperature and pressure sensors are used to provide high precision enhancement. It may be installed in a wide variety of environmental conditions, and meets the requirements for operation in hazardous areas.

Be sure that the ambient temperature is at least 10°C higher than the maximum dew/frost point temperature you expect to measure. This will ensure that you will not have liquid condensation in the sample transport line or the **Aurora H2O** sampling system components. Heat tracing the sample line will aid in elevating the sample temperature above the dew point. An optional heater installed within the enclosure is also available.

### 2.2 Bill of Materials

The following items should have been received with your shipment:

- **Aurora H2O** Unit
- **Aurora H2O** User's Manual on CD ROM
- **AuroraView** Software on CD ROM
- **Aurora H2O** Calibration Data Sheet
- Maintenance/Accessories Kit
- Optional: Pipeline Insertion Filter/Regulator Assembly

### 2.3 Unpacking

The **Aurora H2O** is shipped in a packing box with a plywood base (see *Figure 7* below), and the **Aurora H2O** analyzer is secured to the plywood base with mounting bolts. Transport the shipping package with the plywood base on the bottom, and according to the warning labels on the exterior packaging. Open the packing box from the top, and remove the foam packing material. Collect any separate components such as the **AuroraView** CD, the User Manual CD, and other items contained in the shipment.



Figure 7: Unpacking the Aurora H2O

## 2.3 Unpacking (cont.)

Remove the mounting studs at the bottom of the enclosure. Using two people, lift the **Aurora H2O** from the bottom of the enclosure and from the top of the enclosure where the analyzer electronics is located. A typical **Aurora H2O** weighs approximately 100 pounds (45 kg). Use a proper lifting technique to avoid injury.

Check all the received components and record the model numbers and serial numbers for your records. If anything is missing, contact GE immediately.

## 2.4 Choosing A Site for Installation

You should have discussed environmental and installation factors with a GE Sales, Application or Service Engineer by the time you receive the analyzer.

Before installing the analyzer, read the guidelines below on installation recommendations:

1. Choose an installation site for the **Aurora H2O** analyzer as close to the actual sample point (sample take-off point) as possible, to minimize transport time to the analyzer.
2. Avoid unnecessarily long lengths of sample transport tubing to minimize transport time to the analyzer.
3. Avoid dead-legs in the sample transport tubing to minimize the possibility of liquid build-up.
4. Use stainless steel tubing. Avoid using copper tubing, as the water molecule has greater absorption capabilities for copper compared to stainless steel. Avoid rubber tubing at all costs, as water molecules interact with the rubber, and ambient moisture can permeate through the tube wall into the sample gas.
5. Mount the **Aurora H2O** analyzer at grade, or at a location that is easily accessible for maintenance (on a platform or other structure).
6. Be sure that the ambient temperature is at least 10°C higher than the maximum dew/frost point temperature you expect to measure. This will ensure that you will not have liquid condensation in the sample transport line nor in the **Aurora H2O**. Heat tracing the sample line will aid in elevating the sample temperature above the dew point. An optional heater installed within the enclosure is also available.

A typical **Aurora H2O** system for monitoring moisture off a natural gas pipeline is shown in *Figure 8 on page 15*.



2.4 Choosing A Site for Installation (cont.)

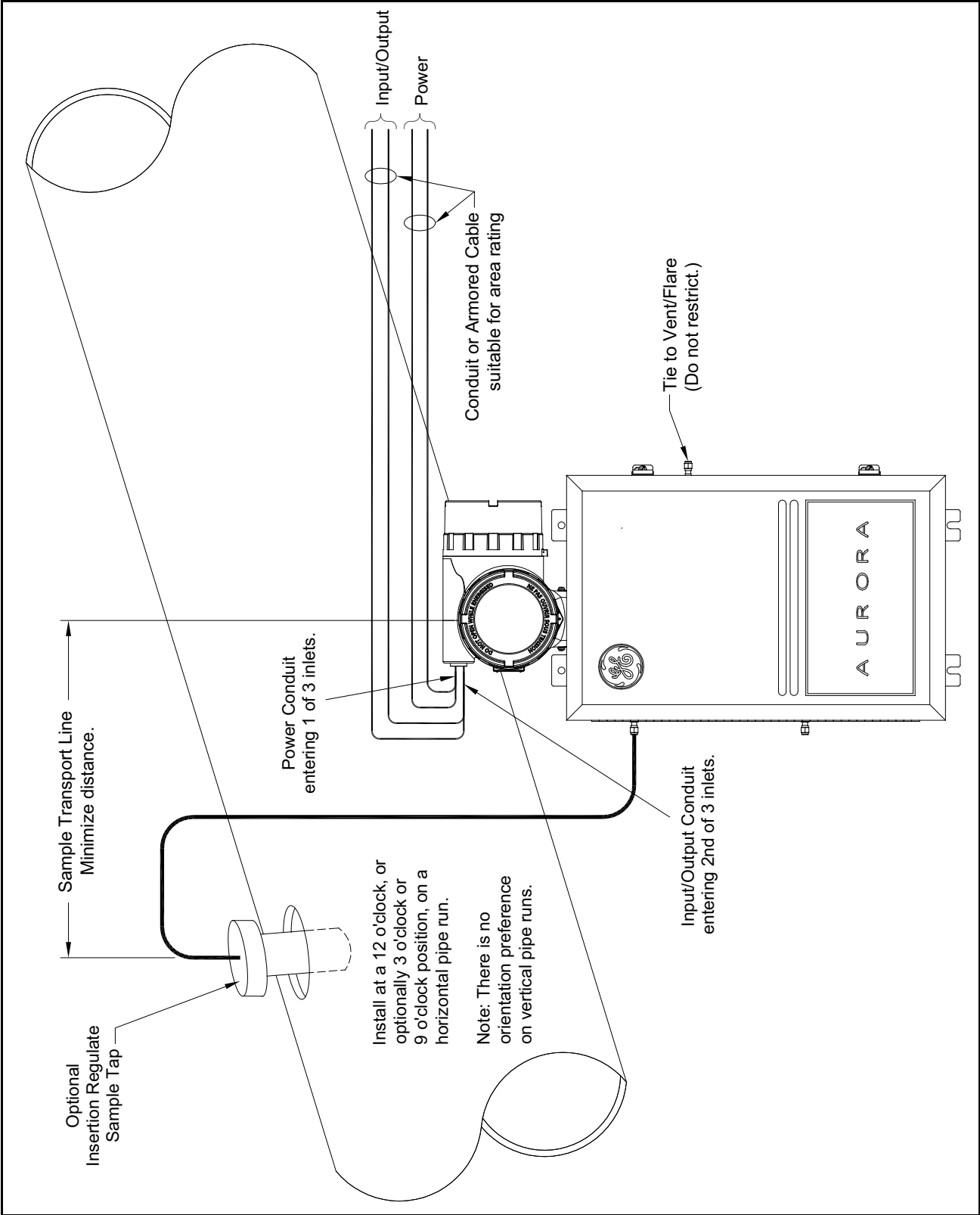

Figure 8: Aurora H<sub>2</sub>O Analyzer Monitoring Moisture Off a Natural Gas Pipeline

## 2.5 Low Voltage Directive

To comply with the Low Voltage Directive, you must install a switch or circuit breaker on the input power line. For greatest safety, locate the circuit breaker or power switch near the electronics console.

**IMPORTANT:** *Installation must be done in accordance with the National Electrical Code, the Canadian Electric Code, and/or any other applicable local codes.*

## 2.6 Mounting

Use the four mounting tabs to mount the **Aurora H2O** System Assembly in the desired location (see *Figure 31* on page 31).

**IMPORTANT:** *The Aurora H2O should only be mounted vertically.*

## 2.7 Optional Insertion Probe/Regulator

### 2.7.1 Description

For natural gas applications that may have entrained particulate and liquid contaminants (especially TEG carry-over from TEG dryers), GE recommends the use of a *Insertion Probe/Regulator* (see *Figure 9* below) to serve as the first part of particulate and condensate filtration where the gas is sampled off the pipe. The device combines the features of a sample tap, a membrane filter and an integral pressure regulator (0-500psig outlet), adjustable at the sample take-off point. The sample tap housing includes a foot-valve so that, once installed, the assembly can be removed from a line under pressure for membrane filter replacement as needed.

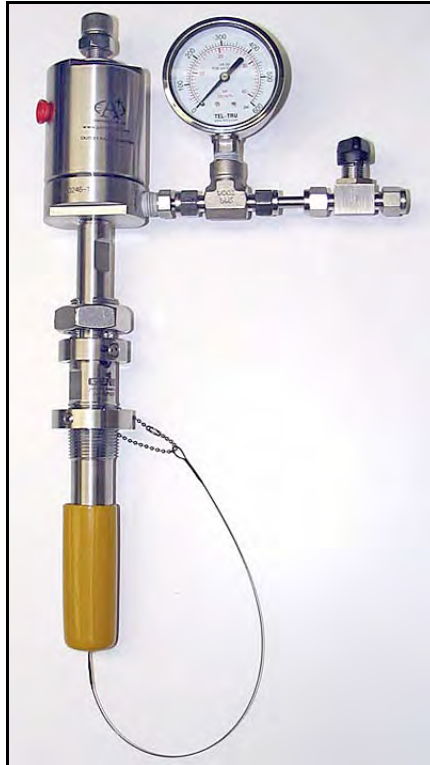

Figure 9: Insertion Probe/Regulator

**Note:** A 29/32" (0.907 inch, 23.1 mm) minimum bore-through clearance is needed on the customer nozzle for insertion of a 3/4" NPT insertion membrane liquid separator/pressure regulator.

### 2.7.2 Installation

Note that the *Optional Insertion Probe/Regulator* can be installed only on unpressurized lines. There is no hot-tap installation for this device.

This procedure is broken down into two steps:

- Installing the Housing
- Installing the Insertion Probe/Regulator Assembly

### 2.7.2a Installing the Housing

The housing, as shown in *Figure 10* below, is supplied with a *Locking Mechanism* to ensure that housing can only be removed intentionally.

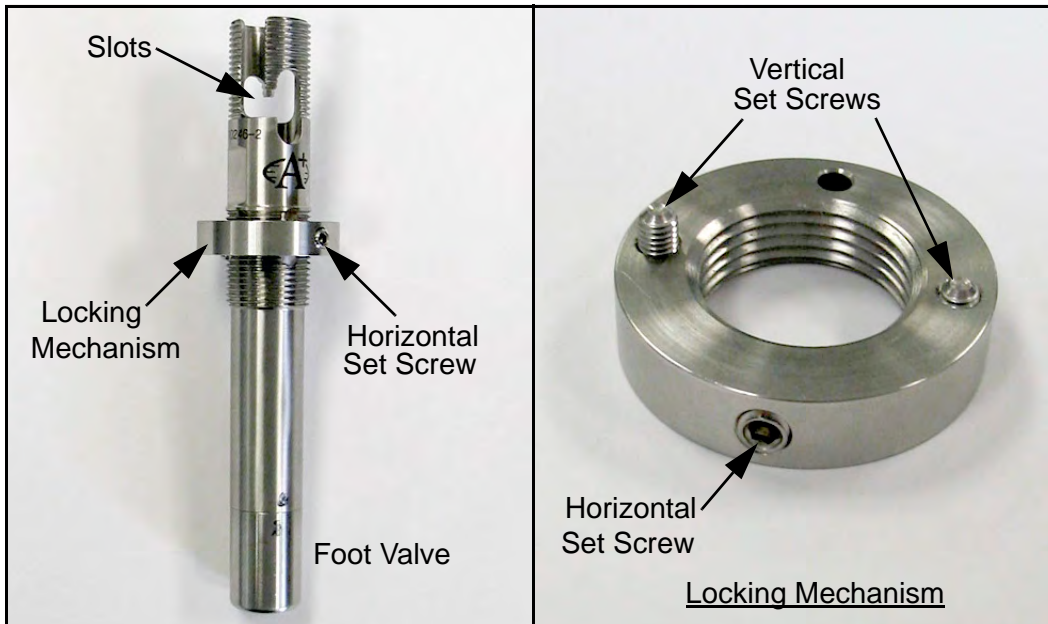

**Figure 10: Installing the Housing and Locking Mechanism**

1. Turn the locking mechanism counter-clockwise until it is at its extreme upper position. Apply thread sealant to the threaded area below vertical slots in the threads (see *Figure 11* below). Do not allow the thread sealant to enter the slot, as it may interfere with the mechanism.

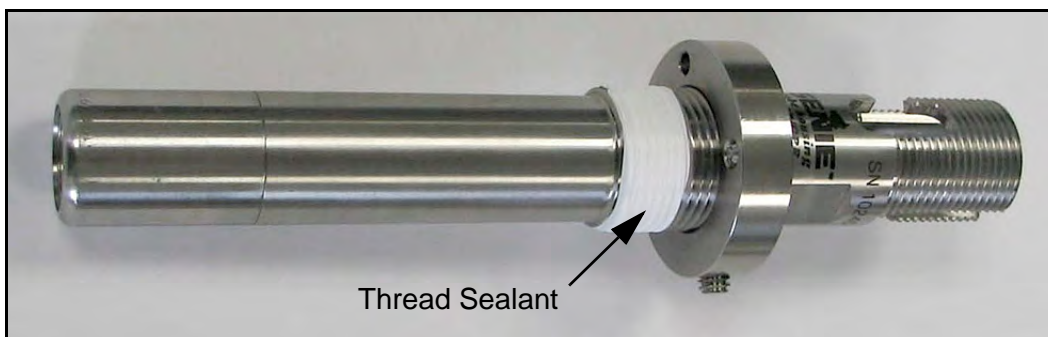

**Figure 11: Applying Thread Sealant**

### 2.7.2a Installing the Housing (cont.)

2. Confirm that the pipeline has been unpressurized. Refer to *Figure 12* below and insert the housing into the pipeline through a  $\frac{3}{4}$ " NPTF thread-o-let (The minimum ID of the thread-o-let is 0.91").

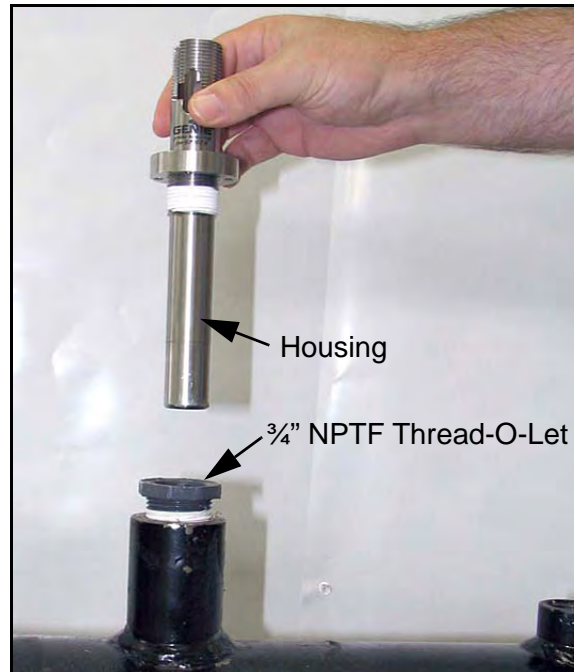

Figure 12: Inserting Housing into Pipeline

3. Using a wrench on the wrench flats, turn the housing until it is secure and sealed (see *Figure 13* below). This will require between three and five turns. **DO NOT OVERTIGHTEN!** The housing may be damaged if it is over-tightened, causing the housing to deform.

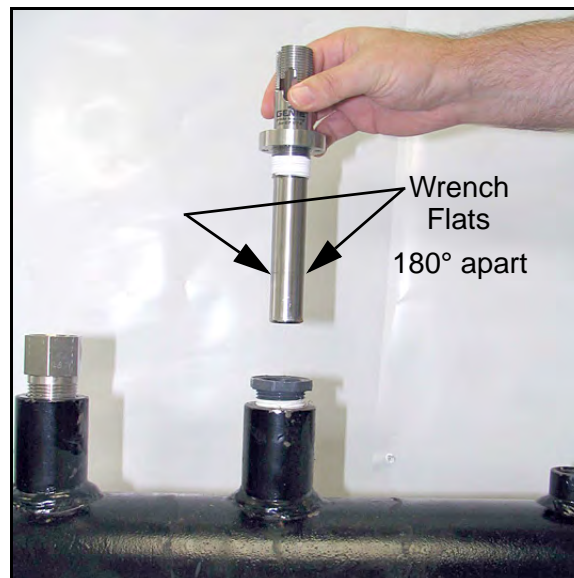

Figure 13: Tightening the Housing

### 2.7.2a Installing the Housing (cont.)

4. Turn the locking mechanism clockwise until it first touches the top of the thread-o-let.
5. Turn the locking mechanism counterclockwise until the Allen screw is aligned with the thread slot (see *Figure 14* below). Using a 1/8" Allen wrench, tighten the Allen screw until its tip is tight against the slot. **DO NOT OVERTIGHTEN THE ALLEN SCREW** as this will cause the housing wall to be indented.



Figure 14: Aligning and Tightening the Allen Screw

6. Using a 3/32" Allen wrench, tighten the Allen screws on the locking mechanism's surface until their tips are firmly set into the thread-o-let's upper surface (see *Figure 15* below).



Figure 15: Tightening the Allen Screws

The housing is now installed. The locking mechanism should prevent the housing from becoming unintentionally unscrewed from the thread-o-let. The pipeline may now be pressurized.

### 2.7.2b Installing the Insertion Membrane Liquid Separator/Pressure Regulator Assembly

1. Confirm that the Allen cap screw head's hex cavity is clean and free from foreign material. Confirm that the Allen cap screw that holds the membrane ferrule is torque-wrench tight (see *Figure 16* below). The torque value should be 10 inch-lbs. If the Allen cap screw is only hand-tight, the screw may protrude excessively, which could result in foot valve actuation when the probe is installed into the housing.

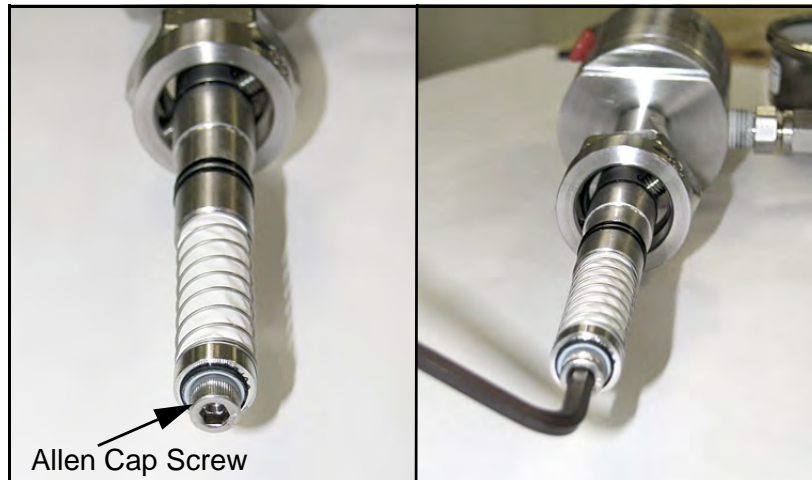

Figure 16: Checking/Tightening the Allen Cap Screw

2. Rotate the pressure adjustment screw on the pressure regulator fully counterclockwise until it rotates freely. Close the isolation ball valve (see *Figure 17* below).

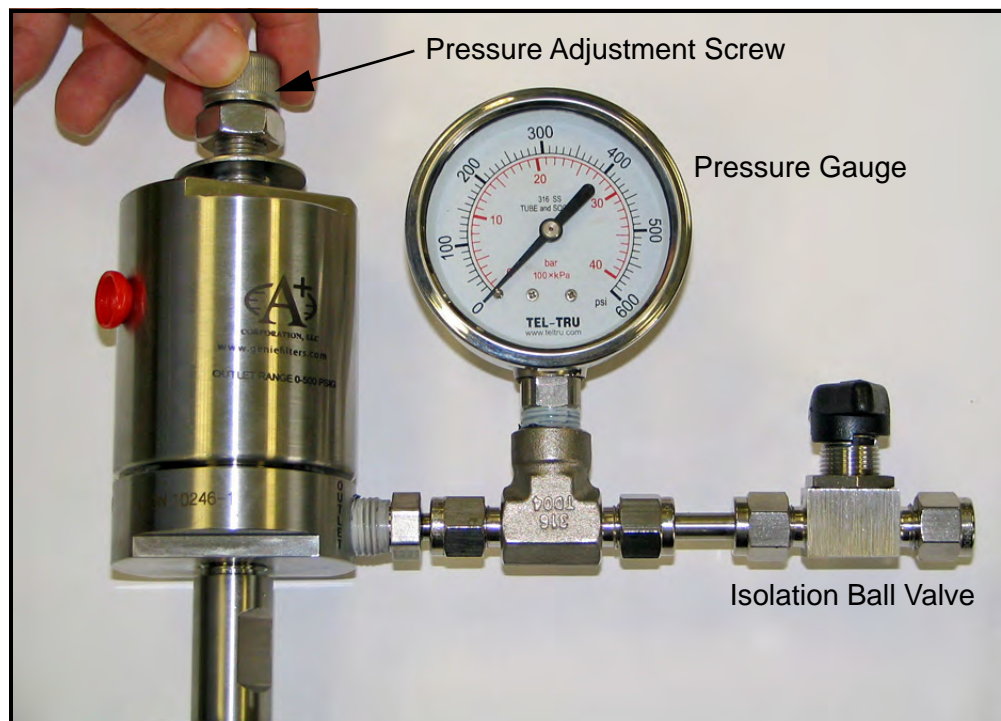

Figure 17: Rotating the Pressure Adjustment Screw

## 2.7.2b Installing the Insertion Membrane Liquid Separator/Pressure Regulator Assembly (cont.)

- Refer to *Figure 18* below and position the membrane end of the probe above the installed housing. Slowly lower the probe into the housing. Avoid membrane contact with the upper section of the housing. **DO NOT APPLY DOWNWARD FORCE.** The probe should slide easily into the housing. Lower the probe only enough to thread the insertion nut one complete turn of thread engagement.

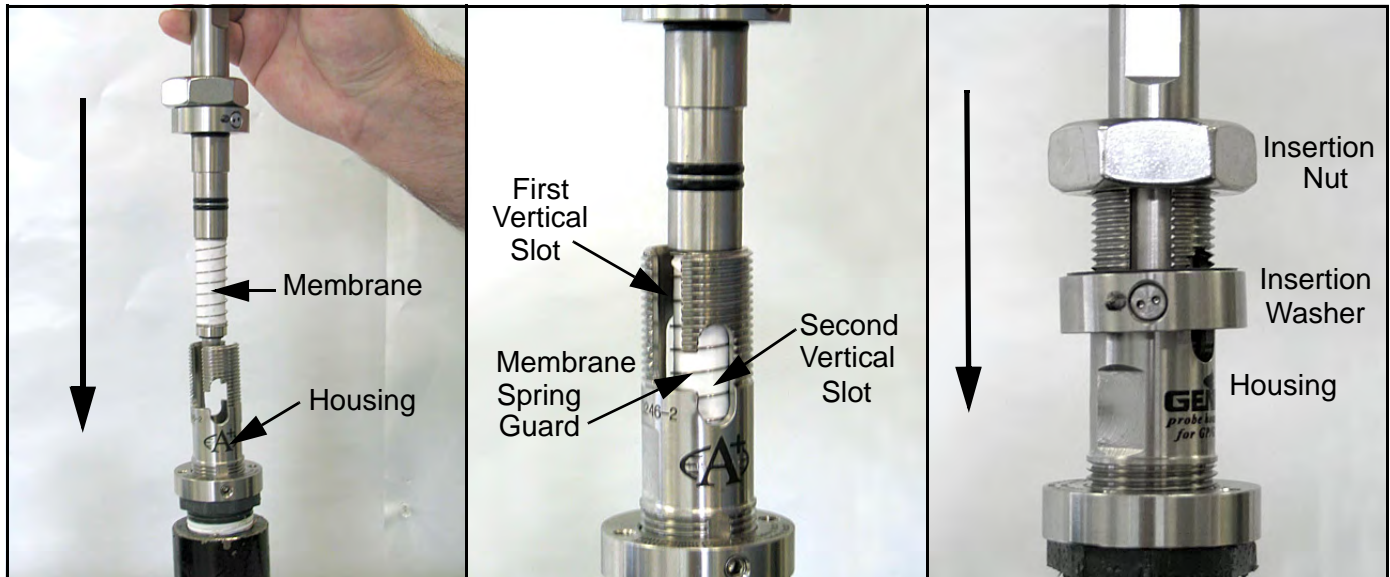

Figure 18: Installing the Probe

- Thread the insertion nut down by hand, lowering the probe until the insertion washer pins slide to the bottom of the first vertical slot (see *Figure 19* below).

**Note:** *The threaded nut on the housing ensures that if all other safety procedures are disregarded, it is mechanically impossible to remove the probe.*

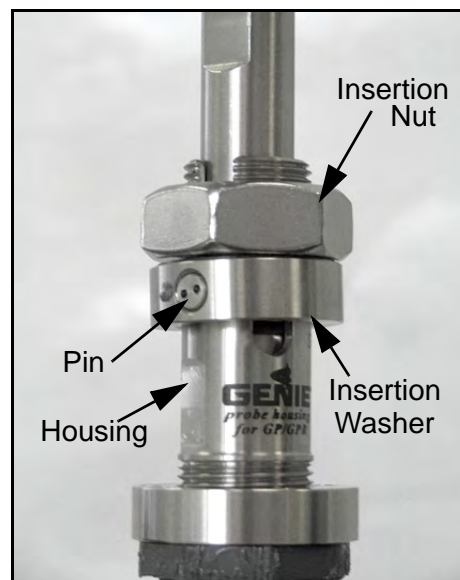

Figure 19: Threading the Insertion Nut



### 2.7.2b Installing the Insertion Membrane Liquid Separator/Pressure Regulator Assembly (cont.)

5. Rotate the probe counterclockwise until the pins are to the far right in the horizontal slot. At this point, the probe is sealed against the housing interior wall. The pins will be in the middle of the second vertical slot (see *Figure 20* below).



Figure 20: Rotating the Probe

6. Loosen the insertion nut until it is above the top of the second vertical slot (see *Figure 21* below). The probe should not rise to the top of the second vertical slot. If the probe rises in the slot, the foot valve o-ring may have been damaged or attacked by the process.

**Note:** *The threaded nut on the housing ensures that if all other safety procedures are disregarded, it is mechanically impossible to remove the probe. Perform the next step regardless of the status of the foot valve o-ring.*



Figure 21: Loosening the Insertion Nut

2.7.2b *Installing the Insertion Membrane Liquid Separator/Pressure Regulator Assembly (cont.)*

7. Tighten the insertion nut by hand until it is against the insertion washer again. Using a wrench, tighten the insertion nut against the insertion washer so that the pins are at the bottom the second vertical slot (see *Figure 22* below). At this point the foot valve opens and the insertion process is complete.



**Figure 22: Tightening the Insertion Nut**

### 2.7.3 Setting the Pressure

**Note:** Perform these steps only after the entire system has been plumbed, including the Aurora H2O.

1. Ensure the inlet sample gas isolation valve on the **Aurora H2O** sample system is closed. Open the isolation ball valve at the *Optional Pipeline Insertion Membrane Liquid Separator/Pressure Regulator*.
2. Turn the pressure adjustment screw clockwise to increase the pressure (see *Figure 23* below). The optional pipeline insertion membrane liquid separator/pressure regulator is the **FIRST STAGE** pressure reduction of the system when used. Depending upon your source pressure, you should step down the pressure to a value in the range listed in *Table 2* below.
3. Tighten the lock nut down to the top of the pressure regulator to avoid future possible changes in pressure regulator setting, once the pressure is set.

**Table 2: Pressure Settings**

Source Pressure	Outlet Pressure Setting
750 psig < source < 1500 psig	400-500 psig
500 psig < source < 750 psig	300 psig
< 500 psig	50% of the average source pressure

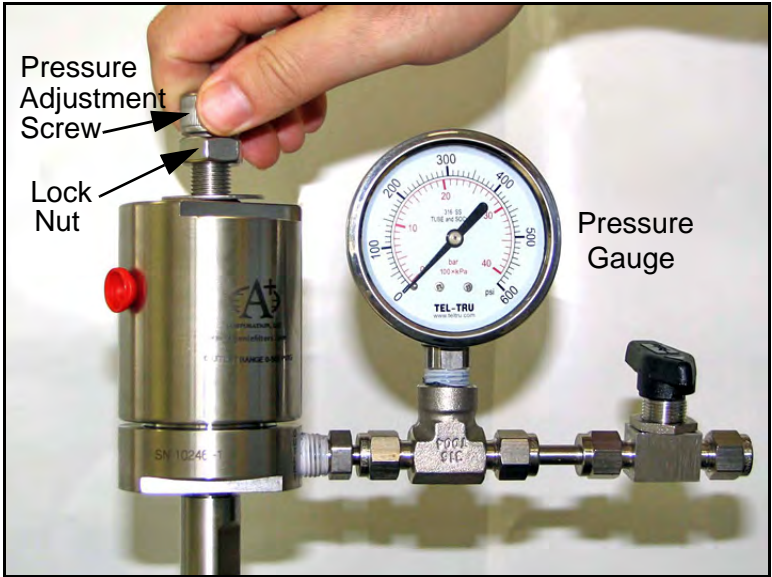

**Figure 23: Turning the Pressure Adjustment Screw**

## 2.8 Making Electrical Connections

Refer to *Figure 32 on page 32* for wiring connections.

1. **Aurora H2O** has three  $\frac{3}{4}$ " NPT conduit inlet ports for power and I/O (see *Figure 24* below). These will normally be shipped plugged from the factory. Follow the applicable wiring code and requirements for wiring the unit.

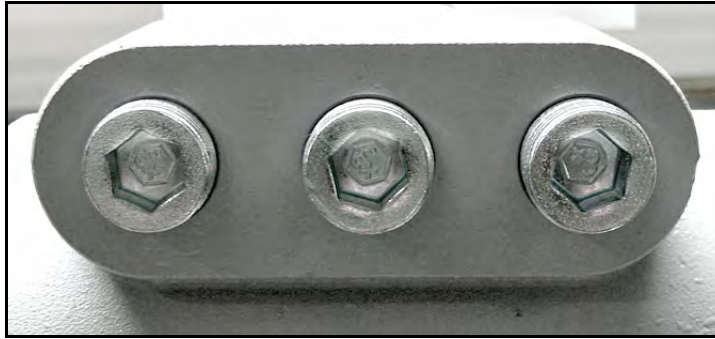

Figure 24: Conduit Inlet Ports

**Note:** Use one conduit inlet for power. Use the two other conduit inlets for input/output as needed. All unused conduit inlet ports should be sealed with suitable blanking elements.

2. Select one conduit for inlet power to the **Aurora H2O** based on your configuration. The **Aurora H2O** comes with a universal power supply, or optionally, as a 24VDC powered unit. Remove the wiring cover to view the wiring terminal block (see *Figure 25* below).

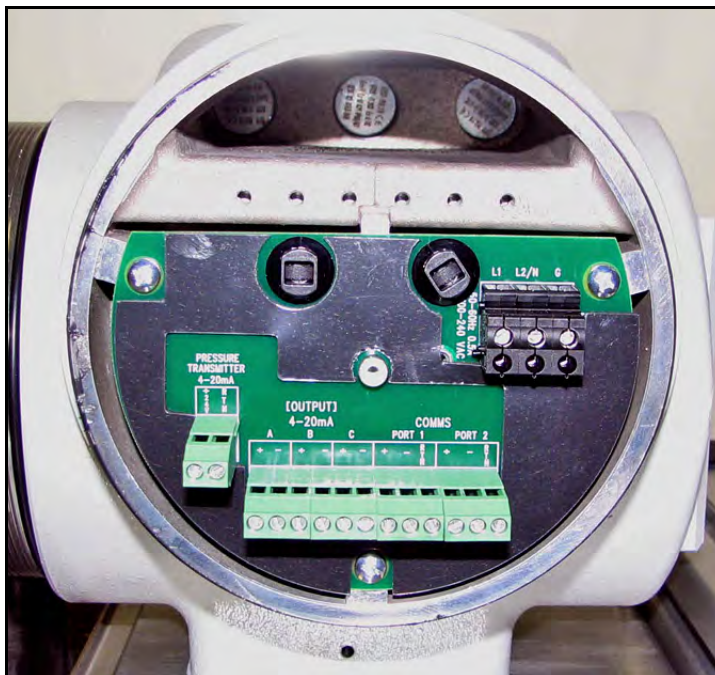
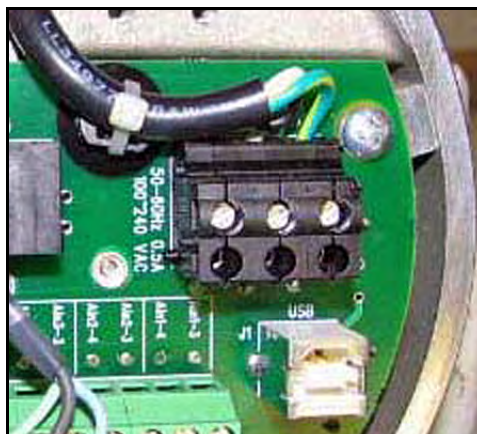

Figure 25: Wiring Terminal Blocks

## 2.8 Making Electrical Connections (cont.)

**Note:** *Supply connection wiring shall be rated at least 10°C above the rate maximum service temperature of 85°C, be stripped back 5/16 in. (8 mm) and torqued to a minimum of 4.4 in. lb. (0.5 Nm).*

3. Run the AC power connections to the Power Terminal Block shown in *Figure 26* below. It is recommended to use 12-18 AWG (3.3 - 0.82 mm<sup>2</sup>) power wiring.



**Figure 26: Power Terminal Block**

4. Use wiring conduit runs, separate from the **Aurora H2O** main power, for all I/O (Input/Output) leads. Wire up to three 4-20mA outputs to the terminals labeled A, B, and C. The three analog outputs A, B and C (0-20mA or 4-20mA) are internally powered by the **Aurora H2O**. Use shielded 18-22 AWG (0.82–0.33 mm<sup>2</sup>) twisted pair wire, and ground the shield at one end only. Wire up digital communications to Port 1 and/or Port 2 as labeled.
5. Either digital port may be configured for RS-232 or RS-485. Port 1 is designated as “SCADA.” Port 2 is designated as “SERVICE.” For operation on RS-485, 2-wire, half-duplex bus, attach the RS-485(+) to (+), and the RS-485(–) to (–). Per Modbus-IDA specifications, a third, common conductor must also interconnect all the devices of the bus. Attach the common conductor to RTN.

**Note:** *For an RS-485 Multi-drop Network, a terminating resistor must be installed across the **Aurora H2O** RS-485 terminals, or an internal terminating resistor can be applied. See below.*

- When using the **Aurora H2O** in RS-485 mode, and to prevent signal reflections on the high-speed RS-485 connections, it is recommended that the far end of the RS-485 lines be terminated properly. The termination can be accomplished in one of two ways:
  - Connect 120 Ω, 1/4 W leaded resistors across the + and – terminals of ports 1 and 2 (both ports or whichever one will be in use)
  - Using long-nose pliers, move jumpers J15 and J16 from pins 2 and 3 (default setting from factory) to pins 1 and 2 (see *Figure 27* on page 28). J16 is the termination for port 1 and J15 is the termination for port 2. It is also recommended that basic ESD precautions such as grounded wrist straps be used for this procedure.

## 2.8 Making Electrical Connections (cont.)

### Multi-drop RS-485:

For multiple **Aurora H2O** units connected in daisy-chain fashion to the RS485 interface, it is important that the farthest unit away from the transmitting device be the only unit incorporating any termination (see *Figure 27* below). All other units must have jumpers J15 and J16 in positions 2 & 3 (default setting from the factory). For more details on RS-485 wiring or operation, refer to TIA/EIA-485-A Specification.

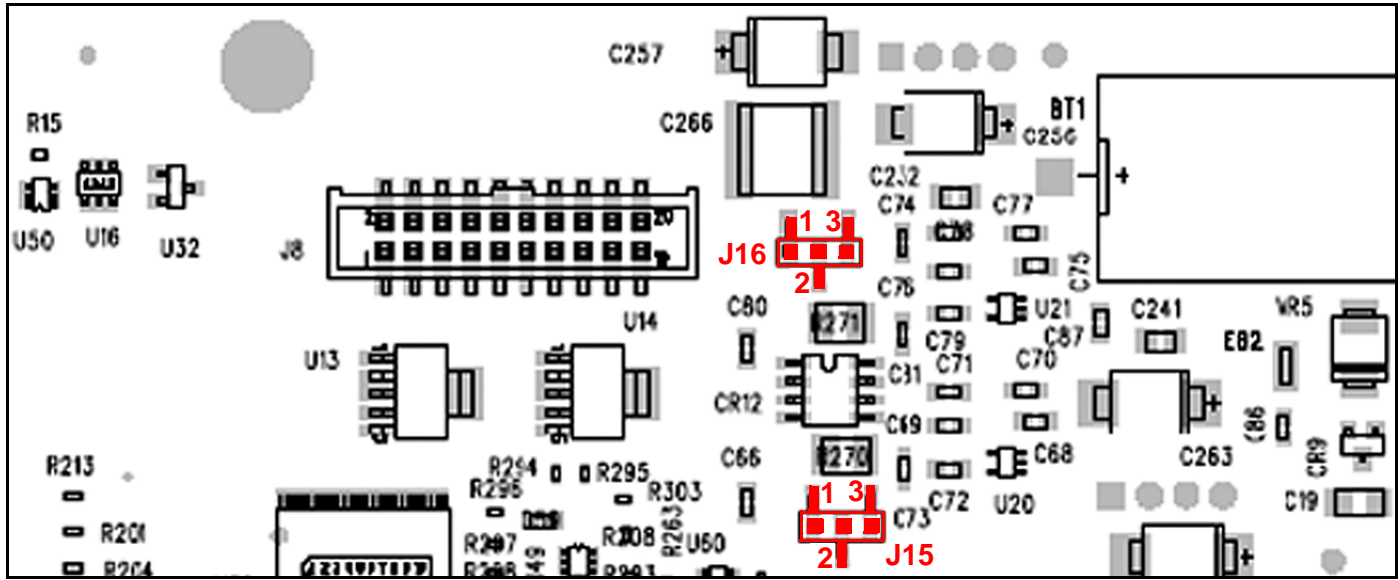

Figure 27: RS-485 Mode Termination - Install Jumpers at J15 and J16, Pins 1 and 2

**Note:** The internal terminations **MUST** be in the default (unterminated) position for operation in RS-232 mode.

- For operation on RS-232, connect RS-232(TXD) to (+), RS-232(RXD) to (-), and RS-232(GND) to RTN (see *Figure 28* below).

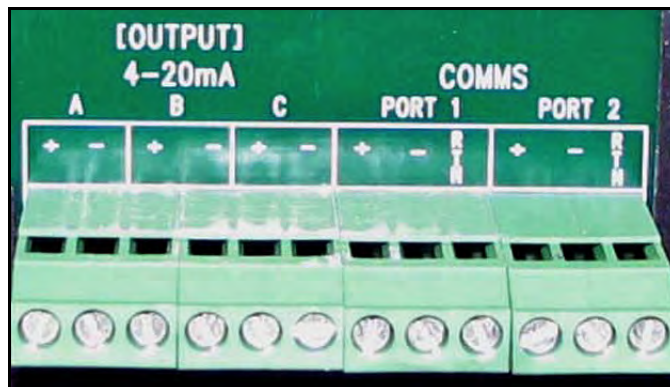

Figure 28: Input/Output Connections

## 2.8 Making Electrical Connections (cont.)

6. For connection to a PC to interface with **AuroraView** software, you may use the supplied 704-688 cable (RS-232 w/ SUB-D-9 connector to tinned leads). Wire the cable as follows:

Color Code		Aurora H2O Terminal
White	Tx	+
Red	Rx	-
Green	Ground	RTN

The as-shipped default configuration is as follows:

<b>BAUD Rate:</b>	115,200
<b>Parity:</b>	Even
<b>Network ID:</b>	1 for Port 1, 2 for Port 2

7. Use a separate wiring conduit run for any 4-20mA pressure transmitter input. This input is used when a live input pressure reading for the main process pressure is desired, to determine an equivalent dew point by the **Aurora H2O** analyzer. Wire the 4-20mA pressure transmitter to the Pressure Transmitter terminal block (see *Figure 29* below). The **Aurora H2O** supplies 24VDC for use with a loop-powered, 2-wire pressure transmitter.



Figure 29: Pressure Transmitter Connections

**IMPORTANT:** *Use of an external pressure transmitter is not covered by the **Aurora H2O** hazardous area certifications. The external pressure transmitter should be suitably rated for the area classification. Its associated wiring should be done in accordance with local codes and regulations, and suitably rated for the area classification.*

8. If the **Aurora H2O** has been supplied with an optional electrical heater, there are two possible configurations: USA/CAN or EU. Connect the AC power using a separate conduit from the power for the **Aurora H2O** analyzer. The heater is equipped with a thermostat preset to 25°C (77°F) nominal. Use 12-18 AWG (3.3 - 0.82 mm<sup>2</sup>) wires. The heater terminals are located within a junction box (item 15 in *Figure 2* on page 4 or *Figure 3* on page 5).

## 2.8 Making Electrical Connections (cont.)

9. Lastly, the **Aurora H2O** analyzer requires a connection to ground from the electronics explosion-proof/flame-proof enclosure. As shown in *Figure 30* below, there are two external ground connections available for the user (on the left and right hand sides of the enclosure). Wire this connection to earth ground, local to the **Aurora H2O** analyzer installation site.



Figure 30: Earth Ground Connection

## 2.9 Specific Conditions of Use

Before operating your Aurora system, be sure the following conditions are met:

1. In the event of repair or replacement of any components, the manufacturer, GE Infrastructure Sensing, shall be contacted for information on the controlled materials and dimensions of the flameproof characteristics of the Aurora H2O Moisture Analyzer.
2. The laser head assembly of the Aurora H2O Moisture Analyzer shall be inside a tool secured enclosure with IP20 or better to ensure the factory installed laser head assembly bolts are inaccessible from the outside.
3. Consult the manufacturer for genuine replacement flange fasteners. 5/16 inch-24 x 1-1/4 inch 18-8 stainless steel socket head cap bolts or better with a minimum tensile strength of 70,000 psi are acceptable alternatives.
4. To reduce the potential of an electrostatic charging hazard, do not rub painted aluminum parts with a dry cloth.



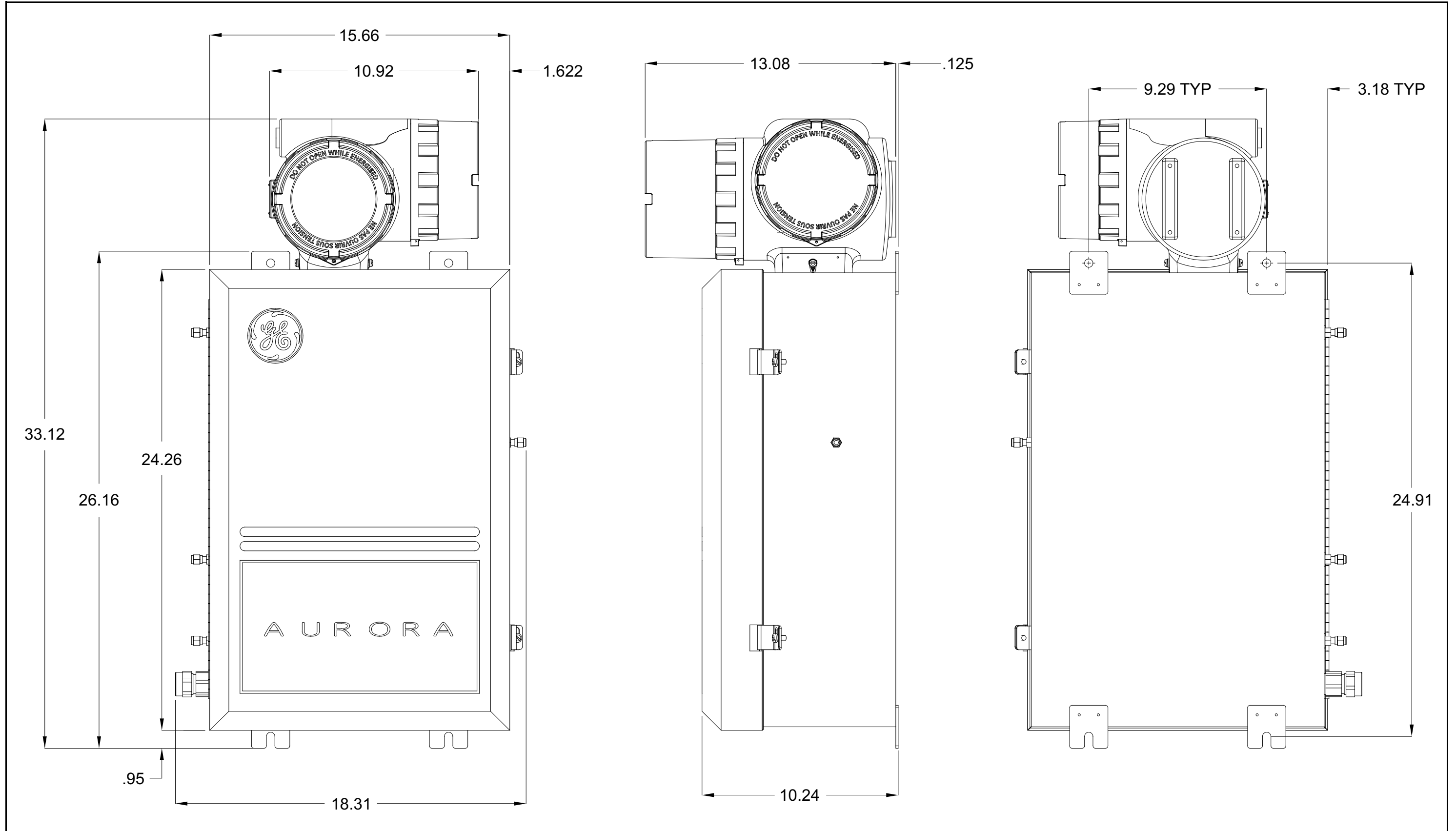
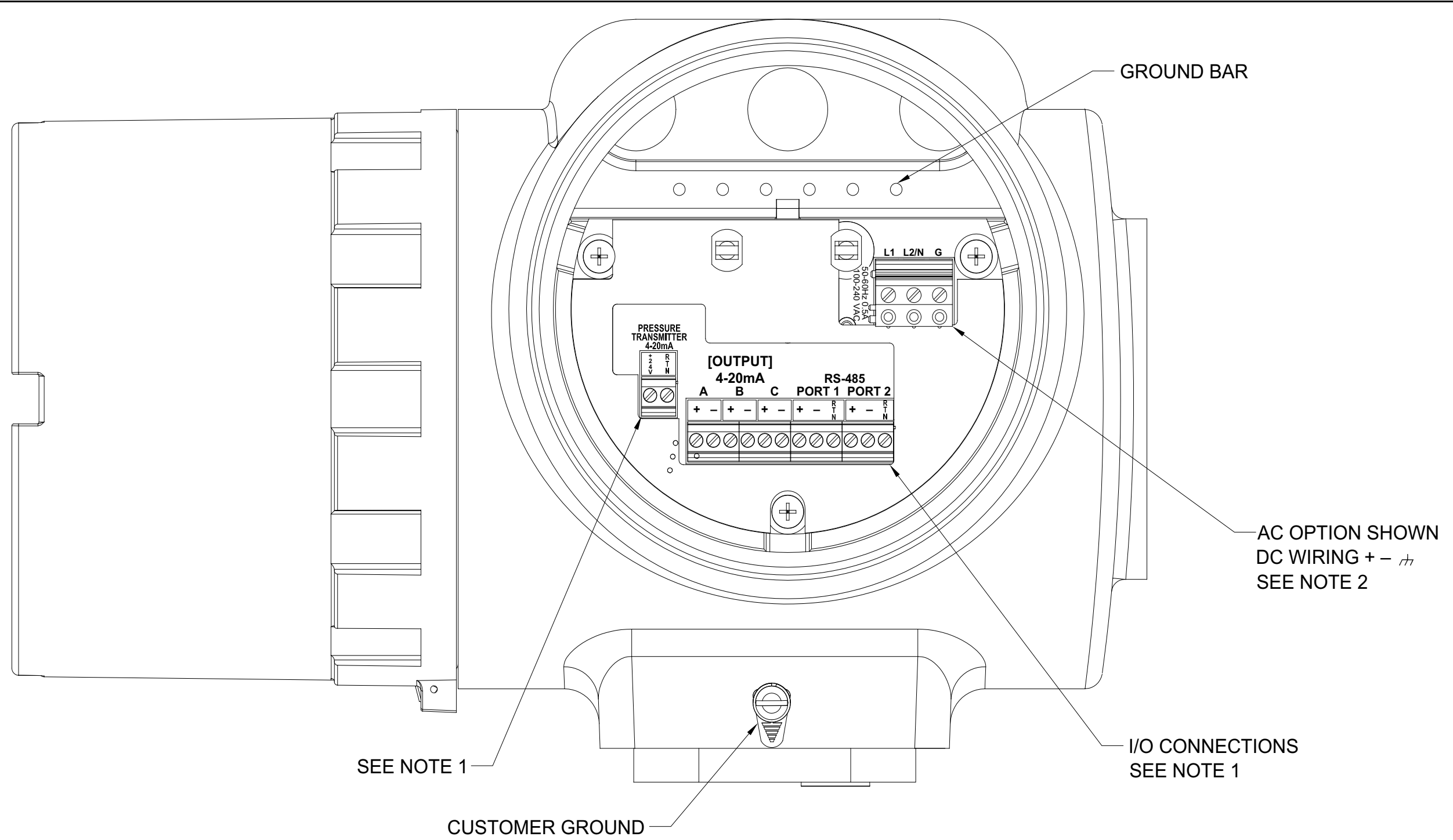

Figure 31: Aurora H2O Outline and Mounting (ref. dwg #712-1456)



AC OPTION SHOWN  
DC WIRING + - ⏏  
SEE NOTE 2

SEE NOTE 1

I/O CONNECTIONS  
SEE NOTE 1

CUSTOMER GROUND

NOTES:

1. I/O CONNECTIONS AND PRESSURE TRANSMITTER WIRE GAUGE RANGE 12-24 AWG.
2. AC AND DC CONNECTION WIRE GAUGE RANGE 12-18 AWG.

Figure 32: Aurora H2O Electronic Assembly Wiring Diagram (ref. dwg #702-8976)

## Chapter 3. Operation and General Programming

### 3.1 Using the Aurora H2O

Follow the information in this chapter to operate the **Aurora H2O** system.

CLASS 1 LASER PRODUCT



**WARNING!** Use of controls or adjustments or performance of procedures other than those specified herein may result in hazardous laser exposure.

### 3.2 Sample System

See the instructions below and *Figure 33 on page 35* to operate the **Aurora H2O** sample system.

#### 3.2.1 Aurora H2O Startup

1. Supply gas inlet pressure should be <400 psig (2760 kPa).
2. Confirm that there are no flow restrictions downstream of the analyzer sample outlet.
  - a. Maximum outlet back pressure: 10 psig
3. Start with all valves in fully closed position and the pressure regulator turned fully counter-clockwise.
4. Turn the sample gas selector valve [1] with the handle indicator pointing fully to the right.
5. Open the bypass gas metering valve [2] 1/4 turn.
6. Fully open the sample gas metering valve [3].
7. Slowly open the supply gas isolation valve [4] 1/4 turn.
8. Slowly turn the supply gas pressure regulator [6] clockwise until the sample gas flow meter [7] indicates mid-scale.
  - a. If the pressure is increased to rapidly, it will activate the liquid-block feature of the membrane filter [8] shutting off gas flow.
  - b. If this occurs, fully close the Supply gas isolation valve [4].
  - c. Wait 30 seconds, and then go back to Step 7. (A pop sound can be heard when the liquid-block re-opens to allow gas flow)
9. Slowly adjust the bypass gas needle valve [2] until the desired flow rate is reached (requires optional flow meter for precise metering).
10. Fully open the Supply gas isolation needle valve [4].

### 3.2.2 Aurora H2O Shut Down

1. Fully close the supply gas isolation valve [4].
2. Turn the supply gas pressure regulator [6] fully counter-clockwise.
3. Fully close the bypass and sample gas metering valves [2 & 3].

### 3.2.3 Aurora H2O Purge Gas Connection

1. Start with all valves in closed position and the pressure regulator turned fully counter-clockwise.
2. Confirm that there are no flow restrictions downstream of the analyzer sample outlet.
  - a. Maximum outlet back pressure: 10 psig
3. Turn the sample gas selector valve [1] with the handle indicator pointing fully to the left.
4. Connect the regulated and filtered gas supply.
  - a. Regulated pressure range: 0-10 psig.
  - b. Outlet filter size: 7 micron
  - c. Initial pressure setting: 0 psig (minimum)
5. Fully open the sample gas metering valve [3].
6. Increase the regulated pressure until the sample gas flow meter [7] indicates mid-scale.

## 3.2 Sample System (cont.)

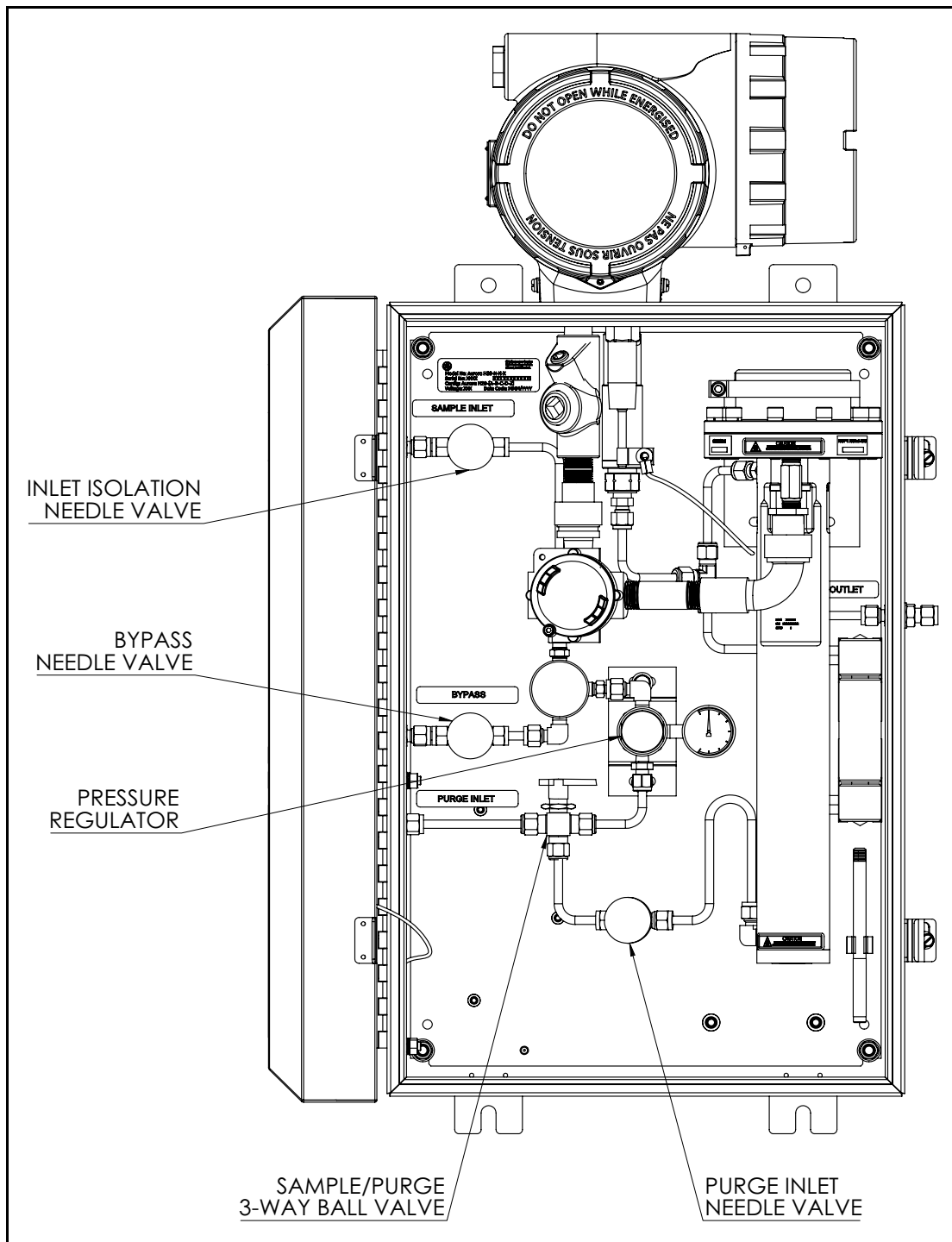



Figure 33: Aurora H2O Sample System (ref. dwg #902-004)

### 3.3 Keypad Features



The Aurora H20 has seven keys: a **Menu** key, four **Arrow** keys, a **Cancel**  key, and an **Enter**  key.

- Use the **Menu** key to open the main menu on the display.
- Use the **Arrow** keys to navigate among menu choices and to increment/decrement numeric entries.
- Use the **Cancel**  key to cancel a numeric entry change, or exit a menu.
- Use the **Enter**  key to accept a numeric entry or select a menu option.

### 3.3.1 Indicator Lights

If the **Fault Indicator** is lit, an instrument fault is detected. A message will be displayed in the Main Display, top/right.

If the **Information Indicator** is lit, the instrument is still operating, but a message will appear in the Main Display top/right, with information about the instrument.

The **Keypad Lock Indicator** will be lit if either: A) the Keypad Lock-Out Switch, internal to the instrument, has been engaged, or B) the instrument keypad has not been used for a period of several minutes, engaging a software feature to lock-out inadvertent key usage. Type (B) keypad lock-out is overcome by pressing **Cancel**, **Enter**, **Cancel** in sequence.

If the **Laser Indicator** is lit, the laser is powered and operating normally. This indicator will be off if there is a laser-specific fault. This indicator will also be off for a brief period when the instrument is first powered. After initial power-up, this indicator may blink several times as the laser temperature is stabilized. The laser indicator will be lit constantly in normal operation.

The **Power Indicator** is normally lit when the instrument is powered on.

### 3.3.2 The Magnetic Stylus

Each of the keys can be selected using a hand-held magnet called a *Magnetic Stylus* (see *Figure 35* below), which is included with the meter. By touching the clear window at a key location, that key will be selected and will flash a red light to verify the contact.



Figure 35: Magnetic Stylus

### 3.3.3 The Default Display

*Figure 36* below shows the default display of the Aurora H2O window.

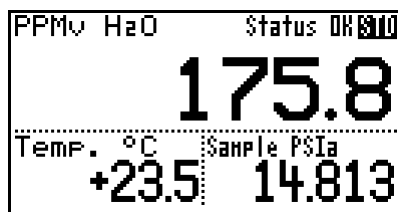

Primary

Figure 36: Default Display

Alt 1

Alt 2

### 3.3.4 Unlocking the Keypad

After power-on, the **Aurora H2O** keypad is locked as indicated by the symbol , lit up with a red backlight. It is necessary to enter the keypad unlock sequence to make any changes to the **Aurora H2O**.

Similar to a mobile phone, the **Aurora H2O** will prompt the operator to unlock if any key is pressed. A passcode is required to use certain factory service features only.

To unlock the keypad, press **Cancel** , **Enter** , **Cancel**  in sequence.

### 3.3.5 Keypad Lock-Out Switch

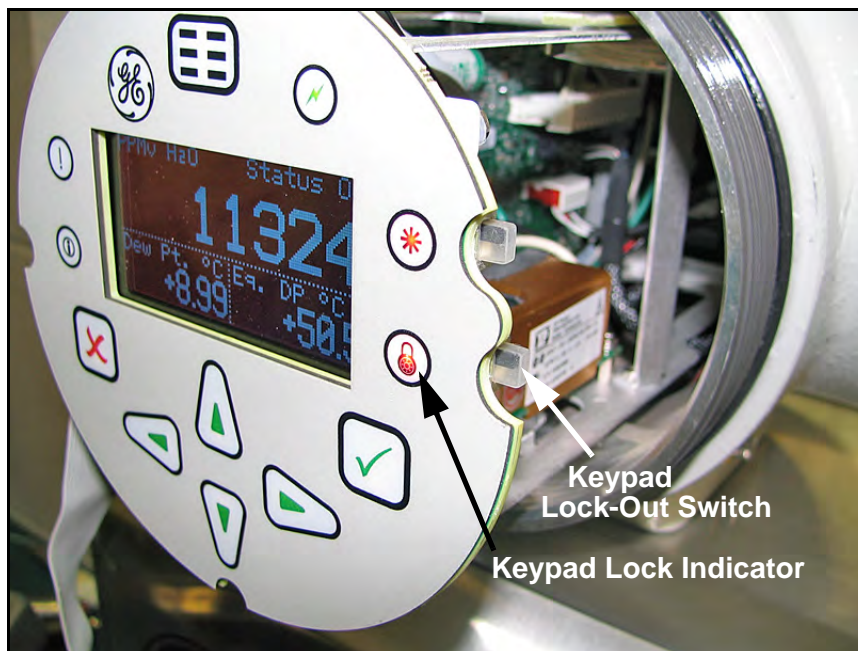

Figure 37: Keypad Lock-Out Switch Location

**Note:** *If the Keypad Lock-Out Switch is in the “down” position, the keypad is locked out and the **RED** LED on the Keypad Lock Indicator is on all the time.*





**WARNING!** Do not open or remove the cover with the power on, unless the area is non-hazardous.



### 3.3.6 Accessing the Menus

After successfully unlocking the keypad, press the  Menu key. The **Aurora H2O** will display the Main Menu (see *Figure 38* below). Use the arrow keys to highlight the menu item desired. Refer to *Menu Map, Figure 45 on page 75*.

Press **Enter**  to select the highlighted item. Many menu items will display another menu. Use **Cancel**  to return to the previous menu page. Pressing **Cancel**  from the Main Menu will return the screen to the Measurement Display.

**Note:** *Menu items displayed with an ellipsis (shown as a series of three dots after the menu item) will bring up more choices, while those without take immediate action.*

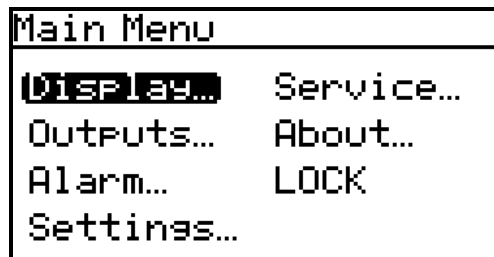





Figure 38: Main Menu



### 3.3.7 Entering Numeric Values

Since the **Aurora H2O** has no numeric keypad, numeric values are entered using a “*combination lock*” style of entry:

Use the **left**  and **right**  arrow keys to select the digit to change. The digit selected will be indicated with a **▲**.

Use the **up**  and **down**  arrow keys to increment or decrement the digit.

**Note:** *If incrementing or decrementing a digit would cause the numeric value to exceed its allowable range (maximum/minimum value), the digit will not change.*

Press **Enter**  to save the new value and return (see *Figure 39* below), or **Cancel**  to return, leaving the original value intact.

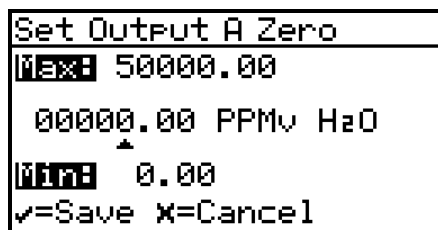
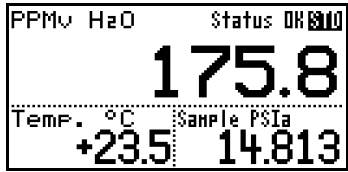

Figure 39: Numeric Entry

### 3.3.8 Starting Up

After proper installation, the **Aurora H2O** Transmitter can be set up to accommodate the user’s requirements. Typically, the user may need to configure the analog outputs, trim the analog outputs, and program the digital outputs. Refer to the Menu Map, Figure 45 on page 75, and complete the following steps. Upon startup, the **Aurora H2O** proceeds through several displays until a screen similar to the following appears:



After startup, the screen will need to be unlocked. To unlock the screen, select



**Note:** In most instances; use the **Enter** key to save an entry and/or move ahead to the following screen; use the **Cancel** key to reject an entry and/or return to the previous screen.

### 3.4 Setting Up the Display

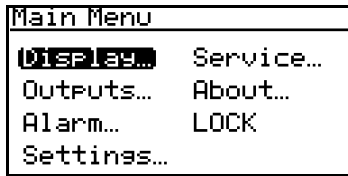

When the screen is unlocked, touch the **Menu** key and the Main Menu appears with several options. To set up the display, select Display... and press **Enter**. The following screen appears:

#### 3.4.1 Selecting Primary Units

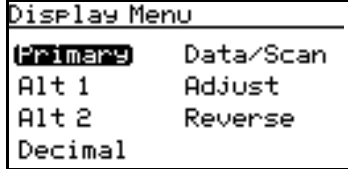

To select units for the primary display, select Primary and press **Enter**. The following screen appears:

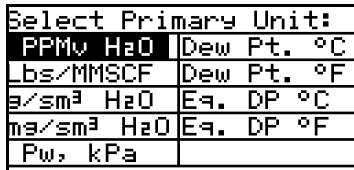

Use the arrow keys to highlight the desired units and press **Enter**. The screen returns to the Display Menu.

### 3.4.2 Selecting Alt 1 and Alt 2 Units

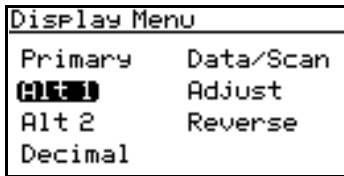

To set the units for Alt 1 and/or Alt 2, use the arrow keys to highlight the one to be set, and press **Enter**. The following screen appears:

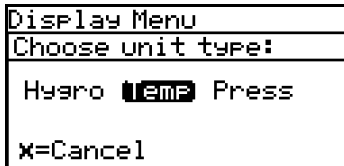

Use the arrow keys to highlight the desired unit type (Hygro, Temperature or Pressure) and press **Enter**. If Temp is selected, the following screen appears.

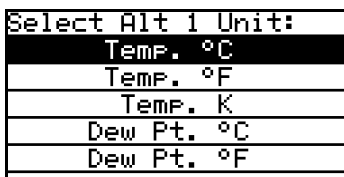

Use the arrow keys to highlight the desired unit and press **Enter**. The screen returns to the Display Menu. Use the same procedure to change other units.

### 3.4.3 Setting Decimal Places

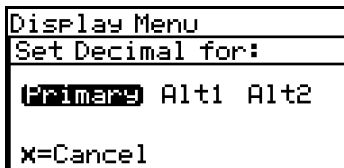

To set the decimal places for unit values, from the Display Menu use the arrow keys to highlight **Decimal** and press **Enter**. Then select the type of display and press **Enter**.

The decimal places setting determines the number of digits displayed for the value to the right of the decimal symbol (“.”), if possible.

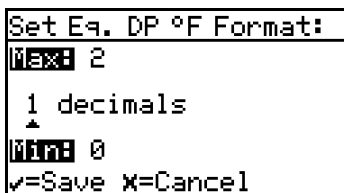

Use the arrow keys to change the number of decimal places and press **Enter**, or press **Cancel** if no changes are necessary. The screen returns to the Display Menu.

### 3.4.4 Data/Scan

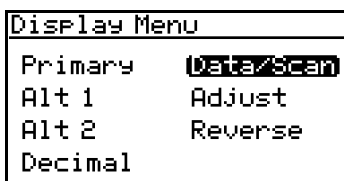

To toggle the display between showing the numeric values (data), and a graphic plot of the 2f waveform (scan), from the Display Menu use the arrow keys to highlight **Data/Scan** and press **Enter**. A screen similar to the following appears.

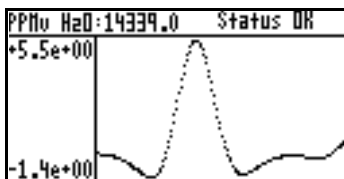

**Note:** The scan can be used for diagnostic purposes when a PC with AuroraView is not readily available.

### 3.4.5 Adjust

**Note:** *The display brightness is not adjustable in the current Aurora design; the brightness adjustment is not available.*

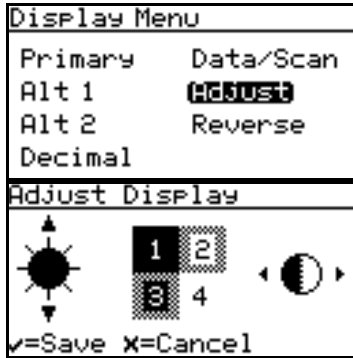

To modify the display contrast and brightness, from the Display Menu use the arrow keys to highlight **Adjust** and press **Enter**. The following screen appears.

Use the Up/Down arrow keys to increase/decrease display brightness. Use the Right/Left arrow keys to increase/decrease display contrast. Press **Enter** to save the changes, or press **Cancel** to return to the previous setup. The screen returns to the Display Menu.

### 3.4.6 Reverse

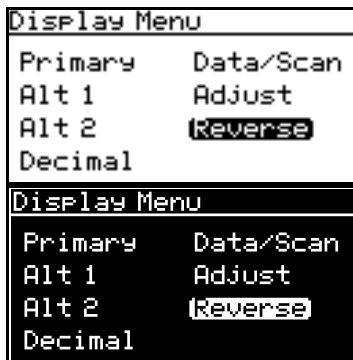

To reverse the text and background shades, from the Display Menu use the arrow keys to highlight **Reverse** and press **Enter**. The following screen appears.

To return to the previous shade setup, select **Reverse** and press **Enter**. The previous screen appears.

## 3.5 Setting Up the Outputs

### 3.5.1 Selecting an Output for Setup



To set up outputs, from the Main Menu choose **Outputs...** and press **Enter**. The following screen appears.

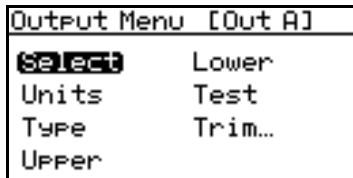

From the Output Menu choose **Select** and press **Enter**. The following screen appears.

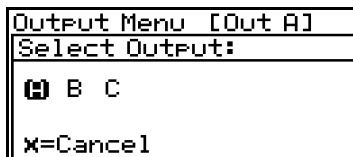

Use the arrow keys to select the output (A, B or C) to be set up, and press **Enter**.

### 3.5.2 Selecting Output Units

```
Output Menu [Out A]
Choose unit type:
[Temp] Temp Press
X=Cancel
```

From the Output Menu, select Units and press **Enter**. Use the arrow keys to select the unit type and press **Enter**. A screen similar to the following appears:

```
Select Out A Units:
PPMv H2O Dew Pt. °C
Lbs/MMSCF Dew Pt. °F
mg/m³ H2O Eq. DP °C
Pw, kPa Eq. DP °F
```

Use the arrow keys to select a new unit. Press **Enter** to save (or **Cancel** to keep the previous value), and return to the Output Menu.

### 3.5.3 Selecting an Output Type

```
Output Menu [Out A]
Select Lower
Units Test
[Type] Trim...
Upper
```

To change the output type, from the Output Menu select Type and press **Enter**. A screen similar to the following appears:

```
Output Menu [Out A]
Select Output Type:
[0-20mA] 0-20mA ALM
X=Cancel
```

Use the arrow keys to select a new output type. Press **Enter** to save (or **Cancel** to keep the previous value), and return to the Output Menu.

**Note:** *If the ALM option is selected in the above menu, the analog output will function as an alarm indicator. In this mode, the analog output will remain at 0 mA during normal operating conditions, but the analog output will be driven to 24 mA whenever there is an alarm condition.*

### 3.5.4 Changing the Upper Output Span

```
Output Menu [Out A]
Select Lower
Units Test
Type Trim...
[Upper]
```

To adjust the upper output span, from the Output Menu select Upper and press **Enter**. A screen similar to the following appears.

```
Set Output A Span
[50000.00] 50000.00
00100.00 PPMv H2O
[0.00] 0.00
✓=Save X=Cancel
```

Use the left and right arrow keys to select each digit to be changed and the up and down arrow keys to increase or decrease its value. Press **Enter** to save (or **Cancel** to keep the previous value), and return to Output Menu.

### 3.5.5 Changing the Lower Output Span

```

Output Menu [Out A]
Select      Lower
Units      Test
Type       Trim...
Upper
  
```

To adjust the lower output span, from the Output Menu select Lower and press **Enter**. A screen similar to the following appears.

```

Set Output A Zero
NEXT 50000.00
00000.00 PPMv H2O
0.00
✓=Save ✗=Cancel
  
```

Use the left and right arrow keys to select each digit to be changed and the up and down arrow keys to increase or decrease its value. Press **Enter** to save (or **Cancel** to keep the previous value), and return to Output Menu.

### 3.5.6 NAMUR Response

The **Aurora H2O** can report measurement failure information via the analog outputs. The signal presentation of failure information is consistent with by the recommendations established by the “User Association of Automation Technology in Process Industries” (NAMUR) published in NE43, version 03.03.2003. When configured for 4-20mA operation, faults and errors are indicated by specific output levels shown in *Figure 40* below:

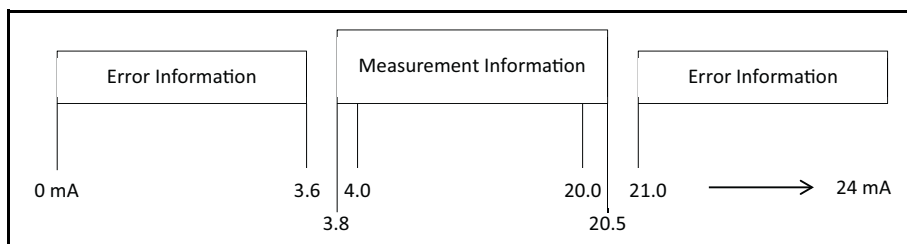

Figure 40: NAMUR Output Value Ranges

In normal operation, a valid measurement is indicated with a signal between 3.8 and 20.5 mA. The Lower (Zero) and Upper (Span) settings determine the measurement value assigned to 4.0 and 20.0 mA, respectively.

For the measurement assigned to an output, the **Aurora H2O** continuously checks if an error has occurred. If an error has occurred, the output will be driven to a current which is within the Error Information bands displayed above. The **Aurora H2O** can signal 3.5 mA ('NAMUR Low') or 21.1 mA ('NAMUR High'). These values are well within the Error Information bands as specified by NAMUR (see *Table 3* below).

**Note:** *The Aurora H2O will never produce a signal between 3.6-3.8 mA or between 20.5-21.0 mA, to allow for reliable discrimination between a measurement and an error.*

Table 3: Signal Messages

Error	Description	Signal
Under Range	The measurement is less than the calibrated range of the analyzer	NAMUR Low
Over Range	The measurement is greater than the calibrated range of the analyzer	NAMUR High
Out of Range	Calculation error or associated measurement (Temp/Pressure) invalid	NAMUR High
No Data	Measurement value has not been calculated yet	NAMUR High
No Calibration	Moisture calibration table empty/invalid	NAMUR High

### 3.5.6a NAMUR Filtering

There may be situations where the NAMUR signaling behavior is undesirable (see Table 4 below). For example, a process operating at or near the **Aurora H2O** calibration limits, or when connected to a SCADA or DCS system that cannot correctly distinguish between a measurement and an error signal. In these cases, the NAMUR reporting behavior can be suppressed (“inhibited”). From the Output menu, select NAMUR:

```
Output Menu [Out A]
Select      Lower
Units      NAMUR
Type       Test
Upper      Trim...
```

Then select the error(s) to inhibit:

```
Output Menu [Out A]
Inhibit NAMUR for:
NONE LoRng HiRng
Lo+Hi  ALL
X=Cancel
```

Table 4: NAMUR Errors

Selection	Result
NONE	No errors are inhibited; NAMUR signaling will occur for any error as shown in the table above.
LoRng	Under Range errors are inhibited; NAMUR signaling will NOT occur for Under Range error conditions. NAMUR signaling will occur for all other errors in the table above.
HiRng	Over Range errors are inhibited; NAMUR signaling will NOT occur for Over Range error conditions. NAMUR signaling will occur for all other errors in the table above.
Lo+Hi	Under Range AND Over Range errors are inhibited; NAMUR signaling will NOT occur for these error conditions. NAMUR signaling will occur for all other errors in the table above.
ALL	ALL errors are inhibited; NAMUR signaling will NOT occur for any error in the table above.

### 3.5.7 Testing the Output

```
Output Menu [Out A]
Select      Lower
Units      Test
Type       Trim...
Upper
```

The Test Menu causes the **Aurora H2O** to generate a 0- or 4-20mA output at the percent of scale selected. For example, in 4-20 operation, 0% = 4mA, 50% = 12mA, 100% = 20mA. This allows the proper function of recording or SCADA equipment to be verified. In 0-20 operation, 0% = 0mA, 50% = 10mA, 100% = 20mA.

```
Output A Test Value:
0000 +110.00
+050.00 %
0000 -25.00
v=Save X=Cancel
```

To test system output, from the Output Menu select Test and press **Enter**. The **Aurora H2O** will proceed to check the settings, and a screen similar to this display will appear.

Use the left and right arrow keys to select each digit to be changed, and the up and down arrow keys to increase or decrease its value. Press **Enter** to save (or **Cancel** to keep) the previous value, and return to the Output Menu.

Check your output wiring. If the reading on your SCADA or DCS is off slightly, then you may use the Trim feature to trim the output zero or span.

### 3.5.8 Trimming the Outputs

The Trim Menu enables the operator to compensate for differences in measurement of the 0/4-20 mA outputs by connected recorders or SCADA equipment. To trim the output:

```
Output Menu [Out A]
Select      Lower
Units      Test
Type       Trim
Upper
```

Select Trim from the Output Menu and press **Enter**. The following screen appears.

**Note:** *The trim applies to whichever output is chosen with the Select menu item, and displayed on the menu title bar.*

```
Trim Menu [Out A]
Select Trim Output:
(A) B C
X=Cancel
```

Use the left and right arrow keys to select an output (A, B or C) and press **Enter**. The screen returns to the previous display.

```
Trim Menu [Out A]
Reset Trim
Trim Zero
Trim Set up
```

When performing a Trim operation, the **Aurora H2O** unit requires you to first reset the trim. To reset the trim output, highlight Reset Trim and press **Enter**. The following screen appears.

```
Trim Menu [Out A]
Reset Out A Trim?
(YES) NO
X=Cancel
```

Use the left or right arrow keys to highlight YES and press **Enter**. This cancels any previous trim values, and returns the **Aurora H2O** to its factory adjustment. The display returns to the previous screen with Trim Zero highlighted.

```
Trim Menu [Out A]
Reset Trim
Trim Zero
Trim Set up
```

To trim the zero value, press **Enter**. A screen similar to the following appears.

This will cause the **Aurora H2O** to output 4.000 mA on the output being trimmed. The output value should then be read using the connected recorder, SCADA equipment, or DVM. Enter the value read from the connected equipment as the Zero Trim value, as follows:



### 3.5.8 Trimming the Outputs (cont.)

**Note:** *Since you cannot trim 0 mA for negative offsets, trim for the lower end of the scale is at the 4 mA output level.*

```

Enter Out A Reading:
Max: 5.2000
  04.0000 mA
  ^
Min: 3.0000
✓=Save X=Cancel
  
```

Use the left and right arrow keys to select each digit to be changed, and the up and down arrow keys to increase or decrease its value. Press **Enter** to save (or **Cancel** to keep the previous value).

```

Trim Menu [Out A]
Reset Trim
Trim Zero
Trim Span
  
```

The Trim Menu returns with Trim Span highlighted. To change the span value, press **Enter**. A screen similar to the following appears.

This will cause the Aurora H2O to output 20.000 mA on the output being trimmed. The output value should then be read using the connected recorder, SCADA equipment, or DVM. Enter the value read from the connected equipment as the Span Trim value.

```

Enter Out A Reading:
Max: 22.2000
 20.0000 mA
  ^
Min: 10.0000
✓=Save X=Cancel
  
```

Use the left and right arrow keys to select each digit to be changed, and the up and down arrow keys to increase or decrease its value. Press **Enter** to save (or **Cancel** to keep the previous value).

Trimming is complete. Accuracy can be verified using the Test Menu, above.

**Example:** Trim is reset, then Trim Zero is selected. The SCADA input reports 3.977 mA.

The operator enters “3.977” as the Zero Trim value.

Trim Span is selected. The SCADA input reports 19.985 mA.

The operator enters “19.985” as the Span Trim value.

Aurora H2O adjusts the output accordingly to true the output as read by the customer recorder, SCADA or DVM.

Using the Test Menu, the operator verifies that a test value of 0% now reads 4.000 mA at the SCADA equipment, and a test value of 100% now reads 20.000 mA.

## 3.6 Setting Up the Alarms

**Note:** *The Aurora H2O is not equipped with alarm relays. The Alarm function is useful only when reading the alarm status via Modbus.*

### 3.6.1 Selecting an Alarm Output

```

Alarm Menu [A]
Select Upper
Status Lower
Units
Type...
  
```

To set up alarm outputs, on the Main Menu choose Alarm and press **Enter**. From the Alarm Menu choose Select and press **Enter**. A screen similar to the following appears.

```

Alarm Menu [A]
Select Alarm:
(A) B C
X=Cancel
  
```

Use the arrow keys to select the output (A, B or C) to be set up and press **Enter**. The display returns to the Alarm Menu.

### 3.6.2 Selecting Alarm Status

Alarm Menu [A]
Select Upper
<b>Status</b> Lower
Units
Type...
Alarm Menu [A]
Set Alarm Status:
<b>OFF</b> ON
X=Cancel

To select the alarm status, from the Alarm Menu select Status and press **Enter**. The following screen appears:

Use the arrow keys to select OFF or ON and press **Enter**. The display returns to the Alarm Menu.

### 3.6.3 Selecting Alarm Units

Alarm Menu [A]
Choose unit type:
Hygro <b>Temp</b> Press
X=Cancel

To select alarm units, from the Alarm Menu select Units and press **Enter**. Use the arrow keys to select the unit type and press **Enter**.

Select Alarm A Units:
PPMv H <sub>2</sub> O Dew Pt. °C
Lbs/MMSCF Dew Pt. °F
mg/m <sup>3</sup> H <sub>2</sub> O Eq. DP °C
Pw, kPa Eq. DP °F

If Hygro was selected, this display appears. Use the arrow keys to select a unit. Press **Enter** to save (or **Cancel** to keep the previous value), and return to the Alarm Menu.

Select Alarm A Units:
<b>Temp. °C</b>
Temp. °F
Temp. K
Dew Pt. °C
Dew Pt. °F

If Temperature was selected, this display appears. Use the arrow keys to select a unit. Press **Enter** to save (or **Cancel** to keep the previous value), and return to the Alarm Menu.

Alarm Menu [A]
Choose Pressure type:
Sample <b>Line</b>
X=Cancel

If Pressure was selected, this display appears. Use the arrow keys to select a unit. Press **Enter** to save (or **Cancel** to keep the previous value), and return to the Alarm Menu.

### 3.6.4 Selecting an Alarm Type

```
Alarm Menu [A]
Select      Upper
Status     Lower
Units
Type...
```

To change the alarm type, from the Alarm Menu select Type and press **Enter**. A screen similar to the following appears:

```
Select Alarm Type:
Setpoint
In Band
Out Band
Fault
```

Use the arrow keys to select an alarm type. Press **Enter** to save (or **Cancel** to keep the previous value), and return to the Alarm Menu.

- **SetPoint:** Alarm activates when parameter exceeds upper limit, and deactivates when parameter is less than lower limit.
- **Inner Band:** Alarm activates when parameter is between upper and lower limits.
- **Outer Band:** Alarm activates when parameter is outside upper and lower limits.
- **Fault:** Alarm activates when a system fault is detected. The alarm de-activates when the fault condition is removed. These conditions can be found in Section 7.4, Table 4.

### 3.6.5 How the Alarm Types Work

See *Figure 41* below for descriptions of the various alarm types:

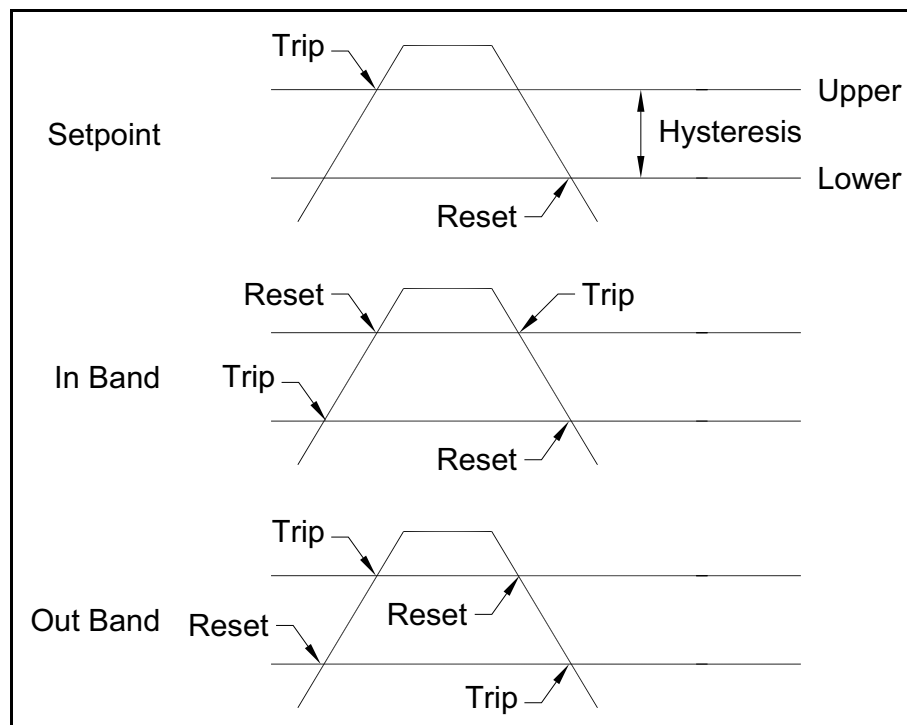

Figure 41: Example of Alarm Types

### 3.6.6 Changing the Upper Alarm Span

```
Alarm Menu [A]
Select   UPPER
Status   Lower
Units
Type...
```

To adjust the upper alarm span, from the Alarm Menu select Upper and press **Enter**. A screen similar to the following appears.

```
Enter MAX Alm Value
NEXT 413.680
 50.000 kPa
  ▲
MIN 0.000
✓=Save X=Cancel
```

Use the left and right arrow keys to select each digit to be changed and the up and down arrow keys to increase or decrease its value. Press **Enter** to save (or **Cancel** to keep the previous value), and return to Output Menu.

### 3.6.7 Changing the Lower Alarm Span

```
Alarm Menu [A]
Select   Upper
Status   LOWER
Units
Type...
```

To adjust the lower alarm span, from the Alarm Menu select Lower and press **Enter**. A screen similar to the following appears.

```
Enter MIN Alm Value
NEXT 413.680
 50.000 kPa
  ▲
MIN 0.000
✓=Save X=Cancel
```

Use the left and right arrow keys to select each digit to be changed and the up and down arrow keys to increase or decrease its value. Press **Enter** to save (or **Cancel** to keep the previous value), and return to Output Menu.

## Chapter 4. Programming Advanced Features

### 4.1 Comm Port Settings

```

Main Menu
Display...  Service...
Outputs...  About...
Alarm...   LOCK
Settings...
  
```

To access the communication port settings, from the Main Menu select Settings and press **Enter**. The following screen appears:

```

Settings Menu
Comms...   Pressure...
Adjust...  Locale...
Gas        Ethernet...
Clock...
  
```

To access the communications port settings, select Comms... and press **Enter**. The following screen appears:

#### 4.1.1 Selecting a Comm Port

```

Comm Port: [SCADA]
Select      Network ID
Baud Rate
Parity
Protocol
  
```

There are two physical comm ports in the **Aurora H2O**. Comm Port 1 is aligned to *SCADA* in the instrument program and Comm Port 2 is aligned to *SERVICE*. This setup enables the user to have Comm Port 1 set up for the primary digital output (for example, RS-485 to the customer SCADA system), and Comm Port 2 to be used for service (for example, to enable a service engineer to interface with the **Aurora H2O** using an RS-232 cable connected to a laptop PC in the field, running **AuroraView** software).

To select a communication port, use the arrow keys to highlight Select and press **Enter**. The following screen appears.

```

Comm Port: [SCADA]
Select Comm Port:
[SERVICE] SERVICE
x=Cancel
  
```

Select SCADA or SERVICE and press **Enter**. The screen returns to the Comm Port Menu.

#### 4.1.2 Setting the Baud Rate

```

Comm Port: [SCADA]
Select      Network ID
Baud Rate
Parity
Protocol
  
```

To set the baud rate, from the Comm Port Menu select Baud Rate and press **Enter**. The following screen appears.

```

Select Baud Rate:
115.2k | 19.2k
57.6k  | 9600
38.4k  | 4800
  
```

Use the arrow keys to highlight the desired baud rate and press **Enter**. The screen returns to the Comm Port Menu.

### 4.1.3 Setting Parity

```
Comm Port: [SCADA]
Select   Network ID
Baud Rate
Parity
Protocol
```

To set parity, from the Comm Port Menu select Parity and press **Enter**. The following screen appears.

```
Comm Port: [SCADA]
Select Parity:
(=O=) ODD NONE
X=Cancel
```

Use the arrow keys to highlight the desired parity and press Enter.

```
Comm Port: [SCADA]
Select Stop Bits:
(O=) TWO
X=Cancel
```

After a parity selection is made, the Aurora prompts for the number of stop bits. Use the arrow keys to highlight the desired number and press Enter. The screen returns to the Comm Port Menu.

### 4.1.4 Selecting Protocol

```
Comm Port: [SCADA]
Select   Network ID
Baud Rate
Parity
Protocol
```

To choose the protocol, from the Comm Port Menu select Protocol and press Enter. The following screen appears.

```
Comm Port: [SCADA]
Select Protocol:
(=RS=) RS-485
X=Cancel
```

Use the arrow keys to highlight the desired protocol and press **Enter**. The screen returns to the Comm Port Menu.

### 4.1.5 Setting the Network ID

```
Comm Port: [SCADA]
Select   Network ID
Baud Rate
Parity
Protocol
```

To set the network ID, from the Comm Port Menu select Network ID and press **Enter**. The following screen appears.

```
Set Node ID:
(=N=) 247
001
(=N=) 1
✓=Save X=Cancel
```

Use the left and right arrow keys to select each digit to be changed. Use the up and down arrow keys to change the value. When finished, press **Enter**. The screen returns to the Comm Port Menu.

## 4.2 Adjust Offset Values

```
Settings Menu
-----
Comms...   Pressure...
Adjust...  Locale...
Gas        Ethernet...
Clock...
```

To adjust offset values, from the Settings Menu select Adjust... and press **Enter**. The following screen appears.

### 4.2.1 Adjusting the PPMv Offset

```
User Adjustments
-----
PPM Level
Filter
Dew Pt Calc
```

To adjust the PPMv offset, select PPM Level and press **Enter**. The following screen appears.

```
PPMv Offset:
-----
Max +25.00
+00.00 PPM
  ^
Min -25.00
√=Save X=Cancel
```

Use the left and right arrow keys to select each digit to be changed. Use the up and down arrow keys to change the value. When finished, press **Enter**. The screen returns to the User Adjustments Menu.

### 4.2.2 Adjusting the Smoothing Filter

```
User Adjustments
-----
PPM Level
Filter
Dew Pt Calc
```

To adjust the smoothing filter, from the User Adjustments Menu select Filter and press **Enter**. The following screen appears.

```
Smoothing Filter:
-----
Max 200
 40 samples
  ^
Min 10
√=Save X=Cancel
```

The smoothing filter setting is used to change the system responsiveness. It is a moving average filter to smooth the moisture readings. 1 sample = 1 scan. The minimum setting is 10 samples, or ~ 0.6 seconds. The maximum setting is 500 samples, or ~ 31 seconds. The default value of 40 samples, as set at the factory, is ~2.5 seconds.

Use the left and right arrow keys to select each digit to be changed. Use the up and down arrow keys to change the value. When finished, press **Enter**. The screen returns to the User Adjustments Menu.

### 4.2.3 Adjusting the Scan Averaging

```

User Adjustments
PPM Level
Filter
Scan Avg
Dew/Frost
  
```

To adjust the Scan Averaging, from the User Adjustments Menu select Scan Avg and press **Enter**. The following screen appears:

```

Scan Average:
Next 501
 060 depth
 1
√=Save X=Cancel
  
```

The Scan Average setting is used to change system noise rejection. By averaging entire scans, the Signal/Noise Ratio (SNR) can be increased. This is particularly useful in the presence of certain background gases, which can interfere with the moisture absorption peak, or introduce background noise.

The Scan Average value is set at the factory to a value which is an optimal tradeoff between noise reduction and system responsiveness, typically between 45-75 scans. Lowering this value provides faster response time in exchange for a noisier measurement; conversely, increasing the scan average provides a smoother measurement in exchange for slower transient response.

Please contact a GE application engineer before modifying this setting.

Use the left and right arrow keys to select each digit to be changed. Use the up and down arrow keys to change the value. When finished, press **Enter**. The screen returns to the User Adjustments Menu.



#### 4.2.4 Setting the Dew Point Calculation Method

- The **dew point** is the temperature at which the air is saturated with respect to water vapor over a **liquid** surface.
- The **frost point** is the temperature at which the air is saturated with respect to water vapor over an **ice** surface.

There can be a difference of several degrees C between the dew point and the frost point.

- When set for Dew/Frost, the **Aurora H2O** will report the *Dew Point* if the reading is above freezing, and will report the *Frost Point* if the reading is below freezing.
- When set for Dew Point, the **Aurora H2O** will calculate the *Dew Point* temperature, even if that temperature is below freezing.

```
User Adjustments
PPM Level
Filter
Dew Pt Calc
```

To set the dew point calculation method, from the User Adjustments Menu select Dew Pt Calc and press **Enter**. The following screen appears.

```
User Adjustments
Calc Dew Point as:
Dew Dew/Frost
X=Cancel
```

Use the arrow keys to highlight the desired dew point setting and press **Enter**. The screen returns to the User Adjustments Menu.

- The Dew calculation should be used for compatibility with ASTM-1142/IGT-8. The tables and calculations in those reports require measurements and provide results in dew point, regardless of the actual phase (dew or frost).
- The Dew/Frost calculation should be used for compatibility with ISO-18453:2004, or when using a chilled mirror apparatus as a check standard.

## 4.3 Set Up the Background Gas

### 4.3.1 Selecting the Type of Gas

The Aurora H2O TDLAS is normally calibrated to a standard gas mixture that is representative of “typical” natural gas. The primary components and concentrations of this gas mixture are:

Component	Concentration
Methane (CH <sub>4</sub> )	90.0%
Nitrogen (N <sub>2</sub> )	6.0%
Carbon Dioxide (CO <sub>2</sub> )	4.0%

The process background gas is selectable from the Settings Menu.

- For normal operation in natural gas service, **STD** should be selected as the background gas.
- For verification testing in **pure methane**, select **CH4**.
- If verifying in **Nitrogen** with a known moisture concentration, **N2** should be selected as the background gas.

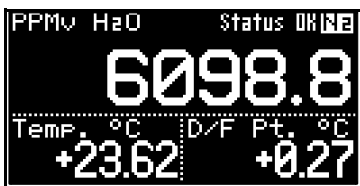

The Aurora H2O displays the selected Background Gas as an indicator in the upper right corner of the LCD, adjacent to the status message.

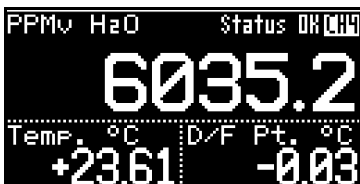

Unless otherwise requested, the Aurora H2O is shipped from the factory configured for Methane operation.



To change the type of background gas, from the Settings Menu select Gas and press Enter. The following screen appears.

### 4.3.1 Selecting the Type of Gas (cont.)

```
Gas Data
Background Gas
Mol. Wt.
Z Factor
Label
```

From the Gas Data menu, select Background and press **Enter**. The following screen appears.

```
Gas Data
Background Gas
N2      STD      CH4
        CO2      Gas2
x=Cancel
```

Use the arrow keys to select the desired background gas, and press **Enter**. The background gas selection is now complete. Press **Cancel** to return to the display page.

**Note:** Selecting either Gas1 or Gas2 enables the Label menu item. This menu opens a keyboard display that allows the user to change the 'Gas1/2' label to one of their own choosing. Entering the Label menu requires the User passcode (2719).

### 4.3.2 Setting the Z Factor

The **Z factor** is a number that accounts for the non-ideal compressibility of natural gas, and is vital for accurate calculation of mass/volume (lbs/MMSCF, mg/m<sup>3</sup>).

```
Gas Data
Bkcd Gas
Z Factor
Mol. Wt.
Label
```

To set the **Z factor**, from the Gas Data Menu, select Z Factor and press enter. The following screen appears.

```
Compress. Factor (Z)
Max 1.5000
0.9987
Min 0.5000
v=Save x=Cancel
```

Use the left and right arrow keys to select each digit to be changed. Use the up and down arrow keys to change the value. When finished, press **Enter**. The screen returns to the Settings Menu.

### 4.3.3 Entering a Label

Selecting either Gas1 or Gas2 enables the Label menu item. This menu opens a keyboard display that allows the user to change the 'Gas1/2' label to one of their own choosing. Entering the Label menu requires the User passcode (2719).

To enter/edit a label:

Selecting the Label menu item displays the Alphanumeric Entry control (see *Figure 42* below).

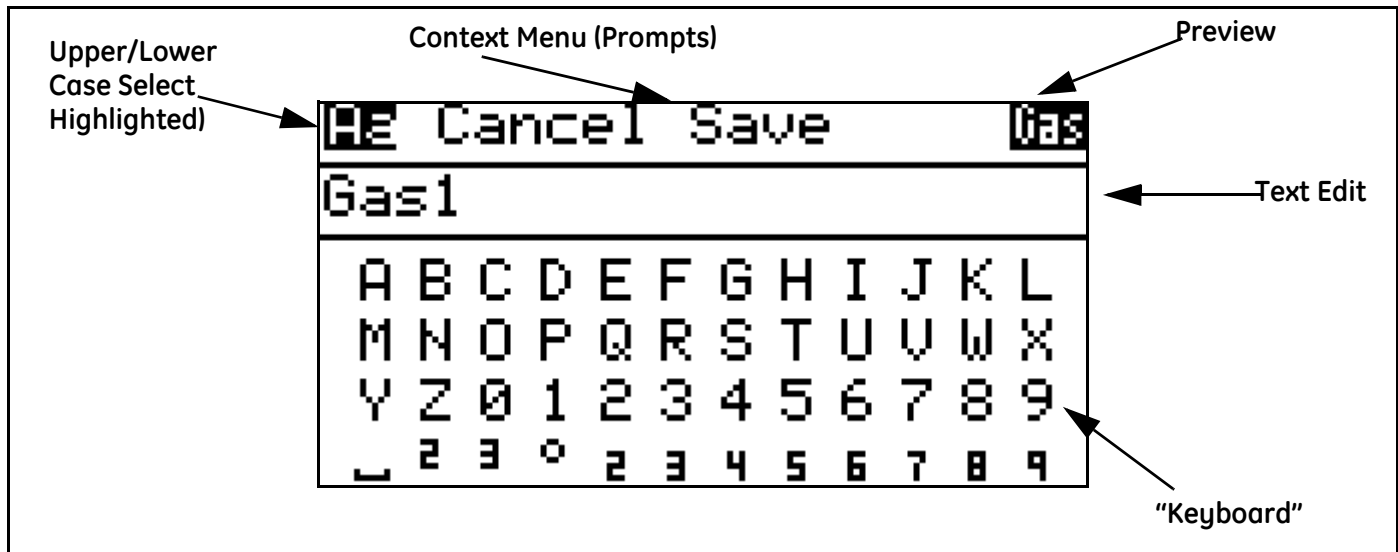

Figure 42: Alphanumeric Entry Control

The alpha menu is divided into three sections. The active section will have something highlighted (reverse video). The **Up/Down** arrows are used to move between sections.

### 4.3.3 Entering a Label (cont.)

The top section is the **Context Menu**. The 'Aa' toggles the keyboard between upper and lower case (shift key). `Cancel` abandons any changes to the label. `Save` saves any changes made to the label. There is also a 'preview' of how the label will look from the main data display.

- Pressing the **Down** arrow will move the highlight to the **Text Edit** section (see *Figure 43* below):

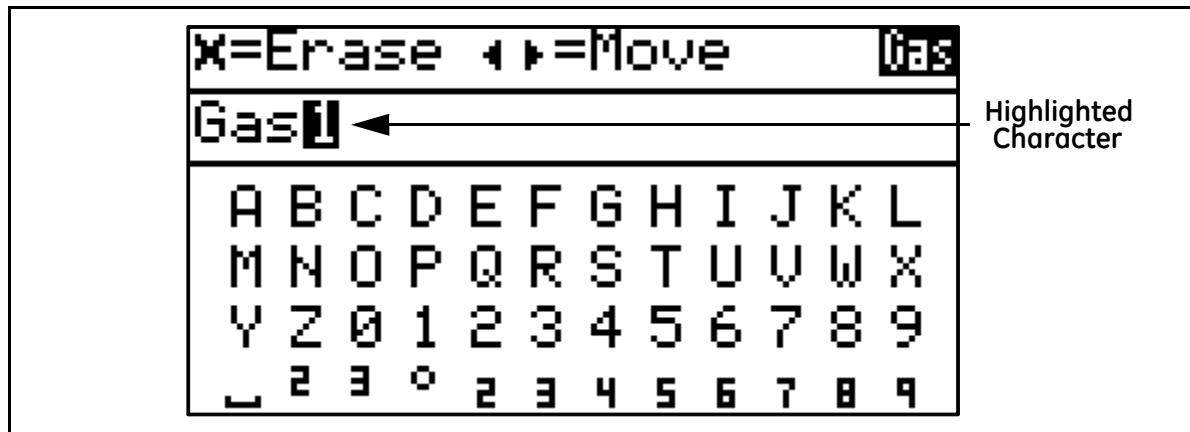

Figure 43: Text Edit

Note that the **Context Menu** has changed; it displays prompts of available key actions.

- In **Text Edit**, the **Left** and **Right** arrows move the highlight from character to character in the label. Pressing **x** erases the highlighted character.
- Pressing the **Down** arrow will move the highlight to the **Keyboard** section (see *Figure 44* below):

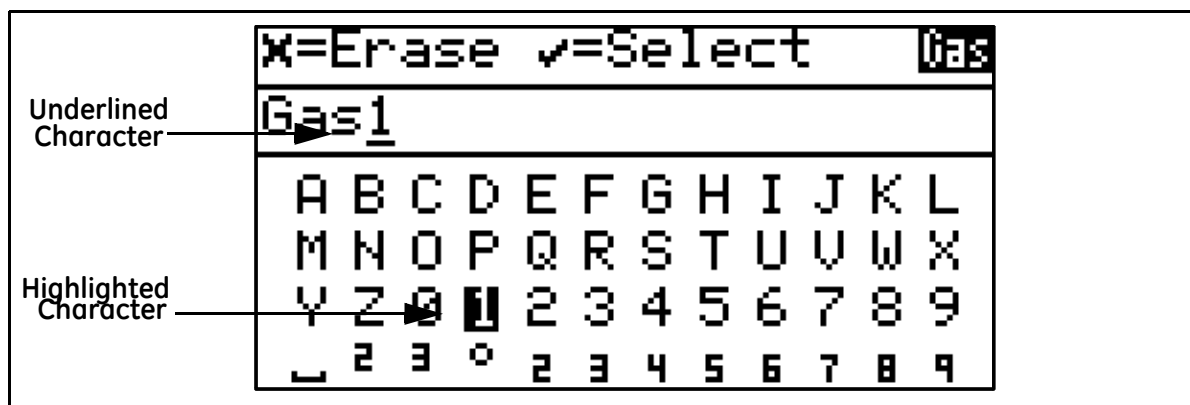

Figure 44: Alphanumeric Menu with Keyboard Highlighted

Note that the **Context Menu** has changed again; it displays prompts of available key actions when in the keyboard. In **Keyboard**, the **Left / Right / Up / Down** arrows move the highlight from character to character in the keyboard.

### 4.3.3 Entering a Label (cont.)

Note that the character selected in **Text Edit** is now underlined.

- Pressing **Enter** replaces the underlined character with the character highlighted on the keyboard.
- Pressing **Cancel** erases the underlined character. Any characters after the erased character are shifted to the left. If there are no characters after the erased character, the underline moves to the last character in the label.
- When in the **Keyboard**, pressing the **Down** arrow repeatedly will move the highlight down to the next row of 'keys'. When the highlight is on the bottom row, pressing **Down** will move the highlight to the top row.
- Pressing the **Up** arrow will move the highlight up to the previous row of keys. When the highlight is on the top row, pressing **Up** will switch to the **Text Edit** section.
- From the **Text Edit** section, pressing **Up** will move the highlight to the **Context Menu** section.
- Choose **Cancel** or **Save** to exit the Label entry.

### 4.3.4 Adjusting the Gas Offset

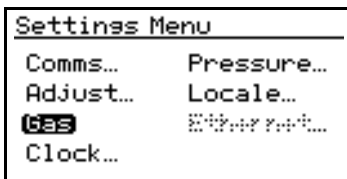

The input information for gas molecular weight is not currently used for any moisture calculations and is reserved for future use.

- lbs/MMSCF is calculated using IGT Research Bulletin #8 and ASTM D-1142-95 referenced at 60°F, 1 ATM.
- $\text{mg/cm}^3$  is based on ideal gas law derivation referenced at 15°C, 1.01325 kPa.

To adjust the gas molecular weight offset, from the Settings Menu select Gas and press **Enter**. From the Gas Data menu select Mol. Weight and press **Enter**. The following screen appears.

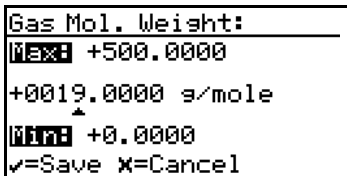

Use the left and right arrow keys to select each digit to be changed. Use the up and down arrow keys to change the value. When finished, press **Enter**. The screen returns to the Settings Menu.

## 4.4 Clock Settings



The clock settings are for informational purposes. They are used to keep track of the test analyzer start time and the laser operational time.

To reset the clock, from the Settings Menu select Clock and press **Enter**. The following screen appears.

### 4.4.1 Resetting the Hour

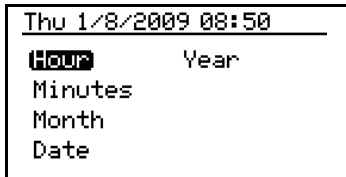

To reset the hour, from the Clock Menu select Hour and press **Enter**. The following screen appears.

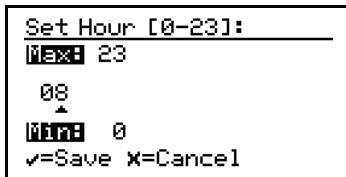

Use the left and right arrow keys to select each digit to be changed. Use the up and down arrow keys to change the value. When finished, press **Enter**. The screen returns to the Clock Menu.

### 4.4.2 Resetting the Minutes

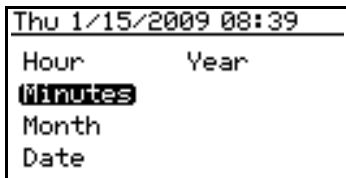

To reset the minutes, from the Clock Menu select Minutes and press **Enter**. The following screen appears.

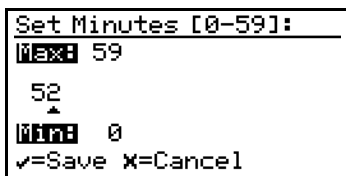

Use the left and right arrow keys to select each digit to be changed. Use the up and down arrow keys to change the value. When finished, press **Enter**. The screen returns to the Clock Menu.

### 4.4.3 Resetting the Month

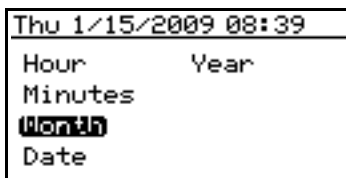

To reset the month, from the Clock Menu select Month and press **Enter**. The following screen appears.

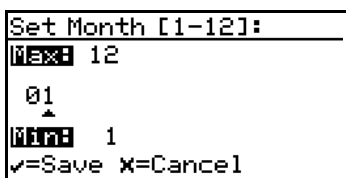

Use the left and right arrow keys to select each digit to be changed. Use the up and down arrow keys to change the value. When finished, press **Enter**. The screen returns to the Clock Menu.

#### 4.4.4 Resetting the Date

```
Thu 1/15/2009 08:39
-----
Hour      Year
Minutes
Month
Date
```

To reset the date, from the Clock Menu select Date and press **Enter**. The following screen appears.

```
Set Date:
-----
Max: 31
 08
  ↑
Min: 1
√=Save X=Cancel
```

Use the left and right arrow keys to select each digit to be changed. Use the up and down arrow keys to change the value. When finished, press **Enter**. The screen returns to the Clock Menu.

#### 4.4.5 Resetting the Year

```
Thu 1/15/2009 08:39
-----
Hour      Year
Minutes
Month
Date
```

To reset the year, from the Clock Menu select Year and press **Enter**. The following screen appears.

```
Set Year:
-----
Max: 2100
 2009
  ↑
Min: 2008
√=Save X=Cancel
```

Use the left and right arrow keys to select each digit to be changed. Use the up and down arrow keys to change the value. When finished, press **Enter**. The screen returns to the Clock Menu.



## 4.5 Pressure Settings

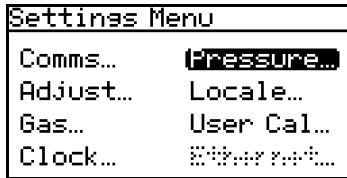

To reset the pressure settings, from the Settings Menu, select Pressure... and press **Enter**. The following screen appears.

### 4.5.1 Setting Pressure Units

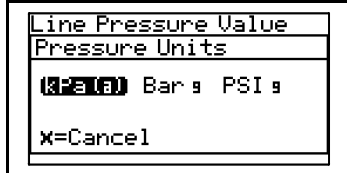

To set the pressure units, from the Pressure Menu, select Units and press **Enter**. You can then choose from: kPa(a) (Kilopascals Absolute), Bar g- (Bars gauge), or PSI g- (Pounds per Square Inch gauge).

### 4.5.2 Setting the Source

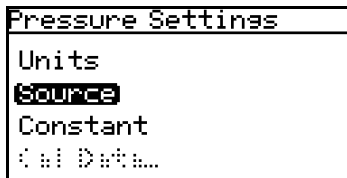

To reset the source, from the Pressure Menu, select Source and press **Enter**. The following screen appears.

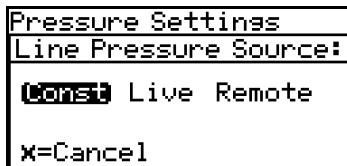

Use the left and right arrow keys to select the line pressure source. Live accepts a pressure value from a pressure transmitter and Remote accepts a value via a Modbus connection. To set a constant value, select Constant and press **Enter**. The screen returns to the Pressure Menu.

### 4.5.3 Changing the Constant

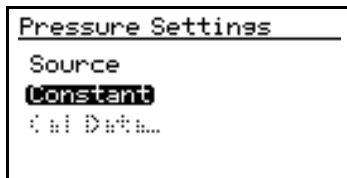

If the pressure source selected is Constant, to reset its value, select Constant from the Pressure Menu and press **Enter**. The following screen appears.

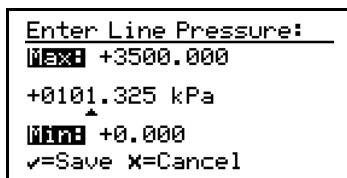

Use the left and right arrow keys to select each digit to be changed. Use the up and down arrow keys to change the value. When finished, press **Enter**. The screen returns to the Pressure Menu.

**Note:** Data entry for this setting is only in kPa.

#### 4.5.4 Editing Pressure Calibration

Pressure input in this section is used only for equivalent dew point calculations. Equivalent dew point is the dew point of the process gas at the process pressure. Input a “constant” value if the line pressure is at a normal pressure, or use an external pressure transmitter to input a “live” pressure input into the **Aurora H2O** analyzer.

```

Pressure Settings
Line Pressure Source:
Constant Live
X=Cancel
  
```

To edit the pressure calibration, from the Line Pressure Source Menu, select Live and press **Enter**. The following screen appears.

```

Line Pressure Value
Source
Constant
Cal Data..
  
```

To edit the Calibration Data, use the arrow keys to select Cal Data and press **Enter**. The following screen appears.

```

Edit Pressure Cal
Select Cal Point
Edit Pressure Value
Edit Input Value
  
```

To select the Calibration Point, use the up and down arrow keys to highlight Select Cal Point and press **Enter**. The following screen appears.

```

Edit Pressure Cal
Select Cal Point:
Zero Span
X=Cancel
  
```

Use the left and right arrow keys to select Zero or Span and press **Enter**. The screen returns to the previous menu.

```

Live Pressure Zero
Select Cal Point
Edit Pressure Value
Edit Input Value
  
```

To edit the Pressure Value, use the up and down arrow keys to select Edit Pressure Value and press **Enter**. The following screen appears.

```

Enter Line Pressure:
WAVE +3500.000
+0000.000 kPa
WAVE +0.000
√=Save X=Cancel
  
```

Use the left and right arrow keys to select each digit to be changed. Use the up and down arrow keys to change the value. When finished, press **Enter**. The screen returns to the previous menu.

#### 4.5.4 Editing Pressure Calibration (cont.)

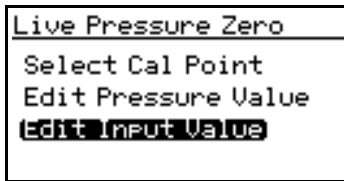

To edit the Input Value, use the up and down arrow keys to select Edit Input Value and press **Enter**. The following screen appears.

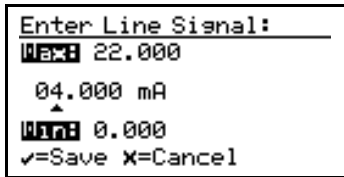

Use the left and right arrow keys to select each digit to be changed. Use the up and down arrow keys to change the value. When finished, press **Enter**. The screen returns to the previous menu.

## 4.6 Regional Settings

This section enables the setting of regional information, depending on the location of the **Aurora H2O**.



To reset the regional settings, from the Settings Menu, select Locale... and press **Enter**. The following screen appears.

**Note:** *Locale settings for your order have been set at the factory and are access code protected. If you determine a need to access Regional Settings, contact the factory for assistance.*

### 4.6.1 Setting the Country Code

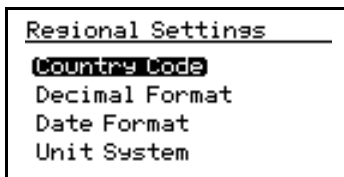

To edit the country code, from the Regional Settings Menu select Country Code and press **Enter**. The following screen appears. A passcode is required to make changes.

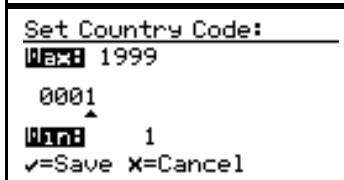

Use the left and right arrow keys to select each digit to be changed. Use the up and down arrow keys to change the value. When finished, press **Enter**. The screen returns to the Regional Settings Menu.

- **Country Codes** = international telephone country codes.
- **Default** = 1 for U.S.
- **Option** = 81 for Japan is available to conform to METI requirements.

## 4.6.2 Setting the Decimal Format

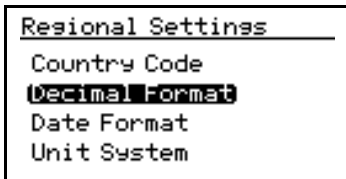

The Decimal Format option determines whether a decimal [.] or a comma [,] is used as the decimal separator. To edit the decimal format, from the Regional Settings Menu select Decimal Format and press **Enter**. The following screen appears.

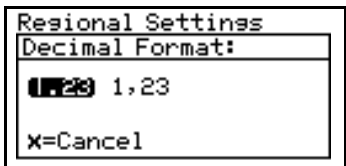

Use the left and right arrow keys to select a decimal [.] or a comma [,] as the decimal separator and press **Enter**. The screen returns to the Display Menu.

## 4.6.3 Setting the Date Format

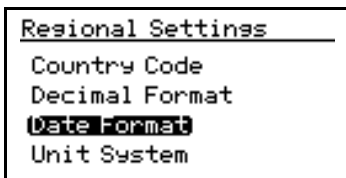

To edit the date format, from the Regional Settings Menu select Date Format and press **Enter**. The following screen appears.

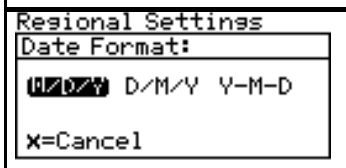

Use the left and right arrow keys to select the desired date format and press **Enter**. The screen returns to the previous display.

## 4.6.4 Setting the Unit System

**IMPORTANT:** *If the Country Code (see “Setting the Country Code” on page 65) has been set to 81 (Japan) the Unit System menu is not available.*

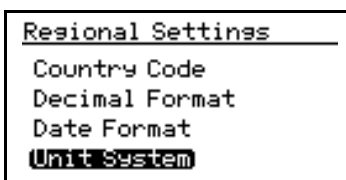

To select the unit system to be used for measurements, select Unit System and press **Enter**. The following screen appears.

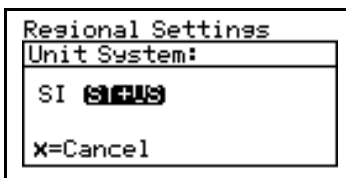

Use the left and right arrow keys to select the Unit System desired [SI = only metric units are available in the selection menus; SI + US = both metric and English units are available in the selection menus] and press **Enter**. The screen returns to the Regional Settings Menu.

**Note:** *Changing the Unit System setting from SI+US to SI in the above menu will NOT immediately change the current Display or Outputs units. This is because it is not possible for the Aurora H2O to know the SI measurement units desired by the operator to replace any currently displayed or output English units. However, the next time the operator selects different Display (see “Selecting Primary Units” on page 40) or Outputs (see “Selecting Output Units” on page 43) units, only SI units will be available in the menu.*

## 4.7 User Calibration

Beginning with software revision H2O.001.F, the **Aurora H2O** supports a two-point User Calibration for use in methane/natural gas. This is provided so that a field calibration can be easily performed to cause the **Aurora H2O** measurement to correspond to a calibration gas or other moisture device. The User Calibration is independent from, and does not affect, the Factory Calibration. The **Aurora H2O** can be quickly switched between User and Factory calibration at any time.

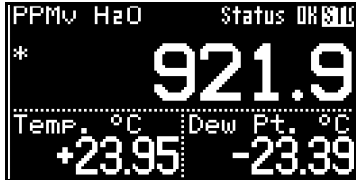

When a User Calibration is active, an asterisk (\*) will appear in the upper left corner of the primary display.

Before the calibration can be performed, the **Aurora H2O** must be operating correctly in methane or natural gas, with methane selected as the Background Gas.

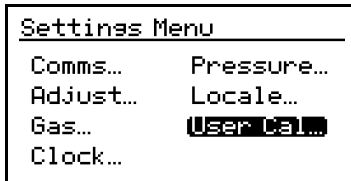

Choose Settings... from the Main Menu. A User Cal... selection is now provided.

**Note:** If the **Aurora H2O** is set for Nitrogen as the background gas, the User Cal selection will be disabled/grayed out.

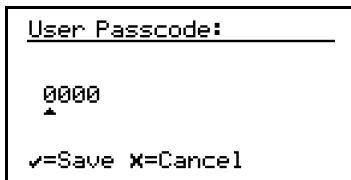

The **Aurora H2O** will prompt for the User Passcode [2719]

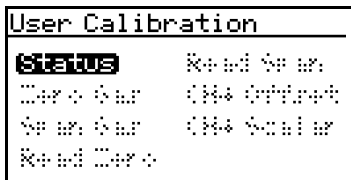

By default, the **Aurora H2O** is operating with the Factory calibration, so the User Calibration Menu is disabled with the exception of the Status selection.

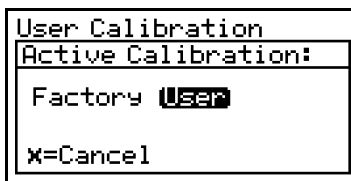

Select Status, and choose User as the Active Calibration.

## 4.7 User Calibration (cont.)

User Calibration	
<b>STATUS</b>	Read Span
Zero Gas	CH4 Offset
Span Gas	CH4 Scalar
Read Zero	

The User Calibration Menu is now enabled.

The selections on the User Calibration Menu include the following functions:

Item	Purpose
Zero Gas	User specifies the water concentration, in PPMv, of the “Zero”, or dry gas.
Span Gas	User specifies the water concentration, in PPMv, of the “Span”, or Cal/Wet gas.
Read Zero	The <b>Aurora H2O</b> will read the signal while exposed to the Zero gas.
Read Span	The <b>Aurora H2O</b> will read the signal while exposed to the Span gas, then determine the CH4 Offset and Scalar calibration values.
CH4 Offset	Permits the user to view/edit the calculated offset term.
CH4 Scalar	Permits the user to view/edit the calculated scalar (gain) term.

Cal Zero Gas:
<b>Max:</b> 50.0
15.0 PPMv
<b>Min:</b> 0.0
✓=Save X=Cancel

First select the Zero Gas and Span Gas items, to specify the cal gases to be used. The zero gas must be in the range of 0.0 to 50.0 PPMv water. It is recommended that the zero gas be 10.0 PPMv or higher for best results. The Span gas must be in the range of 0.0 to 5000.0 PPMv water. It is recommended that the Span gas be 500.0 PPMv or lower for best performance.

Cal Span Gas:
<b>Max:</b> 5000.0
0250.0 PPMv
<b>Min:</b> 100.0
✓=Save X=Cancel

Apply the Zero gas, and wait for the **Aurora H2O** reading to stabilize.

Read Zero Gas:
19% Complete

**Note:** *The user can exit to the display and return to the User Cal Menu without affecting the Calibration procedure.*

Read Zero Gas:
100% Complete
Apply 250 PPMv gas, & select Read Span...
✓=Repeat X=Continue

When the reading is stable, select **Read Zero**. The **Aurora H2O** performs multiple measurements for approximately 15 seconds, indicating its progress. When the readings are complete, you will be prompted to apply the span gas, and continue. If there is doubt about the stability of the zero gas, the reading can be repeated at this point.

## 4.7 User Calibration (cont.)

Apply the Span gas, and wait for the **Aurora H2O** reading to stabilize.

When the reading is stable, select Read Span. The **Aurora H2O** uses the current measurement, and immediately calculates the new calibration. If the calculated values are determined to be valid, the **Aurora H2O** will display "Calibration OK" and prompt you to Save the results, or Cancel. If the values are not valid, the Aurora will display "Calibration \*FAILED\*", and prompt you to continue. On a cal failure or Cancel, no change is made to the User Calibration values.

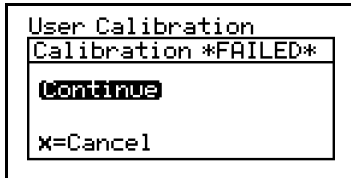

The CH4 Offset and CH4 Scalar items can be used to view or modify the calculated calibration points, if desired.

**Note:** *The default values for the CH4 Offset is 0.0 and the CH4 Scalar is 1.0. These defaults are NOT the same as the Factory Calibration! Making the User Cal active without performing the actual calibration will adversely affect the accuracy of the **Aurora H2O**. If there is any doubt about the quality/accuracy of the gases used, the **Aurora H2O** should be returned to the Factory calibration using the Status item.*

## 4.8 Service Settings



**CAUTION!** The *Service Settings Menu* should be used by factory-trained personnel only.

## 4.9 Aurora H2O Information

```

Main Menu
-----
Display...  Service...
Outputs...  About...
Alarm...   LOCK
Settings...
  
```

To check the **Aurora H2O** information, from the Main Menu select About and press **Enter**. The following screen appears.

### 4.9.1 Checking the ID

```

About Aurora
-----
ID
System Status
Software Versions
Gas Composition
  
```

To check identification information, select ID and press **Enter**. A screen similar to the following appears.

```

Menu: X
GE Sensing Aurora/H2O
Copyright © 2008
General Electric Co.
Unit SN:
Laser SN: Unknown.
  
```

To return to the About Menu, press **Enter**.

### 4.9.2 Checking the System Status

```

About Aurora
-----
ID
System Status
Software Versions
Gas Composition
  
```

To view the status of the **Aurora H2O** system, from the About Menu select System Status and press **Enter**. A screen similar to the following appears.

```

Menu: X
Uptime: 0d 00h
Started: 5/11/2009 14:07
Start Temp: 24.32 °C
Laser Hours: 1399
  
```

**Uptime:** is the elapsed time since the **Aurora H2O** was powered on or reset.  
**Started:** is the date and time that the **Aurora H2O** was last powered on/reset.  
**Start Temp:** is the laser housing temperature as measured at the last startup/reset.  
**Laser Hours:** indicates the total lifetime that the laser has been energized.

To return to the About Menu, press **Enter**.



### 4.9.3 Checking the Software

```
About Aurora
-----
ID
System Status
Software Versions
Gas Composition
```

To view the software versions being used, from the About Menu select Software Versions and press **Enter**. A screen similar to the following appears.

```
Menu: X
-----
BOOT: 1.C
PROG: H20.196.A
```

To return to the About Menu, press **Enter**.

### 4.9.4 Checking the Gas Composition

```
About Aurora
-----
ID
System Status
Software Versions
Gas Composition
```

To view the gas content, from the About Menu select Gas Composition and press **Enter**. A screen similar to the following appears.

```
Menu: X
-----
Standard
  CH4: 90.0%
  N2: 6.0%
  CO2: 4.0%
```

To return to the About Menu, press **Enter**.

### 4.9.5 Checking the Alternate Gas Composition

The **Aurora H2O** TDLAS is normally calibrated to a standard gas mixture that is representative of “typical” natural gas. The primary components and concentrations of this gas mixture are as follows:

Component	Concentration
Methane (CH <sub>4</sub> )	90.0%
Nitrogen (N <sub>2</sub> )	6.0%
Carbon Dioxide (CO <sub>2</sub> )	4.0%

For special applications, where the composition of the gas to be measured differs significantly from the standard, GE can provide an alternate calibration. If this service has been ordered, the **Aurora H2O** will be shipped from the factory with both the standard and a custom calibration installed.

Main Menu	
Display...	Service...
Outputs...	<b>About...</b>
Alarm...	LOCK
Settings...	

The calibration in use can be verified at any time using the **Aurora H2O** About... menu. From the Main Menu, select About and press **Enter**. The following screen appears.

About Aurora	
ID	
System Status	
Software Versions	
<b>Gas Composition</b>	

From the About Aurora menu, select Gas Composition and press **Enter**. The following screen appears.

An identifier label for the gas composition will be displayed above the components:

Menu: X	
Standard	←
CH4: 90.0%	
N2: 6.0%	
CO2: 4.0%	

Gas Composition Identifier

## 4.10 Locking/Unlocking the Display



To lock the **Aurora H2O** against any future changes, from the Main Menu select Lock and press **Enter**. The screen returns to the standard display.

**Note:** *This menu option is the same as exiting the programming menu and waiting for a keypad time-out to lock the keypad.*

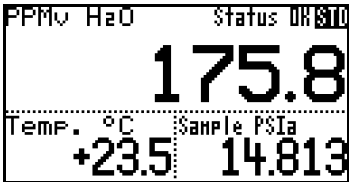

To unlock the **Aurora H2O** for changes, press **Cancel**, **Enter**, **Cancel** as instructed in “Unlocking the Keypad” on page 38.

[no content intended for this page]

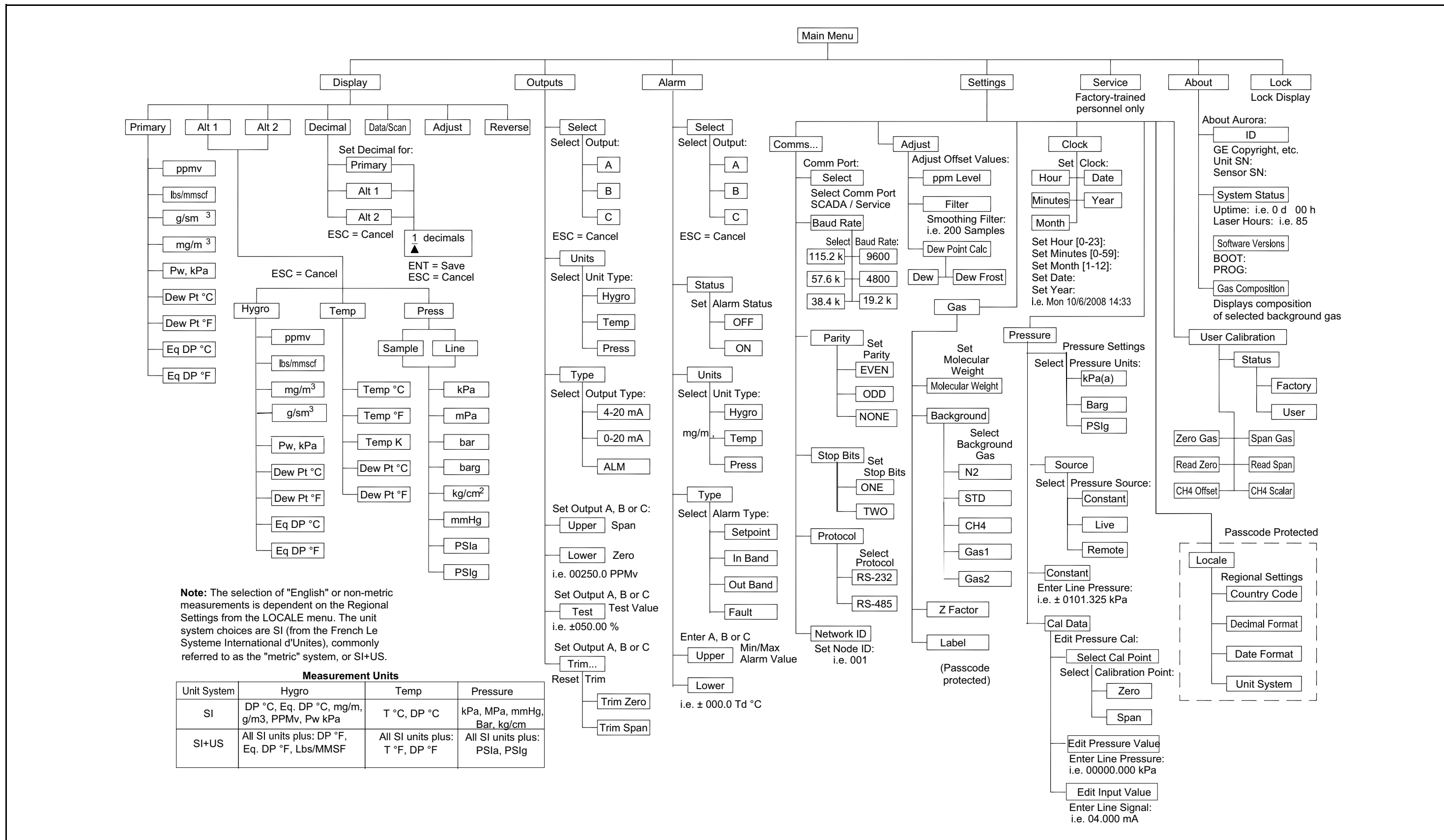

Figure 45: Programming Menu Map

[no content intended for this page]

## Chapter 5. AuroraView Interface Software

### 5.1 Capabilities

Your Aurora H2O Analyzer is shipped with a CD which includes a PC-Software Application called **AuroraView**. With **AuroraView**, you can:

- View **Aurora H2O** Configuration Items such as Alarms & Outputs.
- Use the DataLog function to copy data to a comma delimited .txt file which can be opened by spreadsheet applications such as Microsoft Excel.
- Plot real-time data for one or more **Aurora H2O** parameters
- Manipulate plotted data in a variety of ways such as: color, line type, zoom in/out, etc.
- Trend tabular data in real-time.
- Show Scan Plots of the moisture absorption spectra.
- Copy plots from **AuroraView** to other Window applications like Microsoft Powerpoint or Word.

**AuroraView** does not provide functionality for the following:

- **Aurora H2O** software updates.
- Save the **Aurora H2O** Configuration. The **Aurora H2O** has a robust design which allows the meter to recover from fault conditions without the need to upload the configuration of the meter using external software.

### 5.2 Requirements

**AuroraView** leverages a *National Instruments Run-Time* environment. This environment is supported on the following operating systems with the minimum installation requirements indicated:

- 260 MB of available hard disk space
- 64 MB of RAM or more
- 300 MHz Pentium CPU
- Windows NT 4.0 SP6 or higher, Windows ME, Windows 2000, Windows XP
- Internet Explorer v5.0 or higher

**AuroraView** supports the following serial interfaces:

- RS232
- RS485 Modbus

## 5.3 Installing AuroraView

1. Insert the *Installation CD* into the optical drive on your PC.
2. The installation program should launch automatically (see *Figure 46* below). If it does not, select Start → Run → Browse.

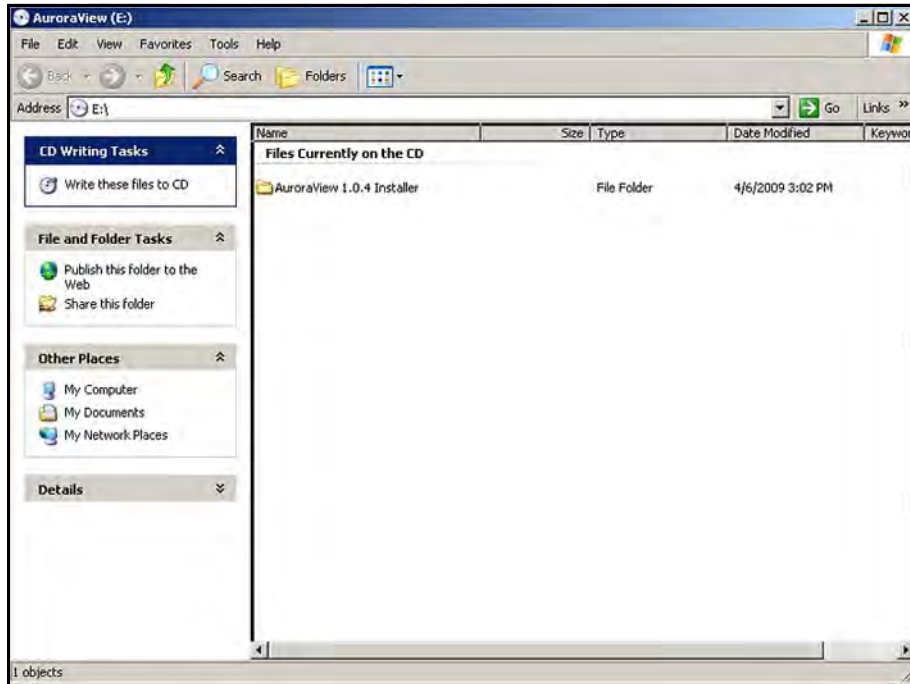

Figure 46: Initial Screen



## 5.3 Installing AuroraView (cont.)

3. Browse to the file named “*setup.exe*” in the root directory of the CD (see *Figure 47* below). Double-click the file to start the installation.

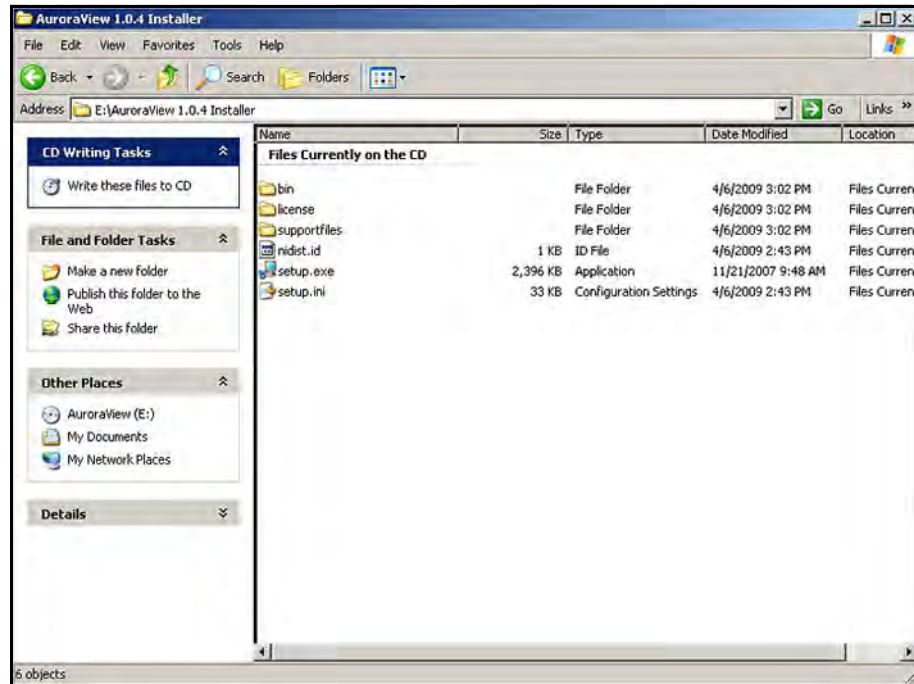

Figure 47: AuroraView Installer

### 5.3 Installing AuroraView (cont.)

4. Exit all other programs before running the installer (see *Figure 48* below).

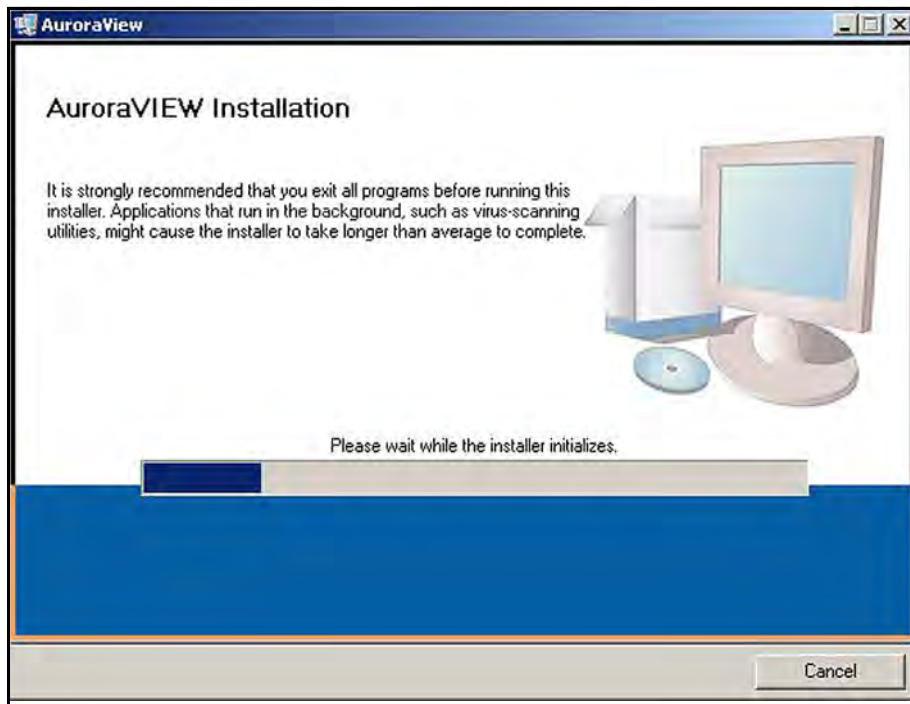

Figure 48: Installation Recommendation

### 5.3 Installing AuroraView (cont.)

- The next screen (see *Figure 50* below) provides the opportunity to change installation locations if desired. When ready, click Next.

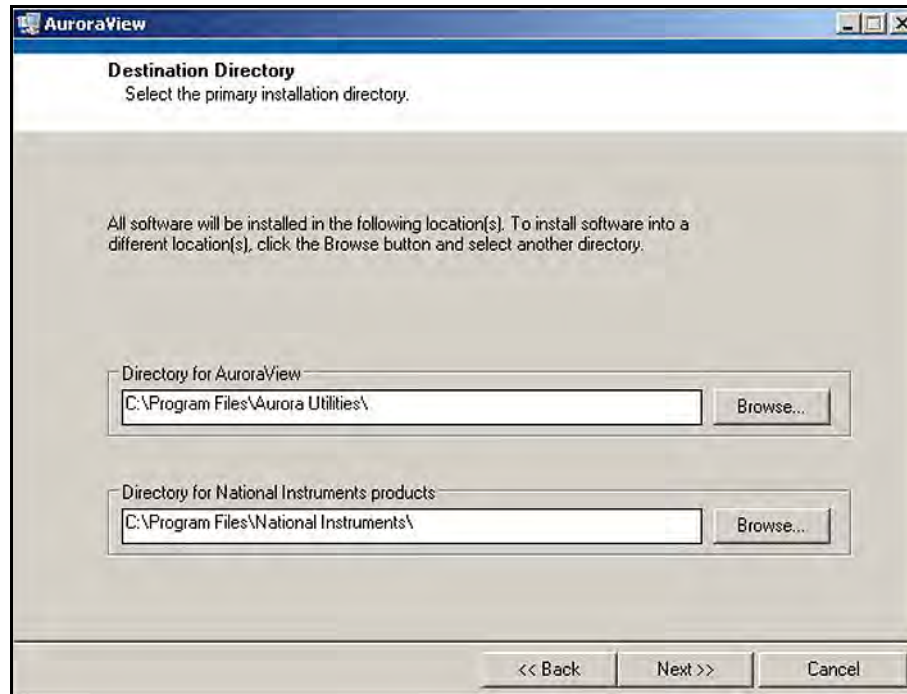

Figure 49: Destination Directory

- At the next screen, accept the *Software License Agreement* (see *Figure 50* below) and click Next.

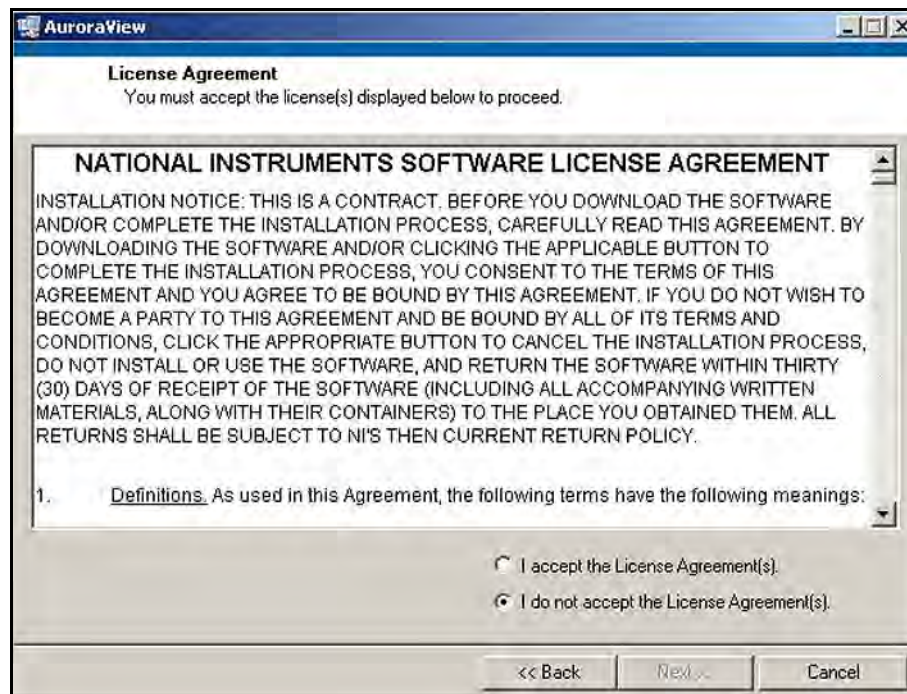
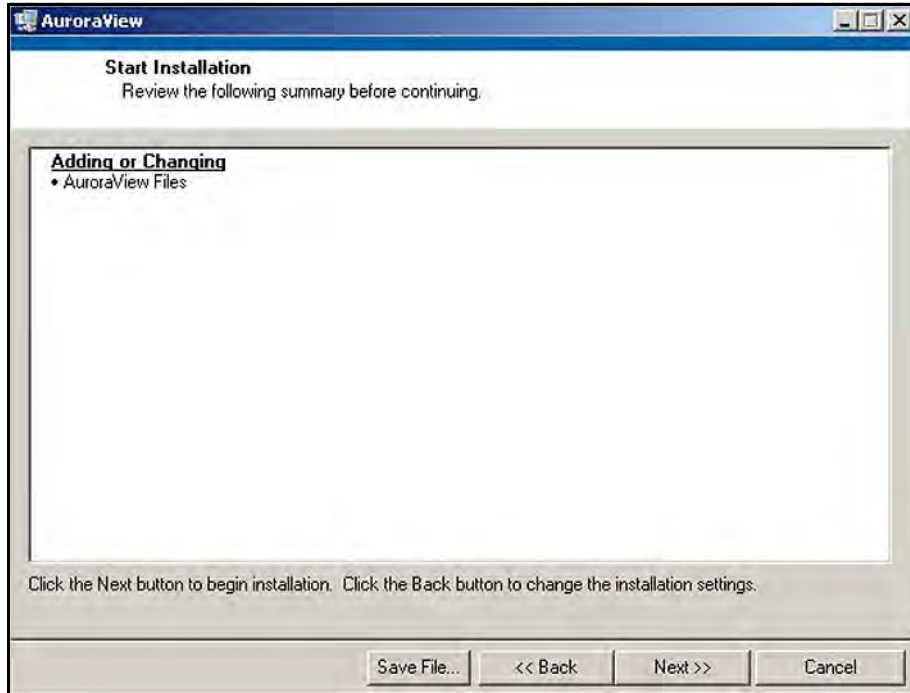

Figure 50: Software License Agreement

### 5.3 Installing AuroraView (cont.)

7. The next screen (see *Figure 51* below) provides instructions for initiating the installation. When ready, click Next to begin.



**Figure 51: Starting the Installation**

### 5.3 Installing AuroraView (cont.)

8. During installation, the screen shown in *Figure 52* below appears.

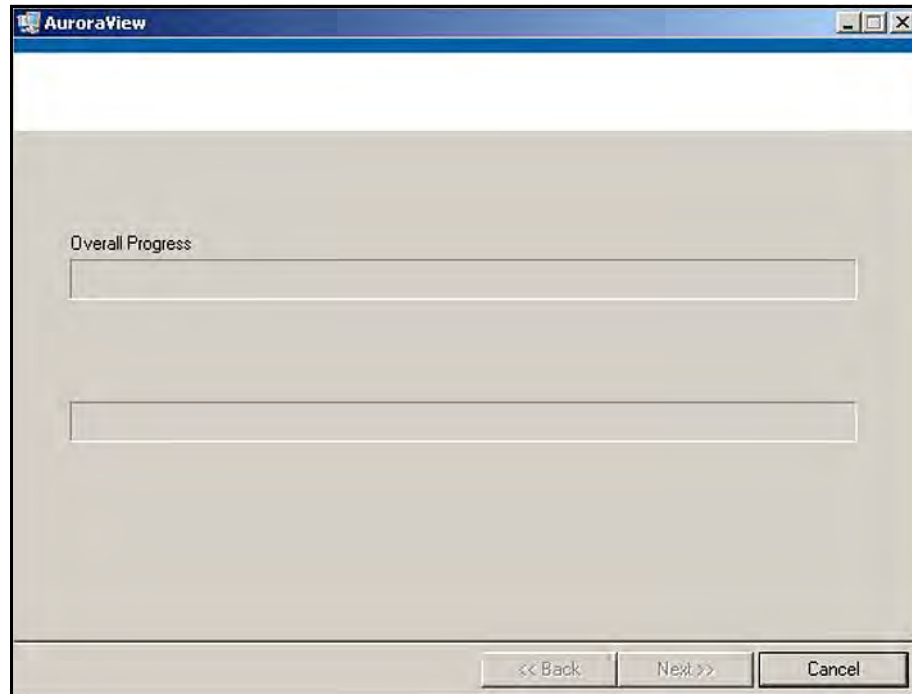

Figure 52: Overall Progress

### 5.3 Installing AuroraView (cont.)

9. The screen shown in *Figure 53* below appears when the installation is complete.

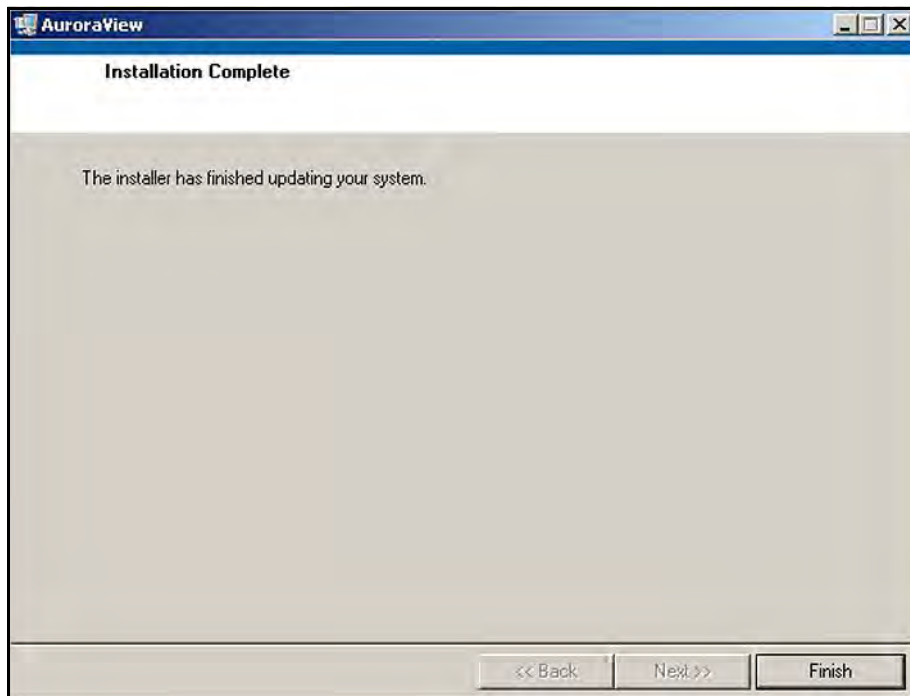

Figure 53: Installation Is Complete

## 5.4 Starting AuroraView

1. From the Start menu, click Programs → AuroraView → AuroraView (see *Figure 54* below).

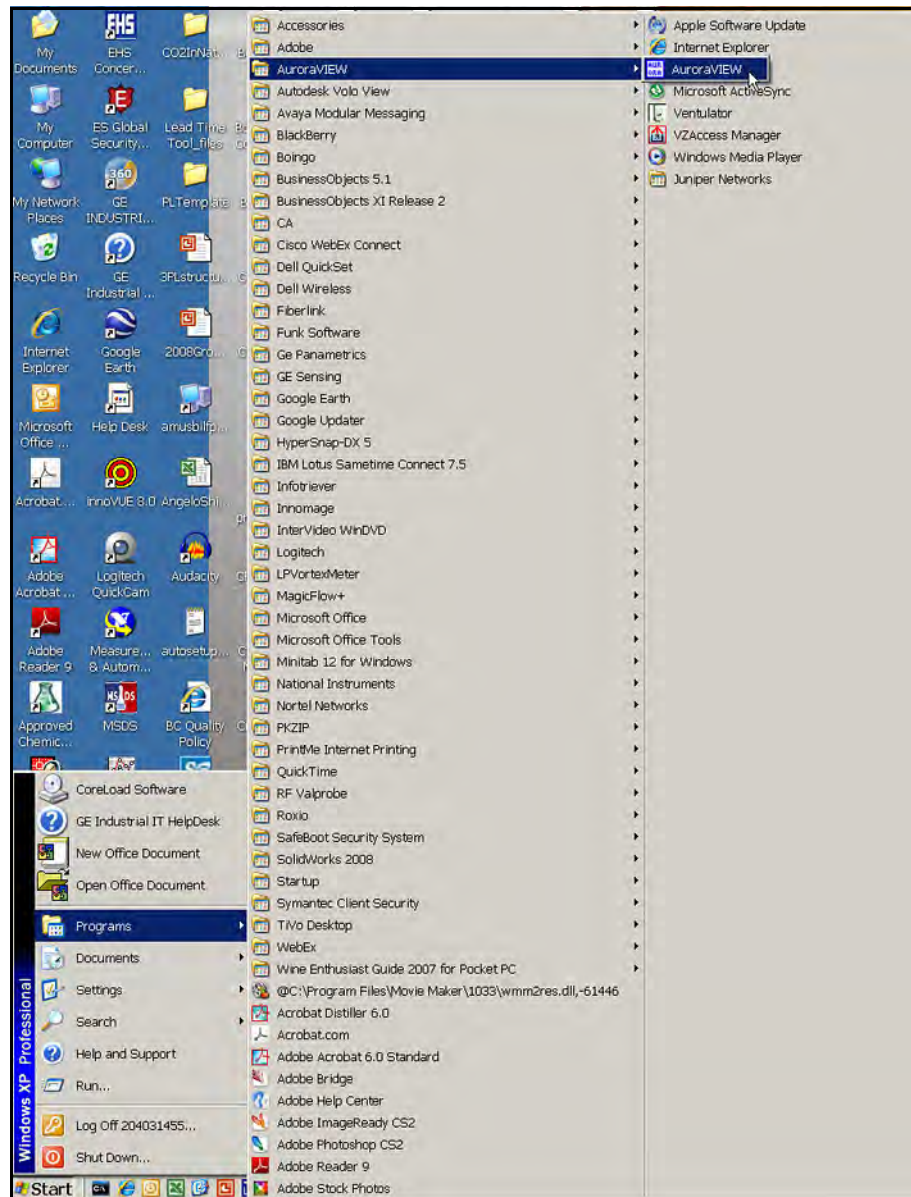

Figure 54: AuroraView in Programs Menu

## 5.4 Starting AuroraView (cont.)

- AuroraView boots up and displays a screen similar to *Figure 55* below.

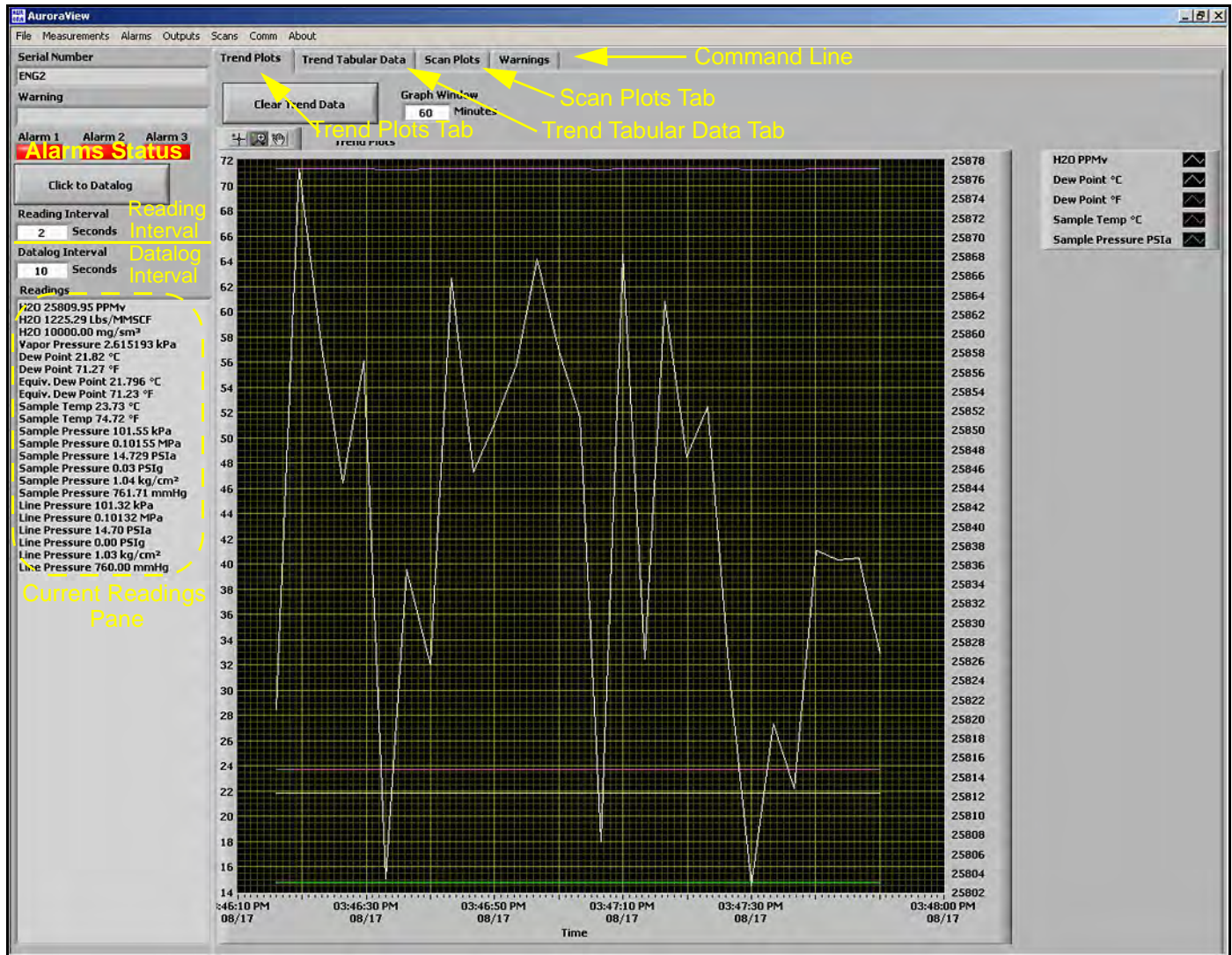

Figure 55: AuroraView Main Screen



## 5.5 Using the Main Menu

1. Click Measurements → Config (see *Figure 56* below).

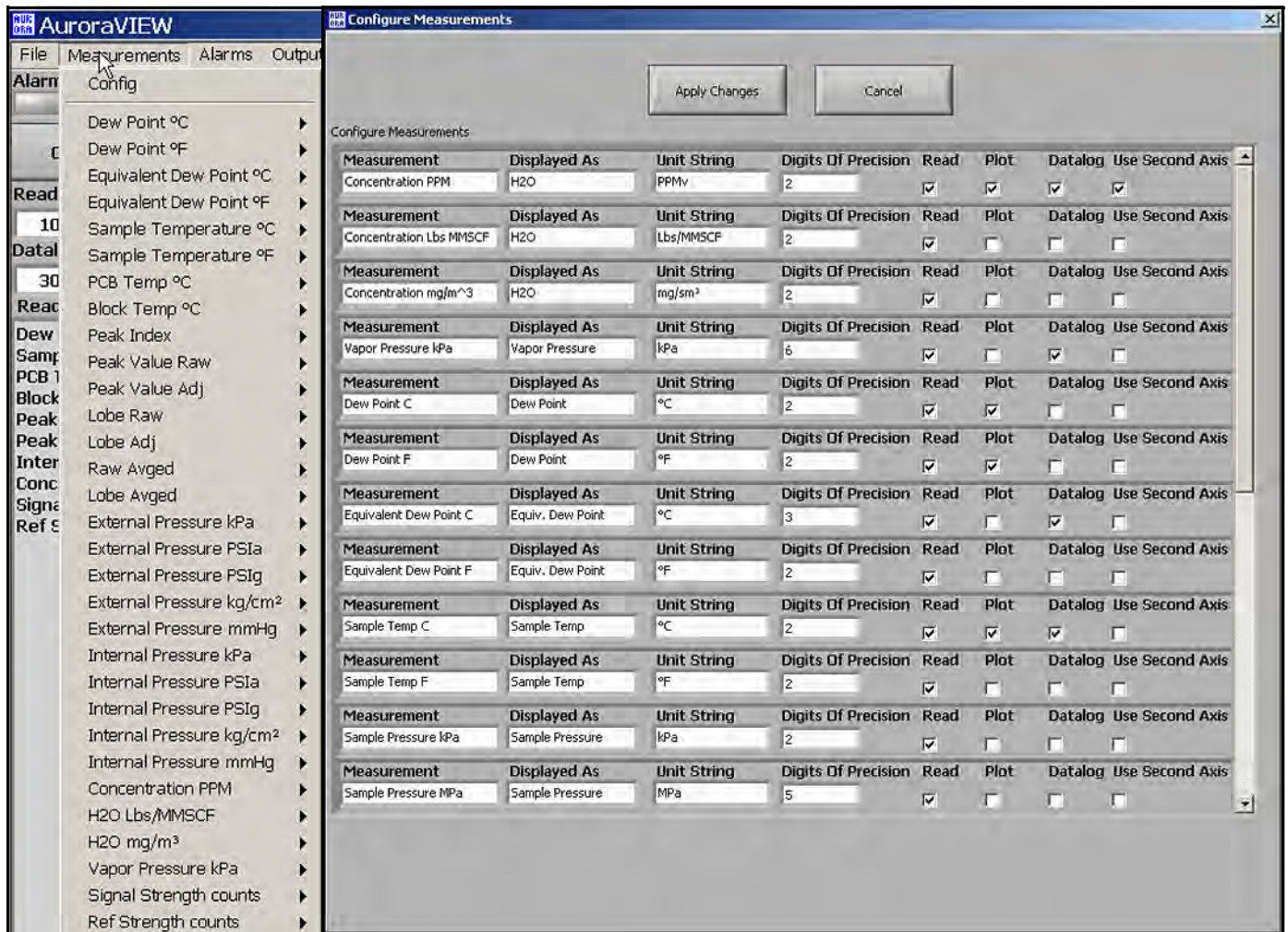

Figure 56: Configuration Measurements

- Unit String: Set this value to the value you want to read, plot or datalog.
- Digits of Precision: Set a numerical value (typically 0, 1, 2). This sets the resolution of the displayed measurement units to the right of the decimal place (i.e., “20.78” would result from a setting of “2”).
- Read: Check this box if you want to show the value in the current Readings pane.
- Plot: Check this box if you want to show the value in the Trend Plots graph AND the Trend Tabular Data tab.

## 5.5 Using the Main Menus (cont.)

**Note:** *The other options under MEASUREMENTS are for individual unit types and perform the same function as checking a box under the CONFIG pop-up window (see Figure 57 below).*

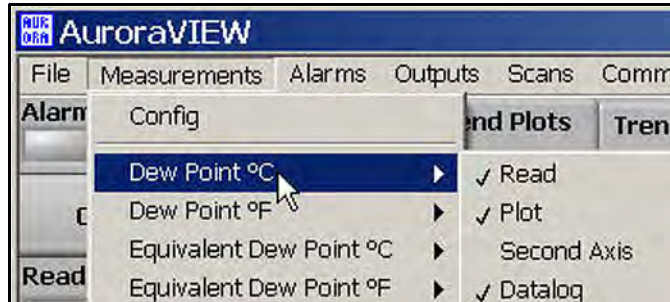

Figure 57: Other Measurement Options

2. Click Alarms → Config

This window enables the user to configure the alarm status within the **AuroraView** application. This feature allows you to remotely configure **Aurora H2O** alarms, which are used only with Modbus RTU digital output. The **AuroraView** Alarms are shown in *Figure 58* and *Figure 59* below and *Figure 60* on page 89.



Figure 58: Alarms Configuration

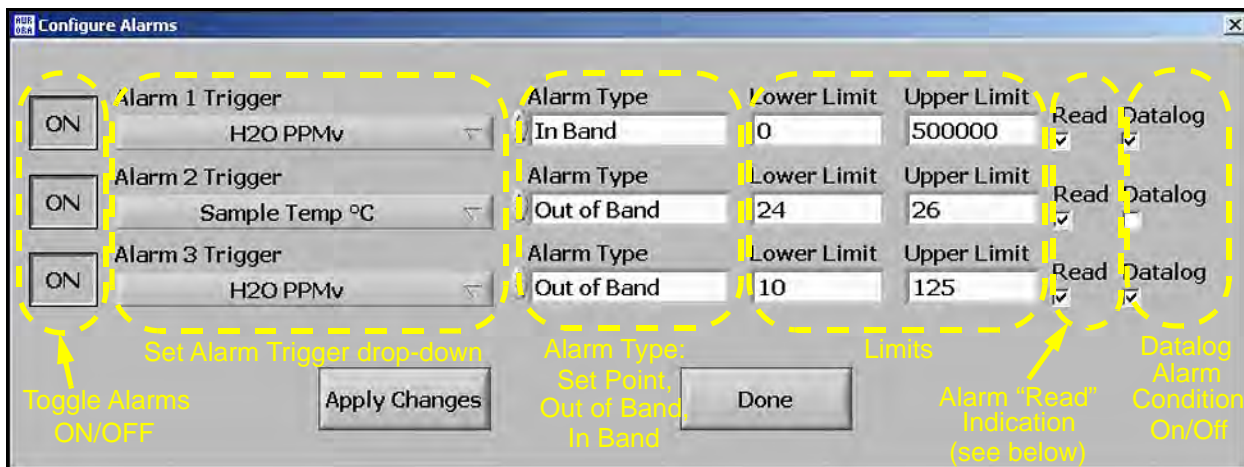

Figure 59: Other Measurements Options

## 5.5 Using the Main Menus (cont.)



Figure 60: Alarm Status Indicators

3. Click Outputs → Config (see *Figure 61* and *Figure 62* below).



Figure 61: Outputs Configuration

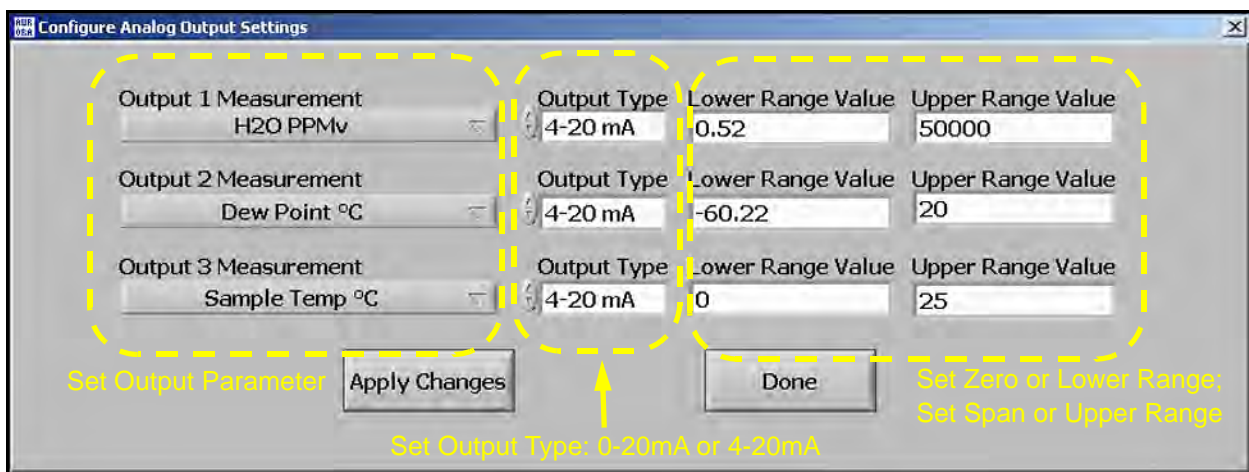

Figure 62: Other Output Options

## 5.5 Using the Main Menu (cont.)

### 4. Click Scan

This section enables you to pick the desired type of scan. The default scan is the SPECTRA scan, which shows the 2f spectral scan. This is the processed signal waveform that the **Aurora H2O** uses to determine the moisture concentration. Viewing this scan may assist in troubleshooting. A typical 2f spectra scan is shown in *Figure 64* below. Select the scan interval in minutes to set the refresh rate at which **AuroraView** updates the scan plot. To enter a scan interval, click on the Click to Save Scans Periodically button, and the screen shown in *Figure 63* below appears. Enter the interval and click on Continue to save or Cancel to reject the change.

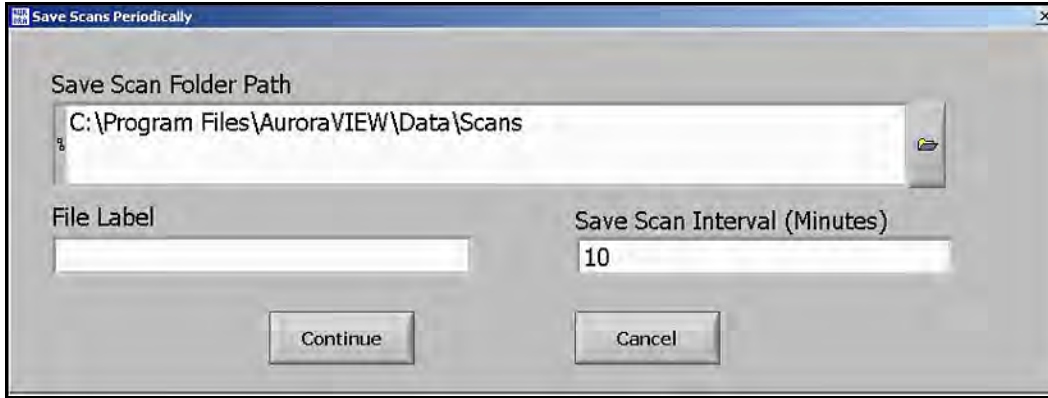

Figure 63: Save Scans Periodically

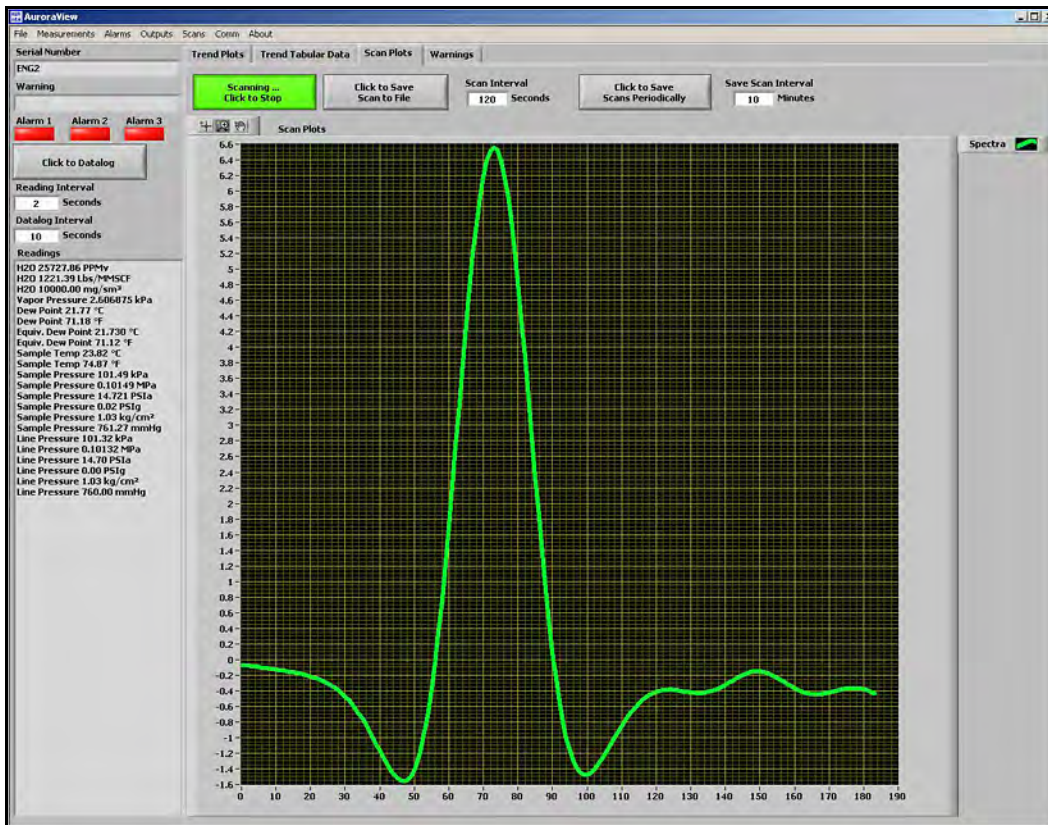

Figure 64: Scan Plot Tab

## 5.5 Using the Main Menus (cont.)

### 5. Click Comms

This window (see *Figure 65* below) enables you to configure communication options. If you have more than one **Aurora H2O** on your network, you will have to establish different NETWORK ID's for each analyzer using the main keypad on the **Aurora H2O**. For your PC system, you will have to select which comm port to use. This is typically COM1. The default baud rate is 115200 baud.

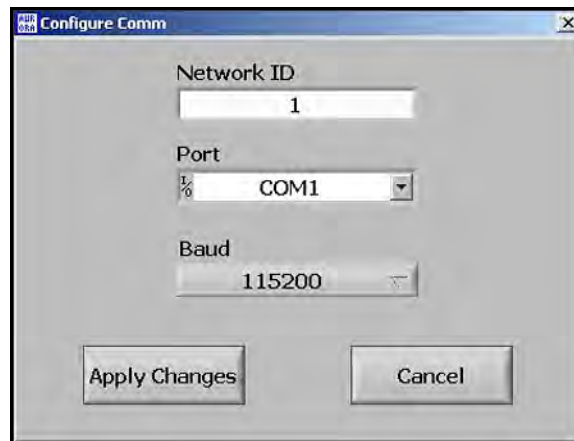

Figure 65: Configure Communication Options

### 6. Click Help (see *Figure 66* below).

This screen indicates the revision level of **AuroraView**.



Figure 66: Software Information

## 5.6 Datalogging with AuroraView

1. In the main view (see Figure 67 below), click on the button Click to Datalog.

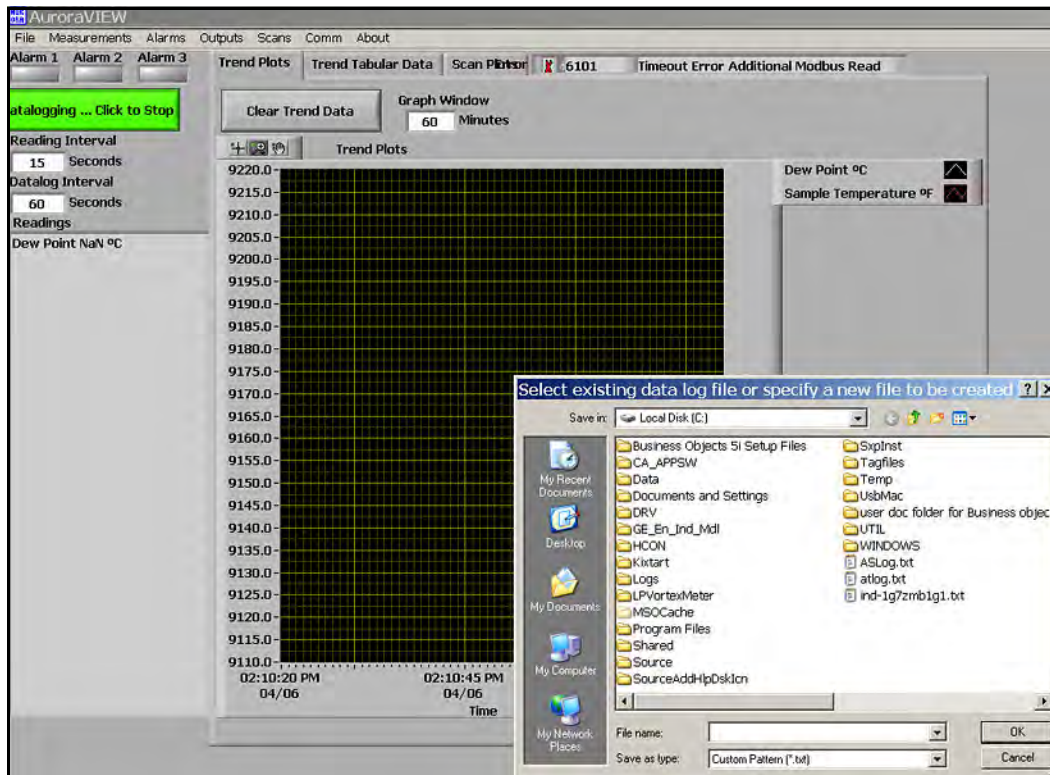

Figure 67: Datalogging with AuroraView

2. **AuroraView** will request a file location. Pick a file location and a file name to save your data log file. All data log files are comma delimited .txt files by default.
3. Once you pick a file location, **AuroraView** will write any parameter that has a check box with Datalog checked in the main Config window at the time interval set in the Datalog Interval box, and the button in the main window will change to Datalogging...Click to Stop.
4. When you are done datalogging, click the button to stop logging. You may now open your .txt datalog file in any application, such as Microsoft Excel, so that you can analyze that data.

**Note:** When datalogging multiple parameters at intervals of five seconds or less, it is recommended to use baud rates of 57.6K or 115.2K.

## 5.7 Working with Trend Plots, Trend Tabular Data and Scan Plots

1. Trend Plots is a powerful graphing feature in **AuroraView**. You can graph many parameters at the same time (see *Figure 68* below).

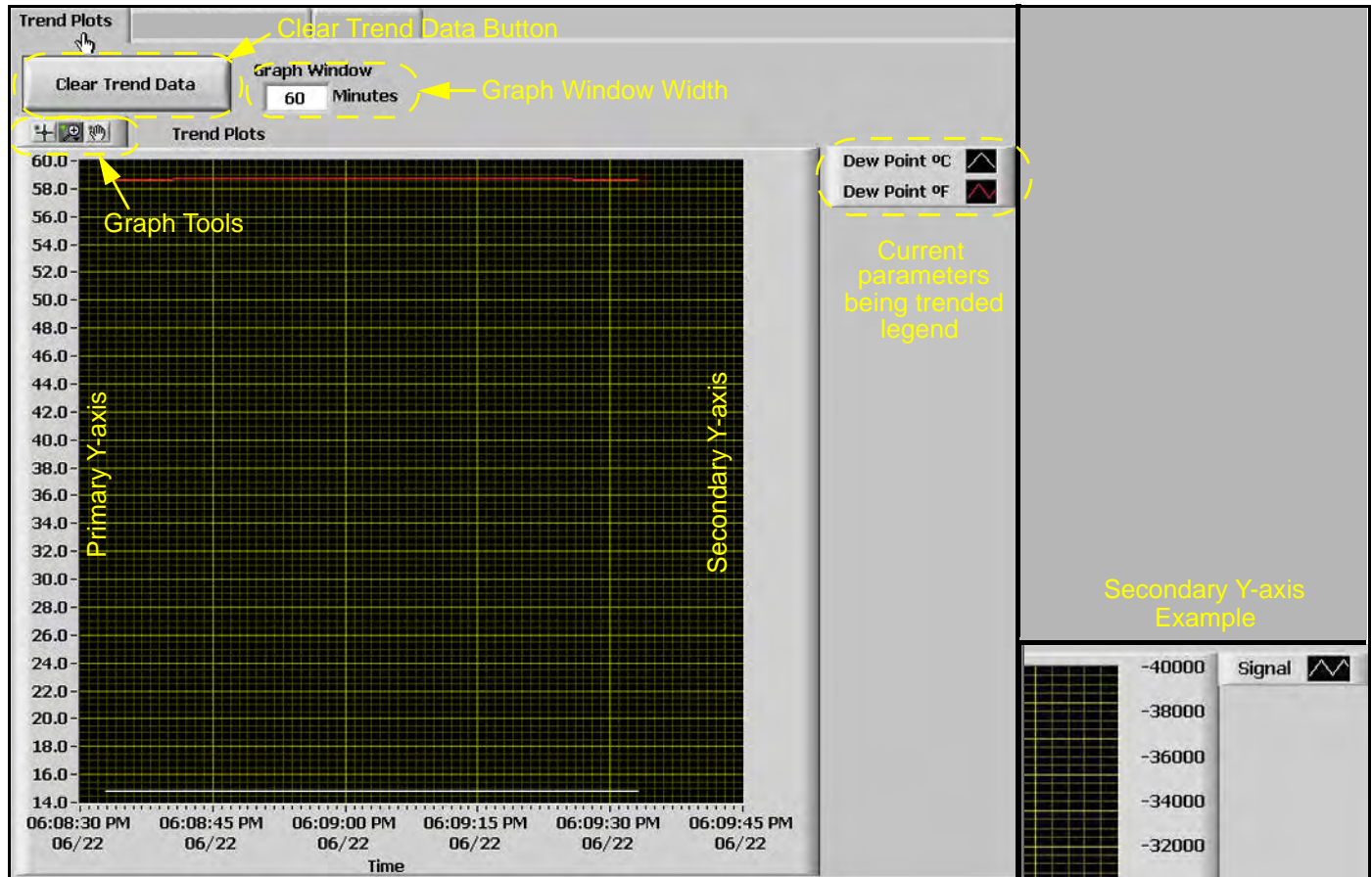

Figure 68: Using Trend Plots

**Note:** If you use the secondary y-axis, you may see “-” tick marks preceding the value. These are tick marks from the graphical applet and not an indication of negative values.

## 5.7 Working with Trend Plots, Trend Tabular Data and Scan Plots (cont.)

- If you right-click on any series of data within the graph, or you click on the current parameter being-trended item in the legend, you will see a variety of options for graphing data (see *Figure 69* below). You can change to a variety of common plots and adjust color, line style, and line width. For some data sets with lots of finite points, you may want to click Anti-Aliased which will smooth the plot line. You can also change bar plots, fill base line, interpolation and point style. X-Scale adjusts the x-scale. Y-Scale adjusts the y-scale and enables the secondary y-axis.

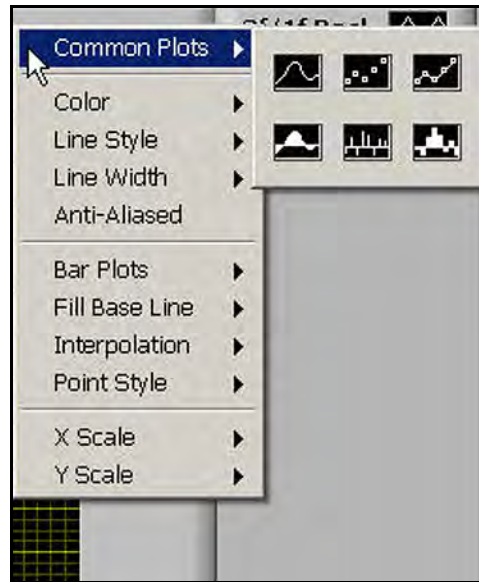

Figure 69: Options for Graphing Data

- There is a series of Graph Tools available at the top left of the trend plot area (see *Figure 70* below).



Figure 70: Graph Tools

- Pointer
- Zoom Tool - gives you six options as shown in *Figure 71* below.
- Hand Tool - Enables you to graph the trend plot area and move it around without rescaling.

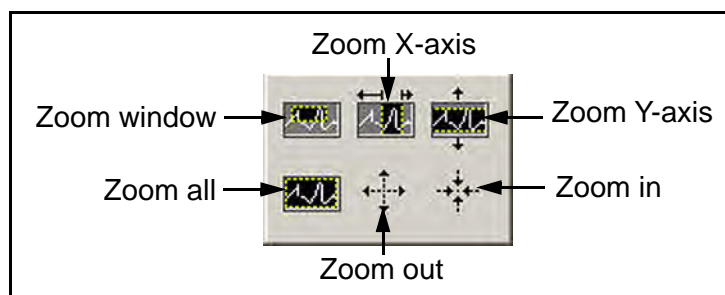

Figure 71: Zoom Tool



## 5.7 Working with Trend Plots, Trend Tabular Data and Scan Plots (cont.)

4. Copying and Pasting a Trend Plot can be done from **AuroraView** (see *Figure 72* and *Figure 73* below) One way to do this quickly is to simply right click over the data area and choose Copy. In another application, like Microsoft Word, simply paste.

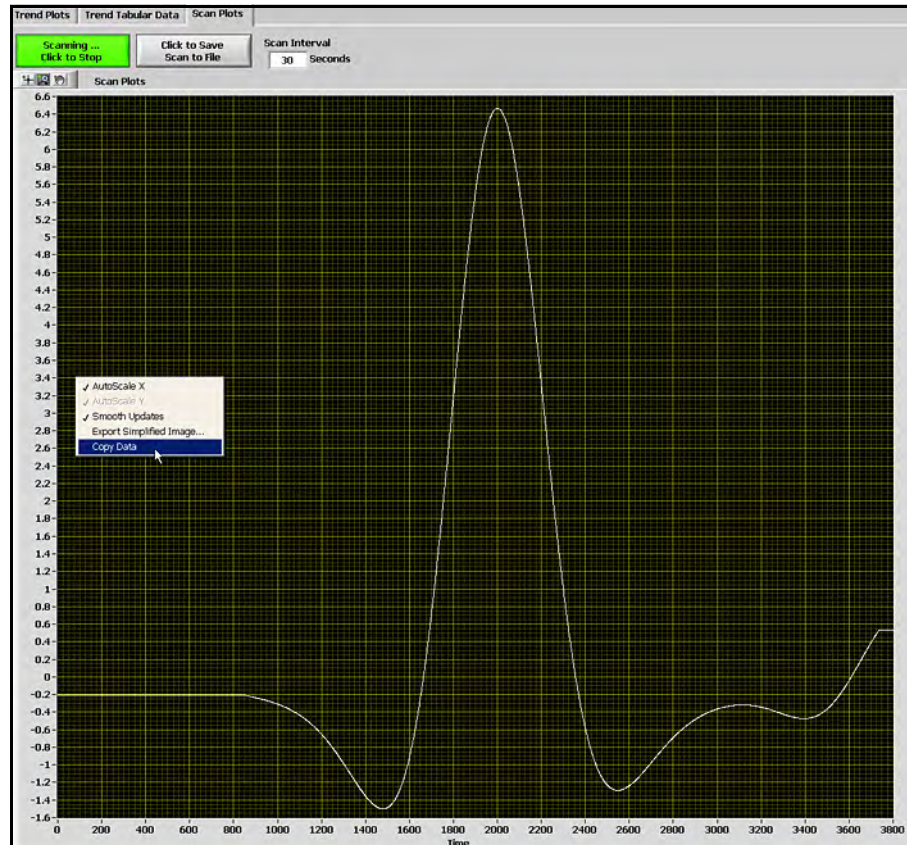

Figure 72: Copying a Trend Plot

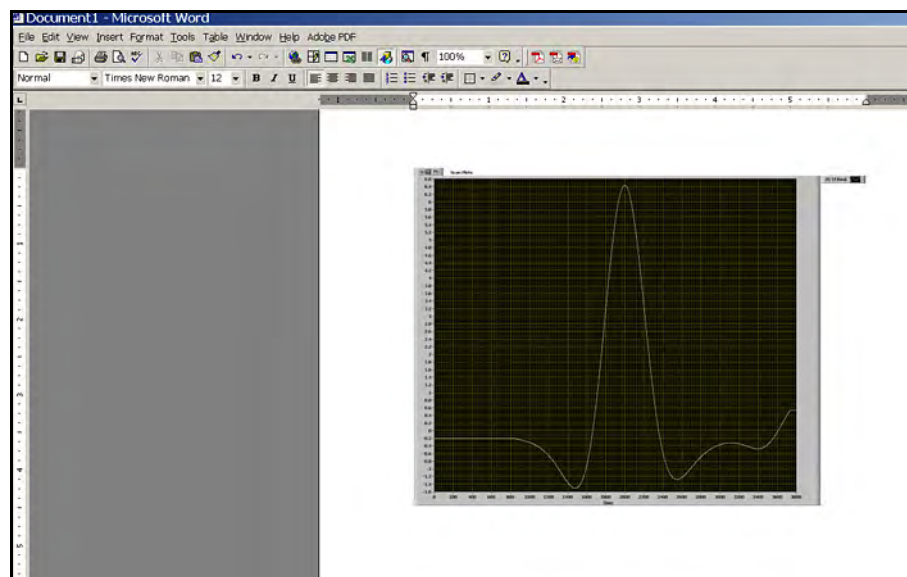

Figure 73: Pasting a Trend Plot

## 5.7 Working with Trend Plots, Trend Tabular Data and Scan Plots (cont.)

Another option is to right-click and chose the option Export Simplified Image (see *Figure 74* below). When you do this, a variety of image file formats will appear. A good universal option is Enhanced Metafile (see *Figure 75* on page 97). Pasting an enhanced metafile will give you the ability to paste an image with an inverted color scheme as shown in the second example posted into Word (see *Figure 76* on page 97).

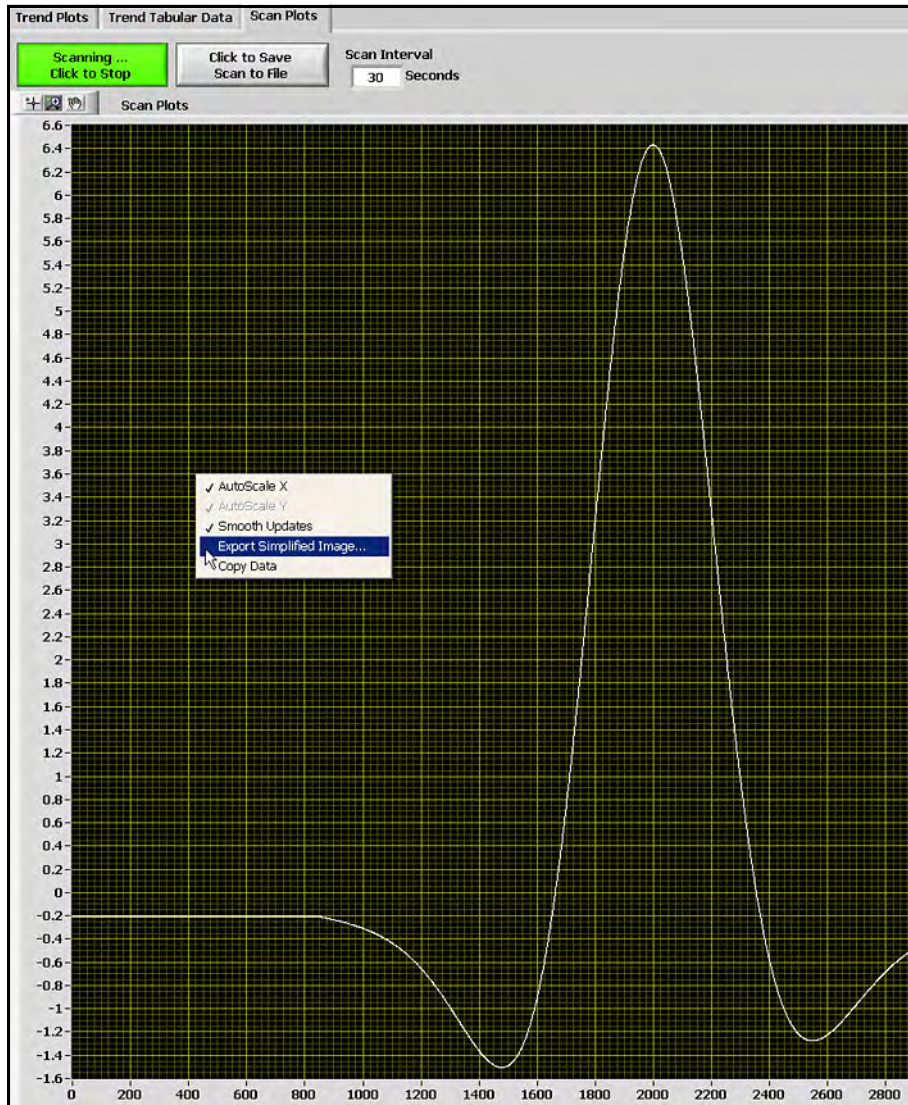

Figure 74: Exporting a Simplified Image

## 5.7 Working with Trend Plots, Trend Tabular Data and Scan Plots (cont.)

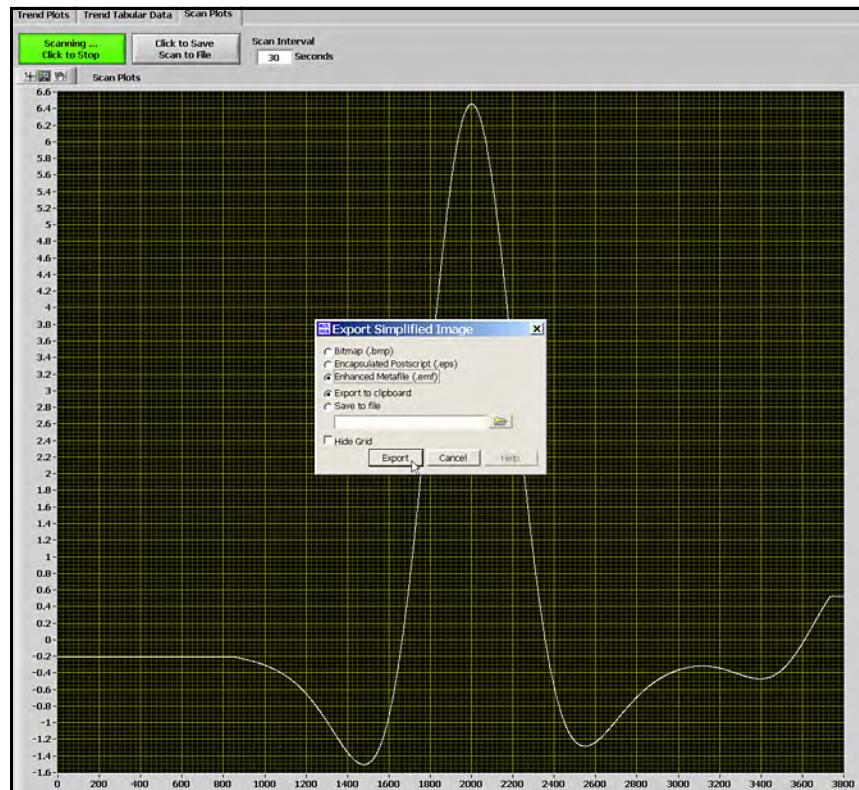

Figure 75: Selecting Enhanced Metafile

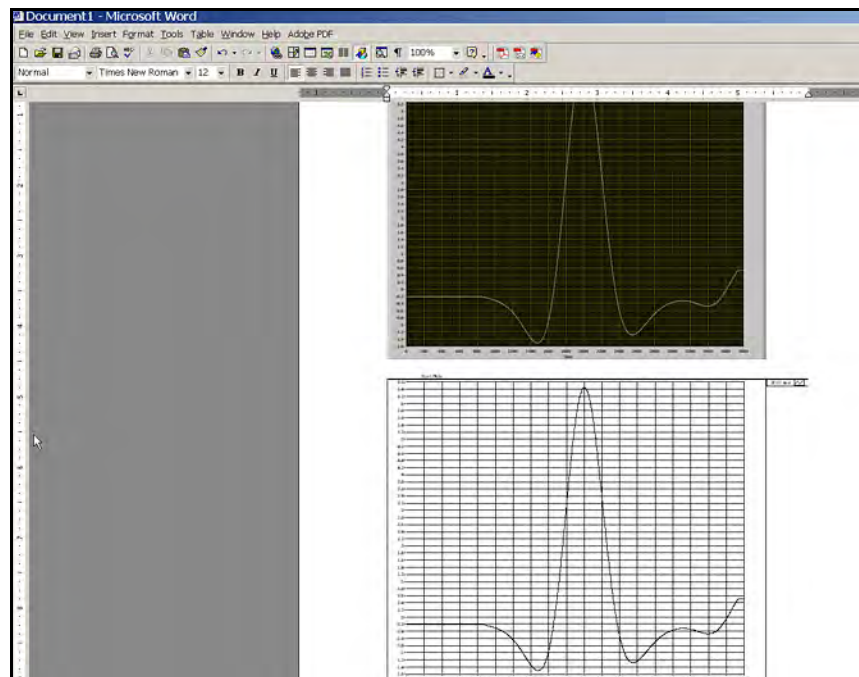
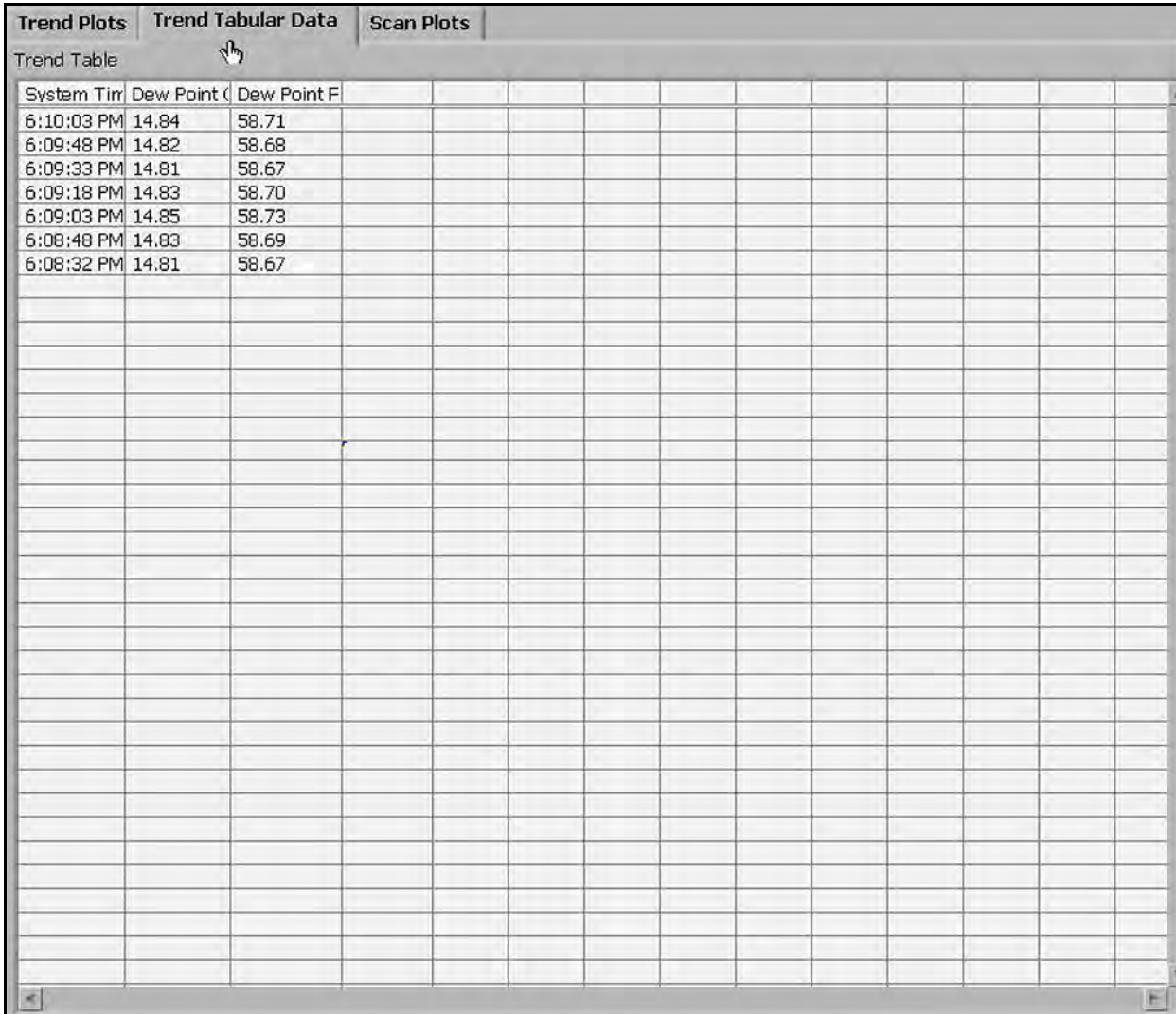

Figure 76: Pasting an Enhanced Metafile

## 5.7 Working with Trend Plots, Trend Tabular Data and Scan Plots (cont.)

Working with Trend Tabular Data, you will be able to see data in tabular format as shown in *Figure 77* below. You can adjust column widths to see data more easily with full titles in the header row.



System Time	Dew Point (C)	Dew Point (F)
6:10:03 PM	14.84	58.71
6:09:48 PM	14.82	58.68
6:09:33 PM	14.81	58.67
6:09:18 PM	14.83	58.70
6:09:03 PM	14.85	58.73
6:08:48 PM	14.83	58.69
6:08:32 PM	14.81	58.67

Figure 77: Trend Data in Tabular Format

## Chapter 6. Maintenance



**CAUTION!** CLASS 1M INVISIBLE LASER RADIATION WHEN OPEN. DO NOT VIEW DIRECTLY WITH OPTICAL INSTRUMENTS.



**WARNING!** Use of controls or adjustments or performance of procedures other than those specified herein may result in radiation exposure that is more hazardous than specified.

### 6.1 Spare Parts

Table 5: Aurora H2O Spare Parts List

Part No.	Description	Qty.
704-688-12	RS-232 Cable; SUB-9-F to Tinned Leads; 12 ft.	1
<b>Aurora H2O Maintenance Kit</b>		
N/A	Plastic Case with Foam Inserts	1
421-3230	Magnetic Stylus	1
240-199	Air Blower	1
403-161	Lens Tissue Package	1
463-030	Replacement Membrane Filter Elements	5
240-201	Allen Wrench, 5/32"	1
240-200	Allen Wrench, 3/32"	1
S40046393	Small Screw Driver	1
403-163	Gloves	4

### 6.2 Cleaning the Mirror

The **Aurora H2O** analyzer may provide the message Weak Signal Return - Check Mirror on the top line of the display, along with the red light “!” to the left of the main display. If this occurs, the mirror and/or the optical window of the measuring cell may be contaminated due to liquid or particulate coating/deposition.

**Note:** *Reagent grade Acetone (Cas no. 67-64-1) may be needed for the cleaning process. The reagent is not supplied as part of the Aurora maintenance kit, and you must obtain the reagent from a local chemical supplier.*

If the error condition Check Mirror is indicated, the first step is to clean the mirror. The process is as follows:

1. Turn the power to the **Aurora H2O** OFF.



**CAUTION!** CLASS 1M INVISIBLE LASER RADIATION WHEN OPEN. DO NOT VIEW DIRECTLY WITH OPTICAL INSTRUMENTS.



**WARNING!** Use of controls or adjustments or performance of procedures other than those specified herein may result in radiation exposure that is more hazardous than specified.

## 6.2 Cleaning the Mirror (cont.)

2. Shut down the gas flow through the optical absorption cell.
  - a. Turn the inlet isolation needle valve (item 4 in *Figure 2 on page 4* or *Figure 3 on page 5*) to the closed position.
  - b. Ensure that the sample flow rotatmeter indicates zero flow.
3. Wear a pair of disposable static dissipative Latex or Nitrile (powder free) gloves.

**Note:** *There are two versions of the Aurora optical absorption cell assembly (see Figure 78 below), each with its own mirror mounting mechanism. The mirror can be removed from the end of this cell for cleaning **WITHOUT DISMOUNTING** the cell. Be sure to follow the correct mirror cleaning procedure for your version of the optical absorption cell assembly.*

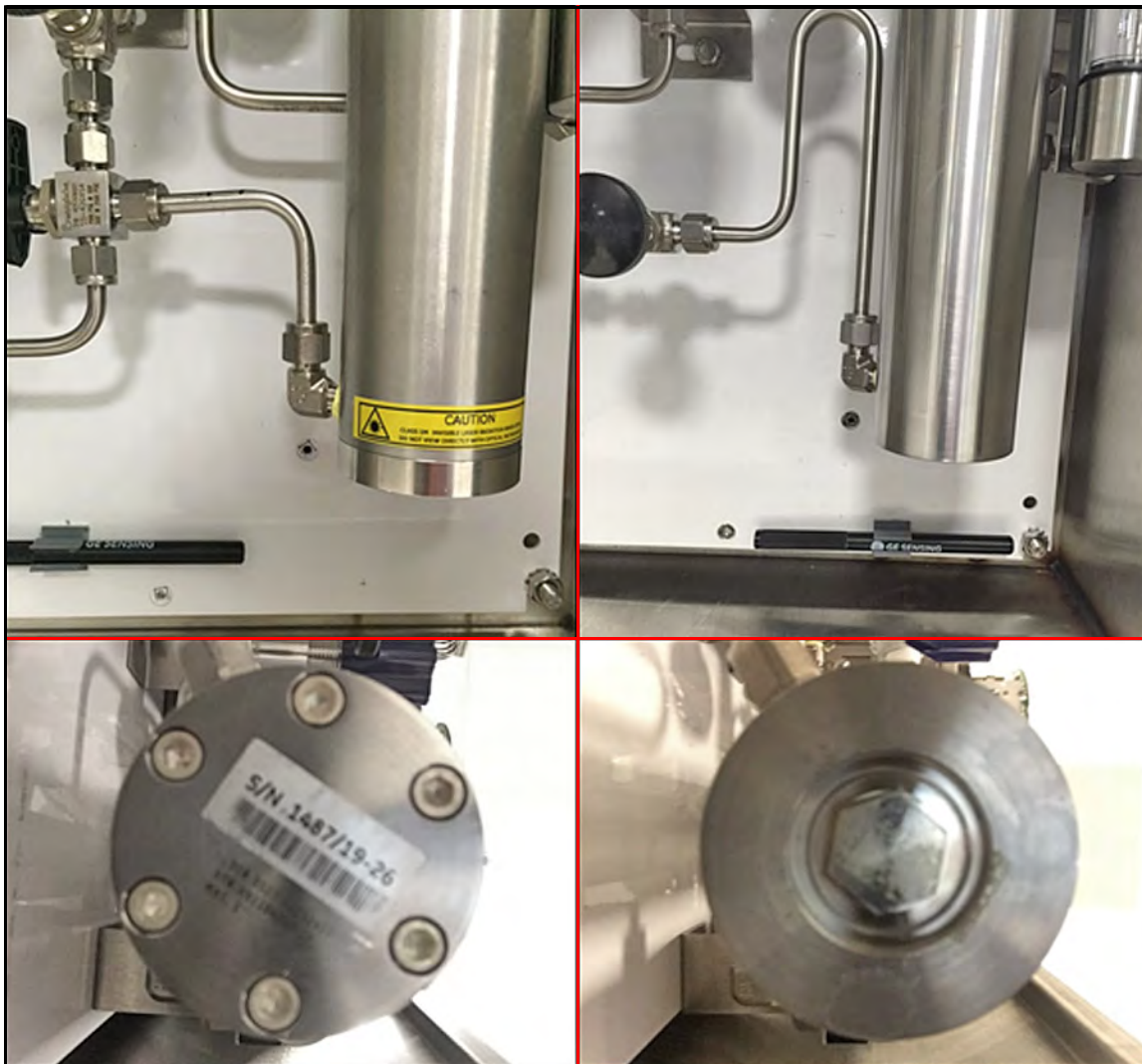

Figure 78: Style 1 (Left) and Style 2 (Right) Optical Absorption Cell/Mirror Assemblies

## 6.2.1 Instructions for Optical Absorption Cell Style 1

**IMPORTANT:** Use the instructions in this section only if you have identified your Optical Absorption Cell as Style 1 in Figure 78 on page 100.

1. Remove the 6 hex bolts securing the mirror (see Figure 79 below) using a 5/32 inch Allen wrench. Hold the stainless steel base of the mirror with one hand while removing the last retaining bolts. The mirror is removed by pulling it straight down. There is one alignment pin (see Figure 80 below) to facilitate proper removal.

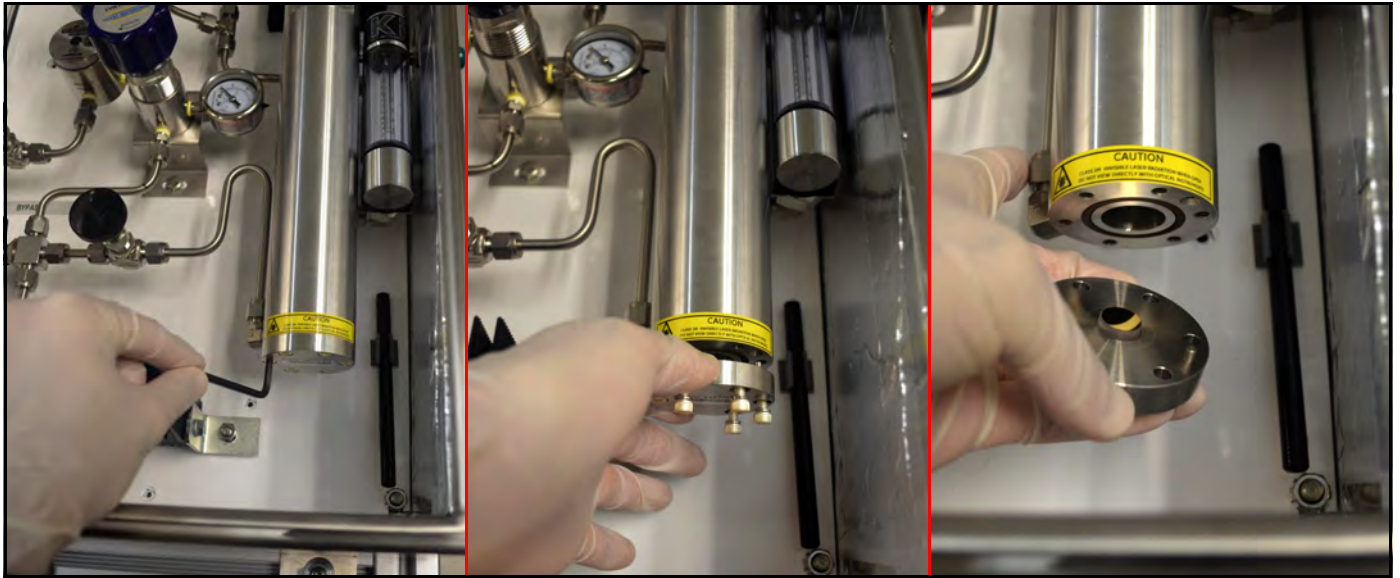

Figure 79: Removing Mirror End Cap Assembly from the Absorption Cell



**CAUTION!** Handle the mirror assembly with extreme care. Performance of the analyzer is critically dependent upon the mirror integrity. Do not touch the mirror surface with any tools, objects, hands or fingers.

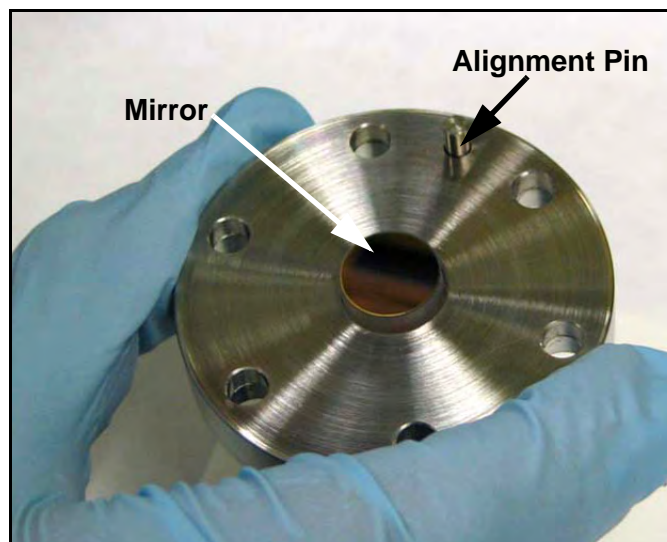

Figure 80: Handling the Mirror Assembly

### 6.2.1 Instructions for Optical Absorption Cell Style 1 (cont.)

2. Make a visual inspection of the mirror surface (see *Figure 81* below). Record any observation of gross contamination. If the mirror appears to be clean, do not clean it. Instead, reinstall it carefully into the system.



**Figure 81: Examining the Mirror**

3. If the mirror is contaminated, the first step in cleaning it is to use the air blower to blow away any particulate matter on the mirror surface. Place the mirror assembly on a flat surface and repeatedly puff the air blower to force dry clean air onto the mirror surface (see *Figure 82* below).

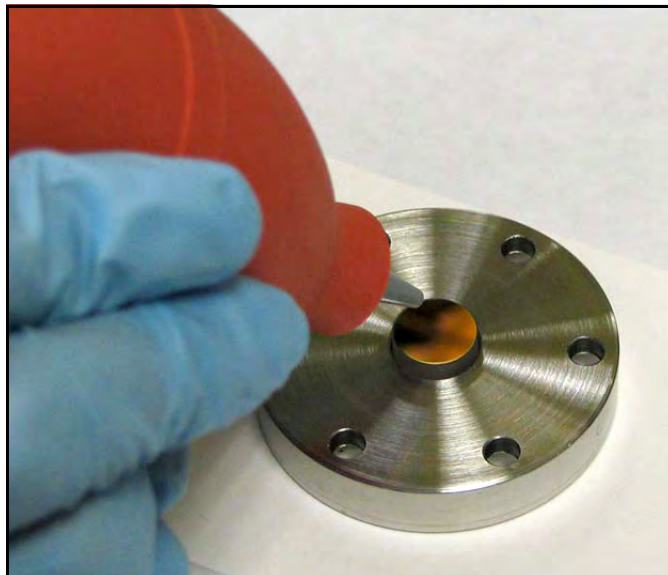

**Figure 82: Blowing Air onto the Mirror**



### 6.2.1 Instructions for Optical Absorption Cell Style 1 (cont.)

- Using a piece of lens tissue, wet a small area with a very small amount of **analytical grade acetone** (barely wet the lens tissue). Typically, one drop of acetone will suffice. Tilt the lens tissue so that the acetone drop is absorbed by the lens paper along the length of the piece (see *Figure 83* below).

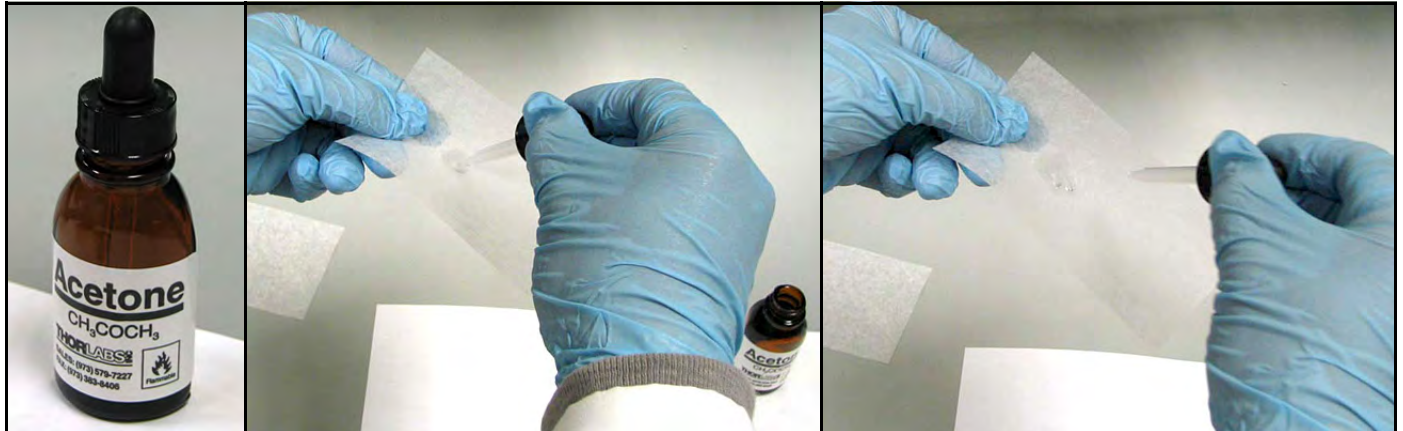

Figure 83: Using Analytical Grade Acetone

- Place the wet lens tissue on top of the mirror and drag it horizontally across the surface of the mirror (see *Figure 84* below), ensuring minimal liquid residue/streaks are left behind on the mirror surface.

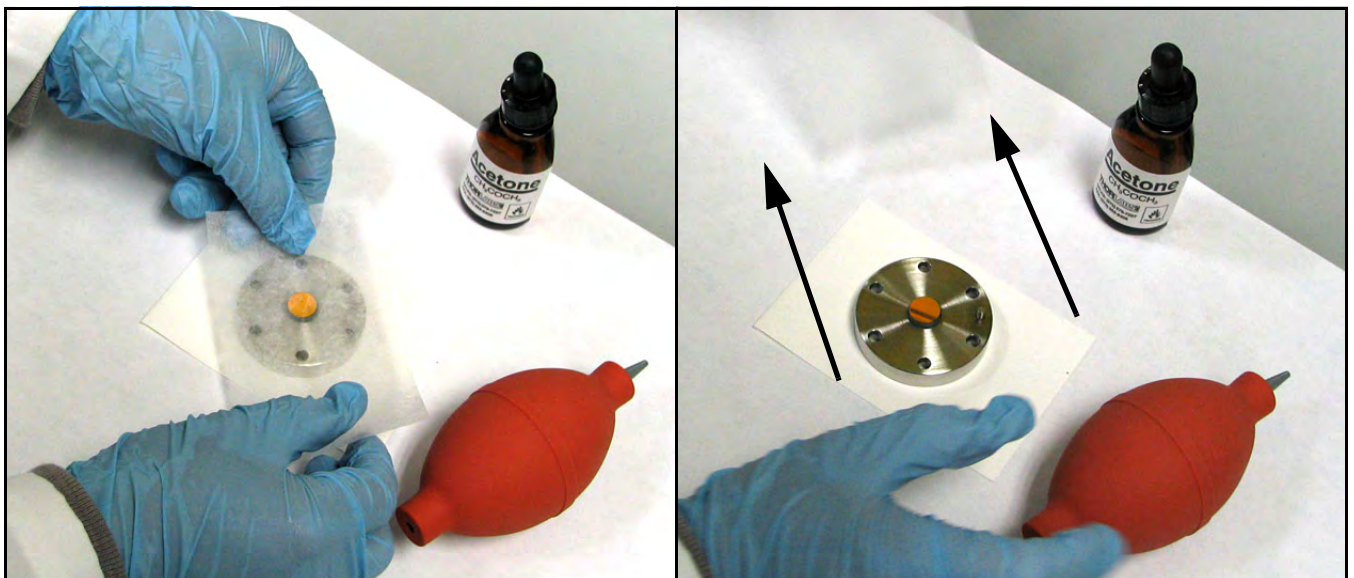
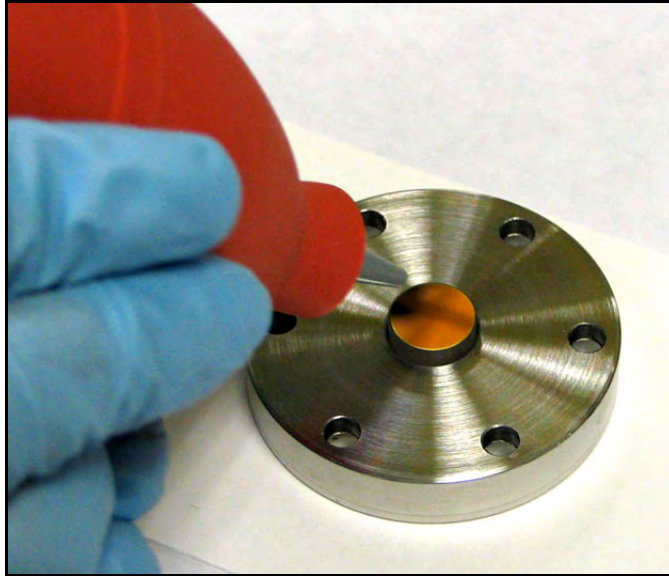

Figure 84: Dragging the Wet Lens Tissue Across the Mirror

### 6.2.1 Instructions for Optical Absorption Cell Style 1 (cont.)

6. Use the air blower to blow dry air onto the surface of the mirror. Puff repeatedly until the mirror surface appears dry (see Figure 85 below).



**Figure 85: Drying the Mirror**

7. Repeat steps **4-6** at least three times, using a new lens tissue each time. Each lens tissue wetted with acetone is used only once to clean off any visible residue on the mirror surface.
8. Visually inspect the mirror, and record any observation of gross contamination.
9. If the mirror does not appear to be clean after repeated cleanings, contact GE Technical Support for further assistance.
10. If the mirror does appear to be clean, re-install it onto the measurement cell.

### 6.2.1 Instructions for Optical Absorption Cell Style 1 (cont.)

11. As you line up the mirror with the measurement cell, note the “key” for properly connecting the two pieces. The mirror will align for mounting in only one position. Rotate the mirror assembly to line up the alignment pin with the alignment pin slot (see *Figure 86* below).

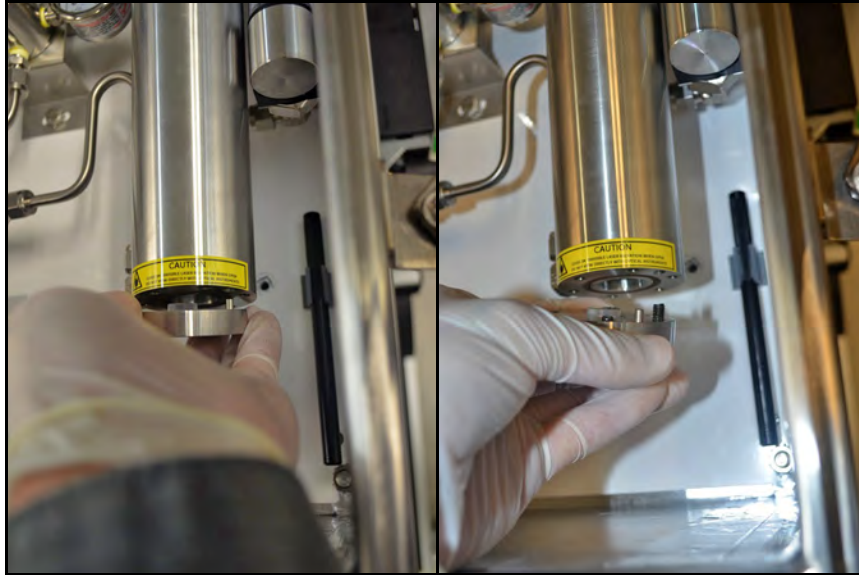

Figure 86: Reinstalling the Mirror End Cap Assembly

12. Loosely reinstall the six retaining bolts by hand.
13. Use an Allen wrench to tighten the six retaining bolts in an alternating or star pattern to achieve a uniform metal-to-metal contact. Tighten the bolts just until they are snug - **DO NOT** over-tighten these bolts.
14. Re-establish power to the **Aurora H2O** analyzer.
15. Re-establish the flow through the sample system.
16. If the **Aurora H2O** still indicates a Check Mirror fault after normal start-up, contact GE Technical Support for further assistance.

## 6.2.2 Instructions for Optical Absorption Cell Style 2

**IMPORTANT:** Use the instructions in this section only if you have identified your Optical Absorption Cell as Style 2 in Figure 78 on page 100.

1. Using a 5/8" socket wrench to loosen the hex head of the mirror assembly, gently unscrew the mirror assembly from the bottom of the absorption cell. While Figure 87 below shows this procedure for a dismantled cell, it is **NOT** necessary to dismount the optical absorption cell assembly to remove the mirror.
2. In cases of excessive contamination/grease entering the optical cell, this mirror could get stuck to the bottom of the cell when the end cap is removed. The mirror should be gently removed by pulling it straight down.

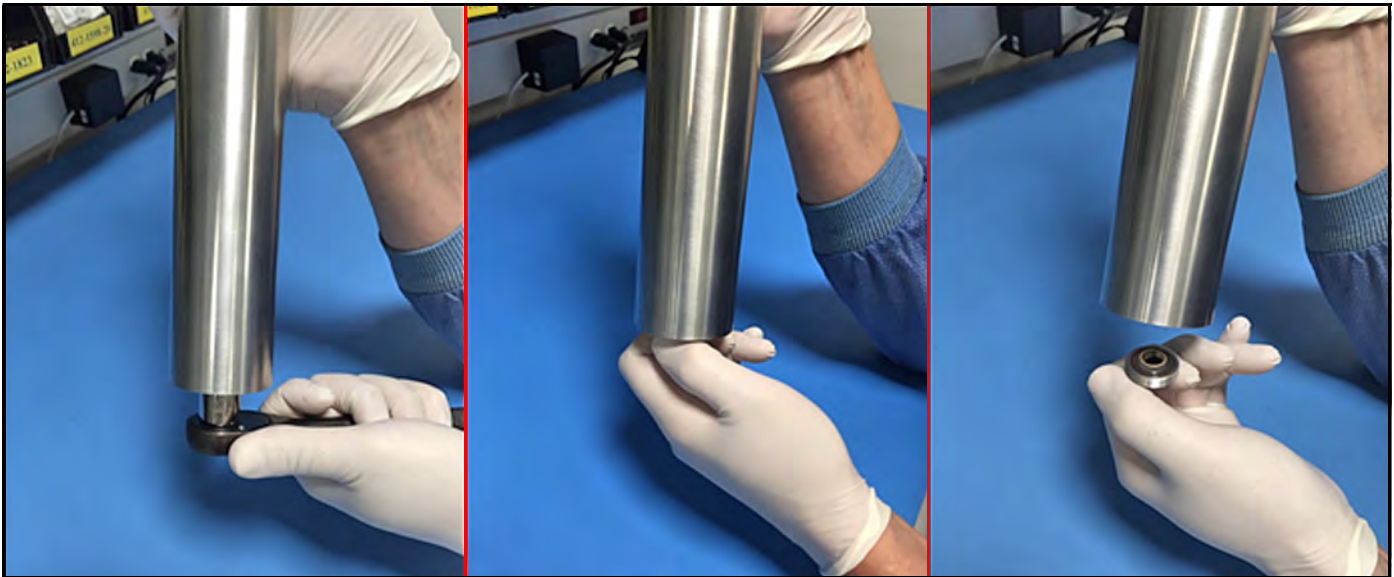

Figure 87: Removing Mirror End Cap Assembly from the Absorption Cell



**CAUTION!** Handle the mirror assembly with extreme care. Performance of the analyzer is critically dependent upon the mirror integrity. Do not touch the mirror surface with any tools, objects, hands or fingers.

## 6.2.2 Instructions for Optical Absorption Cell Style 2 (cont.)

3. Gently place the extracted mirror assembly on a clean lens tissue. Using a pair of plastic-tipped tweezers gently extract the 0.5" diameter mirror from the end cap, taking care not to touch, squeeze or nick the two O-rings in the end cap assembly (see *Figure 88* below).

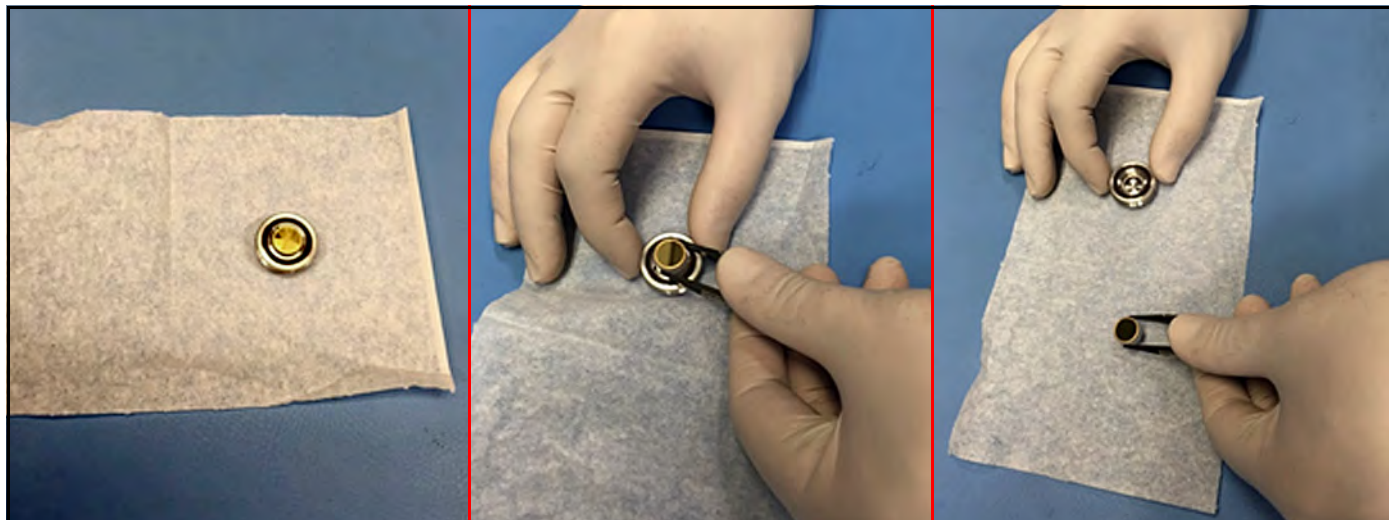

**Figure 88: Inspecting the Mirror Assembly**

4. Make a visual inspection of the mirror surface, and record any observations of gross contamination. If the mirror appears to be clean, do not clean it. Instead, reinstall it carefully into the system (go to Step 12).
5. If the mirror is contaminated, the first step in cleaning it is to use the air blower to blow away any particulate matter on the mirror surface. Place the mirror on a flat surface holding it from the sides with a pair of plastic tipped tweezers and repeatedly puff the air blower to force dry clean air onto the mirror surface (see *Figure 82 on page 102*).
6. Using a piece of lens tissue, wet a small area with a very small amount of analytical grade acetone (barely wetting the lens tissue). Typically, one drop of acetone will suffice. Tilt the lens tissue so that the acetone drop is absorbed by the lens paper along the length of the piece (see *Figure 83 on page 103* and *Figure 89* below).



**Figure 89: Applying Acetone to Lens Tissue**

## 6.2.2 Instructions for Optical Absorption Cell Style 2 (cont.)

7. Place the wet lens tissue on top of the mirror and drag it horizontally across the surface of the mirror, while holding it on with a pair of plastic-tipped tweezers (see *Figure 90* below). Ensure that minimal liquid residue or streaks are left behind on the mirror surface.

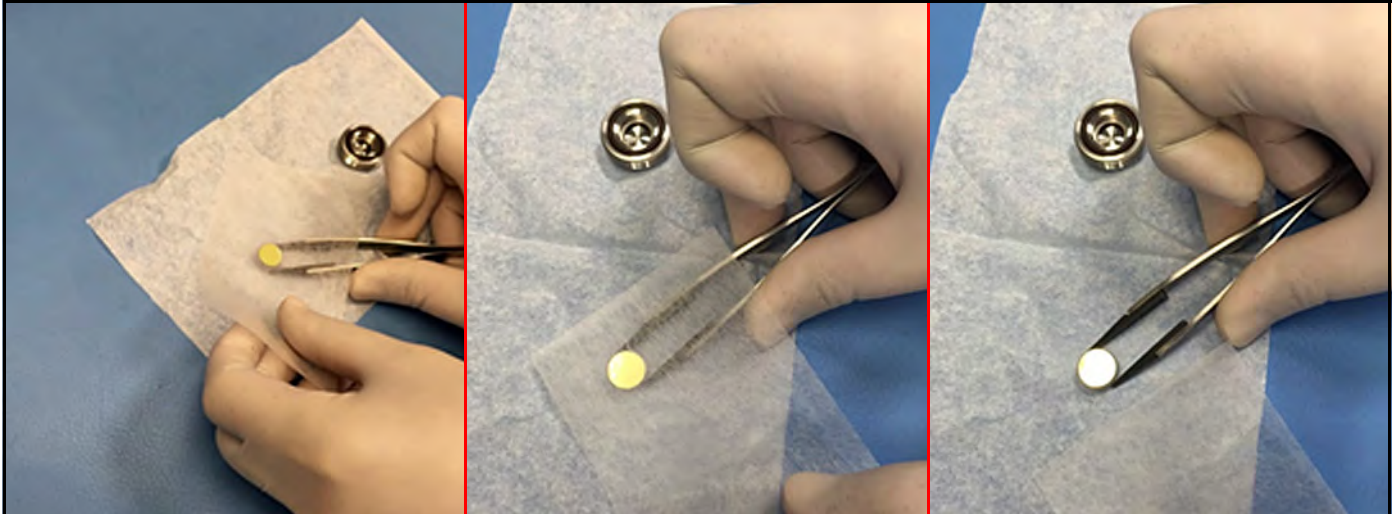

**Figure 90: Cleaning a Contaminated Mirror**

8. Use the air blower to blow dry air onto the surface of the mirror while holding it with the tweezers. Puff repeatedly until the mirror surface appears dry (see *Figure 85* on page 104).
9. Repeat **Steps 6-8** above at least three times, using a new lens tissue each time. Each lens tissue wetted with acetone is used only once to clean off any visible residue on the mirror surface.
10. Visually inspect the mirror, and record any observation of residual contamination.
11. If the mirror does **NOT** appear clean after repeated cleaning, contact GE Technical Support for further assistance.
12. If the mirror does appear to be clean, replace it into the mirror end cap, taking care not to disturb the two O-rings in the assembly (see *Figure 91* below), Prepare to re-install the mirror end cap assembly into the optical absorption cell.



**Figure 91: Replacing Cleaned Mirror into End Cap Assembly**

## 6.2.2 Instructions for Optical Absorption Cell Style 2 (cont.)

- Using tweezers, insert the mirror into the hole on top of the shim, with the gold-plated side facing up. Thread the end cap into the bottom of the absorption cell tube. Secure the threaded end cap in place with a 5/8" socket wrench (see *Figure 92* below).

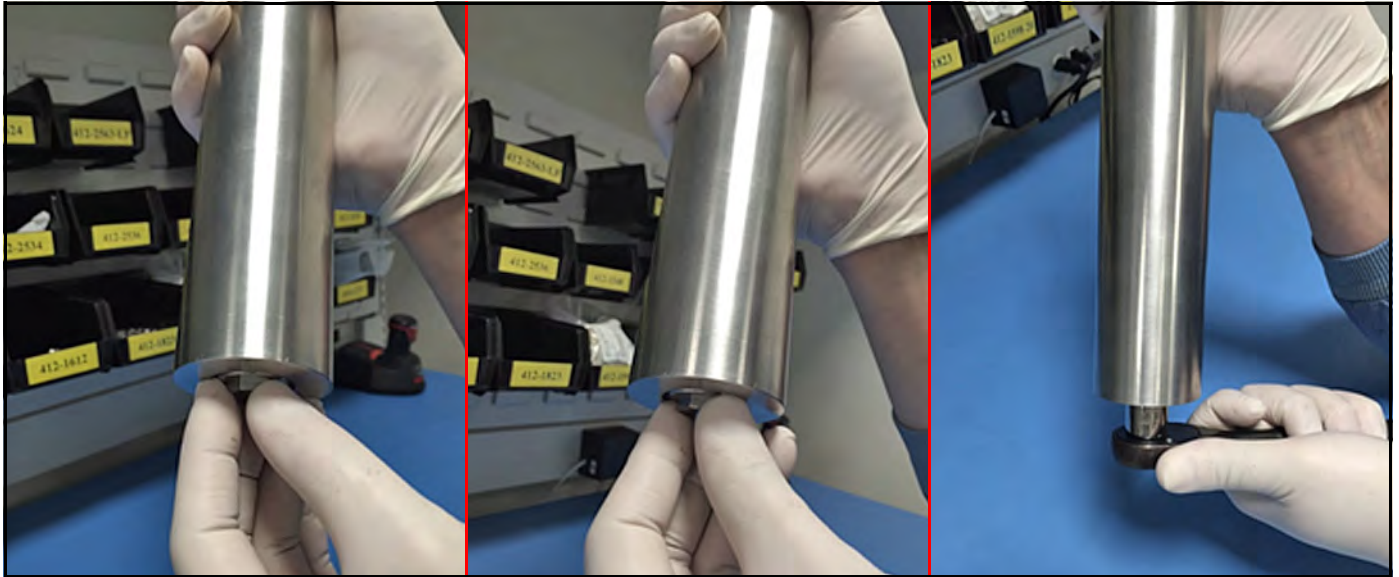

Figure 92: Replacing Mirror End Cap Assembly into the Absorption Cell

- Re-establish power to the **Aurora H2O** analyzer.
- Re-establish the flow through the sample system.
- If the **Aurora H2O** still indicates a Check Mirror fault after normal start-up, contact GE Technical Support for further assistance.

### 6.3 Replacing the Filter Element



The **Aurora H2O** uses a membrane filter (see *Figure 93* to the left) as the secondary filter. This filter is intended to prevent liquid or particulate contamination from entering the absorption cell. The Aurora should not be operated without a filter train upstream of the unit. The membrane filter is equipped with “*Flow Block*” which shuts off the flow if the filter element is heavily loaded with contamination. A spring loaded check valve closes the outlet flow of the sample if the differential pressure across the filter element exceeds a threshold limit. At any given time the flow through the **Aurora H2O** can be checked by observing the rotameter. If the “*flow block*” feature shuts off the flow, do not increase the pressure. Replace the filter element and clean the filter.

**Figure 93: Membrane Filter**

If the flow is being shut off too frequently, additional sample condition schemes, or the combination of the following, will have to be employed:

- **Bypass flow** - needed to sweep liquids or contamination off the filter. A 10:1 bypass flow rate should be maintained.
- Additional upstream filtration
- **Heat** - Heat tracing of the sample line and sample system components, sufficiently above both the water and hydrocarbon dew point, will keep the sample in the gas phase.

To replace the filter element, complete the following steps:

1. Close the inlet isolation needle valve and allow the system to fully depressurize.
2. Turn the filter cap counter-clockwise (see *Figure 94* below). You might need to use a channel-lock wrench to assist in loosening the cap.

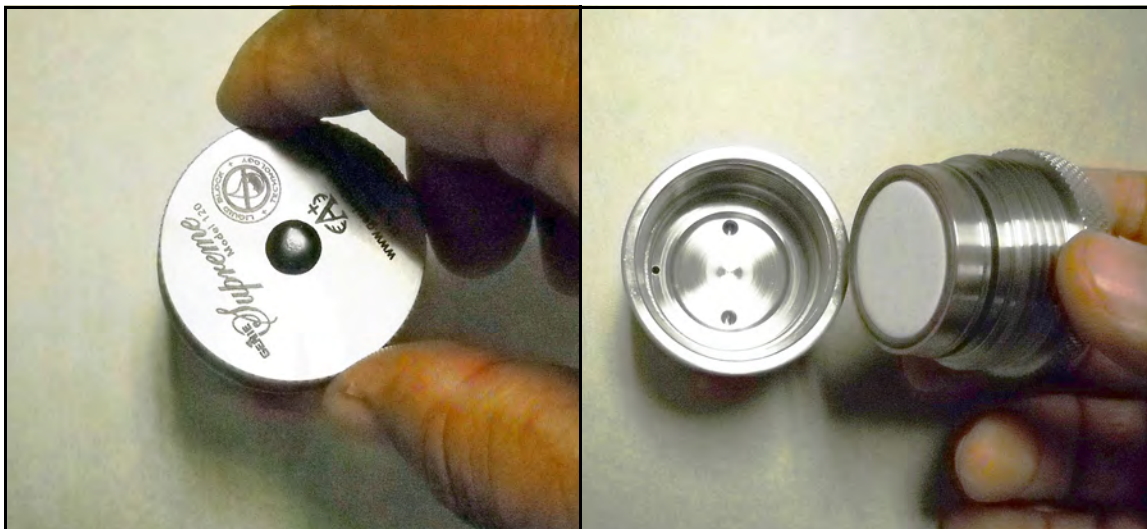

**Figure 94: Removing the Filter Cap**



### 6.3 Replacing the Filter Element (cont.)

3. Place the filter cap on a horizontal flat surface, filter side up.
4. Carefully remove the large O-ring (see *Figure 95* below).

**Note:** *Because the O-rings are reused, replacement O-rings are not included in the maintenance kit.*



**Figure 95: Orient the Filter Cap and Remove the Large O-Ring**

5. Remove the white membrane filter element and the membrane backing plate (see *Figure 96* below).



**Figure 96: Remove the White Filter Element and the Backing Plate**

### 6.3 Replacing the Filter Element (cont.)

6. Remove the small O-ring (see *Figure 97* below).



Figure 97: Remove the Small O-ring

7. Using a tissue, clean the filter components (see *Figure 98* below).

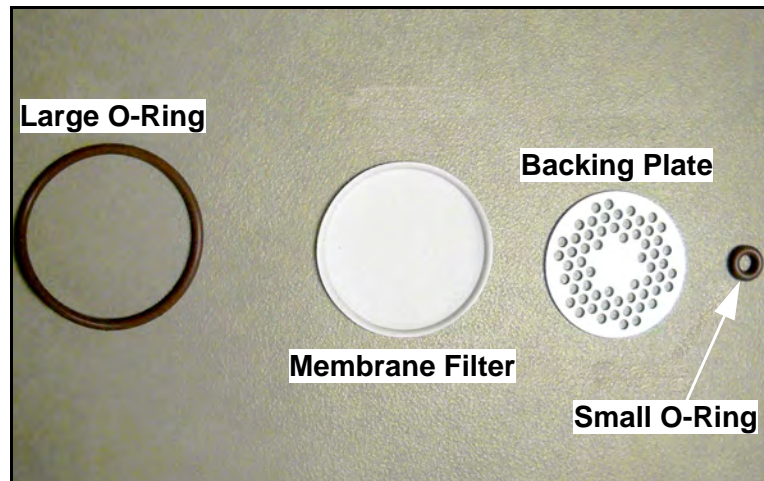

Figure 98: O-Rings, Membrane Filter and Backing Plate Removed

8. Re-assemble the filter, and reinstall the cap hand-tight.

## Chapter 7. Troubleshooting

### 7.1 Introduction

The following are possible **Aurora H2O** analyzer conditions with details on how to deal with them.

### 7.2 Blank Display

1. Is the green POWER LED lit?
  - a. Yes - proceed to **Step 2**.
  - b. No - Check the wiring and the fuse
2. Are the four arrow keys illuminated?
  - a. Yes - If the keys remain illuminated for more than 12 seconds, the *Boot Loader* cannot find a valid *Instrument Program* to run.
  - b. No - contact the factory for service.

### 7.3 Display Dim or Hard to Read

1. Adjust the LCD brightness and contrast using the Display/Adjust menu.

### 7.4 Status Messages and Indicators

The **Aurora H2O** categorizes status messages as either *Faults*, *Warnings*, or *Information*. Status messages are displayed in the upper right corner of the display, with continuous scrolling from right to left for long messages.

- A **fault** is a non-recoverable condition that can affect the quality of measurement by the **Aurora H2O**. Fault messages are accompanied by a slow flashing (!) indicator.
- A **warning** is a recoverable condition that can affect the quality of measurement by the **Aurora H2O**. Warning messages are accompanied by a rapid flashing (!) indicator.
- **Information** messages alert the operator to a condition that is abnormal, but does not affect the quality of measurements. Information messages are accompanied by a slow flashing (i) indicator.

**Aurora H2O** fault and status messages are prioritized. In case of more than one fault/status condition, the condition with the highest priority is displayed. When that condition is resolved, the next highest priority condition is displayed.

## 7.4 Status Messages and Indicators (cont.)

The possible status messages and indicators are summarized in *Table 6* below.

**Table 6: Status Messages and Indicators**

Message	Condition	Description
Status OK	Info	<b>Aurora H2O</b> is operating normally, no faults or other indications.
No CH4 detected	Info	<b>Aurora H2O</b> is reading moisture, but cannot detect the presence of methane.
H2O Under Range	Info	The moisture level is below the system detection limits.
Warning - System Overheating	Fault	The temperature inside the electronics module exceeds 85°C or the air temperature inside the sample system enclosure exceeds 68°C. The laser is powered off until the electronics module temperature is below 80°C, and the sample system enclosure temperature is below 65°C.
FAULT: Temperature	Fault	The temperature transducer is operating out of limits, is disconnected, or has failed.
FAULT: Sample Pressure	Fault	The internal (sample) pressure transducer is operating out of limits, is disconnected, or has failed.
FAULT: Line Pressure	Fault	The external (line) pressure transmitter is operating out of limits, is disconnected, or has failed. Occurs if source of the line pressure measurement is set to "Live", and no pressure transmitter is attached.
Laser Temp Unstable...	Warning	The temperature of the laser is not stable. This warning occurs briefly at power on, as the <b>Aurora H2O</b> sets the correct operating temperature. The laser is powered off until the temperature has stabilized.
Laser Adjust at Limits	Info	<b>Aurora H2O</b> has reached the limit for adjusting the laser power. Contact the factory for assistance.
Laser Reference Fail	Fault	<b>Aurora H2O</b> could not detect any signal from the laser. Contact the factory for assistance.
Weak Signal Return - Check Mirror	Info	<b>Aurora H2O</b> could not detect a signal returned from the sample cell, or the signal is below allowed limits. Check mirror for contamination.
FAULT: TEC FAIL	Fault	<b>Aurora H2O</b> has detected a failure in the laser temperature control. Contact the factory for assistance.
WARNING - Sample Pressure TOO HIGH	Warning	The pressure in the <b>Aurora H2O</b> sample cell is greater than 212 kPa (30.75 psia). Verify regulator and flow settings; check for blocked vent line or excessive back pressure.
ERROR: TEC Setpoint out of Range	Fault	The <b>Aurora H2O</b> temperature controller is was set beyond its operating limits. Contact the factory for assistance.
Service Req: ###	Fault	<b>Aurora H2O</b> has detected a fault condition that has no associated status message. Contact the factory for assistance.

## 7.5 No Flow Measurement Indicated on Aurora H2O Measurement Cell Outlet

Check to make sure that the outlet of the **Aurora H2O** is venting to atmospheric pressure. Ensure that the sample system valves are configured correctly and that the **Aurora H2O** internal pressure regulator is capable of a barely positive pressure setting. Check/Replace the filter element in the coalescer/filter as described in Chapter 5, *Maintenance*.

## 7.6 Verifying Aurora H2O Performance in the Field

There are two methods for verifying the performance of the **Aurora H2O** in the field. The first method is to use a portable hygrometer such as *GE's PM880* portable hygrometer. The second method is to use a moisture generator or standard gas cylinder.

### 7.6.1 Using A Portable Hygrometer

One quick spot check that can be done, that is relatively easy to do and requires minimal set-up time and no consumables, is to use a second hygrometer. *GE* recommends using a *PM880 Portable Hygrometer* (see *Figure 99* below) for this purpose, with a recently calibrated *Aluminum Oxide Moisture Probe*.



Figure 99: PM880 Portable Hygrometer

The *PM880* can be connected to the outlet of the **Aurora H2O** analyzer, using the portable sample system with the aluminum oxide moisture probe, to verify the system. The response time of the portable hygrometer is limited, as the sensor is typically exposed to air during movement to the sample point. So, it is recommended that the sample gas remains flowing through the portable sample system on the sample outlet of the **Aurora H2O** until equilibrium with the moisture concentration of the sample gas is reached. You can use the data-logging capability of the *PM880* to determine when steady-state conditions are reached. Consult *GE* if you have application questions regarding this process.

## 7.6.2 Using a Moisture Standard

The best moisture standard to use is one generated by a moisture generator as a flowing reference, due to the fact that static moisture standards in cylinders have limited capability and reliability. A moisture generator such as *GE's MG101* moisture generator (see *Figure 100* below) can be used for this purpose.



**Figure 100: MG101 Moisture Generator**

However, a moisture generator is typically used only in an indoor location with reasonably good temperature control. In the field this is not always practical, so a more convenient option would be to use a static moisture standard in a gas cylinder. Consult with your local specialty gas supplier about standards for moisture. Based on application experience, GE recommends the following guidelines regarding moisture standards in gas cylinders:

- Use passivated, aluminum gas cylinders only.
- Do not use the cylinder when the pressure falls below 50% of the original pressure supplied by the vendor (typically 1500-1800psig).
- Use the gas cylinder for moisture values of 50–100 ppm.
- Use a moisture standard having a background gas of nitrogen (N<sub>2</sub>).
- Mix the moisture standard for 10 minutes prior to use, following the manufacturer's guidelines (rolling the cylinder is typical).
- Use the gas cylinder at the nominal temperature at which the cylinder was tested by the manufacturer.

Whether using a moisture generator or a standard moisture gas cylinder, the source gas should be connected to the **Aurora H2O** using the **PURGE INLET** on the analyzer. Ensure that the sample gas pressure is regulated to a just barely positive pressure and establish gas flow from the **PURGE INLET** to the **Aurora H2O** measurement cell.

## 7.7 Background Selection Lockout

To prevent accidental selection or tampering, the **Background** menu option can be disabled using a mechanical switch located behind the **Aurora H2O** display. Access to the switch requires removal of the cover, and should be performed only in non-hazardous conditions.

**Note:** *Unless otherwise requested, the Aurora/H2O is shipped with the Background selection **unlocked**.*

The Lockout switch is positioned to the right of the Laser Indicator (see *Figure 101* below). When the switch is in the UP position, the Background Selection menu is **unlocked**. When the switch is in the DOWN position, the Background Selection menu is **locked**.



Figure 101: Background Selection Lockout Switch Location

Attempting to access the Background Gas Selection menu with the switch in the Locked Out (down) position will result in the following message being displayed:

```
Menu: X
Gas select is locked.
Use Gas Lockout
switch to unlock.
```

[no content intended for this page]



## Appendix A. MODBUS RTU/RS485 Communications

### A.1 Introduction

The **Aurora H2O** supports digital communications using the Modbus/RTU protocol, with 2-wire RS-485 or 3-wire RS-232C as the physical layer. Data rate can be specified at rates from 4800 to 115200 bits per second (bps), with selectable parity.

**Aurora H2O** has two physically separate communications ports. Both ports can be selected for either RS-232 or RS-485 operation, and **Aurora H2O** can communicate with both ports simultaneously.

**Note:** **Aurora H2O** supports the Modbus/RTU protocol as defined in:

MODBUS Application Protocol Specification, V1.1b  
&  
MODBUS over Serial Line Specification and Implementation Guide V1.02.

**Note:** The above referenced specifications are available from the Modbus Organization at <http://modbus-ida.org>.

### A.2 Modbus Functions and Data Types

The Modbus functions supported by **Aurora H2O** include:

- (0x03) Read Holding Registers
- (0x04) Read Input Registers
- (0x08) Diagnostics (Serial Line only) - only supports Echo subcommand
- (0x10) Write Multiple registers
- (0x11) Report Slave ID (Serial Line only)
- (0x2B/0x0E) Read Device Identification - only supports Basic Device Identification tags, which are:
  - VendorName
  - Product code
  - Revision number

**Aurora H2O** supports data types of Integer and Double/Float. Integer data types are always four (4) bytes long and should be read with a request for two registers (two bytes per each register, two registers total) at the address. Double/Float data types provide eight (8) byte double precision data or four (4) byte single precision data, depending on how many registers are requested. Four registers are used for double data types, and two registers are used for single precision data types.

### A.3 Modbus Registers

All registers denoted with a bullet (•) in the Read-Only column are read-only registers and should be read with the function “Read Input Registers.” All other registers can be read and written with “Read Holding Registers” or “Write Multiple Registers.”

**Note:** *The Modbus Register Address map supported by Aurora H2O is shown in Table 7 below.*

**Table 7: Modbus Register Map**

Function	Parameter	Description	Range/State	Addr	Data Type	Read Only
System Status <sup>1</sup>	Status Register			0	Integer	•
	Status Register, Latched	Write 0 to clear		1000	Integer	
Display	Data/Plot	Select Plot or Data Display view	0 = Data View 1-60 = Plot view duration, in minutes	1010	Integer	
	Primary Units	Measurement unit to display	Reg. address of Meas.	1100	Integer	
	Primary Decimals	# of decimal places to display	Measurement dependent	1110	Integer	
	Alt 1 (Left) Units	Measurement unit to display	Reg. address of Meas.	1200	Integer	
	Alt 1 (Left) Decimals	# of decimal places to display	Measurement dependent	1210	Integer	
	Alt 2 (Right) Units	Measurement unit to display	Reg. address of Meas.	1300	Integer	
Alt 2 (Right) Decimals	# of decimal places to display	Measurement dependent	1310	Integer		

Table 7: Modbus Register Map (cont.)

Function	Parameter	Description	Range/State	Addr	Data Type	Read Only	
Analog Output	Output 1	Trim Sequence Start/Resume Live Output <sup>2</sup>		2100	Integer		
		Units	Reg. address of Meas.	2110	Integer		
		Type	0 = 4-20mA, 1 = 0-20mA	2120	Integer		
		Trim Reading Zero	3.0 ~ 5.2	2140	Double/Float		
		Trim Reading Span	10.0 ~ 22.2	2150	Double/Float		
		Upper of Value	-10000 ~ 10000	2160	Double/Float		
		Lower of Value	-10000 ~ 10000	2170	Double/Float		
		Test	% value of output, 0~100	2180	Double/Float		
	Output 2	Trim Sequence Start/Resume Live Output <sup>2</sup>			2200	Integer	
		Units	Reg. address of Meas.		2210	Integer	
		Type	0 = 4-20mA, 1 = 0-20mA		2220	Integer	
		Trim Reading Zero	3.0 ~ 5.2		2240	Double/Float	
		Trim Reading Span	10.0 ~ 22.2		2250	Double/Float	
		Upper of Value	-10000 ~ 10000		2260	Double/Float	
		Lower of Value	-10000 ~ 10000		2270	Double/Float	
		Test	% value of output, 0~100		2280	Double/Float	
	Output 3	Trim Sequence Start/Resume Live Output <sup>2</sup>			2300	Integer	
		Units	Reg. address of Meas.		2310	Integer	
		Type	0 = 4-20mA, 1 = 0-20mA		2320	Integer	
		Trim Reading Zero	3.0 ~ 5.2		2340	Double/Float	
		Trim Reading Span	10.0 ~ 22.2		2350	Double/Float	
		Upper of Value	-10000 ~ 10000		2360	Double/Float	
		Lower of Value	-10000 ~ 10000		2370	Double/Float	
		Test	% value of output, 0~100		2380	Double/Float	

Table 7: Modbus Register Map (cont.)

Function	Parameter	Description	Range/State	Addr	Data Type	Read Only	
Alarm	All Alarm Status		0 ~ 7 (Bitfield)	3000	Integer	•	
	Alarm 1	Status		0 = Not tripped, 1 = Tripped	3100	Integer	•
		Switch		0 = OFF, 1 = ON	3110	Integer	
		Units		Reg. address of Meas.	3120	Integer	
		Type		Set Point = 0, In Band = 1, Out Band = 2	3130	Integer	
		Upper		Depends on unit type	3140	Double/Float	
		Lower		Depends on unit type	3150	Double/Float	
	Alarm 2	Status		0 = Not tripped, 1 = Tripped	3200	Integer	•
		Switch		0 = OFF, 1 = ON	3210	Integer	
		Units		Reg. address of Meas.	3220	Integer	
		Type		Set Point = 0, In Band = 1, Out Band = 2	3230	Integer	
		Upper		Depends on unit type	3240	Double/Float	
		Lower		Depends on unit type	3250	Double/Float	
	Alarm 3	Status		0 = Not tripped, 1 = Tripped	3300	Integer	•
		Switch		0 = OFF, 1 = ON	3310	Integer	
		Units		Reg. address of Meas.	3320	Integer	
		Type		Set Point = 0, In Band = 1, Out Band = 2	3330	Integer	
		Upper		Depends on unit type	3340	Double/Float	
Lower			Depends on unit type	3350	Double/Float		
Settings	Adjust	PPM Level offset adjust	-25.00 ~ +25.00	5210	Double/Float		
		Moisture reading average filter size	10 ~ 200 samples	5230	Integer		
	Clock	Hour		0~23	5410	Integer	
		Minutes		0~59	5420	Integer	
		Month		1~12	5430	Integer	
		Date		1~28/29/30/31	5440	Integer	
		Year		2000~2099	5450	Integer	
	External Pressure	Constant		0 ~ 3500.00 kPa	5510	Double/Float	
		Pressure Zero Calibration, mA		0~22 mA	5520	Double/Float	
		Pressure Span Calibration, mA		0~22 mA	5525	Double/Float	
		Pressure Zero Calibration, kPa		0~3500 kPa	5530	Double/Float	
		Pressure Span Calibration, kPa		0~3500 kPa	5535	Double/Float	
Pressure Source		Constant Value = 0, Live Sensor = 1	5540	Integer			

Table 7: Modbus Register Map (cont.)

Function	Parameter	Description	Range/State	Addr	Data Type	Read Only	
Device ID	Aurora H2O Serial Number	-----	-----	8100	8 Character Bytes	•	
	Laser Serial Number	-----	-----	8200	8 Character Bytes	•	
	Calibration Date	Month	1~12		8310	Integer	•
		Date	Depends on month		8320	Integer	•
		Year	2000~2100		8330	Integer	•
System Up Time	MSDate	Uptime, in days		8400	Double/Float	•	
Measurements	Dew Point	Dew Point °C	-----		9110	Double/Float	•
		Dew Point °F	-----		9120	Double/Float	•
		Equivalent Dew Point °C	-----		9130	Double/Float	•
		Equivalent Dew Point °F	-----		9140	Double/Float	•
	Temperature	Sample Temperature °C	-----		9210	Double/Float	•
		Sample Temperature °F	-----		9220	Double/Float	•
	External Pressure	kPa	-----		9510	Double/Float	•
		MPa	-----		9512	Double/Float	•
		PSIa	-----		9520	Double/Float	•
		PSIg	-----		9530	Double/Float	•
		kg/cm <sup>2</sup>	-----		9540	Double/Float	•
		Bars	-----		9550	Double/Float	•
		mmHg	-----		9560	Double/Float	•
	Internal Pressure	kPa	-----		9610	Double/Float	•
		MPa	-----		9612	Double/Float	•
		PSIa	-----		9620	Double/Float	•
		PSIg	-----		9630	Double/Float	•
		kg/cm <sup>2</sup>	-----		9640	Double/Float	•
		Bars	-----		9650	Double/Float	•
		mmHg	-----		9660	Double/Float	•
	H <sub>2</sub> O Concentration	PPM	-----		9710	Double/Float	•
		Lbs MMSCF	-----		9720	Double/Float	•
		mg/sm <sup>3</sup>	-----		9730	Double/Float	•
g/sm <sup>3</sup>		-----		9750	Double/Float	•	
Vapor Pressure	kPa	-----		9800	Double/Float	•	

### A.3 Modbus Registers (cont.)

<sup>1</sup>Address 0 is the *System Status* register, and address 1000 is the latching version of the *System Status* register. That is, both registers will show the error bit if the error is currently present, but only the latching register will show it if the condition is no longer present. Writing 0 to the latching register will clear the error code it contains.

<sup>2</sup>The “*Trim Sequence Start/Resume Live Output*” registers for the three outputs, (address 2100, 2200, 2300) accept certain values through the *Write Multiple Register* to trim the output current:

1. Write 0 to 2x00 to select the normal mA output (proportional to measurement).
2. Write 1 to 2x00 to reset the mA output trim to factory defaults.
3. Write 2 to 2x00 to output the “zero” current (~4.000 mA) and accept a calibration value written to 2x40.
4. Write 3 to 2x00 to output the “span” current (~20.000 mA) and accept a calibration value written to 2x50.

**Note:** *Attempting to write to Trim registers 2x40/2x50 without first writing to Trim State register 2x00 will fail with Modbus exception 4.*

At the end of calibration, write 0 to 2x00 to make **Aurora H2O** exit trim mode.

## A.4 Modbus System Status Codes

Table 8 below lists the *System Status* codes and descriptions. It is possible for multiple status codes to be present. The hexadecimal values represent the bit set for a given condition.

**Table 8: System Status Codes**

Status	Description
0x00000000	<b>Aurora H2O</b> is operating normally, no faults or other indications.
0x00000008	<b>Aurora H2O</b> is reading moisture, but cannot detect the presence of methane.
0x00000010	The moisture level is below the system detection limits.
0x00000020	The temperature inside the electronics module exceeds 85°C. The laser is powered off until the temperature drops below 80°C.
0x00000040	The temperature transducer is operating out of limits, is disconnected, or has failed.
0x00000080	The internal (sample) pressure transducer is operating out of limits, is disconnected, or has failed.
0x00000100	The external (line) pressure transmitter is operating out of limits, is disconnected, or has failed. Occurs if source of the line pressure measurement is set to "Live", and no pressure transmitter is attached.
0x00000200	Power supply under voltage
0x00000400	System ground fault
0x00000800	The temperature of the laser is not stable. This warning occurs briefly at power on, as the <b>Aurora H2O</b> sets the correct operating temperature. The laser is powered off until the temperature has stabilized.
0x00001000	<b>Aurora H2O</b> has reached the limit for adjusting the signal gain. Contact the factory for assistance.
0x00002000	<b>Aurora H2O</b> has reached the limit for adjusting the laser power. Contact the factory for assistance.
0x00004000	<b>Aurora H2O</b> could not detect any signal from the laser. Contact the factory for assistance.
0x00010000	<b>Aurora H2O</b> could not detect a signal returned from the sample cell, or the signal is below allowed limits. Check the mirror for contamination.
0x00020000	<b>Aurora H2O</b> has detected a failure in the laser temperature control. Contact the factory for assistance.
0x00040000	The pressure in the <b>Aurora H2O</b> sample cell is greater than 212 kPa (30.75 psia). Verify regulator and flow settings; check for blocked vent line or excessive back pressure.
0x00000000	The <b>Aurora H2O</b> temperature controller is was set beyond its operating limits. Contact the factory for assistance.
0x1yyyzzzz	Extended Error Code

[no content intended for this page]



<b>A</b>		Information Paragraphs . . . . .	vii
AuroraView		Insertion Probe/Regulator	
Capabilities . . . . .	77	Description . . . . .	17
Datalogging with . . . . .	92	Installation . . . . .	17
Installing . . . . .	78	Setting the Pressure . . . . .	25
Requirements. . . . .	77	Installation	
Scan Plots . . . . .	93	Choosing a Site . . . . .	14
Starting . . . . .	85	Mounting . . . . .	16
Trend Plots . . . . .	93	Installation, System . . . . .	13
Trend Tabular Data . . . . .	93		
Using Main Menus. . . . .	87	<b>K</b>	
<b>B</b>		Keypad	
Bill of Materials . . . . .	13	Lock-Out Switch . . . . .	38
<b>C</b>		Unlocking . . . . .	38
Clock, Resetting . . . . .	61	<b>L</b>	
Comm Port Settings. . . . .	51	Lights, Indicator . . . . .	37
Components . . . . .	6	Low Voltage Directive . . . . .	16
Connections . . . . .	32	<b>M</b>	
<b>D</b>		Magnetic Stylus. . . . .	37
Default Display . . . . .	37	Maintenance . . . . .	99
Display		Menu Map . . . . .	75
Blank . . . . .	113	Menus, Accessing . . . . .	39
Dim or Hard to Read . . . . .	113	Mirror, Cleaning . . . . .	99
Locking/Unlocking . . . . .	73	Modbus	
Setting Up. . . . .	40	Register Map . . . . .	120
Display, Default. . . . .	37	RTU/RS485 Communications. . . . .	119
<b>E</b>		Mounting . . . . .	16, 31
Electrical Connections . . . . .	26	<b>N</b>	
<b>F</b>		Numeric Values, Entering. . . . .	39
Features . . . . .	1	<b>O</b>	
Filter Element, Replacing. . . . .	7, 110	Offset Values, Adjusting. . . . .	53
<b>G</b>		Operation	
Gas Molecular Weight, Adjusting . . . . .	56	Sample System . . . . .	33
<b>H</b>		Theory of . . . . .	2
Heater		Outline . . . . .	31
EU/ATEX . . . . .	5, 8	<b>P</b>	
USA/CAN. . . . .	4, 8	Parts . . . . .	99
<b>I</b>		Parts List . . . . .	6
Indicator Lights . . . . .	37	Pressure Settings, Resetting . . . . .	63

---

Programming	
Advanced Features . . . . .	51
General . . . . .	33
Menu Map . . . . .	75

**R**

Regional Settings . . . . .	65
Replacing the Filter Element . . . . .	7, 110

**S**

Safety	
Auxiliary Equipment . . . . .	vii
General Issues . . . . .	vii
Personal Equipment . . . . .	viii
Sample System	
Operation . . . . .	33
Settings, Regional . . . . .	65
Site Location . . . . .	14
Spare Parts . . . . .	99
Specifications . . . . .	9
Starting Up . . . . .	40
Stylus, Magnetic . . . . .	37
System	
Information . . . . .	70

**T**

Troubleshooting . . . . .	113
Blank Display . . . . .	113
Display Dim or Hard to Read . . . . .	113
No Flow Measurement . . . . .	115
Status Messages and Indicators . . . . .	113
Using a Moisture Standard . . . . .	116
Using a Portable Hygrometer . . . . .	115
Verifying Performance . . . . .	115

**U**

Unpacking . . . . .	13
---------------------	----

**W**

Wiring . . . . .	26, 32
Wiring Diagram	
EU/ATEX Heater . . . . .	8
USA/CAN Heater . . . . .	8

---

## Warranty

Each instrument manufactured by GE Sensing is warranted to be free from defects in material and workmanship. Liability under this warranty is limited to restoring the instrument to normal operation or replacing the instrument, at the sole discretion of GE Sensing. Fuses and batteries are specifically excluded from any liability. This warranty is effective from the date of delivery to the original purchaser. If GE Sensing determines that the equipment was defective, the warranty period is:

- One year from delivery for electronic or mechanical failures
- One year from delivery for sensor shelf life

If GE Sensing determines that the equipment was damaged by misuse, improper installation, the use of unauthorized replacement parts, or operating conditions outside the guidelines specified by GE Sensing, the repairs are not covered under this warranty.

---

**The warranties set forth herein are exclusive and are in lieu of all other warranties whether statutory, express or implied (including warranties or merchantability and fitness for a particular purpose, and warranties arising from course of dealing or usage or trade).**

---

## Return Policy

If a GE Sensing instrument malfunctions within the warranty period, the following procedure must be completed:

1. Notify GE Sensing, giving full details of the problem, and provide the model number and serial number of the instrument. If the nature of the problem indicates the need for factory service, GE Sensing will issue a RETURN AUTHORIZATION NUMBER (RAN), and shipping instructions for the return of the instrument to a service center will be provided.
2. If GE Sensing instructs you to send your instrument to a service center, it must be shipped prepaid to the authorized repair station indicated in the shipping instructions.
3. Upon receipt, GE Sensing will evaluate the instrument to determine the cause of the malfunction.

Then, one of the following courses of action will then be taken:

- If the damage is covered under the terms of the warranty, the instrument will be repaired at no cost to the owner and returned.
- If GE Sensing determines that the damage is not covered under the terms of the warranty, or if the warranty has expired, an estimate for the cost of the repairs at standard rates will be provided. Upon receipt of the owner's approval to proceed, the instrument will be repaired and returned.

[no content intended for this page]

We,

**GE Sensing**  
**1100 Technology Park Drive**  
**Billerica, MA 01821**  
**USA**

declare under our sole responsibility that the

**Aurora H<sub>2</sub>O Moisture Analyzer**

to which this declaration relates, is in conformity with the following standards:

- EN 60079-0: 2006
- EN 60079-1: 2007
- EN 60079-7: 2007
- EN 60529: 1991 +A1: 2000
- II 2 G Ex de IIB T<sub>6</sub>, T<sub>g</sub> = -20°C to +65°C, IP66; FM09ATEX0065X (FM Global, UK)
- EN 61326-1: 2006, Class A, Table 2, Industrial Locations
- EN 61326-2-3: 2006
- EN 61010-1: 2012, Overvoltage Category II
- IEC 60825-1

following the provisions of the 2004/108/EC EMC, 2006/95/EC Low Voltage and 94/9/EC ATEX Directives.

The unit listed above and any ancillary equipment supplied with it do not bear CE marking for the Pressure Equipment Directive, as they are supplied in accordance with Article 3, Section 3 (sound engineering practices and codes of good workmanship) of the Pressure Equipment Directive 97/23/EC for DN<25.

Billerica - September 1, 2015

Issued



Mr. Gary Kozinski  
Certification & Standards, Lead Engineer



[no content intended for this page]



## Customer Support Centers

### U.S.A.

The Boston Center  
1100 Technology Park Drive  
Billerica, MA 01821  
U.S.A.  
Tel: 800 833 9438 (toll-free)  
978 437 1000  
E-mail: [sensing@ge.com](mailto:sensing@ge.com)

### Ireland

Sensing House  
Shannon Free Zone East  
Shannon, County Clare  
Ireland  
Tel: +353 (0)61 470200  
E-mail: [gesensingsnnservices@ge.com](mailto:gesensingsnnservices@ge.com)

An ISO 9001:2008 Certified Company

[www.gemeasurement.com/quality-certifications](http://www.gemeasurement.com/quality-certifications)

[www.gemeasurement.com](http://www.gemeasurement.com)

©2016 General Electric Company. All rights reserved.  
Technical content subject to change without notice.