



*FRENIC-Eco*

*CC-Link*

# CC-Link Interface Card " OPC-F1-CCL "

---

## CAUTION

Thank you for purchasing our CC-Link Interface Card OPC-F1-CCL.

- This product is designed to connect the FRENIC-Eco series of inverters to CC-Link. Read through this instruction manual and be familiar with the handling procedure for correct use.
- Improper handling blocks correct operation or causes a short life or failure.
- Deliver this manual to the end user of the product. The end user should keep this manual in a safe place until the CC-Link Interface Card is discarded.
- For the usage of inverters, refer to the instruction manual prepared for the FRENIC-Eco series of inverters.

Copyright © 2006 Fuji Electric FA Components & Systems Co., Ltd.

All rights reserved.

No part of this publication may be reproduced or copied without prior written permission from Fuji Electric FA Components & Systems Co., Ltd.

All other product and company names mentioned in this manual are trademarks or registered trademarks of their respective holders.

The information contained herein is subject to change without prior notice for improvement.

## Preface

Thank you very much for purchasing CC-Link interface option “OPC-F1-CCL”.

Use this instruction manual to connect CC-Link master (a sequencer manufactured by Mitsubishi Electric Co., Ltd., etc.) and the FRENIC-Eco through the CC-Link. Please, read through this manual carefully prior to use of the product to familiarize yourself with correct use. Improper handling may result in malfunction, shorter service life or failure.

Attestation logo mark

**CC-Link**

 This manual is designed to serve as a quick guide to the installation and operation of the CC-Link Interface Card. For the FRENIC-Eco and other optional functions, refer to the FRENIC-Eco User's Manual (MEH456□), RS-485 User's Manual (MEH448□).

If you have any questions about the product or this instruction manual, please contact the store or our nearest sales office.

## How this manual is organized

This manual is made up of chapters 1 through 14.

### **Chapter 1 Features**

Gives an overview of the main features of the CC-Link Interface Card.

### **Chapter 2 Acceptance Inspection**

Lists points to be checked upon delivery of the Card and precautions for transportation and storage of the Card. Also presents the appearance of the Card and provides information on how to obtain an EDS file.

### **Chapter 3 Installation**

Provides instructions and precautions for installing the Card.

### **Chapter 4 Wiring and Cabling**

Provides wiring and cabling instructions around the pluggable connector for the Card. Also gives the specifications for the cables.

### **Chapter 5 Procedure for Instruction of the Option**

The procedure for introducing CC-Link option is described here.

### **Chapter 6 Function Code**

Lists the inverter's function codes which are specific to CC-Link.

### **Chapter 7 Protective Operation**

Operation when an abnormal telecommunication line is generated while operation command and the speed command given by way of CC-Link.

### **Chapter 8 Link Functions**

Set content when the driving operation of the inverter is done by way of CC-Link.

### **Chapter 9 Communication between Sequencer**

The buffer memory use address of the CC-Link master unit used by the inverter communication.

### **Chapter 10 Communication Specification**

I/O signal and a remote register.

### **Chapter 11 Link Number / Data Format**

Lists the CC-Link communication No and the communication data format.

### **Chapter 12 Application Program examples**

The program example of controlling the inverter by the sequence program.

### **Chapter 13 Troubleshooting**

Provides troubleshooting instructions for certain problems, e.g., when the inverter does not operate as ordered or when an alarm condition has been recognized.

### **Chapter 14 Specifications**

Lists the general specifications and communications specifications.

## Icons

The following icons are used throughout this manual.

 **Note** This icon indicates information which, if not heeded, can result in the product not operating to full efficiency, as well as information concerning incorrect operations and settings which can result in accidents.

 **Tip** This icon indicates information that can prove handy when performing certain settings or operations.

 This icon indicates a reference to more detailed information.

## Table of Contents

Chapter1	Features	3	Chapter10	Communication specification	21
Chapter2	Acceptance Inspection	4	10.1	Input/output signal list	21
Chapter3	Installation	5	10.2	Assigning remote registers	23
Chapter4	Wiring and Cabling	6	10.3	Description of remote registers	25
Chapter5	Procedure for Introduction of the Option	8	Chapter11	Link Number / Data Format	27
Chapter6	Function Codes	9	Chapter12	Application program examples	37
6.1	Standard function codes	9	12.1	System configuration	37
6.2	Function codes exclusive to communication	9	12.2	Outline of master unit	37
6.3	Function codes exclusive to the option	9	12.3	CC-Link startup program	39
Chapter7	Protective Operation	10	12.4	Procedure for reading operation status	40
7.1	Protective Operation function codes	10	12.5	Procedure for setting the operation mode	41
Chapter8	Link Functions	15	12.6	Procedure for operation command setting	42
8.1	Enabling link operation	15	12.7	Monitoring procedure	43
8.2	Confirmation and writing of function code	15	12.8	Procedure for reading function codes	44
Chapter9	Communication between Sequencer	16	12.9	Procedure for writing function codes	45
9.1	Outline of the communication	16	12.10	Procedure for setting the command frequency	46
9.2	Reliability of data exchanged through link	17	12.11	Procedure for reading alarm definition	47
9.3	Using area of buffer memory	18	12.12	Procedure for resetting the inverter	48
9.4	Using addresses of buffer memory	19	Chapter13	Troubleshooting	49
			Chapter14	Specification	51

## Chapter1 Features

CC-Link is FA opening field network system that means Control&Communication Link. It is transmission speed 156kbps~10Mbps the CC-Link master unit is connected with the FRENIC-Eco CC-Link option card with a special cable. And the total extension are 100m~1,200m. Because the system from which the distance is demanded by the system from which the speed are demanded can use it in a wide area, a flexible system configuration becomes possible. This option card corresponds to Ver2.00 (enactment in January, 2003) that can send and receive not only profile Ver1.10 (communications protocol) that the CC-Link society is enacting so far but also more data. (The master bureau should also be doing for Ver2.00 when using it with Ver2.00.)

Installing this option card in FRENIC-Eco can do the following from the CC-Link master unit:

- Inputting operation and stop signals can be monitored.
- The frequency instruction can be set.
- State of driving can be monitored.

Forward operation, reverse operation, Y1~Y5 State of terminal, batch alarm, monitoring, Frequency setting completion, command code execution completed, alarm state, remote station ready, etc.

- Various states of inverter driving can be monitored.

Frequency instruction, output frequency, torque operation value, output current, output voltage, integrated operation time, etc.

- Each function code can be referred and be changed.

## Chapter2 Acceptance Inspection

Unpack the package and check that:

- (1) A CC-Link Card is contained in the package.
- (2) The DeviceNet Card has not been damaged during transportation--no defective electronic devices, dents, or warp.
- (3) The model name "OPC-F1-CCL" is printed on the DeviceNet Card. (See Figure 1.)

If you suspect the product is not working properly or if you have any questions about your product, contact your Fuji Electric representative.

This card corresponds to a soft version since 1300 of the FRENIC-Eco series inverters.

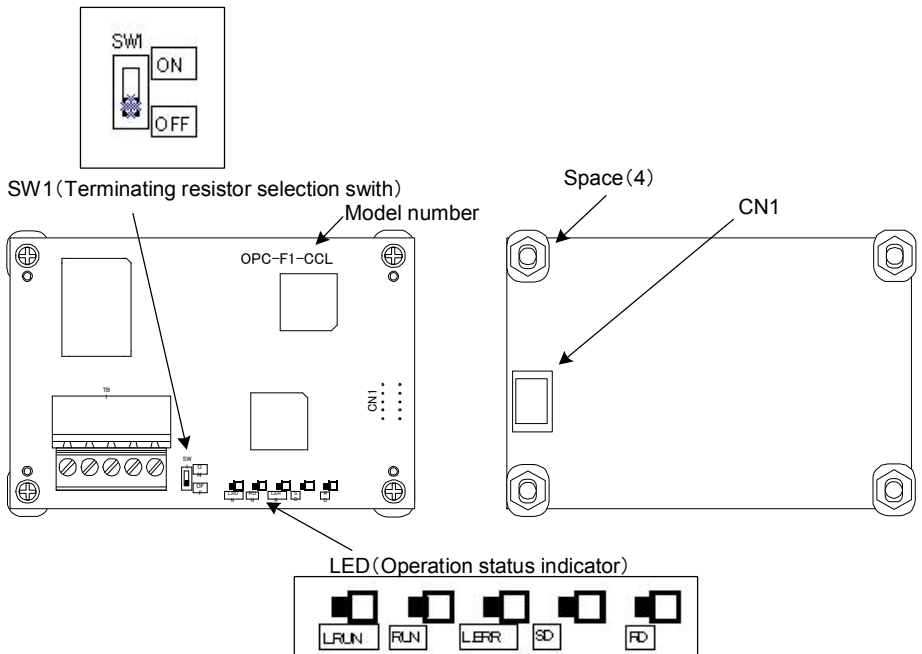

Figure1 Front of the Card

Figure2 Back of the Card

## Chapter3 Installation

### ⚠ WARNING

Turn the power off and wait for at least five minutes for models of 30 kW or below, or ten minutes for models of 37 kW or above, before starting installation. Further, check that the LED monitor is unlit, and check the DC link circuit voltage between the P (+) and N (-) terminals to be lower than 25 VDC.

**Otherwise, electric shock could occur.**

### ⚠ CAUTION

Do not touch any metallic part of the connector for the main unit (CN1) or any electronic component. Otherwise, electronic components may be damaged by static electricity. Also, the stain or adhesion of sweat or dust may adversely affect the contact reliability of the connector in the long run.

**An accident could occur.**

- (1) Remove the covers from the inverter to expose the control printed circuit (Figure 3).

 For the removal instructions, refer to the FRENIC-Eco Instruction Manual (INR-SI47-0852□), Chapter 2, Section 2.3 "Wiring." (For ratings of 37 kW or above, also open the keypad enclosure.)

- (2) Insert four spacers and connector CN1 on the back of the OPC-F1-CCL (Figure 2) into the four spacer holes and Port A (CN4) on the inverter's control printed circuit board (PCB) (Figure 4), respectively.

 **Note** Make sure, visually, that the spacers and CN1 are firmly inserted (Figure 5).

- (3) Install the wires for the OPC-F1-CCL.

 For wiring instructions, see Chapter 4.

- (4) Put the covers back to its original position.

 For the installation instructions, refer to the FRENIC-Eco Instruction Manual (INR-SI47-1059-E), Chapter 2, Section 2.3 "Wiring." (For ratings of 37 kW or above, also close the keypad enclosure.)

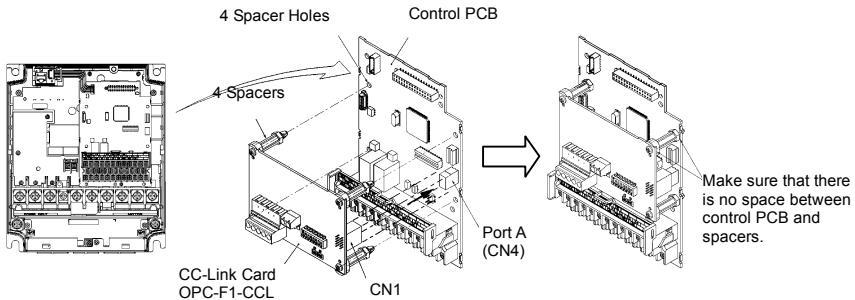

Figure 3 FRN7.5F1S-2J -  
FRN15F1S-2J  
(example)

Figure 4 Mounting the Card

Figure 5 Mounting Completed

## Chapter4 Wiring and Cabling

The wiring and cabling diagram is shown on the page that follows. Observe the following precautions when connecting the product.

When one inverter is connected:

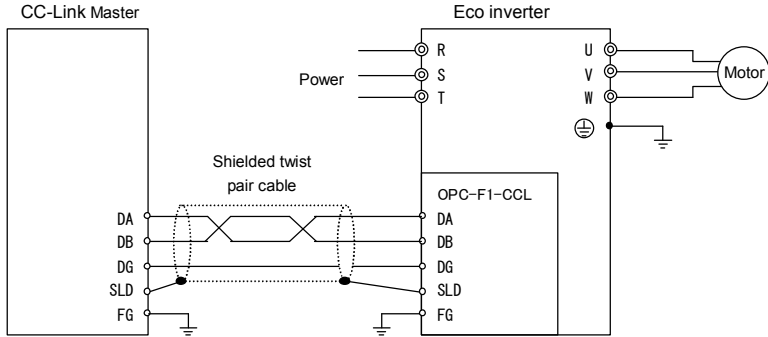

Figure 6 Inverter connection diagram (One unit)

Set SW1 to ON (With terminating resistor) .

When two or more inverters are connected:..... For the number of connected units, refer to chapter 14.

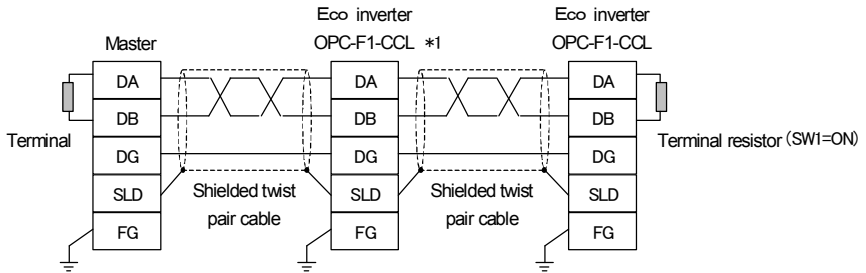

Figure 7 Inverter connection diagram (Two or more units)

\*1) For the unit in the middle, set SW1 to OFF(Without terminating resistor).



[Precautions about connection]

- (1) Use a special cable for the product. (Refer to chapter 14.)  
Never use a soldered cable because it may cause disconnection or wire break.
- (2) Wiring around the CC-Link pluggable connector

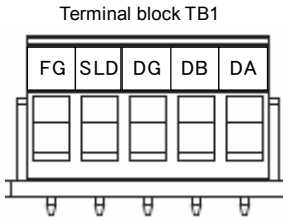

Figure 8

Table 1 Terminal board specifications

Terminal designation	Description	Remark
DA	Used for communication data	
DB		
DG		
SLD	Used for connecting the shield wire of the cable	The SLD and FG are connected each other in the unit.
FG	Used for connecting the earthing wire	

[Wiring around the grounding terminal (FG)]

Connecting the grounding terminal ( G ) on the inverter.

Applicable wire size : AWG24~12 (0.2mm<sup>2</sup>~2.5mm<sup>2</sup>)

Tightening torque : 0.5~0.6 [Nm]

**Note** For protection against external noise and prevention of failures, be sure to connect a grounding wire.

A typical pluggable connector meeting the specifications is MSTB 2.5/5-ST-5.08-AU made by Phoenix Contacts.

- (3) Terminating resistor switch (SW1)

By ON or OFF of SW1, internal terminating resistor can be set.

SW1	Description
OFF	Without terminating resistor
ON	110Ω

- (4) Use the terminating resistors supplied with the PLC.
- (5) Please refer to connected number in Chapter 14 for the maximum, connected number.

## Chapter5 Procedure for Introduction of the Option

The procedure for introducing CC-Link option is described here. Please prepare in the following steps:

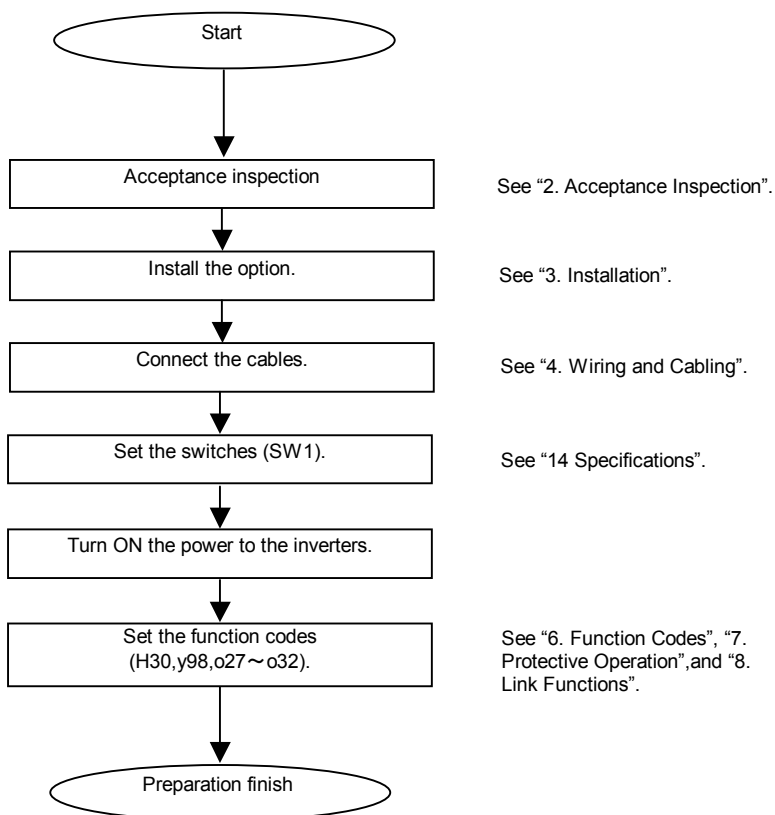

After the above steps have been done, the preparation for operating the inverters is complete.

Confirm the communication is normal after confirming the master side set with LED lit.

Refer to operation status indicate LED in Chapter 14 for lighting LED.

After the master side has been prepared, the inverters can be operated via CC-Link by setting RUN.

## Chapter6 Function Codes

### ⚠ CAUTION

If the data of a function code is incorrect, the system may fall into a dangerous status. Recheck data whenever you have finished setting or writing data. **An accident may occur.**

### 6.1 Standard function codes

There are restrictions on the standard function codes that can be accessed from CC-Link. For further information, refer to the Link No. in chapter 8

### 6.2 Function codes exclusive to communication

A common data format (S-code, M-code, W-code, X-code and Z-code) can be used as the specifications exclusive to communication. The data relating to the command / monitoring are defined other than the standard function codes. For the details of the communication-exclusive function codes, refer to Chapter 5 of FRENIC-Eco RS485 User's Manual (MEH448□). However, the following communication-exclusive function codes prohibit writing via CC-Link (allows reading).

Table2 Communication-exclusive function codes that prohibit writing

No.	Function code name	Reason
S01	Frequency command (p.u.)	Because the same data can be written from the remote output and the remote register. (Refer to "10. Communication Specifications".)
S05	Frequency command	
S06	Operation command	

### 6.3 Function codes exclusive to the option

In the software exclusive to CC-Link option, the operations o27, o28 and o30 in addition to the standard function codes, are available as the function codes exclusive to the option.

Table3 Function codes exclusive to the option

No.	Function code name	Setting range	Setting if a failure has occurred
o27	Operation when a failure has occurred	<u>0</u> ~15	The operation when the error is detected is selected.
o28	Communication failure when a failure has occurred	<u>0.0</u> ~60.0sec	Time set by the timer for continuing operation if a communication failure has occurred.
o30	Extended setting (Multiple setting)	<u>0.5</u> ~255	non operation
		1	Occupying one station (CC-Link Ver.1.1)
		2	Occupying one station double (CC-Link Ver.2)
		3	Occupying one station quadruple (CC-Link Ver.2)
		4	Occupying one station octuple (CC-Link Ver.2)
o31	CC-Link option station number setting	<u>0</u> ~64	Sets station number (address) (Setting value "0" is station number "1".)
		65~255	Invalidity
o32	CC-Link option Transmission Baud rate setting	0	156kbps
		1	625kbps
		2	2.5Mbps
		3	5Mbps
		4	10Mbps
		5~255	Invalidity



For the details of the function code o27 and o28, refer to "7. Protective Operation".

The underlined part is a factory setting value.

## Chapter7 Protective Operation

### 7.1 Protective Operation function codes

This section describes how to operate if a failure of communication line occurs when the system is being operated by operation command and speed command given through the CC-Link.

(1) The inverter operation to be performed if a CC-Link communication error occurs(o27).

o27	Inverter Operation in the Event of an Error		Note
0	Put the motor immediately in trip.	Er-5	
1	Immediately trip the inverter by force, when the time set by o28 (Timer) has expired.	Er-5	
2	Operating is continued to the return of the communication according to the last command. If the communication doesn't return to the end at the time of the timer of o28, the compulsion trip mode.	Er-5	
3	Operating is continued to the return of the communication, and after it returns, it follows the instruction in the communication.	Automatic return after communication returns	
4~9	Same as for [o27=0]		
10	Immediately decelerate the motor by force. When the motor has stopped, turn on er5.	Er-5	The forced deceleration period is specified by F08.
11	When the time set by o28 (Timer) has expired, immediately decelerate the motor by force, when the motor has stopped, turn on er5 .	Er-5	
12	Operating is continued to the return of the communication according to the last command. After decelerate the motor by force, turn on er5, if the communication doesn't return to the end at the time of the timer of o28.	Er-5	
13-15	Operating is continued to the return of the communication, and after it returns, it follows the instruction in the communication.	Automatic return after communication returns	

\*1 Communication line failure factor : Time over error

Option failure : When the MFP3 access error or the main body of the inverter and the communication error occurs, Er4 is generated. It doesn't relate to the setting value of o27.

\*2 Setting value of transmission Baud rate setting (o32) is reflected at the reset input (RST) or next power supply ON.

\*3 The factory values are all "0".

(2) Communication failure when a failure has occurred (o28)

0.0~60.0 sec

- When the function code o27=0 (Mode in which the inverter is forced to immediately in trip in case of communication failure)

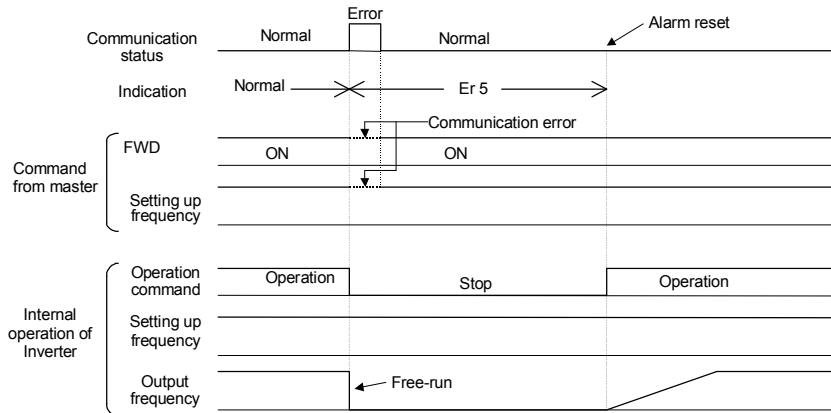

- When the function code o27=1 and o28=5.0 (Mode in which the inverter is forced to stop five seconds after a communication failure occurred)

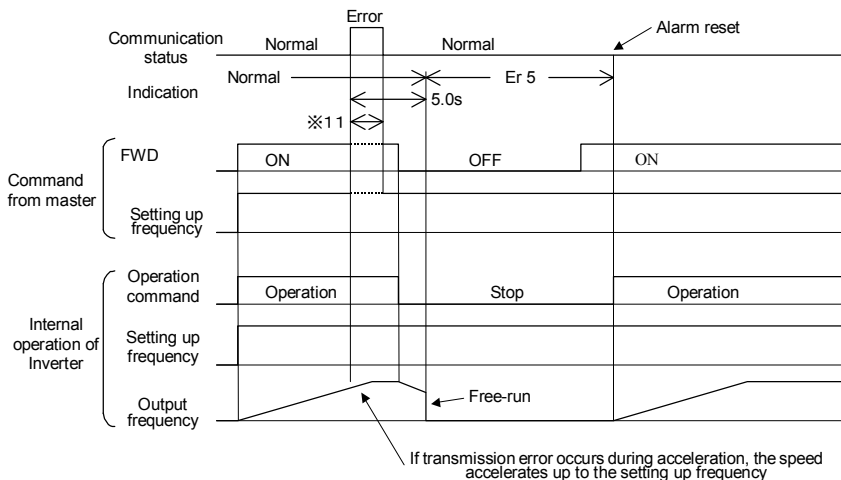

- When the function code o27=2 and o28=5.0 (When communications is not recovered although five seconds elapsed from the occurrence of a communications failure , and an er8 trip occurs)

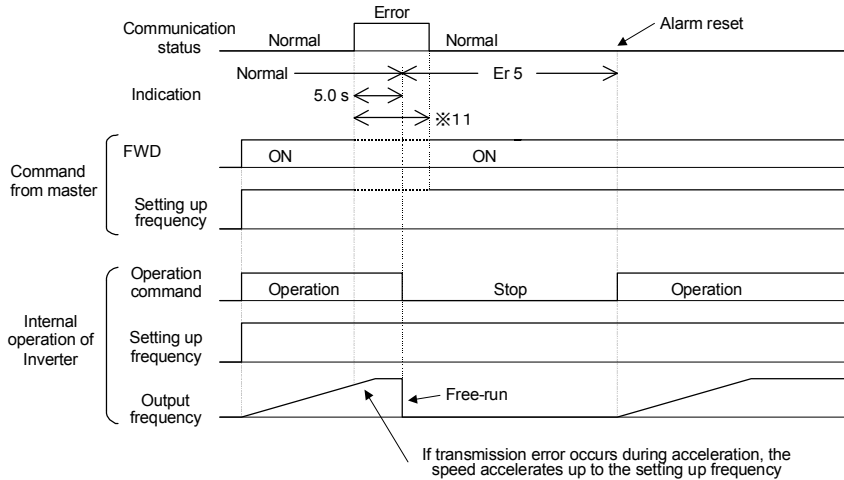

- When the function code o27=2 and o28=5.0 (When a communications failure occurred but communications was recovered within five seconds)

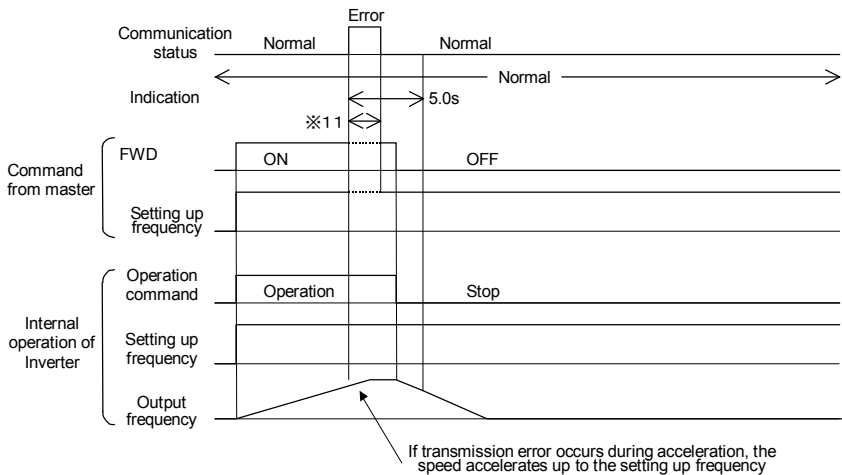

- When the function code o27=3,13 ~ 15 (Mode in which the inverter continues operating when a communication failure occurs)

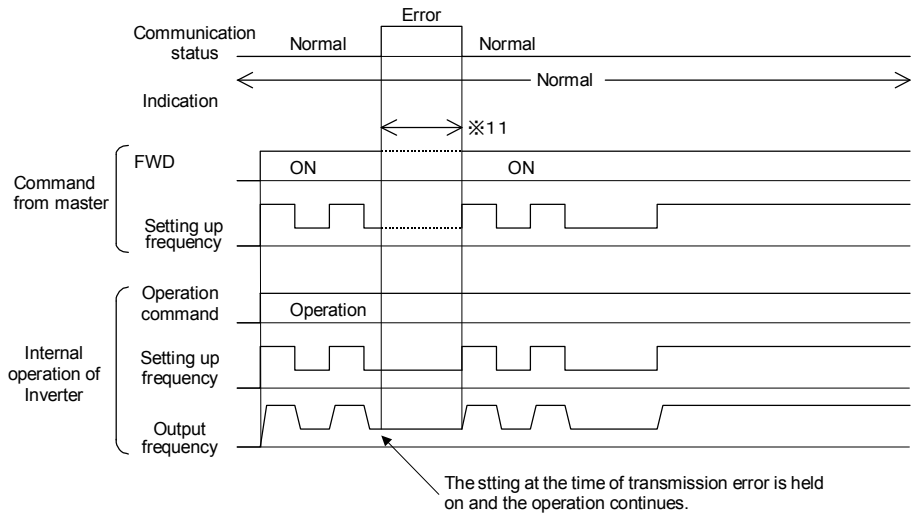

※ 1 1 For the period until communications is recovered, the command (command data, operation data) executed just before the communications failure had occurred is retained.

- When the function code o27=10 (Mode in which the inverter is forced to immediately stop when a communication failure occurs)

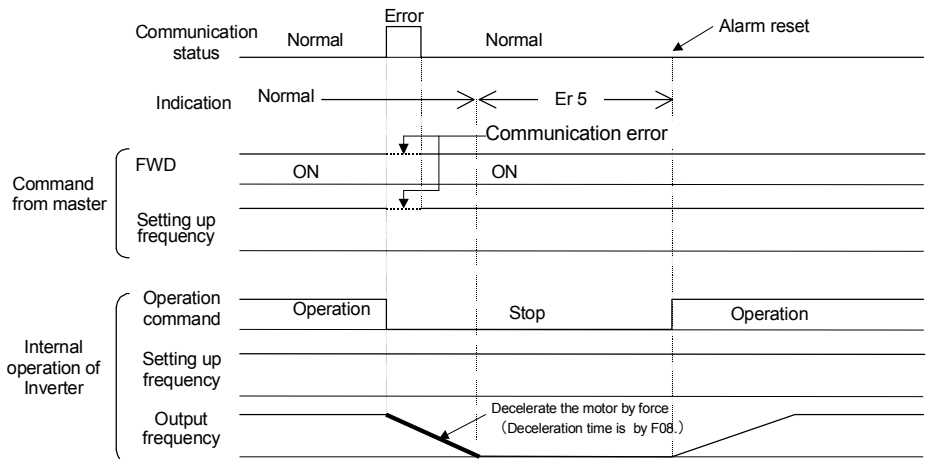

- When the function code o27=11 and o28=5.0 (Mode in which the inverter is forced to stop in 5 seconds when a communication failure occurs)

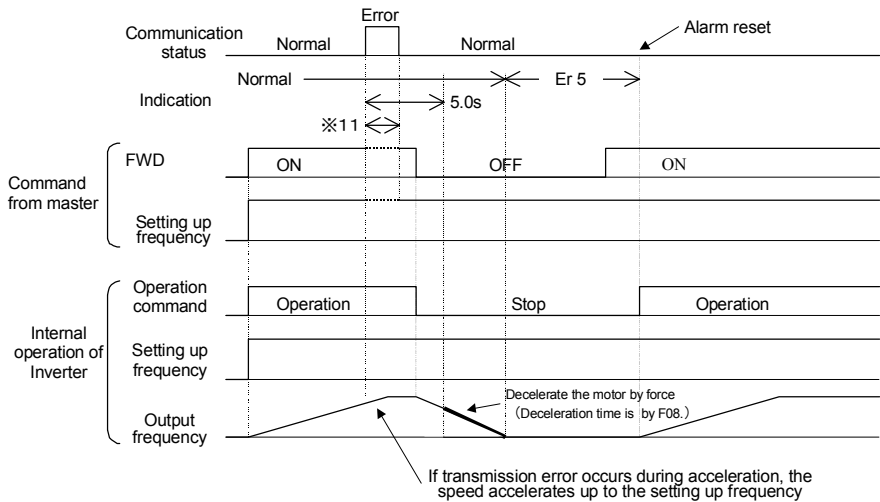

- When the function code o27=12 and o28=5.0 (Mode in which the communication returned within five seconds, when a communication failure occurs)

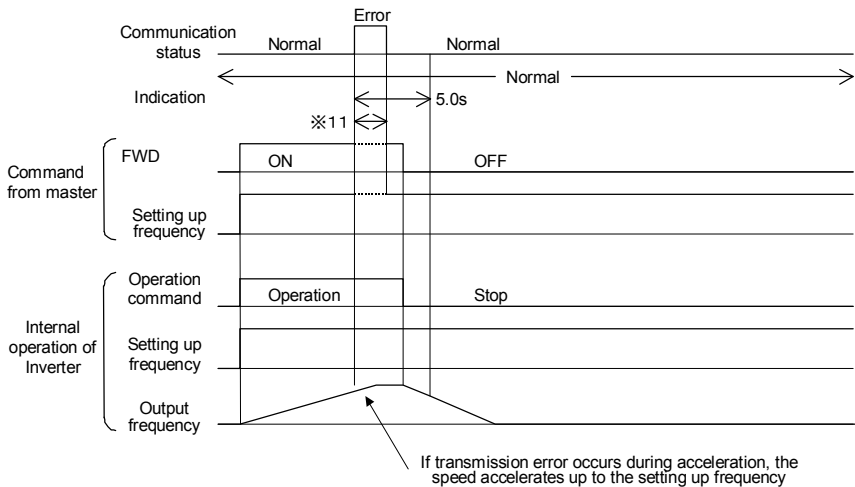



## Chapter8 Link Functions

The function code y98 "Bus Link function (Mode selection)" and the X function "24: operation selection through link [LE]" switch the validity (REM · LOC/COM) of command data (S area). Familiarize yourself with it together with the control block (Chapter 4 in the FRENIC-Eco User's Manual (MET456□)).

### 8.1 Enabling link operation

When the inverter is operated through the CC-Link, the operation must be switched to "Operation through link enable" mode and "command through communication (other than 0)" must be selected by y98 "Bus Link function (Mode selection)". (Such a flexible system configuration as operation command sent from the terminal board and speed command sent through communication is enabled by selecting the value of y98 "Bus Link function (Mode selection)".)

Condition			Mode
Assigning "24 : operation selection through link [LE]" to E01~E05 "X function selection"	Not assigned	Command code FB <sub>H</sub> (operation mode) = 0	"Operation through link enable" mode
		Command code FB <sub>H</sub> (operation mode) = 1	"Operation through link disable" mode
	Assigned	Corresponding X terminal ON	"Operation through link enable" mode
		Corresponding X terminal OFF	"Operation through link disable" mode

y98 setting value	"Operation through link enable" mode		"Operation through link disable" mode	
	Command data	Operation command	Command data	Operation command
0	×	×		×
1	○	×		×
2	×	○		×
3	○	○		×

○:Command through communication is valid. ×:Command through communication is invalid (Operation is enabled by the command from the terminal board or the keypad.)

 **Note** Even in "Operation through link disable" mode, S codes (command data, operation data) can be written.

### 8.2 Confirmation and writing of function code

The change (writing) and the confirmation (reading) in the function code from CC-Link are always effective.

## Chapter9 Communication between Sequencer

### 9.1 Outline of the communication

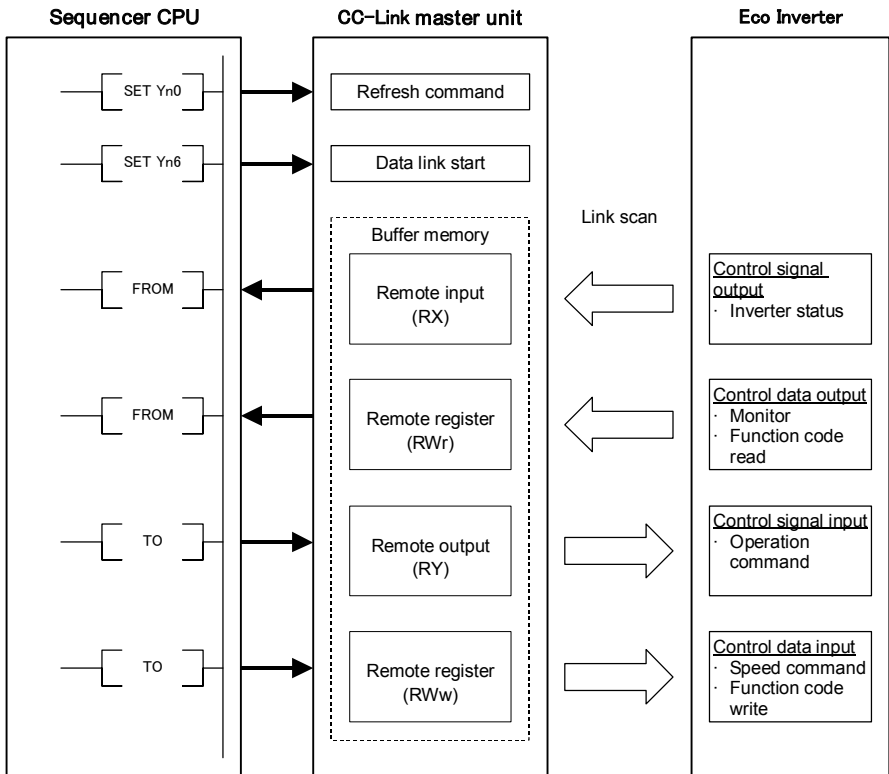

Figure 9

#### CC-Link master station

##### (1) CPU with automatic refresh function installed (Example: QnA-CPU)

Communication between the CC-Link master station and the remote device is performed by exchanging data through the sequence ladder and by automatically refreshing the refresh buffer of the master station with END command.

##### (2) CPU without automatic refresh function installed (Example: AnA-CPU)

Communication between the CC-Link master station and the remote device is performed by exchanging data directly with the refresh buffer of the master station through the sequence ladder.

## 9.2 Reliability of data exchanged through link

- Consistency between the bit data and word data exchanged through link is established by the data configuration in which bit data of different timing from word data can not be included in a word data when bit data changes.
- The buffer operation commands of master unit (FROM, TO), different from normal inputs/outputs, are not updated in batch, but processed through interrupt during execution of the program. The input/output operation through link are executed at the timing of the command. So, note the following three points:
  - (1) Execute data acquisition by FROM command at the start of the program.
  - (2) Execute update of output by TO command after all the related internal processing has finished.
  - (3) Execute update of output buffers of a unit at a same time (in one row).

 Tip It is recommended that all the link buffers are updated in batch.。

### 9.3 Using area of buffer memory

#### (1) Remote input signal (Inverter → Master)

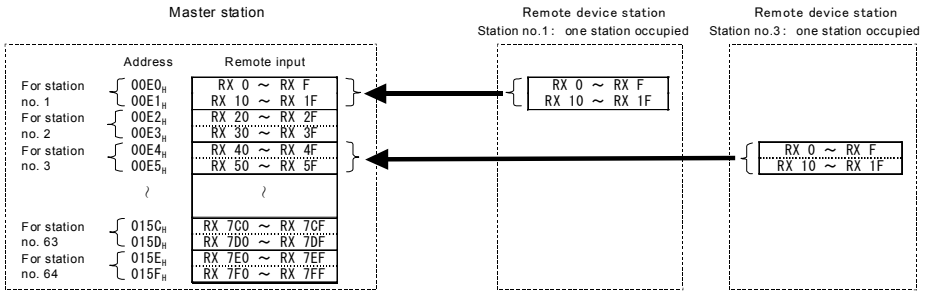

Figure 10

#### (2) Remote output signal (Master → Inverter)

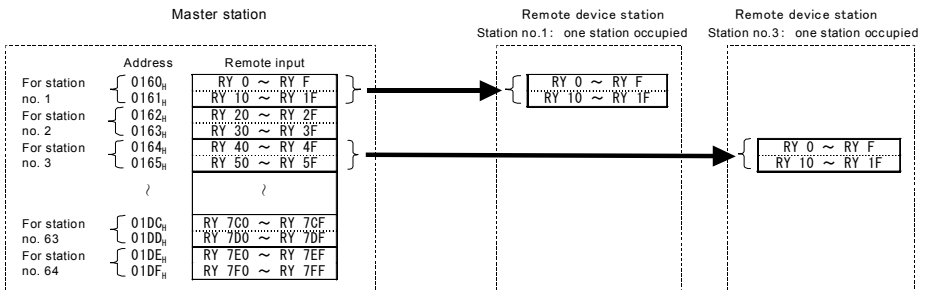

Figure 11

#### (3) Remote register (Master → Inverter)

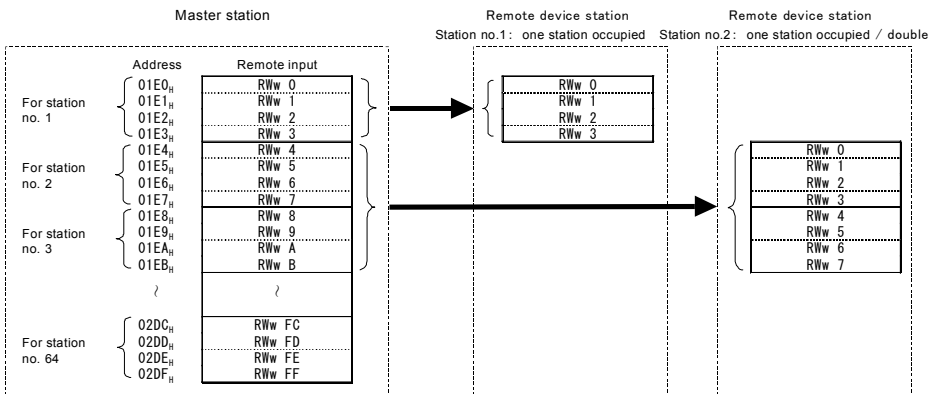

Figure 12

#### (4) Remote register (Inverter → Master)

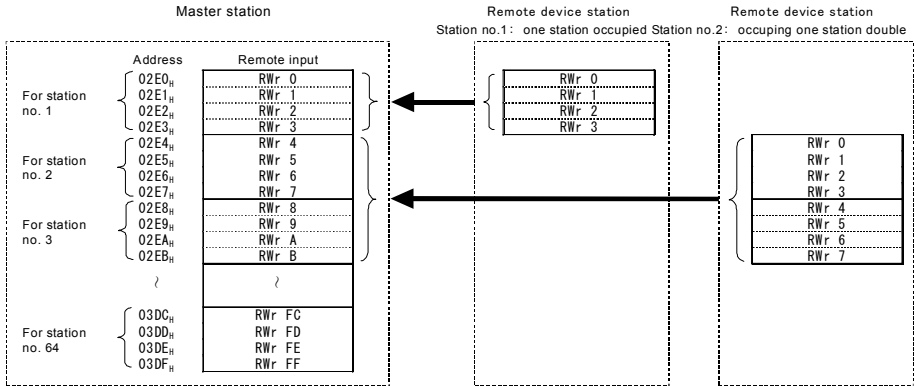

Figure 13

## 9.4 Using addresses of buffer memory

Table 4 Conversion formula of buffer memory address

Master	Conversion formula (Derive register number divided by buffer memory address from station no.)		
		Remote input/output signal	Remote register
CPU with automatic refresh function installed (QnA type)	Register no.	$(\text{Station no.}-1) \times 20_{\text{H}}$	$(\text{Station no.}-1) \times 4_{\text{H}}$
CPU without automatic refresh function installed (AnA type)	Address	Buffer memory top address + $(\text{station no.}-1) \times 2_{\text{H}}$	Buffer memory top address + $(\text{station no.}-1) \times 4_{\text{H}}$

Table 5 Buffer memory address assignment

Station no.	Remote input/output signal				Remote register			
	Input (Inverter → Master)		Output (Master → Inverter)		Master → Inverter		Inverter → Master	
	Register no.	Address	Register no.	Address	Register no.	Address	Register no.	Address
1	RX 0~RX 1F	00E0 <sub>H</sub> ~00E1 <sub>H</sub>	RY 0~RY 1F	0160 <sub>H</sub> ~0161 <sub>H</sub>	RWw 0~RWw 3	01E0 <sub>H</sub> ~01E3 <sub>H</sub>	RWr 0~RWr 3	02E0 <sub>H</sub> ~02E3 <sub>H</sub>
2	RX 20~RX 3F	00E2 <sub>H</sub> ~00E3 <sub>H</sub>	RY 20~RY 3F	0162 <sub>H</sub> ~0163 <sub>H</sub>	RWw 4~RWw 7	01E4 <sub>H</sub> ~01E7 <sub>H</sub>	RWr 4~RWr 7	02E4 <sub>H</sub> ~02E7 <sub>H</sub>
3	RX 40~RX 5F	00E4 <sub>H</sub> ~00E5 <sub>H</sub>	RY 40~RY 5F	0164 <sub>H</sub> ~0165 <sub>H</sub>	RWw 8~RWw B	01E8 <sub>H</sub> ~01EB <sub>H</sub>	RWr 8~RWr B	02E8 <sub>H</sub> ~02EB <sub>H</sub>
4	RX 60~RX 7F	00E6 <sub>H</sub> ~00E7 <sub>H</sub>	RY 60~RY 7F	0166 <sub>H</sub> ~0167 <sub>H</sub>	RWw C~RWw F	01EC <sub>H</sub> ~01EF <sub>H</sub>	RWr C~RWr F	02EC <sub>H</sub> ~02EF <sub>H</sub>
5	RX 80~RX 9F	00E8 <sub>H</sub> ~00E9 <sub>H</sub>	RY 80~RY 9F	0168 <sub>H</sub> ~0169 <sub>H</sub>	RWw10~RWw13	01F0 <sub>H</sub> ~01F3 <sub>H</sub>	RWr10~RWr13	02F0 <sub>H</sub> ~02F3 <sub>H</sub>
6	RX A0~RX BF	00EA <sub>H</sub> ~00EB <sub>H</sub>	RY A0~RY BF	016A <sub>H</sub> ~016B <sub>H</sub>	RWw14~RWw17	01F4 <sub>H</sub> ~01F7 <sub>H</sub>	RWr14~RWr17	02F4 <sub>H</sub> ~02F7 <sub>H</sub>
7	RX C0~RX DF	00EC <sub>H</sub> ~00ED <sub>H</sub>	RY C0~RY DF	016C <sub>H</sub> ~016D <sub>H</sub>	RWw18~RWw1B	01F8 <sub>H</sub> ~01FB <sub>H</sub>	RWr18~RWr1B	02F8 <sub>H</sub> ~02FB <sub>H</sub>
8	RX E0~RX FF	00EE <sub>H</sub> ~00EF <sub>H</sub>	RY E0~RY FF	016E <sub>H</sub> ~016F <sub>H</sub>	RWw1C~RWw1F	01FC <sub>H</sub> ~01FF <sub>H</sub>	RWr1C~RWr1F	02FC <sub>H</sub> ~02FF <sub>H</sub>
9	RX100~RX11F	00F0 <sub>H</sub> ~00F1 <sub>H</sub>	RY100~RY11F	0170 <sub>H</sub> ~0171 <sub>H</sub>	RWw20~RWw23	0200 <sub>H</sub> ~0203 <sub>H</sub>	RWr20~RWr23	0300 <sub>H</sub> ~0303 <sub>H</sub>
10	RX120~RX13F	00F2 <sub>H</sub> ~00F3 <sub>H</sub>	RY120~RY13F	0072 <sub>H</sub> ~0173 <sub>H</sub>	RWw24~RWw27	0204 <sub>H</sub> ~0207 <sub>H</sub>	RWr24~RWr27	0304 <sub>H</sub> ~0307 <sub>H</sub>
11	RX140~RX15F	00F4 <sub>H</sub> ~00F5 <sub>H</sub>	RY140~RY15F	0074 <sub>H</sub> ~0175 <sub>H</sub>	RWw28~RWw2B	0208 <sub>H</sub> ~020B <sub>H</sub>	RWr28~RWr2B	0308 <sub>H</sub> ~030B <sub>H</sub>
12	RX160~RX17F	00F6 <sub>H</sub> ~00F7 <sub>H</sub>	RY160~RY17F	0076 <sub>H</sub> ~0177 <sub>H</sub>	RWw2C~RWw2F	020C <sub>H</sub> ~020F <sub>H</sub>	RWr2C~RWr2F	030C <sub>H</sub> ~030F <sub>H</sub>
13	RX180~RX19F	00F8 <sub>H</sub> ~00F9 <sub>H</sub>	RY180~RY19F	0078 <sub>H</sub> ~0179 <sub>H</sub>	RWw30~RWw33	0210 <sub>H</sub> ~0213 <sub>H</sub>	RWr30~RWr33	0310 <sub>H</sub> ~0313 <sub>H</sub>
14	RX1A0~RX1BF	00FA <sub>H</sub> ~00FB <sub>H</sub>	RY1A0~RY1BF	007A <sub>H</sub> ~017B <sub>H</sub>	RWw34~RWw37	0214 <sub>H</sub> ~0217 <sub>H</sub>	RWr34~RWr37	0314 <sub>H</sub> ~0317 <sub>H</sub>
15	RX1C0~RX1DF	00FC <sub>H</sub> ~00FD <sub>H</sub>	RY1C0~RY1DF	007C <sub>H</sub> ~017D <sub>H</sub>	RWw38~RWw3B	0218 <sub>H</sub> ~021B <sub>H</sub>	RWr38~RWr3B	0318 <sub>H</sub> ~031B <sub>H</sub>
16	RX1E0~RX1FF	00FE <sub>H</sub> ~00FF <sub>H</sub>	RY1E0~RY1FF	007E <sub>H</sub> ~017F <sub>H</sub>	RWw3C~RWw3F	021C <sub>H</sub> ~021F <sub>H</sub>	RWr3C~RWr3F	031C <sub>H</sub> ~031F <sub>H</sub>
17	RX200~RX21F	0100 <sub>H</sub> ~0101 <sub>H</sub>	RY200~RY21F	0180 <sub>H</sub> ~0181 <sub>H</sub>	RWw40~RWw43	0220 <sub>H</sub> ~0223 <sub>H</sub>	RWr40~RWr43	0320 <sub>H</sub> ~0323 <sub>H</sub>
18	RX220~RX23F	0102 <sub>H</sub> ~0103 <sub>H</sub>	RY220~RY23F	0182 <sub>H</sub> ~0183 <sub>H</sub>	RWw44~RWw47	0224 <sub>H</sub> ~0227 <sub>H</sub>	RWr44~RWr47	0324 <sub>H</sub> ~0327 <sub>H</sub>
19	RX240~RX25F	0104 <sub>H</sub> ~0105 <sub>H</sub>	RY240~RY25F	0184 <sub>H</sub> ~0185 <sub>H</sub>	RWw48~RWw4B	0228 <sub>H</sub> ~022B <sub>H</sub>	RWr48~RWr4B	0328 <sub>H</sub> ~032B <sub>H</sub>
20	RX260~RX27F	0106 <sub>H</sub> ~0107 <sub>H</sub>	RY260~RY27F	0186 <sub>H</sub> ~0187 <sub>H</sub>	RWw4C~RWw4F	022C <sub>H</sub> ~022F <sub>H</sub>	RWr4C~RWr4F	032C <sub>H</sub> ~032F <sub>H</sub>
21	RX280~RX29F	0108 <sub>H</sub> ~0109 <sub>H</sub>	RY280~RY29F	0188 <sub>H</sub> ~0189 <sub>H</sub>	RWw50~RWw53	0230 <sub>H</sub> ~0233 <sub>H</sub>	RWr50~RWr53	0330 <sub>H</sub> ~0333 <sub>H</sub>

Station no.	Remote input/output signal				Remote register			
	Input (Inverter → Master)		Output (Master → Inverter)		Master → Inverter		Inverter → Master	
	Register no.	Address	Register no.	Address	Register no.	Address	Register no.	Address
22	RX2A0~RX2BF	010A <sub>H</sub> ~010B <sub>H</sub>	RY2A0~RY2BF	018A <sub>H</sub> ~018B <sub>H</sub>	RWw54~RWw57	0234 <sub>H</sub> ~0237 <sub>H</sub>	RWr54~RWr57	0334 <sub>H</sub> ~0337 <sub>H</sub>
23	RX2C0~RX2DF	010C <sub>H</sub> ~010D <sub>H</sub>	RY2C0~RY2DF	018C <sub>H</sub> ~018D <sub>H</sub>	RWw58~RWw5B	0238 <sub>H</sub> ~023B <sub>H</sub>	RWr58~RWr5B	0338 <sub>H</sub> ~033B <sub>H</sub>
24	RX2E0~RX2FF	010E <sub>H</sub> ~010F <sub>H</sub>	RY2E0~RY2FF	018E <sub>H</sub> ~018F <sub>H</sub>	RWw5C~RWw5F	023C <sub>H</sub> ~023F <sub>H</sub>	RWr5C~RWr5F	033C <sub>H</sub> ~033F <sub>H</sub>
25	RX300~RX31F	0110 <sub>H</sub> ~0111 <sub>H</sub>	RY300~RY31F	0190 <sub>H</sub> ~0191 <sub>H</sub>	RWw60~RWw63	0240 <sub>H</sub> ~0243 <sub>H</sub>	RWr60~RWr63	0340 <sub>H</sub> ~0343 <sub>H</sub>
26	RX320~RX33F	0112 <sub>H</sub> ~0113 <sub>H</sub>	RY320~RY33F	0192 <sub>H</sub> ~0193 <sub>H</sub>	RWw64~RWw67	0244 <sub>H</sub> ~0247 <sub>H</sub>	RWr64~RWr67	0344 <sub>H</sub> ~0347 <sub>H</sub>
27	RX340~RX35F	0114 <sub>H</sub> ~0115 <sub>H</sub>	RY340~RY35F	0194 <sub>H</sub> ~0195 <sub>H</sub>	RWw68~RWw6B	0248 <sub>H</sub> ~024B <sub>H</sub>	RWr68~RWr6B	0348 <sub>H</sub> ~034B <sub>H</sub>
28	RX360~RX37F	0116 <sub>H</sub> ~0117 <sub>H</sub>	RY360~RY37F	0196 <sub>H</sub> ~0197 <sub>H</sub>	RWw6C~RWw6F	024C <sub>H</sub> ~024F <sub>H</sub>	RWr6C~RWr6F	034C <sub>H</sub> ~034F <sub>H</sub>
29	RX380~RX39F	0118 <sub>H</sub> ~0119 <sub>H</sub>	RY380~RY39F	0198 <sub>H</sub> ~0199 <sub>H</sub>	RWw70~RWw73	0250 <sub>H</sub> ~0253 <sub>H</sub>	RWr70~RWr73	0350 <sub>H</sub> ~0353 <sub>H</sub>
30	RX3A0~RX3BF	011A <sub>H</sub> ~011B <sub>H</sub>	RY3A0~RY3BF	019A <sub>H</sub> ~019B <sub>H</sub>	RWw74~RWw77	0254 <sub>H</sub> ~0257 <sub>H</sub>	RWr74~RWr77	0354 <sub>H</sub> ~0357 <sub>H</sub>
31	RX3C0~RX3DF	011C <sub>H</sub> ~011D <sub>H</sub>	RY3C0~RY3DF	019C <sub>H</sub> ~019D <sub>H</sub>	RWw78~RWw7B	0258 <sub>H</sub> ~025B <sub>H</sub>	RWr78~RWr7B	0358 <sub>H</sub> ~035B <sub>H</sub>
32	RX3E0~RX3FF	011E <sub>H</sub> ~011F <sub>H</sub>	RY3E0~RY3FF	019E <sub>H</sub> ~019F <sub>H</sub>	RWw7C~RWw7F	025C <sub>H</sub> ~025F <sub>H</sub>	RWr7C~RWr7F	035C <sub>H</sub> ~035F <sub>H</sub>
33	RX400~RX41F	0120 <sub>H</sub> ~0121 <sub>H</sub>	RY400~RY41F	01A0 <sub>H</sub> ~01A1 <sub>H</sub>	RWw80~RWw83	0260 <sub>H</sub> ~0263 <sub>H</sub>	RWr80~RWr83	0360 <sub>H</sub> ~0363 <sub>H</sub>
34	RX420~RX43F	0122 <sub>H</sub> ~0123 <sub>H</sub>	RY420~RY43F	01A2 <sub>H</sub> ~01A3 <sub>H</sub>	RWw84~RWw87	0264 <sub>H</sub> ~0267 <sub>H</sub>	RWr84~RWr87	0364 <sub>H</sub> ~0367 <sub>H</sub>
35	RX440~RX45F	0124 <sub>H</sub> ~0125 <sub>H</sub>	RY440~RY45F	01A4 <sub>H</sub> ~01A5 <sub>H</sub>	RWw88~RWw8B	0268 <sub>H</sub> ~026B <sub>H</sub>	RWr88~RWr8B	0368 <sub>H</sub> ~036B <sub>H</sub>
36	RX460~RX47F	0126 <sub>H</sub> ~0127 <sub>H</sub>	RY460~RY47F	01A6 <sub>H</sub> ~01A7 <sub>H</sub>	RWw8C~RWw8F	026C <sub>H</sub> ~026F <sub>H</sub>	RWr8C~RWr8F	036C <sub>H</sub> ~036F <sub>H</sub>
37	RX480~RX49F	0128 <sub>H</sub> ~0129 <sub>H</sub>	RY480~RY49F	01A8 <sub>H</sub> ~01A9 <sub>H</sub>	RWw90~RWw93	0270 <sub>H</sub> ~0273 <sub>H</sub>	RWr90~RWr93	0370 <sub>H</sub> ~0373 <sub>H</sub>
38	RX4A0~RX4BF	012A <sub>H</sub> ~012B <sub>H</sub>	RY4A0~RY4BF	01AA <sub>H</sub> ~01AB <sub>H</sub>	RWw94~RWw97	0274 <sub>H</sub> ~0277 <sub>H</sub>	RWr94~RWr97	0374 <sub>H</sub> ~0377 <sub>H</sub>
39	RX4C0~RX4DF	012C <sub>H</sub> ~012D <sub>H</sub>	RY4C0~RY4DF	01AC <sub>H</sub> ~01AD <sub>H</sub>	RWw98~RWw9B	0278 <sub>H</sub> ~027B <sub>H</sub>	RWr98~RWr9B	0378 <sub>H</sub> ~037B <sub>H</sub>
40	RX4E0~RX4FF	012E <sub>H</sub> ~012F <sub>H</sub>	RY4E0~RY4FF	01AE <sub>H</sub> ~01AF <sub>H</sub>	RWw9C~RWw9F	027C <sub>H</sub> ~027F <sub>H</sub>	RWr9C~RWr9F	037C <sub>H</sub> ~037F <sub>H</sub>
41	RX500~RX51F	0130 <sub>H</sub> ~0131 <sub>H</sub>	RY500~RY51F	01B0 <sub>H</sub> ~01B1 <sub>H</sub>	RWwA0~RWwA3	0280 <sub>H</sub> ~0283 <sub>H</sub>	RWrA0~RWrA3	0380 <sub>H</sub> ~0383 <sub>H</sub>
42	RX520~RX53F	0132 <sub>H</sub> ~0133 <sub>H</sub>	RY520~RY53F	01B2 <sub>H</sub> ~01B3 <sub>H</sub>	RWwA4~RWwA7	0284 <sub>H</sub> ~0287 <sub>H</sub>	RWrA4~RWrA7	0384 <sub>H</sub> ~0387 <sub>H</sub>
43	RX540~RX55F	0134 <sub>H</sub> ~0135 <sub>H</sub>	RY540~RY55F	01B4 <sub>H</sub> ~01B5 <sub>H</sub>	RWwA8~RWwAB	0288 <sub>H</sub> ~028B <sub>H</sub>	RWrA8~RWrAB	0388 <sub>H</sub> ~038B <sub>H</sub>
44	RX560~RX57F	0136 <sub>H</sub> ~0137 <sub>H</sub>	RY560~RY57F	01B6 <sub>H</sub> ~01B7 <sub>H</sub>	RWwAC~RWwAF	028C <sub>H</sub> ~028F <sub>H</sub>	RWrAC~RWrAF	038C <sub>H</sub> ~038F <sub>H</sub>
45	RX580~RX59F	0138 <sub>H</sub> ~0139 <sub>H</sub>	RY580~RY59F	01B8 <sub>H</sub> ~01B9 <sub>H</sub>	RWwB0~RWwB3	0290 <sub>H</sub> ~0293 <sub>H</sub>	RWrB0~RWrB3	0390 <sub>H</sub> ~0393 <sub>H</sub>
46	RX5A0~RX5BF	013A <sub>H</sub> ~013B <sub>H</sub>	RY5A0~RY5BF	01BA <sub>H</sub> ~01BB <sub>H</sub>	RWwB4~RWwB7	0294 <sub>H</sub> ~0297 <sub>H</sub>	RWrB4~RWrB7	0394 <sub>H</sub> ~0397 <sub>H</sub>
47	RX5C0~RX5DF	013C <sub>H</sub> ~013D <sub>H</sub>	RY5C0~RY5DF	01BC <sub>H</sub> ~01BD <sub>H</sub>	RWwB8~RWwBB	0298 <sub>H</sub> ~029B <sub>H</sub>	RWrB8~RWrBB	0398 <sub>H</sub> ~039B <sub>H</sub>
48	RX5E0~RX5FF	013E <sub>H</sub> ~013F <sub>H</sub>	RY5E0~RY5FF	01BE <sub>H</sub> ~01BF <sub>H</sub>	RWwBC~RWwBF	029C <sub>H</sub> ~029F <sub>H</sub>	RWrBC~RWrBF	039C <sub>H</sub> ~039F <sub>H</sub>
49	RX600~RX61F	0140 <sub>H</sub> ~0141 <sub>H</sub>	RY600~RY61F	01C0 <sub>H</sub> ~01C1 <sub>H</sub>	RWwC0~RWwC3	02A0 <sub>H</sub> ~02A3 <sub>H</sub>	RWrC0~RWrC3	03A0 <sub>H</sub> ~03A3 <sub>H</sub>
50	RX620~RX63F	0142 <sub>H</sub> ~0143 <sub>H</sub>	RY620~RY63F	01C2 <sub>H</sub> ~01C3 <sub>H</sub>	RWwC4~RWwC7	02A4 <sub>H</sub> ~02A7 <sub>H</sub>	RWrC4~RWrC7	03A4 <sub>H</sub> ~03A7 <sub>H</sub>
51	RX640~RX65F	0144 <sub>H</sub> ~0145 <sub>H</sub>	RY640~RY65F	01C4 <sub>H</sub> ~01C5 <sub>H</sub>	RWwC8~RWwCB	02A8 <sub>H</sub> ~02AB <sub>H</sub>	RWrC8~RWrCB	03A8 <sub>H</sub> ~03AB <sub>H</sub>
52	RX660~RX67F	0146 <sub>H</sub> ~0147 <sub>H</sub>	RY660~RY67F	01C6 <sub>H</sub> ~01C7 <sub>H</sub>	RWwCC~RWwCF	02AC <sub>H</sub> ~02AF <sub>H</sub>	RWrCC~RWrCF	03AC <sub>H</sub> ~03AF <sub>H</sub>
53	RX680~RX69F	0148 <sub>H</sub> ~0149 <sub>H</sub>	RY680~RY69F	01C8 <sub>H</sub> ~01C9 <sub>H</sub>	RWwD0~RWwD3	02B0 <sub>H</sub> ~02B3 <sub>H</sub>	RWrD0~RWrD3	03B0 <sub>H</sub> ~03B3 <sub>H</sub>
54	RX6A0~RX6BF	014A <sub>H</sub> ~014B <sub>H</sub>	RY6A0~RY6BF	01CA <sub>H</sub> ~01CB <sub>H</sub>	RWwD4~RWwD7	02B4 <sub>H</sub> ~02B7 <sub>H</sub>	RWrD4~RWrD7	03B4 <sub>H</sub> ~03B7 <sub>H</sub>
55	RX6C0~RX6DF	014C <sub>H</sub> ~014D <sub>H</sub>	RY6C0~RY6DF	01CC <sub>H</sub> ~01CD <sub>H</sub>	RWwD8~RWwDB	02B8 <sub>H</sub> ~02BB <sub>H</sub>	RWrD8~RWrDB	03B8 <sub>H</sub> ~03BB <sub>H</sub>
56	RX6E0~RX6FF	014E <sub>H</sub> ~014F <sub>H</sub>	RY6E0~RY6FF	01CE <sub>H</sub> ~01CF <sub>H</sub>	RWwDC~RWwDF	02BC <sub>H</sub> ~02BF <sub>H</sub>	RWrDC~RWrDF	03BC <sub>H</sub> ~03BF <sub>H</sub>
57	RX700~RX71F	0150 <sub>H</sub> ~0151 <sub>H</sub>	RY700~RY71F	01D0 <sub>H</sub> ~01D1 <sub>H</sub>	RWwE0~RWwE3	02C0 <sub>H</sub> ~02C3 <sub>H</sub>	RWrE0~RWrE3	03C0 <sub>H</sub> ~03C3 <sub>H</sub>
58	RX720~RX73F	0152 <sub>H</sub> ~0153 <sub>H</sub>	RY720~RY73F	01D2 <sub>H</sub> ~01D3 <sub>H</sub>	RWwE4~RWwE7	02C4 <sub>H</sub> ~02C7 <sub>H</sub>	RWrE4~RWrE7	03C4 <sub>H</sub> ~03C7 <sub>H</sub>
59	RX740~RX75F	0154 <sub>H</sub> ~0155 <sub>H</sub>	RY740~RY75F	01D4 <sub>H</sub> ~01D5 <sub>H</sub>	RWwE8~RWwEB	02C8 <sub>H</sub> ~02CB <sub>H</sub>	RWrE8~RWrEB	03C8 <sub>H</sub> ~03CB <sub>H</sub>
60	RX760~RX77F	0156 <sub>H</sub> ~0157 <sub>H</sub>	RY760~RY77F	01D6 <sub>H</sub> ~01D7 <sub>H</sub>	RWwEC~RWwEF	02CC <sub>H</sub> ~02CF <sub>H</sub>	RWrEC~RWrEF	03CC <sub>H</sub> ~03CF <sub>H</sub>
61	RX780~RX79F	0158 <sub>H</sub> ~0159 <sub>H</sub>	RY780~RY79F	01D8 <sub>H</sub> ~01D9 <sub>H</sub>	RWwF0~RWwF3	02D0 <sub>H</sub> ~02D3 <sub>H</sub>	RWrF0~RWrF3	03D0 <sub>H</sub> ~03D3 <sub>H</sub>
62	RX7A0~RX7BF	015A <sub>H</sub> ~015B <sub>H</sub>	RY7A0~RY7BF	01DA <sub>H</sub> ~01DB <sub>H</sub>	RWwF4~RWwF7	02D4 <sub>H</sub> ~02D7 <sub>H</sub>	RWrF4~RWrF7	03D4 <sub>H</sub> ~03D7 <sub>H</sub>
63	RX7C0~RX7DF	015C <sub>H</sub> ~015D <sub>H</sub>	RY7C0~RY7DF	01DC <sub>H</sub> ~01DD <sub>H</sub>	RWwF8~RWwFB	02D8 <sub>H</sub> ~02DB <sub>H</sub>	RWrF8~RWrFB	03D8 <sub>H</sub> ~03DB <sub>H</sub>
64	RX7E0~RX7FF	015E <sub>H</sub> ~015F <sub>H</sub>	RY7E0~RY7FF	01DE <sub>H</sub> ~01DF <sub>H</sub>	RWwFC~RWwFF	02DC <sub>H</sub> ~02DF <sub>H</sub>	RWrFC~RWrFF	03DC <sub>H</sub> ~03DF <sub>H</sub>

## Chapter10 Communication specification

### 10.1 Input/output signal list

Table 6 Output signals (Master → Inverter)

Device no.	Signal name	Description	
RYn0	Forward command	OFF: Stop command ON: Forward rotation	Simultaneous turn-on of RYn0 and RYn1 makes stop command.
RYn1	Reverse command	OFF: Stop command ON: Reverse rotation	
RYn2	X1 terminal function	Uses it as a self-maintenance signal when the three-wire is operated. (HLD) is ON, (FWD) or (REV) signal is self-maintained, and this maintenance is released by turning off.	Function of each X terminal (E01 ~ E05) can be changed by setting X-terminal function selection.
RYn3	X2 terminal function	Turning this On works as the free-run command (BX). (Secondary side output is cut off)	
RYn4	X3 terminal function	Turning this ON works as the abnormal rest (RST).	
RYn5	X4 terminal function	Turning this On works as selected frequency setting 2(Hz2/Hz1).	
RYn6	X5 terminal function	Turning this On works as the operation command and the frequency setting from the touch panel become effective(LOC).	
RYn7	Unused	-	
RYn8	Unused	-	
RYn9	Secondary side output is cut off (BX)	Turning this On works as the free-run command (BX). (Secondary side output is cut off)	
RYnA	Unused	-	
RYnB	Unused	-	
RYnC *1	Monitor command	By turning ON the monitor command (RYnC), the monitor value is set to RWrn, and the monitoring (RXnC) is turned ON.	
RYnD *2	Speed setting command (RAM)	By turning ON the frequency setting command (RYnD), the speed command (RWwn+1) is written in the volatile memory (RAM) of the inverter. <sup>Note2</sup> After the writing has finished, "frequency setting complete" (RXnD) is turned ON. If a frequency setting error occurs, a value other than 0 is set to the response code (RWrn+2).	
RYnE	Unused	-	
RYnF *3	Command code execution request	By turning ON the command code request command (RYnF), the processing corresponding to the command code set to the command code (RW wn+2) is executed. <sup>Note 3</sup> After the command code has been executed, "command code execution complete" (RXnF) is turned ON. If a command code execution error occurs, a value other than 0 is set to the response code (RWrn+2).	
RY(n+1)A *4	Alarm reset request flag	If an inverter alarm occurs, turning ON the alarm reset request flag resets the inverter, and turns OFF the alarm state flag (RX(n+1)A).	

n: Value determined by setting station number

\*1 During the time when the monitor command (RYnC) is ON, the monitor value is constantly updated.

\*2 During the frequency setting command (RYnD) is ON, , the value of the frequency command (RWwn+1) is constantly reflected on the speed.

\*3 During the time when "command code execution request" is ON, the command code is constantly executed. (With read request the read value is constantly updated, and with write request the write value is constantly reflected on the writing.) However, the function codes (except S code) are written only once.

\*4 During the time when the alarm reset request flag (RY(n+1)A) is ON, alarm reset is constantly executed. So, turn OFF the flag after an alarm has been reset. Alarm reset is always possible irrespective of operation mode.

Table 7 Input signals (Inverter → Master)

Device no.	Signal name	Description	
RXn0	Rotating in forward direction	OFF: Other than rotating in forward direction (stop or rotating in reverse direction) ON: Rotating in forward direction	
RXn1	Rotating in reverse direction	OFF: Other than rotating in reverse direction (stop or rotating in forward direction) ON: Rotating in reverse direction	
RXn2	Y1 terminal function	Turned ON with inverter running (RUN)	Output signal can be changed by setting Y-terminal function selection (E20, E21, E22, E24).
RXn3	Y2 terminal function	Turned ON with frequency arrival signal (FAR)	
RXn4	Y3 terminal function	Turned ON with frequency detected (FDT)	
RXn5	Unused	-	
RXn6	Y5 terminal function	Turned ON with select AX terminal function (AX)	
RXn7	Failure relay output (ABC)	Turned ON when inverter protection function works and output stops.	
RXnC	Monitoring	By turning ON the monitor command (RYnC), the monitor value is set to the remote register RWrn (see 10.2) and the monitoring (RXnC) is turned ON. When the monitor command (RYnC) is turned OFF, the monitoring (RXnC) is turned OFF.	
RXnD	Frequency setting complete (RAM)	By turning ON the frequency setting command (RYnD), the frequency command is written in the volatile memory (RAM) and this signal is turned ON. When the frequency setting command (RYnD) is turned OFF, "frequency setting complete" (RXnD) comes OFF.	
RXnE	Unused	-	
RXnF	Command code execution complete	By turning ON the command code execution request (RYnF), the processing corresponding to the command code (RWwn+2) is executed, and when the processing has been finished, this signal is turned ON. When the command code execution request (RYnF) is turned OFF, the "command code execution complete" comes OFF.	
RX(n+1)A	Alarm status flag	Turned ON when an inverter alarm (alarm other than Er3) occurs.	
RX(n+1)B	Remote station ready	After the power has been turned on, or after the hardware has been reset, and when the initial data setting has been finished and the inverter has become ready, this signal is turned ON. (This signal is used for interlock with read/write from the master unit.) If an inverter alarm occurs, this signal is turned OFF simultaneously with the alarm status flag (RX (n+1)A) ON.	

n: Value determined by setting station number

\*1 If the operation condition setting switch of the master unit, "input data status of station with data link failure (SW4)", is set to ON, the input data from the station with data link failure holds its value received just before the failure has occurred. So, note that, even if an inverter alarm has occurred, the signal "remote station ready" remains ON.

\*2 Note that, if the master outputs an operation command when commands through communication are set invalid (H30 = 0, 1 or [LE] command OFF), the inverter does not operate but the signals "speed setting complete" and "command code execution complete" are turned ON. Also, if the commands through communication are set invalid, whether the input signal from the link (COM) is coming in or not can be checked with "I/O check" on the keypad.



## 10.2 Assigning remote registers

Table 8 Remote registers (Master → Inverter)

Address	Signal name	Description	Remark
RWwn	Monitor code 1 / 2	Sets the monitor code (see Table 10) to be referred to. After the setting has been finished, the data of specified monitor is set to RWrn by turning ON RYnC signal.	
RWwn+1	Frequency command	Sets Frequency command. After the command has been set to this register, the frequency is written by turning ON the RYnD mentioned previously. After the writing the frequency has been finished, RXnD comes ON.	Every 0.01Hz
RWwn+2	Command code	Sets the command code (see Table 11 or, it accesses each function code by formatting the data of page 26.) for rewriting operation mode, reading and writing function code, referring to alarm record, resetting alarm, etc. After the register has been set, the set command is executed by turning ON RYnF. After the command has been executed, RXnF comes ON.	
RWwn+3	Write data	Sets the data specified by the above command code. Turn ON RYnF after the above command code and this register have been set (as required). If writing data is not necessary, set the data to 0.	
RWwn+4	Monitor code 3	Set the monitor code to be monitored. By switching on the RYC signal after setting, the specified monitored data is stored to RWrn□. (□ indicates a register number. (RWrn4~7))	
RWwn+5	Monitor code 4		
RWwn+6	Monitor code 5		
RWwn+7	Monitor code 6		
RWwn+8	Alarm definition No	Set how many alarm definitions in past to be read. Back to eight alarm definitions in past can be read. (lower 8bits is H00)	Latest 0000 Once ahead 0100 Twice ahead 0200 Three ahead 0300
RWwn+9	PID set point	Set the PID set point.	
RWwn+A	Unused	-	
RWwn+B	Unused	-	
RWwn+10 RWwn+12 RWwn+14 RWwn+16 RWwn+18	Link parameter extension setting / Command codes	Set the instruction code for execution of operation mode rewrite, Pr.read/write, error clear, etc. The corresponding instruction is executed in order of RWw2, 10, 12, 14, 16, 18 by switching on RYF after completion of register setting, then, RXF switches on completion of instruction execution of RWw18. Set HFFFF to disable an instruction by RWw10 to18.	
RWwn+11 RWwn+13 RWwn+15 RWwn+17 RWwn+19	Write data	Set the specified by the instruction code of RWw10, 12, 14, 16, and 18. (when required.) RWw10 and 11, 12 and 13, 14 and 15, 16 and 17, and 18 and 19 correspond each other. After setting this register corresponding to the instruction code of RWw10, 12, 14, 16, and 18, switch on RYF. Set zero when the write code is not required.	

n: Value determined by setting station number

CC-Link extension setting is, at CC-Link Ver1.10, [RWwn~RWwn +3] can be used.

at CC-Link Ver2.00 double, [RWwn~RWwn +7] can be used.

at CC-Link Ver2.00 quaduple, [RWwn~RWwn +F] can be used.

at CC-Link Ver2.00 octuple, [RWwn~RWwn +1F] can be used.

【Reading of function · Writing · Reading of link extended setting · Writing data format】

15	14	13	12	11	10	9	8	7	6	5	4	3	2	1	0				
Reserved			Function code group (0~31) 00H(=0) : Fcode(F00~F99) 01H(=1) : Ecode (E00~E99) 02H(=2) : Ccode (C00~C99) 03H(=3) : Pcode (P00~P99) 04H(=4) : Hcode (H00~H99) 06H(=6) : ocode (o00~o99) 07H(=7) : Scode (S00~S99) 08H(=8) : Mcode (M00~M99) 0DH(=13) : Jcode (J00~J99) 0EH(=14) : ycode (y00~y99) 0FH(=15) : Wcode (W00~W99) 10H(=16) : Xcode (X00~X99) 11H(=17) : Zcode (Z00~Z99)					0:Read 1:Write		Function code 00~99									

Table 9 Remote registers (Inverter → Master)

Address	Signal name	Description	Remark
RW <sub>rn</sub>	Monitor value 1	The monitor value specified by the monitor code RW <sub>wn</sub> is set.	
RW <sub>rn</sub> +1	Monitor value 2	The monitor value specified by the monitor code RW <sub>wn</sub> is set.	
RW <sub>rn</sub> +2	Response code	Set reply code corresponds to the command code of RW <sub>wn</sub> +2. (see table12) For correct response "0" is set, and for data error other than "0" is set.	
RW <sub>rn</sub> +3	Read data	With correct response, the response data for the command specified by the command code is set in this register.	
RW <sub>rn</sub> +4	Monitor value 3	When RYC is on, the monitor value specified to the monitor code (RW <sub>w</sub> □) is stored. (□ indicates a register number (RW <sub>w</sub> 4 to 7))	
RW <sub>rn</sub> +5	Monitor value 4		
RW <sub>rn</sub> +6	Monitor value 5		
RW <sub>rn</sub> +7	Monitor value 6		
RW <sub>rn</sub> +8	Alarm definition (alarm data)	The alarm data of alarm definition No. specified by RW <sub>w</sub> 8 is stored in the lower 8bits. Alarm definition No. specified is echo backed to the upper 8bits.	
RW <sub>rn</sub> +9	Alarm definition (output frequency)	Output frequency of the alarm definition No. specified in RW <sub>w</sub> 8 is stored.	
RW <sub>rn</sub> +A	Alarm definition (output current)	Output current of the alarm definition No. specified in RW <sub>w</sub> 8 is stored.	
RW <sub>rn</sub> +B	Alarm definition (output voltage)	Output voltage of the alarm definition No. specified in RW <sub>w</sub> 8 is stored.	
RW <sub>rn</sub> +C	Alarm definition (energization time)	Energization time of the alarm definition No. specified in RW <sub>w</sub> 8 is stored.	
RW <sub>rn</sub> +10 ~ RW <sub>rn</sub> +19	Reply code	Turning on RYnF stores the reply code corresponds to the instruction code of RW <sub>w</sub> 10, 12, 14, 16, and 18. The value "0" is set for a normal reply and other than "0" is set for data fault, mode error, etc.	
	Read data	With correct response, the response data for the command specified by the command code is set in this register.	

n: Value determined by setting station number

CC-Link extension setting is, at CC-Link Ver1.10, [RW<sub>rn</sub>~RW<sub>rn</sub> +3] can be used.

at CC-Link Ver2.00 double, [RW<sub>rn</sub>~RW<sub>rn</sub> +7] can be used.

at CC-Link Ver2.00 quadropole, [RW<sub>rn</sub>~RW<sub>rn</sub> +F] can be used.

at CC-Link Ver2.00 octuple, [RW<sub>rn</sub>~RW<sub>rn</sub> +1F] can be used.

### 10.3 Description of remote registers

Table 10 Monitor codes

Code No.	Second Monitor Description (the first 8 bits)	First Monitor Description (the first 8 bits)	Unit	Remark
00 <sub>H</sub>	No monitor (monitor value fixed to 0)			
01 <sub>H</sub>	Output frequency		0.01Hz	Output in increments of 0.1 Hz
02 <sub>H</sub>	Output current		0.01A/0.1A	*1
03 <sub>H</sub>	Output voltage		0.1V	
04 <sub>H</sub>	No monitor (monitor value fixed to 0)		—	
05 <sub>H</sub>	Set frequency		0.01Hz	
06 <sub>H</sub>	Running speed		1r/min	
07 <sub>H</sub>	Calculated output torque		0.1%	
08 <sub>H</sub>	DC intermediate voltage		0.1V	Output in increments of 1 V
09 <sub>H</sub>   0C <sub>H</sub>	No monitor (monitor value fixed to 0)			
0D <sub>H</sub>	Input power		0.01kW/0.1kW	*1
0E <sub>H</sub>	Output power		0.01kW/0.1kW	*1
0F <sub>H</sub>	Input terminal status		—	
10 <sub>H</sub>	Output terminal status		—	
11 <sub>H</sub>	Load factor		0.1%	
12 <sub>H</sub>   13 <sub>H</sub>	No monitor (monitor value fixed to 0)			
14 <sub>H</sub>	Integrated operation time		1hr	
15 <sub>H</sub>   16 <sub>H</sub>	No monitor (monitor value fixed to 0)			
17 <sub>H</sub>	Actual operation time		1hr	
18 <sub>H</sub>	Output current effect value		0.1%	
19 <sub>H</sub>	Cumulative power		1kW/hr	
1A <sub>H</sub>   33 <sub>H</sub>	No monitor (monitor value fixed to 0)			
34 <sub>H</sub>	PID set point		0.1%	
35 <sub>H</sub>	PID measured value		0.1%	
36 <sub>H</sub>	PID deviation		0.1%	
37 <sub>H</sub> 	No monitor (monitor value fixed to 0)			

\*1 The setting depends on the inverter capacity.(55kW or less/75 kW or more)

◆ Detailed explanation of Input terminal status

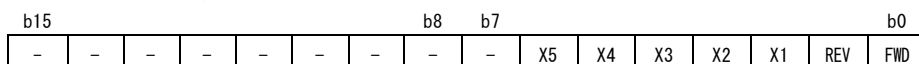
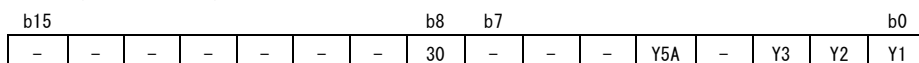

Figure 14

◆ Detailed explanation of output terminal status



"-": Vacant (fixed to 0)

Figure 15

Table 11 Command codes

Item	Code No.	Description of data	Remark
Operation mode read	007B <sub>H</sub>	0000 <sub>H</sub> : Link operation (CC-Link) 0001 <sub>H</sub> : External operation (Terminal board) 0002 <sub>H</sub> : Keypad operation 0003 <sub>H</sub> : Others	
Operation mode write	00FB <sub>H</sub>	0000 <sub>H</sub> : Link operation (CC-Link) 0001 <sub>H</sub> : External operation (Terminal board) 0002 <sub>H</sub> : Keypad operation	Change to "y98=3" Change to "y98=0", "F02=1" Change to "y98=0", "F02=0", "F01=0" Caution) <ul style="list-style-type: none"> <li>It doesn't return to former setting when the power supply is turned on again.</li> <li>【LE】 The terminal becomes top priority.</li> </ul>
Alarm record No.1 and No.2 read	0074 <sub>H</sub>	Record No.1 and No.2 read	L byte: Latest alarm H byte: First alarm in past
Alarm record No.3 and No.4 read	0075 <sub>H</sub>	Record No.3 and No.4 read	L byte: Second alarm in past H byte: Third alarm in past
Frequency command read	006D <sub>H</sub>	Reading frequency command	0~±20000 (Nmax. at ±20000) Accessible from remote register
Frequency command write	00ED <sub>H</sub>	Writing frequency command	When "y=1,3" is set, it is possible to write it.
Function code read	0000 <sub>H</sub> ~ 0063 <sub>H</sub>	Function code is read or written in combination with the link parameter extension setting.	For the link No. and data format, refer to Chapter 11.
Function code write	0080 <sub>H</sub> ~ 00E3 <sub>H</sub>		
Batch alarm definition clear	00F4 <sub>H</sub>	9696 <sub>H</sub> : Batch-clears the alarm history	
Alarm reset	00FD <sub>H</sub>	9696 <sub>H</sub> : Resets the alarm	Even not link operation, reset can be made.

Table 12 Response codes

Code No.	Item	Description
0000 <sub>H</sub>	Normal (no error)	Command code has been normally executed.
0001 <sub>H</sub>	Write mode error	<ul style="list-style-type: none"> <li>Function code has been written during inverter operation.</li> <li>Function code has been written during EEPROM write. (Prohibition while it changes with keypad)</li> <li>Function code has been written with transmission error.</li> </ul>
0002 <sub>H</sub>	Function code select error	An inaccessible link No. has been set.
0003 <sub>H</sub>	Setting range error	The set data is out of the changeable range.

## Chapter11 Link Number / Data Format

Link No of each function code is described. Understand together with refer to Chapter 5 of RS-485 user's manual (MEH448\*) for the data format form).

F:Fundamental Functions		Attribute		
Code	Name	CC Link No		Communication data format
		READ	WRITE	
F00	Data protection	0000	0080	1
F01	Frequency command 1	0001	0081	1
F02	Run Command	0002	0082	1
F03	Maximum frequency	0003	0083	3
F04	Base frequency	0004	0084	3
F05	Rated Voltage at Base Frequency	0005	0085	1
F07	Acceleration time	0007	0087	12
F08	Deceleration time	0008	0088	12
F09	Torque boost	0009	0089	3
F10	Electronic thermal (Select motor characteristics)	000A	008A	1
F11	Overload Protection for (Overload detection level)	000B	008B	24
F12	Motor (Thermal time constant)	000C	008C	3
F14	Restart mode after momentary power failure (Mode selection)	000E	008E	1
F15	Frequency limiter (High)	000F	008F	3
F16	(Low)	0010	0090	3
F18	Bias (Frequency command1)	0012	0092	6
F20	DC Braking (Braking start frequency)	0014	0094	3
F21	(Braking level)	0015	0095	1
F22	(Braking time)	0016	0096	5
F23	Starting frequency	0017	0097	3
F25	Stop frequency	0019	0099	3
F26	Motor sound (Carrier frequency)	001A	009A	1
F27	( tone)	001B	009B	1
F29	Analog Output [FMA] (Mode selection)	001D	009D	1
F30	(Output adjustment)	001E	009E	1
F31	(Function)	001F	009F	1
F33	Pulse Output [FMP] (Pulse rate)	0021	00A1	1
F34	(Duty))	0022	00A2	1
F35	(Function)	0023	00A3	1
F37	Load Selection/Auto Torque Boost /Auto Energy Saving Operation	0025	00A5	1
F43	Current Limiter (Mode selection)	002B	00AB	1
F44	(Level)	002C	00AC	1

## E: Extension Terminal Functions

Code	Name	CC Link No		Communication data format
		READ	WRITE	
E01	Command Assignment to:	[X1]	0101 0181	1
E02		[X2]	0102 0182	1
E03		[X3]	0103 0183	1
E04		[X4]	0104 0184	1
E05		[X5]	0105 0185	1
E20	Signal Assignment to:	[Y1]	0114 0194	1
E21	(Transistor signal)	[Y2]	0115 0195	1
E22		[Y3]	0116 0196	1
E24	(Relay contact signal)	[Y5A/C]	0118 0198	1
E27		[30A/B/C]	011B 019B	1
E31	Frequency Detection (FDT)	(Detection level)	011F 019F	3
E34	Overload Early Warning	(Level)	0122 01A2	24
E35	/Current Detection	(Timer)	0123 01A3	5
E40	PID Display coefficient A		0128 01A8	12
E41	PID Display coefficient B		0129 01A9	12
E43	LED Monitor	(Item selection)	012B 01AB	1
E45	LCD Monitor	(Item selection)	012D 01AD	1
E46		(Language selection)	012E 01AE	1
E47		(Contrast control)	012F 01AF	1
E48	LED Monitor	(Speed monitor item)	0130 01B0	1
E50	Coefficient for Speed Indication		0132 01B2	5
E51	Display Coefficient for Input Watt-hour Data		0133 01B3	45
E52	Keypad		0134 01B4	1
E61	Analog Input for (Extension function selection)		013D 01BD	1
E62		[C1]	013E 01BE	1
E63		[V2]	013F 01BF	1
E64	Saving Digital Reference Frequency		0140 01C0	1
E65	Command Loss Detection		0141 01C1	1
E80	Detect Low Torque	(Detection level)	0150 01D0	1
E81		(Timer)	0151 01D1	5
E98	Command Assignment to:	[FWD]	0162 01E2	1
E99		[REV]	0163 01E3	1

## C: Control Functions of Frequency

Code	Name	CC Link No		Communication data format
		READ	WRITE	
C01	Jump Frequency 1	0201	0281	3
C02	2	0202	0282	3
C03	3	0203	0283	3
C04	(Band)	0204	0284	3
C05	Multistep Frequency 1	0205	0285	5
C06	2	0206	0286	5
C07	3	0907	0987	5
C08	4	0208	0288	5
C09	5	0209	0289	5
C10	6	020A	028A	5
C11	7	020B	028B	5
C30	Frequency Command 2	021E	029E	1
C32	Analog Input Adjustment for [12] (Gain)	0220	02A0	5
C33	(Filter time constant)	0221	02A1	5
C34	(Gain reference point)	0222	02A2	5
C37	Analog Input Adjustment for [C1] (Gain)	0225	02A5	5
C38	(Filter time constant)	0226	02A6	5
C39	(Gain reference point)	0227	02A7	5
C42	Analog Input Adjustment for [V2] (Gain)	022A	02AA	5
C43	(Filter time constant)	022B	02AB	5
C44	(Gain reference point)	022C	02AC	5
C50	Bias Reference Point (Frequency command 1)	0232	02B2	5
C51	Bias for PID command 1 (Bias value)	0233	02B3	6
C52	(Bias reference point)	0234	02B4	5
C53	Selection of Normal/ Inverse Oper (Frequency command 1)	0235	02B5	1

## P: Motor Parameters

Code	Name	CC Link No		Communication data format
		READ	WRITE	
P01	Motor (No. of poles)	0301	0381	1
P02	(Rated capacity)	0302	0382	11
P03	(Rated current)	0303	0383	24
P04	(Auto-tuning)	0304	0384	21
P06	(No-load current)	0306	0386	24
P07	(%R1)	0307	0387	5
P08	(%X)	0308	0388	5
P99	Motor Selection	0363	03E3	1

## H: High Performance Functions

Code	Name	CC Link No		Communication data format
		READ	WRITE	
H03	Data Initialization	0403	0483	1
H04	Auto-resetting (Times)	0404	0484	1
H05	(Reset interval)	0405	0485	3
H06	Cooling Fan ON/OFF Control	0406	0486	1
H07	Acceleration/Deceleration Pattern	0407	0487	1
H09	Select Starting Characteristics (Auto search time for idling motor speed)	0409	0487	1
H11	Deceleration Mode	040B	048B	1
H12	Instantaneous Overcurrent Limiting (Mode selection)	040C	048C	1
H13	Restart Mode after (Restart time)	040D	048D	3
H14	(Frequency fall rate)	040E	048E	5
H15	(Continuous running level)	040F	048F	1
H16	(Allowable momentary power failure time)	0410	0490	3
H17	Select Starting Characteristics (Frequency for idling motor speed)	0411	0491	3
H26	PTC Thermistor (Mode selection)	041A	049A	1
H27	(Level)	041B	049B	5
H30	Communications Link Function (Mode selection)	041E	049E	1
H42	Capacitance of DC Link Bus Capacitor	042A	04AA	1
H43	Cumulative Run Time of Cooling Fan	042B	04AB	1
H47	Initial Capacitance of DC Link Bus Capacitor	042F	04AF	1
H48	Cumulative Run Time of Capacitors on the Printed Circuit Board	0430	04B0	1
H49	Select Starting Characteristics (Auto search time for idling motor speed)	0431	04B1	3
H50	Non-linear V/f Pattern (Frequency)	0432	04B2	3
H51	(Voltage)	0433	04B3	1
H56	Deceleration Time for Forced Stop	0438	04B8	12
H63	Low Limiter (Mode selection)	043F	04BF	1
H64	(Lower limiting frequency)	0440	04C0	3
H69	Automatic Deceleration (Mode selection)	0445	04C5	1
H70	Overload Prevention Control	0446	04C6	5
H71	Deceleration Characteristics	0447	04C7	1
H80	Gain for Suppression of Output Current Fluctuation for Motor	0450	04D0	5
H86	Reserved	0456	04D6	1
H87	Reserved	0457	04D7	3
H88	Reserved	0458	04D8	1
H89	Reserved	0459	04D9	1
H90	Reserved	045A	04DA	1
H91	Reserved	045B	04DB	1
H92	Continue to Run (P-component: gain)	045C	04DC	7
H93	(I-component: time)	045D	04DD	7
H94	Cumulative Run Time of Motor	045E	04DE	1
H95	DC Braking (Braking response mode)	045F	04DF	1
H96	STOP Key Priority/Start Check Function	0460	04E0	1
H97	Clear Alarm Data	0461	04E1	1
H98	Protection/Maintenance Function (Mode selection)	0462	04E2	1



<b>J: Application</b>				
Code	Name	CC Link No		Communication data format
		READ	WRITE	
J01	PID Control (Mode selection)	0D01	0D81	1
J02	(Remote process command)	0D02	0D82	1
J03	P (Gain)	0D03	0D83	7
J04	I (Integral time)	0D04	0D84	3
J05	D (Differential time)	0D05	0D85	5
J06	(Feedback filter)	0D06	0D86	3
J10	(Anti reset windup)	0D0A	0D8A	1
J11	(Select alarm output)	0D0B	0D8B	1
J12	(Upper limit alarm (AH))	0D0C	0D8C	2
J13	(Lower limit alarm (AL))	0D0D	0D8D	2
J15	(Stop frequency for slow flowrate)	0D0F	0D8F	1
J16	(Slow flowrate level stop latency)	0D10	0D90	1
J17	(Starting frequency)	0D11	0D91	1
J18	(Upper limit of PID process output)	0D12	0D92	1
J19	(Lower limit of PID process output)	0D13	0D93	1
J21	Dew Condensation Prevention (Duty)	0D15	0D95	1
J22	Commercial Power Switching Sequence	0D16	0D96	1

<b>y: Link Functions</b>				
Code	Name	CC Link No		Communication data format
		READ	WRITE	
y01	RS485 Communication (Standard) (Station address)	0E01	0E81	1
y02	(Communications error processing)	0E02	0E82	1
y03	(Error processing timer)	0E03	0E83	3
y04	(Transmission speed)	0E04	0E84	1
y05	(Data length)	0E05	0E85	1
y06	(Parity check)	0E06	0E86	1
y07	(Stop bits)	0E07	0E87	1
y08	(No-response error detection time)	0E08	0E88	1
y09	(Response latency time)	0E09	0E89	5
y10	(Protocol selection)	0E0A	0E8A	1
y11	RS485 Communication (Option) (Station address)	0E0B	0E8B	1
y12	(Communications error processing)	0E0C	0E8C	1
y13	(Error processing timer)	0E0D	0E8D	3
y14	(Transmission speed)	0E0E	0E8E	1
y15	(Data length)	0E0F	0E8F	1
y16	(Parity check)	0E10	0E90	1
y17	(Stop bits)	0E11	0E91	1
y18	(No-response error detection time)	0E12	0E92	1
y19	(Response latency time)	0E13	0E93	5
y20	(Protocol selection)	0E14	0E94	1
y98	Bus Link Function (Mode selection)	0E62	0EE2	1
y99	Loader Link Function (Mode selection)	0E63	0EE3	1

O:Option Functions		Attribute		
Code	Name	CC Link No		Communication data format
		READ	WRITE	
o27	Operation when a failure has occurred	061B	069B	1
o28	Communication failure when a failure has occurred	061C	069C	3
o30	CC Link extended setting	061E	069E	1
o31	CC-Link option station number setting	061F	069F	1
o32	CC-Link option Transmission Baud ratesetting	0620	06A0	1

## S:Communications Dedicated Function Codes(public)(Command data)

	Name	Setting range	CC Link No		Communication NO	Display form
			READ	WRITE		
S07	Universal DU	0000H~FFFFH	0707	0787	15	HEX
S08	Acceleration time	0.0~3600.0	0708	0788	3	0.1
S09	Deceleration time	0.0~3600.0	0709	0789	3	0.1
S12	Universal AU	-32768~32767	070C	078C	29	HEX
S13	PID command	-32768~32767	070D	078D	29	HEX
S14	Alarm reset command	0~65535	070E	078E	1	HEX

## M:Communications Dedicated Function Codes(public)(Monitor data)

	Name	Setting range	CC Link No		Communication NO	Display form
			READ	WRITE		
M01	Frequency command (p.u.) (final command)	-32768~32767	0801	-	29	HEX
M05	Frequency command	0.00~655.35	0805	-	22	0.01
M06	Output frequency 1 (p.u.)	-32768~32767	0806	-	29	HEX
M07	Output torque	-327.68~327.67	0807	-	6	0.01
M09	Output frequency 1	-655.35~655.35	0809	-	23	0.01
M10	Input power	0.00~399.99	080A	-	5	0.01
M11	Output current effective value	0.00~399.99	080B	-	5	0.01
M12	Output voltage effective value	0.0~1000.0	080C	-	3	0.1
M13	Operation command (final command)	0000H~FFFFH	080D	-	14	HEX
M14	Operation status	0000H~FFFFH	080E	-	16	HEX
M15	General-purpose output terminal information	0000H~FFFFH	080F	-	15	HEX
M16	Latest alarm contents	0~127	0810	-	10	1
M17	Last alarm contents	0~127	0811	-	10	1
M18	Second last alarm contents	0~127	0812	-	10	1
M19	Third last alarm contents	0~127	0813	-	10	1
M20	Cumulative operation time	0~65535	0814	-	1	HEX
M21	DC link circuit voltage	0~1000	0815	-	1	1
M23	Model code	0000H~FFFFH	0817	-	17	HEX
M24	Capacity code	0~65535	0818	-	11	HEX
M25	ROM version	0~9999	0819	-	35	1
M26	Transmission error transaction code	0~127	081A	-	20	1
M27	Frequency command on alarm (p.u.) (final command)	-32768~32767	081B	-	29	HEX
M31	Frequency command on alarm (final command)	0.00~655.35	081F	-	22	0.01
M32	Output frequency 1 on alarm (p.u.)	-32768~32767	0820	-	29	HEX
M33	Output torque on alarm	-327.68~327.67	0821	-	6	0.01
M35	Output frequency 1 on alarm	-655.35~655.35	0823	-	23	0.01
M36	Input power on alarm	0.00~399.99	0824	-	5	0.01
M37	Output current effective value on alarm	0.00~399.99	0825	-	5	0.01
M38	Output voltage effective value on alarm	0.0~1000.0	0826	-	3	0.1
M39	Operation command on alarm	0000H~FFFFH	0827	-	14	HEX
M40	Operation status on alarm	0000H~FFFFH	0828	-	16	HEX
M41	General-purpose output terminal information on alarm	0000H~FFFFH	0829	-	15	HEX
M42	Cumulative operation time on alarm	0~65535	082A	-	1	HEX
M43	DC link circuit voltage on alarm	0~1000	082B	-	1	1
M44	Inverter internal air temperature on alarm	0~255	082C	-	1	1
M45	Heat sink temperature on alarm	0~255	082D	-	1	1
M46	Life of main circuit capacitor	0.0~100.0	082E	-	3	HEX
M47	Life of PC board electrolytic capacitor	0~65535	082F	-	1	HEX
M48	Life of heat sink	0~65535	0830	-	1	HEX
M49	Input terminal voltage ([I2])	-32768~32767	0831	-	29	HEX
M50	Input terminal current ([C1])	0~32767	0832	-	29	HEX
M54	Input terminal voltage ([V2])	-32768~32767	0836	-	29	HEX
M61	Inverter internal air temperature	0~255	083D	-	1	1
M62	Heat sink temperature	0~255	083E	-	1	1
M63	Load rate	-327.68~327.67	083F	-	6	HEX
M64	Motor output	-327.68~327.67	0840	-	6	HEX
M65	Motor output on alarm	-327.68~327.67	0841	-	6	HEX
M68	PID final command	-32768~32767	0844	-	29	HEX
M69	Inverter rated current	0.00~9999	0845	-	24	1
M70	Operation status 2	0000H~FFFFH	0846	-	44	HEX
M71	Input terminal information	0000H~FFFFH	0847	-	14	HEX
M72	PID feedback	-32768~32767	0848	-	29	HEX
M73	PID output	-32768~32767	0849	-	29	HEX

## W: Communications Dedicated Function Codes

	Name	Setting range	CC Link No		Communication NO	Display form
			READ	WRITE		
W01	Operation status	0000H~FFFFH	0F01	-	16	HEX
W02	Frequency command	0.00~655.35	0F02	-	22	0.01
W03	Output frequency (before slip compensation)	0.00~655.35	0F03	-	22	0.01
W05	Output current	0.00~9999	0F05	-	24	0.01
		0.00~655.35 /0.0~6553.5		-	19	
W06	Output voltage	0.0~1000.0	0F06	-	3	0.1
W07	Torque operation value	-999~999	0F07	-	2	1
W08	Motor speed	0.00~99990	0F08	-	37	0.01
W09	Load rotation speed	0.00~99990	0F09	-	37	0.01
W11	PID process command	-999~9990	0F0B	-	12	0.01
W12	PID feedback value	-999~9990	0F0C	-	12	0.01
W16	Motor speed set value	0.00~99990	0F10	-	37	0.01
W17	Load speed set value	0.00~99990	0F11	-	37	0.01
W21	Input power	0.00~9999	0F15	-	24	0.01
W22	Motor output power	0.00~9999	0F16	-	24	0.01
W23	Load factor	-999~999	0F17	-	2	1
W28	Operation command source	0~22	0F1C	-	1	67
W29	Frequency, PID command source	0~35	0F1D	-	1	68
W30	Speed (unit: %)	0.00~100.00	0F1E	-	5	0.01
W31	Speed setting (unit: %)	0.00~100.00	0F1F	-	5	0.01
W32	PID output	0~150.0	0F20	-	4	0.1
W33	Analog input monitor	-999~9990	0F21	-	12	0.01
W40	Control circuit terminal (input)	0000H~FFFFH	0F28	-	43	HEX
W41	Control circuit terminal (output)	0000H~FFFFH	0F29	-	15	HEX
W42	Communications control signal (input)	0000H~FFFFH	0F2A	-	14	HEX
W43	Communications control signal (output)	0000H~FFFFH	0F2B	-	15	HEX
W44	Terminal [12] input voltage	0.0~12.0	0F2C	-	4	0.1
W45	Terminal [C1] input current	0.0~30.0	0F2D	-	4	0.1
W46	FMA output voltage	0.0~12.0	0F2E	-	3	0.1
W47	FMP output voltage	0.0~12.0	0F2F	-	3	0.1
W48	FMP output voltage	0~6000	0F30	-	1	1
W49	Terminal [V2] input voltage	0.0~12.0	0F31	-	4	0.1
W50	FMA output current	0.0~30.0	0F32	-	3	0.1
W65	FMI output current	0.0~30.0	0F41	-	3	0.1
W70	Cumulative operation time	0~65535	0F46	-	1	0.001
W71	DC link circuit voltage	0~1000	0F47	-	1	1
W72	Maximum temperature of internal air	0~255	0F48	-	1	1
W73	Maximum temperature of heat sink	0~255	0F49	-	1	1
W74	Maximum effective current value	0.00~9999	0F4A	-	24	0.01
W75	Capacitor of the DC bus capacitor	0.00~100.0	0F4B	-	3	0.1
W76	Cumulative operation time of electrolytic capacitor on PC board	0~65535	0F4C	-	1	0.001
W77	Cumulative operation time of cooling fan	0~65535	0F4D	-	1	0.001
W78	Number of startups	0~65535	0F4E	-	1	0.001
W79	Cumulative operation time of motor	0~65535	0F4F	-	1	0.001
W80	Standard fan life	0~65535	0F50	-	1	0.001
W81	Integral electric power consumption	0.001~9999	0F51	-	45	0.001
W82	Integral electric power consumption data	0.001~9999	0F52	-	45	0.001
W83	Number of RS485 Ch1 errors	0~9999	0F53	-	1	1
W84	Contents of RS485 Ch1 error	0~127	0F54	-	20	1
W85	Number of RS485 Ch2 errors	0~9999	0F55	-	1	1
W87	Inverter's ROM version	0~9999	0F57	-	35	1
W89	Remote/multi-function keypad ROM version	0~9999	0F59	-	35	1
W90	Option ROM version	0~9999	0F5A	-	35	1
W94	Content of RS485 Ch2 error	0~127	0F5E	-	20	1
W95	Number of option communications errors	0~9999	0F5F	-	1	1
W96	Content of option communications error	0~9999	0F60	-	1	1

## X:Communications Dedicated Function Codes

	Name	Setting range	CC Link No		Communication NO	Display form
			READ	WRITE		
X00	Alarm history (latest)	0000H~FFFFH	1000	-	41	HEX
X01	Multiple alarm 1	0000H~FFFFH	1001	-	40	HEX
X02	Multiple alarm 2	0000H~FFFFH	1002	-	40	HEX
X03	Sub-code	0~9999	1003	-	1	1
X05	Alarm history (last)	0000H~FFFFH	1005	-	41	HEX
X06	Multiple alarm 1	0000H~FFFFH	1006	-	40	HEX
X07	Multiple alarm 2	0000H~FFFFH	1007	-	40	HEX
X08	Sub-code	0~9999	1008	-	1	1
X10	Alarm history	0000H~FFFFH	100A	-	41	HEX
X11	Multiple alarm 1	0000H~FFFFH	100B	-	40	HEX
X12	Multiple alarm 2	0000H~FFFFH	100C	-	40	HEX
X13	Sub-code	0~9999	100D	-	1	1
X15	Alarm history	0000H~FFFFH	100F	-	41	HEX
X16	Multiple alarm 1	0000H~FFFFH	1010	-	40	HEX
X17	Multiple alarm 2	0000H~FFFFH	1011	-	40	HEX
X18	Sub-code	0~9999	1012	-	1	1
X20	output frequency	0.00~655.35	1014	-	22	0.01
X21	output current	0.00~9999	1015	-	24	0.01
		0.00~655.35 /0.0~6553.5			19	
X22	output voltage	0~1000	1016	-	1	1
X23	torque operation value	-999~999	1017	-	2	1
X24	set frequency	0.00~655.35	1018	-	22	1
X25	operation status	0000H~FFFFH	1019	-	16	HEX
X26	cumulative operation time	0~65535	101A	-	1	0.001
X27	number of startups	0~65535	101B	-	1	0.001
X28	DC link circuit voltage	0~1000	101C	-	1	1
X29	internal air temperature	0~255	101D	-	1	1
X30	heat sink temperature	0~255	101E	-	1	1
X31	control circuit terminal (input)	0000H~FFFFH	101F	-	43	HEX
X32	control circuit terminal (output)	0000H~FFFFH	1020	-	15	HEX
X33	communications control signal (input)	0000H~FFFFH	1021	-	14	HEX
X34	communications control signal (output)	0000H~FFFFH	1022	-	15	HEX
X35	Input power on alarm	0.00~9999	1023	-	24	0.01
X60	output frequency	0.00~655.35	103C	-	22	0.01
X61	output current	0.00~9999	103D	-	24	0.01
		0.00~655.35 /0.0~6553.5			19	
X62	output voltage	0~1000	103E	-	1	1
X63	torque operation value	-999~999	103F	-	2	1
X64	set frequency	0.00~655.35	1040	-	22	1
X65	operation status	0000H~FFFFH	1041	-	16	HEX
X66	cumulative operation time	0~65535	1042	-	1	0.001
X67	number of startups	0~65535	1043	-	1	0.001
X68	DC link circuit voltage	0~1000	1044	-	1	1
X69	internal air temperature	0~255	1045	-	1	1
X70	heat sink temperature	0~255	1046	-	1	1
X71	control circuit terminal (input)	0000H~FFFFH	1047	-	43	HEX
X72	control circuit terminal (output)	0000H~FFFFH	1048	-	15	HEX
X73	communications control signal (input)	0000H~FFFFH	1049	-	14	HEX
X74	communications control signal (output)	0000H~FFFFH	104A	-	15	HEX

## Z: Communications Dedicated Function Codes

	Name	Setting range	CC Link No		Communication NO	Display form
			READ	WRITE		
Z00	output frequency	0.00~655.35	1100	-	22	0.01
Z01	output current	0.00~9999	1101	-	24	0.01
		0.00~655.35 /0.0~6553.5			19	
Z02	output voltage	0~1000	1102	-	1	1
Z03	torque operation value	-999~999	1103	-	2	1
Z04	set frequency	0.00~655.35	1104	-	22	1
Z05	operation status	0000H~FFFFH	1105	-	16	HEX
Z06	cumulative operation time	0~65535	1106	-	1	0.001
Z07	number of startups	0~65535	1107	-	1	0.001
Z08	DC link circuit voltage	0~1000	1108	-	1	1
Z09	internal air temperature	0~255	1109	-	1	1
Z10	heat sink temperature	0~255	110A	-	1	1
Z11	control circuit terminal (input)	0000H~FFFFH	110B	-	43	HEX
Z12	control circuit terminal (output)	0000H~FFFFH	110C	-	15	HEX
Z13	communications control signal (input)	0000H~FFFFH	110D	-	14	HEX
Z14	communications control signal (output)	0000H~FFFFH	110E	-	15	HEX
Z50	output frequency	0.00~655.35	1132	-	22	0.01
		0.00~9999			24	
Z51	output current	0.00~655.35 /0.0~6553.5	1133	-	19	0.01
Z52	output voltage	0~1000	1134	-	1	1
Z53	torque operation value	-999~999	1135	-	2	1
Z54	set frequency	0.00~655.35	1136	-	22	1
Z55	operation status	0000H~FFFFH	1137	-	16	HEX
Z56	cumulative operation time	0~65535	1138	-	1	0.001
Z57	number of startups	0~65535	1139	-	1	0.001
Z58	DC link circuit voltage	0~1000	113A	-	1	1
Z59	internal air temperature	0~255	113B	-	1	1
Z60	heat sink temperature	0~255	113C	-	1	1
Z61	control circuit terminal (input)	0000H~FFFFH	113D	-	43	HEX
Z62	control circuit terminal (output)	0000H~FFFFH	113E	-	15	HEX
Z63	communications control signal (input)	0000H~FFFFH	113F	-	14	HEX
Z64	communications control signal (output)	0000H~FFFFH	1140	-	15	HEX

## Chapter12 Application program examples

### 12.1 System configuration

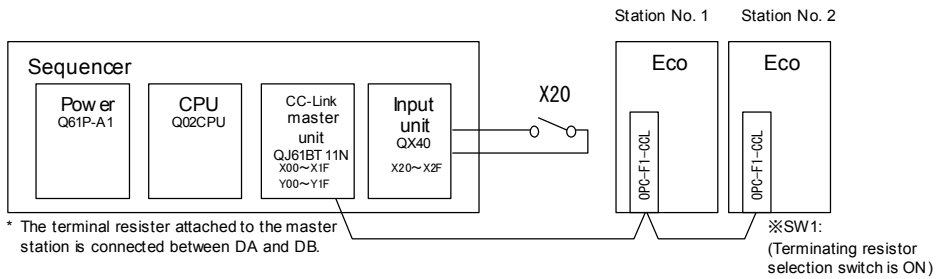

Figure16

### 12.2 Outline of master unit

This section describes outline of the CC-Link master unit which is needed to execute the application program examples. For the details, refer to CC-Link System Master/Local Unit User's Manual (Detail Version) published by Mitsubishi Electric Co., Ltd.

- CC-Link master unit is a special 32-point unit.
- The master unit, installed at the top of the base units, uses X00~X1F and Y00~Y1F for the input/output for starting/stopping the link and other functions. This example uses the following shaded X and Y for the link to the inverter.

Table 13 Input / output allocation of master unit

X00	Unit failure (ON: failure→unit operation disabled)
X01	Self-station linking (OFF before start and with all stations in failure)
X02	Parameter failure (ON: bad setting→start disabled)
X03	ON: some stations in failure
X04	Unit reset completed
X06	Startup normally finished (buffer memory)
X07	Startup finished in failure (buffer memory)
X08	Startup normally finished (EEPROM)
X09	Startup finished in failure (EEPROM)
X0A	EEPROM write normally finished
X0B	EEPROM write finished in failure
X0F	Unit ready (OFF: failure→unit operation disabled)
Y00	Transmit-bit permit (OFF: transmit with all output bit OFF)
Y04	Unit reset
Y06	Link start (parameters of buffer memory are employed)
Y08	Link start (parameters of EEPROM are employed)
Y0A	Start parameters are written from buffer to EEPROM.

#### Manuals of CC-Link master station

■AJ61BT11/A1SJ61QBT11-type CC-Link System Master/Local Unit User's Manual (Detail Version)  
SH-3603

■AJ61QBT11/A1SJ61QBT11-type CC-Link System Master/Local Unit User's Manual (Detail Version)  
SH-3604

■QJ61BT11-type CC-Link System Master/Local Unit User's Manual (Detail Version)  
SH-080017

Table 14 Master unit start parameters

Address	Item	Description	Default
01 <sub>H</sub>	Number of connected units	Sets number of units in connected remote/local stations.	64
02 <sub>H</sub>	Number of times of retry	Sets number of times of retry to the station in communication failure.	3
03 <sub>H</sub>	Number of units to be automatically set in parallel	Sets number of units that can be set in parallel in remote/local stations	1
06 <sub>H</sub>	Specifying operation in CPU down	Specifies data link status during failure of sequencer CPU of master station.	0 (Stop)
10 <sub>H</sub> ~13 <sub>H</sub>	Setting reserved stations	Sets reserved stations.	0 (Not specified)
14 <sub>H</sub> ~17 <sub>H</sub>	Setting error-free stations	Sets error-free stations.	0 (Not specified)
20 <sub>H</sub> ~5F <sub>H</sub>	Station information	Sets type of connected remote/local stations. 11□□ <sub>H</sub> ; Station number is entered in □. (110A <sub>H</sub> if station number is 10.)	-

• Network parameter are set as below.

Table 15 Network parameter setting of the master station

Item	Setting Conditions	
Start I/O No.	0000	
Operation setting	Data link alarm station setting	Input clear
	Setting at CPU stop	Refresh
Type	Master	
Mode	Remote net Ver.1mode	
All connect count	2	
Remote input (RX)	X1000	
Remote output (RY)	Y1000	
Remote resistor (RW <sub>r</sub> )	W0	
Remote resistor (RW <sub>w</sub> )	W100	
Special relay (SB)	SB0	
Special resistor (SW)	SW0	
Retry count	3	
Automatic reconnection station count	1	
CPU down select	Stop	
Scan mode setting	Asynchronous	



### 12.3 CC-Link startup program

The following is an example of the CC-Link startup program for ACPU.

It is not necessary to program the start because it is done by setting the network parameter of the master unit in QCPU.

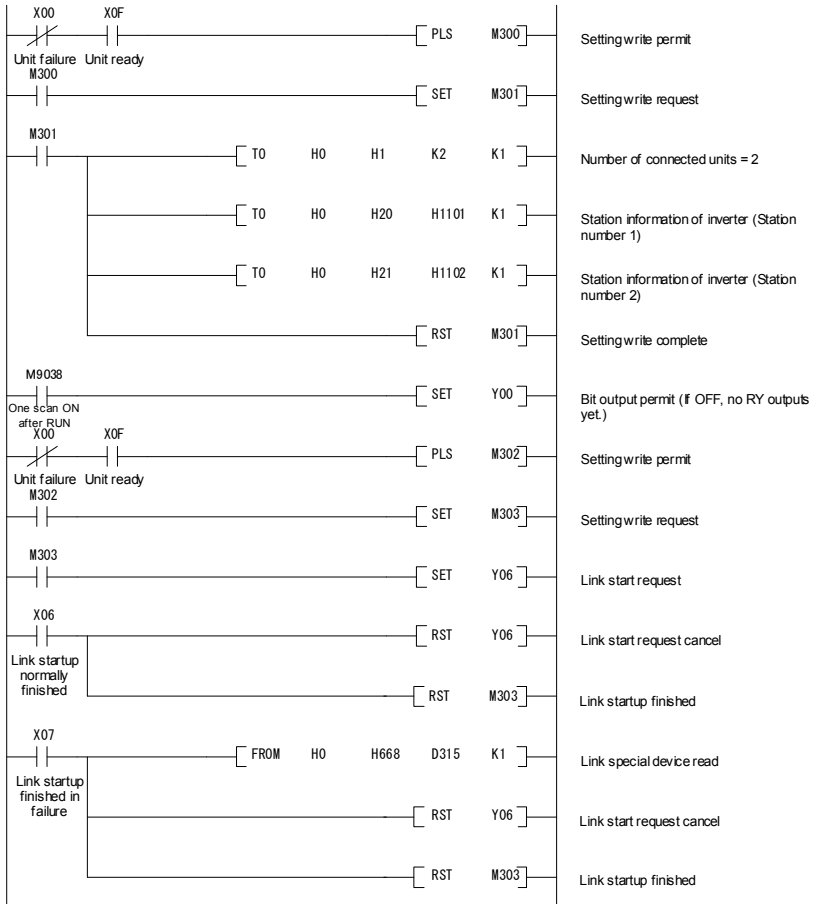

Figure 17

## 12.4 Procedure for reading operation status

The following program turns on Y00 of the output unit when station1 FRENIC-Eco is running.

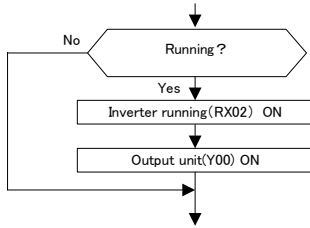

Figure 18

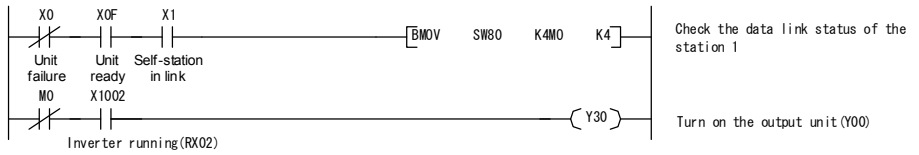

Figure 19

## 12.5 Procedure for setting the operation mode

The following explains a program to change the operation mode of station 1 FRENIC-Eco to network operation.

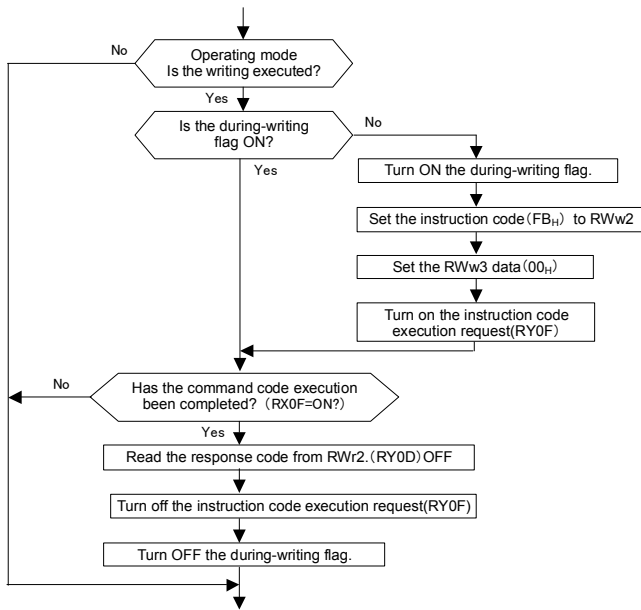

Figure 20

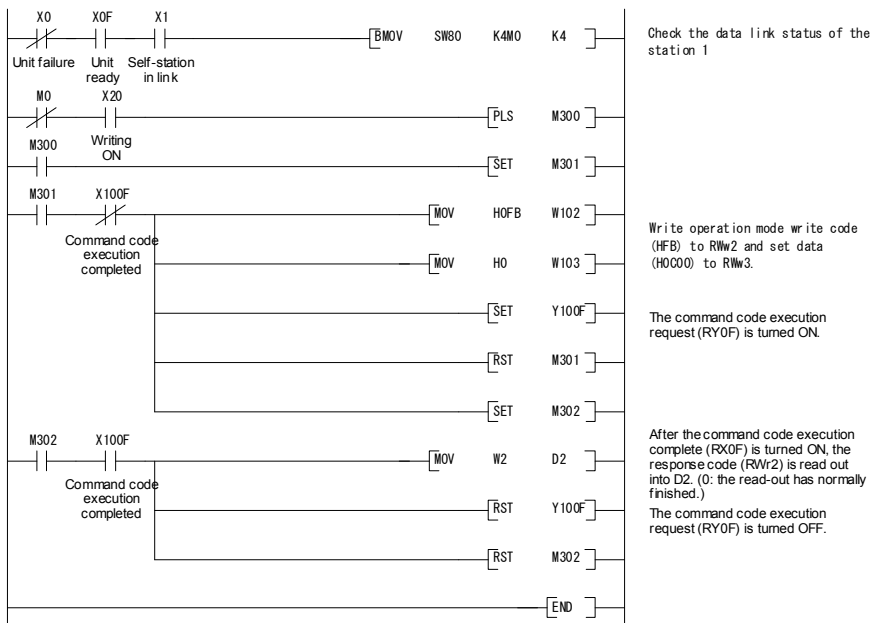

Figure 21

## 12.6 Procedure for operation command setting

When writing forward rotation command into FRENIC-Eco of station no. 1:

Table16 Assigning functions

Bit device	Device No.	Function
M100	RY00	Forward rotation command
M101	RY01	Reverse rotation command
M102	RY02	X1 terminal function
M103	RY03	X2 terminal function
M104	RY04	X3 terminal function
M105	RY05	X4 terminal function
M106	RY06	X5 terminal function
M107	RY07	X6 terminal function
M108	RY08	
M109	RY09	
M110	RY0A	
M111	RY0B	
M112	RY0C	X8 terminal function
M113	RY0D	X7 terminal function
M114	RY0E	Unused
M115	RY0F	Monitor command
M116	RY10	Speed setting command
M125	RY19	
M126	RY1A	Unused
M127	RY1B	Command code execution request
M131	RY1F	

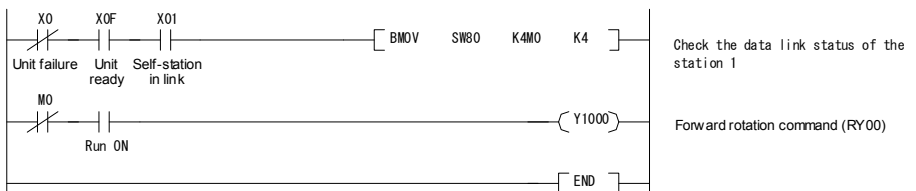

Figure 22

## 12.7 Monitoring procedure

When reading out the output frequency of FRENIC-Eco of station no. 1 into D1:

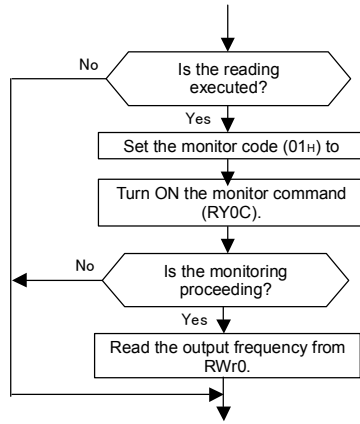

Figure 23

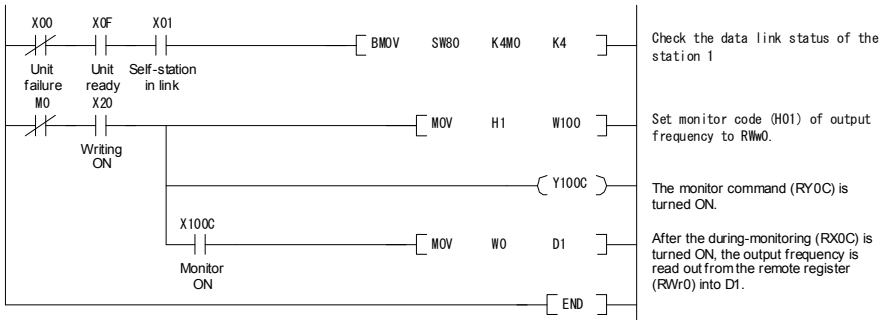

Figure 24

## 12.8 Procedure for reading function codes

When reading out "F07 acceleration time 1" of FRENIC-Eco of station no. 1:

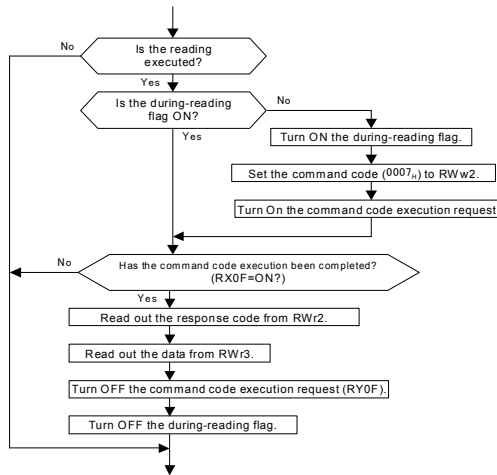

Figure 25

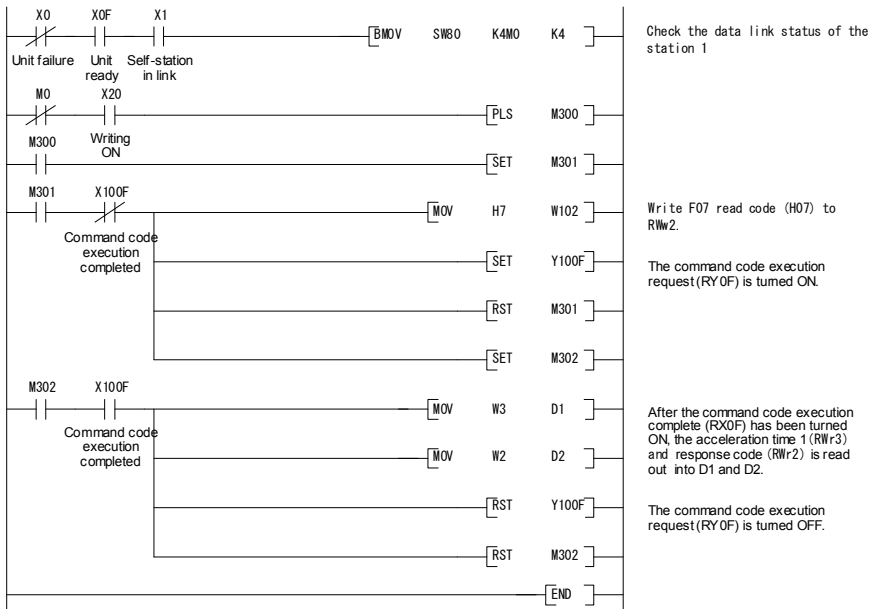

Figure 26

## 12.9 Procedure for writing function codes

Following program change the setting of F07 acceleration time of station 1 RENIC-Eco to 3.0s.

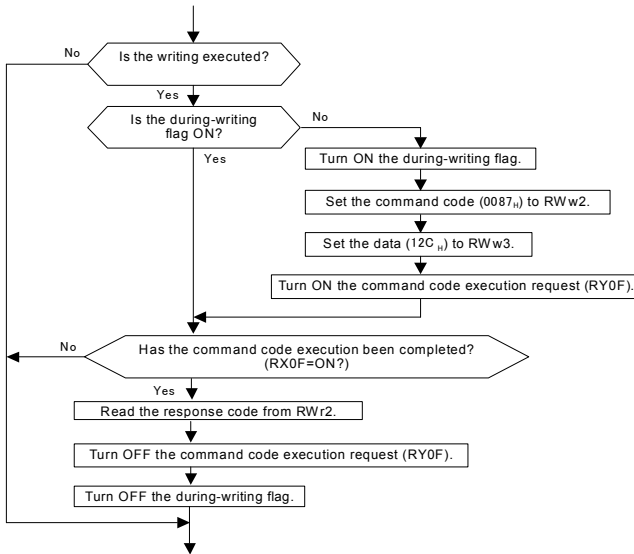

Figure 27

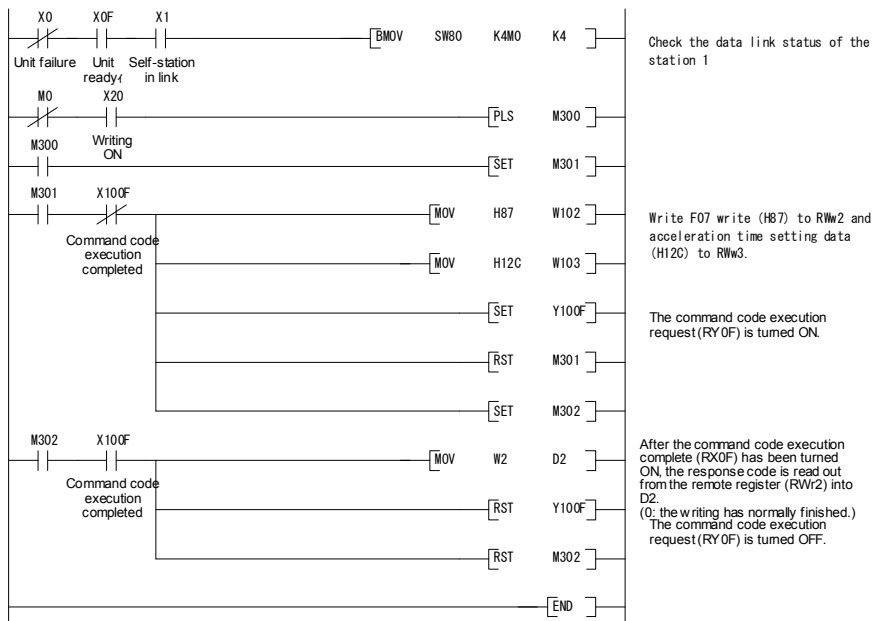

Figure 28

## 12.10 Procedure for setting the command frequency

Following program example changes the command frequency of station 1 RENIC-Eco to 50.00Hz.

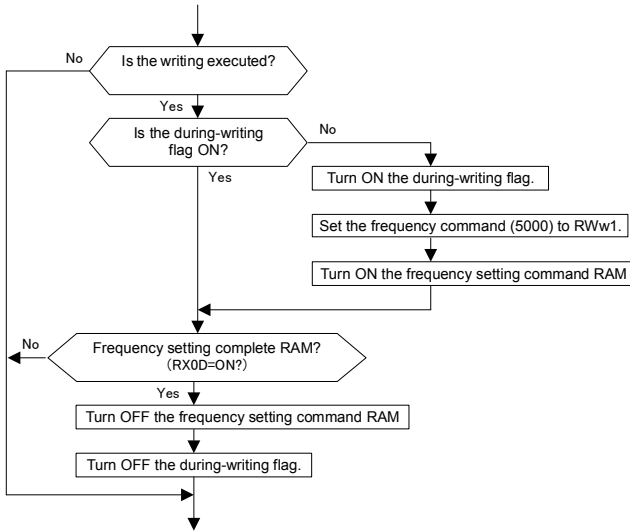

Figure 29

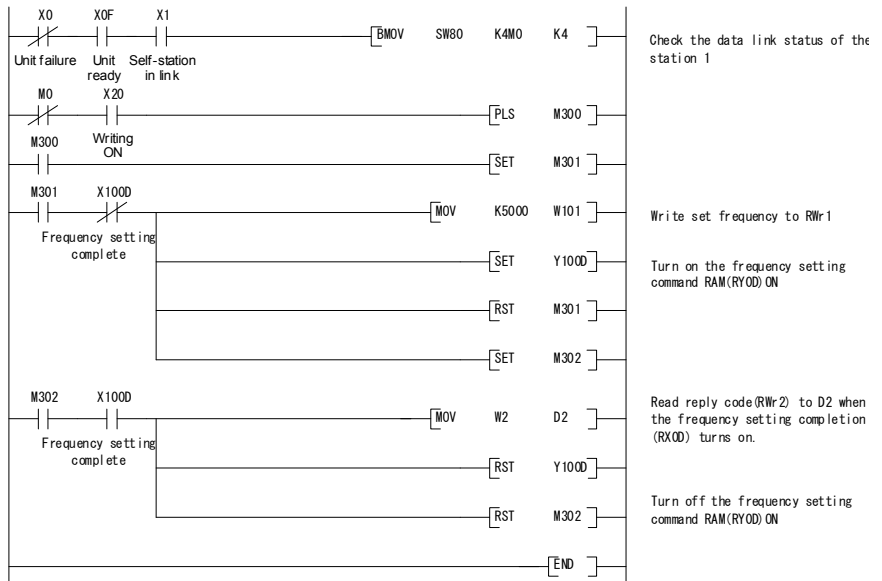

Figure 30



## 12.11 Procedure for reading alarm definition

The following program reads alarm definitions of station 1 FRENIC-Eco to D1

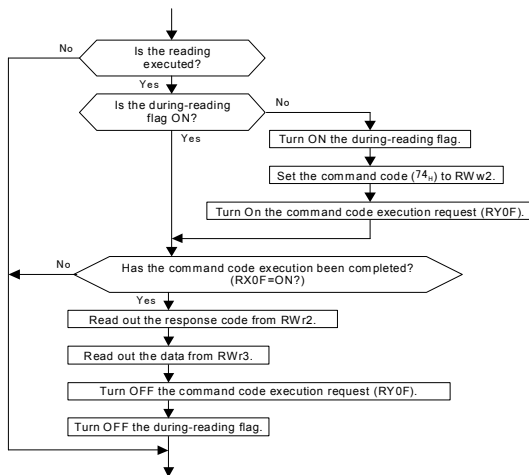

Figure 31

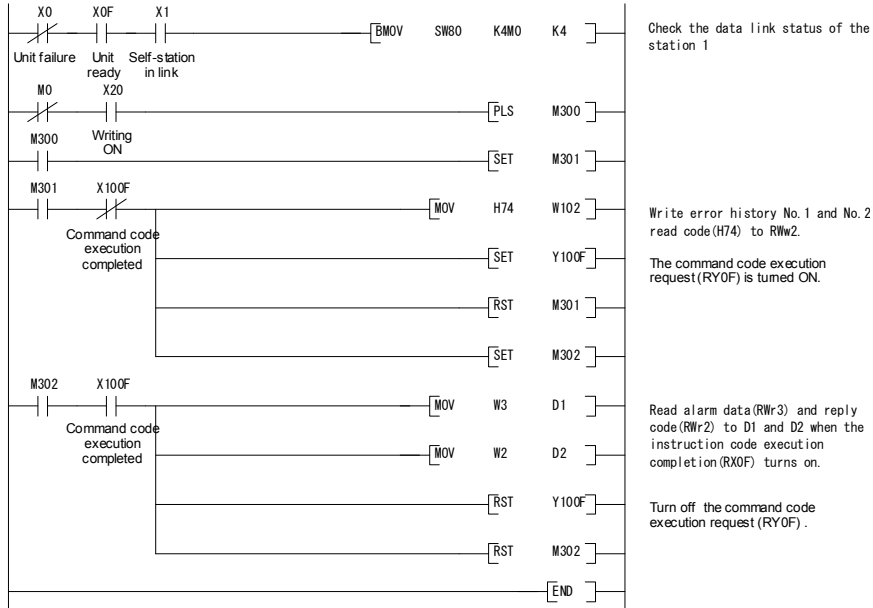

Figure 32

## 12.12 Procedure for resetting the inverter

The following is an example for resetting station 1 FRENIC-Eco

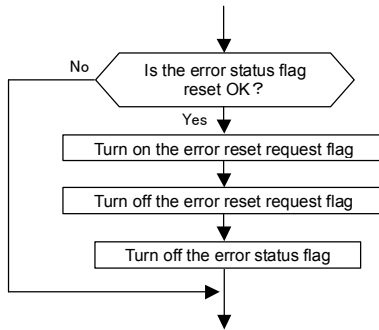

Figure 33

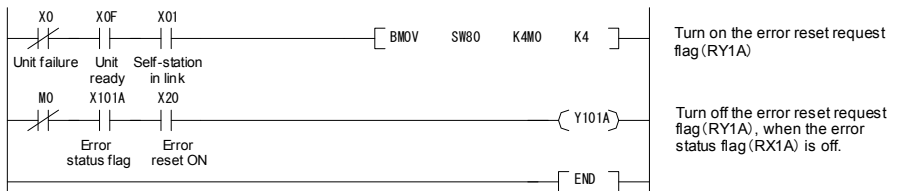
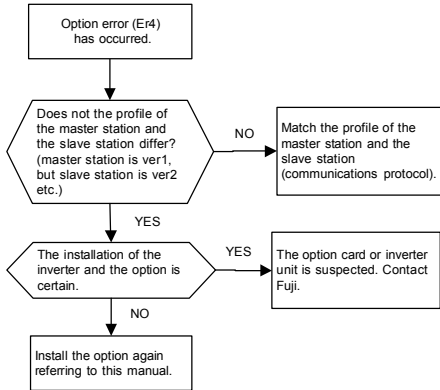

Figure 34

## Chapter13 Troubleshooting

### (1) Option error (Er4)



### (3) The command from the CC-Link is not reflected.

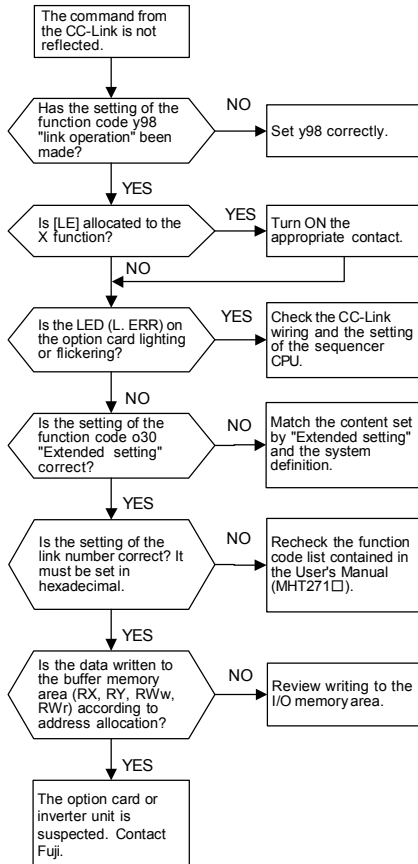

### (2) Network error (Er5)

In case of a network error (CC-Link error), analyze the cause of the failure by referring to the RAS information on the sequencer CPU. For the procedure for referring to the RAS information and its contents, see the Sequencer User's Manual.

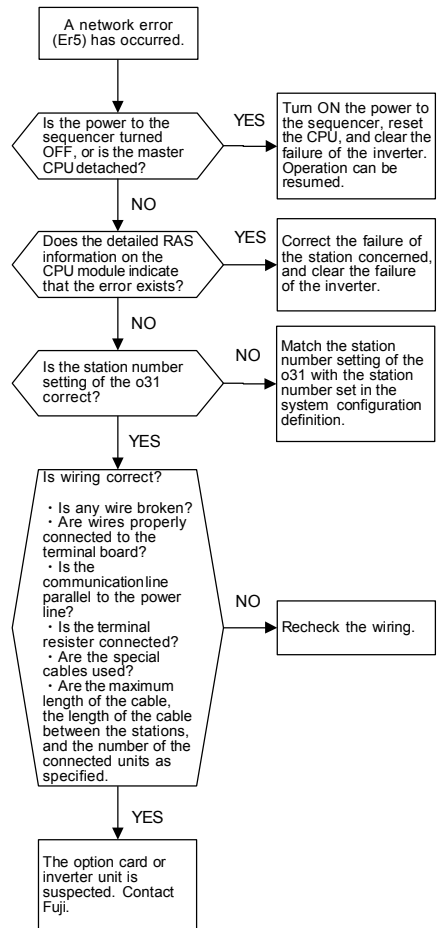

#### (4) Noise measures

The operation status indicate LED (L. ERR) on the option card is lighting or flickering frequently, there is a possibility that the communication abnormality by the influence of the noise has been generated. For this case, following measures are effective. Refer to "Appendix A" of "FRENIC-Eco user's manual (MEH456)" for details.

- 1) Separate the earth pole of the inverter and the earth pole of other equipment.
- 2) Separate the power supply system of other equipment and the inverter with the insulation transformer.
- 3) Separate the main circuit wiring of the inverter with the wiring for the control signal line and other equipment.
- 4) Use the equipment for the noise measures shown in Figure 35.

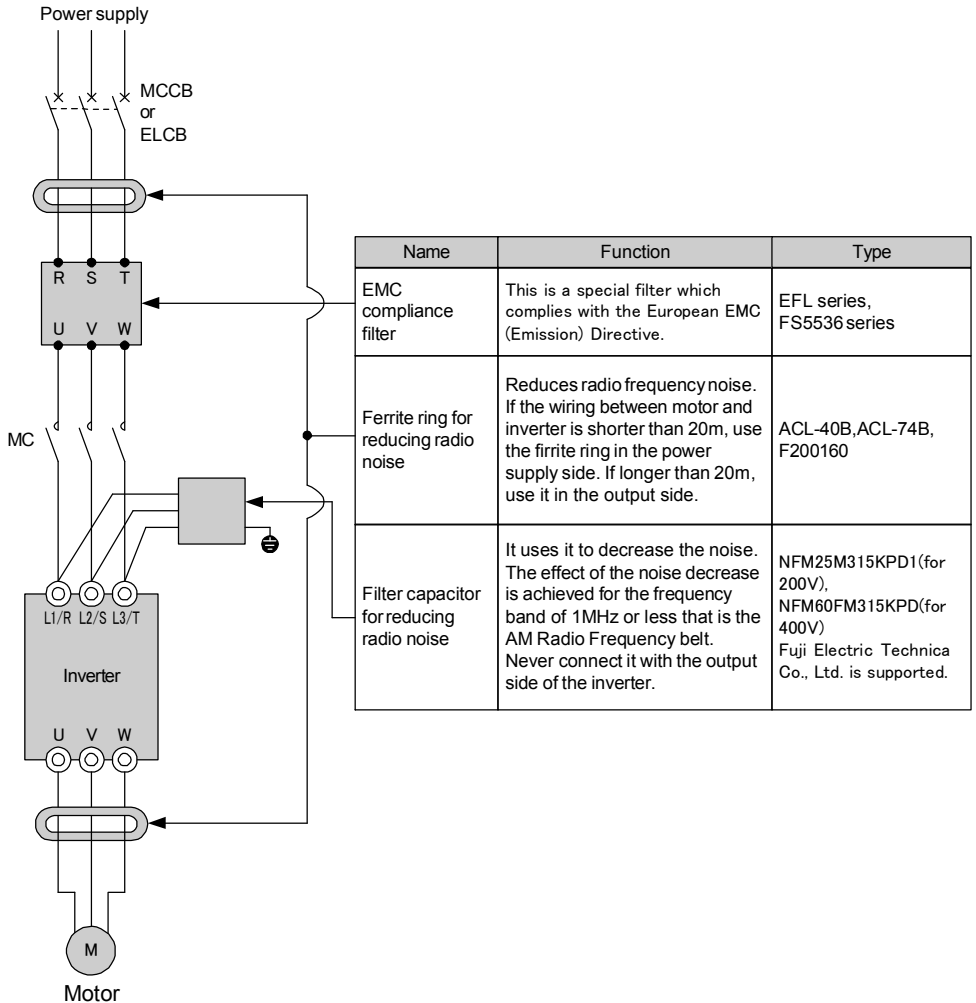

Figure 35

## Chapter14 Specifications

### ⚠ CAUTION

- The system does not operate if the setting of the station number (o31) is not correct. Confirm the following settings, and set the switches to the proper settings.
- Set the option functions with the power to the inverter turned OFF.

Table 16 Hardware specifications

Item	Specifications
Name	CC-Link interface option
Station type	Remote device station
Number of connectable units	42 units max, compatible with other options
Number of stations occupied	Unused ..... o30=0 One station is exclusively occupied (CC-Link Ver1.1) ..... o30=1 One station is exclusively occupied /double(CC-Link Ver2) ..... o30=2 One station is exclusively occupied /quadropole(CC-Link Ver2) ..... o30=3 One station is exclusively occupied /octuple (CC-Link Ver2) ..... o30=4
Connection terminal board	5-terminal board (M3 × 5 screws)
Connection cable	Use CC-Link dedicated cables (FANC-SBH)  For further information, see the CC-Link catalogue or Mitsubishi FA device technical information service MELFANS web site  ( <a href="http://www.nagoya.melco.co.jp/">http://www.nagoya.melco.co.jp/</a> ).
o31	Sets station number (address). An arbitrary station number 1 to 64 can be assigned.
o32	Sets communication speed (Baud rate), 10M / 5M / 2.5M / 625k / 156kbps
Operation status indication LED	L.RUN.....Turned on when refresh data is normally received. Turned off when the data stops for a certain period of time. L.ERR.....Turned on when communication error of the self-station occurs. Flickers if the rotary switch is operated during the power on. RUN.....It lights normally, and it blinks CC-Link Ver set by mistake. SD.....Turned on during transmission. RD.....Turned on during reception.

\* Number of connectable units ..... Because the number of occupied stations differ according to the number of other units (remote I/O station, remote device station) and mixed other profiles, the number of connectable units is required to meet both of the following formulas:

CC-LinkVer 1.10

◆Formula 1:  $(1 \times a) + (2 \times b) + (3 \times c) + (4 \times d) \leq 64$

a: Number of stations occupying one station, b: Number of stations occupying two station,  
c: Number of stations occupying three station, d: Number of stations occupying four station

◆Formula 2:  $(16 \times A) + (54 \times B) + (88 \times C) \leq 2304$

A: number of the units in the remote I/O stations ..... 64 units max.  
B: number of the units in the remote device stations ..... 42 units max.  
C: number of the units in the local stations, waiting master stations,  
and intelligent device stations ..... 26 units max.

CC-Link Ver 2.00

◆Formula 1 :  $\{ ( a + a2 + a4 + a8 ) + ( b + b2 + b4 + b8 ) \times 2 + ( c + c2 + c4 + c8 ) \times 3 + ( d + d2 + d4 + d8 ) \times 4 \} \leq 64$

◆Formula 2 :  $\{ ( a \times 32 + a2 \times 32 + a4 \times 64 + a8 \times 128 ) + ( b \times 64 + b2 \times 96 + b4 \times 192 + b8 \times 384 ) + ( c \times 96 + c2 \times 160 + C4 \times 320 + C8 \times 640 ) + ( d \times 128 + d2 \times 224 + d4 \times 448 + d8 \times 896 ) \} \leq 8192$

◆Formula 3 :  $\{ ( a \times 4 + a2 \times 8 + a4 \times 16 + a8 \times 32 ) + ( b \times 8 + b2 \times 16 + b4 \times 32 + b8 \times 64 ) + ( c \times 12 + c2 \times 24 + C4 \times 48 + C8 \times 96 ) + ( d \times 16 + d2 \times 32 + d4 \times 64 + d8 \times 128 ) \} \leq 2048$

a1: Number of single setting devices occupying one station.  
b1: Number of single setting devices occupying two stations.  
c1: Number of single setting devices occupying three stations.  
d1: Number of single setting devices occupying four stations.  
a2: Number of double setting devices occupying one station.  
b2: Number of double setting devices occupying two stations.  
c2: Number of double setting devices occupying three stations.  
d2: Number of double setting devices occupying four stations.  
a3: Number of quadruple setting devices occupying one station.  
b3: Number of quadruple setting devices occupying two stations.  
c3: Number of quadruple setting devices occupying three stations.  
d3: Number of quadruple setting devices occupying four stations.  
a4: Number of octuple setting devices occupying one station.  
b4: Number of octuple setting devices occupying two stations.  
c4: Number of octuple setting devices occupying three stations.  
d4: Number of octuple setting devices occupying four stations.

◆Formula 4 :  $(16 \times A) + (54 \times B) + (88 \times C) \leq 2304$

A: number of the units in the remote I/O stations ..... 64 units max.  
B: number of the units in the remote device stations ..... 42 units max.  
C: number of the units in the local stations, waiting master stations,  
and intelligent device stations ..... 26 units max.

### Setting of station number (o31)

After turning on the power to the inverter, set the station number of the inverter from 1 to 64.

Table 17 station number specifications

No.	station number
0	Setting error (The LED of the L. ERR comes ON.)
1~64	1~64
65~255	Setting error (The LED of the L. ERR comes ON.)

**Note 1)** Do not change the setting of the station number while the inverter is energized. If the station number is changed while energized, data communication can not be made with the changed station number.

**Note 2)** If the station number is set to a number already used or out of the range, normal communication can not be made. (The LED of the L. ERR comes ON.)

**Note 3)** Set the station number consecutively in order of connections. (If the station number is discontinued,

### Transmission Baud rate (o32)

Set the transmission Baud rate from 0 to 4, after turning on the power to the inverter.

Table 18 Baud rate specifications

No.	Baud rate
0	156kbps (Initial value)
1	625kbps
2	2.5Mbps
3	5Mbps
4	10Mbps
5~255	Setting error (the LED of L. ERR comes on.)

**Note 1)** Do not change the setting of the station number while the inverter is energized. If the station number is changed while energized, data communication can not be made with the changed station number.

### Operation status indication LED

The link status of the CC-Link can be confirmed with five LED's.

Table 19 Specifications of the operating status indication LED's

Status					Performance
L.RUN	L.ERR	RUN	SD	RD	
●	○	●	★	●	Normally communicating
●	★	●	★	●	Normally communicating, but CRC error occurs from time to time due to noise.
●	★	●	○	●	The received data is CRC error, and no response can be made.
●	○	●	○	●	Data to the self-station do not come.
○	★	●	★	●	Making the polling response, but received refresh data is CRC error.
○	★	●	○	●	Data to the self-station is CRC error.
○	○	●	○	●	There is no data to the self-station, or data to the self-station cannot be received due to noise.
○	●	●	○	●○	Incorrect setting of Baud rate or station number、 error of writing outside range
●	★ (0.8s period)	●	★	●	Baud rate or station number has changed halfway.
○	○	●	★	●	No link startup
○	○	●	○	○	Data cannot be received due to broken wire, etc., the power is off, hardware is being reset, Er3 has occurred, or the power supply is in failure.
○	○	★	○	○	Master station is connected to CC-Link Ver.1 and self station is connected to CC-Link Ver.2. CC-Link extended setting is 0,5~255.

● : ON, ○ : OFF, ★ : Flicker (may look like turned on depending on the transmission Baud rate.)

Note 1)If the LED's comes on in other patterns than the above, it can be considered as hardware failure.

Please contact our company.

Table 20 Software specifications

Item		Specifications
Operation	Operation command	Forward/Reverse rotation commands, alarm reset command, X1~X5 commands
	Speed command	16-bit binary data
	Operation status output	Bit data, such as running, braking, torque limitation, and alarm relay output Word data, such as motor speed and torque current commands
Function code		Function codes assigned to the link numbers of the function code list can be referred to and changed. (Refer to Chapter 11.)
Option function code		o27, o28, o30, o31, o32 ..... The factory-shipped value is 0.
Protective function		Er5: CC-Link error Option failure (the method of stopping the option can be selected with the function code o27 or o28.)



# **CC-Link Interface Card "OPC-F1-CCL"**

---

## **Instruction Manual**

First Edition, June 2006

Fuji Electric FA Components & Systems Co., Ltd.

---

The purpose of this manual is to provide accurate information in the handling, setting up and operating of CC-Link Interface Card "OPC-F1-CCL" for the FRENIC-Eco series of inverters. Please feel free to send your comments regarding any errors or omissions you may have found, or any suggestions you may have for generally improving the manual.

In no event will Fuji Electric FA Components & Systems Co., Ltd. be liable for any direct or indirect damages resulting from the application of the information in this manual.

---

## **Fuji Electric FA Components & Systems Co., Ltd.**

Mitsui Sumitomo Bank Ningyo-cho Bldg., 5-7, Nihonbashi, Odemma-cho, Chuo-ku, Tokyo, 103-0011, Japan

Phone: +81 3 5847 8011 Fax: +81 3 5847 8172

**URL** <http://www.fujielectric.co.jp/fcs/>

---