

# Operating Instructions

## Deltapilot S FMB70

Hydrostatic level measurement

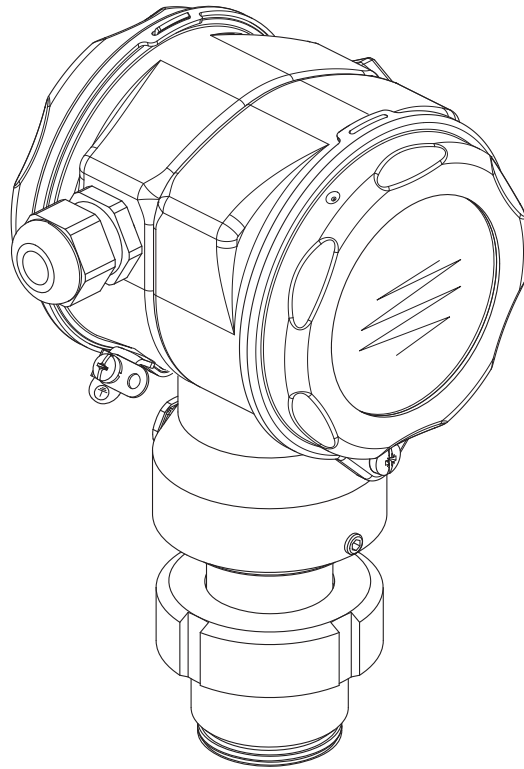

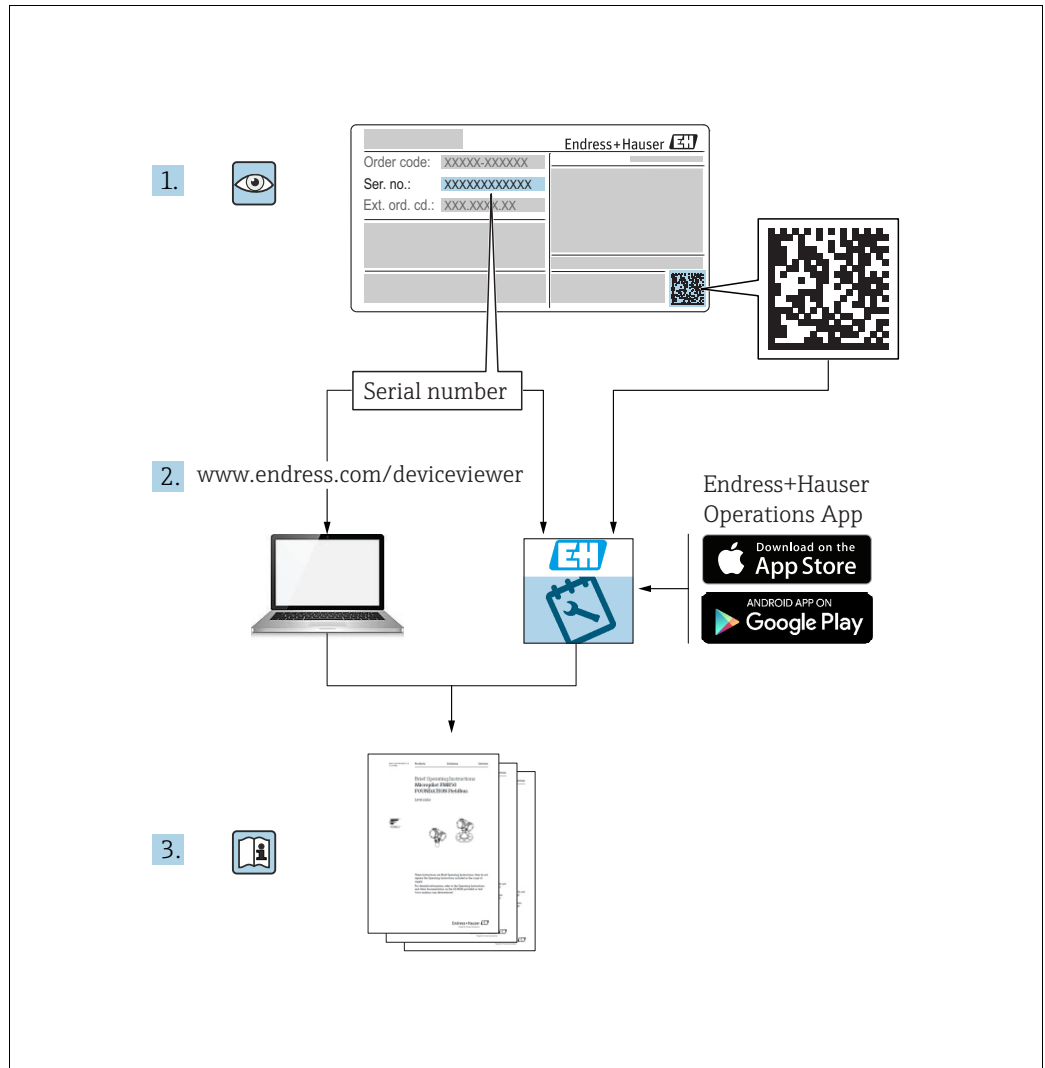

A0023555

Make sure the document is stored in a safe place such that it is always available when working on or with the device.

To avoid danger to individuals or the facility, read the "Basic safety instructions" section carefully, as well as all other safety instructions in the document that are specific to working procedures.

The manufacturer reserves the right to modify technical data without prior notice. Your Endress+Hauser Sales Center will supply you with current information and updates to these Instructions.

## Table of contents

<b>1</b>	<b>Document information</b> .....	<b>4</b>	7.3	Selecting language and measuring mode .....	39
1.1	Document function .....	4	7.4	Position adjustment .....	40
1.2	Symbols used .....	4	7.5	Level measurement .....	42
1.3	Registered trademarks .....	5	7.6	Pressure measurement .....	46
1.4	Terms and abbreviations .....	6	<b>8</b>	<b>Maintenance</b> .....	<b>47</b>
1.5	Turn down calculation .....	7	8.1	Exterior cleaning .....	47
<b>2</b>	<b>Basic safety instructions</b> .....	<b>8</b>	<b>9</b>	<b>Trouble-shooting</b> .....	<b>48</b>
2.1	Requirements concerning the staff .....	8	9.1	Messages .....	48
2.2	Designated use .....	8	9.2	Response of outputs to errors .....	56
2.3	Workplace safety .....	8	9.3	Confirming messages .....	58
2.4	Operational safety .....	8	9.4	Repair .....	59
2.5	Hazardous area .....	9	9.5	Repair of Ex-certified devices .....	59
2.6	Product safety .....	9	9.6	Spare Parts .....	59
2.7	Functional Safety SIL3 (optional) .....	9	9.7	Return .....	59
<b>3</b>	<b>Identification</b> .....	<b>10</b>	9.8	Disposal .....	59
3.1	Product identification .....	10	9.9	Software history .....	60
3.2	Device designation .....	10	<b>10</b>	<b>Technical data</b> .....	<b>60</b>
3.3	Scope of delivery .....	12		<b>Index</b> .....	<b>61</b>
3.4	CE mark, declaration of conformity .....	12			
<b>4</b>	<b>Installation</b> .....	<b>13</b>			
4.1	Incoming acceptance and storage .....	13			
4.2	Installation conditions .....	13			
4.3	General installation instructions .....	13			
4.4	Installation instructions .....	14			
4.5	Post-installation check .....	19			
<b>5</b>	<b>Wiring</b> .....	<b>20</b>			
5.1	Connecting the device .....	20			
5.2	Connecting the measuring unit .....	22			
5.3	Potential matching .....	24			
5.4	Overvoltage protection (optional) .....	24			
5.5	Post-connection check .....	24			
<b>6</b>	<b>Operation</b> .....	<b>25</b>			
6.1	On-site display (optional) .....	25			
6.2	Operating elements .....	26			
6.3	On-site operation – on-site display not connected .....	28			
6.4	On-site operation – on-site display connected .....	31			
6.5	HistoROM®/M-DAT (optional) .....	33			
6.6	Operation via SFX100 .....	36			
6.7	Endress+Hauser operating program .....	36			
6.8	Locking/unlocking operation .....	36			
6.9	Factory setting (reset) .....	37			
<b>7</b>	<b>Commissioning</b> .....	<b>39</b>			
7.1	Configuring messages .....	39			
7.2	Function check .....	39			





# 1 Document information

## 1.1 Document function







These Operating Instructions contain all the information that is required in various phases of the life cycle of the device: from product identification, incoming acceptance and storage, to mounting, connection, operation and commissioning through to troubleshooting, maintenance and disposal.

## 1.2 Symbols used



### 1.2.1 Safety symbols

Symbol	Meaning
 A0011189-DE	<b>DANGER!</b> This symbol alerts you to a dangerous situation. Failure to avoid this situation will result in serious or fatal injury.
 A0011190-DE	<b>WARNING!</b> This symbol alerts you to a dangerous situation. Failure to avoid this situation can result in serious or fatal injury.
 A0011191-DE	<b>CAUTION!</b> This symbol alerts you to a dangerous situation. Failure to avoid this situation can result in minor or medium injury.
 A0011192-DE	<b>NOTICE!</b> This symbol contains information on procedures and other facts which do not result in personal injury.









### 1.2.2 Electrical symbols

Symbol	Meaning	Symbol	Meaning
	Direct current		Alternating current
	Direct current and alternating current		<b>Ground connection</b> A grounded terminal which, as far as the operator is concerned, is grounded via a grounding system.
	<b>Protective ground connection</b> A terminal which must be connected to ground prior to establishing any other connections.		<b>Equipotential connection</b> A connection that has to be connected to the plant grounding system: This may be a potential equalization line or a star grounding system depending on national or company codes of practice.

### 1.2.3 Tool symbols

Symbol	Meaning
 A0011221	Allen key
 A0011222	Hexagon wrench

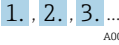
### 1.2.4 Symbols for certain types of information

Symbol	Meaning
 A0011182	<b>Permitted</b> Indicates procedures, processes or actions that are permitted.
 A0011184	<b>Forbidden</b> Indicates procedures, processes or actions that are forbidden.
 A0011193	<b>Tip</b> Indicates additional information.
 A0028658	Reference to documentation
 A0028659	Reference to page
 A0028660	Reference to graphic
 A0031595	Series of steps
 A0018343	Result of a sequence of actions
 A0028673	Visual inspection

### 1.2.5 Symbols in graphics

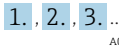
Symbol	Meaning
1, 2, 3, 4, ...	Item numbers
 A0031595	Series of steps
A, B, C, D, ...	Views

### 1.2.6 Symbols at the device

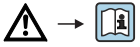
Symbol	Meaning
 A0019159	<b>Safety instructions</b> Observe the safety instructions contained in the associated Operating Instructions.

## 1.3 Registered trademarks

KALREZ, VITON, TEFLON  
Registered trademarks of E.I. Du Pont de Nemours & Co., Wilmington, USA

TRI-CLAMP  
Registered trademark of Ladish & Co., Inc., Kenosha, USA

HART  
Registered trademark of the HART Communication Foundation, Austin, USA.

GORE-TEX®  
Registered trademarks of W.L. Gore & Associates, Inc., USA

## 1.4 Terms and abbreviations

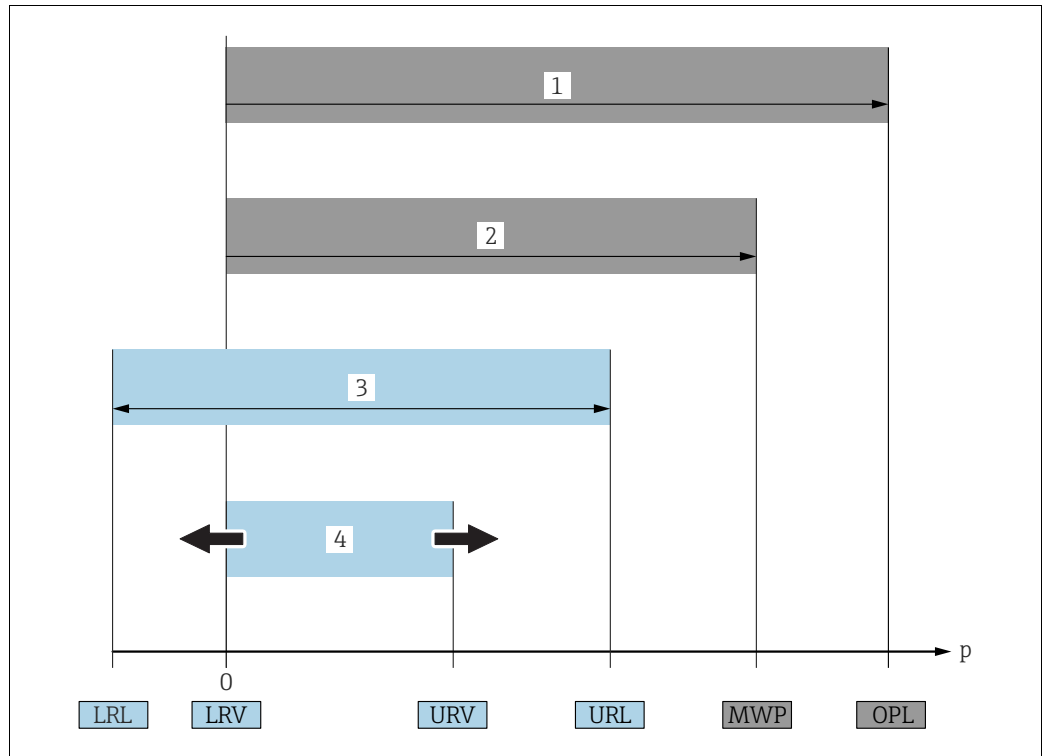

A0029505

Position	Term/Abbreviation	Explanation
1	OPL	The OPL (over pressure limit = sensor overload limit) for the sensors depends on the lowest-rated element, with regard to pressure, of the selected components, i.e. the process connection must be taken into consideration in addition to the measuring cell. Also observe pressure-temperature dependency. For the relevant standards and additional notes, see technical information. The OPL may be applied for a limited time period.
2	MWP	The MWP (maximum working pressure) for the sensors depends on the lowest-rated element, with regard to pressure, of the selected components, i.e. the process connection has to be taken into consideration in addition to the measuring cell. Also observe pressure-temperature dependency. For the relevant standards and additional notes, see technical information. The MWP may be applied for an unlimited time.
3	Maximum sensor measuring range	Range between LRL and URL This span is the maximum calibratable/adjustable measuring span.
4	Calibrated/Adjusted measuring span	Range between LRV and URV Factory setting: 0...URL Other calibrated spans can be ordered with customised settings.
p	-	Pressure
-	LRL	Lower range limit
-	URL	Upper range limit
-	LRV	Lower range value
-	URV	Upper range value
-	TD	Turn down

## 1.5 Turn down calculation

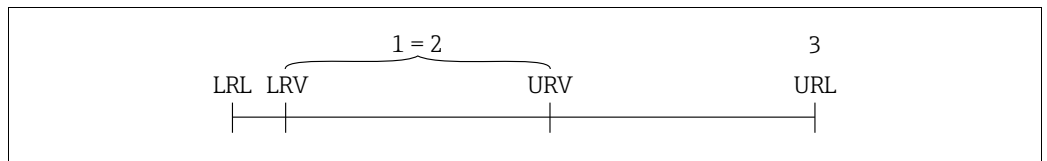

Fig. 1:

- 1 Calibrated/Adjusted measuring span
- 2 Zero-based span
- 3 Upper range limit

### Example

- Sensor: 10 bar (150 psi)
- Upper range limit (URL) = 10 bar (150 psi)
- Calibrated/Adjusted measuring span: 0...5 bar (0...75 psi)
- Lower range value (LRV) = 0 bar
- Upper range value (URV) = 5 bar (75 psi)

Turn down (TD):

$$TD = \frac{URL}{|URV - LRV|}$$

$$TD = \frac{10 \text{ bar (150 psi)}}{|5 \text{ bar (75 psi)} - 0 \text{ bar (0 psi)}|} = 2$$

In this example, the TD is thus 2:1.  
This span is based on the zero point.

## 2 Basic safety instructions

### 2.1 Requirements concerning the staff

The personnel for installation, commissioning, diagnostics and maintenance must fulfill the following requirements:

- Trained, qualified specialists: must have a relevant qualification for this specific function and task
- Are authorized by the plant owner/operator
- Are familiar with federal/national regulations
- Before beginning work, the specialist staff must have read and understood the instructions in the Operating Instructions and supplementary documentation as well as in the certificates (depending on the application)
- Following instructions and basic conditions

The operating personnel must fulfill the following requirements:

- Being instructed and authorized according to the requirements of the task by the facility's owner-operator
- Following the instructions in these Operating Instructions

### 2.2 Designated use

The Deltapilot S is a hydrostatic pressure transmitter for measuring level and pressure.

#### 2.2.1 Incorrect use

The manufacturer is not liable for damage caused by improper or non-designated use.

Verification for borderline cases:

For special fluids and fluids for cleaning, Endress+Hauser is glad to provide assistance in verifying the corrosion resistance of fluid-wetted materials, but does not accept any warranty or liability.

### 2.3 Workplace safety

For work on and with the device:

- Wear the required personal protective equipment according to federal/national regulations.
- Switch off the supply voltage before connecting the device.

### 2.4 Operational safety

Risk of injury!

- ▶ Operate the device in proper technical condition and fail-safe condition only.
- ▶ The operator is responsible for interference-free operation of the device.

#### Conversions to the device

Unauthorized modifications to the device are not permitted and can lead to unforeseeable dangers:

- ▶ If, despite this, modifications are required, consult with Endress+Hauser.

#### Repair

To ensure continued operational safety and reliability,

- ▶ Carry out repairs on the device only if they are expressly permitted.
- ▶ Observe federal/national regulations pertaining to repair of an electrical device.
- ▶ Use original spare parts and accessories from Endress+Hauser only.



## 2.5 Hazardous area

To eliminate a danger for persons or for the facility when the device is used in the hazardous area (e.g. explosion protection, pressure vessel safety):

- Based on the nameplate, check whether the ordered device is permitted for the intended use in the hazardous area.
- Observe the specifications in the separate supplementary documentation that is an integral part of these Instructions.

## 2.6 Product safety

This measuring device is designed in accordance with good engineering practice to meet state-of-the-art safety requirements, has been tested, and left the factory in a condition in which they are safe to operate. It fulfills general safety requirements and legal requirements. It also conforms to the EC directives listed in the device-specific EC declaration of conformity. Endress+Hauser confirms this fact by applying the CE mark.

## 2.7 Functional Safety SIL3 (optional)

If using devices for applications with safety integrity, the Functional Safety Manual must be observed thoroughly.

## 3 Identification

### 3.1 Product identification

The following options are available for identification of the measuring device:

- Nameplate specifications
- Order code with breakdown of the device features on the delivery note
- Enter serial numbers from nameplates in W@M Device Viewer ([www.endress.com/deviceviewer](http://www.endress.com/deviceviewer)) : All information about the measuring device is displayed.

For an overview of the technical documentation provided, enter the serial number from the nameplates in the W@M Device Viewer ([www.endress.com/deviceviewer](http://www.endress.com/deviceviewer)).

#### 3.1.1 Manufacturer address

Endress+Hauser GmbH+Co. KG  
Hauptstraße 1  
79689 Maulburg, Germany  
Address of the manufacturing plant: See nameplate.

### 3.2 Device designation

#### 3.2.1 Nameplate

- The MWP (maximum working pressure) is specified on the nameplate. This value refers to a reference temperature of +20 °C (68°F) and may be applied to the device for an unlimited time. Observe temperature dependency of the MWP. The pressure values permitted at higher temperatures can be found in the standards EN 1092-1: 2001 Tab. 18 (With regard to their stability-temperature property, the materials 1.4435 and 1.4404 are grouped together under 13EO in EN 1092-1 Tab. 18. The chemical composition of the two materials can be identical.), ASME B 16.5a – 1998 Tab. 2-2.2 F316, ASME B 16.5a – 1998 Tab. 2.3.8 N10276, JIS B 2220.
- The test pressure corresponds to the over pressure limit (OPL) of the device = MWP x 1.5.
- The Pressure Equipment Directive (2014/68/EU) uses the abbreviation "PS". The abbreviation "PS" corresponds to the MWP (maximum working pressure) of the measuring device.

#### Aluminum housing (T14/T15)

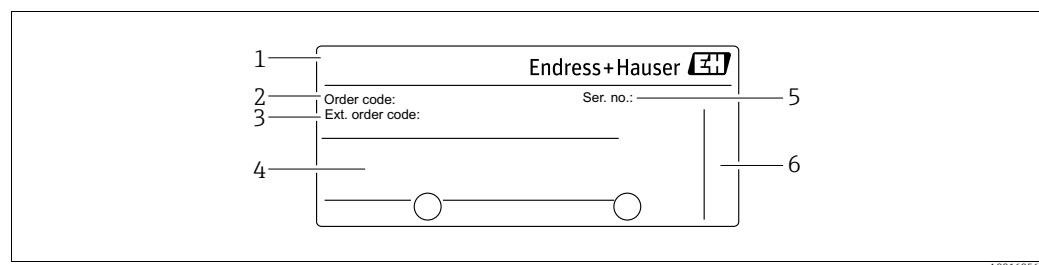

Fig. 2: Nameplate

- 1 Device name
- 2 Order code (for re-orders)
- 3 Extended order code (complete)
- 4 Technical data
- 5 Serial number (for identification)
- 6 Address of manufacturer

Devices for use in hazardous areas are fitted with an additional nameplate.

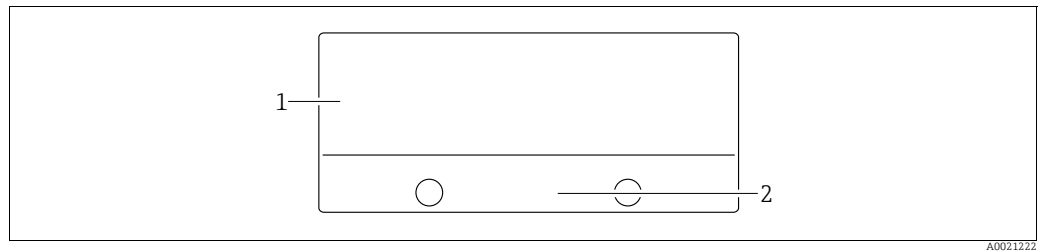

Fig. 3: Additional nameplate

- 1 Approval-specific information
- 2 Document number for safety instructions or drawing number

### Hygienic stainless steel housing (T17)

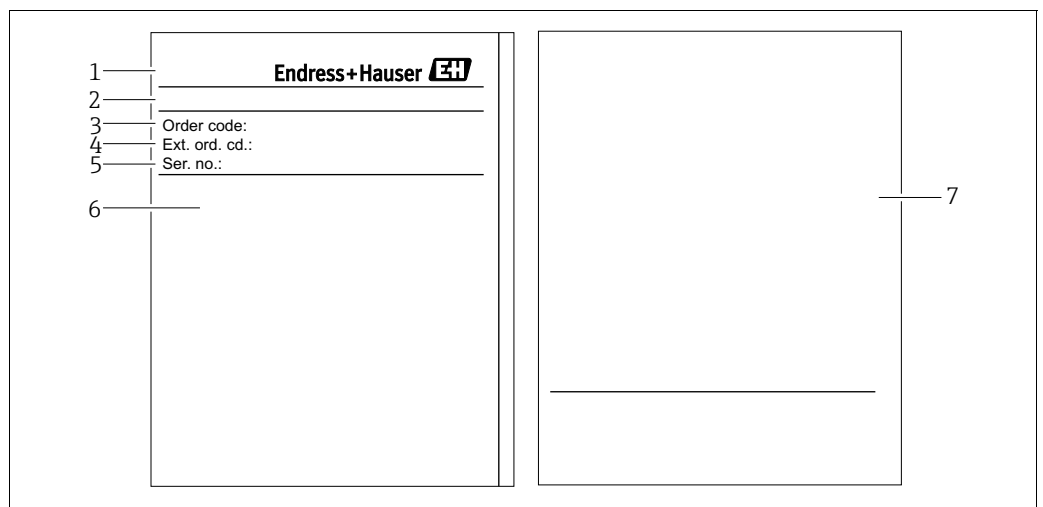

Fig. 4: Nameplate

- 1 Device name
- 2 Address of manufacturer
- 3 Order code (for re-orders)
- 4 Extended order code (complete)
- 5 Serial number (for identification)
- 6 Technical data
- 7 Approval-specific information and document number for safety instructions or drawing number

### 3.2.2 Identifying the sensor type

See parameter "Sensor Meas.Type" in Operating Instruction BA00274P.

### 3.3 Scope of delivery

The scope of delivery comprises:

- Deltapilot S hydrostatic pressure transmitter
- For devices with the "HistoROM/M-DAT" option:  
CD-ROMs with Endress+Hauser operating program
- Optional accessories

Documentation supplied:

- The Operating Instructions BA00332P and BA00274P are available via the Internet.  
→ See: [www.endress.com](http://www.endress.com) → Download.
- Brief Operating Instructions KA01020P
- Leporello KA00218P
- Final inspection report
- Also Safety Instructions with devices for use in hazardous areas
- Optional: factory calibration form, test certificates

### 3.4 CE mark, declaration of conformity

The device is designed to meet state-of-the-art safety requirements, has been tested and left the factory in a condition in which it is safe to operate. The device complies with the applicable standards and regulations as listed in the EC declaration of conformity and thus complies with the statutory requirements of the EC Directives. Endress+Hauser confirms the successful testing of the device by affixing to it the CE mark.

## 4 Installation

### 4.1 Incoming acceptance and storage

#### 4.1.1 Incoming acceptance

- Check the packaging and the contents for damage.
- Check the shipment, make sure nothing is missing and that the scope of supply matches your order.

#### 4.1.2 Transport

**▲ WARNING**

##### **Incorrect transportation**

Housing and diaphragm may become damaged, and there is a risk of injury!

- ▶ Transport the measuring device to the measuring point in its original packaging or by the process connection (with secure transport protection for the diaphragm).
- ▶ Follow the safety instructions and transport conditions for devices weighing more than 18 kg (39.6 lbs).

#### 4.1.3 Storage

The device must be stored in a dry, clean area and protected against damage from impact (EN 837-2).

Storage temperature range:

- -40 to +90°C (-40 to +194°F)
- On-site display: -40 to +85°C (-40 to +185°F)
- Separate housing: -40 to +60°C (-40 to +140°F)

### 4.2 Installation conditions

#### 4.2.1 Dimensions

→ For dimensions, please refer to the Technical Information for Deltapilot S TI00416P, "Mechanical construction" section.

### 4.3 General installation instructions

- Devices with a G 1 1/2 thread:  
When screwing the device into the tank, the flat seal has to be positioned on the sealing surface of the process connection. To avoid additional strain on the process isolating diaphragm, the thread should never be sealed with hemp or similar materials.
- Devices with NPT threads:
  - Wrap Teflon tape around the thread to seal it.
  - Tighten the device at the hexagonal bolt only. Do not turn at the housing.
  - Do not overtighten the thread when screwing. Max. torque: 20 to 30 Nm (14.75 to 22.13 lbf ft)

## 4.4 Installation instructions

- Due to the orientation of the Deltapilot S, there may be a shift in the measured value, i.e. when the container is empty, the measured value does not display zero. You may correct this zero point shift either directly on the device using the  $\square$ -key or by remote operation. → [§ 27](#), "Function of the operating elements – on-site display not connected" or → [§ 40](#), "Position adjustment".
- To ensure optimal readability of the on-site display, it is possible to rotate the housing up to 380°. → [§ 18](#), Section 4.4.5 "Rotating the housing".
- The on-site display can be rotated in 90° stages.
- Endress+Hauser offers a mounting bracket for installing on pipes or walls. → [§ 16](#), Section 4.4.3 "Wall and pipe mounting (optional)".

### 4.4.1 Installation instructions

#### NOTICE

##### Damage to the device!

If a heated Deltapilot S is cooled during the cleaning process (e.g. by cold water), a vacuum develops for a short time, whereby moisture can penetrate the sensor through the pressure compensation (1).

- ▶ If this is the case, mount the sensor with the pressure compensation (1) pointing downwards.

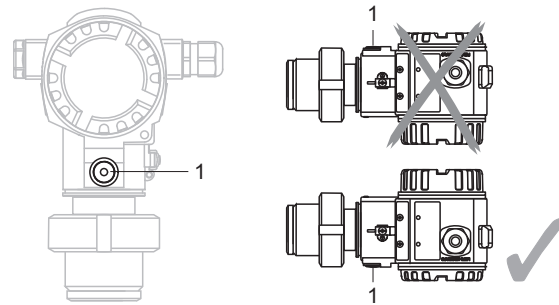

- Keep the pressure compensation and GORE-TEX® filter (1) free from contaminations.
- Do not clean or touch process isolating diaphragm with hard or pointed objects.
- The device must be installed as follows in order to comply with the cleanability requirements of the ASME-BPE (Part SD Cleanability):

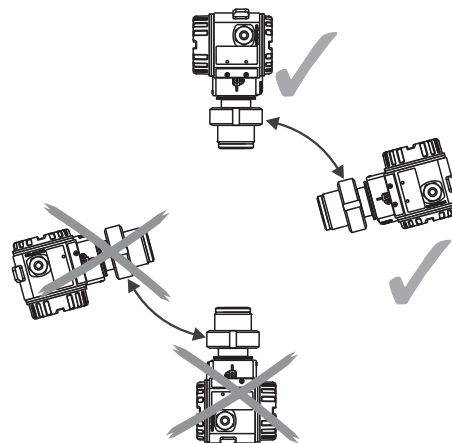

### Level measurement

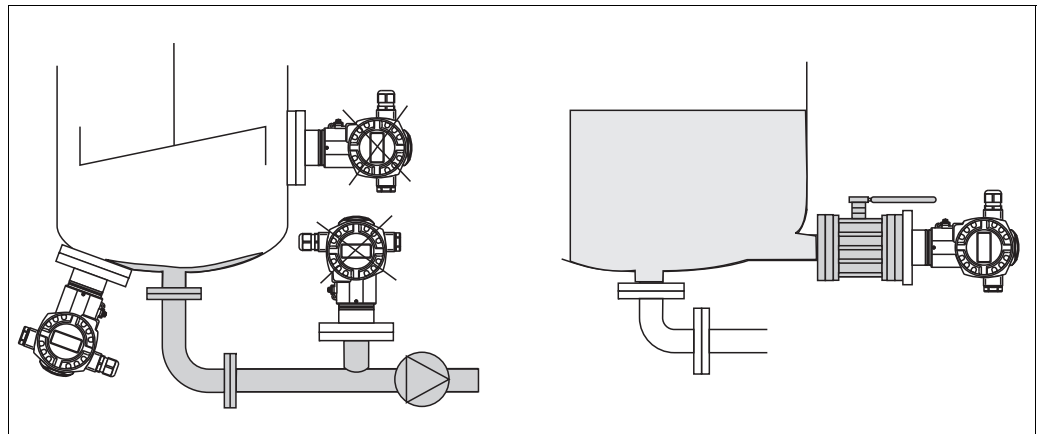

Fig. 5: Measuring arrangement for level

P01-PMP75xxx-11-xx-xx-xx-000

- Always install the device below the lowest measuring point.
- Do not install the device at the following positions:
  - in the filling curtain
  - in the tank outflow
  - in the suction area of a pump
  - or at a point in the tank that can be affected by pressure pulses from the agitator
- The calibration and functional test can be carried out more easily if you mount the device downstream of a shutoff device.
- Deltapilot S must be included in the insulation for media that can harden when cold.

### Pressure measurement in gases

- Mount Deltapilot S with shutoff device above the tapping point so that any condensate can flow into the process.

### Pressure measurement in steams

- Mount Deltapilot S with siphon above the tapping point.
- Fill the siphon with liquid before commissioning.  
The siphon reduces the temperature to almost the ambient temperature.

### Pressure measurement in liquids

- Mount Deltapilot S with the shutoff device below or at the same level as the tapping point.

### 4.4.2 Seal for flange mounting

**NOTICE**

**Corrupted measurement results.**

The seal is not allowed to press against the process isolating diaphragm as this could affect the measurement result.

- ▶ Ensure that the seal is not touching the process isolating diaphragm.

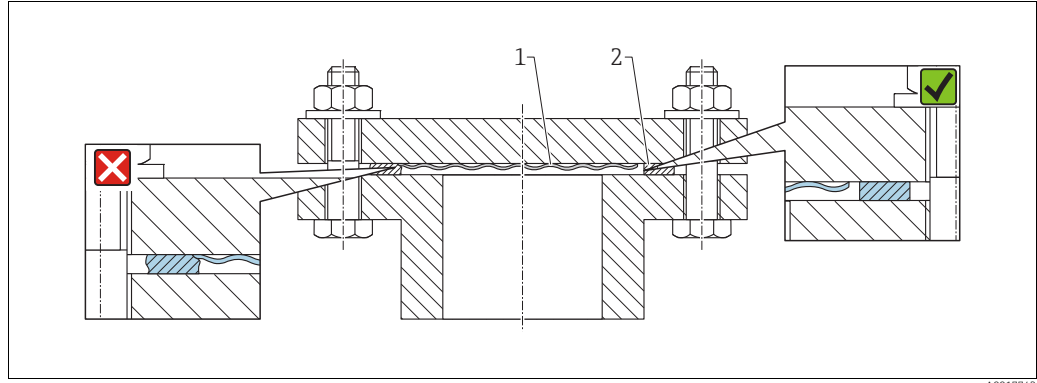
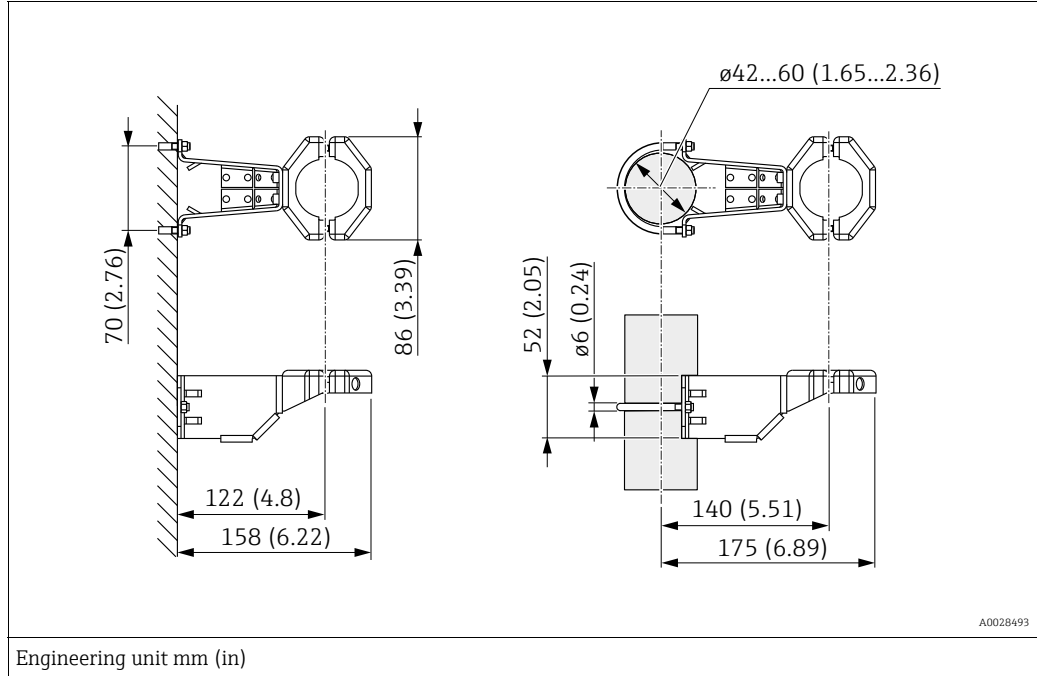

Fig. 6:  
 1 Process isolating diaphragm  
 2 Seal

### 4.4.3 Wall and pipe mounting (optional)

Endress+Hauser offers a mounting bracket for installation on pipes or walls (for pipe diameters from 1 ¼" to 2").



Please note the following when mounting:

- Devices with capillary tubes: mount capillaries with a bending radius  $\geq 100$  mm (3.94 in).
- When mounting on a pipe, tighten the nuts on the bracket uniformly with a torque of at least 5 Nm (3.69 lbs ft).



#### 4.4.4 Assembling and mounting the "separate housing" version

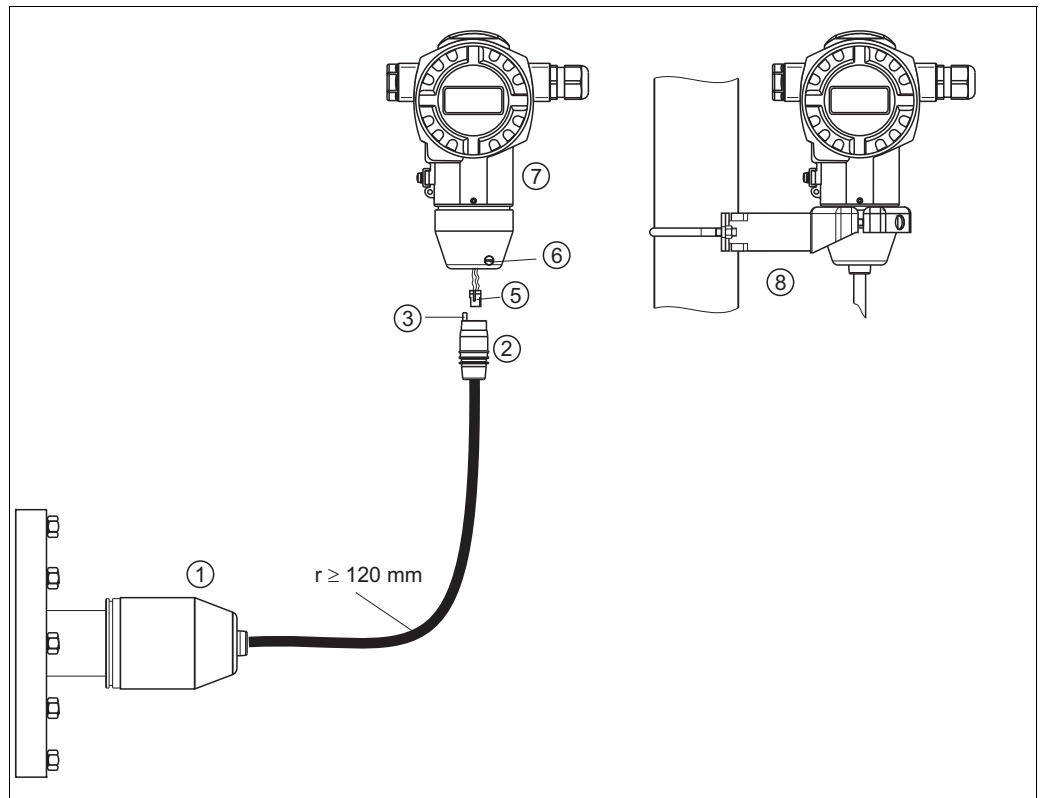

P01-FMB70xxx-11-xx-xx-xx-003

Fig. 7: "Separate housing" version

- 1 In the "separate housing" version, the sensor is supplied with process connection and cable fitted.
- 2 Cable with connection jack
- 3 Pressure compensation
- 5 Plug
- 6 Locking screw
- 7 Housing fitted with housing adapter, included
- 8 Mounting bracket suitable for wall and pipe mounting, included

#### Assembly and mounting

1. Connect plug (item 5) into the corresponding connection jack of the cable (item 2).
2. Plug the cable into the housing adapter (item 7).
3. Tighten the locking screw (item 5).
4. Mount the housing on a wall or pipe using the mounting bracket (item 8). When mounting on a pipe, tighten the nuts on the bracket uniformly with a torque of at least 5 Nm (3.69 lbs ft).  
Mount the cable with a bending radius ( $r$ )  $\geq$  120 mm (4.72 in).

#### 4.4.5 Rotating the housing

The housing can be rotated up to 380° by loosening the Allen screw.

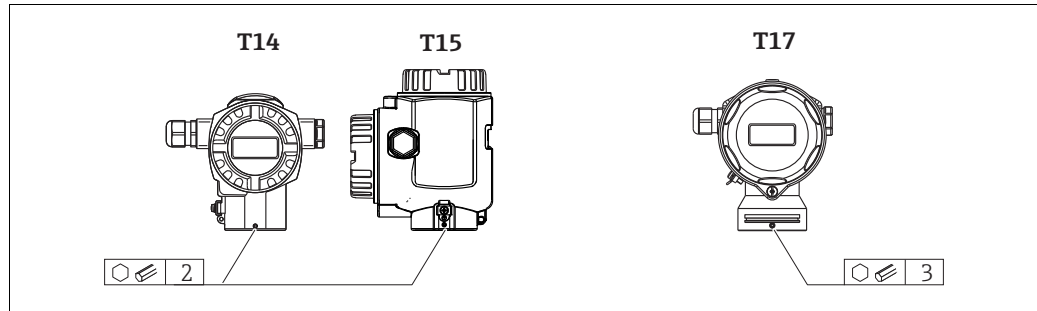

1. T14 and T15 housing: Loosen setscrew with a 2 mm (0.08 in) Allen key.  
T17 housing: Loosen setscrew with a 3 mm (0.12 in) Allen key.
2. Rotate housing (max. up to 380°).
3. Retighten setscrew with 1 Nm (0,74 lbf ft).

#### 4.4.6 Closing the housing cover

##### NOTICE

##### Devices with EPDM cover seal - transmitter leakiness!

Mineral-based, animal-based or vegetable-based lubricants cause the EPDM cover seal to swell and the transmitter to become leaky.

- ▶ The thread is coated at the factory and therefore does not require any lubrication.

##### NOTICE

##### The housing cover can no longer be closed.

Damaged thread!

- ▶ When closing the housing cover, please ensure that the thread of the cover and housing are free from dirt, e.g. sand. If you feel any resistance when closing the cover, check the thread on both again to ensure that they are free from dirt.

##### Close cover on a hygienic stainless steel housing (T17)

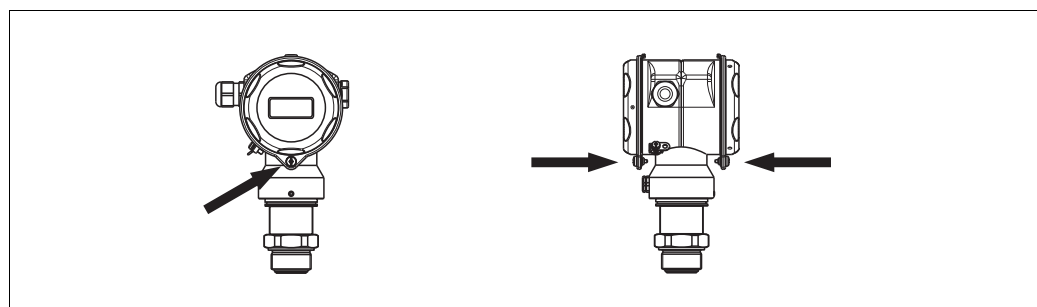

Fig. 8: Close cover

The covers for the terminal and electronics compartment are hooked into the casing and closed with a screw. These screws should be finger-tightened (2 Nm (1.48 lbf ft)) to the stop to ensure that the covers sit tightly.

#### **4.4.7 Mounting of the profile seal for universal process mounting adapter**

For details on mounting, see KA00096F/00/A3.

### **4.5 Post-installation check**

After installing the device, carry out the following checks:

- Are all screws firmly tightened?
- Are the housing covers screwed down tight?

## 5 Wiring

### 5.1 Connecting the device

#### ⚠ WARNING

##### Risk of electric shock!

If the operating voltage is > 35 VDC: Dangerous contact voltage at terminals.

- ▶ In a wet environment, do not open the cover if voltage is present.

#### ⚠ WARNING

##### Limitation of electrical safety due to incorrect connection!

- Risk of electric shock and/or explosion in hazardous areas! In a wet environment, do not open the cover if voltage is present.
- When using the measuring device in hazardous areas, installation must comply with the corresponding national standards and regulations and the Safety Instructions or Installation or Control Drawings.
- Devices with integrated overvoltage protection must be earthed.
- Protective circuits against reverse polarity, HF influences and overvoltage peaks are installed.
- The supply voltage must match the supply voltage on the nameplate. (→ 10, Section 3.2.1 "Nameplate")
- Switch off the supply voltage before connecting the device.
- Remove housing cover of the terminal compartment.
- Guide cable through the gland. Preferably use twisted, screened two-wire cable.
- Connect device in accordance with the following diagram.
- Screw down housing cover.
- Switch on supply voltage.

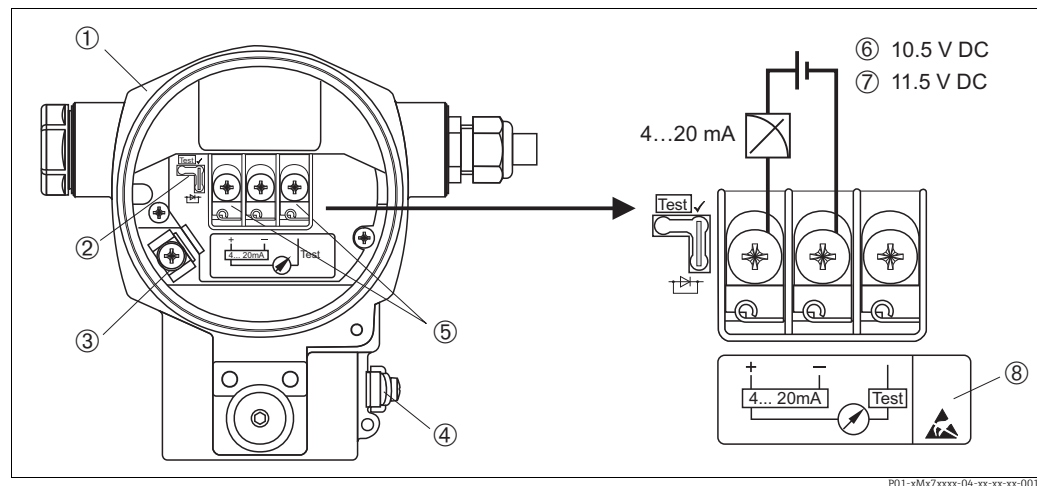

Fig. 9: Electrical connection 4 to 20 mA HART  
→ Observe also Section 5.2.1 "Supply voltage", → 22.

- 1 Housing
- 2 Jumper for 4 to 20 mA test signal.  
→ 22, Section 5.2.1 "Taking 4 to 20 mA test signal" part.
- 3 Internal earth terminal
- 4 External earth terminal
- 5 4 to 20 mA test signal between plus and test terminal
- 6 Minimum supply voltage = 10.5 V DC, jumper is inserted in accordance with the illustration.
- 7 Minimum supply voltage = 11.5 V DC, jumper is inserted in "Test" position.
- 8 Devices with integrated overvoltage protection are labelled OVP (overvoltage protection) here.

### 5.1.1 Connecting devices with Harting plug Han7D

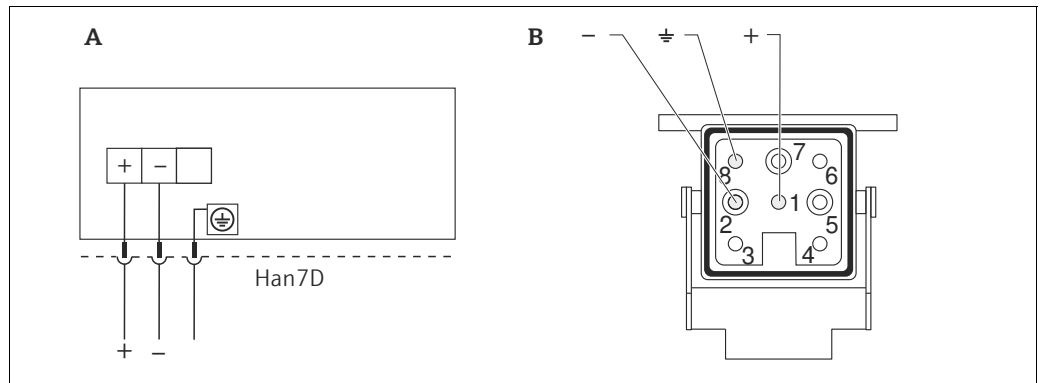

Fig. 10:

- A Electrical connection for devices with Harting plug Han7D
- B View of the plug connector at the device

### 5.1.2 Connecting devices with an M12 connector

PIN assignment for M12 connector	PIN	Meaning
	1	Signal +
	2	Not assigned
	3	Signal -
	4	Earth

### 5.1.3 Connecting the cable version

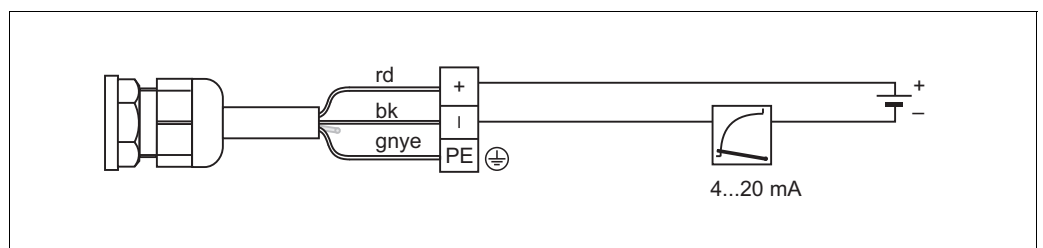

Fig. 11: rd = red, bk = black, gnye = green-yellow

## 5.2 Connecting the measuring unit

### 5.2.1 Supply voltage

#### ⚠ WARNING

#### Supply voltage might be connected!



Risk of electric shock and/or explosion!

- ▶ When using the measuring device in hazardous areas, installation must comply with the corresponding national standards and regulations and the Safety Instructions or Installation or Control Drawings.
- ▶ All explosion protection data are given in separate documentation which is available upon request. The Ex documentation is supplied as standard with all devices approved for use in explosion hazardous areas.

Electronic version	Jumper for 4 to 20 mA test signal in "Test" position (Delivery status)	Jumper for 4 to 20 mA test signal in "Non-Test" position
4 to 20 mA HART, for non-hazardous areas	11.5 to 45 V DC	10.5 to 45 V DC

#### Taking 4 to 20 mA test signal

A 4 to 20 mA signal may be measured via the positive and test terminal without interrupting the measurement. The minimum supply voltage of the device can be reduced by simply changing the position of the jumper. As a result, operation is also possible with lower voltage sources. To keep the measured error below 0.1%, the current measuring device should display an internal resistance of  $< 0.7 \Omega$ . Observe the position of the jumper in accordance with the following table.

Jumper position for test signal	Description
	<ul style="list-style-type: none"> <li>- Taking 4 to 20 mA test signal via plus and test terminal: possible. (Thus, the output current can be measured without interruption via the diode.)</li> <li>- Delivery status</li> <li>- minimum supply voltage: 11.5 V DC</li> </ul>
	<ul style="list-style-type: none"> <li>- Taking 4 to 20 mA test signal via plus and test terminal: not possible.</li> <li>- minimum supply voltage: 10.5 V DC</li> </ul>

### 5.2.2 Terminals

- Supply voltage and internal ground terminal: 0.5 to 2.5 mm<sup>2</sup> (20 to 14 AWG)
- External ground terminal: 0.5 to 4 mm<sup>2</sup> (20 to 12 AWG)

### 5.2.3 Cable specification

- Endress+Hauser recommends using twisted, screened two-wire cables.
- Cable external diameter: 5 to 9 mm (0.2 to 0.35 in)

### 5.2.4 Load

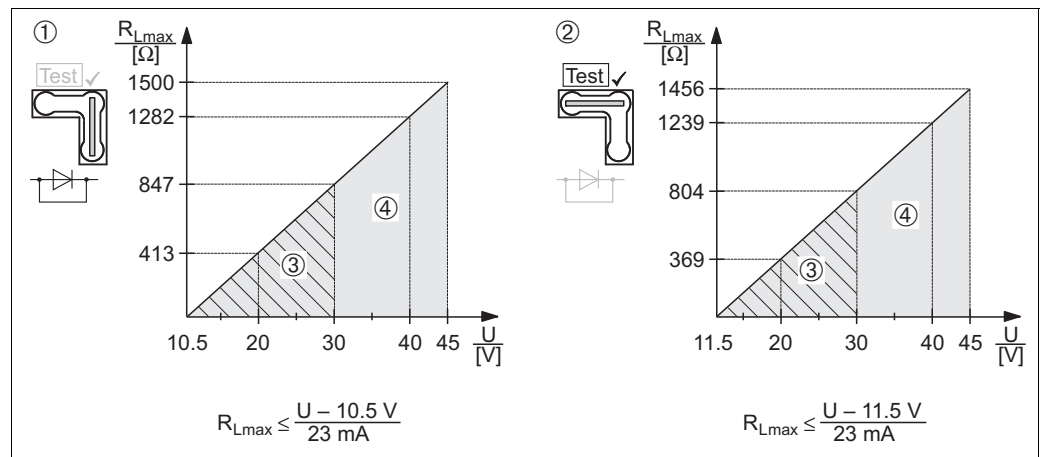

Fig. 12: Load diagram, observe the position of the jumper and the explosion protection. (→ § 22, Section 5.2.1 "Taking 4 to 20 mA test signal" part.)

- 1 Jumper for the 4 to 20 mA test signal inserted in "Non-Test" position
  - 2 Jumper for the 4 to 20 mA test signal inserted in "Test" position
  - 3 Supply voltage 10.5 (11.5) to 30 V DC for Ex ia, 1/2 D, 1 GD, 1/2 GD, FM IS and CSA IS, IEC Ex ia, NEPSI Ex ia
  - 4 Supply voltage 10.5 (11.5) to 45 V DC for devices for non-hazardous areas, 1/3 D, Ex nA, FM DIP, FM NI
- $R_{Lmax}$  Maximum load resistance  
 $U$  Supply voltage



When operating via a handheld terminal or via PC with an operating program, a minimum communication resistance of 250 Ω must exist within the loop.

### 5.2.5 Screening/potential matching

- You achieve optimum screening against disturbances if the screening is connected on both sides (in the cabinet and on the device). If you have to reckon with potential equalisation currents in the plant, only earth screening on one side, preferably at the transmitter (possibility of hydrogen diffusion).
- When using in hazardous areas, you must observe the applicable regulations. Separate Ex documentation with additional technical data and instructions is included with all Ex systems as standard.

### 5.2.6 Connecting Field Xpert SFX100

Compact, flexible and robust industry handheld terminal for remote parametrization and measured value inspection via the HART current output (4-20mA).

For details refer to Operating Instructions BA00060S/04/EN.

### 5.2.7 Connecting Commubox FXA195

The Commubox FXA195 connects intrinsically safe transmitters with the HART protocol to a computer's USB port. This allows remote operation of the transmitter using Endress+Hauser's FieldCare operating program. Power is supplied to the Commubox through the USB port. The Commubox is also suitable for connection to intrinsically safe circuits. → See Technical Information TI00404F for further information.

## 5.2.8 Connecting Commubox FXA291/ToF Adapter FXA291 for operation via FieldCare

### Connecting Commubox FXA291

The Commubox FXA291 connects Endress+Hauser field instruments with CDI interface (= Endress+Hauser Common Data Interface) to the USB interface of a personal computer or a notebook. For details refer to TI00405C/07/en.

For the following Endress+Hauser instruments you need the "ToF Adapter FXA291" as an additional accessory:

- Cerabar S PMC71, PMP7x
- Deltabar S PMD7x, FMD7x
- Deltapilot S FMB70

### Connecting ToF Adapter FXA291

The ToF Adapter FXA291 connects the Commubox FXA291 via the USB interface of a personal computer or a notebook to the following Endress+Hauser instruments:

- Cerabar S PMC71, PMP7x
- Deltabar S PMD7x, FMD7x
- Deltapilot S FMB70

For details refer to KA00271F/00/a2.

## 5.3 Potential matching

Ex applications: Connect all devices to the local potential matching.  
Observe the applicable regulations.

## 5.4 Overvoltage protection (optional)

### NOTICE

#### Device could be destroyed!

Devices with integrated overvoltage protection must be earthed.

Devices showing version "M" in feature 100 "Additional options 1" or feature 110 "Additional options 2" in the order code are equipped with overvoltage protection (see also Technical Information TI00416P "Ordering information").

- Overvoltage protection:
  - Nominal functioning DC voltage: 600 V
  - Nominal discharge current: 10 kA
- Surge current check  $\hat{i} = 20$  kA as per DIN EN 60079-14: 8/20  $\mu$ s satisfied
- Arrester AC current check  $I = 10$  A satisfied

## 5.5 Post-connection check

Perform the following checks after completing electrical installation of the device:

- Does the supply voltage match the specifications on the nameplate?
- Is the device connected as per Section 5.1?
- Are all screws firmly tightened?
- Are the housing covers screwed down tight?

As soon as voltage is applied to the device, the green LED on the electronic insert lights up for a few seconds or the connected on-site display lights up.



## 6 Operation

Feature 20 "Output; operation" in the order code provides you with information on the operating options available to you.

### 6.1 On-site display (optional)

A 4-line liquid crystal display (LCD) is used for display and operation. The on-site display shows measured values, dialog texts, fault messages and notice messages.

The display of the device can be turned in 90° steps.

Depending on the installation position of the device, this makes it easy to operate the device and read the measured values.

Functions:

- 8-digit measured value display including sign and decimal point, bargraph for current display
- simple and complete menu guidance thanks to separation of the parameters into several levels and groups
- each parameter is given a 3-digit ID number for easy navigation
- option for configuring the display according to individual requirements and desires, such as language, alternating display, contrast setting, display of other measured values such as sensor temperature
- comprehensive diagnostic functions (fault and warning message, peak-hold indicators, etc.)
- rapid and safe commissioning with the Quick Setup menus

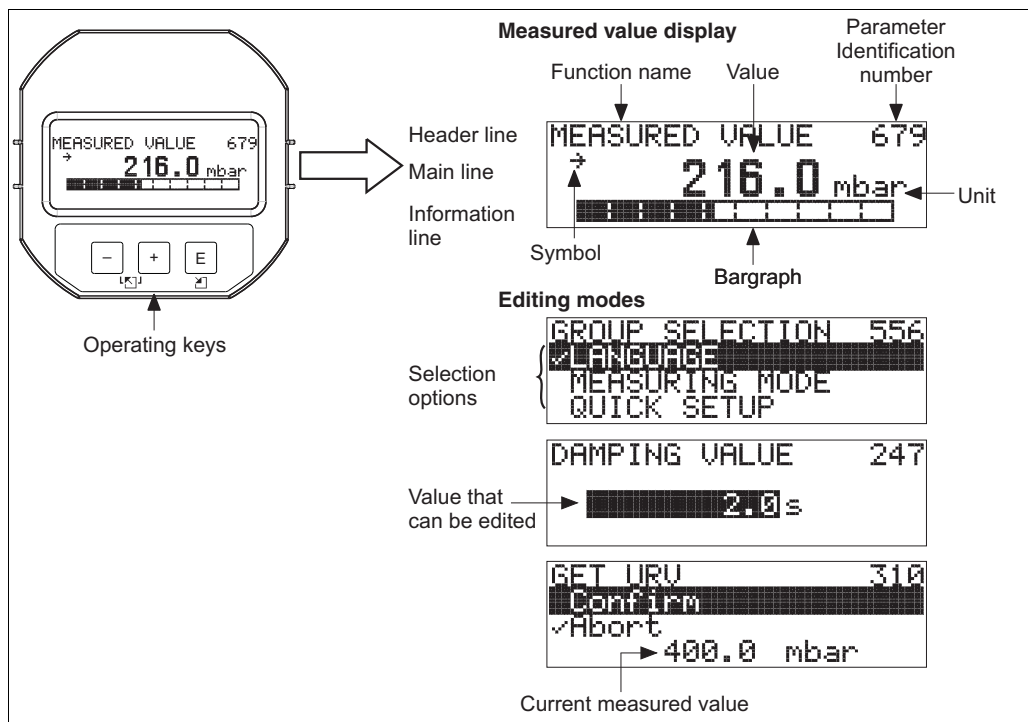

P01-xMx7xxxx-07-xx-xx-xx-001

The following table illustrates the symbols that can appear on the on-site display. Four symbols can occur at one time.

Symbol	Meaning
	<b>Alarm symbol</b> – Symbol flashing: warning, device continues measuring. – Symbol permanently lit: error, device does not continue measuring. <i>Note:</i> The alarm symbol may overlie the tendency symbol.
	<b>Lock symbol</b> The operation of the device is locked. Unlock device, → 36.
	<b>Communication symbol</b> Data transfer via communication <i>Note:</i> The alarm symbol may overlie the communication symbol.
	<b>Tendency symbol (increasing)</b> The measured value is increasing.
	<b>Tendency symbol (decreasing)</b> The measured value is decreasing.
	<b>Tendency symbol (constant)</b> The measured value has remained constant over the past few minutes.

## 6.2 Operating elements

### 6.2.1 Position of operating elements

With regard to aluminium housings (T14/T15), the operating keys are located either outside the device under the protection cap or inside on the electronic insert. In hygienic stainless steel housings (T17), the operating keys are always located inside on the electronic insert.

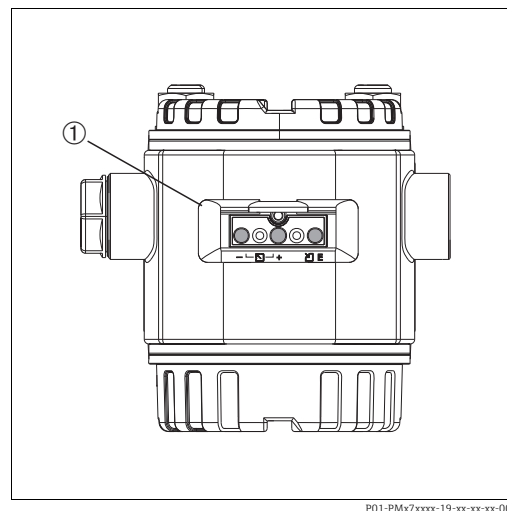

P01-PMx7xxxx-19-xx-xx-xx-009

Fig. 13: Operating keys, external

- 1 Operating keys on the exterior of the device under the protective flap

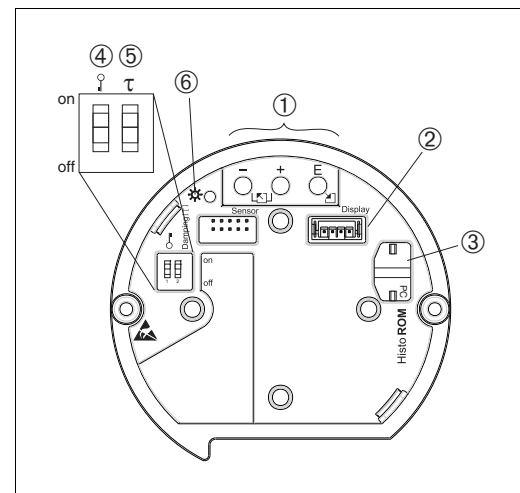











P01-xxxxxxx-19-xx-xx-xx-104

Fig. 14: Operating keys, internal







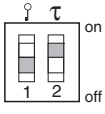

- 1 Operating keys  
 2 Slot for optional display  
 3 Slot for optional HistoROM®/M-DAT  
 4 DIP-switch for locking/unlocking measured-value-relevant parameters  
 5 DIP-switch for damping on/off  
 6 Green LED to indicate value being accepted

## 6.2.2 Function of the operating elements – on-site display not connected

Press and hold the key or the key combination for at least 3 seconds to execute the corresponding function. Press the key combination for at least 6 seconds for a reset.

Operating key(s)	Meaning
	Adopt lower range value. A reference pressure is present at the device. → 28, Section 6.3.1 "Level measuring mode" or → 30, Section 6.3.2 "Level measuring mode".
	Adopt upper range value. A reference pressure is present at the device. → 28, Section 6.3.1 "Level measuring mode" or → 30, Section 6.3.2 "Level measuring mode".
	Position adjustment
 and  and 	Reset all parameters. The reset via operating keys corresponds to the software reset code 7864.
 and 	Copy the configuration data from the optional HistoROM®/M-DAT module to the device.
 and 	Copy the configuration data from the device to the optional HistoROM®/M-DAT module.
 <small>P01-xxxxxxx-19-xx-xx-xx-057</small>	<ul style="list-style-type: none"> <li>- DIP-switch 1: for locking/unlocking measured-value-relevant parameters Factory setting: off (unlocked)</li> <li>- DIP-switch 2: damping on/off, Factory setting: on (damping on)</li> </ul>

## 6.2.3 Function of the operating elements – on-site display connected

Operating key(s)	Meaning
	<ul style="list-style-type: none"> <li>- Navigate upwards in the picklist</li> <li>- Edit the numerical values and characters within a function</li> </ul>
	<ul style="list-style-type: none"> <li>- Navigate downwards in the picklist</li> <li>- Edit the numerical values and characters within a function</li> </ul>
	<ul style="list-style-type: none"> <li>- Confirm entry</li> <li>- Jump to the next item</li> </ul>
 and 	Contrast setting of on-site display: darker
 and 	Contrast setting of on-site display: brighter
 and 	<p>ESC functions:</p> <ul style="list-style-type: none"> <li>- Exit edit mode without saving the changed value.</li> <li>- You are in a menu within a function group. The first time you press the keys simultaneously, you go back a parameter within the function group. Each time you press the keys simultaneously after that, you go up a level in the menu.</li> <li>- You are in a menu at a selection level. Each time you press the keys simultaneously, you go up a level in the menu.</li> </ul> <p><i>Note:</i> The terms function group, level and selection level are explained in → 31, Section 6.4.1.</p>

## 6.3 On-site operation – on-site display not connected

To operate the device with a HistoROM®/M-DAT module → 33, Section 6.5 "HistoROM®/M-DAT (optional)".

### 6.3.1 Level measuring mode

If no on-site display is connected, the following functions are possible by means of the three keys on the electronic insert or on the exterior of the device:

- Position adjustment (zero point correction)
- Assign the lower and upper pressure value to the lower and upper level value
- Device reset, → 27, Section 6.2.2 "Function of the operating elements – on-site display not connected", Table.
- The "-" and ⊕- keys only have a function in the following cases:
  - LEVEL SELECTION "Level Easy Pressure", CALIBRATION MODE "Wet"
  - LEVEL SELECTION "Level Standard", LEVEL MODE "Linear", CALIBRATION MODE "Wet"

The keys have no function in other settings.

- The device is configured for the Level measuring mode as standard. You can switch measuring modes by means of the MEASURING MODE parameter. → 39, Section 7.3 "Selecting language and measuring mode".

The following parameters are set to the following values in the factory:

- LEVEL SELECTION: Level Easy Pressure
- CALIBRATION MODE: Wet
- OUTPUT UNIT or LIN. MEASURAND: %
- EMPTY CALIB.: 0.0
- FULL CALIB.: 100.0.
- SET LRV: 0.0 (corresponds to 4 mA value)
- SET URV: 100.0 (corresponds to 20 mA value)

These parameters can only be modified by means of the on-site display or remote operation such as the FieldCare.

- The operation must be unlocked. → 36, Section 6.8 "Locking/unlocking operation".
- The pressure applied must be within the nominal pressure limits of the sensor. See information on the nameplate.
- → 42, Section 7.5 "Section 7.5". For parameter description see Operating Instructions BA00274P.
- LEVEL SELECTION, CALIBRATION MODE, LEVEL MODE, EMPTY CALIB., FULL CALIB, SET LRV and SET URV are parameter names used for on-site display or remote operation such as FieldCare, for instance.

#### **▲ WARNING**

**Changing the measuring mode can affect the adjustment data!**

This situation can result in product overflow.

- ▶ Check calibration data when the measuring mode is changed.

Carry out position adjustment. <sup>1)</sup>		Setting lower pressure value.		Setting upper pressure value.	
Pressure is present at device.		Desired pressure for lower pressure value (EMPTY PRESSURE <sup>2)</sup> ) is present at device.		Desired pressure for upper pressure value (FULL PRESSURE <sup>1)</sup> ) is present at device.	
↓		↓		↓	
Press -key for 3 s.		Press -key for 3 s.		Press -key for 3 s.	
↓		↓		↓	
Does the LED on the electronic insert light up briefly?		Does the LED on the electronic insert light up briefly?		Does the LED on the electronic insert light up briefly?	
Yes	No	Yes	No	Yes	No
↓	↓	↓	↓	↓	↓
Applied pressure for position adjustment has been accepted.	Applied pressure for position adjustment has not been accepted. Observe the input limits.	The pressure present was saved as the lower pressure value (EMPTY PRESSURE <sup>2)</sup> ) and assigned to the lower level value (EMPTY CALIB. <sup>2)</sup> .	The pressure present was not saved as the lower pressure value. Observe the input limits.	The pressure present was saved as the upper pressure value (FULL PRESSURE <sup>2)</sup> ) and assigned to the upper level value (FULL CALIB. <sup>2)</sup> .	The pressure present was not saved as the upper pressure value. Observe the input limits.

- 1) Observe "Warning" on → 39, Section 7 "Commissioning".
- 2) Parameter name used for the on-site display or remote operation such as the FieldCare.

### 6.3.2 Pressure measuring mode

If no on-site display is connected, the following functions are possible by means of the three keys on the electronic insert or on the exterior of the device:



- Position adjustment (zero point correction)
- Setting lower range value and upper range value
- Device reset, → 27, Section 6.2.2 "Function of the operating elements – on-site display not connected", Table.
  
- The operation must be unlocked. → 36, Section 6.8 "Locking/unlocking operation".
- The device is configured for the Level measuring mode as standard. You can switch measuring modes by means of the MEASURING MODE parameter. → 39, Section 7.3 "Selecting language and measuring mode".
- The pressure applied must be within the nominal pressure limits of the sensor. See information on the nameplate.

**⚠ WARNING**

**Changing the measuring mode can affect the adjustment data!**

This situation can result in product overflow.

- ▶ Check calibration data when the measuring mode is changed.

Carry out position adjustment. <sup>1)</sup>		Setting lower range value.		Setting upper range value.	
Pressure is present at device.		Desired pressure for lower range value is present at device.		Desired pressure for upper range value is present at device.	
↓		↓		↓	
Press  -key for 3 s.		Press  -key for 3 s.		Press  -key for 3 s.	
↓		↓		↓	
Does the LED on the electronic insert light up briefly?		Does the LED on the electronic insert light up briefly?		Does the LED on the electronic insert light up briefly?	
Yes	No	Yes	No	Yes	No
↓	↓	↓	↓	↓	↓
Applied pressure for position adjustment has been accepted.	Applied pressure for position adjustment has not been accepted. Observe the input limits.	Applied pressure for lower range value has been accepted.	Applied pressure for lower range value has not been accepted. Observe the input limits.	Applied pressure for upper range value has been accepted.	Applied pressure for upper range value has not been accepted. Observe the input limits.

1) Observe "Warning" on → 39, Section 7 "Commissioning".

## 6.4 On-site operation – on-site display connected

If the on-site display is connected, the three operating keys are used to navigate through the operating menu and parameter input, →  27, Section 6.2.3 "Function of the operating elements – on-site display connected".

### 6.4.1 General structure of the operating menu





The menu is split into four levels. The three upper levels are used to navigate while you use the bottom level to enter numerical values, select options and save settings.

The entire operating menu is shown in the operating instructions BA00274P "Cerabar S/Deltabar S/Deltapilot S, Description of Instrument Functions".

The structure of the OPERATING MENU depends on the measuring mode selected, e.g. if the "Pressure" measuring mode is selected, only the functions necessary for this mode are displayed.

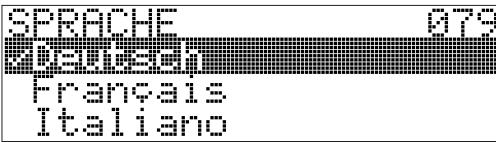
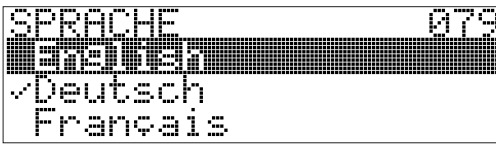
### 6.4.2 Selecting an option

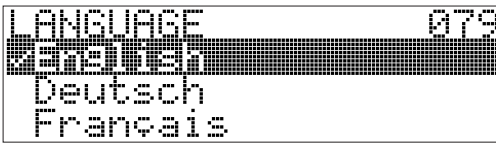
Example: select "English" as the language of the menu.

On-site display	Operation
 <p>SPRACHE 079                  Deutsch                  Français                  Italiano</p> <p><small>P01-xxxxxxx-19-xx-xx-xx-017</small></p>	<p>German is selected as the language. A ✓ in front of the menu text indicates the active option.</p>
 <p>SPRACHE 079                  English                  ✓Deutsch                  Français</p> <p><small>P01-xxxxxxx-19-xx-xx-xx-033</small></p>	<p>Select English with  or .</p>
 <p>LANGUAGE 079                  English                  Deutsch                  Français</p> <p><small>P01-xxxxxxx-19-xx-xx-xx-034</small></p>	<ol style="list-style-type: none"> <li>1. Confirm your choice with . A ✓ in front of the menu text indicates the active option. (English is now selected as the menu language.)</li> <li>2. Jump to the next item with .</li> </ol>

### 6.4.3 Editing a value

Example: adjusting DAMPING VALUE function from 2.0 s to 30.0 s. → 27, Section 6.2.3 "Function of the operating elements – on-site display connected".

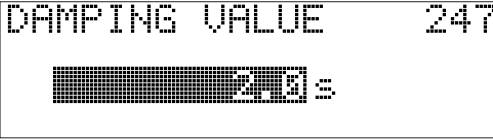
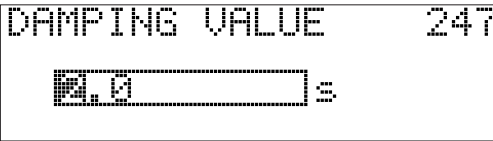
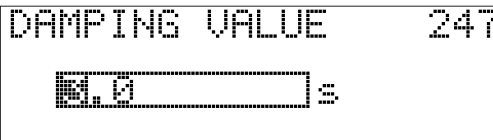
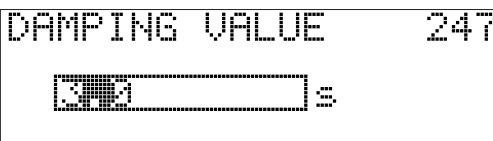
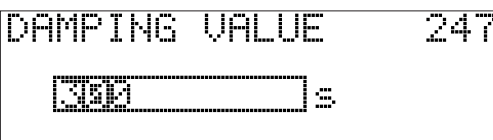
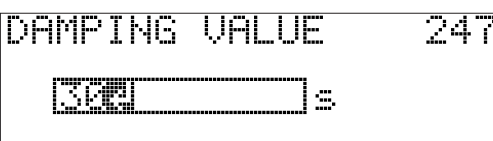
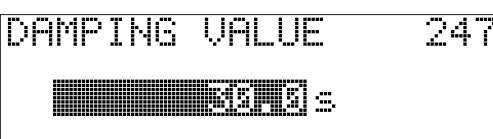
On-site display	Operation
 <p style="text-align: right; font-size: small;">P01-xxxxxxx-19-xx-xx-xx-023</p>	<p>The on-site display shows the parameter to be changed. The value highlighted in black can be changed. The "s" unit is fixed and cannot be changed.</p>
 <p style="text-align: right; font-size: small;">P01-xxxxxxx-19-xx-xx-xx-027</p>	<ol style="list-style-type: none"> <li>1. Press <math>\leftarrow</math> or <math>\rightarrow</math> to get to the editing mode.</li> <li>2. The first digit is highlighted in black.</li> </ol>
 <p style="text-align: right; font-size: small;">P01-xxxxxxx-19-xx-xx-xx-028</p>	<ol style="list-style-type: none"> <li>1. Use <math>\rightarrow</math> to change "2" to "3".</li> <li>2. Confirm "3" with <math>\rightarrow</math>. The cursor jumps to the next position (highlighted in black).</li> </ol>
 <p style="text-align: right; font-size: small;">P01-xxxxxxx-19-xx-xx-xx-029</p>	<p>The decimal point is highlighted in black, i.e. you can now edit it.</p>
 <p style="text-align: right; font-size: small;">P01-xxxxxxx-19-xx-xx-xx-030</p>	<ol style="list-style-type: none"> <li>1. Keep pressing <math>\leftarrow</math> or <math>\rightarrow</math> until "0" is displayed.</li> <li>2. Confirm "0" with <math>\rightarrow</math>. The cursor jumps to the next position. <math>\downarrow</math> is displayed and is highlighted in black. → See next graphic.</li> </ol>
 <p style="text-align: right; font-size: small;">P01-xxxxxxx-19-xx-xx-xx-031</p>	<p>Use <math>\rightarrow</math> to save the new value and exit the editing mode. → See next graphic.</p>
 <p style="text-align: right; font-size: small;">P01-xxxxxxx-19-xx-xx-xx-032</p>	<p>The new value for the damping is now 30.0 s.</p> <ul style="list-style-type: none"> <li>- Jump to the next parameter with <math>\rightarrow</math>.</li> <li>- You can get back to the editing mode with <math>\leftarrow</math> or <math>\rightarrow</math>.</li> </ul>



### 6.4.4 Taking pressure applied at device as value

Example: configuring upper range value – assign 20 mA to the pressure value 400 mbar.

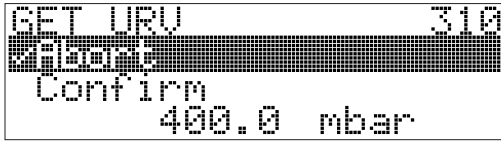
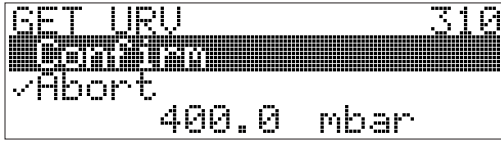
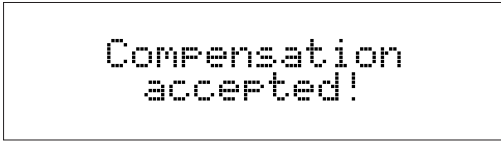
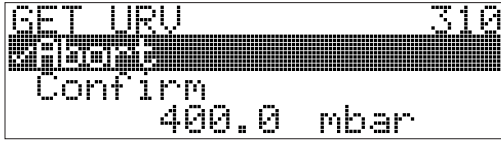
On-site display	Operation
 <p>P01-xxxxxxxx-19-xx-xx-xx-035</p>	The bottom line on the on-site display displays the pressure present, here 400 mbar.
 <p>P01-xxxxxxxx-19-xx-xx-xx-036</p>	Use <input type="checkbox"/> or <input type="checkbox"/> to switch to the "Confirm" option. The active selection is highlighted in black.
 <p>P01-xxxxxxxx-19-xx-xx-xx-037</p>	Use <input type="checkbox"/> to assign the value (400 mbar) to the GET URV parameter. The device confirms the calibration and jumps back to the parameter, here GET URV (see next graphic).
 <p>P01-xxxxxxxx-19-xx-xx-xx-035</p>	Switch to the next parameter with <input type="checkbox"/> .

## 6.5 HistoROM<sup>®</sup>/M-DAT (optional)

### NOTICE

#### Device could be destroyed!

Detach HistoROM<sup>®</sup>/M-DAT from the electronic insert or attach it to the insert in a deenergised state only.

HistoROM<sup>®</sup>/M-DAT is a memory module, which is attached to the electronic insert and fulfils the following functions:

- Back-up copy of configuration data
- Copying configuration data of a transmitter into another transmitter
- Cyclic recording of pressure and sensor-temperature measured values
- Recording diverse events, such as alarms, configuration changes, counters for measuring range undershooting and exceeding for pressure and temperature, exceeding and undershooting the user limits for pressure and temperature, etc.
- The HistoROM<sup>®</sup>/M-DAT module may be retrofitted at any time (Order No.: 52027785).
- The HistoROM data and the data in the device are analysed once a HistoROM<sup>®</sup>/M-DAT is attached to the electronic insert and power is reestablished to the device. During the analysis, the messages "W702, HistoROM data not consistent" and "W706, Configuration in HistoROM and device not identical" can occur. For measures, →  48, Section 9.1 "Messages".

### 6.5.1 Copying configuration data

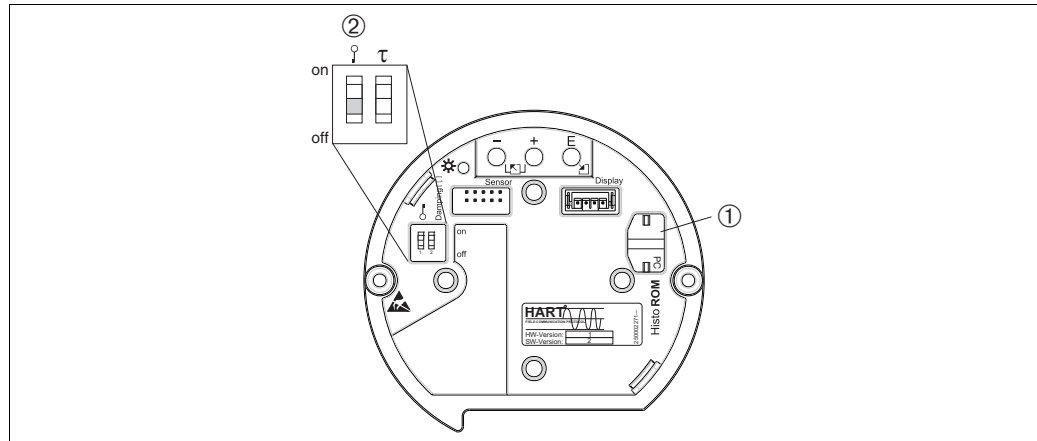

P01-xxxxxxx-19-xx-xx-xx-099

Abb. 15: Electronic insert with optional HistoROM®/M-DAT memory module

- 1 Optional HistoROM®/M-DAT
- 2 To copy configuration data from the HistoROM®/M-DAT module to a device or from a device to a HistoROM®/M-DAT, the operation must be unlocked (DIP-switch 1, Position "off", parameter INSERT PIN NO. = 100). Observe → 36, Section 6.8 "Locking/unlocking operation".

#### On-site operation – on-site display not connected

##### Copying configuration data from a device to a HistoROM®/M-DAT module:

The operation must be unlocked.

1. Disconnect device from supply voltage.
2. Attach the HistoROM®/M-DAT module to the electronic insert.
3. Reestablish supply voltage to the device.
4. Press  $\square$  and "-"-keys (for at least 3 seconds) until the LED on the electronic insert lights up.
5. Wait approx. 20 seconds. Configuration data are loaded from the device to the HistoROM®/M-DAT. The device is not restarted.
6. Before removing the HistoROM®/M-DAT again from the electronic insert, disconnect the device from supply voltage.

##### Copying configuration data from a HistoROM®/M-DAT to a device:

The operation must be unlocked.

1. Disconnect device from supply voltage.
2. Attach the HistoROM®/M-DAT module to the electronic insert. Configuration data from another device are stored in the HistoROM®/M-DAT.
3. Reestablish supply voltage to the device.
4. Press  $\square$  und "+"-keys (for at least 3 seconds) until the LED on the electronic insert lights up.
5. Wait approx. 20 seconds. All parameters except DEVICE SERIAL No, DEVICE DESIGN., CUST. TAG NUMBER, LONG TAG NUMBER, DESCRIPTION, BUS ADDRESS, CURRENT MODE and the parameters in the POSITION ADJUSTMENT and PROCESS CONNECTION group are loaded into the device by HistoROM®/M-DAT. The device is restarted.
6. Before removing the HistoROM®/M-DAT again from the electronic insert, disconnect the device from supply voltage.

**On-site operation via on-site display (optional) or remote operation****Copying configuration data from a device to a HistoROM®/M-DAT:**

The operation must be unlocked.

1. Disconnect device from supply voltage.
2. Attach the HistoROM®/M-DAT module to the electronic insert.
3. Reestablish supply voltage to the device.
4. Using the HistoROM CONTROL parameter select the option "Device → HistoROM" as the data transfer direction (Menu path: GROUPSELECTION → OPERATING MENU → OPERATION).  
The DOWNLOAD SELECT. parameter setting has no influence on an upload from the device into HistoROM.
5. Wait approx. 20 seconds. Configuration data are loaded from the device to the HistoROM®/M-DAT. The device is not restarted.
6. Before removing the HistoROM®/M-DAT again from the electronic insert, disconnect the device from supply voltage.

**Copying configuration data from a HistoROM®/M-DAT to a device:**

The operation must be unlocked.

1. Disconnect device from supply voltage.
2. Attach the HistoROM®/M-DAT module to the electronic insert. Configuration data from another device are stored in the HistoROM®/M-DAT.
3. Reestablish supply voltage to the device.
4. Use the DOWNLOAD SELECT parameter to select which parameters are to be overwritten (Menu path: (GROUPS SELECTION →) OPERATING MENU → OPERATION).

The following parameters are overwritten according to the selection:

– **Configuration copy (factory setting):**

all parameters except DEVICE SERIAL No., DEVICE DESIGN, CUST. TAG NUMBER, LONG TAG NUMBER, DESCRIPTION, BUS ADDRESS, CURRENT MODE and the parameters in the POSITION ADJUSTMENT, PROCESS CONNECTION, CURR. TRIM (SERVICE /SYSTEM 2), SENSOR TRIM and SENSOR DATA group.

– **Device replacement:**

all parameters except DEVICE SERIAL No., DEVICE DESIGN and the parameters in the POSITION ADJUSTMENT, PROCESS CONNECTION, CURR. TRIM (SERVICE/SYSTEM 2), SENSOR TRIM and SENSOR DATA group.

– **Electronics replace:**

all parameters except the parameters in the CURR. TRIM (SERVICE/SYSTEM 2) and SENSOR DATA group.

Factory setting: Configuration copy

5. Using the HistoROM CONTROL parameter select the option "HistoROM → Device" as the data transfer direction.  
(Menu path: GROUP SELECTION → OPERATING MENU → OPERATION)
6. Wait approx. 20 seconds. Configuration data are loaded from the device to the HistoROM®/M-DAT. The device is restarted.
7. Before removing the HistoROM®/M-DAT again from the electronic insert, disconnect the device from supply voltage.

## 6.6 Operation via SFX100

Compact, flexible and robust industry handheld terminal for remote parametrization and measured value inspection via the HART current output (4-20mA).  
For details refer to Operating Instructions BA00060S/04/EN.



## 6.7 Endress+Hauser operating program

FieldCare is an Endress+Hauser asset management tool based on FDT technology. With FieldCare, you can configure all Endress+Hauser devices as well as devices from other manufacturers that support the FDT standard. Hardware and software requirements you can find on the internet: [www.endress.com](http://www.endress.com) → select your country → Search: FieldCare → FieldCare → Technical Data.

FieldCare supports the following functions:

- Configuration of transmitters in online operation
- Loading and saving device data (upload/download)
- HistoROM<sup>®</sup>/M-DAT analysis
- Documentation of the measuring point

Connection options:

- HART via Commubox FXA195 and USB interface of a computer
- HART via Fieldgate FXA520
- →  23, Section 5.2.7, "Connecting Commubox FXA195".
- In the "Level Standard" measuring mode, the configuration data that were loaded with FDT upload cannot be written again (FDT download). These data are only used to document the measuring point.
- →  24, Section 5.2.8, "Connecting Commubox FXA291/ToF Adapter FXA291 for operation via FieldCare".
- Further information on the FieldCare can be found on the Internet (<http://www.endress.com>, Download → Search for: FieldCare).

## 6.8 Locking/unlocking operation

Once you have entered all the parameters, you can lock your entries against unauthorised and undesired access.

You have the following possibilities for locking/unlocking the operation:

- Via a DIP-switch on the electronic insert, locally on the display.
- Via the on-site display (optional)
- Via digital communication.

The -symbol on the on-site display indicates that operation is locked. Parameters which refer to how the display appears, e.g. LANGUAGE and DISPLAY CONTRAST can still be altered.



If operation is locked by means of the DIP-switch, you can only unlock operation again by means of the DIP-switch. If operation is locked by means of the on-site display or remote operation e.g. FieldCare, you can only unlock operation again by means of the on-site display or remote operation.

The table provides an overview of the locking functions:

Locking via	View/read parameter	Modify/write via <sup>1)</sup>		Unlocking via		
		On-site display	Remote operation	DIP-switch	On-site display	Remote operation
DIP-switch	Yes	No	No	Yes	No	No
On-site display	Yes	No	No	No	Yes	Yes
Remote operation	Yes	No	No	No	Yes	Yes

1) Parameters which refer to how the display appears, e.g. LANGUAGE and DISPLAY CONTRAST can still be altered.

### 6.8.1 Locking/unlocking operation locally via DIP-switch

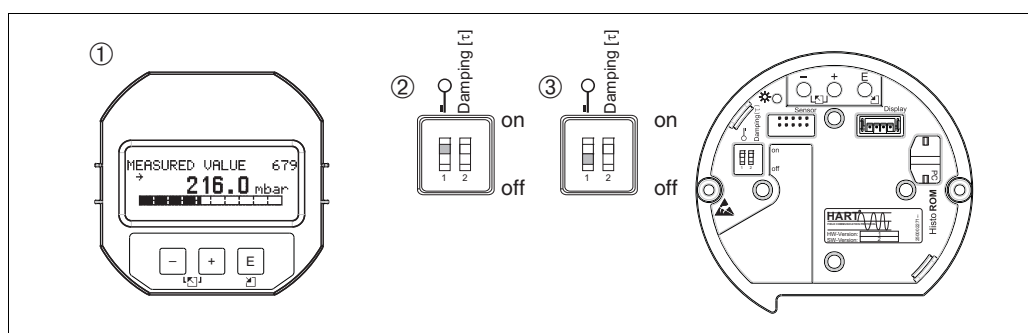

Fig. 16: DIP-switch position "Hardware locking" on the electronic insert

- 1 If necessary, remove on-site display (optional)
- 2 DIP-switch is at "on": operation is locked.
- 3 DIP-switch is at "off": operation is unlocked (operation possible)

### 6.8.2 Locking/unlocking operation via on-site display or remote operation

	Description
Locking operation	<ol style="list-style-type: none"> <li>1. Select INSERT PIN NO. parameter, Menu path: OPERATING MENU → OPERATION → INSERT PIN NO.</li> <li>2. To lock operation, enter a number for this parameter between 0 to 9999 that is ≠100.</li> </ol>
Unlocking operation	<ol style="list-style-type: none"> <li>1. Select INSERT PIN NO. parameter.</li> <li>2. To unlock operation, enter "100" for the parameter.</li> </ol>

## 6.9 Factory setting (reset)

By entering a certain code, you can completely, or partially, reset the entries for the parameters to the factory settings. (→ For factory settings refer to the Operating Instructions BA00274P "Cerabar S/Deltabar S/Deltapilot S, Description of device functions".) Enter the code by means of the ENTER RESET CODE parameter (Menu path: (GROUP SELECTION →) OPERATING MENU → OPERATING).

There are various reset codes for the device. The following table illustrates which parameters are reset by the particular reset codes. Operation must be unlocked to reset parameters (→ 37, Section 6.9).

Any customer-specific configuration carried out by the factory is not affected by a reset (customer-specific configuration remains). If, after a reset, you wish the parameters to be reset to the factory settings, please contact Endress+Hauser Service.

Reset code	Description and effect
1846	<p><b>Display reset</b></p> <ul style="list-style-type: none"> <li>- This reset resets all parameters which have to do with how the display appears (DISPLAY group).</li> <li>- Any simulation which may be running is ended.</li> <li>- The device is restarted.</li> </ul>
62	<p><b>PowerUp reset (warm start)</b></p> <ul style="list-style-type: none"> <li>- This reset resets all the parameters in the RAM. Data are read back anew from the EEPROM (processor is initialised again).</li> <li>- Any simulation which may be running is ended.</li> <li>- The device is restarted.</li> </ul>
2710	<p><b>Measuring mode level reset</b></p> <ul style="list-style-type: none"> <li>- Depending on the settings for the LEVEL MODE, LIN MEASURAND, LINdMEASURAND or COMB. MEASURAND parameters, the parameters needed for this measuring task will be reset.</li> <li>- Any simulation which may be running is ended.</li> <li>- The device is restarted.</li> </ul> <p>Example LEVEL MODE = linear and LIN. MEASURAND = Height</p> <ul style="list-style-type: none"> <li>■ HEIGHT UNIT = m</li> <li>■ CALIBRATION MODE = wet</li> <li>■ EMPTY CALIB. = 0</li> <li>■ FULL CALIB. = Sensor end value converted to mH<sub>2</sub>O, e.g. 4.079 mH<sub>2</sub>O for a 400 mbar (6 psi) sensor</li> </ul>
333	<p><b>User reset</b></p> <ul style="list-style-type: none"> <li>- Affects the following parameters: <ul style="list-style-type: none"> <li>- Function group POSITION ADJUSTMENT</li> <li>- Function group BASIC SETUP, except for the customer-specific units</li> <li>- Function group EXTENDED SETUP</li> <li>- Group OUTPUT</li> <li>- Function group HART DATA: CURRENT MODE, BUS ADDRESS and PREAMBLE NUMBER</li> </ul> </li> <li>- Any simulation which may be running is ended.</li> <li>- The device is restarted.</li> </ul>
7864	<p><b>Total reset</b></p> <ul style="list-style-type: none"> <li>- Affects the following parameters: <ul style="list-style-type: none"> <li>- Function group POSITION ADJUSTMENT</li> <li>- Function group BASIC SETUP</li> <li>- Function group EXTENDED SETUP</li> <li>- Function group LINEARISATION (an existing linearisation table is erased)</li> <li>- Group OUTPUT</li> <li>- Function group PEAK HOLD INDICATOR</li> <li>- Function group HART DATA</li> <li>- All configurable messages ("Error" type) are set to factory setting. See also → 48, Section 9.1 "Messages" and → 56, Section 9.2 "Response of outputs to errors".</li> <li>- Function group USER LIMITS</li> <li>- Function group SYSTEM 2</li> </ul> </li> <li>- Any simulation which may be running is ended.</li> <li>- The device is restarted.</li> </ul>
8888	<p><b>HistoROM reset</b></p> <p>The measured value memory and event memory are cleared. During the reset, the HistoROM must be attached to the electronic insert.</p>

## 7 Commissioning

The device is configured for the level measuring mode as standard. The measuring range and the unit in which the measured value is transmitted correspond to the specifications on the nameplate.

### **▲ WARNING**

#### **Exceeding the maximum allowable working pressure!**

Risk of injury due to bursting of parts! Warning messages are generated if pressure is too high.

- ▶ If a pressure greater than the maximum permitted pressure is present at the device, the messages "E115 Sensor overpressure" and "E727 Sensor pressure error - overrange" are output in succession! Use the device only within the sensor range limits

### **NOTICE**

#### **Shortfall of the allowable working pressure!**

Output of messages if pressure is too low.

- ▶ If a pressure smaller than the minimum permitted pressure is present at the device, the messages "E120 Sensor low pressure" and "E727 Sensor pressure error - overrange" are output in succession! Use the device only within the sensor range limits

### 7.1 Configuring messages

- Messages E727, E115 and E120 are "Error"-type messages and can be configured as a "Warning" or an "Alarm". These messages are configured as "Warning" messages at the factory. This setting prevents the current output from assuming the set alarm current value for applications (e.g. cascade measurement) where the user is consciously aware of the fact that the sensor range can be exceeded
- We recommend setting messages E727, E115 and E120 to "Alarm" in the following instances:
  - The sensor range does not have to be exceeded for the measuring application.
  - Position adjustment has to be carried out that has to correct a large measured error as a result of the orientation of the device (e.g. devices with a diaphragm seal).

### 7.2 Function check

Carry out a post-installation and a post-connection check as per the checklist before commissioning the device.

- "Post-installation check" checklist → see Section 4.5
- "Post-connection check" checklist → see Section 5.5

### 7.3 Selecting language and measuring mode

#### 7.3.1 On-site operation

The LANGUAGE and MEASURING MODE parameters are located on the top menu level.

The following measuring modes are available:

- Pressure
- Level

### 7.3.2 Digital communication

The following measuring modes are available:

- Pressure
- Level

The LANGUAGE parameter is arranged in the DISPLAY group (OPERATING MENU → DISPLAY).

- Use the LANGUAGE parameter to select the menu language for the on-site display.
- Select the menu language for ToF Tool via the "Options" menu → "Options" → "Display" → "Language".
- Select the menu language for FieldCare by means of the "Language Button" in the configuration window. Select the menu language for the FieldCare frame via the "Extra" menu → "Options" → "Display" → "Language".

### 7.4 Position adjustment

Due to the orientation of the device, there may be a shift in the measured value, i.e. when the container is empty, the measured value parameter does not display zero. There are three options to choose from when performing position adjustment.

(Menu path: (GROUP SELECTION →) OPERATING MENU → SETTINGS → POSITION ADJUSTMENT)

Parameter name	Description
POS. ZERO ADJUST (685) Entry	<p>Position adjustment – the pressure difference between zero (set point) and the measured pressure need not be known.</p> <p><b>Example:</b></p> <ul style="list-style-type: none"> <li>– MEASURED VALUE = 2.2 mbar (0.032 psi)</li> <li>– Correct the MEASURED VALUE via the POS. ZERO ADJUST parameter with the "Confirm" option. This means that you are assigning the value 0.0 to the pressure present.</li> <li>– MEASURED VALUE (after pos. zero adjust) = 0.0 mbar</li> <li>– The current value is also corrected.</li> </ul> <p>The CALIB. OFFSET parameter displays the resulting pressure difference (offset) by which the MEASURED VALUE was corrected.</p> <p><b>Factory setting:</b> 0.0</p>
POS. INPUT VALUE (563) Entry	<p>Position adjustment – the pressure difference between zero (set point) and the measured pressure need not be known. To correct the pressure difference, you need a reference measurement value (e. g. from a reference device).</p> <p><b>Example:</b></p> <ul style="list-style-type: none"> <li>– MEASURED VALUE = 0.5 mbar (0.0073 psi)</li> <li>– For the POS. INPUT VALUE parameter, specify the desired set point for the MEASURED VALUE, e.g. 2.0 mbar (0.029 psi). (<math>\text{MEASURED VALUE}_{\text{new}} = \text{POS. INPUT VALUE}</math>)</li> <li>– MEASURED VALUE (after entry for POS. INPUT VALUE) = 2.0 mbar (0.029 psi)</li> <li>– The CALIB. OFFSET parameter displays the resulting pressure difference (offset) by which the MEASURED VALUE was corrected. <math>\text{CALIB. OFFSET} = \text{MEASURED VALUE}_{\text{old}} - \text{POS. INPUT VALUE}</math>, here: <math>\text{CALIB. OFFSET} = 0.5 \text{ mbar (0.0073 psi)} - 2.0 \text{ mbar (0.029 psi)} = -1.5 \text{ mbar (0.022 psi)}</math></li> <li>– The current value is also corrected.</li> </ul> <p><b>Factory setting:</b> 0.0</p>



Parameter name	Description
CALIB. OFFSET (319) Entry	<p>Position adjustment – the pressure difference between zero (set point) and the measured pressure is known.</p> <p><b>Example:</b></p> <ul style="list-style-type: none"><li>- MEASURED VALUE = 2.2 mbar (0.032 psi)</li><li>- Via the CALIB. OFFSET parameter, enter the value by which the MEASURED VALUE should be corrected. To correct the MEASURED VALUE to 0.0 mbar, you must enter the value 2.2 here. (<math>\text{MEASURED VALUE}_{\text{new}} = \text{MEASURED VALUE}_{\text{old}} - \text{CALIB. OFFSET}</math>)</li><li>- MEASURED VALUE (after entry for calib. offset) = 0.0 mbar</li><li>- The current value is also corrected.</li></ul> <p><b>Factory setting:</b> 0.0</p>

## 7.5 Level measurement

### 7.5.1 Information on level measurement

- The Pressure and Level operating modes each have a quick setup menu which guides you through the most important basic functions. See →  44 for the "Level" quick setup menu.
- Furthermore, the three level modes "Level Easy Pressure", "Level Easy Height" and "Level Standard" are available to you for level measurement. You can select from the "Linear", "Pressure linearized" and "Height linearized" level types for the "Level Standard" level mode. The table in the "Overview of level measurement" section below provides an overview of the various measuring tasks.
  - In the "Level Easy Pressure" and "Level Easy Height" level modes, the values entered are not tested as extensively as in the "Level Standard" level mode. The values entered for EMPTY CALIB./FULL CALIB., EMPTY PRESSURE/FULL PRESSURE, EMPTY HEIGHT/FULL HEIGHT and SET LRV/SET URV must have a minimum interval of 1% for the "Level Easy Pressure" and "Level Easy Height" level modes. The value will be rejected with a warning message if the values are too close together. Further limit values are not checked; i.e. the values entered must be appropriate for the sensor and the measuring task so that the measuring device can measure correctly.
  - The "Level Easy Pressure" and "Level Easy Height" level modes encompass fewer parameters than the "Level Standard" mode and are used for quick and easy configuration of a level application.
  - Customer-specific units of fill level, volume and mass or a linearization table may only be entered in the "Level Standard" level mode.
  - Where the device is intended for use as a subsystem in a safety function (SIL), a "Device configuration with enhanced parameter security" (SAFETY CONFIRM.) is only possible for the "Level" operating mode in the "Level Easy Pressure" level mode. All parameters previously entered are checked after a password is entered. Once the "Level Easy Height" or "Level Standard" has been selected, the configuration will first have to be reset to the ex-works setting using the RESET parameter (menu path: (GROUP SELECTION →) OPERATING MENU → OPERATION) using the reset code "7864". → For further information see the Deltapilot S (SD00213P) Functional Safety Manual.
- See the Operating Instructions BA00274P "Cerabar S/Deltabar S/Deltapilot S, Description of device functions".

#### **WARNING**

#### **Changing the measuring mode can affect the adjustment data!**

This situation can result in product overflow.

- ▶ Check calibration data when the measuring mode is changed.

## 7.5.2 Overview of level measurement

Measuring task	LEVEL SELECTION/ LEVEL MODE	Measured variable options	Description	Comment	Measured value display
The measured variable is in direct proportion to the measured pressure. Calibration is performed by entering two pressure-level value pairs.	LEVEL SELECTION: Level Easy Pressure	Via OUTPUT UNIT parameter: %, level, volume or mass units.	<ul style="list-style-type: none"> <li>- Calibration with reference pressure – wet calibration, see Operating Instructions BA00274P.</li> <li>- Calibration without reference pressure – dry calibration, see Operating Instructions BA00274P.</li> </ul>	<ul style="list-style-type: none"> <li>- Incorrect entries are possible</li> <li>- SIL mode possible</li> <li>- Customised units are not possible</li> </ul>	The measured value display and the LEVEL BEFORE LIN parameter show the measured value.
The measured variable is in direct proportion to the measured pressure. Calibration is performed by entering the density and two height-level value pairs.	LEVEL SELECTION: Level Easy Height	Via OUTPUT UNIT parameter: %, level, volume or mass units.	<ul style="list-style-type: none"> <li>- Calibration with reference pressure – wet calibration, see Operating Instructions BA00274P.</li> <li>- Calibration without reference pressure – dry calibration, see Operating Instructions BA00274P.</li> </ul>	<ul style="list-style-type: none"> <li>- Incorrect entries are possible</li> <li>- SIL mode not possible</li> <li>- Customised units are not possible</li> </ul>	The measured value display and the LEVEL BEFORE LIN parameter show the measured value.
The measured variable is in direct proportion to the measured pressure.	LEVEL SELECTION: Level standard/ LEVEL MODE: Linear	Via LIN. MEASURAND parameter: <ul style="list-style-type: none"> <li>- % (level)</li> <li>- Level</li> <li>- Volume</li> <li>- Mass</li> </ul>	<ul style="list-style-type: none"> <li>- Calibration with reference pressure – wet calibration, see Operating Instructions BA00274P.</li> <li>- Calibration without reference pressure – dry calibration, see Operating Instructions BA00274P.</li> </ul>	<ul style="list-style-type: none"> <li>- Incorrect entries are rejected by the device</li> <li>- SIL mode not possible</li> <li>- Customised level, volume and mass units are possible</li> </ul>	The measured value display and the LEVEL BEFORE LIN parameter show the measured value.
The measured variable is not in direct proportion to the measured pressure as, for example, with containers with a conical outlet. A linearisation table must be entered for the calibration.	LEVEL SELECTION: Level standard/ LEVEL MODE: Pressure linearized	Via LIND MEASURAND parameter: <ul style="list-style-type: none"> <li>- Pressure + %</li> <li>- Pressure + volume</li> <li>- Pressure + mass</li> </ul>	<ul style="list-style-type: none"> <li>- Calibration with reference pressure: semiautomatic entry of linearisation table, see Operating Instructions BA00274P.</li> <li>- Calibration without reference pressure: manual entry of linearisation table, see Operating Instructions BA00274P.</li> </ul>	<ul style="list-style-type: none"> <li>- Incorrect entries are rejected by the device</li> <li>- SIL mode not possible</li> <li>- Customised level, volume and mass units are possible</li> </ul>	The measured value display and the TANK CONTENT parameter show the measured value.
<ul style="list-style-type: none"> <li>- Two measured variables are required or</li> <li>- The container shape is given by value pairs, such as height and volume.</li> </ul> <p>The 1st measured variable %-height or height must be in direct proportion to the measured pressure. The 2nd measured variable volume, mass or % must not be in direct proportion to the measured pressure. A linearisation table must be entered for the 2nd measured variable. The 2nd measured variable is assigned to the 1st measured variable by means of this table.</p>	LEVEL SELECTION: Level standard/ LEVEL MODE: Height linearized	Via COMB. MEASURAND parameter: <ul style="list-style-type: none"> <li>- Height + volume</li> <li>- Height + mass</li> <li>- Height + %</li> <li>- %-Height + volume</li> <li>- %-Height + mass</li> <li>- %-Height + %</li> </ul>	<ul style="list-style-type: none"> <li>- Calibration with reference pressure: wet calibration and semiautomatic entry of linearisation table, see Operating Instructions BA00274P.</li> <li>- Calibration without reference pressure: dry calibration and manual entry of linearisation table, see Operating Instructions BA00274P.</li> </ul>	<ul style="list-style-type: none"> <li>- Incorrect entries are rejected by the device</li> <li>- SIL mode not possible</li> <li>- Customised level, volume and mass units are possible</li> </ul>	<p>The measured value display and the TANK CONTENT parameter show the 2nd measured value (volume, mass or %).</p> <p>The LEVEL BEFORE LIN parameter displays the 1st measured value (%-height or height).</p>

### 7.5.3 Quick Setup menu for Level measuring mode



- Some parameters are only displayed if other parameters are appropriately configured. For example, the EMPTY CALIB. parameter is only displayed in the following cases:
  - LEVEL SELECTION "Level Easy Pressure" and CALIBRATION MODE "Wet"
  - LEVEL SELECTION "Level Standard", LEVEL MODE "Linear" and CALIBRATION MODE "WET"
 You can find the LEVEL MODE parameter in the BASIC SETTINGS function group (menu path: (GROUP SELECTION →) OPERATING MENU → SETTINGS → BASIC SETTINGS).
- The following parameters are set to the following values in the factory:
  - LEVEL SELECTION: Level Easy Pressure
  - CALIBRATION MODE: Wet
  - OUTPUT UNIT or LIN. MEASURAND: %
  - EMPTY CALIB.: 0.0
  - FULL CALIB.: 100.0
  - SET LRV (BASIC SETTINGS group): 0.0 (corresponds to 4 mA value)
  - SET URV (BASIC SETTINGS group): 100.0 (corresponds to 20 mA value).
- The quick setup is suitable for simple and quick commissioning. If you wish to make more complex settings, e.g. change the unit from "%" to "m", you will have to calibrate using the BASIC SETTINGS group. → See Operating Instructions BA00274P.

#### **⚠ WARNING**



#### **Changing the measuring mode can affect the adjustment data!**

This situation can result in product overflow.

- ▶ Check calibration data when the measuring mode is changed.

On-site operation	Digital communication
<b>Measured value display</b> On-site display: Switch from the measured value display to GROUP SELECTION with  .	See BA00274P.
<b>GROUP SELECTION</b> Select MEASURING MODE.	
<b>MEASURING MODE</b> Select "Level" option.	
<b>LEVEL SELECTION</b> Select level mode. For an overview see →  43.	
<b>GROUP SELECTION</b> Select QUICK SETUP menu.	
<b>POS. ZERO ADJUST</b> Due to orientation of the device, there may be a shift in the measured value. You correct the MEASURED VALUE via the POS. ZERO ADJUST parameter with the "Confirm" option, i. e. you assign the value 0.0 to the pressure present.	
<b>EMPTY CALIB.</b> <sup>1)</sup> (produce appropriate level) Enter level for the lower calibration point. For this parameter, enter a level value which is assigned to the pressure present at the device.	
<b>FULL CALIB.</b> <sup>1)</sup> (produce appropriate level) Enter level for the upper calibration point. For this parameter, enter a level value which is assigned to the pressure present at the device.	
<b>DAMPING TIME</b> Enter damping time (time constant $\tau$ ). The damping affects the speed at which all subsequent elements, such as the on-site display, measured value and current output react to a change in the pressure.	

- 1)    – LEVEL SELECTION "Level Easy Pressure" and CALIBRATION MODE "Wet"  
       – LEVEL SELECTION "Level Standard", LEVEL MODE "Linear" and CALIBRATION MODE "Wet"

For on-site operation, see also →  27, Section 6.2.3 "Function of the operating elements – on-site display connected" and →  31, Section 6.4 ff "Operating elements".

## 7.6 Pressure measurement

### 7.6.1 Information on pressure measurement

- There is a Quick Setup menu for each of the measuring modes Pressure and Level which guides you through the most important basic functions. With the setting in the MEASURING MODE parameter, you specify which Quick Setup menu should be displayed. → [39](#), Section 7.3 "Selecting language and measuring mode".
- For a detailed description of the parameters see the Operating Instructions BA00274P "Cerabar S/Deltabar S/Deltapilot S, Description of device functions"
  - Table 6, POSITION ADJUSTMENT
  - Table 7, BASIC SETUP
  - Table 15, EXTENDED SETUP
- For pressure measurement, select the "Pressure" option by means of the MEASURING MODE parameter. The operating menu is structured appropriately.

#### **⚠ WARNING**

#### **Changing the measuring mode can affect the adjustment data!**

This situation can result in product overflow.

- ▶ Check calibration data when the measuring mode is changed.

### 7.6.2 Quick Setup menu for Pressure measuring mode

On-site operation	Digital communication
<b>Measured value display</b> On-site display: Switch from the measured value display to GROUP SELECTION with <a href="#">☐</a> .	See BA00274P.
<b>GROUP SELECTION</b> Select MEASURING MODE.	
<b>MEASURING MODE</b> Select "Pressure" option.	
<b>GROUP SELECTION</b> Select QUICK SETUP menu.	
<b>POS. ZERO ADJUST</b> Due to orientation of the device, there may be a shift in the measured value. You correct the MEASURED VALUE via the POS. ZERO ADJUST parameter with the "Confirm" option, i. e. you assign the value 0.0 to the pressure present.	
<b>SET LRV</b> Set the measuring range (enter 4 mA value). Specify a pressure value for the lower current value (4 mA value). A reference pressure does not have to be present at the device.	
<b>SET URV</b> Set the measuring range (enter 20 mA value). Specify a pressure value for the upper current value (20 mA value). A reference pressure does not have to be present at the device.	
<b>DAMPING TIME</b> Enter damping time (time constant $\tau$ ). The damping affects the speed at which all subsequent elements, such as the on-site display, measured value and current output react to a change in the pressure.	

For on-site operation, → [27](#), Section 6.2.3 "Function of the operating elements – on-site display connected" and → [31](#), Section 6.4 ff "Operating elements".

## 8 Maintenance

Keep the pressure compensation and GORE-TEX® filter (1) free from contaminations.

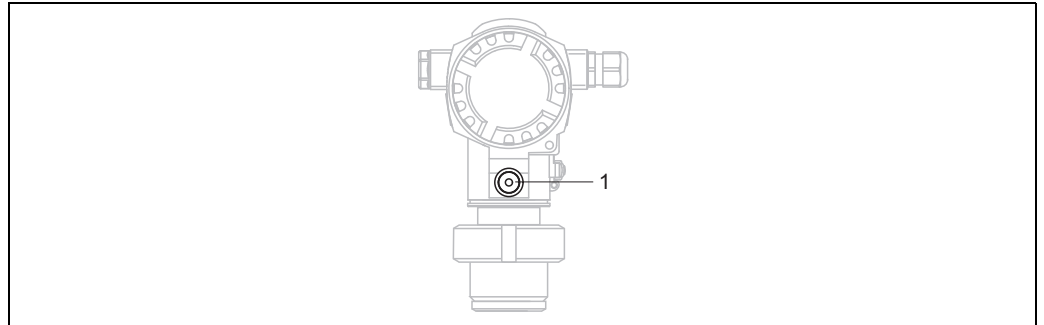

P01-FMB70xxx-17-xx-xx-xx-003

### 8.1 Exterior cleaning

Please note the following points when cleaning the device:

- The cleaning agents used should not attack the surface and the seals.
- Mechanical damage to the process isolating diaphragm, e.g. due to pointed objects, must be avoided.
- Observe degree of protection. See therefore nameplate if necessary (→  10).

## 9 Trouble-shooting

### 9.1 Messages

The following table lists all the possible messages that can occur.



The device differentiates between the error types "Alarm", "Warning" and "Error". You may specify whether the instrument should react as if for an "Alarm" or "Warning" for "Error" messages.

→ See "Error type/NA 64" column and Section 9.2 "Response of outputs to errors".

In addition, the "Error type/NA 64" column classifies the messages in accordance with NAMUR Recommendation NA 64:

- Break down: indicated with "B"
- Maintenance need: indicated with "C" (check request)
- Function check: indicated with "T" (in service)

Error message display on the on-site display:

- The measured value display shows the message with the highest priority. → See "Priority" column.
- The ALARM STATUS parameter shows all the messages present in descending order of priority. You can scroll through all the messages present with the  key or  key.

Message display via the digital communication:

- The ALARM STATUS parameter shows the message with the highest priority. → See "Priority" column.



- If the device detects a defect in the on-site display during initialization, special error messages are generated. → For the error messages, →  55, Section 9.1.1 "On-site display error messages".
- For support and further information, please contact Endress+Hauser Service.
- → See also Section 9.4 ff.

Code	Error type/ NA 64	Corresponds NE 107	Message/description	Cause	Measure	Priority
101 (A101)	Alarm B	Failure (F)	B>Sensor electronic EEPROM error	<ul style="list-style-type: none"> <li>- Electromagnetic effects are greater than specifications in the technical data. (→ See Section 10.) This message normally only appears briefly.</li> <li>- Sensor defect.</li> </ul>	<ul style="list-style-type: none"> <li>- Wait a few minutes.</li> <li>- Restart the device. Perform reset (Code 62).</li> <li>- Block off electromagnetic effects or eliminate source of disturbance.</li> <li>- Replace sensor.</li> </ul>	17
102 (W102)	Warning C	Maintenance request (M)	C>Checksum error in EEPROM: peakhold segment	<ul style="list-style-type: none"> <li>- Main electronics defect. Correct measurement can continue as long as you do not need the peak hold indicator function.</li> </ul>	<ul style="list-style-type: none"> <li>- Replace main electronics.</li> </ul>	53
106 (W106)	Warning C	Funktion check (C)	C>Downloading - please wait	<ul style="list-style-type: none"> <li>- Downloading.</li> </ul>	<ul style="list-style-type: none"> <li>- Wait for download to complete.</li> </ul>	52
110 (A110)	Alarm B	Failure (F)	B>Checksum error in EEPROM: configuration segment	<ul style="list-style-type: none"> <li>- The supply voltage is disconnected when writing.</li> <li>- Electromagnetic effects are greater than specifications in the technical data. (→ See Section 10.)</li> <li>- Main electronics defect.</li> </ul>	<ul style="list-style-type: none"> <li>- Reestablish supply voltage. Perform reset (Code 7864) if necessary. Carry out calibration again.</li> <li>- Block off electromagnetic effects or eliminate sources of disturbance.</li> <li>- Replace main electronics.</li> </ul>	6



Code	Error type/ NA 64	Corresponds NE 107	Message/description	Cause	Measure	Priority
113 (A113)	Alarm B	Failure (F)	B>ROM failure in transmitter electronic	– Main electronics defect.	– Replace main electronics.	1
115 (E115)	Error B factory setting: Warning C	Out of specification (S)	B>Sensor overpressure	– Overpressure present.  – Sensor defect.	– Reduce pressure until message disappears.  – Replace sensor.	29
116 (W116)	Warning C	Maintenance request (M)	C>Download error, repeat download	– The file is defect.  – During the download, the data are not correctly transmitted to the processor, e.g. because of open cable connections, spikes (ripple) on the supply voltage or electromagnetic effects.	– Use another file.  – Check cable connection PC – transmitter. – Block off electromagnetic effects or eliminate sources of disturbance. – Perform reset (Code 7864) and carry out calibration again. – Repeat download.	36
120 (E120)	Error B factory setting: Warning C	Out of specification (S)	B>Sensor low pressure	– Pressure too low.  – Sensor defect.	– Increase pressure until message disappears.  – Replace sensor.	30
121 (A121)	Alarm B	Failure (F)	B>Checksum error in factory segment of EEPROM	– Main electronics defect.	– Replace main electronics.	5
122 (A122)	Alarm B	Failure (F)	B>Sensor not connected	– Cable connection sensor –main electronics disconnected.  – Electromagnetic effects are greater than specifications in the technical data. (→ See Section 10.)  – Main electronics defect.  – Sensor defect.	– Check cable connection and repair if necessary.  – Block off electromagnetic effects or eliminate source of disturbance.  – Replace main electronics.  – Replace sensor.	13
130 (A130)	Alarm B	Failure (F)	B>EEPROM is defect.	– Main electronics defect.	– Replace main electronics.	10
131 (A131)	Alarm B	Failure (F)	B>Checksum error in EEPROM: min/max segment	– Main electronics defect.	– Replace main electronics.	9
132 (A132)	Alarm B	Failure (F)	B>Checksum error in totalizer EEPROM	– Main electronics defect.	– Replace main electronics.	7
133 (A133)	Alarm B	Failure (F)	B>Checksum error in History EEPROM	– An error occurred when writing.  – Main electronics defect.	– Perform reset (Code 7864) and carry out calibration again.  – Replace electronics.	8
602 (W602)	Warning C	Funktion check (C)	C>Linearisation curve not monoton	– The linearisation table is not monotonic increasing or decreasing.	– Add to linearisation table or perform linearisation again.	57

Code	Error type/ NA 64	Corresponds NE 107	Message/description	Cause	Measure	Priority
604 (W604)	Warning C	Funktion check (C)	C>Linearisation table not valid. Less than 2 points or points too close	<ul style="list-style-type: none"> <li>- The linearisation table consists of less than 2 points.</li> <li>- At least 2 points in the linearisation table are too close together. A minimum gap of 0.5 % of the distance between two points must be maintained. Spans for the "Pressure linearized" option: HYDR. PRESS MAX. - HYDR. PRESS MIN.; TANK CONTENT MAX. - TANK CONTENT MIN. Spans for the "Height linearized" option: LEVEL MAX - LEVEL MIN; TANK CONTENT MAX. - TANK CONTENT MIN.</li> </ul>	<ul style="list-style-type: none"> <li>- Add to linearisation table. If necessary, perform linearisation again.</li> <li>- Correct linearisation table and accept again.</li> </ul>	58
613 (W613)	Warning I	Funktion check (C)	I>Simulation is active	<ul style="list-style-type: none"> <li>- Simulation is switched on, i.e. the device is not measuring at present.</li> </ul>	<ul style="list-style-type: none"> <li>- Switch off simulation.</li> </ul>	60
620 (E620)	Error C Factory setting: Warning C	Out of specification (S)	C>Current output out of range	<ul style="list-style-type: none"> <li>The current is outside the permitted range 3.8 to 20.5 mA.</li> <li>- The pressure applied is outside the set measuring range (but within the sensor range).</li> <li>- Loose connection at sensor cable</li> </ul>	<ul style="list-style-type: none"> <li>- Check pressure applied, reconfigure measuring range if necessary (→ See also Operating Instructions BA00274P)</li> <li>- Perform reset (Code 7864) and carry out calibration again.</li> <li>- Wait a short period of time and tighten the connection, or avoid loose connection.</li> </ul>	49
700 (W700)	Warning C	Maintenance request (M)	C>Last configuration not stored	<ul style="list-style-type: none"> <li>- An error occurred when writing or reading configuration data or the power supply was disconnected.</li> <li>- Main electronics defect.</li> </ul>	<ul style="list-style-type: none"> <li>- Perform reset (Code 7864) and carry out calibration again.</li> <li>- Replace main electronics.</li> </ul>	54
701 (W701)	Warning C	Funktion check (C)	C>Measuring chain config. exceeds sensor range	<ul style="list-style-type: none"> <li>- The calibration carried out would result in the sensor nominal operating range being undershot or overshot.</li> </ul>	<ul style="list-style-type: none"> <li>- Carry out calibration again.</li> </ul>	50
702 (W702)	Warning C	Maintenance request (M)	C>HistoROM data not consistent.	<ul style="list-style-type: none"> <li>- Data were not written correctly to the HistoROM, e.g. if the HistoROM was detached during the writing process.</li> <li>- HistoROM does not have any data.</li> </ul>	<ul style="list-style-type: none"> <li>- Repeat upload.</li> <li>- Perform reset (Code 7864) and carry out calibration again.</li> <li>- Copy suitable data to the HistoROM. (→ See also → 34, Section 6.5.1 "Copying configuration data".)</li> </ul>	55
703 (A703)	Alarm B	Failure (F)	B>Measurement error	<ul style="list-style-type: none"> <li>- Fault in the main electronics.</li> <li>- Main electronics defect.</li> </ul>	<ul style="list-style-type: none"> <li>- Briefly disconnect device from the power supply.</li> <li>- Replace main electronics.</li> </ul>	22
704 (A704)	Alarm B	Funktion check (C)	B>Measurement error	<ul style="list-style-type: none"> <li>- Fault in the main electronics.</li> <li>- Main electronics defect.</li> </ul>	<ul style="list-style-type: none"> <li>- Briefly disconnect device from the power supply.</li> <li>- Replace main electronics.</li> </ul>	12
705 (A705)	Alarm B	Failure (F)	B>Measurement error	<ul style="list-style-type: none"> <li>- Fault in the main electronics.</li> <li>- Main electronics defect.</li> </ul>	<ul style="list-style-type: none"> <li>- Briefly disconnect device from the power supply.</li> <li>- Replace main electronics.</li> </ul>	21

Code	Error type/ NA 64	Corresponds NE 107	Message/description	Cause	Measure	Pri ority
706 (W706)	Warning C	Maintenance request (M)	C>Configuration in HistoROM and device not identical	<ul style="list-style-type: none"> <li>– Configuration (parameters) in the HistoROM and in the device is not identical.</li> </ul>	<ul style="list-style-type: none"> <li>– Copy data from the device to the HistoROM. (See also → 34, Section 6.5.1 "Copying configuration data".)</li> <li>– Copy data from the HistoROM to the device. (See also → 34, Section 6.5.1 "Copying configuration data".) The message remains if the HistoROM and the device have different software versions. The message goes out if you copy the data from the device to the HistoROM.</li> <li>– Device reset codes such as 7864 do not have any effect on the HistoROM. That means that if you do a reset, the configurations in the HistoROM and in the device may not be the same.</li> </ul>	59
707 (A707)	Alarm B	Funktion check (C)	B>X-VAL. of lin. table out of edit limits.	<ul style="list-style-type: none"> <li>– At least one X-VALUE in the linearisation table is either below the value for HYDR. PRESS. MIN. or MIN. LEVEL or above the value for HYDR. PRESS. MAX. or LEVEL MAX.</li> </ul>	<ul style="list-style-type: none"> <li>– Carry out calibration again. (→ See also Operating Instructions BA00274P)</li> </ul>	38
710 (W710)	Warning C	Funktion check (C)	B>Set span too small. Not allowed.	<ul style="list-style-type: none"> <li>– Values for calibration (e.g. lower range value and upper range value) are too close together.</li> <li>– The sensor was replaced and the customer-specific configuration does not suit the sensor.</li> <li>– Unsuitable download carried out.</li> </ul>	<ul style="list-style-type: none"> <li>– Adjust calibration to suit sensor. (→ See also Operating Instructions BA00274P, parameter description MINIMUM SPAN)</li> <li>– Adjust calibration to suit sensor.</li> <li>– Replace sensor with a suitable sensor.</li> <li>– Check configuration and perform download again.</li> </ul>	51
711 (A711)	Alarm B	Funktion check (C)	B>LRV or URV out of edit limits	<ul style="list-style-type: none"> <li>– Lower range value and/or upper range value undershoot or overshoot the sensor range limits.</li> <li>– The sensor was replaced and the customer-specific configuration does not suit the sensor.</li> <li>– Unsuitable download carried out.</li> </ul>	<ul style="list-style-type: none"> <li>– Reconfigure lower range value and/or upper range value to suit the sensor. Pay attention to position factor.</li> <li>– Reconfigure lower range value and/or upper range value to suit the sensor. Pay attention to position factor.</li> <li>– Replace sensor with a suitable sensor.</li> <li>– Check configuration and perform download again.</li> </ul>	37
713 (A713)	Alarm B	Funktion check (C)	B>100% POINT level out of edit limits	<ul style="list-style-type: none"> <li>– The sensor was replaced.</li> </ul>	<ul style="list-style-type: none"> <li>– Carry out calibration again.</li> </ul>	39

Code	Error type/ NA 64	Corresponds NE 107	Message/description	Cause	Measure	Prio rity
715 (E715)	Error C Factory setting: Warning C	Out of specification (S)	C>Sensor over temperature	<ul style="list-style-type: none"> <li>- The temperature measured in the sensor is greater than the upper nominal temperature of the sensor. (→ See also Operating Instructions BA00274P, parameter description Tmax SENSOR)</li> <li>- Unsuitable download carried out.</li> </ul>	<ul style="list-style-type: none"> <li>- Reduce process temperature/ ambient temperature.</li> <li>- Check configuration and perform download again.</li> </ul>	32
716 (E716)	Error B Factory setting: Alarm B	Failure (F)	B>Process isolating diaphragm broken	<ul style="list-style-type: none"> <li>- Sensor defect.</li> </ul>	<ul style="list-style-type: none"> <li>- Replace sensor.</li> <li>- Reduce pressure.</li> </ul>	24
717 (E717)	Error C Factory setting: Warning C	Out of specification (S)	C>Transmitter over temperature	<ul style="list-style-type: none"> <li>- The temperature measured in the electronics is greater than the upper nominal temperature of the electronics (+88 °C (+190 °F)).</li> <li>- Unsuitable download carried out.</li> </ul>	<ul style="list-style-type: none"> <li>- Reduce ambient temperature.</li> <li>- Check configuration and perform download again.</li> </ul>	34
718 (E718)	Error C Factory setting: Warning C	Out of specification (S)	C>Transmitter under temperature	<ul style="list-style-type: none"> <li>- The temperature measured in the electronics is smaller than the lower nominal temperature of the electronics (-43 °C (-45 °F)).</li> <li>- Unsuitable download carried out.</li> </ul>	<ul style="list-style-type: none"> <li>- Increase ambient temperature. Insulate device if necessary.</li> <li>- Check configuration and perform download again.</li> </ul>	35
719 (A719)	Alarm B	Funktion check (C)	B>Y-VAL of lin. table out of edit limits	<ul style="list-style-type: none"> <li>- At least on Y-VALUE in the linearisation table is below the MIN. TANK CONTANT or above the MAX. TANK CONTENT.</li> </ul>	<ul style="list-style-type: none"> <li>- Carry out calibration again. (→ See also Operating Instructions BA00274P)</li> </ul>	40
720 (E720)	Error C Factory setting: Warning C	Out of specification (S)	C>Sensor under temperature	<ul style="list-style-type: none"> <li>- The temperature measured in the sensor is smaller than the lower nominal temperature of the sensor. (→ See also Operating Instructions BA00274P, parameter description Tmin SENSOR)</li> <li>- Unsuitable download carried out.</li> <li>- Loose connection at sensor cable</li> </ul>	<ul style="list-style-type: none"> <li>- Increase process temperature/ ambient temperature.</li> <li>- Check configuration and perform download again.</li> <li>- Wait a short period of time and tighten the connection, or avoid loose connection.</li> </ul>	33
721 (A721)	Alarm B	Funktion check (C)	B>ZERO POSITION level out of edit limits	<ul style="list-style-type: none"> <li>- LEVEL MIN or LEVEL MAX has been changed.</li> </ul>	<ul style="list-style-type: none"> <li>- Perform reset (Code 2710) and carry out calibration again.</li> </ul>	41
722 (A722)	Alarm B	Funktion check (C)	B>EMPTY CALIB. or FULL CALIB. out of edit limits	<ul style="list-style-type: none"> <li>- LEVEL MIN or LEVEL MAX has been changed.</li> </ul>	<ul style="list-style-type: none"> <li>- Perform reset (Code 2710) and carry out calibration again.</li> </ul>	42
723 (A723)	Alarm B	Funktion check (C)	B>MAX. FLOW out of edit limits	<ul style="list-style-type: none"> <li>- FLOW-MEAS. TYPE has been changed.</li> </ul>	<ul style="list-style-type: none"> <li>- Carry out calibration again.</li> </ul>	43

Code	Error type/ NA 64	Corresponds NE 107	Message/description	Cause	Measure	Prio rity
725 (A725)	Alarm B	Failure (F)	B>Sensor connection error, cycle disturbance	<ul style="list-style-type: none"> <li>- Electromagnetic effects are greater than specifications in the technical data. (→ See Section 10.)</li> <li>- Setscrew loose.</li> <li>- Sensor or main electronics defect.</li> </ul>	<ul style="list-style-type: none"> <li>- Block off electromagnetic effects or eliminate source of disturbance.</li> <li>- Retighten setscrew with 1 Nm (0,74 lbf ft) (see Chap. 4.4.5).</li> <li>- Replace sensor or main electronics.</li> </ul>	25
726 (E726)	Error C Factory setting: Warning C	Out of specification (S)	C>Sensor temperature error - overrange	<ul style="list-style-type: none"> <li>- Electromagnetic effects are greater than specifications in the technical data. (→See Section 10.)</li> <li>- Process temperature is outside permitted range.</li> <li>- Sensor defect.</li> </ul>	<ul style="list-style-type: none"> <li>- Block off electromagnetic effects or eliminate source of disturbance.</li> <li>- Check temperature present, reduce or increase if necessary.</li> <li>- If the process temperature is within the permitted range, replace sensor.</li> </ul>	31
727 (E727)	Error C Factory setting: Warning C	Out of specification (S)	C>Sensor pressure error - overrange	<ul style="list-style-type: none"> <li>- Electromagnetic effects are greater than specifications in the technical data. (→ See Section 10.)</li> <li>- Pressure is outside permitted range.</li> <li>- Sensor defect.</li> </ul>	<ul style="list-style-type: none"> <li>- Block off electromagnetic effects or eliminate source of disturbance.</li> <li>- Check pressure present, reduce or increase if necessary.</li> <li>- If the pressure is within the permitted range, replace sensor.</li> </ul>	28
728 (A728)	Alarm B	Failure (F)	B>RAM error	<ul style="list-style-type: none"> <li>- Fault in the main electronics.</li> <li>- Main electronics defect.</li> </ul>	<ul style="list-style-type: none"> <li>- Briefly disconnect device from the power supply.</li> <li>- Replace main electronics.</li> </ul>	2
729 (A729)	Alarm B	Failure (F)	B>RAM error	<ul style="list-style-type: none"> <li>- Fault in the main electronics.</li> <li>- Main electronics defect.</li> </ul>	<ul style="list-style-type: none"> <li>- Briefly disconnect device from the power supply.</li> <li>- Replace main electronics.</li> </ul>	3
730 (E730)	Error C Factory setting: Warning C	Out of specification (S)	C>LRV user limits exceeded	<ul style="list-style-type: none"> <li>- Pressure measured value has undershot the value specified for the Pmin ALARM WINDOW parameter.</li> <li>- Loose connection at sensor cable</li> </ul>	<ul style="list-style-type: none"> <li>- Check system/pressure measured value.</li> <li>- Change value for Pmin ALARM WINDOW if necessary. (→ See also Operating Instructions BA00274P, parameter description Pmin ALARM WINDOW)</li> <li>- Wait a short period of time and tighten the connection, or avoid loose connection.</li> </ul>	46

Code	Error type/ NA 64	Corresponds NE 107	Message/description	Cause	Measure	Prio rity
731 (E731)	Error C Factory setting: Warning C	Out of specification (S)	C>URV user limits exceeded	- Pressure measured value has overshot the value specified for the Pmax ALARM WINDOW parameter.	- Check system/pressure measured value. - Change value for Pmax ALARM WINDOW if necessary. (→ See also Operating Instructions BA00274P, parameter description Pmax ALARM WINDOW)	45
		Out of specification (S)		- Loose connection at sensor cable	- Wait a short period of time and tighten the connection, or avoid loose connection.	
732 (E732)	Error C Factory setting: Warning C	Out of specification (S)	C>LRV Temp. User limits exceeded	- Temperature measured value has undershot the value specified for the Tmin ALARM WINDOW parameter.	- Check system/temperature measured value. - Change value for Tmin ALARM WINDOW if necessary. (→ See also Operating Instructions BA00274P, parameter description Tmin ALARM WINDOW)	48
733 (E733)	Error C Factory setting: Warning C		Out of specification (S)	C>URV Temp. User limits exceeded	- Temperature measured value has overshot the value specified for the Tmax ALARM WINDOW parameter.	- Check system/temperature measured value. - Change value for Tmax ALARM WINDOW if necessary. (→ See also Operating Instructions BA00274P, parameter description Tmax ALARM WINDOW)
736 (A736)	Alarm B	Failure (F)	B>RAM error	- Fault in the main electronics.  - Main electronics defect.	- Briefly disconnect device from the power supply.  - Replace main electronics.	4
737 (A737)	Alarm B	Failure (F)	B>Measurement error	- Fault in the main electronics.  - Main electronics defect.	- Briefly disconnect device from the power supply.  - Replace main electronics.	20
738 (A738)	Alarm B	Failure (F)	B>Measurement error	- Fault in the main electronics.  - Main electronics defect.	- Briefly disconnect device from the power supply.  - Replace main electronics.	19
739 (A739)	Alarm B	Failure (F)	B>Measurement error	- Fault in the main electronics.  - Main electronics defect.	- Briefly disconnect device from the power supply.  - Replace main electronics.	23
740 (E740)	Error C Factory setting: Warning C	Maintenance request (M)	C>Calculation overflow, bad configuration, hardware defect	- Level measuring mode: the measured pressure has undershot the value for HYDR. PRESS. MIN. or overshot the value for HYDR. PRESS MAX.  - Level measuring mode: The measured level did not reach the LEVEL MIN value or exceeded the LEVEL MAX value.  - Flow measuring mode: the measured pressure has undershot the value for MAX. PRESS FLOW.	- Check configuration and carry out calibration again if necessary. - Select a device with a suitable measuring range.  - Check configuration and carry out calibration again if necessary. (→ See also Operating Instructions BA00274P, parameter description LEVEL MIN.)  - Check configuration and carry out calibration again if necessary. - Select a device with a suitable measuring range.	27
741 (A741)	Alarm B	Funktion check (C)	B>TANK HEIGHT out of edit limits	- LEVEL MIN or LEVEL MAX has been changed.	- Perform reset (Code 2710) and carry out calibration again.	44

Code	Error type/ NA 64	Corresponds NE 107	Message/description	Cause	Measure	Priority
742 (A742)	Alarm B	Failure (F)	B>Sensor connection error (upload)	<ul style="list-style-type: none"> <li>- Electromagnetic effects are greater than specifications in the technical data. (→ See Section 10.) This message normally only appears briefly.</li> <li>- Cable connection sensor –main electronics disconnected.</li> <li>- Sensor defect.</li> </ul>	<ul style="list-style-type: none"> <li>- Wait a few minutes.</li> <li>- Perform reset (Code 7864) and carry out calibration again.</li> <li>- Check cable connection and repair if necessary.</li> <li>- Replace sensor.</li> </ul>	18
743 (E743)	Alarm B	Failure (F)	B>Electronic PCB error during initialisation	<ul style="list-style-type: none"> <li>- This message normally only appears briefly.</li> <li>- Main electronics defect.</li> </ul>	<ul style="list-style-type: none"> <li>- Wait a few minutes.</li> <li>- Restart the device. Perform reset (Code 62).</li> <li>- Replace main electronics.</li> </ul>	14
744 (A744)	Alarm B	Failure (F)	B>Main electronic PCB error	<ul style="list-style-type: none"> <li>- Electromagnetic effects are greater than specifications in the technical data. (→ See Section 10.)</li> <li>- Main electronics defect.</li> </ul>	<ul style="list-style-type: none"> <li>- Restart the device. Perform reset (Code 62).</li> <li>- Block off electromagnetic effects or eliminate source of disturbance.</li> <li>- Replace main electronics.</li> </ul>	11
745 (W745)	Warning C	Maintenance request (M)	C>Sensor data unknown	<ul style="list-style-type: none"> <li>- Sensor does not suit the device (electronic sensor nameplate). Device continues measuring.</li> </ul>	<ul style="list-style-type: none"> <li>- Replace sensor with a suitable sensor.</li> </ul>	56
746 (W746)	Warning C	Funktion check (C)	C>Sensor connection error - initialising	<ul style="list-style-type: none"> <li>- Electromagnetic effects are greater than specifications in the technical data. (→ See Section 10.) This message normally only appears briefly.</li> <li>- Overpressure or low pressure present.</li> </ul>	<ul style="list-style-type: none"> <li>- Wait a few minutes.</li> <li>- Restart the device. Perform reset (Code 7864).</li> <li>- Block off electromagnetic effects or eliminate source of disturbance.</li> <li>- Reduce or increase pressure.</li> </ul>	26
747 (A747)	Alarm B	Failure (F)	B>Sensor software not compatible to electronics	<ul style="list-style-type: none"> <li>- Sensor does not suit the device (electronic sensor nameplate).</li> </ul>	<ul style="list-style-type: none"> <li>- Replace sensor with a suitable sensor.</li> </ul>	16
748 (A748)	Alarm B	Failure (F)	B>Memory failure in signal processor	<ul style="list-style-type: none"> <li>- Electromagnetic effects are greater than specifications in the technical data. (→See Section 10.)</li> <li>- Main electronics defect.</li> </ul>	<ul style="list-style-type: none"> <li>- Block off electromagnetic effects or eliminate source of disturbance.</li> <li>- Replace main electronics.</li> </ul>	15



### 9.1.1 On-site display error messages

If the device detects a defect in the on-site display during initialization, the following error messages can be displayed:

Message	Measure
Initialization, VU Electr. Defect A110	Exchange on-site display.
Initialization, VU Electr. Defect A114	
Initialization, VU Electr. Defect A281	
Initialization, VU Checksum Err. A110	
Initialization, VU Checksum Err. A112	
Initialization, VU Checksum Err. A171	

## 9.2 Response of outputs to errors

The device differentiates between the error types Alarm, Warning and Error.  
 → See the following table and →  48, Section 9.1 "Messages".

Output	A (Alarm)	W (Warning)	E (Error: Alarm/Warning)
Current output	Assumes the value specified via the OUTPUT FAIL MODE <sup>1)</sup> , ALT. CURR. OUTPUT <sup>1</sup> and SET MAX. ALARM <sup>1</sup> parameter. → See also the following section "Configuring current output for an alarm".	Device continues measuring.	For this error, you can enter whether the device should react as in the event of an alarm or as in the event of a warning. See corresponding "Alarm" or "Warning" column. (→ See also Operating Instructions BA00274P, parameter description SELECT ALARM TYPE)
Bargraph (on-site display)	The bargraph adopts the value defined by the OUTPUT FAIL MODE <sup>1</sup> parameter.	The bargraph adopts the value which corresponds to the current value.	→ See this table, "Alarm" or "Warning" column, depending on selection.
On-site display	<ul style="list-style-type: none"> <li>- The measured value and message are displayed alternately</li> <li>- Measured value display:  -symbol is permanently displayed.</li> </ul> <p>Message display</p> <ul style="list-style-type: none"> <li>- 3-digit number such as A122 and description</li> </ul>	<ul style="list-style-type: none"> <li>- The measured value and message are displayed alternately</li> <li>- Measured value display:  -symbol flashes.</li> </ul> <p>Message display:</p> <ul style="list-style-type: none"> <li>- 3-digit number such as W613 and description</li> </ul>	<ul style="list-style-type: none"> <li>- The measured value and message are displayed alternately</li> <li>- Measured value display: see corresponding "Alarm" or "Warning" column</li> </ul> <p>Message display:</p> <ul style="list-style-type: none"> <li>- 3-digit number such as E731 and description</li> </ul>
Remote operation (digital communication)	In the case of an alarm, the ALARM STATUS <sup>2)</sup> parameter displays a 3-digit number such as 122 for "Sensor not connected".	In the case of a warning, the ALARM STATUS <sup>2)</sup> parameter displays a 3-digit number such as 613 for "Simulation is active".	In the case of an error, the ALARM STATUS <sup>2)</sup> parameter displays a 3-digit number such as 731 for "URV user limits exceeded".

- 1) Menu path: (GROUP SELECTION →) OPERATING MENU → OUTPUT
- 2) Menu path: (GROUP SELECTION →) OPERATING MENU → MESSAGES



### 9.2.1 Configuring current output for an alarm

You can configure the current output for the event of an alarm by means of the OUTPUT FAIL MODE, ALT. CURR. OUTPUT and SET MAX. ALARM parameters. These parameters are displayed in the OUTPUT group (menu path: (GROUP SELECTION →) OPERATING MENU → OUTPUT).

In the event of an alarm, the current and the bargraph assume the value entered with the OUTPUT FAIL MODE parameter.

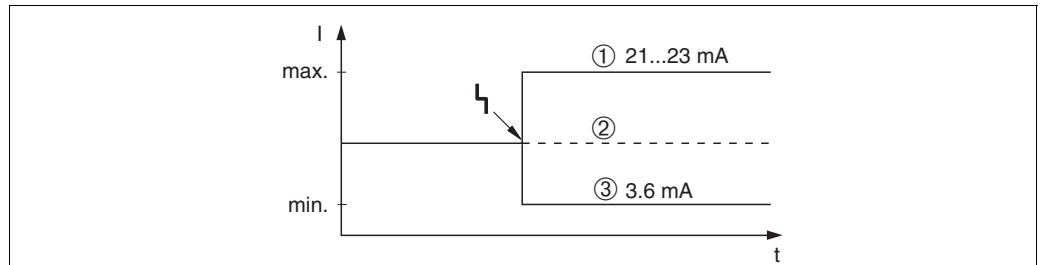

Fig. 17: Current output in the event of an alarm

**Options:**

- 1 Max. alarm (110%): can be set between 21 to 23 mA via the SET MAX. ALARM parameter
- 2 Hold meas. value: last measured value is kept
- 3 Min. alarm (-10%): 3.6 mA

**Factory setting:**

- OUTPUT FAIL MODE: Max. Alarm (110%)
- SET MAX. ALARM: 22 mA

Use the ALT. CURR. OUTPUT parameter to set the current output value for the error messages E 120 "Sensor low pressure" and E 115 "Sensor overpressure". You have the following options:

- Normal/NE43: the current output assumes the value set via the OUTPUT FAIL MODE and SET MAX. ALARM parameters.
- Special
  - Lower sensor limit undershot (E 120 "Sensor low pressure"): 3.6 mA
  - Upper sensor limit overshoot (E 115 "Sensor overpressure") overshoot: current output assumes the value set via the SET MAX ALARM parameter.

Attention : when using the case "special", the behavior is limited to an over/underpressure in a range LRL -10% up to LRL -30% and URL +10% up to URL +30%.

**Factory setting:**



- ALT. CURR. OUTPUT: Normal/NE43

### 9.3 Confirming messages

Depending on the settings for the ALARM DISPL. TIME and ACK. ALARM MODE parameters, the following measures should be taken to clear a message:

Settings <sup>1)</sup>	Measures
<ul style="list-style-type: none"> <li>- ALARM DISPL. TIME = 0 s</li> <li>- ACK. ALARM MODE = off</li> </ul>	<ul style="list-style-type: none"> <li>- Rectify cause of the message (see also Section 9.1).</li> </ul>
<ul style="list-style-type: none"> <li>- ALARM DISPL. TIME &gt; 0 s</li> <li>- ACK. ALARM MODE = off</li> </ul>	<ul style="list-style-type: none"> <li>- Rectify cause of the message (see also Section 9.1).</li> <li>- Wait for the alarm display time to elapse.</li> </ul>
<ul style="list-style-type: none"> <li>- ALARM DISPL. TIME = 0 s</li> <li>- ACK. ALARM MODE = on</li> </ul>	<ul style="list-style-type: none"> <li>- Rectify cause of the message (see also Section 9.1).</li> <li>- Confirm message using ACK. ALARM parameter.</li> </ul>
<ul style="list-style-type: none"> <li>- ALARM DISPL. TIME &gt; 0 s</li> <li>- ACK. ALARM MODE = on</li> </ul>	<ul style="list-style-type: none"> <li>- Rectify cause of the message (see also Section 9.1).</li> <li>- Confirm message using ACK. ALARM parameter.</li> <li>- Wait for the alarm display time to elapse. If a message appears and the alarm display time elapses before the message has been acknowledged, the message will be cleared once it has been acknowledged.</li> </ul>

1) Menu path for ALARM DISPL. TIME and ACK. ALARM MODE: (GROUP SELECTION →) OPERATING MENU → DIAGNOSTICS → MESSAGES

If the on-site display displays a message, you can suppress it with the -key. If there are several messages, the on-site display shows the message which has the highest priority (see also Section 9.1). Once you have suppressed this message using the -key, the message with the next highest priority is displayed. You can use the -key to suppress each message, one after the other. The ALARM STATUS parameter continues to display all the messages present.

## 9.4 Repair

The Endress+Hauser repairs concept provides for measuring devices to have a modular design and also the customer may carry out repairs (see Chap. 9.6 "Spare Parts" on →  59).

- For certified devices, please consult Chapter "Repair of Ex-certified devices".
- For more information on service and spare parts contact the Endress+Hauser Service. → See [www.endress.com/worldwide](http://www.endress.com/worldwide).

## 9.5 Repair of Ex-certified devices

### WARNING

#### Limitation of electrical safety due to incorrect connection!

Risk of explosion!

When repairing Ex-certified devices, please note the following:

- Only specialist personnel or Endress+Hauser may undertake repairs of certified devices.
- Relevant standards, national hazardous area regulations and Safety Instructions and Certificates must be observed.
- Only genuine Endress+Hauser spare parts may be used.
- When ordering spare parts, please check the device designation on the nameplate. Identical parts may only be used as replacements.
- Electronic inserts or sensors already in use in a standard instrument may not be used as spare parts for a certified device.
- Carry out repairs according to the instructions. After repairs, the device must fulfil the requirements of the specified individual tests.
- A certified device may only be converted into another certified variant by Endress+Hauser.
- All repairs and modifications must be documented.

## 9.6 Spare Parts

- Some replaceable measuring device components are identified by means of a spare part nameplate. This contains information about the spare part.
- All the spare parts for the measuring device along with the order code are listed in the W@M Device Viewer ([www.endress.com/deviceviewer](http://www.endress.com/deviceviewer)) and can be ordered. If available, users can also download the associated Installation Instructions.



Measuring device serial number:

- Located on the device and spare part nameplate.
- Can be read out via the "DEVICE SERIAL No" parameter in the "TRANSMITTER DATA" submenu.

## 9.7 Return

The measuring device must be returned if repairs or a factory calibration are required, or if the wrong measuring device has been ordered or delivered. According to legal regulations, Endress+Hauser, as a ISO-certified company, is required to follow certain procedures when handling returned products that are in contact with process fluids.

To ensure swift, safe and professional device returns, please read the return procedures and conditions on the Endress+Hauser website at [www.services.endress.com/return-material](http://www.services.endress.com/return-material).

## 9.8 Disposal

When disposing, separate and recycle the device components based on the materials.

## 9.9 Software history

Date	Software version	Software changes	Documentation	
			Operating Instructions	Description of Instrument Functions
06.2006	02.10.zz	Original software. Compatible with: - ToF Tool Field Tool Package, version 4.0 or higher - FieldCare version 2.02.00 - HART Communicator DXR375 with Device Rev.: 21, DD Rev.: 1	—	BA274P/00/EN/07.06 71027249
			BA332P/00/EN/08.06 71027253	BA274P/00/EN/08.06 71027249
			BA332P/00/EN/07.07 71043309	BA274P/00/EN/07.07 71061022
			BA332P/00/EN/12.07 71043309	BA274P/00/EN/07.07 71061022
			BA332P/00/EN/05.08 71071716	BA274P/00/EN/05.08 71071855
			BA332P/00/EN/08.08 71077293	BA274P/00/EN/05.08 71071855
			BA332P/00/EN/06.09 71095397	BA274P/00/EN/06.09 71095452
			BA332P/00/EN/05.10 71114100	BA274P/00/EN/05.10 71118244
			BA00332P/00/EN/13.11 71139745	BA00274P/00/EN/13.11 71139795
			BA00332P/00/EN/14.12 71161907	BA00274P/00/EN/13.11 71139795
01.2013	02.11.zz	"Russian" is included as a menu language by default. The menu language "Nederlands" is no longer supported.	BA00332P/00/EN/15.13 71204552	BA00274P/00/EN/14.13 71204628
			BA00332P/00/EN/16.14 71254265	BA00274P/00/EN/15.14 71254474
06.2014	02.20.zz	HART7 protocole revision has been implemented.	BA00332P/00/EN/17.14 71260298	BA00274P/00/EN/16.14 71260321
			BA00332P/00/EN/18.14 71270395	BA00274P/00/EN/17.14 71270402
10.2017	02.30.zz	Improvement of safety confirmation and menus in FieldCare and HART handheld terminal.	BA00332P/00/EN/19.16 71336242	BA00274P/00/EN/18.16 71336359

## 10 Technical data

For technical data, please refer to the Technical Information TI00416P for Deltapilot S.

# Index

## Numerics

4 to 20 mA test signal. . . . . 22

## A

Alarm messages. . . . . 48

## C

Cable specification. . . . . 22

Commubox FXA195 anschließen . . . . . 23

Connecting Commubox FXA291 . . . . . 24

Connecting ToF Adapter FXA291 . . . . . 24

## D

Designated use. . . . . 8

Display. . . . . 25

## E

Electrical connection . . . . . 20

Error messages. . . . . 48

## F

Factory setting . . . . . 37

FieldCare. . . . . 36

## H

Hazardous area . . . . . 9

HistoROM/M-DAT . . . . . 33

## I

Incoming acceptance . . . . . 13

Installation instructions . . . . . 14

## L

Language, selection. . . . . 39

Level measurement . . . . . 42–43

Level measurement, on-site operation . . . . . 28

Level measurement, Quick Setup menu . . . . . 44

Load. . . . . 23

Locking operation . . . . . 36

## M

Measuring mode, selection . . . . . 39

## N

Nameplate . . . . . 10

## O

On-site display . . . . . 25

Operating elements, position. . . . . 26

Operating keys, function, with on-site display . . . . . 27

Operating keys, function, without on-site display. . . . . 27

Operating keys, position . . . . . 26

Operating menu. . . . . 31

Operational safety . . . . . 8

Overvoltage protection . . . . . 24

## P

Pipe mounting . . . . . 16

Position adjustment . . . . . 40

Potential matching . . . . . 23–24

Pressure measurement. . . . . 46

Pressure measurement, on-site operation. . . . . 30

Pressure measurement, Quick Setup menu . . . . . 46

Product safety . . . . . 9

## Q

Quick Setup menu level . . . . . 44

Quick Setup menu pressure . . . . . 46

## R

Repair . . . . . 59

Repair of Ex-certified devices. . . . . 59

Reset . . . . . 37

Returning devices . . . . . 59

Rotating the housing . . . . . 18

## S

Scope of delivery . . . . . 12

Screening . . . . . 23

Separate housing, assemble and mount. . . . . 17

Service Interface FXA291. . . . . 24

Sicherheitshinweise . . . . . 8

SIL3 . . . . . 9

Software history . . . . . 60

Spare Parts. . . . . 59

Storage . . . . . 13

Supply voltage . . . . . 22

## T

Trouble-shooting. . . . . 48

## U

Unlocking operation . . . . . 36

## W

Wall mounting. . . . . 16

Warnings . . . . . 48

Workplace safety. . . . . 8

---

---





[www.addresses.endress.com](http://www.addresses.endress.com)

---