

pH meter F-71

■ Preface

Thank you for purchasing one of the F-71 pH meters.

This meter has a large-sized LCD display, which enables to use the varied functions by simple operations, and especially will be convenient to use in laboratory.

Carefully read this manual before using the meter.

■ Warranty and Responsibility

Your meter is covered by HORIBA, Ltd. warranty for a period of one (1) year, under normal use. Although unlikely, if any trouble attributable to HORIBA, Ltd. should occur during this period, necessary exchange or repairs shall be conducted by HORIBA, Ltd., free of charge. The warranty does not cover the following:

- Any trouble or damage attributable to actions or conditions specifically mentioned to be avoided in the operation manuals
- Any trouble or damage attributable to use of the meter in ways or for purposes other than those described in the operation manuals
- If any repairs renovations, disassembly, etc. are performed on this meter by any party other than HORIBA, Ltd. or a party authorized by HORIBA, Ltd.
- Any alteration to the external appearance of this meter attributable to scratches, dirt, etc. occurring through normal use
- Wear and tear to parts, the exchange of accessories, or the use of any parts not specified by HORIBA, Ltd.

HORIBA, LTD. SHALL NOT BE LIABLE FOR ANY DAMAGES RESULTING FROM ANY MALFUNCTIONS OF THE PRODUCT, ANY ERASURE OF DATA, OR ANY OTHER USES OF THE PRODUCT.

■ Unauthorized reprinting or copying of this operation manual

No unauthorized reprinting or copying of all or part of this operation manual is allowed. The utmost care has been used in the preparation of this operation manual. If, however, you have any questions or notice any errors, please contact the HORIBA customer service center printed on the back cover of this operation manual.

Copyright © HORIBA, Ltd. 2011

REGULATIONS

■ Conformable Directive

This equipment conforms to the following directives and standards:



Directives: The EMC Directive 2004/108/EC
The Low Voltage Directive 2006/95/EC

Standards: [the EMC Directive] EN61326-1:2006
Class B, Basic requirements
[the Low Voltage Directive] EN61010-1:2010(Ed.3.0)

● Installation Environment

This product is designed for the following environment.

- Overvoltage category II
- Measurement category I

WARNING: Do not use the equipment for measurements within measurement categories II, III and IV.

● Information on Disposal of Electrical and Electronic Equipment and Disposal of Batteries and Accumulators

The crossed out wheeled bin symbol with underbar shown on the product or accompanying documents indicates the product requires appropriate treatment, collection and recycle for waste electrical and electronic equipment (WEEE) under the Directive 2002/96/EC, and/or waste batteries and accumulators under the Directive 2006/66/EC in the European Union.

The symbol might be put with one of the chemical symbols below. In this case, it satisfies the requirements of the Directive 2006/66/EC for the object chemical.

This product should not be disposed of as unsorted household waste. Your correct disposal of WEEE, waste batteries and accumulators will contribute to reducing wasteful consumption of natural resources, and protecting human health and the environment from potential negative effects caused by hazardous substance in products.

Contact your supplier for information on applicable disposal methods.

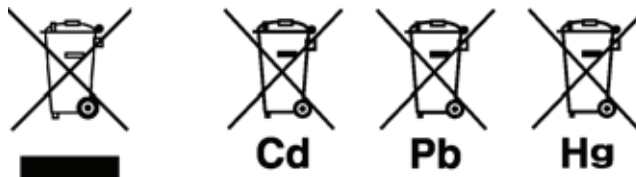

REGULATIONS

■ FCC Rules

Any changes or modifications not expressly approved by the party responsible for compliance shall void the user's authority to operate the equipment.

● WARNING

This equipment has been tested and found to comply with the limits for a Class A digital device, pursuant to part 15 of the FCC Rules. These limits are designed to provide reasonable protection against harmful interference when the equipment is operated in a commercial environment. This equipment generates, uses, and can radiate radio frequency energy and, if not installed and used in accordance with the instruction manual, may cause harmful interference to radio communications.

Operation of this equipment in a residential area is likely to cause harmful interference in which case the user will be required to correct the interference at his own expense.

■ Hazard Classification and Warning Symbols

Warning messages are described in the following manner. Read the messages and follow the instructions carefully.

● Hazard classification

 **DANGER**

This indicates an imminently hazardous situation which, if not avoided, will result in death or serious injury. This signal word is to be limited to the most extreme situations.

 **WARNING**

This indicates a potentially hazardous situation which, if not avoided, could result in death or serious injury.

 **CAUTION**

This indicates a potentially hazardous situation which, if not avoided, may result in minor or moderate injury. It may also be used to alert against unsafe practices.

Without safety alert indication of hazardous situation which, if not avoided, could result in property damage.

● Warning symbols



Description of what should be done, or what should be followed











Description of what should never be done, or what is prohibited

SAFETY OPERATION

■ Safety Precautions

This section provides precautions to enable you to use the product safely and correctly and to prevent injury and damage. The terms of DANGER, WARNING, and CAUTION indicate the degree of imminency and hazardous situation. Read the precautions carefully as it contains important safety messages.

 WARNING	
	Do not use an unspecified AC adapter. Otherwise, it may heat up or be ignited resulting in a fire or an accident.
	Do not disassemble or modify the meter. Otherwise, it may heat up or be ignited resulting in a fire or an accident.

 CAUTION	
	Harmful chemicals Some ion electrodes are used with hazardous standard solutions. Handle them with care. If the internal solution comes in contact with the skin, wash it off immediately. If it gets into eyes, flush with plenty of water and then consult a doctor.
	Harmful chemicals The internal solution of an electrodes is highly concentrated potassium chloride (3.33 mol/L KCl). If the internal solution comes in contact with the skin, wash it off immediately. If it gets into eyes, flush with plenty of water and then consult a doctor.
	Broken glass Broken glass may cause injury. The outer tube and tip of an electrode are made of glass. Handle them with care.
	Do not use the cable of serial communication, USB, or AC adapter under wet or humid conditions. Otherwise, it may cause an fire, electric shock, or breakage.

■ Product Handling Information

● Operational Precautions

- Do not drop, crash, or give any physical impact on the instrument.
- Do not immerse the instrument into alcohol, organic solvent, strong acid, strong alkaline, or the like. The instrument body contains ABS resin, acrylic resin, and some rubber parts.
- If the instrument is dropped into water or gets wet, wipe it using soft cloth. Do not heat to dry it with a hair-dryer (or the like).
- Use fingers to press the operation keys or the touch panel. Do not use a hard object like a metal stick or rod.
- Be careful not to let water into the instruction inside. The instrument is not water-proof.
- To disconnect an electrode or interface cable, hold the connector and pull it off. If you pull at the cable, it may cause a breakage.
- The touch panel is capacitance-type. Make sure to turn OFF the power before cleaning the panel. If you wipe it with the power ON, it may cause instrument malfunction.
- RS-232C or USB communication between the instrument and a personal computer may fail because of environmental conditions, such as (radio/electromagnetic) noise.

● Environmental conditions for use and storage

- Temperature: 0°C to 45°C
- Humidity: under 80% in relative humidity and free from condensation

Avoid the following conditions:

- Dusty environment
- Strong vibration
- Direct sunlight
- Corrosive gas environment
- Close to an air-conditioner
- Direct wind

● Transportation

When transporting the instrument, repackage it in the original package box. Otherwise, it may cause instrument breakage.

● Disposal

Standard solution used for the calibration must be under neutralized before the disposal. As for the disposal of the meter, treat it as an industrial waste.

■ Description in This Manual

— **NOTE** —

This mark indicates the operation requires a special care and attention.

— **REF** —

This mark indicates to which the reader should go for reference.

— **HINT!** —

This mark indicates reference information.

CONTENTS

Chapter 1 About the F-71	1
Chapter 2 Information of the F-71	2
2.1 Measurement Items	2
2.2 Packing List	2
2.3 Names and Functions	3
2.3.1 Names of Each Part	3
2.3.2 Display	4
2.3.3 Operation Key	5
2.4 Measurement (MEAS) Flow Chart	6
2.5 Setting (SET) Flow Chart	7
2.6 Data (DATA) Flow Chart	8
Chapter 3 Basic Operation	9
3.1 Preparation	9
3.1.1 Assembling the Electrode Stand	9
3.1.2 Electrode Connection	10
3.1.3 Connecting the Power Source	11
3.1.4 Connecting and Setting the Printer	12
3.1.5 Connecting the Personal Computer	13
3.2 Settings	14
3.2.1 pH Standard Solution Setting	14
3.2.2 Temperature Compensation Function Setting	16
3.2.3 Auto Data Memory Setting	18
3.2.4 pH Calibration Interval Setting	19
3.2.5 Sample ID Setting	21
3.2.6 Auto Printer Setting	22
3.2.7 Maintenance	23
3.3 Calibration	38
3.3.1 pH Calibration	38
3.3.2 Calibration Value Printing	47
3.4 Measurement	48
3.4.1 Measurement Value Hold	48

CONTENTS

3.4.2	Measurement Items Changing	49
3.4.3	Auto Data Memory	49
3.4.4	Measurement Value Printing	50
3.5	Data Operation	52
3.5.1	Data Memory of Measurement Value	52
3.5.2	Memory Data Display	53
3.5.3	Memory Data Printing	54
3.5.4	Calibration History Display	55
3.5.5	Calibration History Printing	56
3.5.6	pH Check History Display	58
3.5.7	pH Check Data Printing	59
 Chapter 4 Maintenance and Troubleshooting		 60
4.1	pH (ORP) Electrode Maintenance	60
4.2	Troubleshooting	64
4.2.1	Error Message Chart	64
4.2.2	More Troubleshooting	70
 Chapter 5 Specifications		 76
5.1	Specifications	76
5.2	Default Settings	77
5.3	Options	78

Chapter 1 About the F-71

The desktop type pH meter F-71 is optimized for laboratory measurement, and allows you to measure pH and ORP.

It provides a comfortable measurement environment with the design easy to wipe clean without roughness on the surface, and the free-standing electrode stand and the custom LCD for ease of measurement.

Chapter 2 Information of the F-71

2.1 Measurement Items

Measurement item	F-71
pH	√
ORP (mV)	√
Temperature	√

2.2 Packing List

The F-71's package includes the following.

Electrodes are required for the measurement in addition to this package. If you want to buy an electrode, contact HORIBA sales representative.

Product	Quantity
Main unit	1
Electrode stand	1
Instruction Manual	1
Quick Manual	1
AC adapter	1
Ferrite core	1

2.3 Names and Functions

2.3.1 Names of Each Part

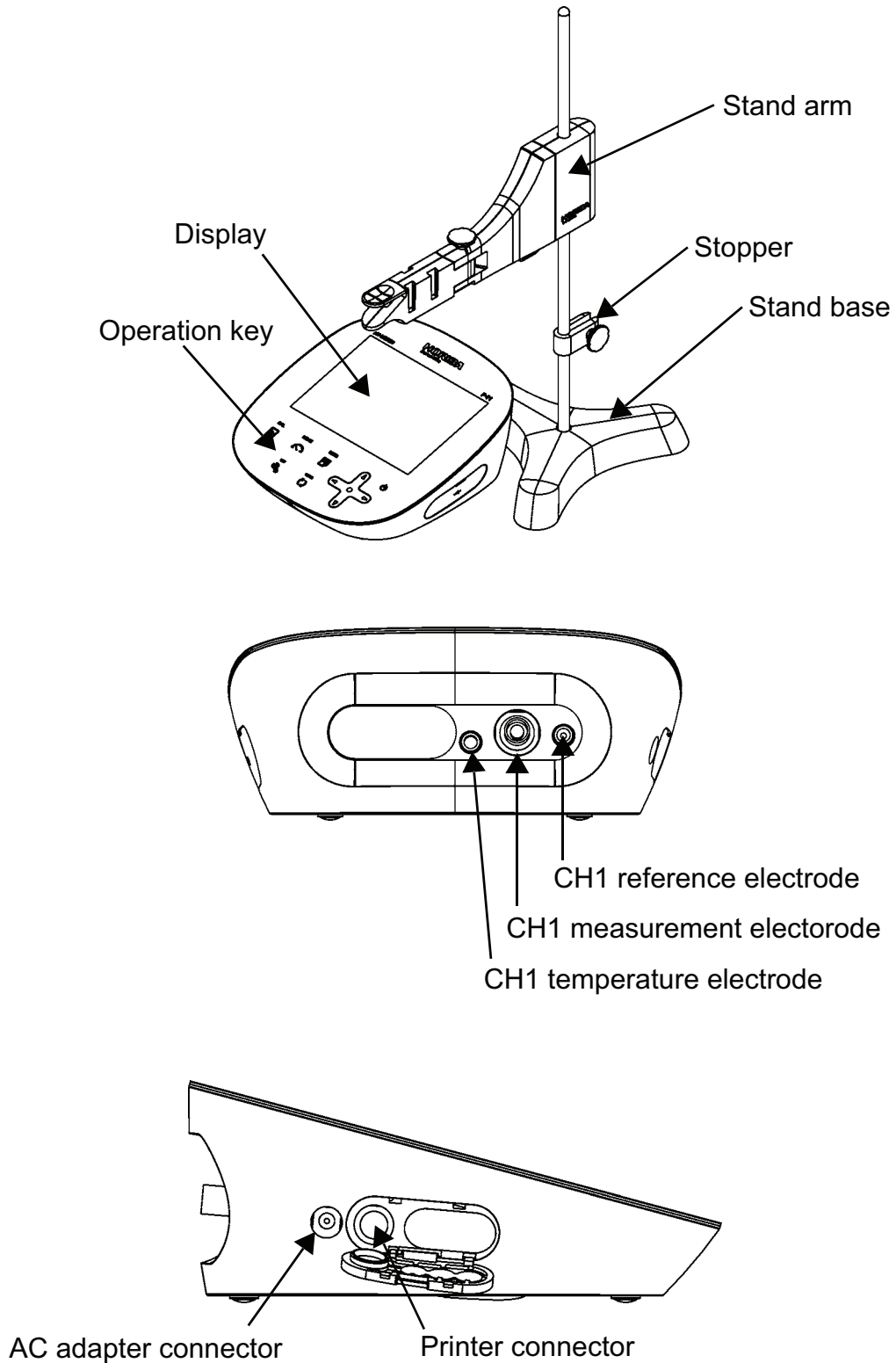

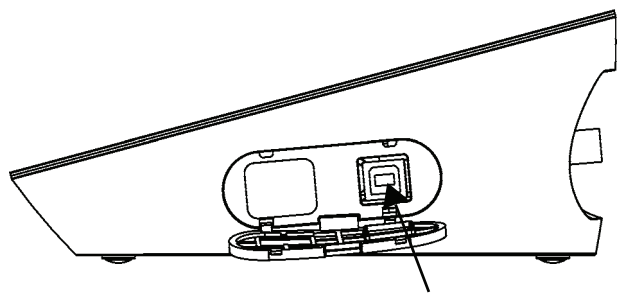

Connector for USB communication with a personal computer



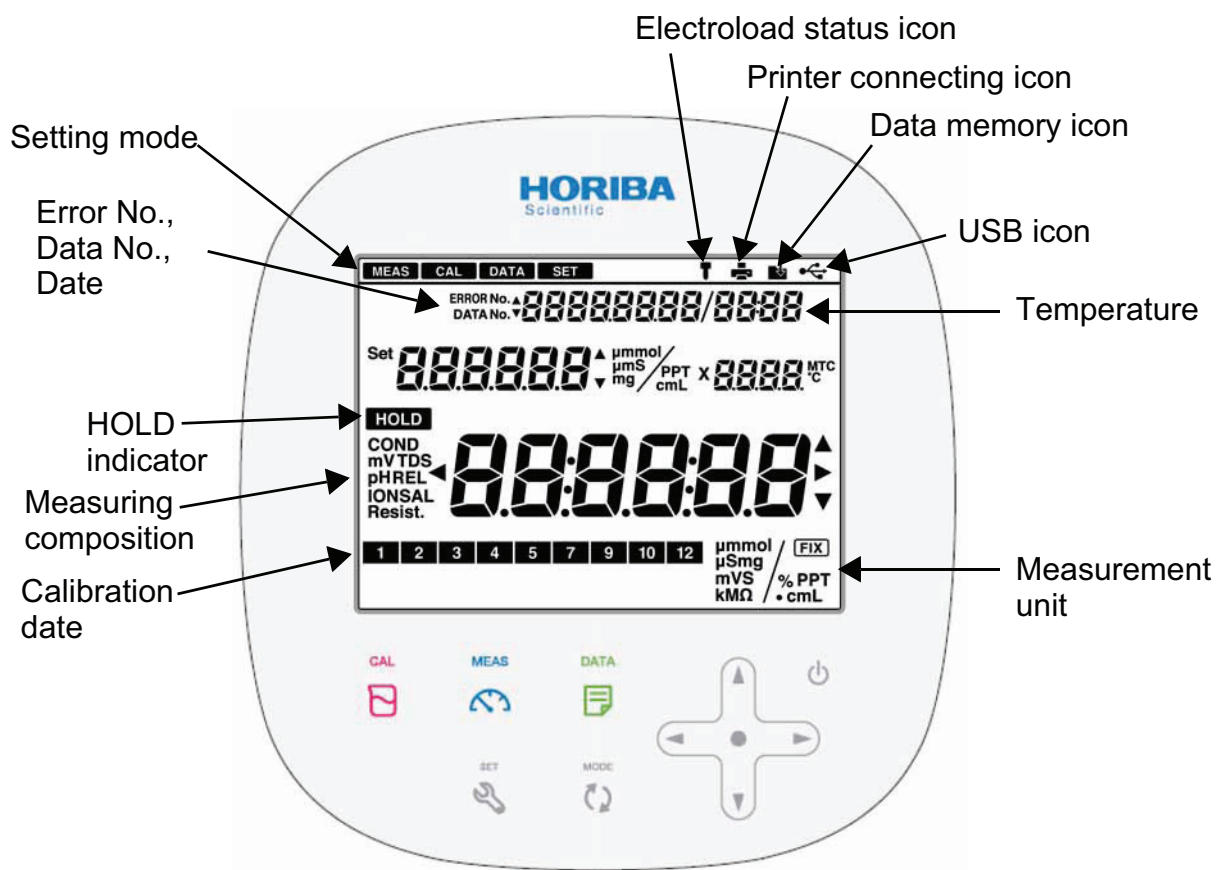



2.3.2 Display



2.3.3 Operation Key

This instrument employs capacitance switches.

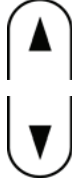
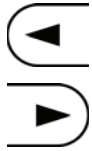
You can not operate them with thick gloves. Operate them with bare hands or thin rubber gloves.

Operation key		Function
CAL 	CAL key	Starts/stops calibration or enters the calibration mode.
MEAS 	MEAS key	Starts/stops measurement or enters the measurement mode. Applies the setting values of the setting mode.
DATA 	DATA key	Enters the data operation mode. Printouts calibration value.
SET 	SET key	Enters the setting mode. Cancels the setting values of the setting mode.
MODE 	MODE key	Toggles the measurement items.
	▲ key ▼ key	Increases the values. Decreases the values. Switches the setting item. Switches the CH items.
	◀▶ key	Change number of digits, selects functions. Printouts measurement values. (▶ key)
	ENTER key	Settlement, execution, prinout (except measurement values) Start/stops automatic data memory.
	POWER key	Turns ON or OFF the power.

NOTE

Press the POWER key for 1 second or longer to turn ON the power, for 2 seconds or longer to turn OFF the power.

2.4 Measurement (MEAS) Flow Chart

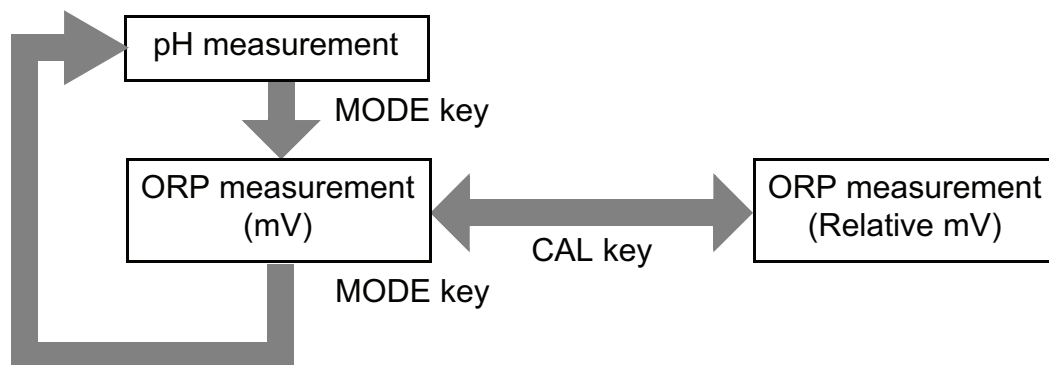

2.5 Setting (SET) Flow Chart

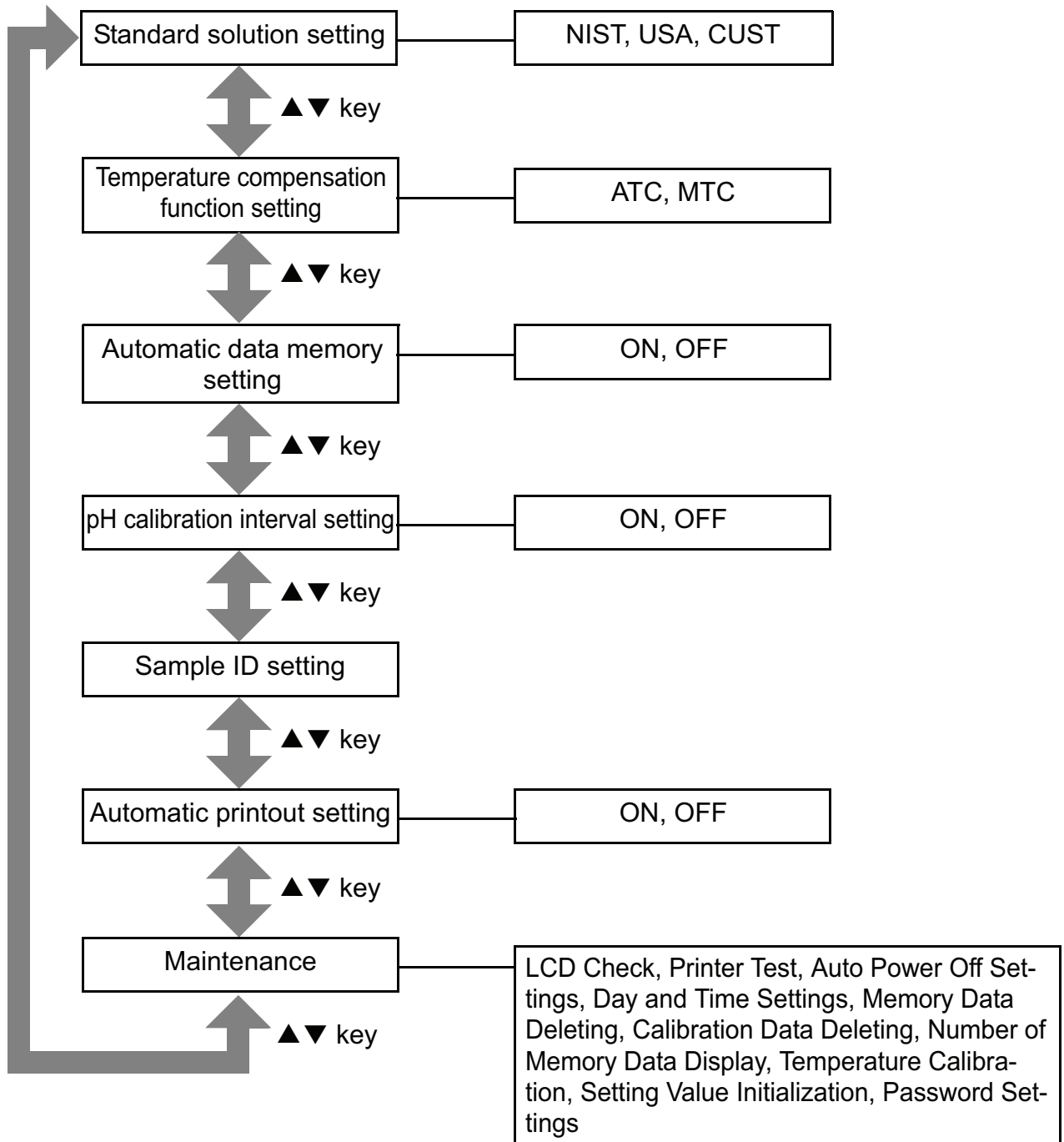

2.6 Data (DATA) Flow Chart

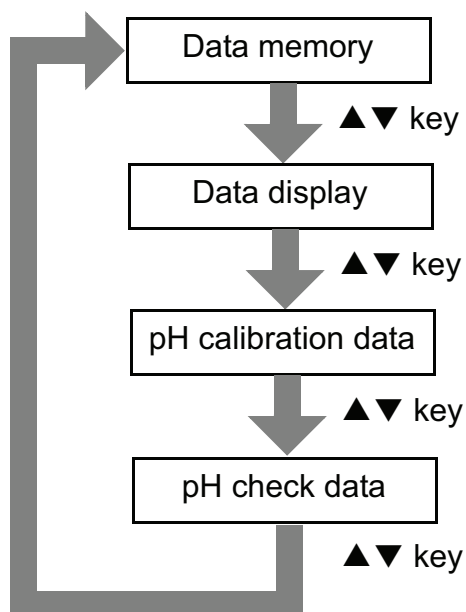

Chapter 3 Basic Operation

3.1 Preparation

3.1.1 Assembling the Electrode Stand

1. Attach the stand shaft to the stand base.
2. Attach the stopper and the stand arm to the stand shaft.

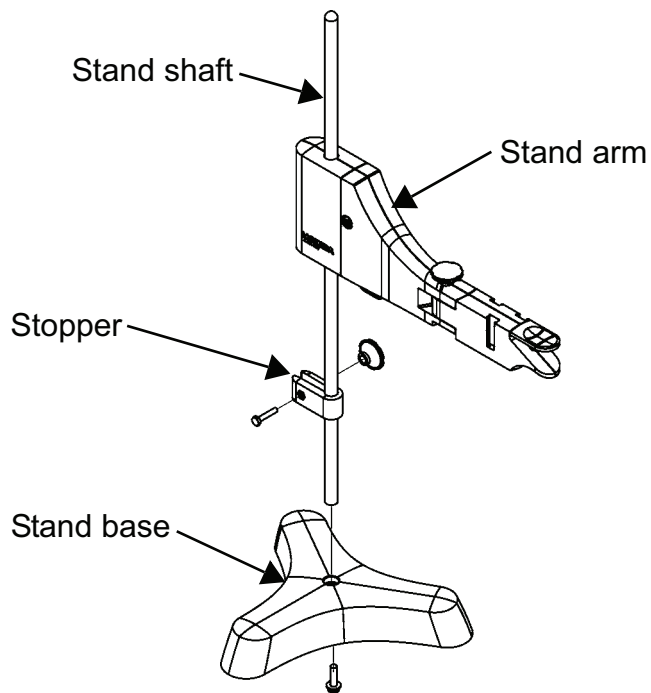

3.1.2 Electrode Connection

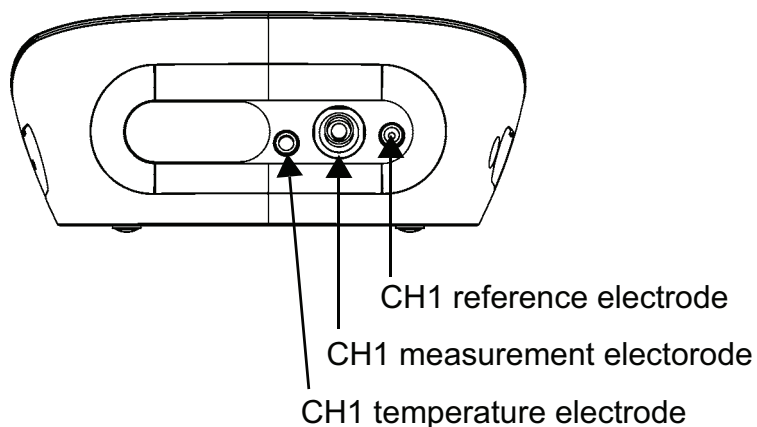

● Electrode connector

1. Insert the groove of electrode plug by fitting it with the socket pin of the instrument.

NOTE

If the pin and groove are misaligned, do not insert the plug with force.

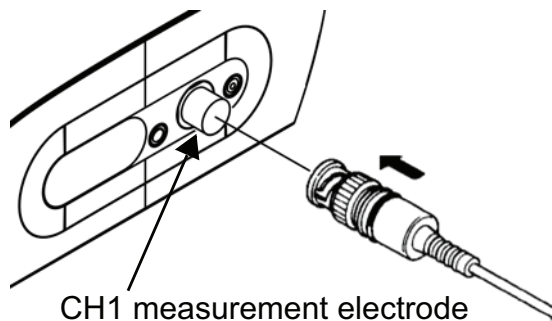

2. Turn the electrode connector to the right along the groove to plug the connector.

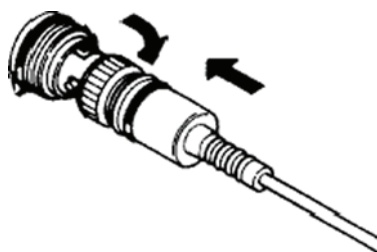

3. Put the connector cover on the connector.

NOTE

Just push the cover on the instrument. Do not screw in it.

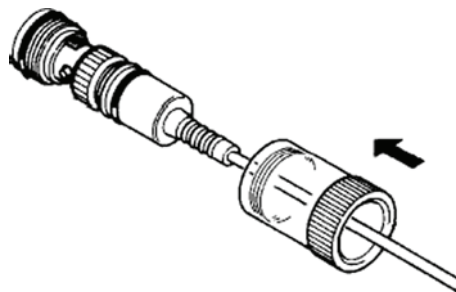

● **Temperature connector**

1. Insert the temperature connector into the jack socket on the instrument.

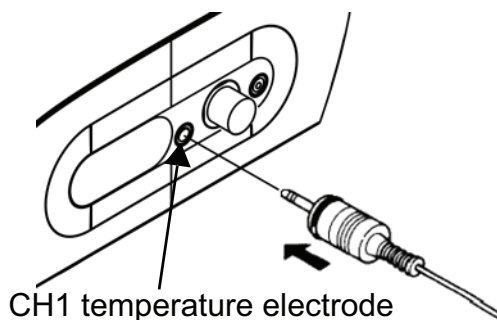

NOTE

If the temperature connector is unconnected or the connection is wrong, the MTC set temperature is displayed as the sample temperature.

3.1.3 Connecting the Power Source

1. Insert the AC adapter cable by fitting with the connector socket of in the instrument.

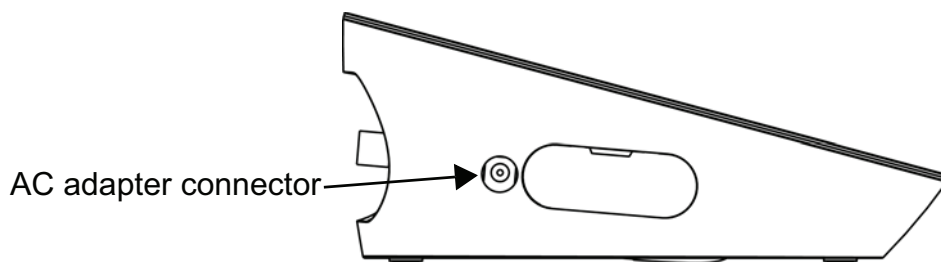

NOTE

- Do not insert the cable with force when the connectors do not match.
- Attach the provided ferrite core to the AC adapter cable.

3.1.4 Connecting and Setting the Printer

● Connecting the Printer

1. Insert the printer cable by fitting with the connector socket of the instrument.

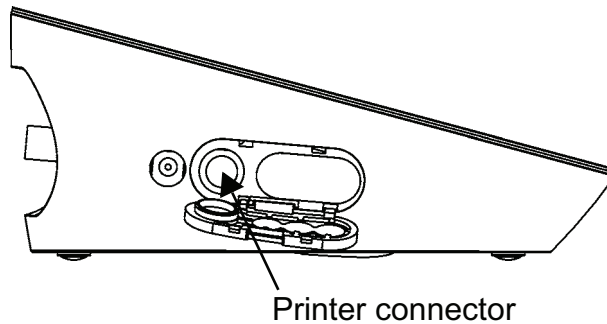

The following printer is possible.

Printer

- CITIZEN CBM-910-24RJ100-A:
plain paper type (Parts No.: 3014030145)
- Optional printer cable (Parts No.: 3014030148) is required.

NOTE

- Make sure to use an appropriate cable for the printer.
- Make sure to power OFF the instrument before connecting a printer.
- When you do not connect a printer with the instrument, disconnect the printer cable and put the rubber cap firmly on the connector sockets of the instrument.

● Setting the Printer

Refer to the instruction manual of the printer for settings and operations of the printer.

- (1) Set the DIP switch No. 6 to ON and No. 7 to OFF, and then set printer paper and ink ribbon. Keep the LF key held down
- (2) Keep the SEL key held down.
The printer prints output when the SEL key is being pressed.

3.1.5 Connecting the Personal Computer

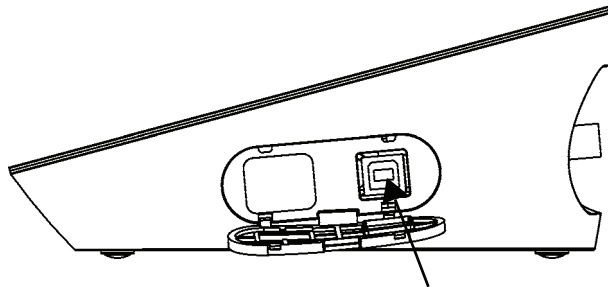

Personal computer communication connector

- Use proprietary cables to connect with a personal computer.
Proprietary cable
Parts name: USB cable (1 m)
Parts No.: 3200373941
- Make sure that the transfer formats of the measuring instrument and personal computer are same.
Otherwise, communication may fail due to a communication error or the online mode start failure.
If you change the transfer formats, power OFF both of the instrument and the personal computer once, and then turn on them again.
- For the details of communication commands, register with our website and see the free download page of manuals.

3.2 Settings

This section describes the procedures of the instrument condition settings for measurement, calibration, and maintenance.

The settings apply when you press the MEAS key to return to the measurement screen.

If you press the SET key during setting or after pressing the ENTER key, the settings are cancelled.

3.2.1 pH Standard Solution Setting

There are 3-type settings of standard solutions used for calibration; NIST, USA, and CUST.

NIST is selected initially for pH standard solutions.

This setting is possible only for CH1.

1. Press the SET key on the measurement screen is displayed to enter the pH standard solution setting screen.

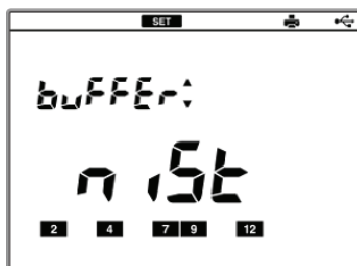

2. Press the ENTER key to enter the pH standard solution change screen

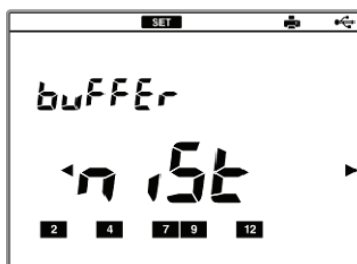

3. Press the ◀ or ▶ key to change NIST, USA, and CUST, and press the ENTER key.

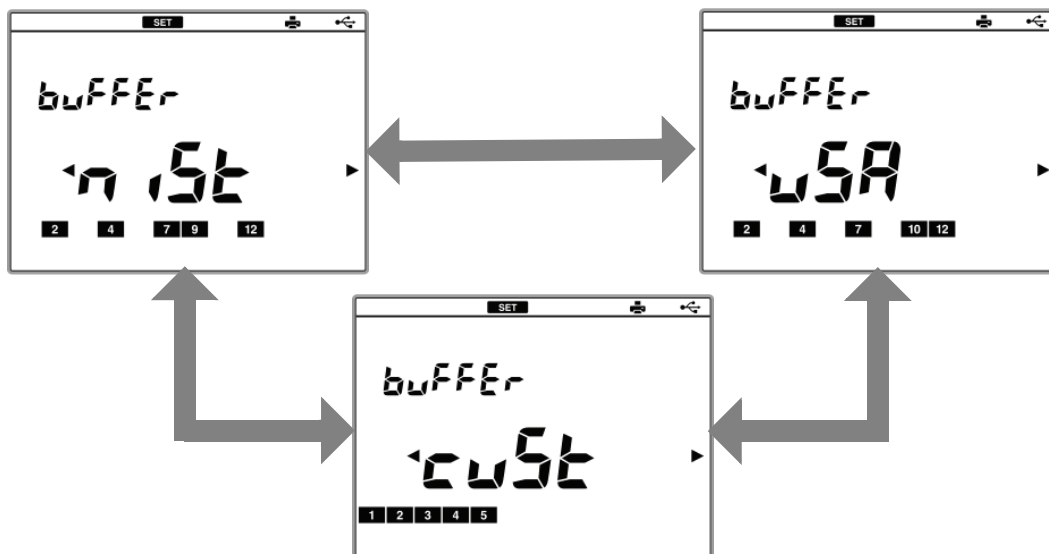

NIST specification (NIST)	When using a standard solution of interior specification
	Bottle mark 2 4 7 9 12
US specification (USA)	When using a standard solution of the USA specification
	Bottle mark 2 4 7 10 12
Customized specification (CUST)	When the user's exclusive standard solution
	Bottle mark 1 2 3 4 5

NOTE

The calibration value of the pH7 standard solution differs between NIST and USA.

NIST specification: pH6.865 (at 25°C)

US specification: pH7.000 (at 25°C)

When you use NIST standard solution for calibration, make sure to set NIST here.

3.2.2 Temperature Compensation Function Setting

You can perform temperature compensation for pH electrode outputs.

1. Press the SET key on the measurement screen, and press the ▼ key to enter the temperature compensation function setting screen.



2. Press the ENTER key to enter the temperature compensation function change screen.
3. Press the ◀ or ▶ key to change ATC or MTC, and press the ENTER key.

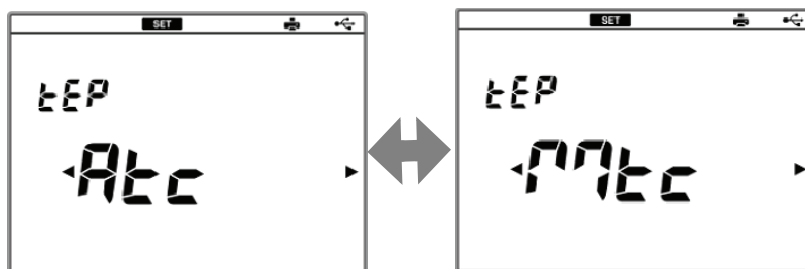

4. If you select MTC, press the ◀ or ▶ key to select a digit and press the ▲ or ▼ key to change the value, and then press the ENTER key.

Setting range: 0°C to 100°C



ATC

In Automatic Temperature Compensation (ATC), the instrument detects the solution temperature. When the temperature sensor is connected, the current temperature of the solutions is displayed automatically. If the sensor is not connected, the set value for MTC (default: 25°C) is displayed.

MTC

In Manual Temperature Compensation (MTC), the temperature sensor of the electrode is not used, and the solution temperature is entered manually.

3.2.3 Auto Data Memory Setting

Data memory can be performed automatically at a regular interval.

1. Press the SET key on the measurement screen, and press the ▲ or ▼ key to enter the auto data memory setting screen.



2. Press the ENTER key to enter the auto data memory change screen.
3. Press the ◀ or ▶ key to change ON or OFF, and press the ENTER key.

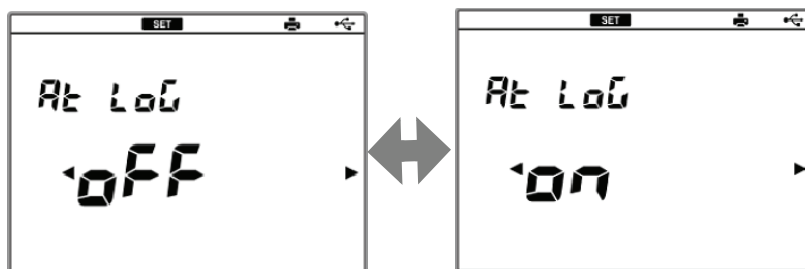

4. If you select ON, press the ◀ or ▶ key to select a digit and press the ▲ or ▼ key to change the value, and then press the ENTER key.

Setting range: 2 seconds to 24 hours



3.2.4 pH Calibration Interval Setting

This setting allows you to ensure calibration at a regular interval. When the set interval (days) elapses after the previous calibration, ERROR No.0008 (Calibration cycle error) is displayed.

1. Press the SET key on the measurement screen, and press the ▲ or ▼ key to enter the pH calibration interval setting screen.



2. Press the ENTER key to enter the calibration interval change screen.



3. Press the ◀ or ▶ key to change ON or OFF, and press the ENTER key.

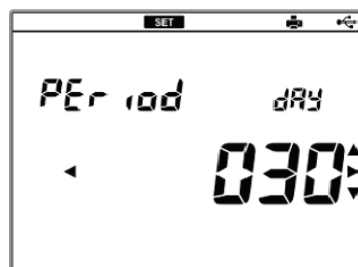

4. If you select ON, press the ◀ or ▶ key to select a digit and press the ▲ or ▼ key to change the value, and then press the ENTER key.

Setting range: 1 to 999 days

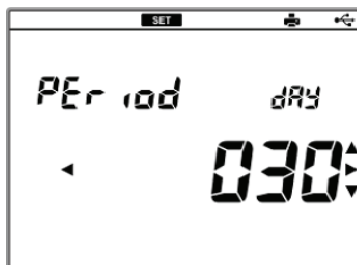

3.2.5 Sample ID Setting

If a sample ID is set here, it is recorded together with the measurement data at the data memory and it allows you to search data easily.

1. Press the SET key on the measurement screen, and press the ▲ or ▼ key to enter the sample ID setting screen.

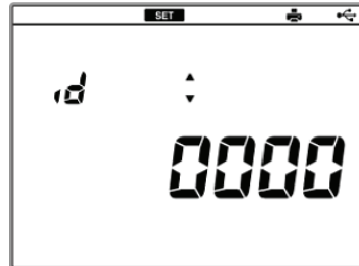

2. Press the ENTER key to enter the sample ID change screen.
3. Press the ◀ or ▶ key to select digit and press the ▲ or ▼ key to change value, and press the ENTER key.

Setting range: 0 to 9999

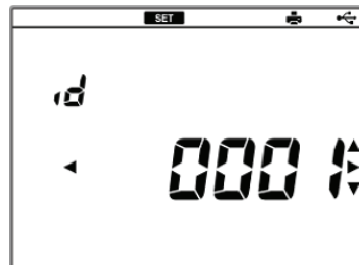

3.2.6 Auto Printer Setting

You can set automatic printout when a printer is connected.

When this setting is ON, automatic printout is executed at the following occasions.

- Data memory is performed during measurement.
- Calibration or check is completed in the calibration mode.

1. Press the SET key on the measurement screen, and press the ▲ or ▼ key to enter the auto printer setting screen.



2. Press the ENTER key to enter the auto printer setting change screen.
3. Press the ◀ or ▶ key to select ON or OFF, and press the ENTER key.

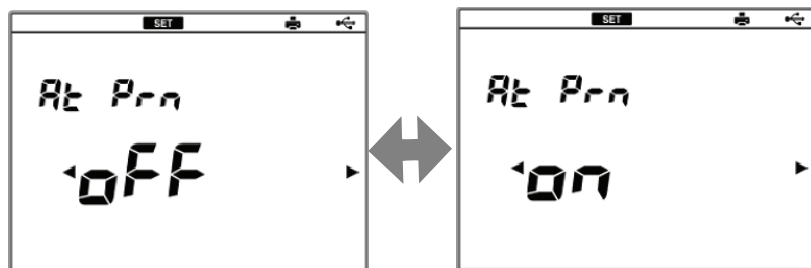

3.2.7 Maintenance

The functions on the maintenance screen helps you to use the instrument in good conditions.

● LCD Check

You can check the LCD.

1. Press the SET key on the measurement screen, and press the ▲ or ▼ key to enter the maintenance screen.

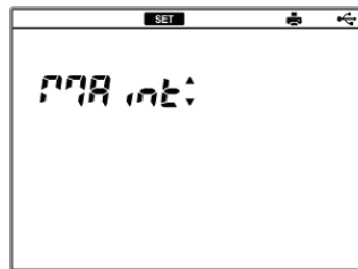

2. Press the ENTER key to enter the maintenance item selecting screen.



3. Press ENTER key to indicate the all LCD.

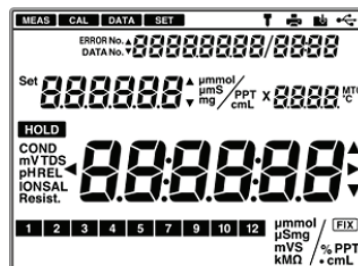

4. Press the ENTER key to return to the maintenance item selecting screen.



● Printer Test

You can check the printer connection and printout operation.

1. Press the SET key on the measurement screen, and press the ▲ or ▼ key to enter the maintenance screen.

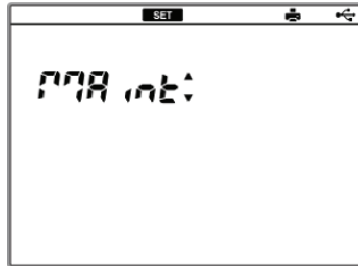

2. Press the ENTER key to enter the maintenance item selecting screen.



3. Press the ▲ or ▼ key to enter the printer test screen.

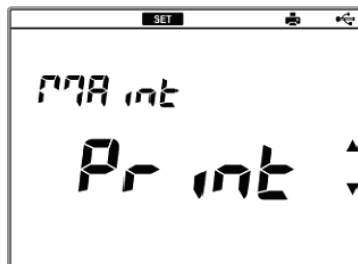

4. Press the ENTER key to start the printing.

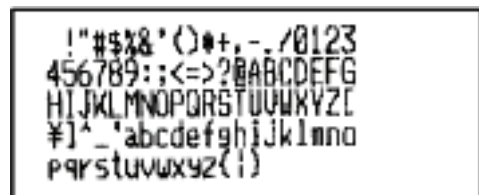

5. Press the ENTER key to return to the printer test screen.



● Auto Power Off Setting

You can set ON/OFF of the auto power off function. When this function is ON and no key operations are performed for the set period, the instrument is powered OFF automatically.

1. Press the SET key on the measurement screen, and press the ▲ or ▼ key to enter the maintenance screen.

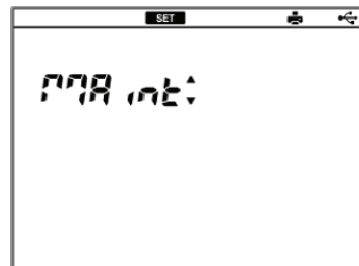

2. Press the ENTER key to enter the maintenance item selecting screen.



3. Press the ▲ or ▼ key to enter the auto power off setting screen.

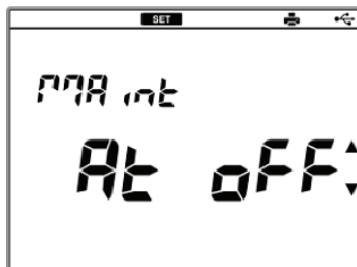

4. Press the ENTER key to enter the auto power off change screen.
5. Press the ◀ or ▶ key to change ON or OFF, and press the ENTER key.

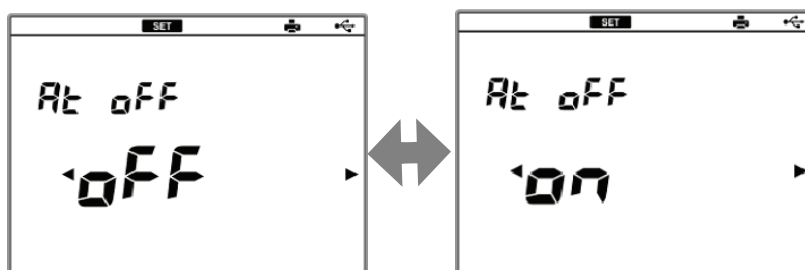

6. Press the ◀ or ▶ key to select a digit and press the ▲ or ▼ key to change the value, and then press the ENTER key to return to the auto power off change screen.

Setting range: 1 to 30 minutes



● Date Setting

Perform this operation when you use the instrument for the first time or replace the lithium batteries.

1. Press the SET key on the measurement screen, and press the ▲ or ▼ key to enter the maintenance screen.

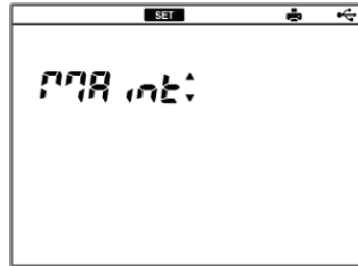

2. Press the ENTER key to enter the maintenance item selecting screen.



3. Press the ▲ or ▼ key to enter the date setting screen.



4. Press the ENTER key to enter the year setting screen. Press the ◀ or ▶ key to select a digit and press the ▲ or ▼ key to change the value, and then press the ENTER key.

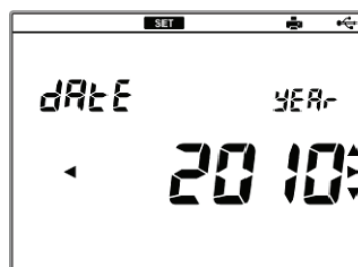

5. Press the ◀ or ▶ key to select a digit and press the ▲ or ▼ key to change the value for month and day setting, and then press the ENTER key.

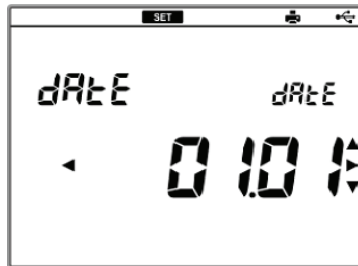

6. Press the ◀ or ▶ key to select a digit and press the ▲ or ▼ key to change the value for hour and minute setting, and press the ENTER key to return to the date setting screen.

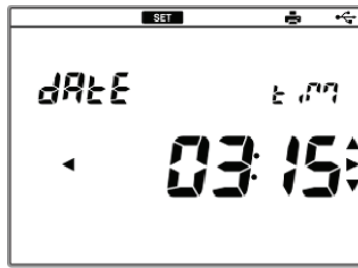

● Memory Data Clearing

You can delete the memory data of the instrument. This operation is irreversible. We recommend printing out or saving data into a PC ("3.1.5 Connecting the Personal Computer" P.13) before this operation.

1. Press the SET key on the measurement screen, and press the ▲ or ▼ key to enter the maintenance screen.

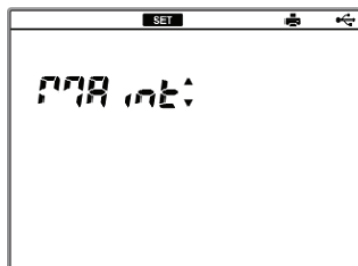

2. Press the ENTER key to enter the maintenance item selecting screen.



3. Press the ▲ or ▼ key to enter the memory data clear screen.



4. Press the ENTER key to enter the memory data clear (Yes/No) screen.

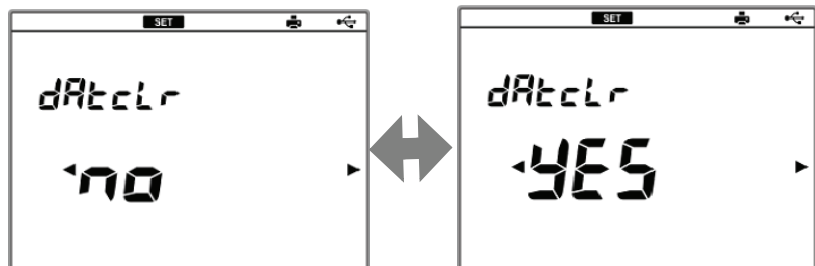

5. Press the ◀ or ▶ key to select Yes, and press ENTER key to delete the memory data.
When the deletion is completed, "End" is displayed.

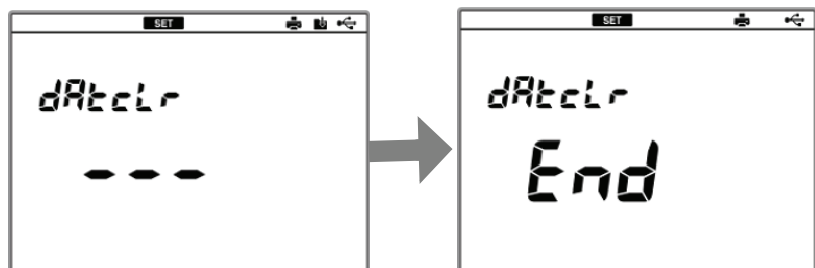

6. Press the ENTER key to return to the memory data clear screen.

● Calibration Data Clearing

You can delete the calibration data of pH to initialize this. Note that this operation is irreversible.

1. Press the SET key on the measurement screen, and press the ▲ or ▼ key to enter the maintenance screen.

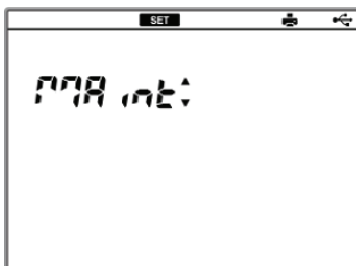

2. Press the ENTER key to enter the maintenance item selecting screen.



3. Press the ▲ or ▼ key to enter the calibration data clear screen.



4. Press the ENTER key to enter the measurement item screen.



5. Press the ENTER key to enter the calibration data deleting (Yes/No) screen.
(*Case of pH)

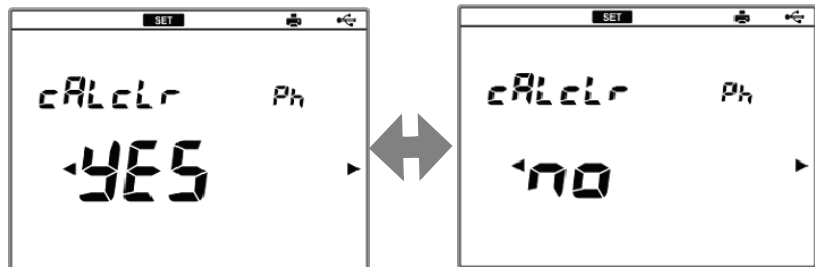

6. Press the ◀ or ▶ key to select Yes, and press ENTER key to delete the calibration data.
When the deletion is completed, "End" is displayed.

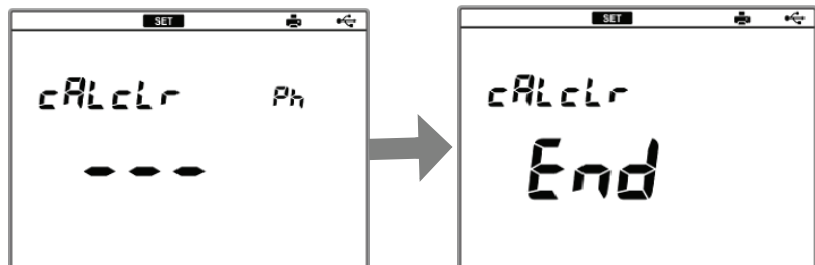

7. Press the ENTER key to return to the calibration data clear screen.

● Number of Memory Data Display

The number of memory data saved in the instrument is displayed. You can store up to 999 data.

1. Press the SET key on the measurement screen, and press the ▲ or ▼ key to enter the maintenance screen.

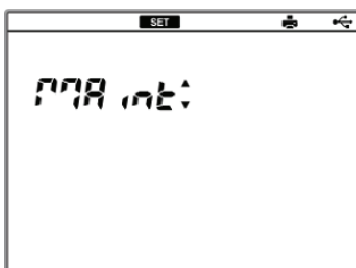

2. Press the ENTER key to enter the maintenance item selecting screen.



3. Press the ▲ or ▼ key to enter the number of memory data display screen.

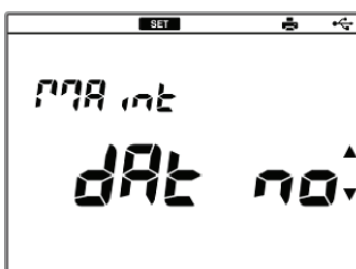

4. Press the ENTER key to display the number of the memory data currently saved in the instrument.



5. Press the ENTER key to return to the number of memory data display screen.

● Temperature Calibration

You can perform calibration of the temperature sensor of an electrode.

1. Press the SET key on the measurement screen, and press the ▲ or ▼ key to enter the maintenance screen.

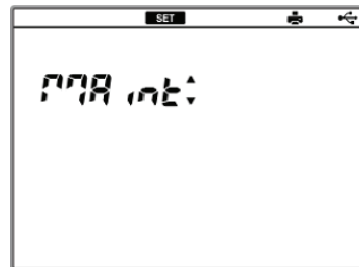

2. Press the ENTER key to enter the maintenance item selecting screen.



3. Press the ▲ or ▼ key to enter the temperature calibration screen.



4. Press the ENTER key to enter the temperature display value change screen.

5. Press the ◀ or ▶ key to select a digit and press the ▲ or ▼ key to change the value, and then press the ENTER key to return to the temperature calibration screen.



● Setting Initialization

The settings are initialized.

Refer to "5.2 Default Settings" P.77 for default settings.

1. Press the SET key on the measurement screen, and press the ▲ or ▼ key to enter the maintenance screen.

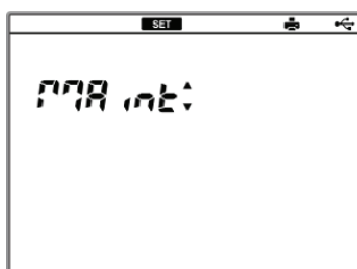

2. Press the ENTER key to enter the maintenance item selecting screen.

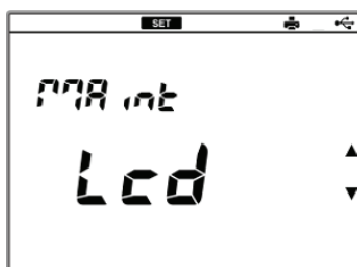

3. Press the ▲ or ▼ key to enter the initializing settings screen.



4. Press the ENTER key to enter the initializing settings (Yes/No) screen.

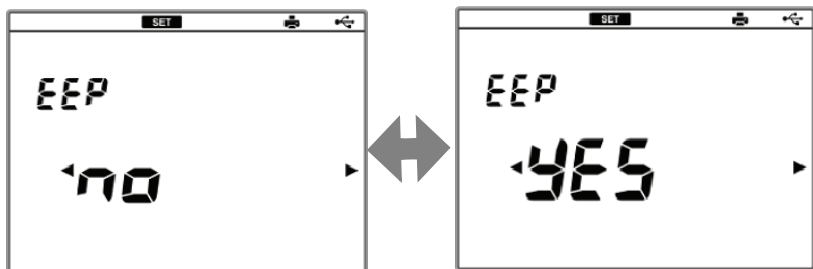

5. Press the ◀ or ▶ key to select Yes, and press ENTER key to initialize the settings.
The initializing is complete when "End" is displayed.

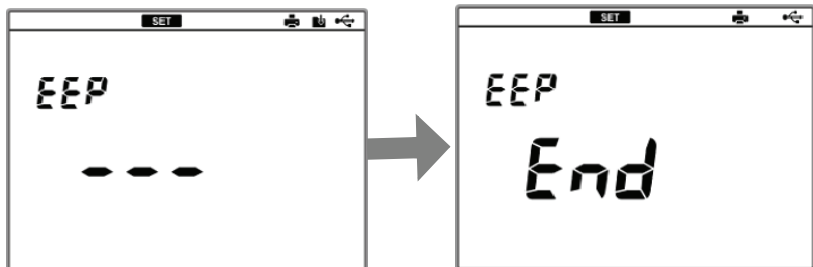

6. Press the ENTER key to return to the initializing settings screen.

● Password Setting

This function prevents an unauthorized person from tampering the date of measurement data, or operating accidentally to change settings, delete memory data, etc.

1. Press the SET key on the measurement screen, and press the ▲ or ▼ key to enter the maintenance screen.

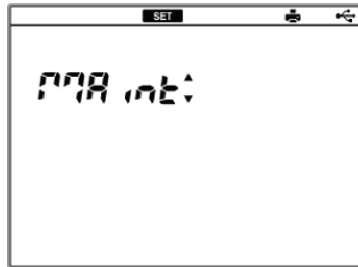

2. Press the ENTER key to enter the maintenance item selecting screen.



3. Press the ▲ or ▼ key to enter the password settings screen.



4. Press the ENTER key to enter the password change screen.

5. Press the ◀ or ▶ key to change ON or OFF, and press the ENTER key.

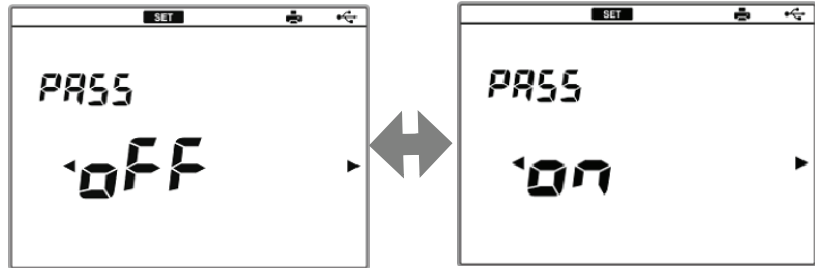

6. If you select ON, press the ◀ or ▶ key to select a digit and press the ▲ or ▼ key to change the value, and then press the ENTER key and press the ENTER key to return to the password change screen.

Setting range: 0000 to 9999



NOTE

If this setting is ON, password entry is required when you power ON the instrument. Enter the password and press the ENTER key.

If you forget the password, contact HORIBA sales representative.

3.3 Calibration

3.3.1 pH Calibration

Up to 5 points of pH calibration is possible.

● Repeatability Check of Calibration

After calibration is completed, immerse the electrode in the standard solution of pH7 and press the ENTER key to perform the repeatability check of calibration.

It is necessary to calibrate the standard solution of pH7 in NIST or USA of the standard solution setting. This operation is valid only once after calibration.

● Calibration with NIST Standard Solution

It is possible to calibrate pH2, pH4, pH7, pH9, and pH12 using NIST standard solutions.

In this manual, an example of 2 points calibration with the standard solutions of pH7 and pH4, which are used generally, is explained.

The calibration order is arbitrary. In this example, the procedures of calibration of pH7 are explained, and followed by ones of pH4, but you can perform calibration in an order as you like.

- 1.** Prepare the pH electrode. Wash the pH electrode with pure water (deionized), and wipe it off by filter paper or tissue paper.
- 2.** Open the filler port of the internal solution. During the calibration, the filler port should be kept open.
- 3.** Immerse the pH electrode in the standard solution of pH7 to calibrate the first point.

4. Press the CAL key to enter the NIST calibration screen.

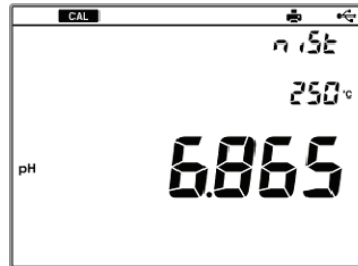

5. Wait for the instantaneous value to be stable and press the CAL key.
The HOLD indicator blinks until the reading stabilizes. When the reading stabilizes, the HOLD indicator lights up and the reading is held.



The **7** mark, which means that the pH7 calibration is completed, is displayed on the screen.

- To stop calibration.
Press the CAL key while the HOLD indicator blinks.
- To redo calibration.
Press the CAL key again after the HOLD indicator lights up.

6. Wash the pH electrode with pure water (deionized), and wipe it off by filter paper or tissue paper.
7. Immerse the pH electrode in the standard solution of pH4 to calibrate the second point.
8. Press the CAL key to display the instantaneous value. Wait for the instantaneous value to be stable and press the CAL key.

The HOLD indicator blinks until the reading stabilizes. When the reading stabilizes, the HOLD indicator lights up and the reading is held.

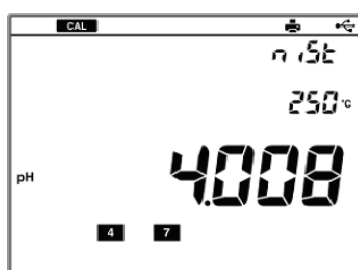

The **4** mark, which means that the pH4 calibration is completed, is displayed on the screen.



9. To perform repeatability check of the calibration, immerse the pH electrode in the standard solution of pH7 and press the Enter key twice.
The measurement value of the pH7 standard solution is displayed on the screen.
10. Press the MEAS key to return to the pH measurement mode.

NOTE

You can redo the calibration procedures of each standard solution while you are in the same calibration mode. But if you go back to the measurement mode once and return to the calibration mode again, redoing calibration will erase the previous set of calibration. You have to perform the entire calibration procedures from the beginning in this case.

Electrode status

You can check the electrode status after calibration.

Display	Description
 ,ERR No display	Good condition. Electrode sensitivity: 93% to 100%
 Blinks	Electrode sensitivity: 90% to 93% • Check that the standard solutions are correct. • Wash the electrode. " ● Washing electrodes" P.63
 Lights up	Electrode sensitivity: 85% to 90% " ● ERROR No.0005 Span calibration ERROR (pH)" P.67
ERROR No.0004	It is the asymmetry potential error. " ● ERROR No.0004 Zero calibration ERROR" P.66
ERROR No.0005	It is the sensitivity error. " ● ERROR No.0005 Span calibration ERROR (pH)" P.67

● Calibration with USA Standard Solution

It is possible to calibrate pH2, pH4, pH7, pH10, and pH12 using USA standard solutions.

In this manual, an example of 2 points calibration with the standard solutions of pH7 and pH4, which are used generally, is explained.

The calibration order is arbitrary. In this example, the procedures of calibration of pH7 are explained, and followed by ones of pH4, but you can perform calibration in an order as you like.

1. Prepare the pH electrode. Wash the pH electrode with pure water (deionized), and wipe it off by filter paper or tissue paper.

2. Open the filler port of the internal solution. During the calibration, the filler port should be kept open.
3. Immerse the pH electrode in the standard solution of pH7 to calibrate the first point.
4. Press the CAL key to enter the USA calibration screen.

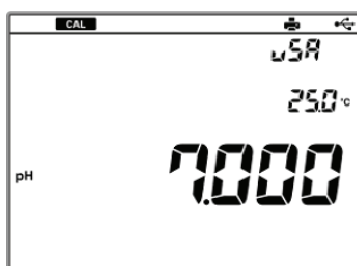

5. Check the stable indication value, and press the CAL key.

The HOLD indicator blinks until the reading stabilizes. When the reading stabilizes, the HOLD indicator lights up and the reading is held.

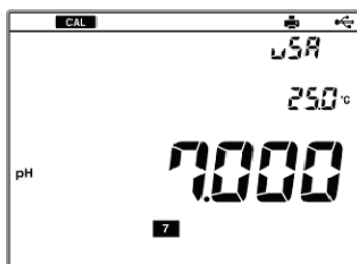

The **7** mark, which means that the pH7 calibration is completed, is displayed on the screen.

- To stop calibration:
Press the CAL key while the HOLD indicator blinks.
 - To redo calibration:
Press the CAL key again after the HOLD indicator lights up.
6. Wash the pH electrode with pure water (deionized), and wipe it off by filter paper or tissue paper.
 7. Immerse the pH electrode in the standard solution of pH4 to calibrate the second point.

8. Press the CAL key to display the instantaneous value. Wait for the instantaneous value to be stable and press the CAL key.

The HOLD indicator blinks until the reading stabilizes. When the reading stabilizes, the HOLD indicator lights up and the reading is held.

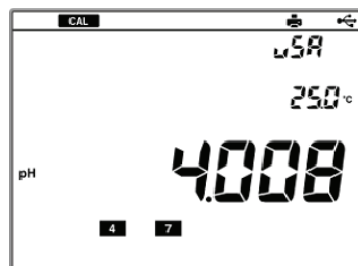

The **4** mark, which means that the pH4 calibration is completed, is displayed on the screen.

9. To perform repeatability check of the calibration, immerse the pH electrode in the standard solution of pH7 and press the Enter key twice.

The measurement value of the pH7 standard solution is displayed on the screen.



10. Press the MEAS key to return to the pH measurement mode.

NOTE

You can redo the calibration procedures of each standard solution while the calibration mode is continued. But if you go back to the measurement mode once and return to the calibration mode again, the calibration data are all cleared. You have to perform the entire calibration procedures from the beginning in this case.

Electrode status

You can check the electrode status after calibration.

Display	Description
 ,ERR No display	Good condition. Electrode sensitivity: 93% to 100%
 Blinks	Electrode sensitivity: 90% to 93% • Check that the standard solutions are correct. • Wash the electrode. " ● Washing electrodes" P.63
 Lights up	Electrode sensitivity: 85% to 90% " ● ERROR No.0005 Span calibration ERROR (pH)" P.67
ERROR No.0004	It is the asymmetry potential error. " ● ERROR No.0004 Zero calibration ERROR" P.66
ERROR No.0005	It is the sensitivity error. " ● ERROR No.0005 Span calibration ERROR (pH)" P.67

● Calibration with CUST Screen

Up to 5 points can be calibrated using performed using desired standard solutions.

1. Prepare the pH electrode. Wash the pH electrode with pure water (deionized), and wipe it off by filter paper or tissue paper.
2. Open the filler port of the internal solution. During the calibration, the filler port should be kept open.
3. Immerse the pH electrode in the desired standard solution to calibrate the first point.

4. Press the CAL key to enter the CUST calibration screen.



5. Press the ◀ or ▶ key to select digit and press the ▲ or ▼ key to change value, to set the value of the desired standard solution.
6. Check the stable indication value, and press the CAL key.

The HOLD indicator blinks until the reading stabilizes. When the reading stabilizes, the HOLD indicator lights up and the reading is held.

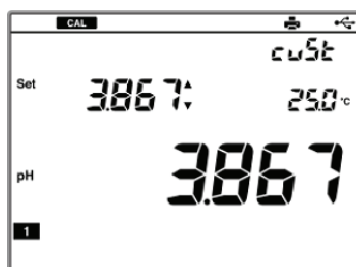

The **1** mark, which means that the first point calibration is completed, is displayed on the screen.

- To stop calibration:
Press the CAL key while the HOLD indicator blinks.
 - To redo calibration:
Press the CAL key again after the HOLD indicator lights up.
7. Wash the pH electrode with pure water (deionized), and wipe it off by filter paper or tissue paper.
 8. Immerse the pH electrode in the standard solution of pH4 to calibrate the second point.
 9. Press the ▲ or ▼ key to set the value of the random standard solution.

10. Press the CAL key to display the instantaneous value. Wait for the instantaneous value to be stable and press the CAL key.

The HOLD indicator blinks until the reading stabilizes. When the reading stabilizes, the HOLD indicator lights up and the reading is held.

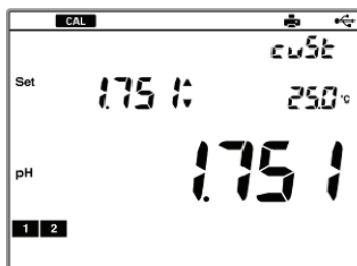

The **2** mark, which means that the second point calibration is completed, is displayed on the screen.

11. As for calibration of the third and later points, perform the calibration from the step 6.
12. When the calibration is completed, press the MEAS key to return to the measurement mode.

3.3.2 Calibration Value Printing

You can print out the data during calibration HOLD or calibration error.

1. Check the printer settings and that the printer is connected correctly. (Refer to "3.1.4 Connecting and Setting the Printer" P.12.)
2. Press the DATA key during calibration HOLD or calibration error. The currently displayed data is printed out. Printing examples are shown below.

● Printing at pH calibration

Inst. model :F-71	①	<ul style="list-style-type: none">① Instrument model② Serial number③ Electrode status④ Asymmetry potential⑤ Sensitivity⑥ Calibration data
Inst. SN :123456789	②	
Elect. status :OK	③	
Offset : -0.1mV	④	
Sensitivity pH 4.008- 6.865 :100.0%	⑤	
Calibration data Date :2011/03/21 Time :20:13 pH 4.008 : 176.9mV 25.0°C MTC pH 6.865 : 7.9mV 25.0°C MTC	⑥	

3.4 Measurement

3.4.1 Measurement Value Hold

The instrument can hold the measurement value automatically when it judges that the value is stable. Press the MEAS key when the instantaneous value is displayed in the instantaneous measurement, and the HOLD indicator blinks. Then, when the value is stable, the HOLD indicator lights up and the value is held. To cancel the HOLD state or to stop the stability judgment (HOLD blinking), press the MEAS key again.

● Stabilization Criteria

pH measurement:

pH change in 10 seconds: within ± 0.017 pH
(converted to 25°C)

ORP and ion measurements:

Potential change in 10 seconds: within ± 1 mV

Temperature measurement:

Temperature change in 10 seconds: within ± 2 °C

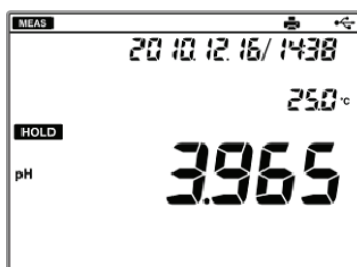

3.4.2 Measurement Items Changing

When the MODE key is pressed, measurement item can be changed in the channel where ACT is lit.

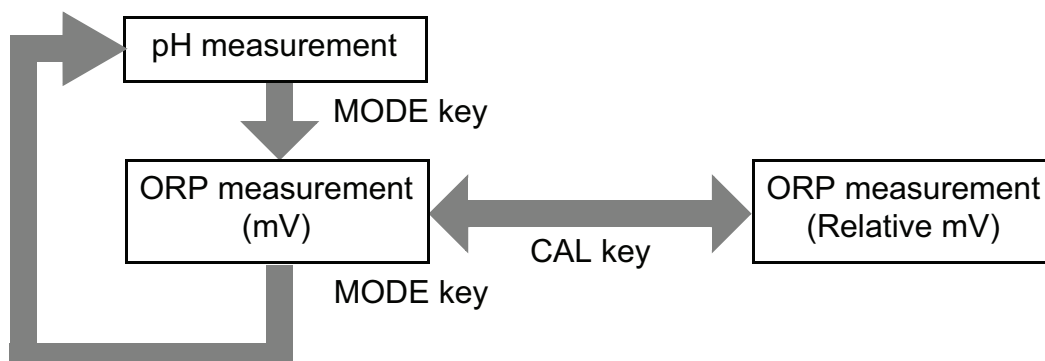

3.4.3 Auto Data Memory

The instrument can perform data memory automatically at a regular interval. Refer to "3.2.3 Auto Data Memory Setting" P.18 for the setting operations.

If the auto power off setting is ON, it is temporarily OFF while this function is active.

1. After the interval setting is completed, press the MEAS key to return to the measurement screen. "Auto LOG" is displayed on the screen.

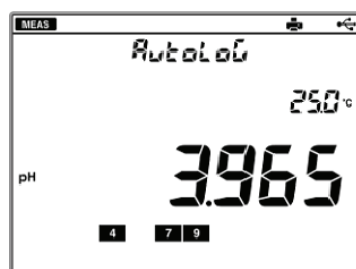

2. Press the ENTER key. "Auto LOGGING" is displayed on the screen, and the auto data memory function starts.

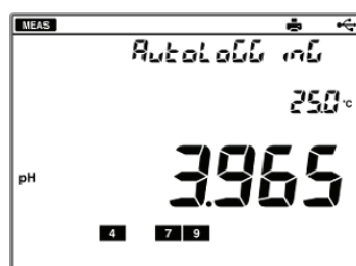

3. To stop the auto data memory, press the ENTER key.

NOTE

-
- Do not power ON/OFF while the auto data memory function works.
It may damage the reliability of the memory data.
 - Only the POWER, ENTER, and the ▲ or ▼ keys are possible while the auto data memory function works.
 - The actual date of memory may have the difference of ± 1 second from the time calculated based on the interval setting.
 - When the number of memory data exceeds 999, data memory is stopped and ERROR No.0010 is displayed.
-

3.4.4 Measurement Value Printing

You can print out measurement values or the HOLD value.

When the automatic printout setting is ON, automatic printout is executed at the following occasions.

- You perform data memory during measurement.
 - Calibration or check is completed in the calibration mode.
1. Check that the printer settings and connection are correctly. (Refer to "3.1.4 Connecting and Setting the Printer" P.12.)
 2. Press the ► key in the measurement mode or HOLD state. The currently displayed measurement value is printed out. Printing examples are shown below.

● pH measurement mode

Date	:2011/03/21	
Time	:19:43	
pH	: 7.254	
HOLD	:INST	①
Temperature	:	
	25.0°C MTC	②
Sample	:0000	③
Inst. model	:F-71	④
Inst. SN	:123456789	⑤
Elect. status	:OK	⑥
Offset	: -14.4mV	⑦
Sensitivity		
pH 4.008- 6.864		⑧
: 99.2%		
pH 6.864- 9.175		
: 99.0%		

- ① HOLD condition
At HOLD: AUTO
Instant value: INST
- ② Temperature compensation setting
At Manual mode: MTC
At Auto mode: ATC
- ③ Sample ID
- ④ Instrument model
- ⑤ Serial number
- ⑥ Electrode status
- ⑦ Asymmetry potential
- ⑧ Sensitivity

● mV measurement mode

Date	:2011/03/10	
Time	:18:35	
mV ABS	: 1000.2mV	①
HOLD	:AUTO	②
Temperature	:	
	25.0°C MTC	③
Sample	:0007	④
Inst. model	:F-71	⑤
Inst. SN	:123456789	⑥

- ① mV status
Absolute mV: ABS
Relative mV: REL
- ② HOLD condition
At HOLD: AUTO
Instant value: INST
- ③ Temperature compensation setting
At Manual mode: MTC
At Auto mode: ATC
- ④ Sample ID
- ⑤ Instrument model
- ⑥ Serial number

3.5 Data Operation

3.5.1 Data Memory of Measurement Value

Measurement data can be stored into the instrument memory.

Refer to "3.4.3 Auto Data Memory" P.49 for automatic data memory.

1. Press the DATA key to enter the data operation screen.



2. Press the ENTER key to enter the data memory screen.

The measurement value and "IN" are alternately displayed.

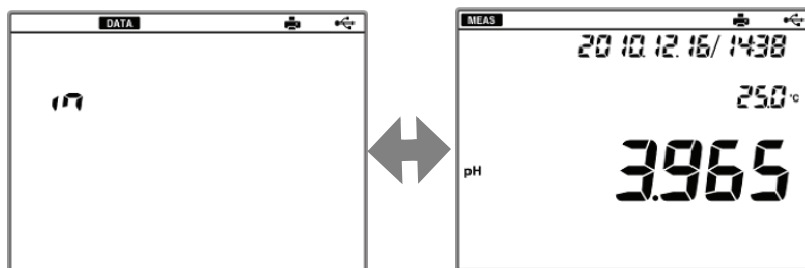

3. Press the ENTER key.
The measurement data is stored into the memory.

3.5.2 Memory Data Display

The memory data can be displayed on the screen.

1. Press the DATA key to enter the data operation mode.



2. Press the ▲ or ▼ key to enter the memory data display screen.



3. The latest data is displayed.

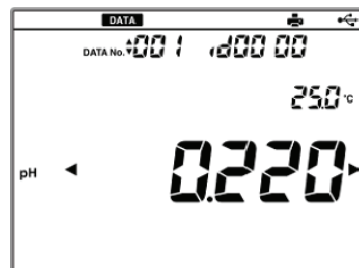

4. Press the ◀ or ▶ key to switch between date display and DATA No/ID No. display. Press the ▲ or ▼ key to search past data.

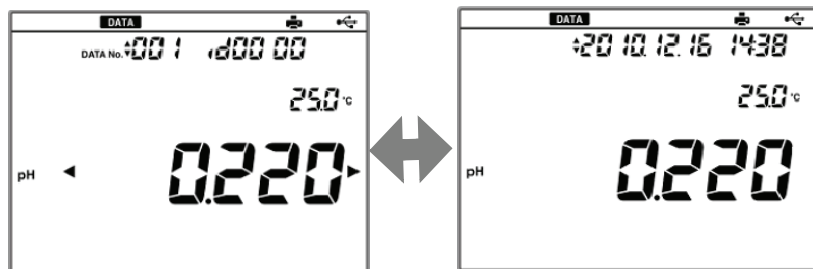

3.5.3 Memory Data Printing

The memory data can be printed out.

1. Display the memory data referring to "3.5.2 Memory Data Display" P.53.
2. Press the ENTER key.

The displayed measurement data is printed out.

● pH measurement mode

Memory Num :013	①
Date :2011/03/10	
Time :18:06	
Sample :0007	②
pH : 6.732	
HOLD :AUTO	③
Temperature :	
25.0°C MTC	④
Inst. model :F-71	
Inst. SN :123456789	
Elect. status :OK	⑤

- ① Memory number
- ② Sample ID
- ③ HOLD condition
At HOLD: AUTO
Instant value: INST
- ④ Temperature compensation setting
At Manual mode: MTC
At Auto mode: ATC
- ⑤ Electrode status

● mV measurement mode

Memory Num :014	①
Date :2011/03/10	
Time :18:36	
Sample :0007	②
mV ABS : 1000.2mV	③
HOLD :AUTO	④
Temperature :	
25.0°C MTC	⑤
Inst. model :F-71	
Inst. SN :123456789	

- ① Memory number
- ② Sample ID
- ③ mV state
Absolute mV: ABS
Relative mV: REL
- ④ HOLD condition
At HOLD: AUTO
Instant value: INST
- ⑤ Temperature compensation setting
At Manual mode: MTC
At Auto mode: ATC

3.5.4 Calibration History Display

● pH calibration history display

1. Press the DATA key to enter the data operation screen.



2. Press the ▲ or ▼ key to enter the calibration history display screen.



3. Press the ENTER key.
The asymmetry potential of the latest calibration data is displayed.



4. Press the ◀ or ▶ key to display the sensitivity and the data of the third point or later.

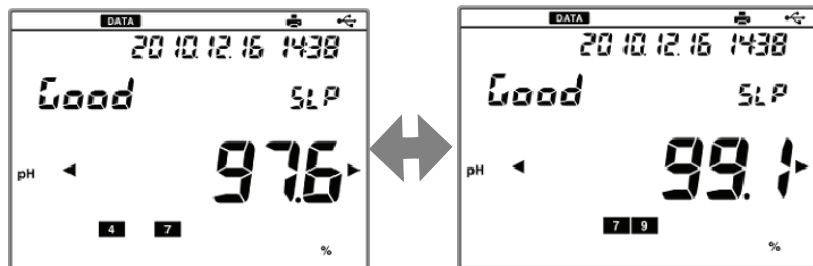

NOTE

When the electrode sensitivity is 90% to 93%, "Check" is displayed instead of "Good". When the sensitivity is 85% to 90%, "bAd" is displayed.
Refer to " Electrode status" P.41.

3.5.5 Calibration History Printing

The calibration history can be printed out for each measurement item.

1. Check the printer settings and that the printer is connected correctly. (Refer to "3.1.4 Connecting and Setting the Printer" P.12.)
2. Refer to "3.5.4 Calibration History Display" P.55 to display the calibration history.
3. Press the ENTER key.

The displayed measurement data is printed out.

● pH check data (without check data)

Inst. model :F-71	①	① Instrument model
Inst. SN :123456789	②	② Serial number
Elect. status :OK	③	③ Electrode status
Offset : 0.4mV	④	④ Asymmetry potential
Sensitivity pH 4.008- 6.865 :100.0%	⑤	⑤ Sensitivity
pH 6.865- 9.180 : 93.4%		
Calibration data Date :2011/03/10 Time :18:56 pH 4.008 : 177.0mV 25.0°C MTC	⑥	⑥ Calibration data
pH 6.865 : 7.9mV 25.0°C MTC		
pH 9.180 : -120.0mV 25.0°C MTC		

● pH calibration history (with check data)

<p>Inst. model :F-71</p> <p>Inst. SN :123456789</p> <p>Elect. state :OK</p> <p>Offset : 0.4mV</p> <p>Sensitivity</p> <p>pH 4.008- 6.865 :100.0%</p> <p>pH 6.865- 9.180 : 93.4%</p> <p>Repeatability:Good(0) 0.000</p> <p>Calibration data</p> <p>Date :2011/03/10</p> <p>Time :18:56</p> <p>pH 4.008 : 177.0mV 25.0°C MTC</p> <p>pH 6.865 : 7.9mV 25.0°C MTC</p> <p>pH 9.180 : -120.0mV 25.0°C MTC</p> <p>Inspection before use</p> <p>pH 6.852 : -5.5mV 25.0°C MTC</p>	<p>①</p> <p>②</p> <p>③</p> <p>④</p> <p>⑤</p> <p>⑥</p> <p>⑦</p>	<p>① Instrument model</p> <p>② Serial number</p> <p>③ Electrode status</p> <p>④ Asymmetry potential</p> <p>⑤ Sensitivity</p> <p>⑥ Check value of repeatability</p> <p>⑦ Calibration data</p>
---	--	--

3.5.6 pH Check History Display

The pH check history can be printed out.

● Repeatability Check of Calibration

After calibration is completed, immerse the electrode in the standard solution of pH7 and press the ENTER key to perform the repeatability check of calibration.

It is necessary to calibrate the standard solution of pH7 in NIST or USA of the standard solution setting. This operation is valid only once after calibration.

● Calibration Repeatability check

1. Press the DATA key to enter the data operation screen.



2. Press the ▲ or ▼ key to enter the pH check history display screen.



3. Press the ENTER key.
The repeatability of the latest check data is displayed.



3.5.7 pH Check Data Printing

The pH check history can be printed out.

1. Check that the printer settings and that the is connection are correctly. (Refer to "3.1.4 Connecting and Setting the Printer" P.12.)
2. Display the memory data referring to "3.5.6 pH Check History Display" P.58.
3. Press the ENTER key.

The displayed measurement data is printed out.

Inst. model :F-71	①	① Instrument model
Inst. SN :123456789	②	② Serial number
Calibration data		
Date :2011/03/10		
Time :18:18		
Inspection befoure use		
Repeatability:Good(0)		
0.000	③	③ Check value of repeatability
pH 6.866 : 7.8mV		
25.0°C MTC	④	④ Temperature compensation setting At Manual mode: MTC At Auto mode: ATC.

Chapter 4 Maintenance and Troubleshooting

This chapter explains the daily maintenance operations and error messages.

Daily maintenance is vital in assuring accurate measurement and preventing breakage from occurring. If electrode maintenance is neglected, it may cause various problems and erroneous measurements. This instrument is equipped with a convenient error message function. If an error message appears, be sure to take appropriate countermeasures.

4.1 pH (ORP) Electrode Maintenance

Maintain the electrodes by referring to the following information or to the operation manuals of the electrodes.



CAUTION



Broken glass

Broken glass may cause injury.
The outer tube and tip of an electrode are made of glass.
Handle them with care.



As an example, the maintenance operations of pH electrodes (9615-10D) are described below.

Maintain ORP electrodes in the same manner.

● Maintenance after daily use

After making measurements, wash the electrode using pure water (deionized water), wipe off water from the electrode with filter or tissue paper, and store it with its cap placed on.

● Long-term storage

 CAUTION	
	Harmful chemicals The internal solution of an electrodes is highly concentrated potassium chloride (3.33 mol/L KCl). If the internal solution comes in contact with the skin, wash it off immediately. If it gets into eyes, flush with plenty of water and then consult a doctor.

When an electrode is not to be used for a long period of time, store it after performing the following procedure. Also, exchange the internal solution every 3 to 6 months, using the steps explained below.

1. Disconnect the electrode from the instrument.
2. Detach the protective cap from the electrode.

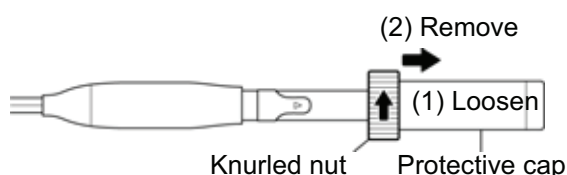

3. Open the internal solution filler port, then use a dropper to remove the internal solution.

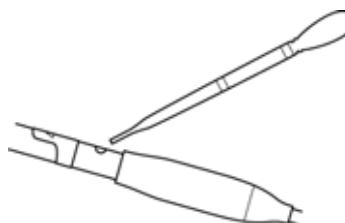

4. Fill the electrode with new internal solution (model 300), until it nearly reaches the filler port.

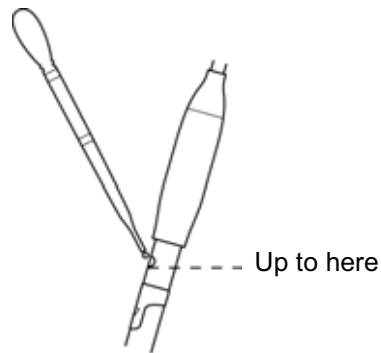

5. Wash the tip of the electrode well with pure water (deionized) and wipe it with filter or tissue paper.



6. If the inside of the protective cap is dry, wash the inside with pure water (deionized). After shaking out the water, fill the cap with enough pure water (deionized) to soak the sponge.

NOTE

If the inside of the protective cap of an electrode dries out and the electrode is not used for a long period of time, the response speed of the electrode may slow and its sensitivity may decrease.

● Washing electrodes

If the tip of the pH electrode is extremely dirty, response speed may become slow and it may cause errors in measurement value.

If the electrode is so dirty that it cannot be cleaned by rinsing with pure water (deionized), wash the electrode using the methods below depending the dirt.

General dirt & oily grime

Wipe the dirt/grime off using cotton gauze absorbed with neutral detergent.



Inorganic grime

Rinse the tip using a hydrochloric acid solution of approximately 1 mol/L or a wash solution (model 220). Be sure not to soak the electrode in strong acid for a long period of time.



4.2 Troubleshooting

This instrument is equipped with a simple error-message function to notify the operator that an operation error or problem with the equipment has occurred. Errors or other problems that occur in the measurement mode are announced by an "ERROR No." appearing in the upper lefthand corner of the screen.

4.2.1 Error Message Chart

ERROR No.	Message	Definition
0001	Memory ERROR	Data cannot be read from or written to the internal memory.
0003	Unstable reading ERROR	The electric potential does not stabilize within three minutes.
0004	Zero calibration ERROR	The asymmetry potential of the electrode is outside the range of ± 45 mV.
0005	Span calibration ERROR	pH: The electrode sensitivity is not within the range from 85% to 105% for the theoretical sensitivity. ION: the slope is inverse.
0007	Buffer uncertain	The standard solution can not be identified automatically.
0008	Please calibrate	The actual calibration interval exceeds the calibration cycle setting.
0009	Printer communication ERROR	There is a problem with the printer communication.
0010	Data memory over	The number of the memory data exceeds the limit of the memory.
000E	Key operation ERROR	Key operation is invalid.

● ERROR No.0001 Memory ERROR

Definition

Data cannot be read from or written to the internal memory.

Cause	Countermeasure
The instrument does not start properly due to noise or other at power ON.	Disconnect and reconnect the AC adapter, and press the ON/OFF key 10 seconds later. If the same error occurs again after the countermeasure is performed, contact HORIBA sales representative.
The internal IC is defective.	Contact HORIBA sales representative.

● ERROR No.0003 Unstable reading ERROR

Definition

The electric potential does not stabilize within three minutes.

Cause	Countermeasure
This is caused by the effect of the sample solution The sample solution is pure water or other solution with low conductivity, or the pH concentration or temperature change.	Press the MEAS key again while "HOLD" blinks or lights up, to measure the sample using instantaneous value measurement.
The electrode is dirty.	Wash the electrode.
The electrode is cracked.	Replace the electrode.
The responsive glass membrane of the electrode has been dry for a long time.	Soak the membrane (on the electrode) in pure water (deionized) for 24 hours.

Cause	Countermeasure
The temperature of the sample solution is fluctuating.	Measure after the sample solution temperature stabilizes.

● ERROR No.0004 Zero calibration ERROR

Definition

The asymmetry potential of the electrode is outside the range of ± 45 mV.

Cause	Countermeasure
The electrode is dirty.	Wash the electrode.
The electrode is cracked.	Replace the electrode.
The standard solution concentration is fluctuating.	Replace the internal solution in the reference electrode.
The electrode is not connected correctly.	Connect the electrode correctly.
Electrode is not submerged deeply enough to cover reference junction.	Immerse the electrode in the sample, to at least 3 cm beyond the electrode tip.
There is problem with the standard buffers.	Use new standard solution.

● **ERROR No.0005 Span calibration ERROR (pH)**

Definition

The electrode sensitivity is not within the range from 85% to 105% for the theoretical sensitivity.

Cause	Countermeasure
The electrode is dirty.	Wash the electrode.
The electrode is cracked.	Replace the electrode.
Calibration was not performed correctly.	Redo the calibration correctly.
There is a problem with the standard solution.	Prepare new standard solutions.
The electrode is not connected correctly.	Connect the electrode correctly.
Electrode is not submerged deeply enough to cover reference junction.	Immerse the electrode in the sample, to at least 3 cm beyond the electrode tip.

● ERROR No.0007 Buffer uncertain

Definition

The standard solution can not be identified automatically. After performing the countermeasures below, perform calibration again from the beginning.

Cause	Countermeasure
There is a problem with the standard solution.	Prepare new standard solution.
There is a problem with the standard solution setting.	Match the regulation type (NIST, USA) of standard solutions between the settings and the actuals.
The responsive membrane is dry or dirty.	Measure after cleaning the responsive membrane and soaking it in pure water for 24 hours.
Reference internal solution is poor or dirty.	Replace the internal solution with new solution.
The responsive membrane is damaged or worn out.	Replace the electrode.

● ERROR No.0008 Please calibrate

Definition

The actual calibration interval exceeds the calibration cycle setting.

Cause	Countermeasure
It exceeds setting days of the calibration cycle.	Perform calibration.

● ERROR No.0009 Printer communication ERROR

Definition

There is a problem with the printer communication.

Power OFF the instrument and perform the countermeasures below, and then power ON again.

Cause	Countermeasure
There is a problem with the printer unit connection.	Check the printer connection, and connect the instrument and printer again.
The printer is defective.	Replace the printer. If the same error occurs again after the countermeasure is performed, contact HORIBA sales representative.

● ERROR No.0010 Data memory over

Definition

The number of the memory data exceeds the limit of the memory.

Cause	Countermeasure
Memory over	Check the contents of the memory data, and delete unnecessary data.

● ERROR No.000E Key operation ERROR

Definition

Key operation is invalid.

Cause	Countermeasure
Loose connection or breaking of keys	Disconnect and reconnect the AC adapter, and press the ON/OFF key 10 seconds later. If the same error occurs again after the countermeasure is performed, contact HORIBA sales representative.

4.2.2 More Troubleshooting

This section describes the countermeasures for the troubles that are not indicated by ERROR messages.

● The indicated value fluctuates

When there is a problem with the electrode.

Cause	Countermeasure
The responsive membrane is dry or dirty.	Wash the responsive membrane.
The responsive membrane is damaged or worn out.	Replace the electrode.
There are air bubbles on the electrode.	Shake the electrode to remove the air bubbles.
There is no standard solution remaining.	Fill the electrode with new standard solution, as noted in the operation manual of the electrode.
The wrong standard solution is being used.	Use the correct standard solution.

When there is a problem with the instrument

Cause	Countermeasure
There is a motor or other device causing electrical interference.	Measure at a place where no influence from induction is given. Ground all AC-powered equipment
The electrode is not connected correctly.	Connect the electrode correctly.

When there is a problem in the sample

Cause	Countermeasure
The liquid junction is not immersed in the sample solution.	Immerse the electrode in the sample solution up until the liquid junction.
Caused by the effects of the sample.	Judge by measuring with a stable standard solution. Contact HORIBA sales representative.

● **The response is slow.**

Cause	Countermeasure
Caused by the effects of the sample.	Response time may slow down, depending on the properties of the sample solution. Contact HORIBA sales representative.
Wash the responsive membrane.	Wash the responsive membrane.
The responsive membrane is damaged or worn out.	Replace the electrode.
There is a problem with the standard solution.	Fill the electrode with new standard solution, as noted in the operation manual of the electrode.

● **The indicated value does not change/No response.**

Cause	Countermeasure
Key operation is invalid.	Disconnect and reconnect the AC adapter, and press the ON/OFF key 10 seconds later. If the same error occurs again, seek repairs at contact HORIBA sales representative.
The electrode connector is not attached correctly.	Turn the power OFF, then turn it back ON again.
The electrode is defective. (The responsive membrane is cracked.)	Replace the electrode.
The pH meter is defective.	Contact HORIBA sales representative.

● **The details when the AC adapter is disconnected.**

Cause	Countermeasure
No lithium battery is set.	Set the lithium battery (CR2032).
The lithium battery runs down.	Replace the lithium battery (CR2032).

NOTE

Refer to " ● Date Setting" P.27, and set date and time.

Lithium battery replacement

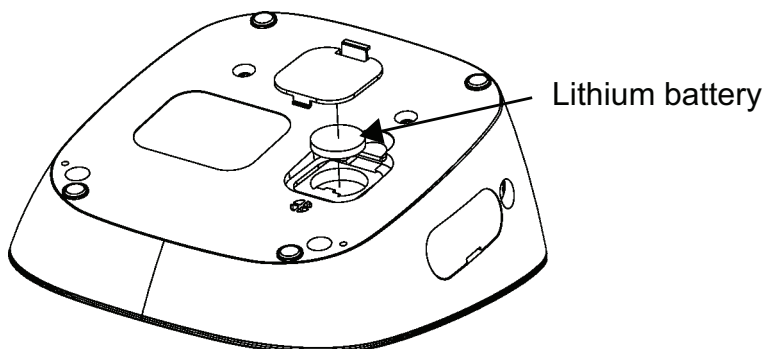

● **The measured value is blinks.**

- The pH value is outside the measurement range (when pH value is displayed).

Measurement range: pH0.000 to pH14.000

- The mV value is outside the display range (when mV value is displayed).

Display range: ± 1999.9 mV

Cause	Countermeasure
The sample is inappropriate.	Use a sample within the measurement range.
The liquid junction is not immersed in the sample.	Immerse the electrode up to 3 cm from its tip.
The electrode cable is broken.	Replace the electrode.
The instrument is defective.	Perform the check operation mentioned below.
Calibration is unperformed or incorrect.	Perform calibration correctly.

Check operation

pH, mV

Short the connector for the electrode on the instrument between the center pin and outer metal.

If the measurement value stops blinking in this state, the instrument is normal.

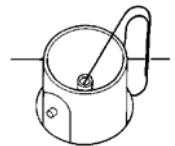

● **The temperature display blinks.**
The temperature display is fixed at 25°C.

The temperature measurement value is outside the measurement range.

Measurement range: -30°C to 130°C

Cause	Countermeasure
The temperature of the sample is outside display range.	Check the sample temperature. Adjust it within the measurement range.
The internal thermistor connection of the electrode is broken or shorted.	Check the resistance of the temperature sensor connector. If it is 50 kΩ or more at room temperature, replace the electrode.
The connection of the temperature connector is failed.	Insert the temperature connector firmly.
The instrument is defective.	Contact HORIBA sales representative.
The settings of the temperature calibration is failed.	Initialize the settings referring to " ● Setting Initialization" P.34.

● **Measurements are not repeatable.**

Cause	Countermeasure
The effects of the sample.	The pH or other properties of the sample solution may have changed over time, making poor repeatability.
The responsive membrane is dry or dirty.	Wash the responsive membrane.
The internal solution of the electrode runs out or contaminated.	Replace the internal solution with new one.
The responsive membrane is cracked or worn out.	Replace the electrode.

● **Printout is not made even when a printer is connected.**

Check the following points.

- Is the printer turned ON?
- Is an error occurred in printer?
- Is the printing paper run out or clogged?
- When the test print is made according to the manual, is it done correctly?
- Is the test print done correctly when it is made according to the manual?

Chapter 5 specifications

5.1 Specifications

● Measuring object

Measuring object	Item	Description	F-71
pH	Measuring principle	Glass electrode	√
	Display range	pH-2.000 to pH19.999	√
	Measuring range	pH0.000 to pH14.000	√
	Display resolution	0.001 pH	√
	Repeatability	±0.005 pH ±1 digit	√
Temperature	Measuring principle	Thermistor method	√
	Measuring range	0.0°C to 100.0°C	√
	Display resolution	0.1°C	√
	Repeatability	±0.1°C ±1 digit	√
mV	Measuring range	±1999.9 mV	√
	Display resolution	0.1 mV	√
	Repeatability	±0.1 mV ±1 digit	√

● Functions

Item	F-71
PC USB interface	√
Memory number	999
Calibration points	5
Password setting	√
Printer connection	√

5.2 Default Settings

Item	Description	Default value
Common settings	Temperature compensation	Automatic temperature compensation (ATC)
	Manual temperature compensation value	25°C
	Auto power off	OFF
	Sample ID	0000
	Calibration interval	OFF
	Password	OFF
	Auto data memory	OFF
	Auto print	OFF
pH	Calibration standard solution	NIST
	Default value before calibration	Asymmetric potential: 0 mV Sensitivity: 100%

5.3 Options

This section lists spare and optional parts for the instrument. These parts are possible through HORIBA sales representative. Place an order specifying their names, and part numbers.

Part name		Part number	Remarks
AC adapter for	AC adapter, Cable (UL, 120 V)	3014031951	
	AC adapter, Cable (EU, 230 V)	3014031952	
Plain paper printer	Printer (USA 120 V)	3014030146	
	Printer (EU, 230 V)	3014030147	
	Printer cable	3014030148	
	Roll paper	3014030149	
	Ink ribbon	3014030150	
Serial cable		3014030151	
USB cable		3200373941	
Electrode stand (Standard type)		3200382557	
Electrode stand (Long type)		3200382560	
Stand arm		3200373991	
Sensor holder		3200373961	
X-51 Digital Simulator		—	For pH, mV, ION, DO
X-52 Digital Simulator		—	For COND

For any question regarding this product,
please contact your local agency,
or inquire from the Customer Registration website
(<http://www.horiba.com/register>)

HORIBA, Ltd.

1st edition: September 2011
CODE: GZ0000260893

裏表紙は別途デザインの表紙とする