



Manual

EE355
Dew Point Transmitter
down to -60 °C Td

YOUR PARTNER IN SENSOR TECHNOLOGY



ELEKTRONIK®
Ges.m.b.H.

E+E Elektronik® Ges.m.b.H. doesn't accept warranty and liability claims neither upon this publication nor in case of improper treatment of the described products.

The document may contain technical inaccuracies and typographical errors. The content will be revised on a regular basis. These changes will be implemented in later versions. The described products can be improved and changed at any time without prior notice.

USA

FCC notice:

This equipment has been tested and found to comply with the limits for a Class B digital device, pursuant to part 15 of the FCC Rules. These limits are designed to provide reasonable protection against harmful interference in a residential installation. This equipment generates, uses and can radiate radio frequency energy and, if not installed and used in accordance with the installation manual, may cause harmful interference to radio communications. However, there is no guarantee that interference will not occur in a particular installation. If this equipment does cause harmful interference to radio or television reception, which can be determined by turning the equipment off and on, the user is encouraged to try to correct the interference by one or more of the following measures:

- Reorient or relocate the receiving antenna.
- Increase the separation between the equipment and receiver.
- Connect the equipment into an outlet on a circuit different from that to which the receiver is connected.
- Consult the dealer or an experienced radio/TV technician for help.

CANADIAN

ICES-003 Issue 5:

CAN ICES-3 B / NMB-3 B

TABLE OF CONTENT

1	General	4
1.1	Symbol Clarification.....	4
1.2	Safety Instructions.....	4
1.2.1	Intended Use.....	4
1.2.2	Installation, start up and control	5
1.3	Environmental aspects	6
2	Product description	6
2.1	General.....	6
2.2	Dimensions in mm (inch).....	6
2.3	Autocalibration.....	7
2.4	Measurement range and Accuracy.....	7
3	Installation	7
3.1	Installation location.....	7
3.2	Installing directly into the process	8
3.3	Installing the probe in a sampling system	8
3.3.1	Basic sampling cell.....	9
3.3.2	Sampling cell with quick connector	9
4	Electrical Connection	10
4.1	Connecting cable - Accessory HA0108xx	10
5	Setup and Adjustment	10
5.1	Dew point adjustment by the user	10
6	Modbus RTU	11
6.1	Data Transmission.....	11
6.2	Modbus Map.....	11
7	Maintenance	12
7.1	Filter replacement.....	12
7.2	Sensor cleaning.....	12
8	Accessories	13
8.1	Scope of Supply	13
9	Technical Data	13

1 General

This manual is a part of the scope of supply and serves to ensure optimal operation and functioning of the equipment.

For this reason, the manual must be read before start-up.

Furthermore, it is necessary that this manual is read and understood by those responsible for the handling, installation, and maintenance of the equipment.

This manual may not be used for competitive purposes or passed on to third parties without the written consent of E+E Elektronik® Ges.m.b.H.

It is permitted to make copies for personal use.

All information, technical data and illustrations contained in these instructions are based on information available at the time of publication.

1.1 Symbol Clarification



This symbol indicates safety instructions.

The safety instructions have to be carried out unconditionally. If disregarded loss, injury, or damage may be inflicted to people or property. In any case E+E Elektronik® Ges.m.b.H. cannot be held responsible.



This symbol indicates attention.

The note should be observed to achieve an optimal functioning of the equipment.

1.2 Safety Instructions

1.2.1 Intended Use

The dew point transmitter is intended to be used for the measurement of air (compressed air) and other non-corrosive and non-flameable gasses only.

The EE355 can be installed in a pressurized system up to 80 bar (1160 psi).

Mounting, electrical installation, putting into operation and maintenance should be done by qualified personnel only.

The use of the EE355 in any other way than described in this manual bears a safety risk for people and the entire measurement installation and is therefore not allowed.

The manufacturer cannot be held responsible for damages as a result of incorrect handling, installation, and maintenance of the equipment.

To avoid health risks or damage to the equipment, the installation should not be operated on with tools, which are not specifically mentioned or described in this manual.

Excessive mechanical stress and inappropriate handling must be avoided.

The dew point transmitter can only be utilized in accordance with the conditions defined in the technical data. Otherwise, inaccuracies of the measurement will occur and equipment failures cannot be ruled out.

For the safety of user and for functionality of the equipment the, by the manufacturer recommended steps to put into operation, to test and to maintain should be taken and completed.

Unauthorized modifications of the product lead to loss of all warranty claims. This may be accomplished only with an explicit permission of E+E Elektronik®!

The device is constructed for the operation of separated extra-low voltage (SELV).

1.2.2 Installation, start up and control

The dew point transmitter is designed and built in accordance with the latest state in technology, tested adequately and has been shipped from the factory in good order and condition.

As a user, you are responsible to comply with all applicable safety regulations amongst others:

- Instruction for installation
- Local standards and codes

The manufacturer has taken all actions to assure safe operation. The user has to make sure that the equipment is positioned and installed in such a way that safe operation is not impaired.

The equipment is factory tested and shipped in good order and condition.

This manual contains information and notes of caution, which have to be followed by the user to assure safe operation.

Mounting, electrical installation, putting into operation and maintenance should only be done by qualified personnel. The plant operator should authorize qualified personnel to operate on the installation.

These professionals must have read and understood this and they have to follow the instructions as detailed in this manual.

Check all connections of the entire installation thoroughly, before putting the system into operation.

Do not put a damaged product into operation and make sure this does not happen inadvertently.

A malfunction of the equipment should only be handled and fixed by authorized and qualified personnel.

If it is not possible to repair the malfunction, take the equipment out of operation and make sure that it cannot be put back into operation again.

Repairs not described in this manual may only be carried out by the manufacturer or by the respective service organization.

Disclaimer of Liability

The manufacturer or their delegated representative is only liable in case of intend or gross negligence. The accountability is limited to the value of the order issued at the time to the manufacturer.

The manufacturer is not liable for damages, originated from disregarding the safety instructions or violating the instructions of the manual or operating conditions. Consequential damages are excluded from the any liability.

1.3 Environmental aspects



Products from E+E Elektronik® are developed and designed due to consideration of the importance of environmental protection. Therefore, disposal of the product also should not lead to pollution of the environment.



Single-variety components must be separated before the transmitter is disposed of. The electronic components must be collected and as electronic scrap properly disposed of.

2 Product description

2.1 General

The compact EE355 Dew Point Transmitter with a measuring range down to $-60\text{ }^{\circ}\text{C Td}$ and an robust stainless steel housing is ideal for OEM applications in compressed air systems, plastic dryers and industrial drying processes. The core of the EE355 is the monolithic measurement cell type HMC200, manufactured in thin-film technology. Due to the excellent long term stability and durability against condensation the EE355 has low maintenance needs.

An integrated auto-calibration procedure permits a measurement accuracy of $<2\text{ }^{\circ}\text{C Td}$. The recommended calibration interval is 2 Years.

The measured values for dew point, frost point or ppm volume concentration are available on an analog 4-20 mA and a digital Modbus RTU output.

2.2 Dimensions in mm (inch)

ISO-Thread

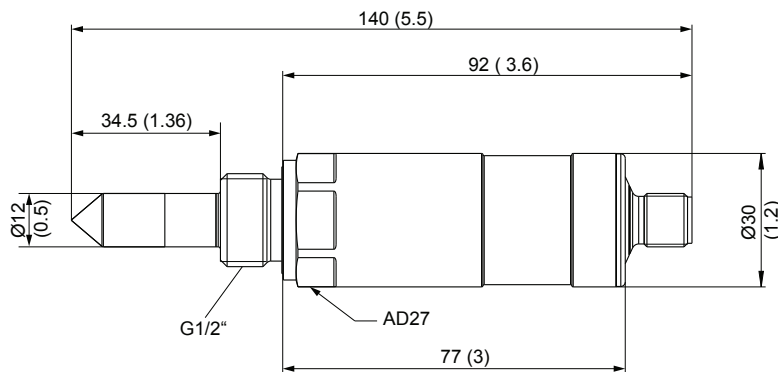

NPT-Thread

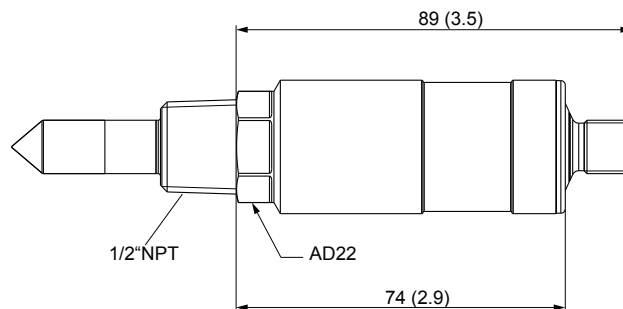

2.3 Autocalibration

Dew point temperatures ranging from -60 to -20 °C (-76...-4 °F) at room temperatures correspond to relative humidities of 0.08 to 5.37 % RH.

To guarantee the accuracy at the lowest humidity, even the smallest drift effects in the humidity sensing element have to be compensated.

A special auto-calibration method is used to compensate the usual drift effects, which leads to high-precision measurements even at the lowest dew point temperatures.

Autocalibration is carried out every 30 minutes and takes approx. 3 minutes. During the autocalibration, the analog outputs are frozen at the last measuring value.

2.4 Measurement range and Accuracy

The dew point transmitter EE355 has a specified accuracy of ± 2 °C in the measurement range -60...60 °C dew point.

Measuring signal limitation:

at medium temperature ≤ 20 °C: Td limitation = -80 °C

at medium temperature > 20 °C: Td limitation = medium temperature - 100 °C

e.g. at medium temperature 30 °C the measuring signal is limited at -70 °C dew point.

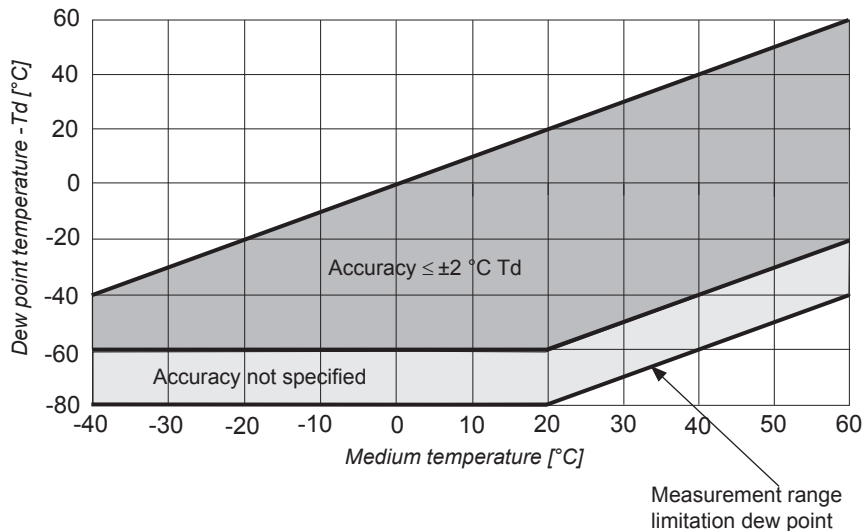

Pic. 1 Dew point measurement range and specified accuracy

The maximum scaling of the analog output is -100...80 °C dew point.

3 Installation

3.1 Installation location

Select a location that offers optimum measuring conditions. Air must be able to circulate freely around the sensing element.

Temperature differences between the process and the location of installation do not affect the dew point measurement. However, attention should be paid to the fact that changes in the pressure of a gas also changes the dew point. If there is a pressure difference between the location of installation and the process, the measurement can be several tens of degrees dew point off.

The exact effects of changes in pressure on the dew point can be simulated using the E+E humidity calculator. Please find further details on our website www.epluse.com.

Leaks should be avoided, because penetration of humidity from the environment will affect the measurement.



Upon delivery the sensor is protected by a cap that keeps the dew point sensor dry. The cap should only be removed immediately before installation into the application.

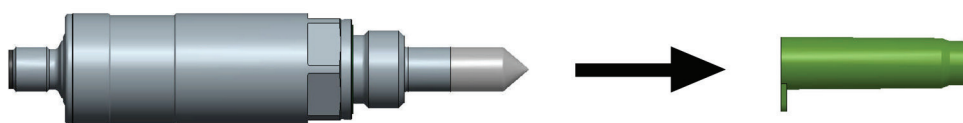

Pic. 2 Remove protection cap

3.2 Installing directly into the process

If installing directly into the process, a stop valve should be at both sides of the installation point. This makes it easy to remove the transmitter for maintenance and calibration.



It is not permitted to use a sealing ring with a NPT 1/2" thread. Appropriate PTFE sealing tape or sealant should be used instead.

Insert the probe into the process and screw it as tight as possible by hand. If there is a sealing ring, check the correct centering and tighten the screw connection with a torque of 30 Nm.

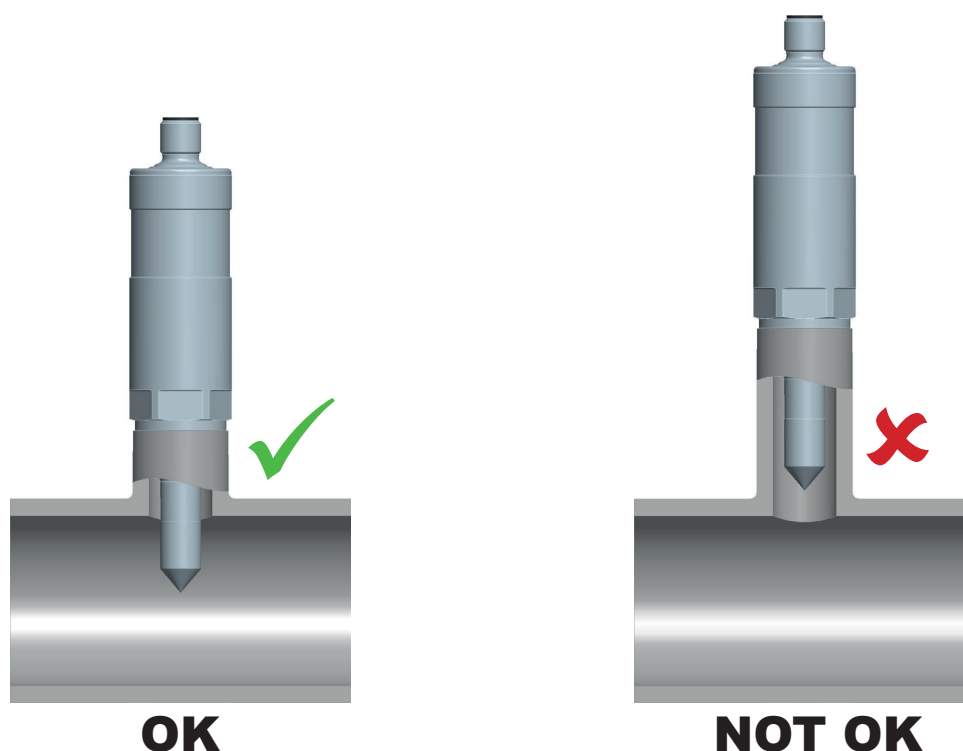

Pic. 3 Installing directly into the pipe

3.3 Installing the probe in a sampling system

Sampling is necessary if a direct installation of the probe in the process is not possible or not required. Reasons may be:

- an excessive process temperature
- protecting the sensor against soiling
- the need to remove the probe without interrupting the process.

To obtain a representative sample of the process gas and to avoid measuring errors, please note

the following:

- Differences in pressure between the process and the sampling chamber will result in significant measuring errors.
- Measurements at low dew point temperatures are sensitive to humidity penetrating from the environment due to leaks. Therefore, the sampling system must be pressure-tight.
- Non hygroscopic materials must be used.
- The sampling line should be as short as possible.
- The response time increases if the gas flow is < 1 l/min (0.25 gpm).
- A too low gas flow can result in back-diffusion of humidity from the environment and distort the measurement.

3.3.1 Basic sampling cell

The basic sampling cell offers the possibility to integrate the dew point transmitter into an existing or self-constructed sampling system.

Pressure range: 0...64 bar (0...928 psi)

Order code: (ISO) HA050103 (NPT) HA050105

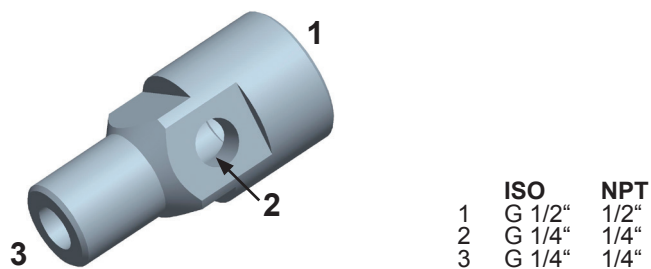

Pic. 4 Basic sampling cell

3.3.2 Sampling cell with quick connector

The sampling cell is specially developed for use in compressed air lines and has a quick-connector suitable for standard compressed air connections DN7.2. This allows the cell to be fitted and removed without interrupting the process.

The flow of gas can be adjusted using a bleed screw.

Pressure range: 0...10 bar (0...145 psi)

Order code: HA050102

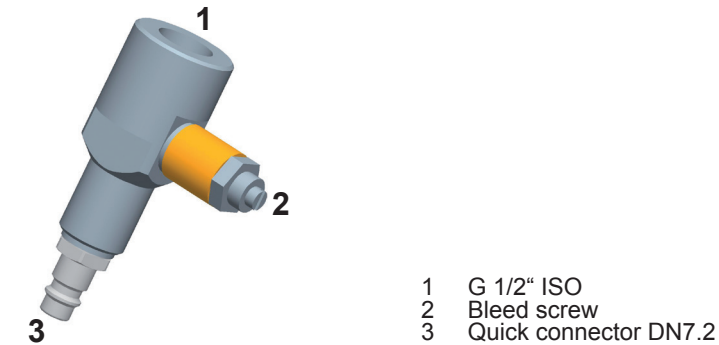

Pic. 5 Sampling cell with quick connector

4 Electrical Connection

The electrical connection is made via the 5-pin connector M12x1. An attachable mating connector is included.

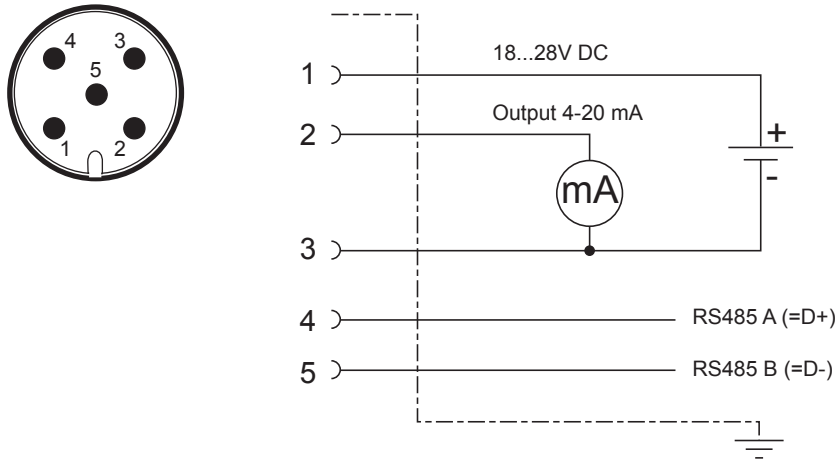

To meet the EMC Directive 2004/108/EC a shielded cable must be used.

4.1 Connecting cable - Accessory HA0108xx



1		BN	V+
2		WH	Output 4-20mA
3		BU	GND
4		BK	RS485 A (=D+)
5		GY	RS485 B (=D-)

5 Setup and Adjustment

The EE355 is ready to use and requires no configuration by the customer. The factory setting of the analog output corresponds to the ordered type designation.

With an optional Modbus to USB converter (order code HA011013) and the free EE-PCS configuration software the user can adjust the transmitter, set the Modbus parameters, and change the scaling of the analog output.

5.1 Dew point adjustment by the user

Dew point adjustment by the user is possible only at low dew points. The adjustment can only be carried out if the difference from ambient temperature to the reference dew point temperature is $< -60\text{ }^{\circ}\text{C}$.

Example:

Ambient temperature = $20\text{ }^{\circ}\text{C}$

Reference dew point temperature must be lower than $-40\text{ }^{\circ}\text{C}$.

6 Modbus RTU

Instructions for Modbus-Protocol-Setup please see Application Note AN0103 (www.epluse.com/EE355).



- The EE355 can be used in Modbus networks with max. 32 units.
- The bus termination shall be realized with 120 Ohm resistor (not included in the scope of supply)
- For proper function the power supply must be strong enough to ensure supply voltage within the specified range (see technical data) at any time and at all devices in the bus. This is particularly relevant when using long and thin cables which can cause high voltage drop.

6.1 Data Transmission

	Adjustable Values	Factory Setting
Slave Address	1...247	243
Baud Rate	9600 / 19200 / 38400	9600
Data Bits	8	8
Parity	None / Even / Odd	Even
Stop Bits	1 / 2	1

6.2 Modbus Map

The measured values are stored as a 32Bit float value. Depending on the measurement unit selected, the measurements are saved in SI or US/GB units.

Register	Protocol-Address	Measuring Value	SI-Unit	US/GB-Unit
Read Registers (Function Code 0x03 / 0x04) / 32Bit float value				
30026	0x19	Temperature	°C	°F
30028	0x1B	Relative Humidity	%	%
30032	0x1F	Dew point temperature	°C	°F
30042	0x29	Frost point temperature	°C	°F
30060	0x3B	volume concentration	ppm	ppm
Read Registers (Function Code 0x03 / 0x04) / 16Bit integer value				
30501	0x1F4	State of auto-calibration 0 ... normal operation 1 ... auto-calibration active		
Write Registers (Function Code 0x06) / 16Bit integer value				
60001	0x00	Slave-ID		
60002	0x01	RS485 Data Transmission		

7 Maintenance

7.1 Filter replacement

A soiled filter cap should not be cleaned but replaced with a new one. The order number for new filters is HA010103.

When replacing the filter, please note the following:

- Unscrew the filter cap very carefully to avoid damaging the sensing element.
- Handling the filter might clog the pores. Use gloves to screw on the new filter.

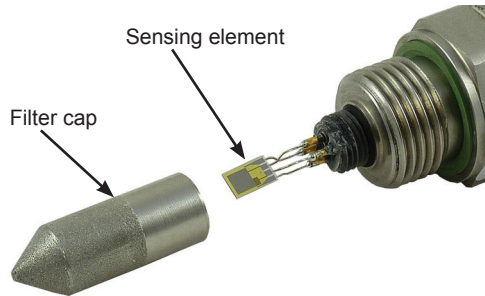

Pic. 6 EE355 Filter and Sensor

7.2 Sensor cleaning



Do not touch or rub the sensing element during the cleaning process.

It is strongly advised NOT to try cleaning the sensor by mechanical means, such as rubbing the sensor with cotton material!

The best way to clean the sensor is to use an ultrasound cleaner. This is a commercially available piece of equipment, which generates ultrasound vibrations in a small bath. The cleaning agent in the bath should be 50% isopropyl alcohol + 50% distilled water.

Remove the filter cap from the tip of the sensing probe. This has to be done very carefully in order to avoid damaging the sensing element.

Hold onto the sensing probe and slowly stir the tip of the sensing probe in the ultrasound bath for about 1 minute. The sensing element, the leads and the socket should be immersed in the liquid.

If an ultrasound cleaning bath is not available, stir the sensor as described above in a container with a mixture of 50% isopropyl alcohol + 50% distilled water for approx. 2-3 minutes. This procedure suffices for "normal soiling".

In the event of extreme soiling – which can be seen on the humidity sensing element with the naked eye – continue the operation until the pollutants are dissolved.

After the cleaning procedure with isopropyl alcohol, stir the tip of the sensing probe in a container with distilled water for about 30 seconds and then allow it to dry at room temperature.

8 Accessories

Description

M12x1 5pin connection cable socket/flying leads 1.5m
 M12x1 5pin connection cable socket/flying leads 5m
 M12x1 5pin connection cable socket/flying leads 10m
 Modbus - USB converter for EE35x
 Sampling cell with quick connector
 Basic sampling cell ISO
 Basic sampling cell NPT
 Sampling cell for ambient pressure
 Stainless steel sintered filter (included in the scope of supply)
 Attachable mating connector - 5-pin (included in the scope of supply)

Order code

HA010819
 HA010820
 HA010821
 HA011013
 HA050102
 HA050103
 HA050105
 HA050106
 HA010103
 HA010708

8.1 Scope of Supply

- Dew point transmitter
- M12x1 Attachable mating connector - 5 pin, straight
- Quick manual
- Calibration Certificate acc. DIN EN 10204-3.1

9 Technical Data

Measuring values

Dew point (Td)

Measurement range

-60...60 °C Td (-76...140 °F Td)

Accuracy ¹⁾

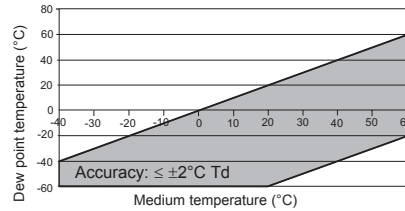

Response time t_{90}

< 5 min -20 °C Td (-4 °F Td) → -60 °C Td (-76 °F Td)
 <15 sec -60 °C Td (-76 °F Td) → -20 °C Td (-4 °F Td)

Volume concentration (ppm)

Measurement range

20...200,000 ppm

Accuracy at 20 °C (68 °F) and 1013mbar

5 ppm + 9 % from measured value

Output

Analog output (scalable)

4 - 20 mA (3-wire technology) RL < 500 Ohm

Maximum adjustable scaling

-100...80 °C Td (-148...176 °F Td)

Resolution of analog output

2 μ A

Digital interface

MODBUS RTU (max. 32 units in one bus)

Temperature dependence

± 5 ppm of the measuring span / °C (Deviating from 20 °C)

General

Supply voltage (Class III) \triangleleft

18...28 V DC

Current consumption at 24V DC

<20 mA + load current /
 with autocalibration: 100 mA + load current

Pressure range of use

0...80 bar

Housing / protection class

Stainless steel 1.4404 (AISI 316L) / IP65

Electrical connection ²⁾

M12x1 5-pin plug

Sensor protection

Stainless steel sintered filter

Temperature / humidity operating range

-40...70 °C (-40...158 °F) / 0...100 % RH

Storage temperature range

-40...60 °C (-40...140 °F)

Electromagnetic compatibility

EN61326-1 EN61326-2-3 Industrial environment
 FCC Part 15 ICES-003 ClassB



¹⁾ The accuracy statement includes the uncertainty of the factory calibration with an enhancement factor k=2 (2-times standard deviation). The accuracy was calculated in accordance with EA-4/02 and with regard to GUM (Guide to the Expression of Uncertainty in Measurement).

²⁾ Field-attachable mating connector is included in the scope of supply.



HEADQUARTERS

E+E Elektronik Ges.m.b.H.

Langwiesen 7
A-4209 Engerwitzdorf
Austria
Tel: +43 7235 605 0
Fax: +43 7235 605 8
info@epluse.com
www.epluse.com

SUBSIDIARIES

E+E Elektronik Germany

info@epluse.de

Office Bad Homburg
Tel: +49 6172 13881-0

Office Hamburg
Tel: +49 160 9050 6460

Office Stuttgart
Tel: +49 151 5383 7500

E+E Elektronik Italy

info@epluse.it
Tel: +39 02 2707 86 36

E+E Elektronik France

info@epluse.fr
Tel: +33 4 74 72 35 82

E+E Elektronik USA

office@epluse.com

Office Boston
Tel: +1 508 530 3068

Office Chicago
Tel: +1 847 490 7813

E+E Elektronik Korea

Tel: +82 31 732 6050
info@epluse.co.kr

E+E Elektronik China

info@epluse.cn

Office Beijing
Tel: +86 10 8499 2361

Office Shanghai
Tel: +86 21 6117 6129

Office Guangzhou
Tel: +86 20 3898 7052

YOUR PARTNER IN SENSOR TECHNOLOGY



ELEKTRONIK®
Ges.m.b.H.