

PACSystems™ Ethernet Switch

SLM080 User Manual

Warnings and Caution Notes as Used in this Publication

WARNING

Warning notices are used in this publication to emphasize that hazardous voltages, currents, temperatures, or other conditions that could cause personal injury exist in this equipment or may be associated with its use.

In situations where inattention could cause either personal injury or damage to equipment, a Warning notice is used.

CAUTION

Caution notices are used where equipment might be damaged if care is not taken.

Note: Notes merely call attention to information that is especially significant to understanding and operating the equipment.

These instructions do not purport to cover all details or variations in equipment, nor to provide for every possible contingency to be met during installation, operation, and maintenance. The information is supplied for informational purposes only, and Emerson makes no warranty as to the accuracy of the information included herein. Changes, modifications, and/or improvements to equipment and specifications are made periodically and these changes may or may not be reflected herein. It is understood that Emerson may make changes, modifications, or improvements to the equipment referenced herein or to the document itself at any time. This document is intended for trained personnel familiar with the Emerson products referenced herein.

Emerson may have patents or pending patent applications covering subject matter in this document. The furnishing of this document does not provide any license whatsoever to any of these patents.

Emerson provides the following document and the information included therein as-is and without warranty of any kind, expressed or implied, including but not limited to any implied statutory warranty of merchantability or fitness for particular purpose. If you purchased this product through an Authorized Channel Partner, please contact the seller directly

Contents

| | |
|--|-----------|
| Section 1: Getting to Know Your Switch | 1 |
| 1.1 About the SLM080 Managed Industrial Switch | 1 |
| 1.2 Software Features..... | 1 |
| Section 2: Hardware Features | 2 |
| 2.1 Hardware Installation | 2 |
| 2.1.1 Installing Switch on DIN-Rail..... | 2 |
| 2.1.2 Mount Switch on DIN-Rail..... | 3 |
| 2.1.3 Wall Mounting Installation | 3 |
| Section 3: Hardware Overview | 4 |
| 3.1 Front Panel | 4 |
| 3.2 Front Panel LEDs..... | 5 |
| 3.3 Top view Panel | 6 |
| Section 4: Cables..... | 7 |
| 4.1 Ethernet Cables | 7 |
| 4.2 100BASE-TX/10BASE-T Pin Assignments..... | 7 |
| 4.3 Console Cable..... | 8 |
| Section 5: Web Management..... | 18 |
| 5.1 Configuration by Web Browser | 18 |
| 5.1.1 About Web-based Management..... | 18 |
| 5.1.2 System Information..... | 20 |
| 5.1.3 Basic setting..... | 21 |
| 5.1.3.1 Switch Setting..... | 21 |
| 5.1.4 Admin Password..... | 22 |
| 5.1.5 IP Setting | 23 |
| 5.1.5.1 SNTP..... | 24 |
| 5.1.5.2 LLDP..... | 28 |
| 5.1.5.3 5.1.4.6 Auto Provision | 28 |
| 5.1.5.4 Backup & Restore | 29 |
| 5.1.5.5 Upgrade Firmware | 30 |

| | | |
|-----------|--|----|
| 5.1.6 | DHCP Server..... | 30 |
| 5.1.6.1 | DHCP Server – Setting..... | 30 |
| 5.1.6.2 | DHCP Server – Client List..... | 31 |
| 5.1.6.3 | DHCP Server – Port and IP bindings | 32 |
| 5.1.6.4 | Port Setting..... | 33 |
| 5.1.6.4.1 | Port Control | 33 |
| 5.1.6.5 | Port Status | 34 |
| 5.1.6.6 | Rate Limit..... | 34 |
| 5.1.6.7 | 5.1.6.4 Port Trunk | 35 |
| 5.1.7 | Redundancy | 37 |
| 5.1.7.1 | Redundant Ring | 37 |
| 5.2 | RSTP..... | 39 |
| 5.2.1 | RSTP setting..... | 39 |
| 5.2.2 | VLAN..... | 41 |
| 5.2.3 | VLAN Setting - IEEE 802.1Q | 41 |
| 5.2.3.1 | VLAN Setting – Port Based..... | 42 |
| 5.2.4 | SNMP | 44 |
| 5.2.4.1 | SNMP – Agent Setting..... | 44 |
| 5.2.4.2 | SNMP –Trap Setting | 45 |
| 5.2.5 | SNMPV3..... | 46 |
| 5.2.6 | Traffic Prioritization..... | 48 |
| 5.2.6.1 | Qos policy | 48 |
| 5.2.6.2 | Port-Base Priority | 49 |
| 5.2.6.3 | COS/802.1p | 50 |
| 5.2.6.4 | TOS/DSCP | 51 |
| 5.2.7 | Multicast..... | 52 |
| 5.2.7.1 | IGMP Snooping | 52 |
| 5.2.7.2 | Static Multicast Filtering..... | 53 |
| 5.2.8 | Security..... | 54 |
| 5.2.8.1 | IP Security | 54 |
| 5.2.8.2 | Port Security | 55 |
| 5.2.8.3 | MAC Blacklist | 56 |
| 5.2.8.4 | 802.1x | 57 |
| 5.2.8.5 | Warning..... | 60 |
| 5.2.9 | Monitor and Diagnostics | 64 |
| 5.2.9.1 | MAC Address Table | 64 |

| | | |
|---------|-------------------------|----|
| 5.2.9.2 | Port Statistics | 65 |
| 5.2.9.3 | System Event Log | 65 |
| 5.2.9.4 | Port Monitoring | 66 |
| 5.2.9.5 | Save Configuration..... | 67 |
| 5.2.9.6 | Factory Default | 68 |
| 5.2.9.7 | System Reboot..... | 68 |

Section 6: Command Line Interface Management 69

| | | |
|------|---|----|
| 6.1 | About CLI Management | 69 |
| 6.2 | Commands Set List—System Commands Set | 73 |
| 6.3 | Commands Set List—Port Commands Set | 76 |
| 6.4 | Commands Set List—Trunk Command Set | 79 |
| 6.5 | Commands Set List—VLAN command set..... | 80 |
| 6.6 | Commands Set List—Spanning Tree command set..... | 82 |
| 6.7 | Commands Set List—QoS command set..... | 84 |
| 6.8 | Commands Set List—IGMP command set..... | 85 |
| 6.9 | Commands Set List—MAC/Filter Table command set | 85 |
| 6.10 | Commands Set List—SNMP Command Set | 87 |
| 6.11 | Commands Set List—Port Mirroring command set | 89 |
| 6.12 | Commands Set List—802.1x command set | 90 |
| 6.13 | Commands Set List—TFTP command set..... | 92 |
| 6.14 | Commands Set List—SYSLOG, SMTP, EVENT command set | 93 |
| 6.15 | Commands Set List—SNTP command set..... | 95 |

Section 7: Command Set List—Redundant Ring command set96

Section 8: Technical Specifications 97

| | |
|-----------------------------------|-----|
| General Contact Information | 100 |
| Technical Support..... | 100 |

Section 1: Getting to Know Your Switch

1.1 About the SLM080 Managed Industrial Switch

The SLM080 is powerful managed industrial switch with many features. This switch can work under wide temperature, dusty environment and humid condition.

The SLM080 can be managed by WEB, Console or other third-party SNMP software as well. Besides, these switches can be managed by a useful utility that we called PACSystems Ethernet Switch Configuration Tool, which is powerful network management software. With its friendly and powerful interface, you can easily configure multiple switches at the same time, and monitor switches' status.

1.2 Software Features

- World's fastest Redundant Ethernet Ring : Redundant Ring (Recovery time < 10ms over 250 units connection)
- Supports Ring Coupling, Dual Homing over Redundant Ring
- Supports SNMPv1/v2/v3 & Port base/802.1Q VLAN Network Management
- Event notification by Email, SNMP trap and Relay Output
- Web-based ,Console(CLI) configuration
- Enable/disable ports, MAC based port security
- Port based network access control (802.1x)
- VLAN (802.1Q) to segregate and secure network traffic
- Radius centralized password management
- SNMPv3 encrypted authentication and access security
- RSTP (802.1w)
- Quality of Service (802.1p) for real-time traffic
- VLAN (802.1Q) with double tagging and GVRP supported
- IGMP Snooping for multicast filtering
- Port configuration, status, statistics, mirroring, security

Section 2: Hardware Features

- Redundant three DC power inputs
- Wide Operating Temperature: -40 to 70°C
- Storage Temperature: -40 to 85°C
- Operating Humidity: 5% to 95%, non-condensing
- Casing: IP-30
- 10/100Base-T(X) Ethernet port
- Console Port
- Dimensions(W x D x H) : 52 mm(W)x 106 mm(D)x 144 mm(H)

2.1 Hardware Installation

2.1.1 Installing Switch on DIN-Rail

Each switch has a DIN-Rail kit on rear panel. The DIN-Rail kit helps switch to fix on the DIN-Rail. It is easy to install the switch on the DIN-Rail:

2.1.2 Mount Switch on DIN-Rail

Figure 1: DIN Rail Size

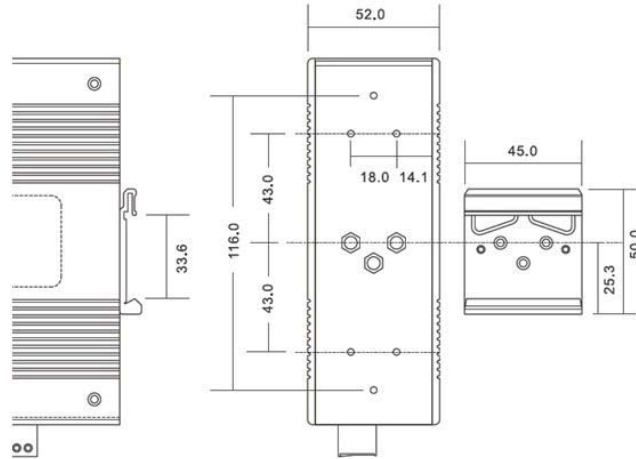

2.1.3 Wall Mounting Installation

Each switch has another installation method for users to fix the switch. A wall mount panel can be found in the package. The following steps show how to mount the switch on the wall:

Figure 2: Wall Mounting Installation

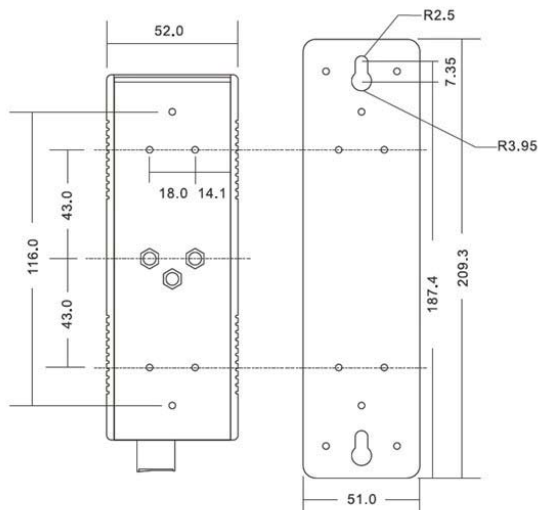

Section 3: Hardware Overview

3.1 Front Panel

The following table describes the labels that stick on the Switch

| Port | Description |
|----------------------------------|---|
| 10/100 RJ-45 fast Ethernet ports | 10/100Base-T(X) RJ-45 fast Ethernet ports support auto-negotiation. Default Setting : Speed: auto Duplex: auto Flow control : disable |
| Console | Use RS-232 to RJ-45 connector to manage switch. |
| Reset | Push reset button 2 to 3 seconds to reset the switch. Push reset button 5 seconds to reset the switch into Factory Default . |

Figure 3: SLM080

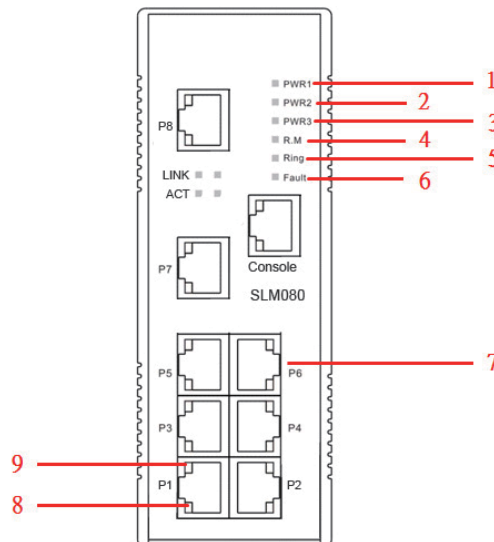

1. LED for PWR1. When the PWR1 links, the green led will be light on.
2. LED for PWR2. When the PWR2 links, the green led will be light on.
3. LED for PWR3. n the PWR3 links, the green led will be light on.

4. LED for R.M (Ring master). When the LED light on, it means that the switch is the ring master of Redundant Ring.
5. LED for Ring. When the led light on, it means the Redundant Ring is activated.
6. LED for Fault Relay. When the fault occurs, the amber LED will be light on.
7. 10/100Base-T(X) Ethernet ports..
8. LED for Ethernet ports ACT status.
9. LED for Ethernet ports Link status.

3.2 Front Panel LEDs

| LED | Color | Status | Description |
|-------------------------------------|-------|-----------------|---|
| PW1 | Green | On | DC power module 1 activated. |
| PW2 | Green | On | DC power module 2 activated. |
| PW3 | Green | On | Power jack activated. |
| R.M | Green | On | Redundant Ring Master. |
| Ring | Green | On | Redundant Ring enabled. |
| | | Slowly blinking | Redundant Ring topology has problem |
| | | Fast blinking | Redundant Ring work normally. |
| Fault | Amber | On | Fault relay. Power failure or Port down/fail. |
| 10/100Base-T(X) Fast Ethernet ports | | | |
| LNK / ACT | Green | On | Port link up. |
| | | Blinking | Data transmitted. |
| Full Duplex | Amber | On | Port works under full duplex. |
| | | | |
| ACT | | | |
| LNK | | | |

3.3 Top view Panel

The bottom panel components of SLM080 are shown as below:

1. Terminal block includes: PWR1, PWR2 (12-48V DC) and Relay output (1A@24VDC).
2. Power jack for PWR3 (12-45VDC).
3. Reset button. Push the button 3 seconds for reset; 5 seconds for factory default
4. Console port (RJ-45).

Figure 4: Top View of Panel

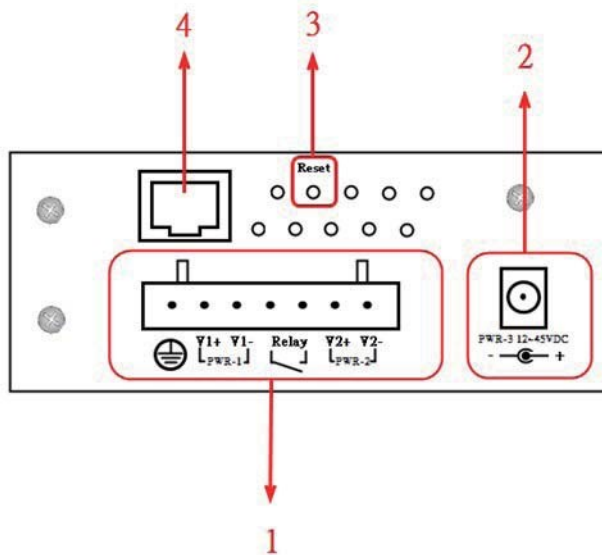

Section 4: Cables

4.1 Ethernet Cables

The SLM080 switches have standard Ethernet ports. According to the link type, the switches use CAT 3, 4, 5,5e UTP cables to connect to any other network device (PCs, servers, switches, routers, or hubs). Please refer to the following table for cable specifications.

Cable Types and Specifications

| Cable | Type | Max. Length | Connector |
|------------|----------------------|--------------------|-----------|
| 10BASE-T | Cat .3, 4, 5 100-ohm | UTP 100 m (328 ft) | RJ-45 |
| 100BASE-TX | Cat .5 100-ohm UTP | UTP 100 m (328 ft) | RJ-45 |

4.2 100BASE-TX/10BASE-T Pin Assignments

With 100BASE-TX/10BASE-T cable, pins 1 and 2 are used for transmitting data, and pins 3 and 6 are used for receiving data.

RJ-45 Pin Assignments

| Pin Number | Assignment |
|------------|------------|
| 1 | TD+ |
| 2 | TD- |
| 3 | RD+ |
| 4 | Not used |
| 5 | Not used |
| 6 | RD- |
| 7 | Not used |
| 8 | Not used |

The SLM080 switches support auto MDI/MDI-X operation. You can use a straight-through cable to connect PC to switch. The following table below shows the 10BASE-T/ 100BASE-TX MDI and MDI-X port pin outs.

10/100 Base-TX MDI/MDI-X pins assignment

| Pin Number | MDI port | MDI-X port |
|------------|---------------|---------------|
| 1 | TD+(transmit) | RD+(receive) |
| 2 | TD-(transmit) | RD-(receive) |
| 3 | RD+(receive) | TD+(transmit) |
| 4 | Not used | Not used |
| 5 | Not used | Not used |
| 6 | RD-(receive) | TD-(transmit) |
| 7 | Not used | Not used |
| 8 | Not used | Not used |

Note: “+” and “-” signs represent the polarity of the wires that make up each wire pair.

4.3 Console Cable

SLM080 switches can be management by console port . The DB-9 to RJ-45 cable can be found in the package. You can connect them to PC via a RS-232 cable with DB-9 female connector and the other end (RJ-45 connector) connects to console port of switch.

| PC pin out (male) assignment | RS-232 with DB9 female connector | DB9 to RJ 45 |
|------------------------------|----------------------------------|--------------|
| Pin #2 RD | Pin #2 TD | Pin #2 |
| Pin #3 TD | Pin #3 RD | Pin #3 |
| Pin #5 GD | Pin #5 GD | Pin #5 |

Figure 5: DB9 Pinout

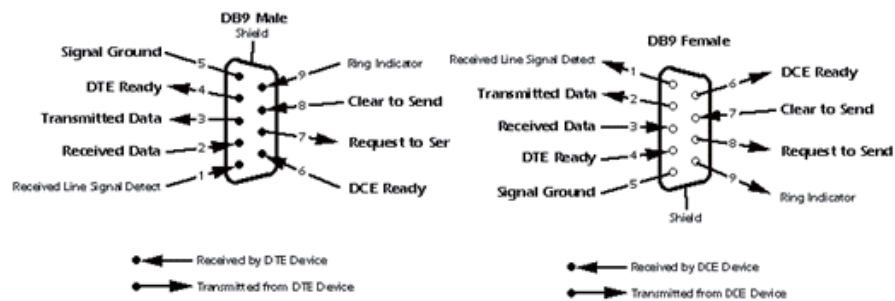

Section 5: Web Management

WARNING

While making any establishment and upgrade firmware, please remove physical loop connection first.

Do NOT power off equipment while firmware is upgrading.

5.1 Configuration by Web Browser

This section introduces the configuration by Web browser.

5.1.1 About Web-based Management

An embedded HTML web site resides in flash memory on the CPU board. It contains advanced management features and allows you to manage the switch from anywhere on the network through a standard web browser such as Microsoft Internet Explorer.

The Web-Based Management function supports Internet Explorer 5.0 or later. It is based on Java Applets with an aim to reduce network bandwidth consumption, enhance access speed and present an easy viewing screen.

Note: By default , IE5.0 or later version does not allow Java Applets to open sockets. You need to explicitly modify the browser setting in order to enable Java Applets to use network ports. And also the switch can support the HTTP and HTTPS mode at the same time, you can use any mode to manage switch.

Preparing for Web Management

The default value is as below: IP Address: 192.168.0.100

Subnet Mask: 255.255.255.0

Default Gateway: 192.168.0.254

User Name: admin

Password: admin

System Login

1. Launch the Internet Explorer.
2. Type http:// or https:// and the IP address of the switch. Press “Enter”.

Figure 6: URL



3. The login screen appears.
4. Key in the username and password. The default username and password is “admin”.
5. Click “Enter” or “OK” button, then the main interface of the Web-based management appears.

Figure 7: Login Credentials



Main Interface

Figure 8: Main Interface

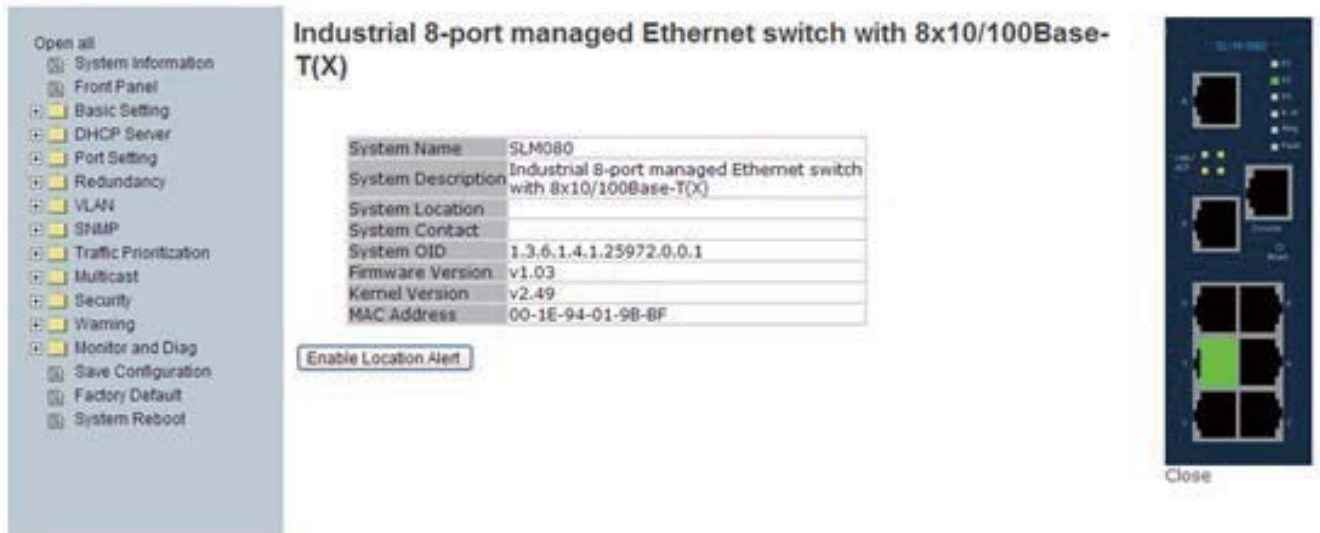

5.1.2 System Information

Figure 9: System Information

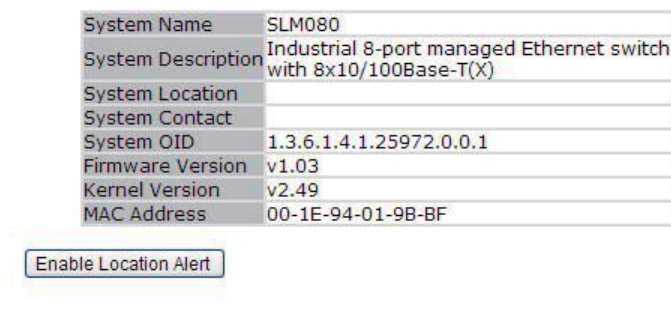

System Information

System Information interface

The system information will display the configuration of Basic Setting / Switch Setting page.

Enable Location Alert

When enabling, click **Enable Location Alert**, Pwr1, Pwr2, and Pwr3 LEDs of the switch will start to flash together, and click **Disable Location Alert**, the LEDs will stop flashing. Front Panel

Show the panel of Switch. Click **Close** to close panel on web.

5.1.3 Basic setting

5.1.3.1 Switch Setting

Figure 10: Switch Setting

Switch Setting

| | |
|--------------------|---|
| System Name | SLM080 |
| System Description | Industrial 8-port managed Ethernet switch with 8x10/100Base-T |
| System Location | |
| System Contact | |
| System OID | 1.3.6.1.4.1.25972.0.0.1 |
| Firmware Version | v1.03 |
| Kernel Version | v2.49 |
| Device MAC | 00-1E-94-01-9B-BF |

Apply Help

The following table describes the labels in this screen.

| Label | Description |
|--------------------|--|
| System Name | Assign the name of switch. The maximum length is 64 bytes |
| System Description | Display the description of switch. |
| System Location | Assign the switch physical location. The maximum length is 64 bytes |
| System Contact | Enter the name of contact person or organization |
| System OID | Display the SNMP Object ID of enterprise private MIB. |
| Firmware Version | Display the switch's firmware version |
| Kernel Version | Display the kernel software version |
| MAC Address | Display the unique hardware address assigned by manufacturer (default) |

Admin Password

Change web management login username and password for the management security issue

Figure 11: Admin Password

Admin Password

| | |
|------------------|--------------------------|
| Old User Name | <input type="text"/> |
| Old Password | <input type="password"/> |
| New User Name | <input type="text"/> |
| New Password | <input type="password"/> |
| Confirm Password | <input type="password"/> |

The following table describes the labels in this screen.

| Label | Description |
|-------------------------------------|--|
| Old User Name | Enter the current system User Name. If this is incorrect , the new |
| Old Password | Enter the current system password. If this is incorrect , the new password will not be set . |
| New User Name | Enter the new system User Name |
| New Password | Enter the new system password, and the password must meet the requirement : Minimum 8 characters; At least one Upper case letter. At least one numeric character. At least one special character such as @, #, \$, |
| Confirm password | Re-type the new password. |
| <input type="button" value="Save"/> | Click to save changes. |

IP Setting

You can configure the IP Settings and DHCP client function through IP configuration.

Figure 12: IP Setting

IP Setting

DHCP Client :

| | |
|-------------|--|
| IP Address | <input type="text" value="192.168.0.100"/> |
| Subnet Mask | <input type="text" value="255.255.255.0"/> |
| Gateway | <input type="text" value="192.168.0.254"/> |
| DNS1 | <input type="text" value="0.0.0.0"/> |
| DNS2 | <input type="text" value="0.0.0.0"/> |

The following table describes the labels in this screen.

| Label | Description |
|-------------|---|
| DHCP Client | To enable or disable the DHCP client function. When DHCP client function is enabling, the switch will be assigned the IP address from the network DHCP server. The default IP address will be replaced by the IP address which the DHCP server has assigned. After clicking “Apply” button, a popup dialog shows up to inform when the DHCP client is enabling. The current IP will lose and you should find a new IP on the DHCP server. |
| IP Address | Assign the IP address that the network is using. If DHCP client function is enabling, you do not need to assign the IP address. The network DHCP server will assign the IP address for the switch and it will be display in this column. The default IP is 192.168.0.100 |
| Subnet Mask | Assign the subnet mask of the IP address. If DHCP client function is enabling, you do not need to assign the subnet mask |
| Gateway | Assign the network gateway for the switch. The default gateway is 192.168.0.254 |
| DNS1 | Assign the primary DNS IP address |
| DNS2 | Assign the secondary DNS IP address |
| Apply | Click “Apply” to activate the configurations. |
| IP Address | Assign the IP address that the network is using. If DHCP client function is enabling, you do not need to assign the IP address. The network DHCP server will assign the IP address for the switch and it will be display in this column. The default IP is 192.168.0.100 |
| | Assign the subnet mask of the IP address. If DHCP client function |

| Label | Description |
|-------------|---|
| Subnet Mask | is enabling, you do not need to assign the subnet mask |
| Gateway | Assign the network gateway for the switch. The default gateway is 192.168.0.254 |
| DNS1 | Assign the primary DNS IP address |
| DNS2 | Assign the secondary DNS IP address |
| Apply | Click “Apply” to activate the configurations. |

5.1.3.2 SNTP

The SNTP (Simple Network Time Protocol) settings allow you to synchronize switch clocks in the Internet .

Figure 13: SNTP

SNTP

SNTP Client :

| | |
|---------------------|---|
| UTC Timezone | (GMT)Greenwich Mean Time: Dublin, Edinburgh, Lisbon, London |
| SNTP Server Address | 0.0.0.0 |
| Current System Time | 1970年1月1日 上午12:29:23 |

Daylight Saving Time :

| | |
|------------------------|----------------------|
| Daylight Saving Period | 2013 / Oct / 12 05 ~ |
| Daylight Saving Offset | 0 (hours) |

The following table describes the labels in this screen.

| Label | Description |
|------------------------|--|
| SNTP Client | Enable or disable SNTP function to get the time from the SNTP server. |
| UTC Time zone | Set the switch location time zone. The following table lists the different location time zone for your reference. |
| SNTP Sever IP Address | Set the SNTP server IP address. |
| Current System Time | Display the switch current time. |
| Daylight Saving Time | Enable or disable daylight saving time function. When daylight saving time is enabling, you need to configure the daylight saving time period. |
| Daylight Saving Period | Set up the Daylight Saving beginning time and Daylight Saving ending time. Both will be different each year. |
| Daylight Saving Offset | Set up the offset time. |
| Apply | Click "Apply" to activate the configurations. |

| Local Time Zone | Conversion from UTC | Time at 12:00 UTC |
|--|---------------------|-------------------|
| November Time Zone | - 1 hour | 11 am |
| Oscar Time Zone | -2 hours | 10 am |
| ADT - Atlantic Daylight | -3 hours | 9 am |
| AST - Atlantic Standard | | |
| EDT - Eastern Daylight | -4 hours | 8 am |
| EST - Eastern Standard | | |
| CDT - Central Daylight | -5 hours | 7 am |
| CST - Central Standard | | |
| MDT - Mountain Daylight | -6 hours | 6 am |
| MST - Mountain Standard | | |
| PDT - Pacific Daylight | -7 hours | 5 am |
| PST - Pacific Standard | | |
| ADT - Alaskan Daylight | -8 hours | 4 am |
| ALA - Alaskan Standard | -9 hours | 3 am |
| HAW - Hawaiian Standard | -10 hours | 2 am |
| Nome, Alaska | -11 hours | 1 am |
| CET - Central European FWT - French Winter MET - Middle European | | |
| MEWT - Middle European Winter | +1 hour | 1 pm |
| SWT - Swedish Winter | | |
| EET - Eastern European, USSR Zone 1 | +2 hours | 2 pm |
| BT - Baghdad, USSR Zone 2 | +3 hours | 3 pm |

| | | |
|--|-----------|----------|
| ZP4 - USSR Zone 3 | +4 hours | 4 pm |
| ZP5 - USSR Zone 4 | +5 hours | 5 pm |
| ZP6 - USSR Zone 5 | +6 hours | 6 pm |
| WAST - West Australian Standard | +7 hours | 7 pm |
| CCT - China Coast, USSR Zone 7 | +8 hours | 8 pm |
| JST - Japan Standard, USSR Zone 8 | +9 hours | 9 pm |
| EAST - East Australian Standard GST Guam Standard, USSR Zone 9 | +10 hours | 10 pm |
| IDLE - International Date Line NZST - New Zealand Standard NZT - New Zealand | +12 hours | Midnight |

5.1.3.3 LLDP

LLDP (Link Layer Discovery Protocol) function allows the switch to advertise its information to other nodes on the network and store the information it discovers.

Figure 14: LLDP

LLDP

LLDP Protocol: Enable

LLDP Interval: 30 sec

Apply Help

The following table describes the labels in this screen.

| Label | Description |
|---------------|--|
| LLDP Protocol | “Enable” or “Disable” LLDP function. |
| LLDP Interval | The interval of resend LLDP (by default at 30 seconds) |
| Apply | Click “Apply” to set the configurations. |
| Help | Show help file. |

5.1.3.4 5.1.4.6 Auto Provision

Auto Provision allows you to update the switch firmware automatically. You can put firmware or configuration file on TFTP server. When you reboot the switch, it will upgrade automatically. Before updating, make sure you have your TFTP server ready and the firmware image and configuration file is on the TFTP server.

Figure 15: Auto Provision

Auto Provision

Auto Install Configuration file from TFTP server?

TFTP Server IP Address: 192.168.0.66

Configuration File Name: data.bin

Auto Install Firmware image file from TFTP server?

TFTP Server IP Address: 192.168.0.66

Firmware File Name: image.bin

Apply Help

The following table describes the labels in this screen.

| Label | Description |
|-------------------------|-----------------------------------|
| TFTP Server IP Address | Fill in the TFTP server IP |
| Configuration File Name | Fill the configuration file name. |
| Firmware File Name | Fill the Firmware file name. |

5.1.3.5 Backup & Restore

You can save current EEPROM value from the switch to TFTP server, then go to the TFTP restore configuration page to restore the EEPROM value.

Figure 16: Backup and Restore

Backup & Restore

Restore Configuration From TFTP Server

TFTP Server IP Address: 192.168.0.66

Restore File Name: data.bin

Restore Help

Backup Configuration To TFTP Server

TFTP Server IP Address: 192.168.0.66

Backup File Name: data.bin

Backup Help

The following table describes the labels in this screen.

| Label | Description |
|------------------------|--|
| TFTP Server IP Address | Fill in the TFTP server IP |
| Restore File Name | Fill the file name. |
| Restore | Click “restore” to restore the configurations. |
| Backup File Name | Fill the configuration file name. |
| Backup | Click “backup” to backup the configurations. |

5.1.3.6 Upgrade Firmware

Upgrade Firmware allows you to update the switch firmware. Before updating, make sure you have your TFTP server ready and the firmware image is on the TFTP server.

Figure 17: Upgrade Firmware

Upgrade Firmware

| | |
|--------------------|--------------|
| TFTP Server IP | 192.168.0.66 |
| Firmware File Name | image.bin |

5.1.4 DHCP Server

5.1.4.1 DHCP Server – Setting

The system provides with DHCP server function. Enable the DHCP server function, the switch system will be a DHCP server.

Figure 18: DHCP Server Settings

DHCP Server - Setting

| | |
|--|---------------|
| DHCP Server : <input type="button" value="Disable"/> | |
| Start IP Address | 192.168.0.2 |
| End IP Address | 192.168.0.200 |
| Subnet Mask | 255.255.255.0 |
| Gateway | 192.168.0.254 |
| DNS | 0.0.0.0 |
| Lease Time (Hour) | 168 |

The following table describes the labels in this screen.

| Label | Description |
|-------------------|--|
| DHCP Server | Enable or Disable the DHCP Server function. Enable – the switch will be the DHCP server on your local network |
| Start IP Address | The dynamic IP assign range. Low IP address is the beginning of the dynamic IP assigns range. For example: dynamic IP assign range is from 192.168.1.100 to 192.168.1.200. 192.168.1.100 will be the Start IP address. |
| End IP Address | The dynamic IP assign range. High IP address is the end of the dynamic IP assigns range. For example: dynamic IP assign range is from 192.168.1.100 to 192.168.1.200. 192.168.1.200 will be the End IP address |
| Subnet Mask | The dynamic IP assign range subnet mask |
| Gateway | The gateway in your network. |
| DNS | Domain Name Server IP Address in your network. |
| Lease Time (Hour) | It is the period that system will reset the assigned dynamic IP to ensure the IP address is in used. |
| Apply | Click “Apply” to set the configurations. |

5.1.4.2 DHCP Server – Client List

When the DHCP server function is activated, the system will collect the DHCP client information and display in here.

5.1.4.3 DHCP Server – Port and IP bindings

You can assign the specific IP address which is in the assigned dynamic IP range to the specific port . When the device is connecting to the port and asks for dynamic IP assigning, the system will assign the IP address that has been assigned before in the connected device.

Figure 19: DHCP Server - Port and IP

DHCP Server - Port and IP I

| Port No. | IP Address |
|----------|--------------------------------------|
| Port.01 | <input type="text" value="0.0.0.0"/> |
| Port.02 | <input type="text" value="0.0.0.0"/> |
| Port.03 | <input type="text" value="0.0.0.0"/> |
| Port.04 | <input type="text" value="0.0.0.0"/> |
| Port.05 | <input type="text" value="0.0.0.0"/> |
| Port.06 | <input type="text" value="0.0.0.0"/> |
| Port.07 | <input type="text" value="0.0.0.0"/> |
| Port.08 | <input type="text" value="0.0.0.0"/> |

5.1.4.4 Port Setting

5.1.4.4.1 Port Control

By this function, you can set the state, speed/duplex, flow control, and security of the port .

Figure 20: Port Control

Port Control

| Port No. | State | Speed/Duplex | Flow Control | Security |
|----------|--------|-----------------|--------------|----------|
| Port.01 | Enable | AutoNegotiation | Symmetric | Disable |
| Port.02 | Enable | AutoNegotiation | Symmetric | Disable |
| Port.03 | Enable | AutoNegotiation | Symmetric | Disable |
| Port.04 | Enable | AutoNegotiation | Symmetric | Disable |
| Port.05 | Enable | AutoNegotiation | Symmetric | Disable |
| Port.06 | Enable | AutoNegotiation | Symmetric | Disable |
| Port.07 | Enable | AutoNegotiation | Symmetric | Disable |
| Port.08 | Enable | AutoNegotiation | Symmetric | Disable |

Apply Help

The following table describes the labels in this screen.

| Label | Description |
|--------------|--|
| Port NO. | Port number for setting. |
| State | Enable/Disable the port . |
| Speed/Duplex | You can set Auto-negotiation, 100-full, 100-half, 10-full, 10-half mode. |
| Flow Control | Support symmetric and asymmetric mode to avoid packet loss when congestion occurred. |
| Security | Enabled port security will disable MAC address learning in this port . Thus only the frames with MAC addresses in port security list will be forwarded, otherwise will be discarded. |
| Apply | Click “Apply” to activate the configurations. |

5.1.4.5 Port Status

The following information provides the current port status information

Figure 21: Port Status

Port Status

| Port No. | Type | Link | State | Speed/Duplex | Flow Control |
|----------|-------|------|--------|--------------|--------------|
| Port.01 | 100TX | Down | Enable | N/A | N/A |
| Port.02 | 100TX | Down | Enable | N/A | N/A |
| Port.03 | 100TX | UP | Enable | 100 Full | Disable |
| Port.04 | 100TX | Down | Enable | N/A | N/A |
| Port.05 | 100TX | UP | Enable | 100 Full | Disable |
| Port.06 | 100TX | Down | Enable | N/A | N/A |
| Port.07 | 100TX | Down | Enable | N/A | N/A |
| Port.08 | 100TX | Down | Enable | N/A | N/A |

5.1.4.6 Rate Limit

By this function, you can limit traffic of all ports, including broadcast , multicast and flooded unicast . You can also set “Ingress” or “Egress” to limit traffic received or transmitted bandwidth.

Figure 22: Rate Limit

Rate Limit

| Port No. | Ingress Limit Frame Type | Ingress | Egress |
|----------|--------------------------|---------|--------|
| Port.01 | All | 0 kbps | 0 kbps |
| Port.02 | All | 0 kbps | 0 kbps |
| Port.03 | All | 0 kbps | 0 kbps |
| Port.04 | All | 0 kbps | 0 kbps |
| Port.05 | All | 0 kbps | 0 kbps |
| Port.06 | All | 0 kbps | 0 kbps |
| Port.07 | All | 0 kbps | 0 kbps |
| Port.08 | All | 0 kbps | 0 kbps |

Rate range is from 100 kbps to 102400 kbps (i.e. 100Mbps) for mega-ports, or 256000 kbps (i.e. 250Mbps) for giga-ports. Zero means no limit.

Apply Help

The following table describes the labels in this screen.

| Label | Description |
|--------------------------|---|
| Ingress Limit Frame Type | You can set “all”, “Broadcast only”, ”Broadcast/Multicast” or ”Broadcast/Multicast/Flooded Unicast” mode. |
| Ingress | The switch port received traffic. |
| Egress | The switch port transmitted traffic. |
| Apply | Click “Apply” to activate the configurations. |

5.1.4.7

5.1.6.4 Port Trunk

Port Trunk – Setting

You can select static trunk or 802.3ad LACP to combine several physical links with a logical link to increase the bandwidth.

Figure 23: Port Trunk - Setting

Port Trunk - Setting

| Port No. | Group ID | Type |
|----------|----------|--------|
| Port.01 | None | Static |
| Port.02 | None | Static |
| Port.03 | None | Static |
| Port.04 | None | Static |
| Port.05 | None | Static |
| Port.06 | None | Static |
| Port.07 | None | Static |
| Port.08 | None | Static |

Note: the types should be the same for all member ports in a group.

802.3ad LACP Work Ports

| Group ID | Work Ports |
|----------|------------|
| Trunk1 | max |
| Trunk2 | max |
| Trunk3 | max |
| Trunk4 | max |

Apply Help

The following table describes the labels in this screen.

| Label | Description |
|-----------|--|
| Group ID | Select port to join a trunk group. |
| Type | Support static trunk and 802.3ad LACP |
| Work Port | Select the number of active ports in dynamic group (LACP). The default value of works ports is maximum number of the group. If the number is not maximum number of ports, the other inactive ports in dynamic group will be suspended (no traffic). Once the active port is broken, the suspended port will be active automatically. |
| Apply | Click "Apply" to set the configurations. |

Figure 24: Port Trunk - Status

Port Trunk - Status

| Group ID | Trunk Member | Type |
|----------|--------------|--------|
| Trunk 1 | N/A | Static |
| Trunk 2 | N/A | Static |
| Trunk 3 | N/A | Static |
| Trunk 4 | N/A | Static |

| Label | Description |
|-------------|----------------------|
| Group ID | Trunk Group number |
| Port Member | Show Group port info |

5.1.5 Redundancy

5.1.5.1 Redundant Ring

Redundant Ring is the most powerful Ring in the world. The recovery time of Ring is less than 10ms. It can reduce unexpected damage caused by network topology change. Redundant Ring Supports 3 Ring topology: Ring, Coupling Ring and Dual Homing.

Figure 25: Redundant Ring

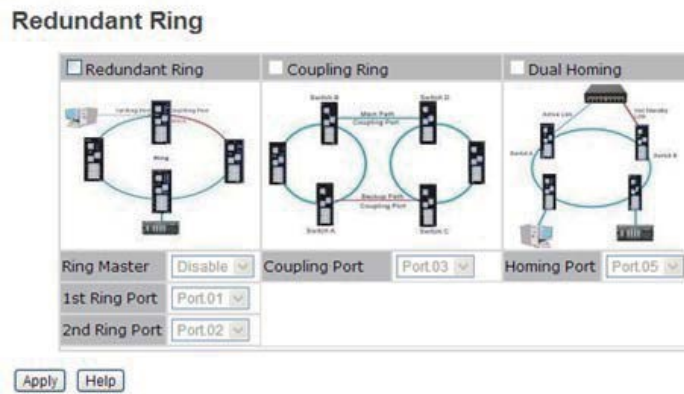

The following table describes the labels in this screen.

| Label | Description |
|----------------|---|
| Redundant Ring | Mark to enable Ring. |
| Ring Master | There should be one and only one Ring Master in a ring. However if there are two or more switches which set Ring Master to enable, the switch with the lowest MAC address will be the actual Ring Master and others will be Backup Masters. |
| 1stRingPort | The primary port , when this switch is Ring Master. |
| 2ndRingPort | The backup port , when this switch is Ring Master. |
| Coupling Ring | Mark to enable Coupling Ring. Coupling Ring can be used to divide a big ring into two smaller rings to avoid effecting all switches when network topology change. It is a good application for connecting two Rings. |
| Coupling Port | Link to Coupling Port of the switch in another ring. Coupling Ring need four switch to build an active and a backup link. Set a port as coupling port . The coupled four ports of four switches will be run at active/backup mode. |
| Dual Homing | Mark to enable Dual Homing. By selecting Dual Homing mode, Ring will be connected to normal switches through two RSTP links (ex: backbone Switch). The two links work as active/backup mode, and connect each Ring to the normal switches in RSTP mode. |
| Apply | Click “Apply” to set the configurations. |

Note: We don't suggest you to set one switch as a Ring Master and a Coupling Ring at the same time due to heavy load.

5.2 RSTP

The Rapid Spanning Tree Protocol (RSTP) is an evolution of the Spanning Tree Protocol. It provides faster spanning tree convergence after a topology change. The system also supports STP and the system will auto detect the connected device that is running STP or RSTP protocol.

5.2.1 RSTP setting

You can enable/disable RSTP function, and set parameters for each port .

Figure 26: RSTP Setting

RSTP Setting

RSTP Mode:

Bridge Setting

| | |
|---------------------------|------------------------------------|
| Priority (0-61440) | <input type="text" value="32768"/> |
| Max Age Time(6-40) | <input type="text" value="20"/> |
| Hello Time (1-10) | <input type="text" value="2"/> |
| Forward Delay Time (4-30) | <input type="text" value="15"/> |

The following table describes the labels in this screen.

| Label | Description |
|------------------------------|---|
| RSTP mode | You must enable or disable RSTP function before configuring the related parameters. |
| Priority (0-61440) | A value used to identify the root bridge. The bridge with the lowest value has the highest priority and is selected as the root . If the value changes, You must reboot the switch. The value must be multiple of 4096 according to the protocol standard rule. |
| Max Age Time(6-40) | The number of seconds a bridge waits without receiving Spanning-tree Protocol configuration messages before attempting a reconfiguration. Enter a value between 6 through 40. |
| Hello Time (1-10) | The time that controls switch sends out the BPDU packet to check RSTP current status. Enter a value between 1 through 10. |
| Forwarding Delay Time (4-30) | The number of seconds a port waits before changing from its Rapid Spanning-Tree Protocol learning and listening states to the forwarding state. Enter a value between 4 through 30. |
| Apply | Click "Apply" to set the configurations. |

NOTE: Follow the rule to configure the MAX Age, Hello Time, and Forward Delay Time.

$2 \times (\text{Forward Delay Time value} - 1) \geq \text{Max Age value} \geq 2 \times (\text{Hello Time value} + 1)$

Show RSTP algorithm result at this table

Figure 27: Port Setting

Port Setting

| Port No. | Enable | Path Cost(0:auto, 1-200000000) | Priority (0-240) | P2P | Edge |
|----------|--------|--------------------------------|------------------|------|------|
| Port.01 | enable | 0 | 128 | auto | true |
| Port.02 | enable | 0 | 128 | auto | true |
| Port.03 | enable | 0 | 128 | auto | true |
| Port.04 | enable | 0 | 128 | auto | true |
| Port.05 | enable | 0 | 128 | auto | true |
| Port.06 | enable | 0 | 128 | auto | true |
| Port.07 | enable | 0 | 128 | auto | true |
| Port.08 | enable | 0 | 128 | auto | true |

| Label | Description |
|-------------------------|---|
| Path Cost (1-200000000) | The cost of the path to the other bridge from this transmitting bridge at the specified port . Enter a number 1 through 200000000. |
| Port Priority (0-240) | Decide which port should be blocked by priority in LAN. Enter a number 0 through 240. The value of priority must be the multiple of 16 |
| Admin P2P | Some of the rapid state transactions that are possible within RSTP are dependent upon whether the port concerned can only be connected to exactly one other bridge (i.e. It is served by a point-to-point LAN segment), or it can be connected to two or more bridges (i.e. It is served by a shared medium LAN segment). This function allows the P2P status of the link to be manipulated administratively. True means P2P enabling. False means P2P disabling. |
| Admin Edge | The port directly connected to end stations, and it cannot create bridging loop in the network. To configure the port as an edge port , set the port to “True”. |
| Admin Non STP | The port includes the STP mathematic calculation. True is not including STP mathematic calculation. False is including the STP mathematic calculation. |
| Apply | Click “Apply” to set the configurations. |

5.2.2 VLAN

A Virtual LAN (VLAN) is a logical network grouping that limits the broadcast domain, which allows you to isolate network traffic. Only the members of the VLAN will receive traffic from the same members of VLAN. Basically, creating a VLAN from a switch is logically equivalent of reconnecting a group of network devices to another Layer 2 switch. However, all the network devices are still plugged into the same switch physically.

The switch supports port-based and 802.1Q (tagged-based) VLAN. The default configuration of VLAN operation mode is at “802.1Q”.

5.2.3 VLAN Setting - IEEE 802.1Q

Tagged-based VLAN is an IEEE 802.1Q specification standard, and it is possible to create a VLAN across devices from different switch vendors. IEEE 802.1Q VLAN uses a technique to insert a “tag” into the Ethernet frames. Tag contains a VLAN Identifier (VID) that indicates the VLAN numbers.

You can create Tag-based VLAN, and enable or disable GVRP protocol. There are 256 VLAN groups to provide configure. Enable 802.1Q VLAN, the all ports on the switch belong to default VLAN, VID is 1. The default VLAN cannot be deleted.

GVRP allows automatic VLAN configuration between the switch and nodes. If the switch is connected to a device with GVRP enabled, you can send a GVRP request by using the VID of a VLAN defined on the switch; the switch will automatically add that device to the existing VLAN.

Figure 28: VLAN Setting

VLAN Setting

VLAN Operation Mode : 802.1Q

GVRP Mode : Disable

Management Vlan ID : 0

VLAN Configuration

| Port No. | Link Type | Untagged VID | Tagged VIDs |
|----------|-----------|--------------|-------------|
| Port.01 | Access | 1 | |
| Port.02 | Access | 1 | |
| Port.03 | Access | 1 | |
| Port.04 | Access | 1 | |
| Port.05 | Access | 1 | |
| Port.06 | Access | 1 | |
| Port.07 | Access | 1 | |
| Port.08 | Access | 1 | |

Note: Use the comma to separate the multiple tagged VIDs.
E.g., 2-4,6 means joining the Tagged VLAN 2, 3, 4 and 6.

The following table describes the labels in this screen.

| Label | Description |
|---------------------|--|
| VLAN Operation Mode | Configure VLAN Operation Mode: disable, Port Base, 802.1Q |
| GVRP Mode | Enable/Disable GVRP function. |
| Management VLAN ID | Management VLAN can provide network administrator a secure VLAN to management Switch. Only the devices in the management VLAN can access the switch. |
| Port | Select the port to configure. |
| Link type | There are 3 types of link type: |
| Untagged VID | Set the port default VLAN ID for untagged devices that |
| Tagged VIDs | Set the tagged VIDs to carry different VLAN frames to other |
| Apply | Click "Apply" to set the configurations. |

5.2.3.1 VLAN Setting – Port Based

Packets can go among only members of the same VLAN group. Note all unselected ports are treated as belonging to another single VLAN. If the port-based VLAN enabled, the VLAN-tagging is ignored.

Figure 29: VLAN Setting

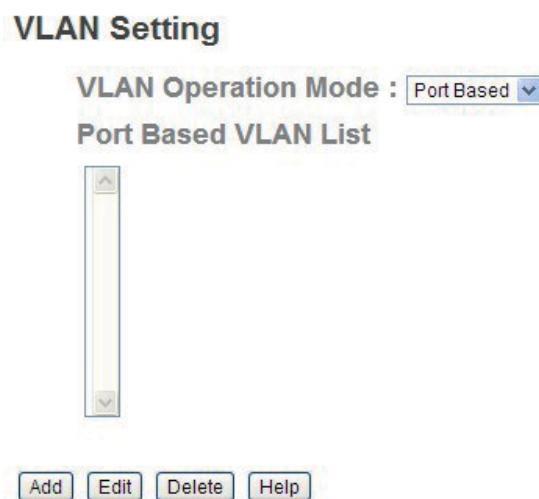

The following table describes the labels in this screen.

| Label | Description |
|--------|--|
| Add | Click “add” to enter VLAN add interface. |
| Edit | Edit exist VLAN |
| Delete | Delete exist VLAN |
| Help | Show help file. |

Figure 30: VLAN Setting

VLAN Setting

VLAN Operation Mode : Port Based

Group Name

VLAN ID

Port.01
Port.02
Port.03
Port.04
Port.05
Port.06
Port.07
Port.08

Add

Remove

Apply Help

The following table describes the labels in this screen.

| Label | Description |
|------------|--|
| Group Name | VLAN name. |
| VLAN ID | Specify the VLAN ID |
| Add | Select port to join the VLAN group. |
| Remove | Remove port of the VLAN group |
| Apply | Click “Apply” to set the configurations. |
| Help | Show help file. |

5.2.4 SNMP

Simple Network Management Protocol (SNMP) is the protocol developed to manage nodes (servers, workstations, routers, switches and hubs etc.) on an IP network. SNMP enables network administrators to manage network performance, find and solve network problems, and plan for network growth. Network management systems learn of problems by receiving traps or change notices from network devices implementing SNMP.

5.2.4.1 SNMP – Agent Setting

You can set SNMP agent related information by Agent Setting Function.

Figure 31: SNMP - Agent Setting

The following table describes the labels in this screen.

| Label | Description |
|-----------------------|--|
| SNMP agent Version | There are three SNMP versions supported such as SNMP V1/ SNMP V2c, and SNMP V3. SNMP V1/SNMP V2c agent use a community string match for authentication, that means SNMP servers access objects with read-only or read/write permissions with the community default string public/private. SNMP V3 requires an authentication level of MD5 or DES to encrypt data to enhance data security. |
| SNMP V1/V2c Community | SNMP Community should be set for SNMP V1/V2c. Four sets of "Community String/Privilege" are supported. Each Community String is maximum 32 characters. Keep empty to remove this Community string. |
| Apply | Click "Apply" to activate the configurations. |
| Help | Show help file. |

5.2.4.2 SNMP –Trap Setting

A trap manager is a management station that receives traps, the system alerts generated by the switch. If no trap manager is defined, no traps will issue. Create a trap manager by entering the IP address of the station and a community string. To define management stations as trap manager and enter SNMP community strings and selects the SNMP version.

Figure 32: SNMP - Trap Setting

The following table describes the labels in this screen.

| Label | Description |
|--------------|---|
| Server IP | The server IP address to receive Trap |
| Community | Community for authentication |
| Trap Version | Trap Version supports V1 and V2c and V3 |
| Add | Add trap server profile. |
| Remove | Remove trap server profile. |
| Help | Show help file. |

5.2.5 SNMPV3

Figure 33: SNMPV3

SNMPv3 Engine ID: f465000003001e94019bbf

SNMPv3 User

| | |
|------------------|----------------------|
| User Name | <input type="text"/> |
| Auth Password | <input type="text"/> |
| Privacy Password | <input type="text"/> |

Current SNMPv3 User Profile

| User Name | Auth. Password | Priv. Password |
|-----------|----------------|----------------|
|-----------|----------------|----------------|

The following table describes the labels in this screen

| Label | Description |
|---------------|---|
| Context Table | Configure SNMP v3 context table. Assign the context name of context table. Click "Apply" to change context name |
| User Table | <ol style="list-style-type: none">1. Configure SNMP v3 user table.2. User ID: set up the user name.3. Authentication Password: set up the authentication password.4. Privacy Password: set up the private password.5. Click "Add" to add context name.6. Click "Remove" to remove unwanted context name. |

| | |
|---------------|--|
| Group Table | <ol style="list-style-type: none">1. Configure SNMP v3 group table.2. Security Name (User ID): assign the user name that you have set up in user table.3. Group Name: set up the group name.4. Click "Add" to add context name.5. Click "Remove" to remove unwanted context name. |
| Access Table | <ol style="list-style-type: none">1. Configure SNMP v3 access table.2. Context Prefix: set up the context name.3. Group Name: set up the group.4. Security Level: select the access level.5. Context Match Rule: select the context match rule.6. Read View Name: set up the read view.7. Write View Name: set up the write view.8. Notify View Name: set up the notify view.9. Click "Add" to add context name.10. Click "Remove" to remove unwanted context name. |
| MIBview Table | <ol style="list-style-type: none">1. Configure MIB view table.2. ViewName: set up the name.3. Sub-Oid Tree: fill the Sub OID.4. Type: select the type – exclude or included.5. Click "Add" to add context name.6. Click "Remove" to remove unwanted context name. |
| Help | Show help file. |

5.2.6 Traffic Prioritization

Traffic Prioritization includes 3 modes: port base, 802.1p/COS, and TOS/DSCP. By traffic prioritization function, you can classify the traffic into four classes for differential network application.

5.2.6.1 Qos policy

Figure 34: Policy

Policy

QoS Mode :

QoS Policy :

Use an 8,4,2,1 weighted fair queuing scheme

Use a strict priority scheme

The following table describes the labels in this screen.

| Label | Description |
|------------|--|
| QOS Mode | <ul style="list-style-type: none"> ■ Port-base: the output priority is determined by ingress port. ■ COS only: the output priority is determined by COS only. ■ TOS only: the output priority is determined by TOS only. ■ COS first: the output priority is determined by COS and TOS, but COS first . ■ TOS first: the output priority is determined by COS and TOS, but TOS first . |
| QOS policy | <ul style="list-style-type: none"> ■ Using the 8,4,2,1 weight fair queue scheme: the output queues will follow 8:4:2:1 ratio to transmit packets from the highest to lowest queue. For example: 8 high queue packets, 4 middle queue packets, 2 low queue packets, and the one lowest queue packets are transmitted in one turn. ■ Use the strict priority scheme: always the packets in higher queue will be transmitted first until higher queue is empty. |
| Apply | Click "Apply" to set the configurations. |
| Help | Show help file. |

5.2.6.2 Port-Base Priority

Figure 35:Port-Base Priority

Port-based Priority

| Port No. | Priority |
|----------|----------|
| Port.01 | Lowest |
| Port.02 | Lowest |
| Port.03 | Lowest |
| Port.04 | Lowest |
| Port.05 | Lowest |
| Port.06 | Lowest |
| Port.07 | Lowest |
| Port.08 | Lowest |

The following table describes the labels in this screen

| Label | Description |
|--------------------|---|
| Port base Priority | Assign Port with a priority queue. 4 priority queues can be assigned: High, Middle, Low, and Lowest . |
| Apply | Click “Apply” to set the configurations. |
| Help | Show help file. |

5.2.6.3 COS/802.1p

Figure 36: COS/802.1p

| COS/802.1p | | COS Port Default | |
|------------|----------|------------------|-----|
| COS | Priority | Port No. | COS |
| 0 | Lowest | Port.01 | 0 |
| 1 | Lowest | Port.02 | 0 |
| 2 | Low | Port.03 | 0 |
| 3 | Low | Port.04 | 0 |
| 4 | Middle | Port.05 | 0 |
| 5 | Middle | Port.06 | 0 |
| 6 | High | Port.07 | 0 |
| 7 | High | Port.08 | 0 |

Apply Help

The following table describes the labels in this screen

| Label | Description |
|------------------|---|
| COS/802.1p | COS (Class Of Service) is well known as 802.1p. It describes that the output priority of a packet is determined by user priority field in 802.1Q VLAN tag. The priority value is supported 0to7.COS value map to 4 priority queues: High, Middle, Low, and Lowest . |
| COS Port Default | When an ingress packet has not VLAN tag, a default priority value is considered and determined by ingress port . |
| Apply | Click “Apply” to set the configurations. |
| Help | Show help file. |

5.2.6.4 TOS/DSCP

Figure 37: TOS/DSCP

TOS/DSCP

| | | | | | | | | |
|----------|----------|----------|----------|----------|----------|----------|----------|----------|
| DSCP | 0 | 1 | 2 | 3 | 4 | 5 | 6 | 7 |
| Priority | Lowest ▾ | Lowest ▾ | Lowest ▾ | Lowest ▾ | Lowest ▾ | Lowest ▾ | Lowest ▾ | Lowest ▾ |
| DSCP | 8 | 9 | 10 | 11 | 12 | 13 | 14 | 15 |
| Priority | Lowest ▾ | Lowest ▾ | Lowest ▾ | Lowest ▾ | Lowest ▾ | Lowest ▾ | Lowest ▾ | Lowest ▾ |
| DSCP | 16 | 17 | 18 | 19 | 20 | 21 | 22 | 23 |
| Priority | Low ▾ | Low ▾ | Low ▾ | Low ▾ | Low ▾ | Low ▾ | Low ▾ | Low ▾ |
| DSCP | 24 | 25 | 26 | 27 | 28 | 29 | 30 | 31 |
| Priority | Low ▾ | Low ▾ | Low ▾ | Low ▾ | Low ▾ | Low ▾ | Low ▾ | Low ▾ |
| DSCP | 32 | 33 | 34 | 35 | 36 | 37 | 38 | 39 |
| Priority | Middle ▾ | Middle ▾ | Middle ▾ | Middle ▾ | Middle ▾ | Middle ▾ | Middle ▾ | Middle ▾ |
| DSCP | 40 | 41 | 42 | 43 | 44 | 45 | 46 | 47 |
| Priority | Middle ▾ | Middle ▾ | Middle ▾ | Middle ▾ | Middle ▾ | Middle ▾ | Middle ▾ | Middle ▾ |
| DSCP | 48 | 49 | 50 | 51 | 52 | 53 | 54 | 55 |
| Priority | High ▾ | High ▾ | High ▾ | High ▾ | High ▾ | High ▾ | High ▾ | High ▾ |
| DSCP | 56 | 57 | 58 | 59 | 60 | 61 | 62 | 63 |
| Priority | High ▾ | High ▾ | High ▾ | High ▾ | High ▾ | High ▾ | High ▾ | High ▾ |

Apply Help

The following table describes the labels in this screen

| Label | Description |
|----------|---|
| TOS/DSCP | TOS (Type of Service) is a field in IP header of a packet . This TOS field is also used by Differentiated Services and is called the Differentiated Services Code Point (DSCP). The output priority of a packet can be determined by this field and the priority value is supported 0to63. DSCP value map to 4 priority queues: High, Middle, Low, and Lowest . |
| Apply | Click “Apply” to set the configurations. |
| Help | Show help file. |

5.2.7 Multicast

5.2.7.1 IGMP Snooping

Internet Group Management Protocol (IGMP) is used by IP hosts to register their dynamic multicast group membership. IGMP has 3 versions, IGMP v1, v2 and v3. Please refer to RFC

1112, 2236 and 3376. IGMP Snooping improves the performance of networks that carry multicast traffic. It provides the ability to prune multicast traffic so that it travels only to those end destinations that require that traffic and reduces the amount of traffic on the Ethernet LAN.

Figure 38: IGMP Snooping

IGMP Snooping

IGMP Snooping :

IGMP Query Mode:

IGMP Snooping Table

| IP Address | VLAN ID | Member Port |
|------------|---------|-------------|
| | | |

The following table describes the labels in this screen.

| Label | Description |
|---------------------|--|
| IGMP Snooping Table | Show current IP multicast list |
| IGMP Protocol | Enable/Disable IGMP snooping. |
| IGMP Query | Switch will be IGMP querier or not . There should exist one and only one IGMP querier in an IGMP application. The "Auto" mode means that the querier is the one with lower IP address. |
| Apply | Click "Apply" to set the configurations. |
| Help | Show help file. |

5.2.7.2 Static Multicast Filtering

Static Multicast filtering is the system by which end stations only receive multicast traffic if they register to join specific multicast groups. With multicast filtering, network devices only forward multicast traffic to the ports that are connected to registered end stations.

Figure 39: Multicast Filtering

Multicast Filtering

IP Address

Member Ports Port.01 Port.02 Port.03 Port.04
 Port.05 Port.06 Port.07 Port.08

Multicast Filtering List

| IP Address | Member Ports |
|------------|--------------|
|------------|--------------|

The following table describes the labels in this screen.

| Label | Description |
|--------------|---|
| IP Address | Assign a multicast group IP address in the range of 224.0.0.0 ~ |
| Member Ports | Tick the check box beside the port number to include them as the member ports in the specific multicast group IP address. |
| Add | Show current IP multicast list |
| Delete | Delete an entry from table |
| Help | Show help file. |

5.2.8 Security

Five useful functions can enhance security of switch: IP Security, Port Security, MAC Blacklist , and MAC address Aging and 802.1x protocol.

5.2.8.1 IP Security

Only IP in the Secure IP List can manage the switch through your defined management mode. (WEB, SNMP)

Figure 40: IP Security

IP Security

IP Security Mode:

Enable WEB Management

Enable SNMP Management

| Secure IP List | |
|----------------|---------|
| Secure IP1 | 0.0.0.0 |
| Secure IP2 | 0.0.0.0 |
| Secure IP3 | 0.0.0.0 |
| Secure IP4 | 0.0.0.0 |
| Secure IP5 | 0.0.0.0 |
| Secure IP6 | 0.0.0.0 |
| Secure IP7 | 0.0.0.0 |
| Secure IP8 | 0.0.0.0 |
| Secure IP9 | 0.0.0.0 |
| Secure IP10 | 0.0.0.0 |

The following table describes the labels in this screen.

| Label | Description |
|------------------------|--|
| IP security mode | Enable/Disable the IP security function. |
| Enable WEB Management | Mark the blank to enable WEB Management . |
| Enable SNMP Management | Mark the blank to enable SNMP Management . |
| Apply | Click “Apply” to set the configurations. |
| Help | Show help file. |

5.2.8.2 Port Security

Static MAC Forwarding is to add static MAC addresses to hardware forwarding database. If port security is enabled at Port Control page, only the frames with MAC addresses in this list will be forwarded, otherwise will be discarded.

Figure 41: Port Security

Port Security

MAC Address

Port No. Port.01

Port Security List

| MAC Address | Port |
|-------------|------|
|-------------|------|

The following table describes the labels in this screen.

| Label | Description |
|-------------|---|
| MAC Address | Input MAC Address to a specific port . |
| Port NO. | Select port of switch. |
| Add | Add an entry of MAC and port information. |
| Delete | Delete the entry. |
| Help | Show help file. |

5.2.8.3 MAC Blacklist

MAC Blacklist can eliminate the traffic forwarding to specific MAC addresses in list . Any frames forwarding to MAC addresses in this list will be discarded. Thus the target device will never receive any frame.

Figure 42: MAC Blacklist

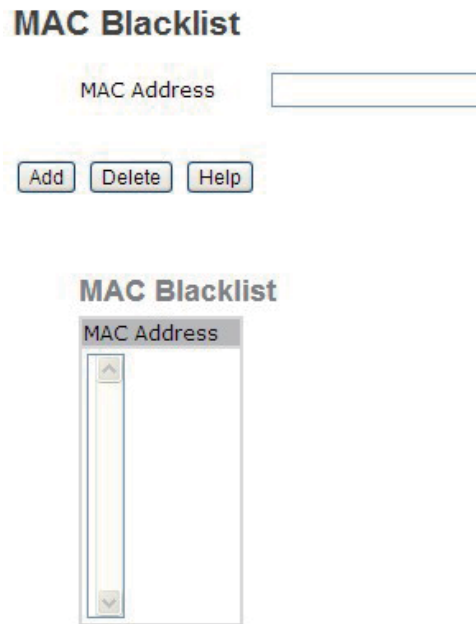

The following table describes the labels in this screen.

| Label | Description |
|-------------|---|
| MAC Address | Input MAC Address to add to MAC Blacklist . |
| Port NO. | Select port of switch. |
| Add | Add an entry to Blacklist table. |
| Delete | Delete the entry. |
| Help | Show help file. |

5.2.8.4 802.1x

802.1x - Radius Server

802.1x makes the use of the physical access characteristics of IEEE802 LAN infrastructures in order to provide a authenticated and authorized devices attached to a LAN port . Please refer to IEEE 802.1X - Port Based Network Access Control.

Figure 43: 802.1x - Radius Server

802.1x - Radius Server

Radius Server Setting

| | |
|------------------|---------------|
| 802.1x Protocol | Disable ▾ |
| Radius Server IP | 192.168.16.3 |
| Server Port | 1812 |
| Accounting Port | 1813 |
| Shared Key | 12345678 |
| NAS, Identifier | NAS_L2_SWITCH |

Advanced Setting

| | |
|--------------------|------|
| Quiet Period | 60 |
| TX Period | 30 |
| Supplicant Timeout | 30 |
| Server Timeout | 30 |
| Max Requests | 2 |
| Re-Auth Period | 3600 |

The following table describes the labels in this screen.

| Label | Description |
|--------------------|--|
| 802.1x Portocol | Enable or Disable 802.1X Radius Server function . |
| Radius Server IP | The IP address of the authentication server. |
| Server port | Set the UDP port number used by the authentication server to authenticate. |
| Account port | Set the UDP destination port for accounting requests to the specified Radius Server. |
| Shared Key | A key shared between this switch and authentication server. |
| NAS, Identifier | A string used to identify this switch. |
| Advanced Setting | |
| Quiet Period | Set the time interval between authentication failure and the start of a new authentication attempt . |
| Tx Period | Set the time that the switch can wait for response to an EAP request/identity frame from the client before resending the request . |
| Supplicant Timeout | Set the period of time the switch waits for a supplicant response to an EAP request . |
| Server Timeout | Set the period of time the switch waits for a Radius ser ver response to an authentication request . |
| Max Requests | Set the maximum number of times to retry sending packets to the supplicant . |
| Re-Auth Period | Set the period of time after which clients connected must be re-authenticated. |
| Apply | Click "Apply" to set the configurations. |
| Help | Show help file. |

802.1x-Port Authorized Mode

Set the 802.1x authorized mode of each port .

Figure 44: Port Authorized Mode

802.1x - Port Authorize Mode

| Port No. | Port Authorize Mode |
|----------|---------------------|
| Port.01 | Accept |
| Port.02 | Accept |
| Port.03 | Accept |
| Port.04 | Accept |
| Port.05 | Accept |
| Port.06 | Accept |
| Port.07 | Accept |
| Port.08 | Accept |

Apply Help

The following table describes the labels in this screen.

| Label | Description |
|----------------------|---|
| Port Authorized Mode | <ul style="list-style-type: none"> ▪ Reject: force this port to be unauthorized. ▪ Accept: force this port to be authorized. ▪ Authorize: the state of this port was determined by the outcome of the 802.1x authentication. ▪ Disable: this port will not participate in 802.1x. |
| Apply | Click “Apply” to set the configurations. |
| Help | Show help file. |

802.1x-Port Authorized Mode

Show 802.1x port authorized state

Figure 45: 802.1x Port Authorized Mode

802.1x - Port Authorize State

| Port No. | Port Authorize State |
|----------|----------------------|
| Port.01 | Accept |
| Port.02 | Accept |
| Port.03 | Accept |
| Port.04 | Accept |
| Port.05 | Accept |
| Port.06 | Accept |
| Port.07 | Accept |
| Port.08 | Accept |

5.2.8.5 Warning

Warning function is very important for managing switch. You can manage switch by SYSLOG, E-MAIL, and Fault Relay. It helps you to monitor the switch status on remote site. When events occurred, the warning message will send to your appointed server, E-MAIL, or relay fault to switch panel.

System alarm support two warning mode: 1. SYSLOG. 2. E-MAIL . You can monitor switch through selected system events.

Warning – Fault Relay Alarm

When any selected fault event is happened, the Fault LED in switch panel will light up and the electric relay will signal at the same time.

Figure 46: Fault Alarm

Fault Alarm

Power Failure

PWR 1 PWR 2

Port Link Down/Broken

Port.01 Port.02
 Port.03 Port.04
 Port.05 Port.06
 Port.07 Port.08

System Warning – SYSLOG Setting

The SYSLOG is a protocol to transmit event notification messages across networks. Please refer to RFC 3164 - The BSD SYSLOG Protocol

Figure 47: System Warning - Syslog Setting

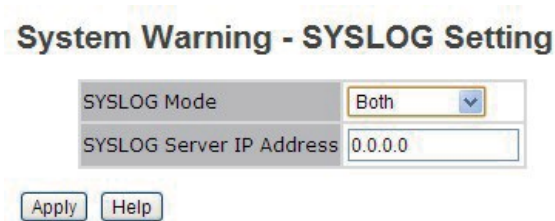

The following table describes the labels in this screen.

| Label | Description |
|--------------------------|--|
| SYSLOG Mode | <ul style="list-style-type: none">▪ Disable: disable SYSLOG.▪ Client Only: log to local system.▪ Server Only: log to a remote SYSLOG server.▪ Both: log to both of local and remote server. |
| SYSLOG Server IP Address | The remote SYSLOG Server IP address. |
| Apply | Click “Apply” to set the configurations. |
| Help | Show help file system. |

The SMTP is Short for Simple Mail Transfer Protocol. It is a protocol for e-mail transmission across the Internet . Please refer to RFC 821 - Simple Mail Transfer Protocol.

Figure 48: System Warning - SMTP Setting

System Warning - SMTP Setting

E-mail Alert : Disable ▾

| | |
|---|--|
| SMTP Server Address | <input type="text" value="0.0.0.0"/> |
| Sender E-mail Address | <input type="text" value="administrator"/> |
| Mail Subject | <input type="text" value="Automated Email Alert"/> |
| <input type="checkbox"/> Authentication | |
| Recipient E-mail Address 1 | <input type="text"/> |
| Recipient E-mail Address 2 | <input type="text"/> |
| Recipient E-mail Address 3 | <input type="text"/> |
| Recipient E-mail Address 4 | <input type="text"/> |
| Recipient E-mail Address 5 | <input type="text"/> |
| Recipient E-mail Address 6 | <input type="text"/> |

Apply Help

| Label | Description |
|--------------------------|--|
| E-mail Alert | Enable/Disable transmission system warning events by e-mail. |
| SMTP Server IP Address | Setting up the mail server IP address |
| Mail Subject | The Subject of the mail |
| Sender | Set up the email account to send the alert . |
| Authentication | <ul style="list-style-type: none"> ■ Username: the authentication username. ■ Password: the authentication password. ■ Confirm Password: re-enter password. |
| Recipient E-mail Address | The recipient's E-mail address. It supports 6 recipients for a mail. |
| Apply | Click "Apply" to set the configurations. |
| Help | Show help file. |

System Warning – Event Selection

SYSLOG and SMTP are the two warning methods that supported by the system. Check the corresponding box to enable system event warning method you wish to choose. Please note that the checkbox can not be checked when SYSLOG or SMTP is disabled.

Figure 49: System Warning - Event Selection

System Warning - Event Selection

System Event

| Event | SYSLOG | SMTP |
|--------------------------------|--------------------------|--------------------------|
| System Cold Start | <input type="checkbox"/> | <input type="checkbox"/> |
| Power Status | <input type="checkbox"/> | <input type="checkbox"/> |
| SNMP Authentication Failure | <input type="checkbox"/> | <input type="checkbox"/> |
| Redundant Ring Topology Change | <input type="checkbox"/> | <input type="checkbox"/> |

System Warning - Event Selection

System Event

| Event | SYSLOG | SMTP |
|--------------------------------|--------------------------|--------------------------|
| System Cold Start | <input type="checkbox"/> | <input type="checkbox"/> |
| Power Status | <input type="checkbox"/> | <input type="checkbox"/> |
| SNMP Authentication Failure | <input type="checkbox"/> | <input type="checkbox"/> |
| Redundant Ring Topology Change | <input type="checkbox"/> | <input type="checkbox"/> |

Port Event

| Port No. | SYSLOG | SMTP |
|----------|--------------------------------------|--------------------------------------|
| Port.01 | <input type="text" value="Disable"/> | <input type="text" value="Disable"/> |
| Port.02 | <input type="text" value="Disable"/> | <input type="text" value="Disable"/> |

The following table describes the labels in this screen.

| Label | Description |
|--------------------------------|--|
| System Cold Start | When the device executes cold start , the system will issue a log event . |
| Power Status | Alert When the power failure |
| Authentication Failure | Alert when SNMP authentication failure. |
| Redundant ring topology change | Alert when redundant topology changes. |
| Port Event | <ul style="list-style-type: none"> ■ Disable ■ Link Up ■ Link Down ■ Link Up & Link Down |
| Apply | Click “Apply” to set the configurations. |
| Help | Show help file. |

5.2.9 Monitor and Diagnostics

5.2.9.1 MAC Address Table

The MAC Address Table, that is Filtering Database, supports queries by the Forwarding Process, as to whether a frame received by a given port with a given destination MAC address is to be forwarded through a given potential transmission port .

Figure 50: MAC Address Table

MAC Address Table

Port No : Port.01 ▼

Current MAC Address

Dynamic Address Count : 0
Static Address Count : 0

Clear MAC Table
Help

MAC Address Aging

MAC Address Table Aging Time: (0~3825) 300 secs

Auto Flush MAC Address Table When Ports Link Down

Apply
Help

The following table describes the labels in this screen.

| Label | Description |
|---------------------------------------|---|
| Port NO. : | Show all MAC addresses mapping to a selected port in table. |
| Clear Mac Table | Clear all MAC addresses in table |
| Auto Flush Table When Ports Link Down | Enable this function , when port link down , switch will Flush MAC table. |
| MAC Address Auto Learning | Enable or Disable MAC Learning function . |
| Apply | Click “Apply” to set the configurations. |

5.2.9.2 Port Statistics

Figure 51: Port Statistics

Port Statistics

| Port | Type | Link | State | Tx Good Packet | Tx Bad Packet | Rx Good Packet | Rx Bad Packet | Tx Abort Packet | Packet Collision |
|---------|-------|------|--------|----------------|---------------|----------------|---------------|-----------------|------------------|
| Port.01 | 100TX | Down | Enable | 0 | 0 | 0 | 0 | 0 | 0 |
| Port.02 | 100TX | Down | Enable | 0 | 0 | 0 | 0 | 0 | 0 |
| Port.03 | 100TX | Up | Enable | 11060 | 0 | 20537 | 0 | 0 | 0 |
| Port.04 | 100TX | Down | Enable | 0 | 0 | 0 | 0 | 0 | 0 |
| Port.05 | 100TX | Up | Enable | 977 | 0 | 1115 | 0 | 0 | 0 |
| Port.06 | 100TX | Down | Enable | 0 | 0 | 0 | 0 | 0 | 0 |
| Port.07 | 100TX | Down | Enable | 0 | 0 | 0 | 0 | 0 | 0 |
| Port.08 | 100TX | Down | Enable | 0 | 0 | 0 | 0 | 0 | 0 |

5.2.9.3 System Event Log

If system log client is enabled, the system event logs will be shown in this table.

Figure 52: System Event Log

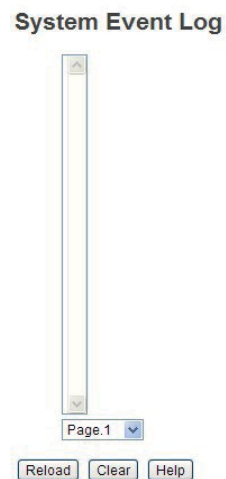

The following table describes the labels in this screen.

| Label | Description |
|--------|---|
| Page | Select LOG page. |
| Reload | To get the newest event logs and refresh this page. |
| Clear | Clear log. |
| Help | Show help file. |

5.2.9.4 Port Monitoring

Port monitoring function supports TX (egress) only, RX (ingress) only, and both TX/RX monitoring. TX monitoring sends any data that egress out checked TX source ports to a selected TX destination port as well. RX monitoring sends any data that ingress in checked RX source ports out to a selected RX destination port as well as sending the frame where it normally would have gone. Note that keep all source ports unchecked in order to disable port monitoring.

Figure 53: Port Monitoring

Port Monitoring

| Port | Destination Port | | Source Port | |
|---------|----------------------------------|----------------------------------|--------------------------|--------------------------|
| | RX | TX | RX | TX |
| Port.01 | <input checked="" type="radio"/> | <input checked="" type="radio"/> | <input type="checkbox"/> | <input type="checkbox"/> |
| Port.02 | <input type="radio"/> | <input type="radio"/> | <input type="checkbox"/> | <input type="checkbox"/> |
| Port.03 | <input type="radio"/> | <input type="radio"/> | <input type="checkbox"/> | <input type="checkbox"/> |
| Port.04 | <input type="radio"/> | <input type="radio"/> | <input type="checkbox"/> | <input type="checkbox"/> |
| Port.05 | <input type="radio"/> | <input type="radio"/> | <input type="checkbox"/> | <input type="checkbox"/> |
| Port.06 | <input type="radio"/> | <input type="radio"/> | <input type="checkbox"/> | <input type="checkbox"/> |
| Port.07 | <input type="radio"/> | <input type="radio"/> | <input type="checkbox"/> | <input type="checkbox"/> |
| Port.08 | <input type="radio"/> | <input type="radio"/> | <input type="checkbox"/> | <input type="checkbox"/> |

The following table describes the labels in this screen.

| Label | Description |
|------------------|---|
| Destination Port | The port will receive a copied frame from source port for monitoring purpose. |
| Source Port | The port will be monitored. Mark the blank of TX or RX to be monitored. |
| TX | The frames come into switch port . |
| RX | The frames receive by switch port . |
| Apply | Click “Apply” to activate the configurations. |
| Clear | Clear all marked blank.(disable the function) |
| Help | Show help file. |

5.2.9.5 Save Configuration

If any configuration changed, “Save Configuration” should be clicked to save current configuration data to the permanent flash memory. Otherwise, the current configuration will be lost when power off or system reset.

Figure 54: Save Configuration

Save Configuration



The following table describes the labels in this screen.

| Label | Description |
|-------|--------------------------|
| Save | Save all configurations. |
| Help | Show help file. |

5.2.9.6 Factory Default

Figure 55: Factory Default

Factory Default

- Keep current IP address setting?
- Keep current username & password?

Reset switch to default configuration. Click to reset all configurations to the default value. You can select “Keep current IP address setting” and “Keep current username & password” to keep current IP and username and password.

5.2.9.7 System Reboot

Figure 56: System Reboot

System Reboot

Please click [\[Reboot\]](#) button to restart switch device.

Section 6: Command Line Interface Management

6.1 About CLI Management

Besides WEB-base management , SLM080 also supports CLI management . You can use console to management switch by CLI.

CLI Management by RS-232 Serial Console (9600, 8, none, 1, none)

Before Configuring by RS-232 serial console, use an RJ45 to DB9-F cable to connect the Switches' RS-232 Console port to your PCs' COM port .

Follow the steps below to access the console via RS-232 serial cable.

1. From the Windows desktop, click on Start -> Programs -> Accessories -> Communications -> Hyper Terminal
2. Input a name for new connection

Figure 57: Input Name

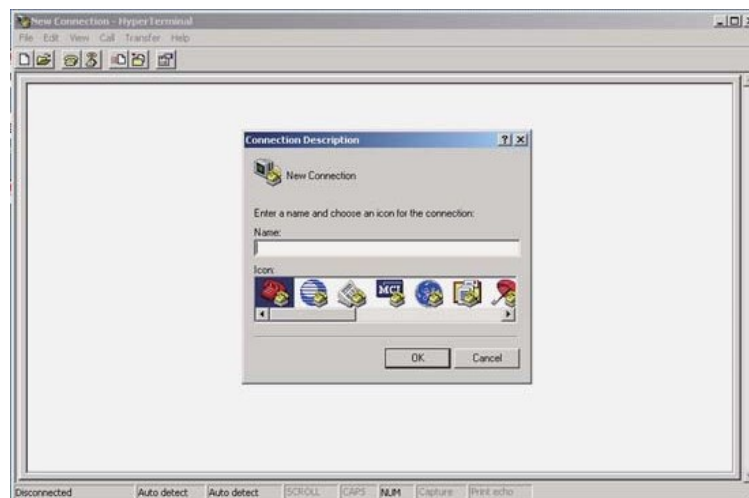

3. Select to use COM port number

Figure 58: COM Port Number

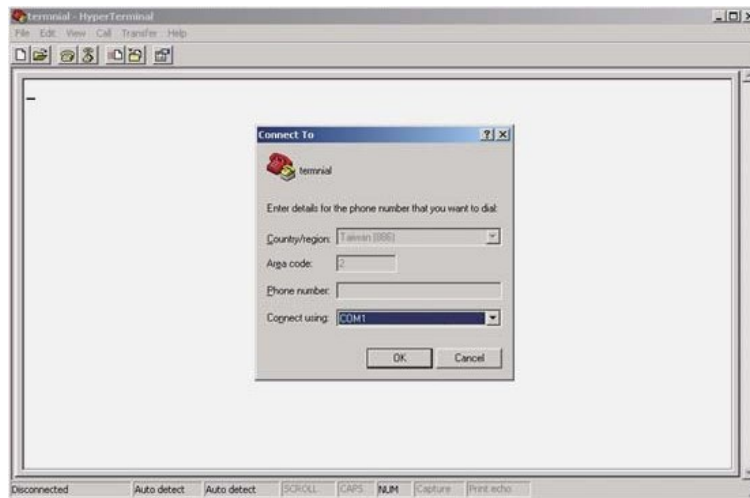

4. The COM port properties setting, 9600 for Bits per second, 8 for Data bits, None for Parity, 1 for Stop bits and none for Flow control.

Figure 59: COM Port Properties

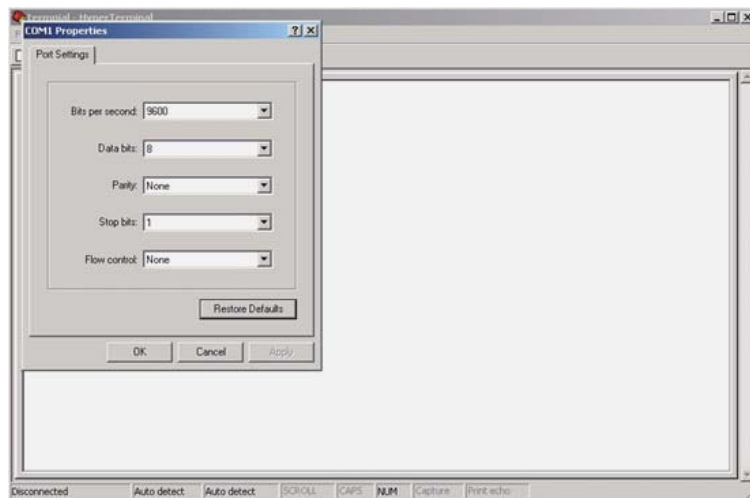

- The Console login screen will appear. Use the keyboard to enter the Username and Password (The same with the password for Web Browser), then press **Enter**.

Figure 60: SLM080

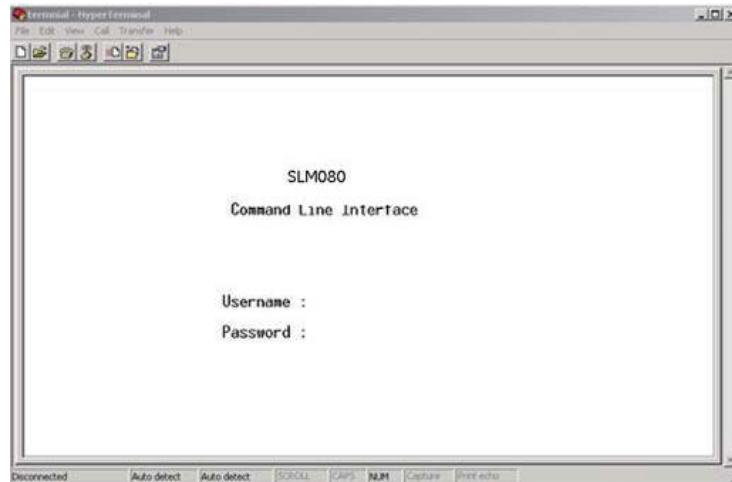

Commands Level

| Modes | Access Method | Prompt | Exit Method | About This Model |
|----------------------|--|-----------------|---|---|
| User EXEC | Begin a session with your switch. | switch> | Enter logout or quit . | The user command available at the level of user is the subset of those available at the privileged level. Use this mode to <ul style="list-style-type: none"> • Enter menu mode. • Display system information. |
| Privileged EXEC | Enter the enable command while in user EXEC mode. | switch# | Enter disable to exit . | The privileged command is advance mode Privileged this mode to <ul style="list-style-type: none"> • Display advance function status • save configures |
| Global configuration | Enter the configure command while in privileged EXEC mode. | switch(config)# | To exit to privileged EXEC mode, enter exit | Use this mode to configure parameters that apply to your Switch as a whole. |

| Modes | Access Method | Prompt | Exit Method | About This Model |
|-------------------------|--|------------------------|---|--|
| | | | or end | |
| VLAN database | Enter the vlan database command while in privileged EXEC mode. | switch(vlan)# | To exit to user EXEC mode, enter exit. | Use this mode to configure VLAN-specific parameters. |
| Interface configuration | Enter the interface command (with a specific interface) while in global configuration mode | switch (config-if)# | To exit to global configuration mode, enter exit. To exist privileged EXEC mode or end. | Use this mode to configure parameters for the switch and Ethernet ports. |

Symbol of Command Level

| Mode | Symbol of Command Level |
|-------------------------|-------------------------|
| User EXEC | E |
| Privileged EXEC | P |
| Global configuration | G |
| VLAN database | V |
| Interface configuration | I |

6.2 Commands Set List—System Commands Set

| SLM080Commands | Level | Description | Example |
|---|-------|---|---|
| show config | E | Show switch configuration | switch>show config |
| show terminal | P | Show console information | switch#show terminal |
| write memory | P | Save your configuration into permanent memory (flash rom) | switch#write memory |
| system name [System Name] | G | Configure system name | switch(config)#system name xxx |
| system location [System Location] | G | Set switch system location string | switch(config)#system location xxx |
| system description [System Description] | G | Set switch system description string | switch(config)#system description xxx |
| system contact [System Contact] | G | Set switch system contact window string | switch(config)#system contact xxx |
| show system-info | E | Show system information | switch>show system-info |
| ip address [Ip-address] [Subnet-mask] [Gateway] | G | Configure the IP address of switch | switch(config)#ip address 192.168.1.1 255.255.255.0 192.168.1.254 |
| ip dhcp | G | Enable DHCP client function of switch | switch(config)#ip dhcp |
| show ip | P | Show IP information of switch | switch#show ip |
| no ip dhcp | G | Disable DHCP client function of switch | switch(config)#no ip dhcp |
| reload | G | Halt and perform a cold restart | switch(config)#reload |

| SLM080Commands | Level | Description | Example |
|---|-------|---|---|
| default | G | Restore to default | Switch(config)#default |
| admin username [Username] | G | Changes a login username. (maximum 10 words) | switch(config)#admin username xxxxxx |
| admin password [Password] | G | Specifies a password (maximum 10 words) | switch(config)#admin password xxxxxx |
| show admin | P | Show administrator information | switch#show admin |
| dhcpserver enable | G | Enable DHCP Server | switch(config)#dhcpserver enable |
| dhcpserver lowip [Low IP] | G | Configure low IP address for IP pool | switch(config)# dhcpserver lowip 192.168.1.1 |
| dhcpserver highip [High IP] | G | Configure high IP address for IP pool | switch(config)# dhcpserver highip 192.168.1.50 |
| dhcpserver subnetmask [Subnet mask] | G | Configure subnet mask for DHCP clients | switch(config)#dhcpserver subnetmask 255.255.255.0 |
| dhcpserver gateway [Gateway] | G | Configure gateway for DHCP clients | switch(config)#dhcpserver gateway 192.168.1.254 |
| dhcpserver dnsip [DNS IP] | G | Configure DNS IP for DHCP clients | switch(config)# dhcpserver dnsip 192.168.1.1 |
| dhcpserver leasetime [Hours] | G | Configure lease time (in hour) | switch(config)#dhcpserver leasetime 1 |
| dhcpserver ipbinding [IP address] | I | Set static IP for DHCP clients by port | switch(config)#interface fastEthernet 2 switch(config- if)#dhcpserver ipbinding 192.168.1.1 |

| SLM080Commands | Level | Description | Example |
|---|-------|--|---|
| show dhcpserver configuration | P | Show configuration of DHCP server | switch#show dhcpser ver configuration |
| show dhcpserver clients | P | Show client entries of DHCP server | switch#show dhcpserver clinets |
| show dhcpserver ip-binding | P | Show IP-Binding information of DHCP server | switch#show dhcpserver ip-binding |
| no dhcpserver | G | Disable DHCP server function | switch(config)#no dhcpserver |
| security enable | G | Enable IP security function | switch(config)#security enable |
| security http | G | Enable IP security of HTTP server | switch(config)#security http |
| security ip [Index(1..10)] [IP Address] | G | Set the IP security list | switch(config)#security ip 1 192.168.1.55 |
| show security | P | Show the information of IP security | switch#show security |
| no security | G | Disable IP security function | switch(config)#no security |
| no security http | G | Disable IP security of HTTP server | switch(config)#no security http |

6.3 Commands Set List—Port Commands Set

| SLM080 Commands | Level | Description | Example |
|--|-------|---|---|
| interface fastEthernet [Portid] | G | Choose the port for modification. | switch(config)#interface fastEthernet 2 |
| duplex [full half] | I | Use the duplex configuration command to specify the duplex mode of operation for Fast Ethernet. | switch(config)#interface fastEthernet 2 switch(config-if)#duplex full |
| speed [10 100 1000 auto] | I | Use the speed configuration command to specify the speed mode of operation for Fast Ethernet., the speed can't be set to 1000 if the port isn't a giga port.. | switch(config)#interface fastEthernet 2 switch(config-if)#speed 100 |
| flowcontrol mode [Symmetric Asymmetric] | I | Use the flowcontrol configuration command on Ethernet ports to control traffic rates during congestion. | switch(config)#interface fastEthernet 2 switch(config- if)#flowcontrol mode Asymmetric |
| no flowcontrol | I | Disable flow control of interface | switch(config-if)#no flowcontrol |
| security enable | I | Enable security of interface | switch(config)#interface fastEthernet 2 switch(config- if)#security enable |
| no security | I | Disable security of interface | switch(config)#interface fastEthernet 2 switch(config-if)#no security |
| | | | switch(config)#interface |

| SLM080 Commands | Level | Description | Example |
|--|-------|--|---|
| bandwidth type all | I | Set interface ingress limit frame type to “accept all frame” | fastEthernet 2 switch(config-if)#bandwidth type all |
| bandwidth type broadcast-multicast-flooded-unicast | I | Set interface ingress limit frame type to “accept broadcast, multicast, and flooded unicast frame” | switch(config)#interface fastEthernet 2 switch(config-if)#bandwidth type broadcast-multicast-flooded-unicast |
| bandwidth type broadcast-multicast | I | Set interface ingress limit frame type to “accept broadcast and multicast frame” | switch(config)#interface fastEthernet 2 switch(config-if)#bandwidth type broadcast-multicast |
| bandwidth type broadcast-only | I | Set interface ingress limit frame type to “only accept broadcast frame” | switch(config)#interface fastEthernet 2 switch(config-if)#bandwidth type broadcast-only |
| bandwidth in [Value] | I | Set interface input bandwidth. Rate Range is from 100 kbps to 102400 kbps or to 256000 kbps for giga ports, and zero means no limit. | switch(config)#interface fastEthernet 2 switch(config-if)#bandwidth in 100 |
| bandwidth out [Value] | I | Set interface output bandwidth. Rate Range is from 100 kbps to 102400 kbps or to 256000 kbps for giga ports, and zero means no limit . | switch(config)#interface fastEthernet 2 switch(config-if)#bandwidth out 100 |
| show bandwidth | I | Show interfaces bandwidth control | switch(config)#interface fastEthernet 2 switch(config-if)#show bandwidth |
| | | Use the state interface configuration command to specify the state mode of operation for Ethernet ports. Use the disable form of this command to | switch(config)#interface fastEthernet 2 switch(config-if)#state Disable |

| SLM080 Commands | Level | Description | Example |
|------------------------------|-------|--|--|
| state [Enable Disable] | 1 | disable the port . | |
| show interface configuration | 1 | show interface configuration status | switch(config)#interface fastEthernet 2 switch(config-if)#show interface configuration |
| show interface status | 1 | show interface actual status | switch(config)#interface fastEthernet 2 switch(config-if)#show interface status |
| show interface accounting | 1 | show interface statistic counter | switch(config)#interface fastEthernet 2 switch(config-if)#show interface accounting |
| no accounting | 1 | Clear interface accounting information | switch(config)#interface fastEthernet 2 switch(config-if)#no accounting |

6.4 Commands Set List—Trunk Command Set

| SLM080 Commands | Level | Description | Example |
|--|-------|---|---|
| aggregator priority [1to65535] | G | Set port group system priority | switch(config)#aggregator priority 22 |
| aggregator activityport [Port Numbers] | G | Set activity port | switch(config)#aggregator activityport 2 |
| aggregator group [GroupID] [Port-list] lacp workp [Workport] | G | Assign a trunk group with LACP active. [GroupID] :1to3 [Port-list]:Member port list, This parameter could be a port range(ex.1-4) or a port list separate by a comma(ex.2, 3, 6) [Workport]: The amount of work ports, this value could not be less than zero or be large than the amount of member ports. | switch(config)#aggregator group 1 1-4 lacp workp 2 or switch(config)#aggregator group 2 1,4,3 lacp workp 3 |
| aggregator group [GroupID] [Port-list] nolacp | G | Assign a static trunk group. [GroupID] :1to3 [Port-list]:Member port list , This parameter could be a port range(ex.1-4) or a port list separate by a comma(ex.2, 3, 6) | switch(config)#aggregator group 1 2-4 nolacp or switch(config)#aggregator group 1 3,1,2 nolacp |
| show aggregator | P | Show the information of trunk group | switch#show aggregator |
| no aggregator lacp [GroupID] | G | Disable the LACP function of trunk group | switch(config)#no aggregator lacp 1 |
| no aggregator group [GroupID] | G | Remove a trunk group | switch(config)#no aggregator group 2 |

6.5 Commands Set List—VLAN command set

| SLM080 Commands | Level | Description | Example |
|--|-------|---|--|
| vlan database | P | Enter VLAN configure mode | switch#vlan database |
| vlan [8021q gvrp] | V | To set switch VLAN mode. | switch(vlan)# vlanmode 802.1q or switch(vlan)# vlanmode gvrp |
| no vlan [VID] | V | Disable vlan group(by VID) | switch(vlan)#no vlan 2 |
| no gvrp | V | Disable GVRP | switch(vlan)#no gvrp |
| IEEE 802.1Q VLAN | | | |
| vlan 8021q port [PortNumber] access- link untag [UntaggedVID] | V | Assign a access link for VLAN by port , if the port belong to a trunk group, this command can't be applied. | switch(vlan)#vlan 802.1q port 3 access-link untag 33 |
| vlan 8021q port [PortNumber] trunk- link tag [TaggedVID List] | V | Assign a trunk link for VLAN by port , if the port belong to a trunk group, this command can't be applied. | switch(vlan)#vlan 8021q port 3 trunk-link tag 2,3,6,99 or switch(vlan)#vlan 8021q port 3 trunk-link tag 3-20 |
| vlan 8021q port [PortNumber] hybrid- link untag [UntaggedVID] tag [TaggedVID List] | V | Assign a hybrid link for VLAN by port , if the port belong to a trunk group, this command can't be applied. | switch(vlan)# vlan 8021q port 3 hybrid-link untag 4 tag 3,6,8 or switch(vlan)# vlan 8021q port 3 hybrid-link untag 5 tag 6-8 |
| vlan 8021q aggregator [TrunkID] access-link untag [UntaggedVID] | V | Assign a access link for VLAN by trunk group | switch(vlan)#vlan 8021q aggregator 3 access-link untag 33 |

| | | | |
|--|----------|---|--|
| <p>vlan 8021q aggregator [TrunkID] trunk-link tag [TaggedVID List]</p> | <p>V</p> | <p>Assign a trunk link for VLAN by trunk group</p> | <p>switch(vlan)#vlan 8021q aggregator 3 trunk-link tag 2,3,6,9 9 or switch(vlan)#vlan 8021q aggregator 3 trunk-link tag 3- 20</p> |
| <p>vlan 8021q aggregator [PortNumber] hybrid-link untag [UntaggedVID] tag [TaggedVID List]</p> | <p>V</p> | <p>Assign a hybrid link for VLAN by trunk group</p> | <p>switch(vlan)# vlan 8021q aggr eator 3 hybrid-link untag 4 tag 3,6,8 or switch(vlan)# vlan 8021q aggr eator 3 hybrid-link untag 5 tag 6-8</p> |
| <p>show vlan [VID] or show vlan</p> | <p>V</p> | <p>Show VLAN information</p> | <p>switch(vlan)#show vlan 23</p> |

6.6 Commands Set List—Spanning Tree command set

| SLM080 Commands | Level | Description | Example |
|--------------------------------------|-------|---|---|
| spanning-tree enable | G | Enable spanning tree | switch(config)#spanning-tree enable |
| spanning-tree priority [0to61440] | G | Configure spanning tree priority parameter | switch(config)#spanning-tree priority 32767 |
| spanning-tree max-age [seconds] | G | Use the spanning-tree max-age global configuration command to change the interval between messages the spanning tree receives from the root switch. If a switch does not receive a bridge protocol data unit (BPDU) message from the root switch within this interval, it recomputed the Spanning Tree Protocol (STP) topology. | switch(config)# spanning-tree max-age 15 |
| spanning-tree hello-time [seconds] | G | Use the spanning-tree hello-time global configuration command to specify the interval between hello bridge protocol data units (BPDUs). | switch(config)#spanning-tree hello-time 3 |
| spanning-tree forward-time [seconds] | G | Use the spanning-tree forward-time global configuration command to set the forwarding-time for the specified spanning-tree instances. The forwarding time determines how long each of the listening and learning states last before the port begins forwarding. | switch(config)# spanning-tree forward-time 20 |

| | | | |
|--------------------------------------|---|--|---|
| stp-path-cost [1to200000000] | I | Use the spanning-tree cost interface configuration command to set the path cost for Spanning Tree Protocol (STP) calculations. In the event of a loop, spanning tree considers the path cost when selecting an interface to place into the forwarding state. | switch(config)#interface fastEthernet 2 switch(config-if)#stp-path-cost 20 |
| stp-path-priority [Port Priority] | I | Use the spanning-tree port-priority interface configuration command to configure a port priority that is used when two switches tie for position as the root switch. | switch(config)#interface fastEthernet 2 switch(config-if)# stp-path-priority 127 |
| stp-admin-p2p [Auto True False] | I | Admin P2P of STP priority on this interface. | switch(config)#interface fastEthernet 2 switch(config-if)# stp-admin-p2p Auto |
| stp-admin-edge [True False] | I | Admin Edge of STP priority on this interface. | switch(config)#interface fastEthernet 2 switch(config-if)# stp-admin-edge True |
| stp-admin-non-stp [True False] | I | Admin NonSTP of STP priority on this interface. | switch(config)#interface fastEthernet 2 switch(config-if)# stp-admin-non-stp False |
| Show spanning-tree | E | Display a summary of the spanning-tree states. | switch>show spanning-tree |
| no spanning-tree | G | Disable spanning-tree. | switch(config)#no spanning-tree |

6.7 Commands Set List—QoS command set

| SLM080 Commands | Level | Description | Example |
|---|-------|---|--|
| qos policy [weighted-fair strict] | G | Select QOS policy scheduling | switch(config)#qos policy weighted-fair |
| qos prioritytype [port- based cos- only tos- only cos- first tos- first] | G | Setting of QOS priority type | switch(config)#qos prioritytype |
| qos priority portbased [Port] [lowest low middle high] | G | Configure Port-based Priority | switch(config)#qos priority portbased 1 low |
| qos priority cos [Priority] [lowest low middle high] | G | Configure COS Priority | switch(config)#qos priority cos 22 middle |
| qos priority tos [Priority] [lowest low middle high] | G | Configure TOS Priority | switch(config)#qos priority tos 3 high |
| show qos | P | Display the information of QoS configuration | switch>show qos |
| no qos | G | Disable QoS function | switch(config)#no qos |

6.8 Commands Set List—IGMP command set

| SLM080 Commands | Level | Description | Example |
|-------------------------|-------|---|--------------------------------|
| igmp enable | G | Enable IGMP snooping function | switch(config)#igmp enable |
| igmp-query auto | G | Set IGMP query to auto mode | switch(config)#igmp-query |
| igmp-query force | G | Set IGMP query to force mode | switch(config)#igmp-query |
| show igmp configuration | | Displays the details of an IGMP configuration | switch#show igmp configuration |
| | | Displays the details of an IGMP configuration | |
| no igmp | G | Disable IGMP snooping function | switch(config)#no igmp |
| no igmp-query | G | Disable IGMP query | switch#no igmp-query |

6.9 Commands Set List—MAC/Filter Table command set

| SLM080 Commands | Level | Description | Example |
|---------------------------------------|-------|--|--|
| mac-address-table static hwaddr [MAC] | I | Configure MAC address table of interface (static). | switch(config)#interface fastEthernet 2 switch(config-if)#mac-address-table static hwaddr 000012345678 |
| mac-address-table filter hwaddr [MAC] | G | Configure MAC address table(filter) | switch(config)#mac-address-table filter hwaddr 000012348678 |
| show mac-address-table | P | Show all MAC address table | switch#show mac-address-table |
| show mac-address-table static | P | Show static MAC address table | switch#show mac-address-table static |
| show mac-address-table filter | P | Show filter MAC address table. | switch#show mac-address-table filter |

| | | | |
|--|---|--|--|
| no mac-address-table static hwaddr [MAC] | I | Remove an entry of MAC address table of interface (static) | switch(config)#interface fastEthernet 2 switch(config-if)#no mac-address-table static hwaddr 000012345678 |
| no mac-address-table filter hwaddr [MAC] | G | Remove an entry of MAC address table (filter) | switch(config)#no mac-address-table filter hwaddr 000012348678 |
| no mac-address-table | G | Remove dynamic entry of MAC address table | switch(config)#no mac-address-table |

6.10 Commands Set List—SNMP Command Set

| SLM080 Commands | Level | Description | Example |
|--|-------|--|--|
| snmp agent-mode [v1v2c v3] | G | Select the agent mode of SNMP | switch(config)#snmp agent- mode v1v2c |
| snmp-server host [IP address] community [Community-string] trap-version [v1 v2c] | G | Configure SNMP server host information and community string | switch(config)#snmp-server host 192.168.10.50 community public trap-version v1 (remove) Switch(config)# no snmp-server host 192.168.10.50 |
| snmp community- strings [Community-string] right [R O RW] | G | Configure the community string right | switch(config)#snmp community- strings public right RO or switch(config)#snmp community- strings public right RW |
| snmp snmpv3-user [User Name] password [Authentication Password] [Privacy Password] | G | Configure the userprofile for SNMPV3 agent. Privacy password could be empty. | switch(config)#snmp snmpv3- user test01 password AuthPW PrivPW |
| show snmp | P | Show SNMP configuration | switch#show snmp |
| show snmp-server | P | Show specified trap server information | switch#show snmp-server |
| no snmp community-strings [Community] | G | Remove the specified community. | switch(config)#no snmp community-strings public |

| SLM080 Commands | Level | Description | Example |
|--|-------|---|---|
| no snmp snmpv3-user [User Name] password [Authentication Password] [Privacy Password] | G | Remove specified user of SNMP v3 agent . Privacy password could be empty. | switch(config)# no snmp snmpv3-user test01 password AuthPW PrivPW |
| no snmp-server host [Host-address] | G | Remove the SNMP server host. | switch(config)#no snmp-server 192.168.10.50 |

6.11 Commands Set List—Port Mirroring command set

| SLM080 Commands | Level | Description | Example |
|-----------------------------|-------|---|---|
| monitor rx | G | Set RX destination port of monitor function | switch(config)#monitor rx |
| monitor tx | G | Set TX destination port of monitor function | switch(config)#monitor tx |
| show monitor | P | Show port monitor information | switch#show monitor |
| monitor [RX TX Both] | I | Configure source port of monitor function | switch(config)#interface fastEthernet 2 switch(config-if)#monitor RX |
| show monitor | I | Show port monitor information | switch(config)#inter face fastEthernet 2 switch(config-if)#show monitor |
| no monitor | I | Disable source port of monitor function | switch(config)#interface fastEthernet 2 switch(config-if)#no monitor |

6.12 Commands Set List—802.1x command set

| SLM080 Commands | Level | Description | Example |
|---------------------------------------|-------|--|---|
| 8021x enable | G | Use the 802.1x global configuration command to enable 802.1x protocols. | switch(config)# 8021x enable |
| 8021x system radiusip [IP address] | G | Use the 802.1x system radius IP global configuration command to change the radius server IP. | switch(config)# 8021x system radiusip 192.168.1.1 |
| 8021x system serverport [port ID] | G | Use the 802.1x system server port global configuration command to change the radius server port | switch(config)# 8021x system serverport 1815 |
| 8021x system accountport [port ID] | G | Use the 802.1x system account port global configuration command to change the accounting port | switch(config)# 8021x system accountport 1816 |
| 8021x system sharekey [ID] | G | Use the 802.1x system share key global configuration command to change the shared key value. | switch(config)# 8021x system sharekey 123456 |
| 8021x system nasid [words] | G | Use the 802.1x system nasid global configuration command to change the NAS ID | switch(config)# 8021x system nasid test1 |
| 8021x misc quietperiod [sec.] | G | Use the 802.1x misc quiet period global configuration command to specify the quiet period value of the switch. | switch(config)# 8021x misc quietperiod 10 |

| SLM080 Commands | Level | Description | Example |
|---|-------|---|---|
| 8021x misc txperiod [sec.] | G | Use the 802.1x misc TX period global configuration command to set the TX period. | switch(config)# 8021x misc txperiod 5 |
| 8021x misc supportimeout [sec.] | G | Use the 802.1x misc supp timeout global configuration command to set the supplicant timeout . | switch(config)# 8021x misc supportimeout 20 |
| 8021x misc servertimeout [sec.] | G | Use the 802.1x misc server timeout global configuration command to set the server timeout . | switch(config)#8021x misc servertimeout 20 |
| 8021x misc maxrequest [number] | G | Use the 802.1x misc max request global configuration command to set the MAX requests. | switch(config)# 8021x misc maxrequest 3 |
| 8021x misc reauthperiod [sec.] | G | Use the 802.1x misc reauth period global configuration command to set the reauth period. | switch(config)# 8021x misc reauthperiod 3000 |
| 8021x portstate [disable reject accept authorize] | I | Use the 802.1x port state interface configuration command to set the state of the selected port . | switch(config)#interface fastethernet 3 switch(config-if)#8021x portstate accept |
| show 8021x | E | Display a summary of the 802.1x properties and also the port sates. | switch>show 8021x |
| no 8021x | G | Disable 802.1x function | switch(config)#no 8021x |

6.13 Commands Set List—TFTP command set

| SLM080 Commands | Level | Description | Example |
|-------------------------------|-------|--|---|
| backup flash:backup_cfg | G | Save configuration to TFTP and need to specify the IP of TFTP server and the file name of image. | switch(config)#backup flash:backup_cfg |
| restore flash:restore_ cfg | G | Get configuration from TFTP server and need to specify the IP of TFTP server and the file name of image. | switch(config)#restore flash:restore_cfg |
| upgrade flash:upgrade_fw | G | Upgrade firmware by TFTP and need to specify the IP of TFTP server and the file name of image. | switch(config)#upgrade lash:upgrade_fw |

6.14 Commands Set List—SYSLOG, SMTP, EVENT command set

| SLM080Commands | Level | Description | Example |
|---|-------|---|--|
| systemlog ip [IP address] | G | Set System log server IP address. | switch(config)# systemlog ip 192.168.1.100 |
| systemlog mode [client server both] | G | Specified the log mode | switch(config)# systemlog mode both |
| show systemlog | E | Display system log. | Switch>show systemlog |
| show systemlog | P | Show system log client & server information | switch#show systemlog |
| no systemlog | G | Disable systemlog function | switch(config)#no systemlog |
| smtp enable | G | Enable SMTP function | switch(config)#smtp enable |
| smtp serverip [IP address] | G | Configure SMTP server IP | switch(config)#smtp serverip 192.168.1.5 |
| smtp authentication | G | Enable SMTP authentication | switch(config)#smtp authentication |
| smtp account [account] | G | Configure authentication account | switch(config)#smtp account User |
| smtp password [password] | G | Configure authentication password | switch(config)#smtp password |
| smtp rcptemail [Index] [Email address] | G | Configure Rcpt e-mail Address | switch(config)#smtp rcptemail 1 Alert@test .com |
| show smtp | P | Show the information of SMTP | switch#show smtp |
| no smtp | G | Disable SMTP function | switch(config)#no smtp |
| event device-cold-start [Systemlog SMTP Both] | G | Set cold start event type | switch(config)#event device-cold-start both |
| event authentication-failure [Systemlog SMTP Both] | G | Set Authentication failure event type | switch(config)#event authentication-failure both |

| SLM080Commands | Level | Description | Example |
|--|-------|--|---|
| event Redundant Ring- topology-change [Systemlog SMTP Both] | G | Set s ring topology changed event type | switch(config)#event ring-topology-change both |
| event systemlog [Link-UP Link-Down Both] | I | Set port event for system log | switch(config)#interface fastethernet 3 switch(config-if)#event systemlog both |
| event smtp [Link-UP Link-Down Both] | I | Set port event for SMTP | switch(config)#interface fastethernet 3 switch(config-if)#event smtp both |
| show event | P | Show event selection | switch#show event |
| no event device-cold-start | G | Disable cold start event type | switch(config)#no event device-cold-start |
| no event authentication-failure | G | Disable Authentication failure event typ | switch(config)#no event authentication-failure |
| no event Redundant Ring-topology-change | G | Disable Redundant Ring topology changed event type | switch(config)#no event ring-topology-change |
| no event systemlog | I | Disable port event for system log | switch(config)#interface fastethernet 3 switch(config-if)#no event systemlog |
| no event smpt | I | Disable port event for SMTP | switch(config)#interface fastethernet 3 switch(config-if)#no event smpt |
| show systemlog | P | Show system log client & server information | switch#show systemlog |

6.15 Commands Set List—SNTP command set

| SLM080 Commands | Level | Description | Example |
|---|-------|---|---|
| sntp enable | G | Enable SNTP function | switch(config)#sntp enable |
| sntp daylight | G | Enable daylight saving time, if SNTP function is inactive, this command can't be applied. | switch(config)#sntp daylight |
| sntp daylight-period [Start time] [End time] | G | Set period of daylight saving time, if SNTP function is inactive, this command can't be applied. Parameter format: [yyyymmdd-hh:mm] | switch(config)# sntp daylight-period 20060101-01:01 20060202-01-01 |
| sntp daylight-offset [Minute] | G | Set offset of daylight saving time, if SNTP function is inactive, this command can't be applied. | switch(config)#sntp daylight-offset 3 |
| sntp ip [IP] | G | Set SNTP server IP, if SNTP function is inactive, this command can't be applied. | switch(config)#sntp ip 192.169.1.1 |
| sntp timezone [Timezone] | G | Set timezone index, use "show sntp timzezone" command to get more information of index number | switch(config)#sntp timezone 22 |
| show sntp | P | Show SNTP information | switch#show sntp |
| show sntp timezone | P | Show index number of time zone list | switch#show sntp timezone |
| no sntp | G | Disable SNTP function | switch(config)#no sntp |
| no sntp daylight | G | Disable daylight saving time | switch(config)#no sntp daylight |

Section 7: Command Set List—Redundant Ring command set

| SLM080 Commands | Level | Description | Example |
|---|-------|--|------------------------------------|
| Ring enable | G | Enable Redundant Ring | switch(config)# ring enable |
| Ring master | G | Enable ring master | switch(config)# ring master |
| Ring couplering | G | Enable couple ring | switch(config)# ring couplering |
| Ring dualhoming | G | Enable dual homing | switch(config)# ring dualhoming |
| Ring ringport [1st Ring Port] [2nd Ring Port] | G | Configure 1st/2nd Ring Port | switch(config)# ring ringport 7 8 |
| Ring controlport [Control Port] | G | Configure Control Port | switch(config)# ring controlport 2 |
| Ring homingport [Dual Homing Port] | G | Configure Dual Homing Port | switch(config)# ring homingport 3 |
| show Ring | P | Show the information of Redundant Ring | switch#show ring |
| no Ring | G | Disable Redundant Ring | switch(config)#no ring |
| no Ring master | G | Disable ring master | switch(config)# no ring master |
| no Ring couplering | G | Disable couple ring | switch(config)# no ring couplering |
| no Ring dualhoming | G | Disable dual homing | switch(config)# no ring dualhoming |

Section 8: Technical Specifications

| Emerson Switch Model | SLM080 |
|--------------------------------|---|
| Physical Ports | |
| 10/100 Base-T(X) Ports in RJ45 | 8 |
| Auto MDI/MDIX | |
| Technology | |
| Ethernet Standards | <p>IEEE 802.3 for 10Base-T</p> <p>IEEE 802.3u for 100Base-TX and 100Base-FX</p> <p>IEEE 802.3x for Flow control</p> <p>IEEE 802.3ad for LACP (Link Aggregation Control Protocol)</p> <p>IEEE 802.1D for STP (Spanning Tree Protocol)</p> <p>IEEE 802.1p for COS (Class of Service)</p> <p>IEEE 802.1Q for VLAN Tagging</p> <p>IEEE 802.1w for RSTP (Rapid Spanning Tree Protocol)</p> <p>IEEE 802.1x for Authentication</p> <p>IEEE 802.1AB for LLDP (Link Layer Discovery Protocol)</p> |
| MAC Table | 8192 MAC addresses |
| Priority Queues | 4 |
| Processing | Store-and-Forward |
| Switch Properties | <p>Switching latency: 7 us</p> <p>Switching bandwidth: 5.6Gbps</p> <p>Max. Number of Available VLANs: 4096</p> <p>IGMP multicast groups: 1024</p> <p>Port rate limiting: User Define</p> |
| | |

| Emerson Switch Model | SLM080 |
|----------------------|---|
| Security Features | <p>Enable/disable ports, MAC based port security</p> <p>Port based network access control (802.1x)</p> <p>VLAN (802.1Q) to segregate and secure network traffic</p> <p>Supports Q-in-Q VLAN for performance & security to expand the VLAN space</p> <p>Radius centralized password management</p> <p>SNMP v1/v2c/v3 encrypted authentication and access security</p> |
| Software Features | <p>STP/RSTP (IEEE 802.1D/w)</p> <p>Redundant Ring with recovery time less than 10ms over 250 units</p> <p>TOS/Diffserv supported</p> <p>Quality of Service (802.1p) for real-time traffic</p> <p>VLAN (802.1Q) with VLAN tagging and GVRP supported</p> <p>IGMP Snooping for multicast filtering</p> <p>Port configuration, status, statistics, monitoring, security</p> <p>SNTP for synchronizing of clocks over network</p> <p>DHCP Server / Client support</p> <p>Port Trunk support</p> |
| Network Redundancy | <p>Redundant Ring</p> <p>STP</p> <p>RSTP</p> |

| | |
|-----------------------------|--|
| Warning / Monitoring System | Relay output for fault event alarming Syslog server / client to record and view events Include SMTP for event warning notification via |
| RS-232 Serial Console Port | RS-232 in RJ45 connector with console cable. 9600bps, 8, N, 1 |
| LED Indicators | |
| Power Indicator | Green : Power LED x 3 |
| R.M. Indicator | Green : Indicate system operated in Redundant Ring Master |
| Redundant Ring Indicator | Green : Indicate system operated in Redundant Ring mode |
| Fault Indicator | Amber : Indicate unexpected event occurred |
| 10/100Base-T(X) RJ45 Port | Green for port Link/Act . Amber for Duplex/Collision |
| Fault Contact | |
| Relay | Relay output to carry capacity of 1A at 24VDC |
| Power | |
| Redundant Input Power | Triple DC inputs. 12~48VDC on 7-pin terminal block, |
| Power Consumption (Typ.) | 9 Watts |
| Overload Current Protection | Present |
| Reverse Polarity Protection | Present on terminal block |
| Physical Characteristic | |
| Enclosure | IP-30 |
| Dimension (W x D x H) | 52(W)x106.1(D)x144.3(H) mm (2.05x4.18x5.68 inch.) |
| Weight (g) | 730 g |
| Environmental | |
| Storage Temperature | -40 to 85oC (-40 to 185oF) |
| Operating Temperature | -40 to 70oC (-40 to 158oF) |
| Operating Humidity | 5% to 95% Non-condensing |
| Regulatory approvals | |
| EMI | FCC Part 15, CISPR (EN55022) class A |
| EMS | EN61000-4-2 (ESD), EN61000-4-3 (RS), EN61000-4-4 (EFT), EN61000-4-5 (Surge), EN61000-4-6 (CS), EN61000-4-8, EN61000-4-11 |
| Shock | IEC60068-2-27 |
| Free Fall | IEC60068-2-32 |
| Vibration | IEC60068-2-6 |
| Warranty | 5 years |

General Contact Information

Home link: <http://www.emerson.com/industrial-automation-controls>

Knowledge Base: <https://www.emerson.com/industrial-automation-controls/support>

Technical Support

Americas

Phone: 1-888-565-4155
1-434-214-8532 (If toll free option is unavailable)

Customer Care (Quotes/Orders>Returns): customercare.mas@emerson.com
Technical Support: support.mas@emerson.com

Europe

Phone: +800-4444-8001
+420-225-379-328 (If toll free option is unavailable)

Customer Care (Quotes/Orders>Returns): customercare.emea.mas@emerson.com
Technical Support: support.mas.emea@emerson.com

Asia

Phone: +86-400-842-8599
+65-6955-9413 (All other Countries)

Customer Care (Quotes/Orders>Returns): customercare.cn.mas@emerson.com
Technical Support: support.mas.apac@emerson.com

Any escalation request should be sent to: mas.sfdcescalation@emerson.com

Note: If the product is purchased through an Authorized Channel Partner, please contact the seller directly for any support.

Emerson reserves the right to modify or improve the designs or specifications of the products mentioned in this manual at any time without notice. Emerson does not assume responsibility for the selection, use or maintenance of any product. Responsibility for proper selection, use and maintenance of any Emerson product remains solely with the purchaser.

© 2020 Emerson. All rights reserved.

Emerson Terms and Conditions of Sale are available upon request. The Emerson logo is a trademark and service mark of Emerson Electric Co. All other marks are the property of their respective owners.

