

Echotouch®

Ultrasonic Level Transmitter



US01, US03, US06 & US12 Series Manual



An ultrasonic sound wave is pulsed from the base of the transducer. The sound wave reflects against the process medium below it. The sound wave energy is returned to the transducer. The microprocessor based electronics measures the time of flight between the sound pulse generation and its receipt. This translates into the distance or range between the transducer and process media below.

NEW FEATURES

- Reflective Ultrasonic Technology
- Simple configuration with WebCal[®] software or push button (some models) configuration
- Increased temperature range
- Increased output filtering

TABLE OF CONTENTS

Introduction:2
 Specifications:.....4
 Dimensions:5
 Intrinsically Safe Control Drawings:7
 Safety Precautions:.....9
 Getting Started:.....11
 Setup Overview:.....11
 Components:.....12
 WebCal vs. Display Configuration:14
 Understanding Sensor Height (Height):15
 Understanding Fill-Height (Fill-H):.....16
 Sensor Output to Local Display::18
 Configuration Using WebCal[®]:.....19
 Step #1 – Install WebCal Software:20
 USB Fob Interface:.....21
 Step #2 – Measure the Tank:.....22
 Step #3 – Sensor Configuration:.....23
 Step #4 – Dimensional Entry:24
 Step #5 – Tank Level Confirmation:.....25
 Step #6 – Write to Unit:.....25
 Configuration Using Display:26
 Step #1 – Measure Tank:.....27
 Step #2 – Setting the Units of Measurement:28
 Step #3 – Setting the Height:29
 Step #4 – Setting the Fill-H:30
 Step #5 – Setting the Fail-Safe Current Output (LOST):31
 Étape #1 - Mesurer le Tank:32
 Étape #2 – Réglage des Unités de Mesure (UNITS):33
 Étape #3 – Réglage de la Height:34
 Étape #4 – Réglage de la Fill-H:35
 Étape #5 – Comment Sélectionner une Sortie Actuelle Faible (LOST):36

Installation:..... 37
 Mounting Guide:..... 37
 Fitting Selection: 39
Wiring: 42
 Analog Output (4-20 mA): 42
 Wire Connections:..... 43
 Accessing the Terminals (US06 & US12 Series Only): 43
 Common Wiring to Displays, Controllers & PLCs: 46
WebCal® Appendix: 49
 Sensor Configuration: 49
 Volumetric Configuration:..... 51
 Tank Level Confirmation: 54
 Write to Unit: 55
Display Appendix: 56
 Air Gap vs Liquid Level: 56
 How to reverse the current output (Rev mA): 57
 How to Setup to Start-up Power: 58
 Values Menu: 59
 SETUP: 59
 Diagnostic (DIAG) parameters: 59
 Reset: 60
 Factory Settings: 61
 User Settings: 61
 Troubleshooting: 62
Warranty: 64

SPECIFICATIONS

Mechanical (US06 & US12 series):

Display Module:	Removable via short cable and plug
LCD:	6 characters, 10 mm (0.394") height
Buttons:	Three, Up / DN / SELECT
Pin Connection:	<i>Display can be removed such that the open connection allows the sensor to be WebCal capable.</i>
Enclosure:	Metal thermal head with skirt to support transducer w/ conduit. * Earth ground on package external (min. 14 AWG)

Electrical Connections:

Power & Return:	2-pin quick connect terminal block
WebCal Connect.:	2-pin quick connect terminal block
Display Connect.:	5-pin plug and socket
Conduit Connection:	Single, 1/2 inch NPT
Transducer:	Polyvinylidene Fluoride (PVDF)
Terminal Cable Size:	16 to 24 AWG
Process Mount:	US06: 2" NPT or 2" G US12: 3" NPT or 3" G
Gasket	Viton A (G thread only)
Classification:	Intrinsically Safe
Compliance:	CE, RoHS

Mechanical (US01 & US03 series):

Enclosure:	Polypropylene (PP-FR GF30)
Transducer:	Polyvinylidene Fluoride (PVDF)
Cable jacket mat'l:	Polyvinyl Chloride (PVC)
Cable type:	4-conductor with shield
Cable length:	4' (121.9 cm)
⚠ Cable Min. Temp.:	200°C
Process Mount:	2" NPT or 2" G
Gasket	Viton A (G thread only)
Classification:	Intrinsically Safe
Compliance:	CE, RoHS

Electrical:

Supply Voltage:	14-28 Vdc
Signal:	4 to 20 mA current loop; 22 mA max.
Signal invert:	4-20mA or 20-4mA
Signal fail-safe:	4mA, 20mA, 21mA, 22mA or hold last value

Environmental:

Temperature:	F: -40° to 176° C: -40° to 80°
Temp. compensation:	Automatic
Ambient temp.:	F: -31° to 140° C: -35° to 60°
Pressure:	30 psi, derated @ 1.667 psi per degree C above 25 °C
Enclosure:	US12: TYPE 4X, IP66 US06: TYPE 4X, IP66 US03: TYPE 6P, IP68 US01: TYPE 6P, IP68

Functional:

Range:	US12: 12 meters (39.37 feet) US06: 6 meters (19.69 feet) US03: 3 meters (9.84 feet) US01: 1.5 meters (4.92 feet)
Dead band:	US12: 45cm (18 inches) US06: 20cm (8 inches) US03: 10cm (4 inches) US01: 3.81cm (1.5 inches)
Accuracy:	US12, US06 & US03: 0.2% of Range in air @ 20°C US01: 0.125 (3mm)
Resolution:	US12: 0.196" (5mm) US06: 0.079" (2mm) US03: 0.039" (2mm) US01: 0.019" (1mm)
Beam width:	US12: 6" (15.2cm) US06: 3" (7.6cm) US03: 2" (5cm) US01: 2" (5cm)
Menu:	Self-scrolling (US06 & US12 only)

DIMENSIONS

Dimensions for US01 & US03 Series

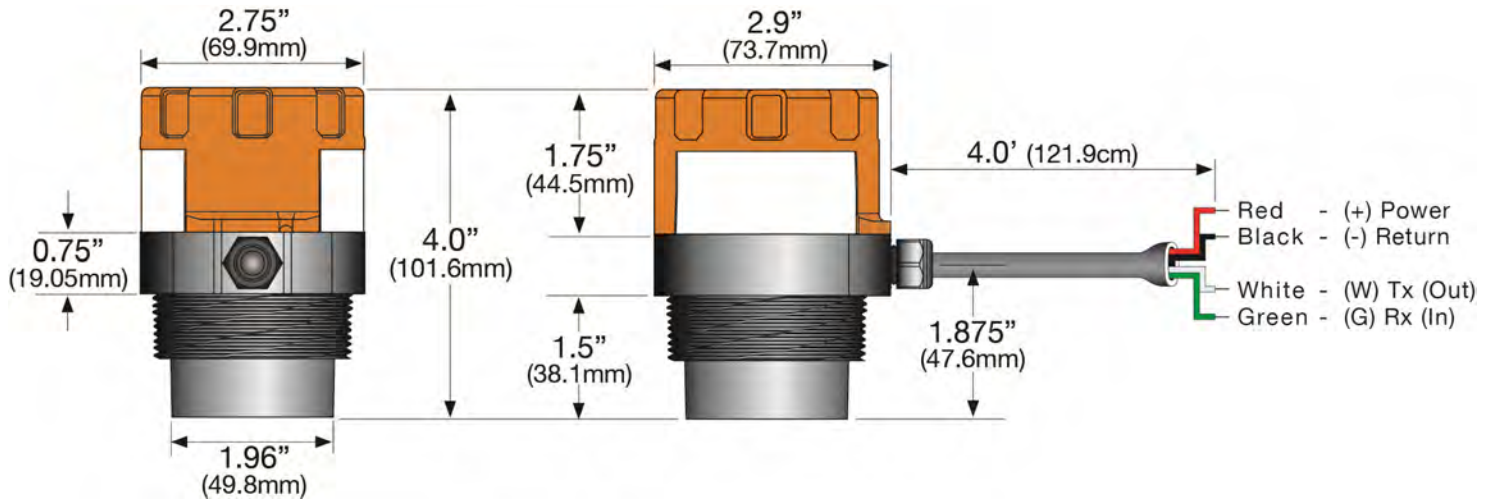

Dimensions for US06 Series

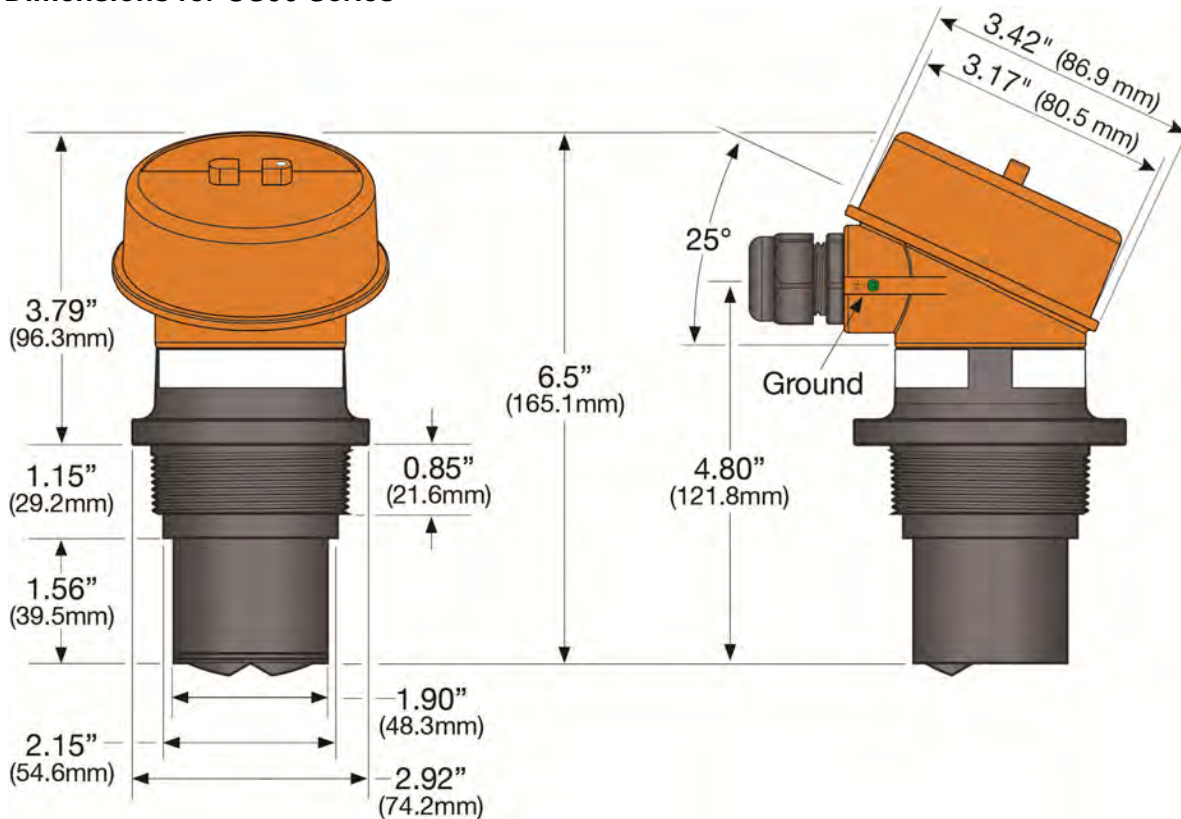

DIMENSIONS

Dimensions for US12 Series

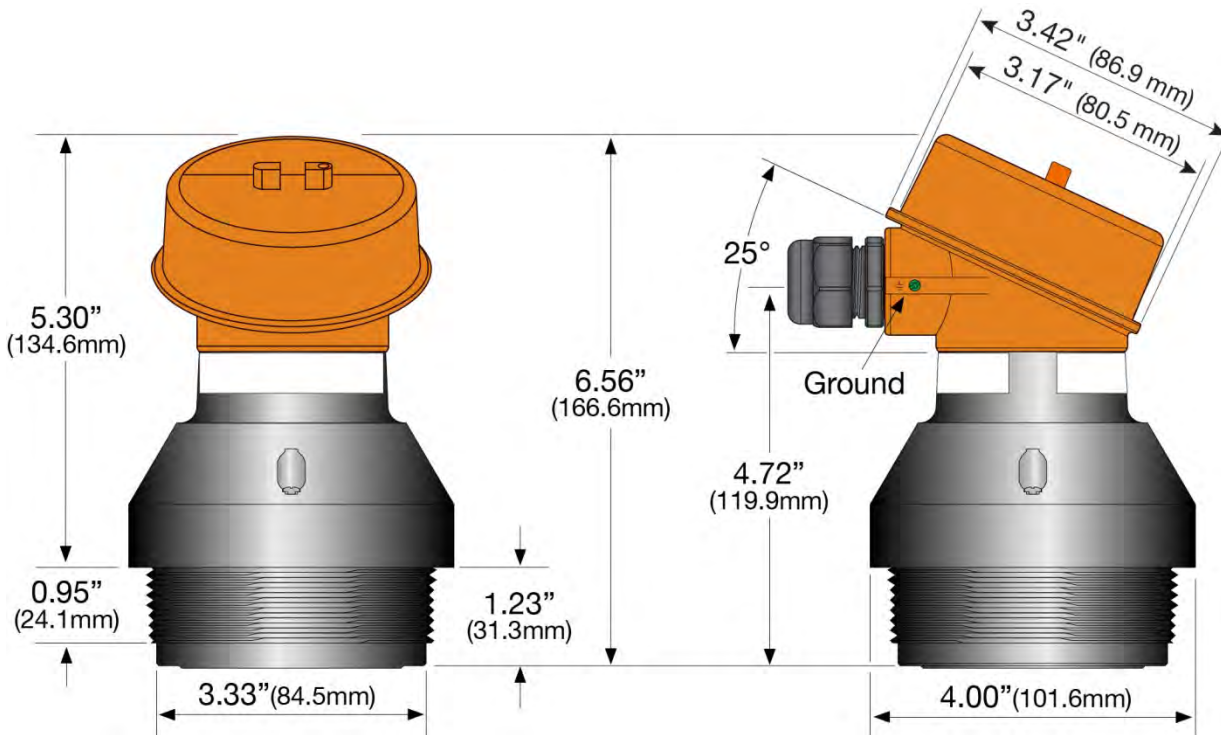

REFLECTIVE TECHNOLOGY

Condensation is the most common variable in liquid level applications. Condensation attenuates the acoustic signal of ultrasonic sensors with horizontal transducers, weakening their signal strength and signal to noise ratio by up to 50%, and substantially reducing their measurement reliability. At the core of Reflective Technology™ is a simple fact. Unlike flat horizontal surfaces, significant water droplets cannot adhere to smooth vertical surfaces. By orienting the transducer vertically, condensation runs off the transducer and does not affect sensor performance. The unimpeded transmit and receive signals are redirected to and from the liquid off a 45° reflector, delivering reliable level measurement.

FLAT TRANSDUCER

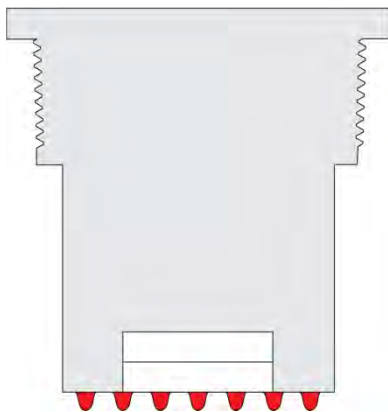

Signal Attenuation

REFLECTIVE TRANSDUCER

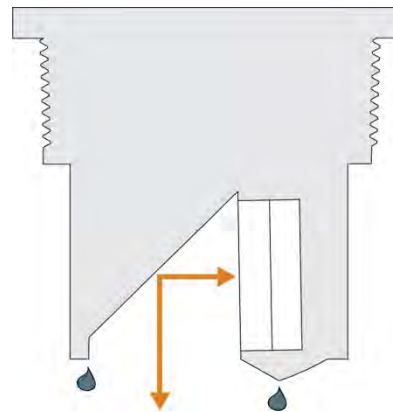

Reliable Measurement

INTRINSICALLY SAFE CONTROL DRAWING 600820 (US06 & US12 SERIES):

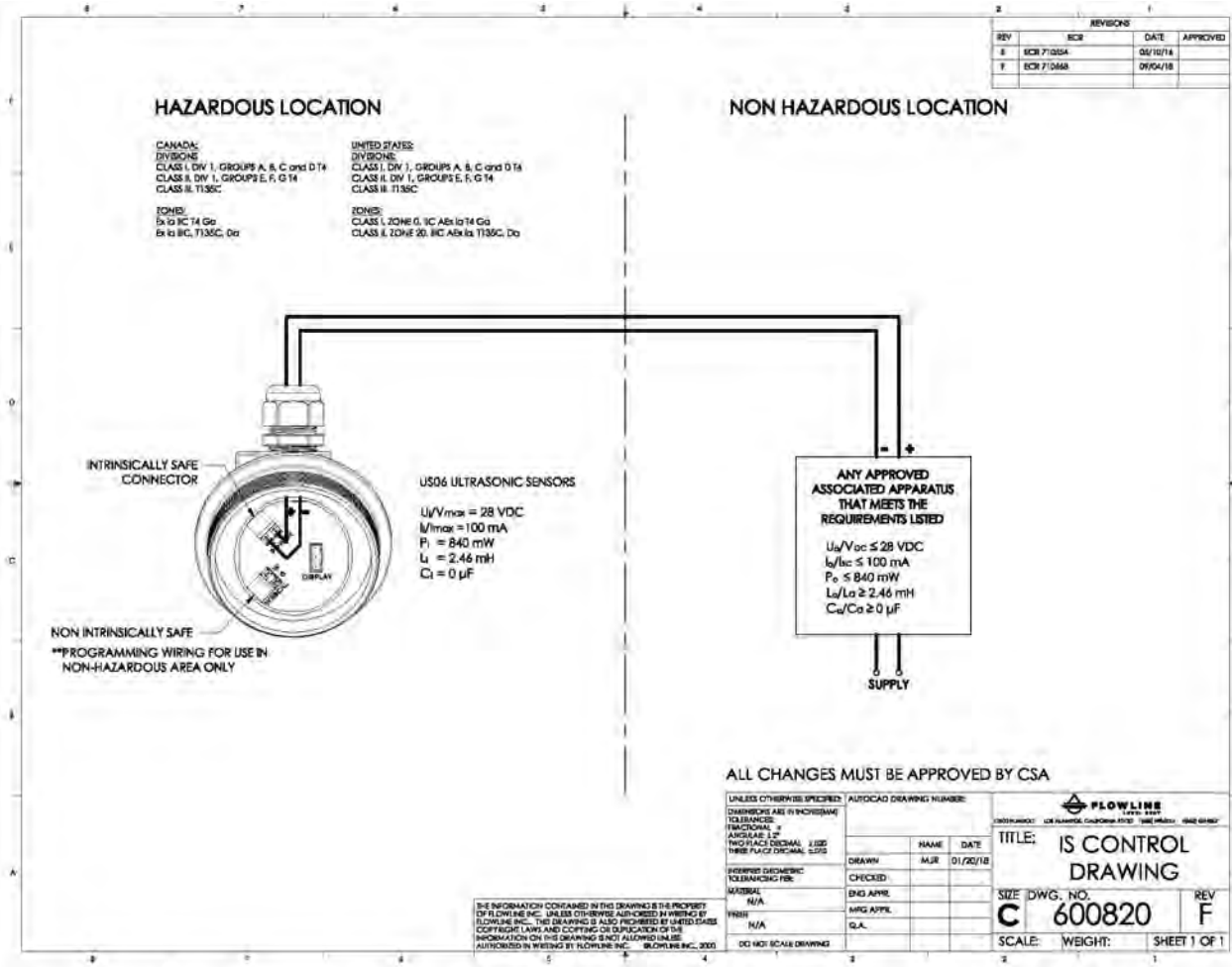

Intrinsically Safe Approvals:

Intrinsic Safe: 14-28 Vdc \leq 22mA
 Output: 4-20mA
 Temp: -40°C to +80°C
 Type 4X/IP66: US06 & US12 series only
 Approval Agency: cCSA_{us}
 General: CE, RoHS

CSA for U.S.:

Class I, Div 1, Groups A, B, C and D T4;
 Class II, Div 1, Groups E, F, G T4;
 Class III, T135°C;
 Class I, Zone 0, IIC AEx ia T4 Ga,
 Class II, Zone 20, IIIC AEx ia, T135°C, Da

CSA for Canada:

Class I, Division 1, Groups A, B, C and D T4;
 Class II, Division 1, Groups E, F, G T4;
 Class III, T135°C;
 Ex ia IIC T4 Ga;
 Ex ia IIIC T135°C Da;

IECEx:

Ex ia IIC T4 Ga;
 Ex ia IIIC T135°C Da
 Tamb: -40°C tp 80°C

Install as per Control Drawing 600820

INTRINSICALLY SAFE CONTROL DRAWING 610125 (US01 & US03 SERIES):

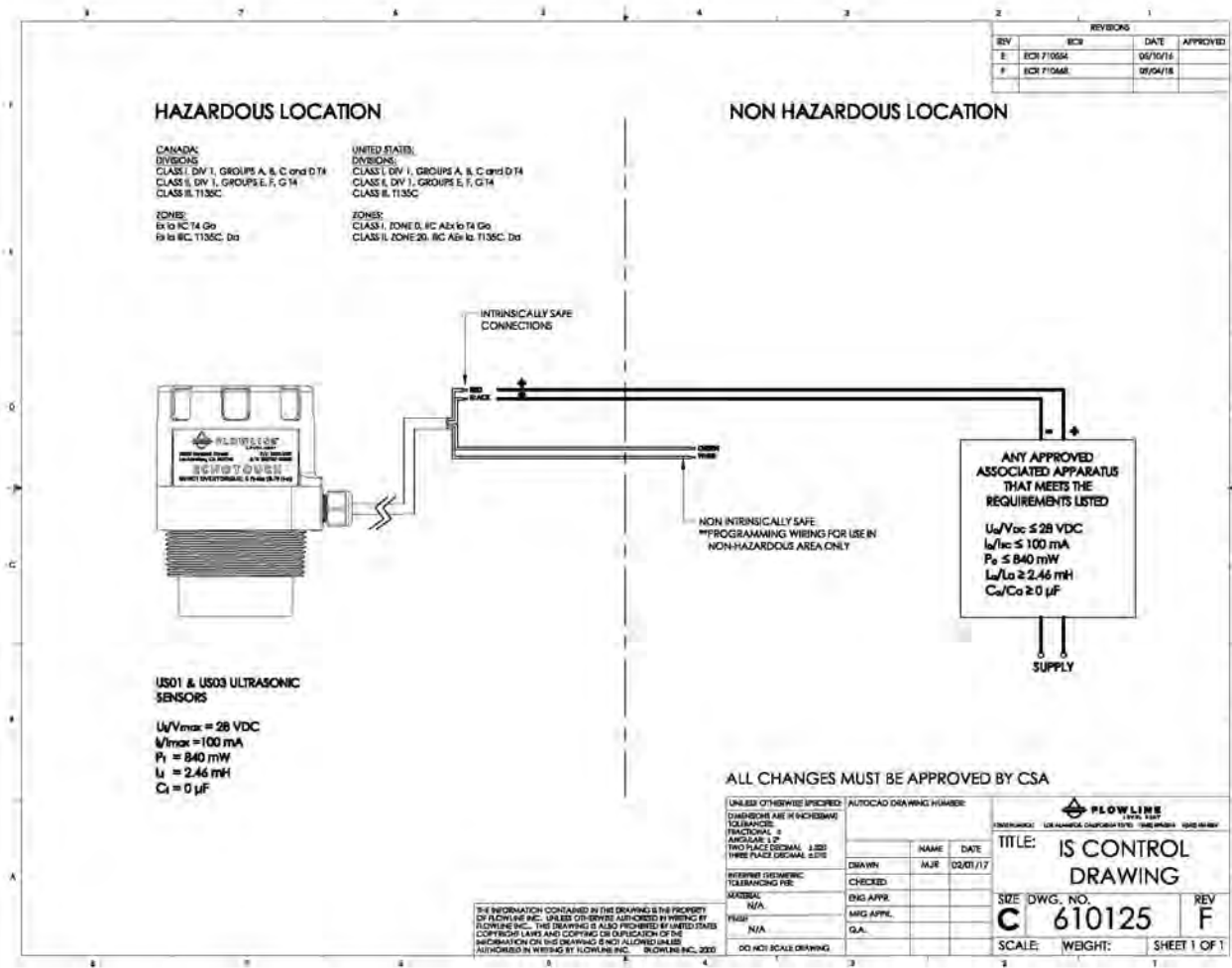

Intrinsically Safe Approvals:

Intrinsic Safe: 14-28 Vdc \leq 22mA
 Output: 4-20mA_{dc}
 Temp: -40°C to +80°C
 Type 6P/IP68: US01 & US03 series only
 Approval Agency: cCSA_{us}
 General: CE, RoHS

CSA for U.S.:

Class I, Div 1, Groups A, B, C and D T4;
 Class II, Div 1, Groups E, F, G T4;
 Class III, T135°C;
 Class I, Zone 0, IIC AEx ia T4 Ga,
 Class II, Zone 20, IIIC AEx ia, T135°C, Da

CSA for Canada:

Class I, Division 1, Groups A, B, C and D T4;
 Class II, Division 1, Groups E, F, G T4;
 Class III, T135°C;
 Ex ia IIC T4 Ga;
 Ex ia IIIC T135°C Da;

IECEX:

Ex ia IIC T4 Ga;
 Ex ia IIIC T135°C Da
 Tamb: -40°C tp 80°C

Install as per Control Drawing 610125

SAFETY PRECAUTIONS

⚠ About this Manual: PLEASE READ THE ENTIRE MANUAL PRIOR TO INSTALLING OR USING THIS PRODUCT. This manual includes information on the EchoTouch® series Ultrasonic Level Transmitter from FLOWLINE. Please refer to the part number located on the switch label to verify the exact model configuration, which you have purchased.

⚠ User's Responsibility for Safety: FLOWLINE manufactures a broad range of level sensing technologies. While each of these sensors is designed to operate in a wide variety of applications, it is the user's responsibility to select a sensor model that is appropriate for the application, install it properly, perform tests of the installed system, and maintain all components. The failure to do so could result in property damage or serious injury.

⚠ Proper Installation and Handling: Only professional staff should install and/or repair this product. Never over tighten the sensor within the fitting. Always check for leaks prior to system start-up.

⚠ Wiring and Electrical: A supply voltage of 14 to 28 VDC is used to power the Echotouch®. Electrical wiring of the transmitter should be performed in accordance with all applicable national, state, and local codes.

⚠ Material Compatibility: The enclosure for the US06 & US12 series is made of metal and for the US01 and US03 series the enclosure is made of Polypropylene. The transducer is made of Polyvinylidene Fluoride (PVDF). Make sure that the model, which you have selected, is chemically compatible with the application media.

⚠ Enclosure: While the sensor housing is liquid-resistant the EchoTouch® is not designed to be operational when immersed. It should be mounted in such a way that the enclosure and transducer do not come into contact with the application media under normal operational conditions.

⚠ Warning - Potential Electrostatic Charging Hazard (Handling Static-Sensitive Circuits/Devices): When handling the transmitter, the technician should follow these guidelines to reduce any possible electrostatic charge build-up on the technician's body and the electronic part.

1. Always touch a known good ground source before handling the part. This should be repeated while handling the part and more frequently after sitting down from a standing position, sliding across the seat or walking a distance.
2. Avoid touching electrical terminals of the part unless making connections.
3. DO NOT open the US06 or US12 unit cover until it is time to configure.

⚠ Warning: Always use the Viton gasket when installing "G" threaded versions of EchoTouch®

⚠ Warning: Make sure that all electrical wiring of the switch is in accordance with applicable codes.

⚠ Warning: Use only specified replacement parts or Intrinsic Safety can be impaired.

⚠ Warning: To prevent ignition of explosive atmospheres, disconnect power before servicing.

⚠ Make a Fail-Safe System: Design a fail-safe system that accommodates the possibility of switch and/or power failure. FLOWLINE recommends the use of redundant backup systems and alarms in addition to the primary system.

⚠ Flammable, Explosive or Hazardous Applications: Only the EchoTouch® is rated for use in hazardous locations. Refer to the certificate of compliance for all applicable intrinsically safe ratings and entity parameters for the EchoTouch®. Refer to the National Electric Code (NEC) for all applicable installation requirements in hazardous locations.

PRÉCAUTIONS DE SÉCURITÉ

⚠ A Propos de ce Manuel: VEUILLEZ LIRE TOUT LE MANUEL AVANT D'INSTALLER OU D'UTILISER CE PRODUIT. Ce manuel comprend des informations sur l'émetteur de niveau ultrasonique EchoTouch® de FLOWLINE. Reportez-vous au numéro de pièce situé sur l'étiquette du commutateur pour vérifier la configuration exacte du modèle que vous avez achetée.

⚠ Responsabilité de l'utilisateur pour la Sécurité: FLOWLINE fabrique une large gamme de technologies de détection de niveau. Bien que chacun de ces capteurs soit conçu pour fonctionner dans une grande variété d'applications, il est de la responsabilité de l'utilisateur de sélectionner un modèle de capteur approprié à l'application, de l'installer correctement, d'effectuer des tests du système installé et de maintenir tous les composants. Le défaut de le faire pourrait entraîner des dommages matériels ou graves.

⚠ Installation et Manipulation Appropriées: seul le personnel professionnel doit installer et / ou réparer ce produit. Ne jamais serrer le capteur sur le raccord. Vérifiez toujours les fuites avant le démarrage du système.

⚠ Câblage et électricité: une tension d'alimentation de 14 à 28 VDC est utilisée pour alimenter l'Echotouch®. Le câblage électrique de l'émetteur doit être effectué conformément à tous les codes nationaux, d'état et locaux applicables.

⚠ Compatibilité des Matériaux: Le boîtier des séries US06 et US12 est en métal et celui des séries US01 et US03 en polypropylène. Le transducteur est en fluorure de polyvinylidène (PVDF). Assurez-vous que le modèle, que vous avez sélectionné, est chimiquement compatible avec les supports d'application.

⚠ Boîtier: Bien que le boîtier du capteur soit résistant aux liquides, l'EchoTouch® n'est pas conçu pour être opérationnel lorsqu'il est immergé. Il doit être monté de telle sorte que l'enceinte et le transducteur ne soient pas en contact avec le support d'application dans des conditions normales de fonctionnement.

⚠ Avertissement - Danger potentiel de charge électrostatique (manipulation de circuits / dispositifs sensibles à l'électricité statique): lors de la manipulation de l'émetteur, le technicien doit suivre ces directives pour réduire toute accumulation de charge électrostatique possible sur le corps du technicien et la partie électronique.

1. Toujours toucher une bonne source de sol connue avant de manipuler la pièce. Cela devrait être répété lors de la manipulation de la pièce et plus fréquemment après avoir reposé sur une position debout, glisser sur le siège ou marcher sur une distance.
2. Évitez de toucher les bornes électriques de la pièce à moins de faire des connexions.
3. N'ouvrez PAS le capot de l'appareil US06 ou US12 avant la configuration.

⚠ Avertissement: Utilisez toujours le joint Viton lors de l'installation des versions filetées "G" d'EchoTouch®

⚠ Avertissement: Assurez-vous que tout le câblage électrique du commutateur est conforme aux codes applicables.

⚠ Attention: utilisez uniquement des pièces de rechange spécifiées ou la sécurité intrinsèque peut être altérée.

⚠ Avertissement: Pour éviter tout allumage d'atmosphères explosives, débranchez l'alimentation avant l'entretien.

⚠ Effectuez un système anti-défaillance: Concevez un système de sécurité qui permet de commuter et / ou de panne de courant. FLOWLINE recommande l'utilisation de systèmes de sauvegarde redondants et d'alarmes en plus du système primaire.

⚠ Applications inflammables, explosives ou dangereuses: seul EchoTouch® est destiné à être utilisé dans des endroits dangereux. Reportez-vous au certificat de conformité pour toutes les cotes de sécurité intrinsèquement applicables et les paramètres de l'entité pour EchoTouch®. Reportez-vous au National Electric Code (NEC) pour toutes les exigences d'installation applicables dans les endroits dangereux.

SETUP OVERVIEW

Below highlights the initial steps in setting up your sensor for operation.

1. **Check Part Number** (Section Two)
 - a. Confirm that the sensor's part number matches the ordered part number and all components are provided with the model delivered.
2. **Measurements, Installation & Software** (Section Two)
 - a. Understand the location placement of the sensor relative to Measurement Range including Sensor Height and Fill-Height settings.
 - b. Download the WebCal® software from www.flowline.com/webcal-software/.
3. **Configure Sensor with WebCal™** (Section Three)
 - a. Section 3 contains information on using the WebCal® configuration software.
4. **Configure Sensor with Push Button** (Section Four)
 - a. Section 4 contains information on using the Push Button Display to configure the sensor.
 - b. Only applies to the US06 & US12 Series.
5. **Install the sensor** (Section Five)
 - a. Section 5 contains information about the sensor location placement and its mechanical installation.
6. **Wire the sensor** (Section Six)
 - a. Section 6 contains information about the sensor's electrical wiring and power requirements.

Note: When configuring Echotouch®, choose either the WebCal® or Push Button method. Either method will accomplish the goal of sensor configuration. Changes to the configuration can be made using the alternative method. When beginning with one method, it is recommended to complete the configuration before using the other method to make any adjustments.

COMPONENTS

Echotouch® is offered in different models. Depending on the model purchased, you may or may not have been shipped all the components shown below. A “G” threaded process mounts require a Viton® gasket for installation and operation of Echotouch®.

P/N	Max. Range	Dead Band	Thread	Fob	Enclosure/ Connection	Configuration
US12-0001-00	39.4' (12m)	18" (45.7cm)	3" NPT	Not Included	TYPE 4X / ½" Conduit	Push Button or WebCal®
US12-0001-01				Included		
US12-0011-00			3" G	Not Included		
US12-0011-01				Included		
US06-0001-00	19.7' (6m)	8" (20cm)	2" NPT	Not Included		
US06-0001-01				Included		
US06-0011-00			2" G	Not Included		
US06-0011-01				Included		
US03-0001-00	9.8' (3m)	4" (10cm)	2" NPT	Not Included	TYPE 6P / 4' Pigtail	WebCal® only
US03-0001-01				Included		
US03-0011-00			2" G	Not Included		
US03-0011-01				Included		
US01-0001-00	4.9' (1.5m)	1.5" (3.81cm)	2" NPT	Not Included		
US01-0001-01				Included		
US01-0011-00			2" G	Not Included		
US01-0011-01				Included		

- Viton Gasket (G threaded version only)
 - Part # 200129 – (US06-0013-0_ only)
 - Part # 210157 – (US12-0013-0_ only)
- Liquid Tight Fitting (US06 & US12 series only)
 - Part # LM90-1001
 - **Note:** If using the Liquid Tight Fitting on the ½" conduit, the cable minimum is 0.170" (4.3mm) and the maximum is 0.450" (11.4mm).
- Quick Start Guide



COMPOSANTS

Echotouch® est offert dans différents modèles. Selon le modèle acheté, vous pouvez ou non avoir envoyé tous les composants indiqués ci-dessous. Un montage fileté "G" nécessite un joint Viton® pour l'installation et l'utilisation d'Echotouch®.

P/N	Max. Gamme	Dead Band	Fil	Fob	Enceinte/ Connexion	Configuration
US12-0001-00	39.4' (12m)	18" (45.7cm)	3" NPT	Not Inclus	TYPE 4X / ½" Conduit	Bouton poussoir ou WebCal®
US12-0001-01				Inclus		
US12-0011-00			3" G	Not Inclus		
US12-0011-01				Inclus		
US06-0001-00	19.7' (6m)	8" (20cm)	2" NPT	Not Inclus		
US06-0001-01				Inclus		
US06-0011-00			2" G	Not Inclus		
US06-0011-01				Inclus		
US03-0001-00	9.8' (3m)	8" (20cm)	2" NPT	Not Inclus	TYPE 6P / 4' Natte	WebCal® seulement
US03-0001-01				Inclus		
US03-0011-00			2" G	Not Inclus		
US03-0011-01				Inclus		
US01-0001-00	4.9' (1.5m)	4" (10cm)	2" NPT	Not Inclus		
US01-0001-01				Inclus		
US01-0011-00			2" G	Not Inclus		
US01-0011-01				Inclus		

- Viton Gasket (version fileté G uniquement)
 - Part # 200129 – (US06-0013-0_ seulement)
 - Part # 210157 – (US12-0013-0_ seulement)
- Liquid Tight Fitting (US06 & US12 série seulement)
 - Part # LM90-1001
 - **Remarque:** Si vous utilisez l'ajustement liquide étanche sur le conduit ½", le minimum du câble est de 0,170" (4.3mm) et le maximum est de 0.450 "(11.4mm).
- Guide de démarrage rapide



WEBCAL® VS. DISPLAY CONFIGURATION

EchoTouch® can be configured using either the free WebCal® software and USB® Fob or with the internal display module. Either method will accomplish the goal of sensor configuration. Changes to the configuration can be made using the alternative method. Upon implementing one methodology, it is recommended to complete the configuration before using the other methodology in making any adjustments.

EchoTouch® can be configured before installation or after installation. The transmitter features non-volatile memory, so any settings configured before installation will not be lost when the sensor is powered down. To start, the following information is required:

- Basic Tank Information
 - **HEIGHT** (Sensor Height) – Distance from the bottom of the tank to the bottom of the sensor.
 - **FILL-H** (Fill-Height) – Distance from the bottom of the tank to the fill-height of the liquid.
- Power:
 - Provide input power to the Echotouch®

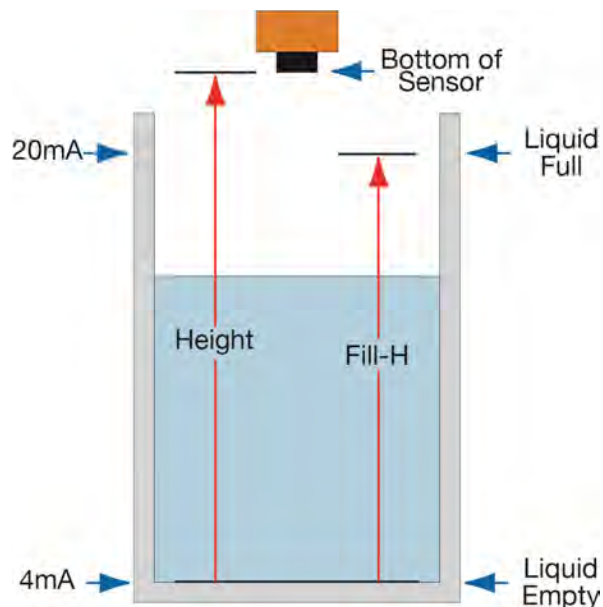

Note: The **HEIGHT** and Fill-Height (**FILL-H**) settings also determine the 4 to 20 mA current span. The **HEIGHT** setting determines the 4mA position and the **FILL-H** setting determines the 20 mA position.

UNDERSTANDING SENSOR HEIGHT (HEIGHT)

This is a critical setting for EchoTouch®. Sensor Height (SH) defines the location of the sensor from the bottom of the tank. The value must take into account the shape of the tank and any risers, fittings, structures or extensions associated with the tank or the installation (see examples below). The reference point for definition of the Sensor Height is always the bottom of the mounting nut.

Simple Vertical Tank

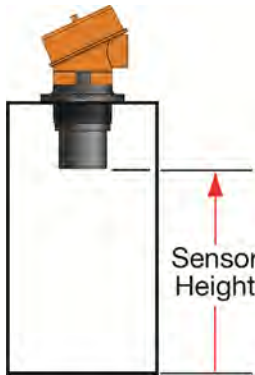

Dome Top Raises HEIGHT



Sensor Off-center Changes HEIGHT

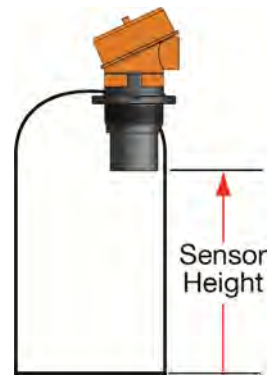

Simple Open Top Tank

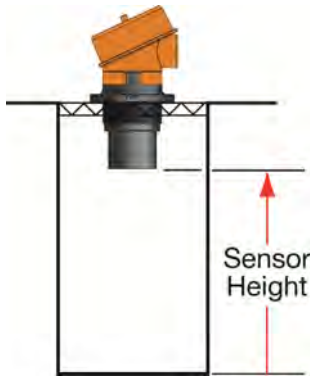

Sensor Extends into Sump

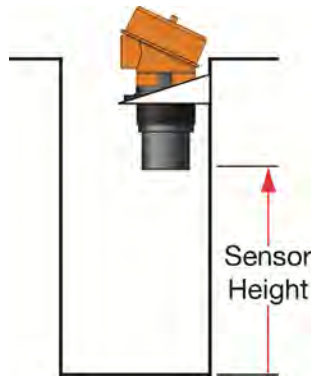

Cone Bottom Elevates HEIGHT

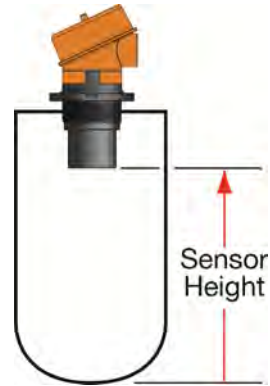

Simple Horizontal Tank

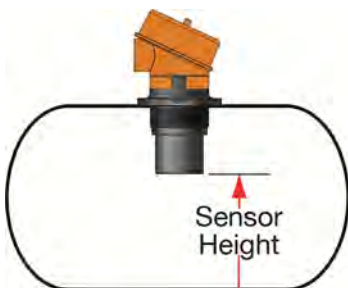

Riser Elevates HEIGHT

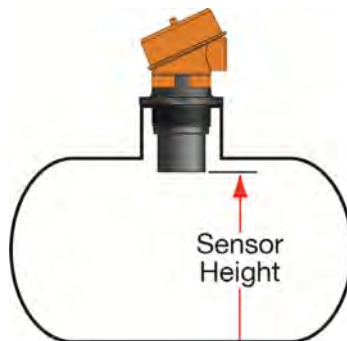

Mounting Fixture Elevates HEIGHT

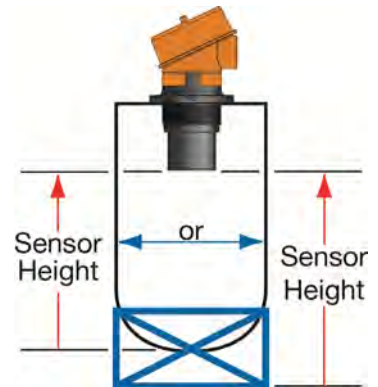

UNDERSTANDING FILL-HEIGHT (FILL-H)

This is another critical setting for EchoTouch®. **FILL-H** (Fill-Height) defines the location of the highest point in the tank where the sensor will read level changes. When the level rises above **FILL-H**, the sensor will read full (as long as the level does not enter the dead band). The reference point for definition of **FILL-H** is always from the bottom location of the Sensor Height. The value must take into account the sensors dead band, any risers, fittings, structures or extensions associated with the tank or the installation as well as the tanks geometry.

Example #1 – Flat Top Tanks

Tank A is a vertical tank with a flat top. The highest value for **FILL-H** can be calculated by subtracting the **Dead Band** from the **Sensor Height**.

$$\text{FILL-H} = \text{Sensor Height} - \text{Dead Band}$$

Tank B is another vertical tank with a riser that matches the dead band of the sensor. In this case, the **FILL-H** will be set to the top of the tank.

Note: The ratio of height to diameter of the riser must be no greater than 2:1. Any higher and the sensor will target the inside wall of the riser.

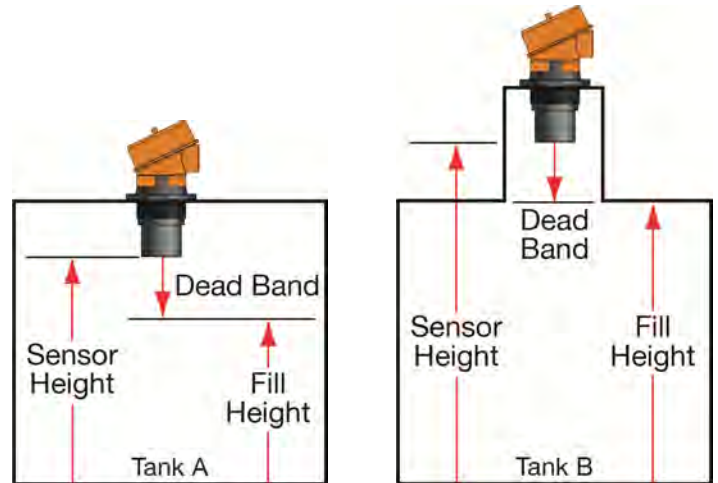

Example #2 – Dome Top Tanks

Tank C has a tall enough dome whereas the **Dead Band** is above the straight side of the tank. The **FILL-H** can be set to the top of the straight side (this is advantageous because the top of the straight side is typically a known volume of liquid).

The sensor is moved to a flat part of **Tank D**. As a result, the **Dead Band** is now below the straight side of the tank. **FILL-H** cannot be set to match the straight side of the tank. Calculate **FILL-H** as follows:

$$\text{FILL-H} = \text{Sensor Height} - \text{Dead Band}$$

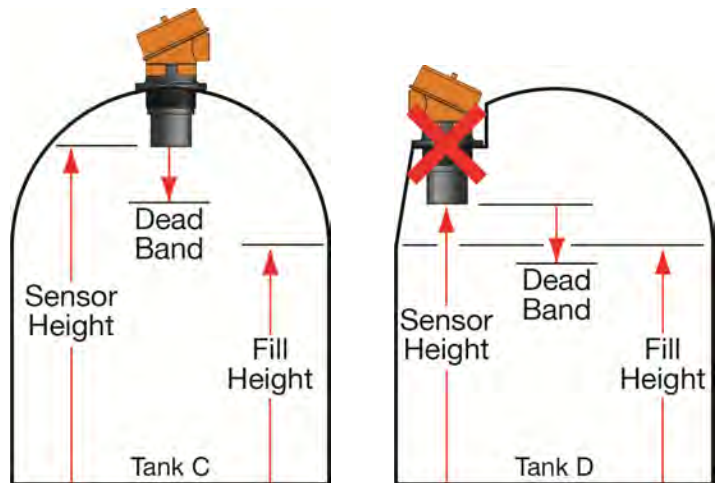

Example #3 – Horizontal Tanks

Tank E is a horizontal tank with a rounded top. The highest value for **FILL-H** can be calculated by subtracting the **Dead Band** from the **Sensor Height**.

$$\text{FILL-H} = \text{Sensor Height} - \text{Dead Band}$$

Tank F is another horizontal tank with a riser that matches the dead band of the sensor. In this case, the **FILL-H** will be set to the top of the tank.

Note: The ratio of height to diameter of the riser must be no greater than 2:1. Any higher and the sensor will target the inside wall of the riser.

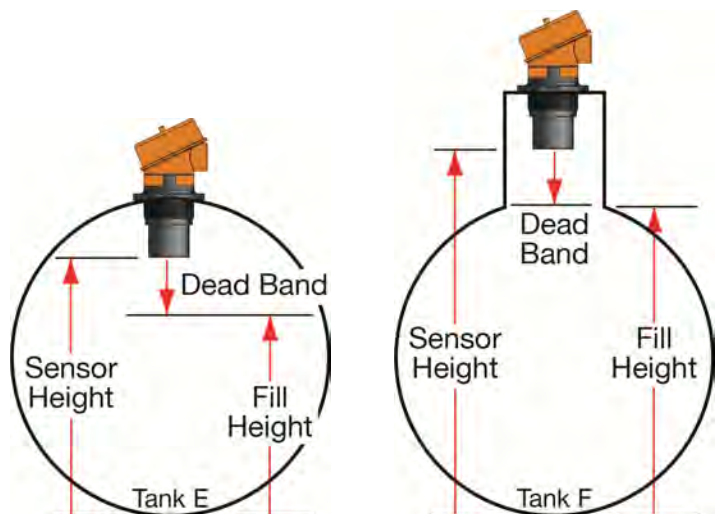

Example #4 – Cone Bottom Tank

Tank G and **Tank H** are both vertical tanks that are being supported above ground level with tank stands. The location of the **Sensor Height** (Tank G - bottom of tank or Tank H – ground level) will influence the **FILL-H** setting.

Note: *FILL-H must always be referenced to the lowest location of the Sensor Height.*

Since **Tank G** is off of the ground, the lowest location may be difficult to identify/measure. This location is required if the Volumetric Mode in WebCal[®] is used.

Tank H uses ground level as the main reference location. This method is easiest to use and ideal for using the Distance mode of WebCal[®].

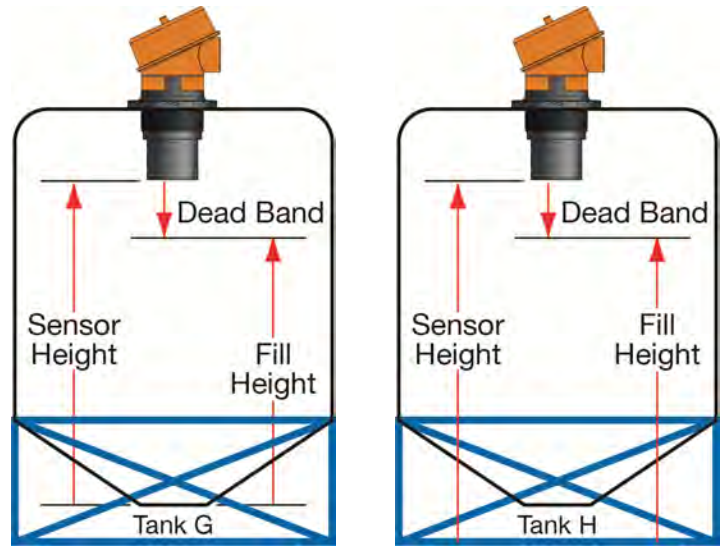

Cone and Rounded Bottom Tanks

The location of an EchoTouch[®] installed along the top of a cone or rounded bottom tank may have an effect on the installation of the sensor. Be sure to understand the geometry directly underneath the sensor. Cone or rounded bottom tanks will provide off angled surfaces that can reflect the ultrasonic sound energy away from the sensor as the liquid level is lowered.

#1 Center of Cone



#2 Above an Angled Tank Bottom (straight side only)



#3 Above an Angled Tank Bottom (full range)

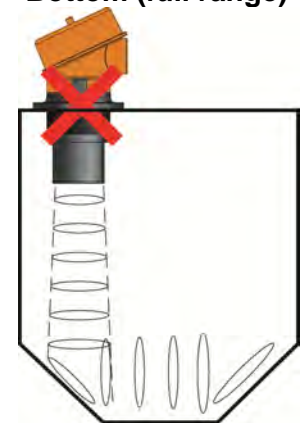

<p>Tank Geometry</p>	<p>Does not impede sensor's performance. Sensor is able to track the entire range of the tank.</p>	<p>Does not impede sensor's performance as long as the level remains within the straight side of the tank wall.</p>	<p>Does impede sensor's performance. The angled bottom will reflect ultrasonic energy away from the sensor.</p>
<p>Distance Reading</p>	<p>HEIGHT is typically set to the bottom of the tank. Sensor will track the full range of the tank.</p>	<p>HEIGHT is typically set to the bottom of the straight side. Sensor will only tack the straight side of the tank.</p>	<p>HEIGHT is set to the bottom of the tank, the sensor will function as long as the level is within the straight side of the tank.</p>

SENSOR OUTPUT TO LOCAL DISPLAY/CONTROLLER

Echotouch® outputs a 4-20 mA signal to a local display/controller or to remote devices such as PLCs, SCADA, DCS or other displays/controllers. The 4-20 mA signal is set relative to the Sensor Height and Fill-Height settings. These settings create an operational range that can be translated into a level reading in defined units (i.e. inches, feet, gallons, meters, liters, etc.).

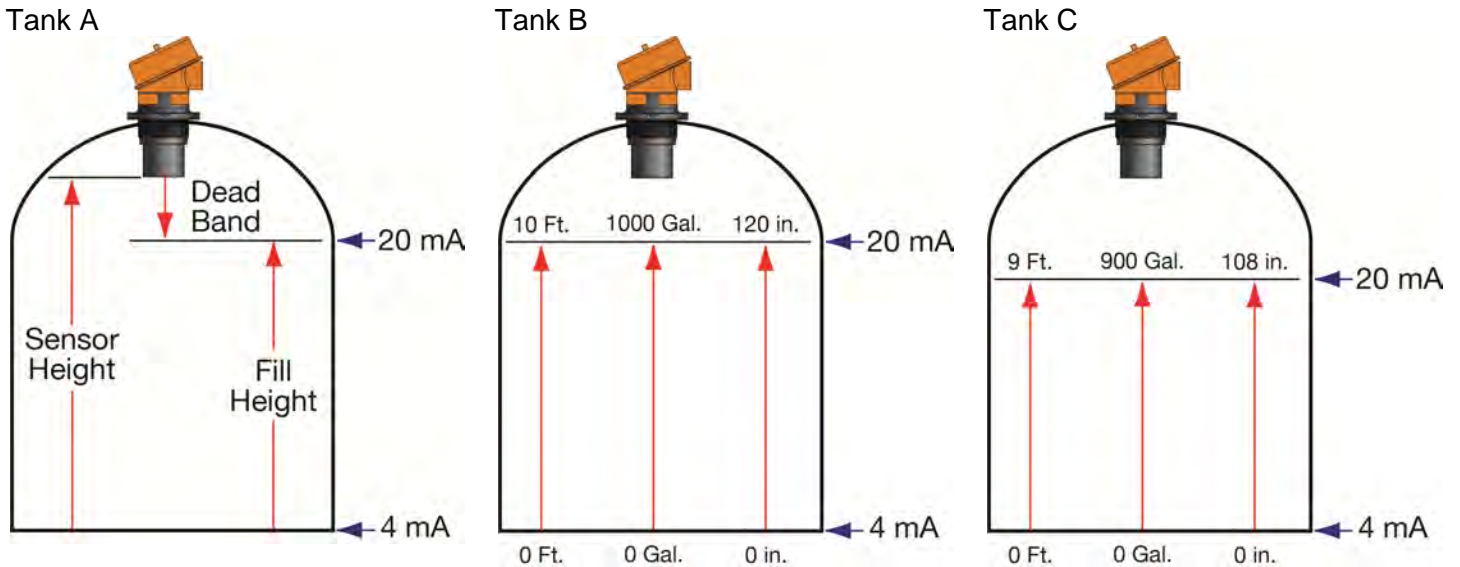

In the Tank A example, the Sensor Height sets the 4mA to the bottom of the tank. Fill-Height sets the 20mA to the top of the straight side of the tank.

In the Tank B example, the 4-20mA sensor range is correlated to actual units of level measurement. The operational range now will have engineering values of 0 to 10 feet or 0 to 1000 gallons or 0 to 120 inches.

In the Tank C example, the 20mA setting was lowered by 1 foot, so the engineering values for the new shorter operational ranges are either 0 to 9 feet, 0 to 900 gallons or 0 to 108 inches.

EchoTouch® can be configured before installation. The transmitter features non-volatile memory, so any setting configured before installation will not be lost when the switch is powered down. To configure, follow the steps below:

1. Install WebCal® software
 - a. Go to www.flowline.com/webCal-software/ and select language version.
 - b. Review how USB® Fob interfaces with EchoTouch® and your computer.
2. Measure the Tank
 - a. Begin by measuring the key tank and fitting dimensions.
 - b. Correct tank dimensions will result in accurate sensor measurement.
3. Sensor Configuration
 - a. Configures Loop Fail-Safe, Output at Empty & Startup Condition for the sensor.
4. Dimensional Entry
 - a. Distance Mode (default)
 - i. Basic information for operation (Sensor Height & Fill-Height).
5. Tank Level Confirmation
 - a. Confirm the values are accurate for the application.
6. Write to Unit
 - a. Uploads configuration into the sensor.
 - b. Access to a customer wiring diagram specific to the relay configuration.

Note: When configuring EchoTouch®, choose either the WebCal® or Push Button method. Push Button is **only** available with the US06 and US12 series. Either method will accomplish the goal of sensor configuration. Changes to the configuration can be made using the alternative method. When beginning with one method, it is recommended to complete the configuration before using the other method to make any adjustments.

STEP 1 – INSTALL WEBCAL® SOFTWARE

EchoTouch® is configured through WebCal®, a PC software program. WebCal® is a free download from Flowline’s website. **You must download and install WebCal® prior to plugging in the USB® Fob (LI99-2001).** Please go to .flowline.com/webcal-software/, and select your language version.

WEBCAL® SYSTEM REQUIREMENTS:

- Windows® XP, Vista, 7, 8, 10
- 32 or 64-bit system
- 1 USB® 2.0 port
- 10 MB hard drive space
- 256 MB RAM
- Internet connection

*** For complete information on the WebCal® software, please refer to the WebCal® manual located at www.flowline.com/webcal-software/.**

USB® FOB INTERFACE:

EchoTouch® communicates with WebCal®* through a USB® interface called a Fob. Before plugging your Fob into your computer's USB® port, be sure that you have installed WebCal® (see www.flowline.com/webcal-software/) on your computer.

Connect the red, green, white and black wires from Echotouch® into the correct terminals on the Fob. Tighten the screws on the terminals. Plug your Fob into the USB® port of your computer.

US01 & US03 Series only

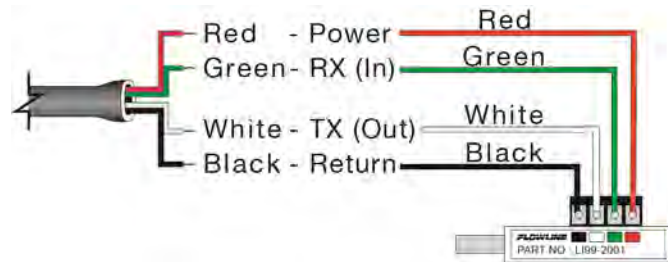

US06 & US12 Series only

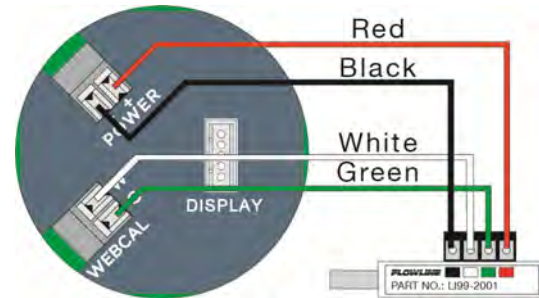

LI99-2001 USB® Fob



Note: Only use the **LI99-2001 USB® Fob (white)**. The **LI99-1001 USB® Fob (black)** will not work with the EchoPod® series.

Wiring is identical for all EchoTouch® Series – Use only the Red, Black, Green and White wires.

- The **maximum cable distance** between the computer and EchoTouch® is **15'**. This only applies for configuring the EchoTouch®.
- Once EchoTouch® is configured and prior to installation, isolate the white and green wires from active power to prevent a short from the configuration circuit.
- **Note:** When using the Fob, do not add VDC or VAC power. The Fob, when connected to the computer, will provide the required power to the EchoTouch®.
- **Note:** When connecting the sensor to the WebCal® Software, you must remove the display or the software will not connect. Once completed, you can re-connect the display to the terminal.

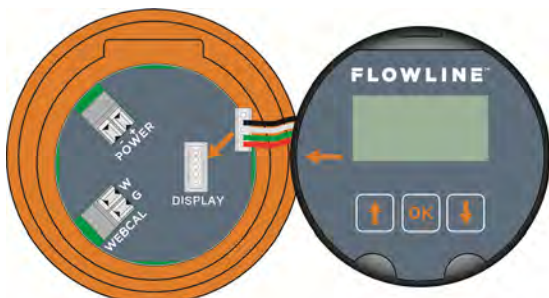

- *** For complete information on the WebCal® software, please refer to the WebCal® manual located at www.flowline.com/webcal-software/.**

STEP 2 - MEASURE THE TANK

Measuring the tank is one of the most important aspects in configuring the sensor. When measuring the tank, take into account the location of the sensor with respect to fittings, risers, dome tops and bottoms, and identify where the measurements are taken from the sensor. The Sensor Height is influenced by the installation location. Sensors mounted along the sloped portion of the tank will result in a lower (**HEIGHT**) value. On the other hand, sensors installed in risers/nozzles will result in a higher (**HEIGHT**) value.

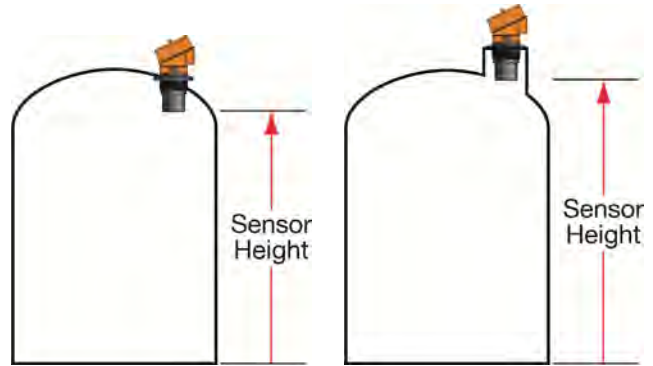

The basic measurements (**Height** and **Fill-H**) for configuration are described below:

1. **HEIGHT** (Sensor Height) - Distance from the bottom of the tank to the Bottom of Sensor.
 - a. The bottom of the tank will be the sensor's zero level / empty level.
 - b. This setting determines the 4mA location.
2. **FILL-H** (Fill-Height) - Distance from the bottom of the tank to the level of liquid where the tank is full is **FILL-H**.
 - a. The **FILL-H** is typically set to the liquid full level.
 - b. This setting determines the 20 mA location.
 - c. 20mA cannot be set within the sensor's dead band [8" (20cm) from bottom of sensor]. Largest **FILL-H** value will be as follows:

$$\text{Largest FILL-H} = \text{HEIGHT} - 8'' (20\text{cm})$$

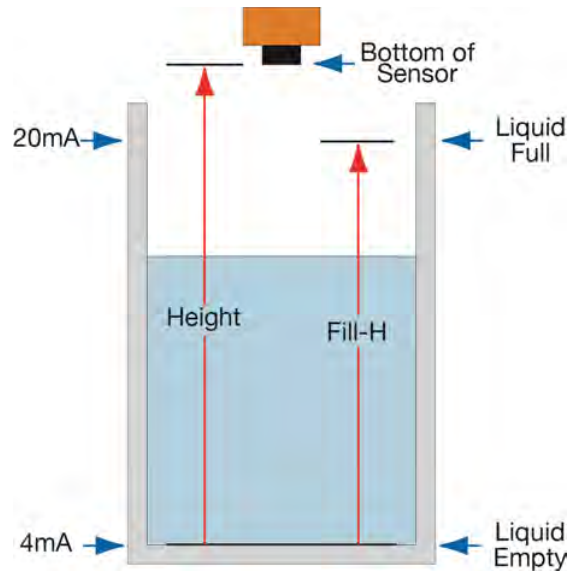

With EchoTouch® connected to your computer, open the WebCal®* software by clicking on the WebCal® icon. Follow steps 3-6 to configure the transmitter. Click “Help” in the lower right hand corner and open the help menu of WebCal® for instructions on WebCal®. If you need additional assistance using WebCal®, please contact a Flowline applications engineer at (562) 598-3015. **Note:** For complete information on the WebCal® software, please refer to the WebCal® manual located at .flowline.com/webcal-software/.

STEP 3 - SENSOR CONFIGURATION:

Configures the Loop Fail-Safe, Output at Empty and Startup Condition for the sensor.

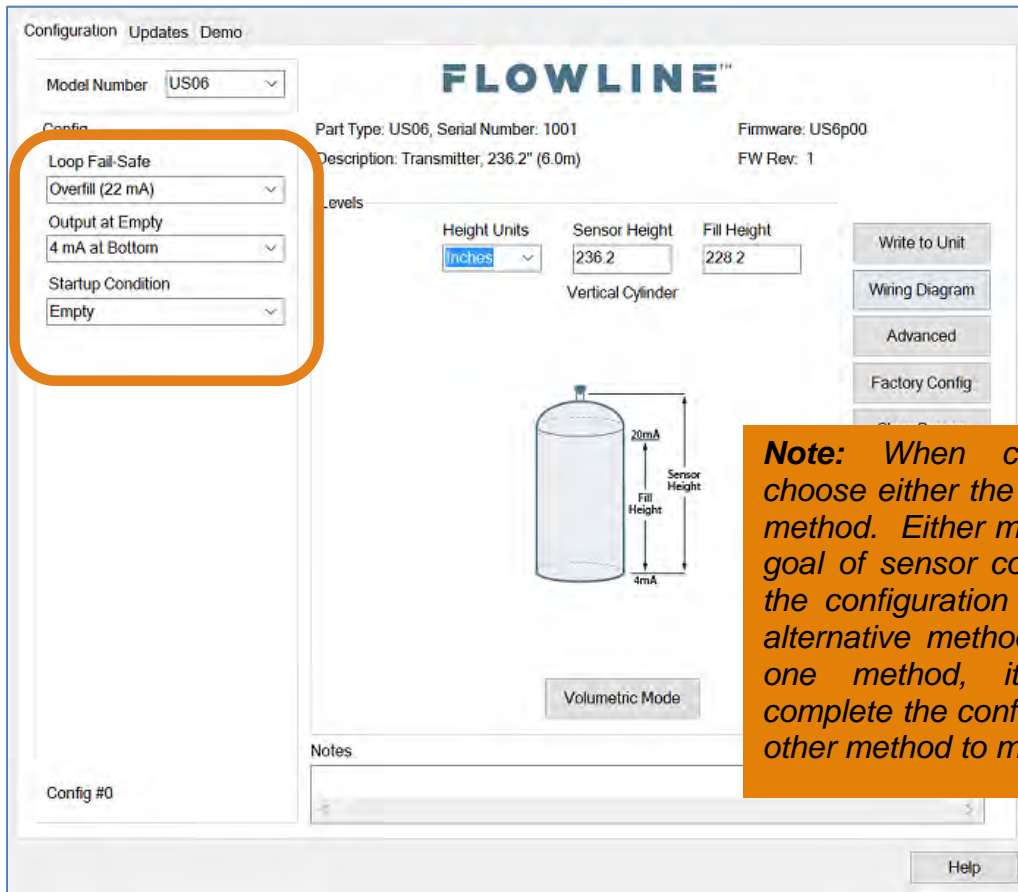

Note: When configuring EchoTouch®, choose either the WebCal® or Push Button method. Either method will accomplish the goal of sensor configuration. Changes to the configuration can be made using the alternative method. When beginning with one method, it is recommended to complete the configuration before using the other method to make any adjustments.

STEP 4 – DIMENSIONAL ENTRY:

Distance Mode (default): Output of sensor is based on the distance (height of liquid) in the tank. Any change in liquid level will reflect linearly to the current output. Note: Most applications will fall into this category. For Volumetric outputs, refer to **VOLUMETRIC CONFIGURATION** on page 40. The two values (Sensor Height and Fill-Height) below set the 4-20 mA current span for the sensor. Both values will be set in the units shown under Height Units.

Sensor Height: Sets the location for 4mA. It is based on the distance from the Empty level position (bottom of tank) to the Measurement location for the sensor (bottom of sensor).

Fill-Height: Sets the location for 20mA. It is based on the distance from the Empty level position (bottom of tank) to the Full level position (see below).

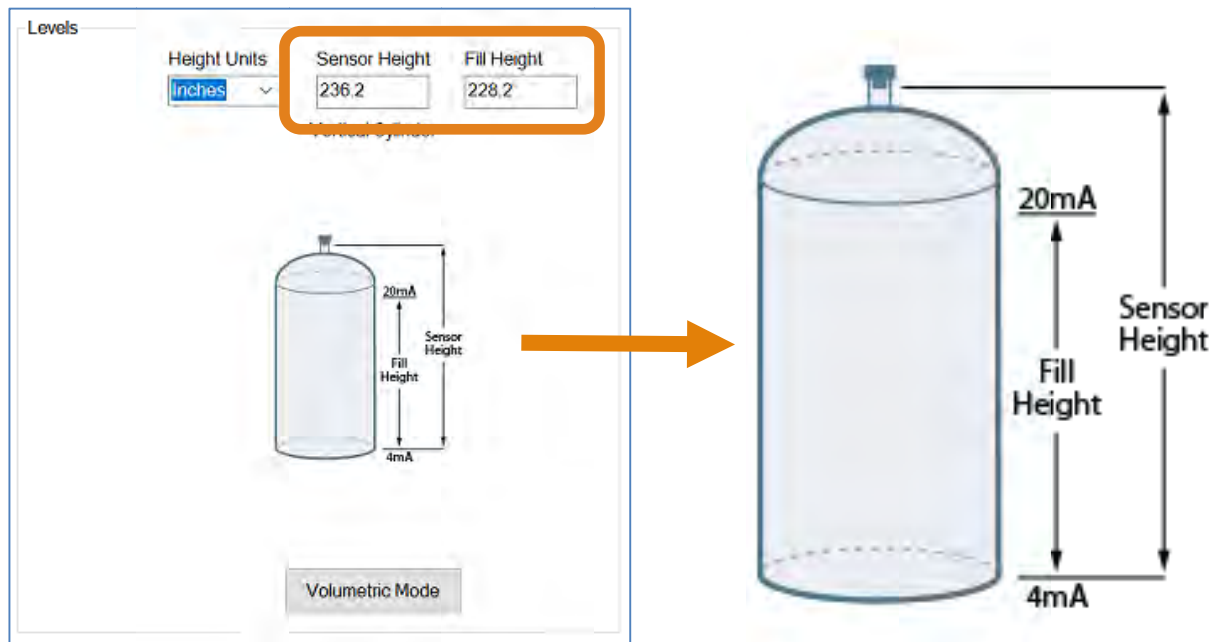

STEP 5 – TANK LEVEL CONFIRMATION:

Verify the Height Units, Sensor Height & Fill-Height. All values were calculated in the previous Dimensional Entry window. To adjust these settings, click on **Volumetric Modes**.

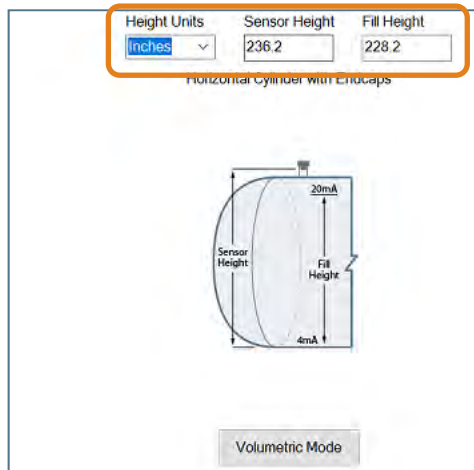
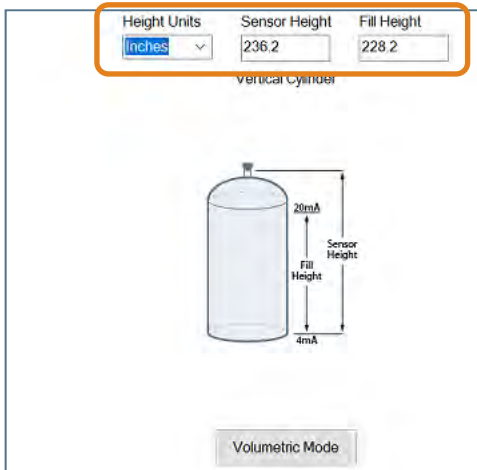

STEP 6 – WRITE TO UNIT:

This WebCal®* operation uploads configuration into the sensor. Other features in the section include providing a custom wiring diagram specific to the signal output and saving the configuration file to your hard drive.

Configuration Updates Demo

FLOWLINE™

Part Type: US06, Serial Number: 1001 Firmware: US6p00
Description: Transmitter, 236.2" (6.0m) FW Rev: 1

Model Number:

Config

Loop Fail-Safe:

Output at Empty:

Startup Condition:

Levels

Height Units	Sensor Height	Fill Height
Inches	236.2	228.2

Vertical Cylinder

Capacity: 9000.0

Notes

Config #0

Volumetric Sensor Output
The Volumetric Mode button will be highlighted in Blue when a volume output is selected.

* For complete information on the WebCal® software, please refer to the WebCal® manual located at flowline.com/webcal-software/.

EchoTouch® can be configured before installation. The transmitter features non-volatile memory, so any setting configured before installation will not be lost when the switch is powered down. To configure, follow the steps below: (Pages 27 to 31)

1. Measure the Tank
 - a. Begin by measuring the key tank and fitting dimensions.
 - b. Correct tank dimensions will result in accurate sensor measurement.
2. Set the Units of Measurement (**UNITS**)
 - a. Units can be configured in basic engineering units of length including Feet, Inches, Centimeters or Meters.
3. Set the Sensor Height (**HEIGHT**)
 - a. This is the empty setting (4mA) for the tank.
4. Set the Fill-Height (**FILL-H**)
 - a. This is the full setting (20mA) for the tank.
5. Set the Fail-Safety (**SAFE**)
 - a. This is the maximum measurement range for the sensor. The sensor will ignore all echo returns beyond this setting.

NOTE: When configuring EchoTouch®, choose either the WebCal® or Push Button method. Either method will accomplish the goal of sensor configuration. Changes to the configuration can be made using the alternative method. When beginning with one method, it is recommended to complete the configuration before using the other method to make any adjustments.

NOTE: Display configuration is only available with the US06 & US12 series.

EchoTouch® peut être configuré avant l'installation. L'émetteur dispose d'une mémoire non volatile, de sorte que tout réglage configuré avant l'installation ne sera pas perdu lorsque le commutateur est mis hors tension. Pour configurer, procédez comme suit: (Pages 32 à 36)

1. Mesurer le réservoir
 - a. Commencez par mesurer le réservoir de clés et les dimensions de montage.
 - b. Les dimensions correctes du réservoir entraîneront une mesure précise du capteur.
2. Définissez les unités de mesure (UNITS)
 - a. Les unités peuvent être configurées dans des unités d'ingénierie de base comprenant des pieds, des pouces, des centimètres ou des compteurs.
3. Réglez la hauteur du capteur (HAUTEUR)
 - a. C'est le réglage vide (4mA) pour le réservoir.
4. Définissez la hauteur de remplissage (FILL-H)
 - a. C'est le réglage complet (20mA) pour le réservoir.
5. Configurez la sécurité d'échec (SAFE)
 - a. C'est la plage de mesure maximale pour le capteur. Le capteur ignore tous les retours d'écho au-delà de ce paramètre.

REMARQUE: lors de la configuration d'EchoTouch®, choisissez la méthode WebCal® ou Push Button. L'une ou l'autre méthode atteindra l'objectif de la configuration du capteur. Les modifications apportées à la configuration peuvent être effectuées en utilisant la méthode alternative. En commençant par une méthode, il est recommandé de compléter la configuration avant d'utiliser l'autre méthode pour procéder à des ajustements.

REMARQUE: la configuration de l'affichage n'est disponible qu'avec les séries US06 & US12.

#1 - MEASURE THE TANK

Measuring the tank is one of the most important aspects in configuring the sensor. When measuring the tank, take into account the location of the sensor with respect to fittings, risers, dome tops and bottoms, and identify where the measurements are taken from the sensor. The Sensor Height is influenced by the installation location. Sensors mounted along the sloped portion of the tank will result in a lower (**HEIGHT**) value. On the other hand, sensors installed in risers/nozzles will result in a higher (**HEIGHT**) value.

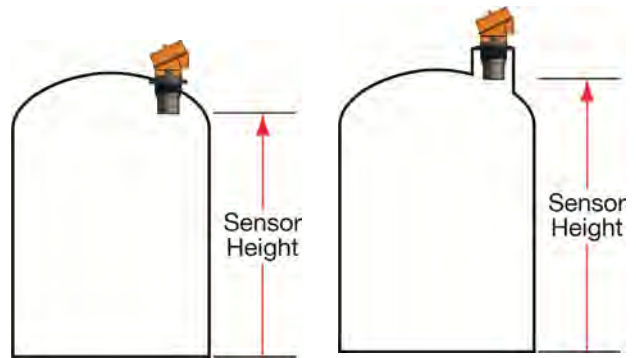

The basic measurements (**Height** and **Fill-H**) for configuration are described below:

1. **HEIGHT** (Sensor Height) - Distance from the bottom of the tank to the Bottom of Sensor.
 - a. The bottom of the tank will be the sensor's zero level / empty level.
 - a. This setting determines the 4mA location.
2. **FILL-H** (Fill-Height) - Distance from the bottom of the tank to the level of liquid where the tank is full is **FILL-H**.
 - a. The **FILL-H** is typically set to the liquid full level.
 - b. This setting determines the 20 mA location.
 - c. 20mA cannot be set within the sensor's dead band [8" (20cm) from bottom of sensor]. Largest **FILL-H** value will be as follows:

$$\text{Largest FILL-H} = \text{HEIGHT} - 8'' (20\text{cm})$$

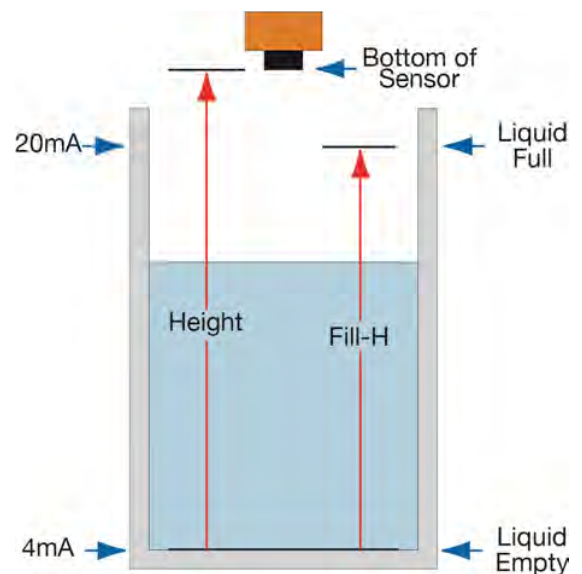

TOP-LEVEL MENU

- The TOP-LEVEL MENU will continue to scroll through the items listed to the right until the SELECT button is pressed.
- To return to the Normal / Operational mode of Echotouch®, press SELECT while **RUN** appears in the display.

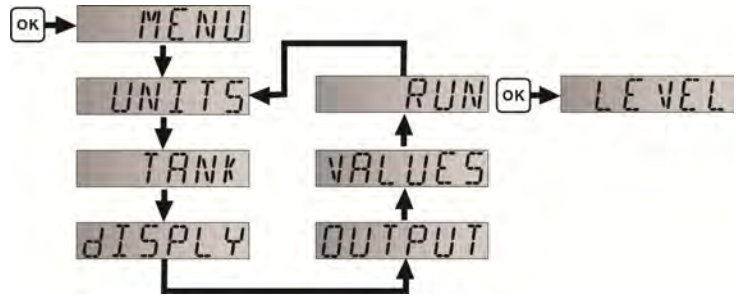

How to enter the TOP-LEVEL MENU

1. Press and hold OK (approximately 5 seconds) until **MENU** is displayed.
2. The TOP-LEVEL MENU items will rotate through display.
3. Use OK to choose a MENU item.



How to exit the TOP-LEVEL MENU

In TOP-LEVEL MENU, press SELECT when **RUN** appears.

STEP 2 - SETTING THE UNITS OF MEASUREMENT (UNITS)

1. In the TOP-LEVEL MENU mode, select **UNITS**.
2. Press OK to choose between **INCHES**, **CM** (centimeter), **FEET** or **METERS**.
 - a. To cancel **UNITS**, Select **EXIT**.
3. Select EXIT to return to the TOP-LEVEL MENU.

Note: EchoTouch® will adjust the display when measurement units are changed under **UNITS**. Example: If you are in inches and the display reads 60.0, the display will change to 5.00 when feet is selected as the unit of measurement.

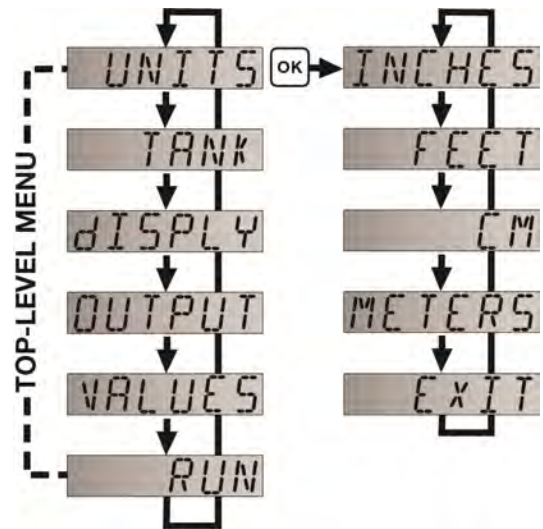

STEP 3 - SETTING THE HEIGHT (SENSOR HEIGHT)

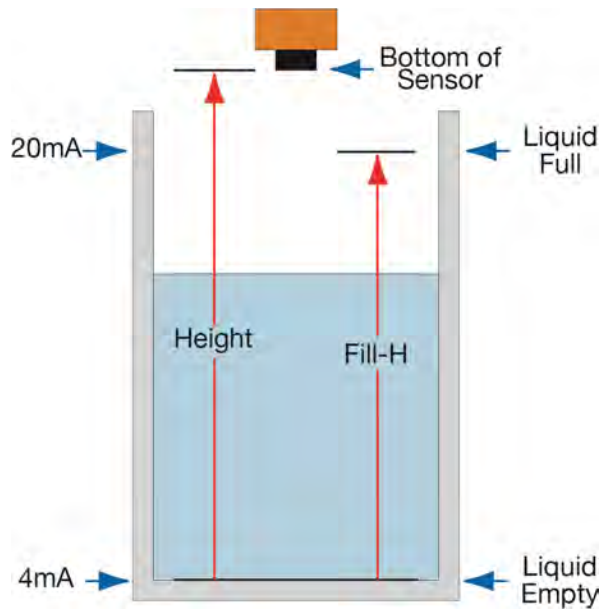

1. In TOP-LEVEL MENU mode, select **TANK**.
2. Select **HEIGHT**.
3. Using the UP and DOWN buttons, set the **HEIGHT** of the tank (transducer face to the bottom of the tank).
4. To enter the value, press and hold OK for 2 seconds and release. **SAVED** will display.
5. Select **EXIT** to return to TOP-LEVEL MENU.

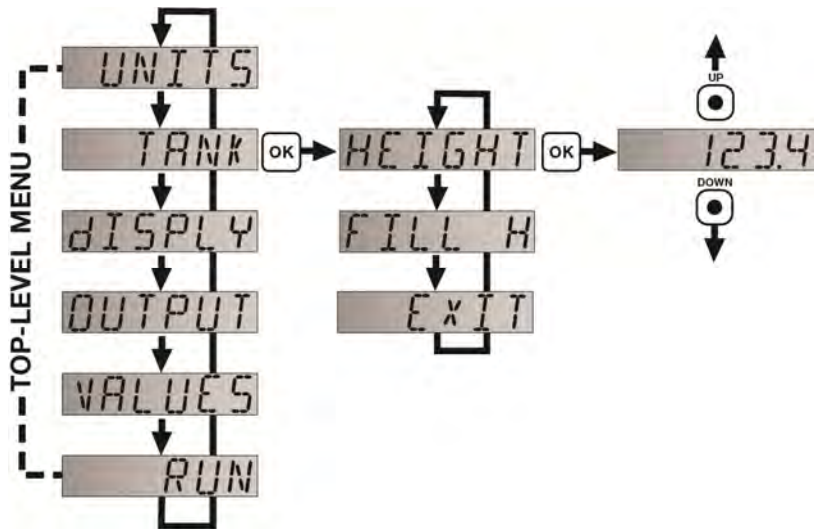

Note: The **HEIGHT** setting also determines the 4 mA current location. To reverse the current output with 20mA at the bottom of the tank, use the **REV MA** function.

Note: To speed up the scrolling of the values on the display, hold down the OK button while holding down the UP or DOWN buttons.

STEP 4 - SETTING THE FILL-H (FILL-HEIGHT)

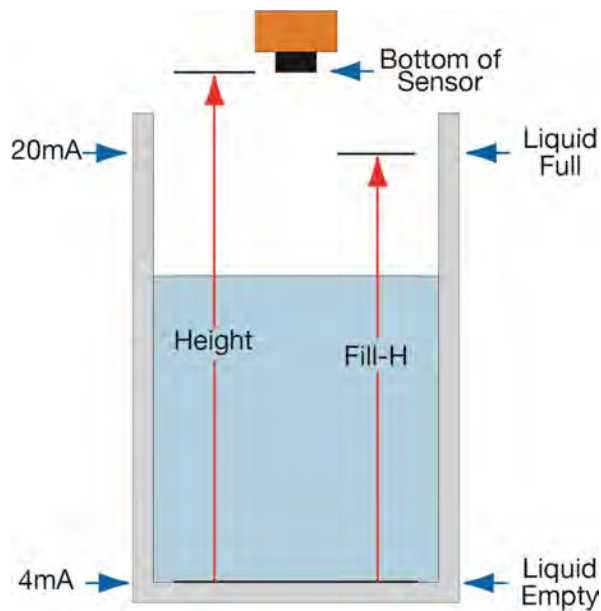

1. In TOP-LEVEL MENU mode, select **TANK**.
2. Select **FILL-H**.
3. Using the UP and DOWN buttons, set the Fill Height (**FILL-H**) of the tank (max. level of liquid to the bottom of the tank).
4. To enter the value, press and hold OK for 2 seconds and release. **SAVED** will display.
5. Select **EXIT** to return to TOP-LEVEL MENU.

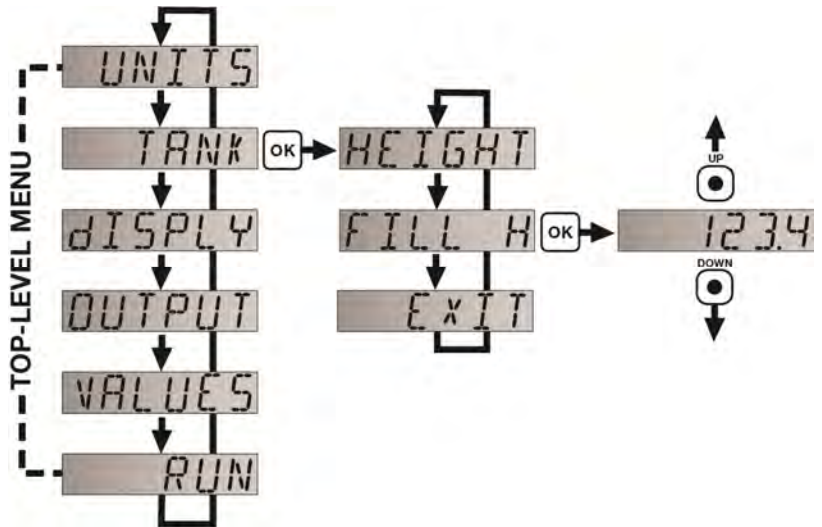

Note: The Fill-Height (**FILL-H**) setting determines the 20 mA current span. To reverse the current output with 4mA being at the top of the tank, use the **REV MA** function.

Note: To speed up the scrolling of the values on the display, hold down the OK button while holding down the UP or DOWN buttons.

STEP 5 - HOW TO SELECT FAIL-SAFE CURRENT OUTPUT (LOST)

In the event the sensor does not receive an echo, the Fail-Safe Current Output or **LOST** setting can be set to output a current of **4mA**, **20mA**, **21mA**, **22mA** or **Hold** (last known value). During fail-safe, the display will read **LOST**.

1. In TOP-LEVEL MENU mode, select **OUTPUT**.
2. Select **SAFE**.
3. Select **4mA**, **20mA**, **21mA**, **22mA** or **HOLD**.
 - a. Press and hold OK on the selected setting for 3 seconds then release.
 - b. To cancel **SAFE**, Select **EXIT**.
4. Select **EXIT** to return to TOP-LEVEL MENU.

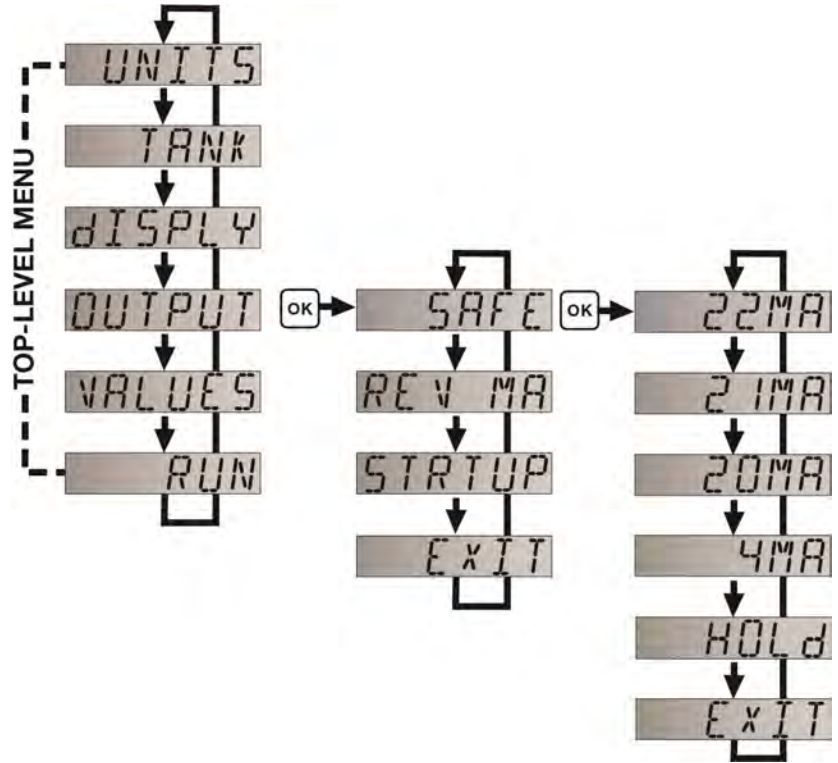
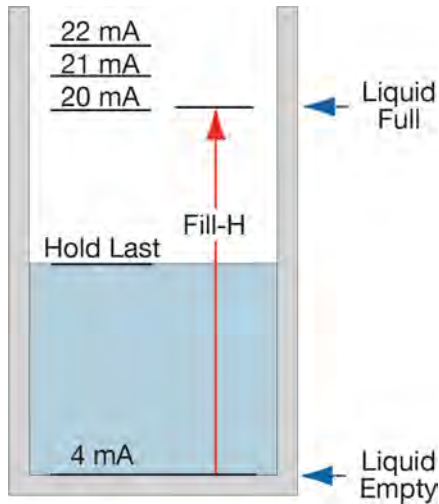

ÉTAPE #1 - MESURER LE TANK

La mesure du réservoir est l'un des aspects les plus importants de la configuration du capteur. Lors de la mesure du réservoir, tenir compte de l'emplacement du capteur en ce qui concerne les raccords, les élévateurs, les dômes et les fonds, et identifier les mesures prises à partir du capteur. La hauteur du capteur est influencée par l'emplacement d'installation. Les capteurs montés le long de la partie inclinée du réservoir entraîneront une valeur inférieure (**HAUTEUR**). D'autre part, les capteurs installés dans les risers / buses entraîneront une valeur plus élevée (**HAUTEUR**).

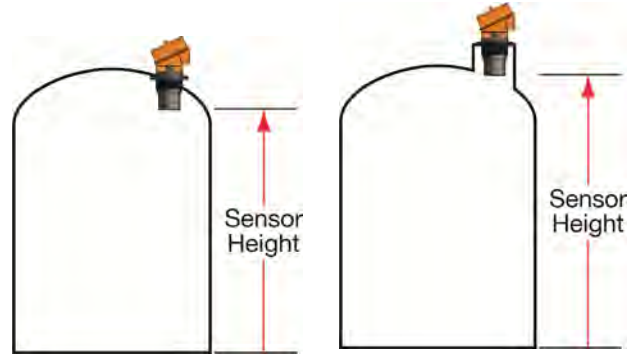

Les mesures de base (**Height** et **Fill-H**) pour la configuration sont décrites ci-dessous :

1. **HEIGHT** (Hauteur du capteur) - Distance du fond du réservoir au bas du capteur.
 - a. Le fond du réservoir correspondra au niveau zéro / vide du capteur.
 - b. Ce paramètre détermine l'emplacement 4mA.
2. **FILL-H** (Fill-Height) - La distance du fond du réservoir au niveau du liquide où le réservoir est plein est FILL-H.
 - a. Le **FILL-H** est généralement réglé sur le niveau complet du liquide.
 - b. Ce paramètre détermine l'emplacement de 20 mA.
 - c. 20mA ne peut pas être réglé dans la bande morte du capteur [8 "(20cm) du bas du capteur]. La plus grande valeur **FILL-H** sera la suivante:

Le plus grand **FILL-H** = **HEIGHT** - 8 "(20cm)

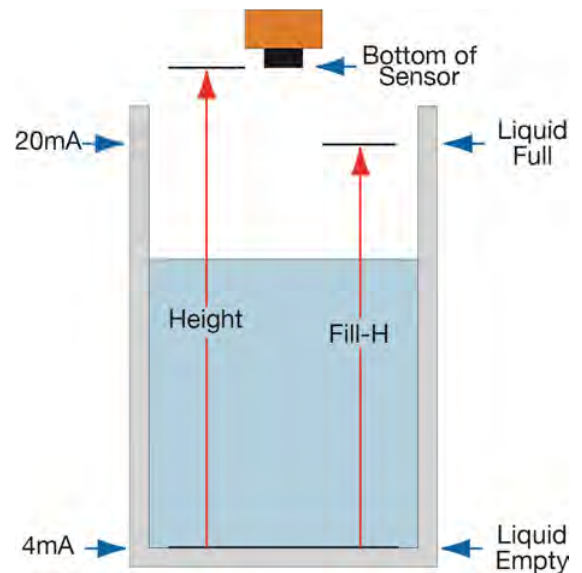

MENU DE HAUT NIVEAU

- Le MENU TOP-LEVEL continuera à faire défiler les éléments répertoriés à droite jusqu'à ce que le bouton OK soit enfoncé.
- Pour revenir au mode Normal / Opérationnel d'Echotouch®, appuyez sur OK pendant que RUN apparaît à l'écran.

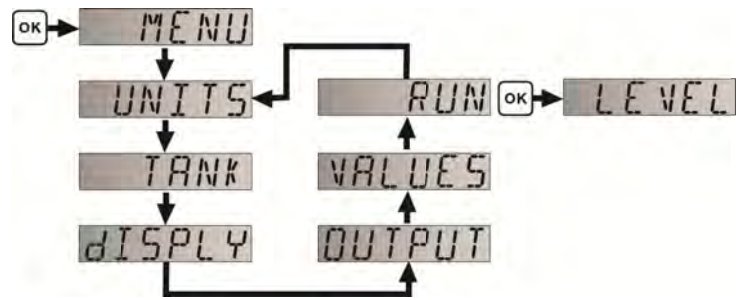

Comment accéder au MENU DE NIVEAU SUPÉRIEUR

- Appuyez et maintenez la touche SELECT (environ 5 secondes) jusqu'à ce que MENU soit affiché.
- Les éléments TOP-LEVEL MENU tournent à travers l'affichage.
- Utilisez OK pour choisir un élément MENU.



Comment quitter le MENU DE NIVEAU SUPÉRIEUR

Dans le MENU HAUT DE NIVEAU, appuyez sur OK lorsque RUN apparaît.

ÉTAPE #2 - RÉGLAGE DES UNITÉS DE MESURE (UNITS)

- Dans le mode TOP-LEVEL MENU, sélectionnez UNITS.
- Appuyez sur SELECT pour choisir entre INCHES, CM (centimètre), FEET ou METERS.
 - Pour annuler UNITS, sélectionnez EXIT.
- Sélectionnez EXIT pour revenir au MENU TOP-LEVEL.

Remarque: EchoTouch® réglera l'affichage lorsque les unités de mesure sont modifiées sous **UNITS**. Exemple: si vous êtes en pouces et que l'affichage indique 60.0, l'affichage passe à 5,00 lorsque les pieds sont sélectionnés comme unité de mesure.

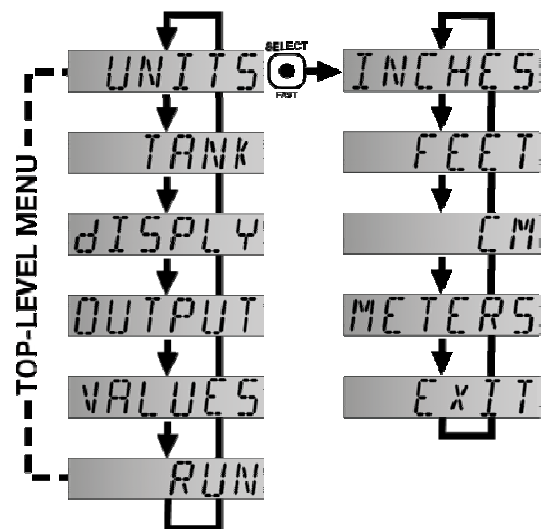

ÉTAPE 3 - RÉGLAGE DE LA HAUTEUR (SENSOR HEIGHT)

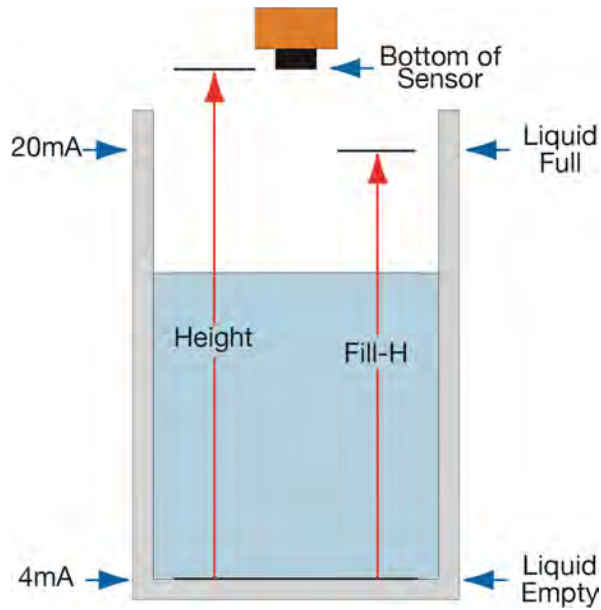

1. En mode TOP-LEVEL MENU, sélectionnez **TANK**.
2. Sélectionnez **HEIGHT**.
3. À l'aide des boutons HAUT et BAS, réglez la **HEIGHT** du réservoir (face du transducteur au bas du réservoir).
4. Pour entrer la valeur, appuyez et maintenez la touche OK pendant 2 secondes et relâchez. **SAVED** s'affichera.
5. Sélectionnez **EXIT** pour revenir au MENU TOP-LEVEL.

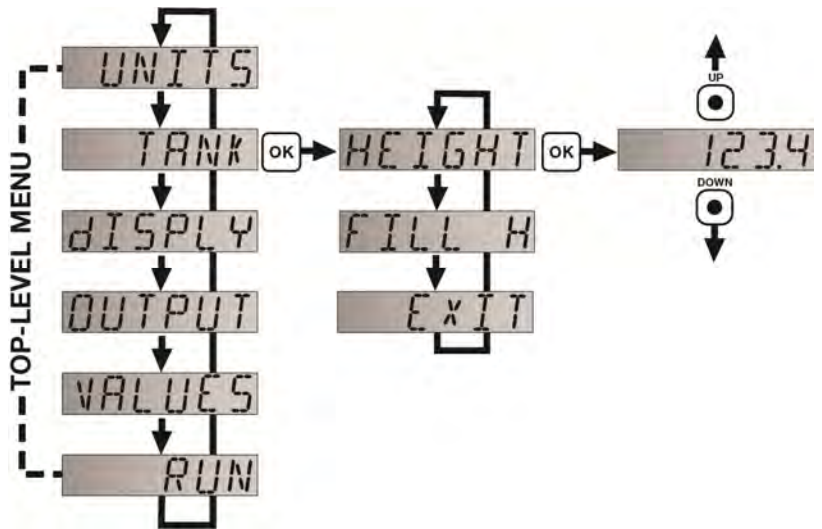

Remarque: Le paramètre **HEIGHT** détermine également l'emplacement actuel de 4 mA. Pour inverser la sortie de courant avec 20 mA au bas du réservoir, utilisez la fonction **REV MA**.

Remarque: Pour accélérer le défilement des valeurs sur l'affichage, maintenez la touche OK enfoncée tout en maintenant enfoncés les boutons UP ou DOWN.

ÉTAPE 4 - RÉGLAGE DE LA FILL-H (FILL-HEIGHT)

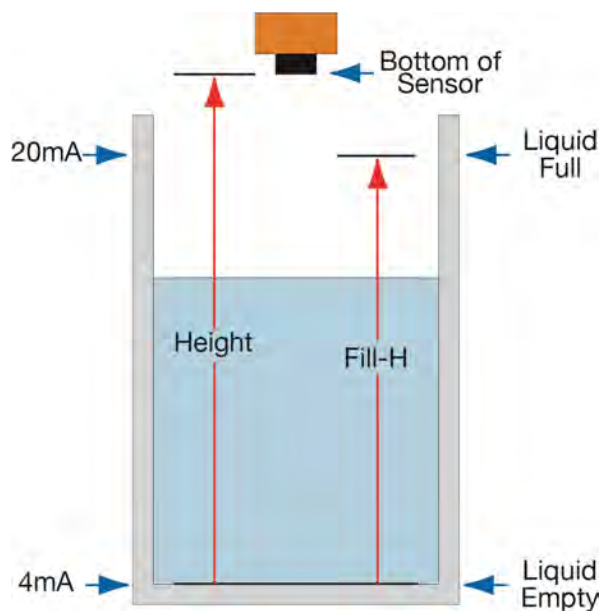

1. En mode TOP-LEVEL MENU, sélectionnez **TANK**.
2. Sélectionnez **FILL-H**.
3. À l'aide des boutons HAUT et BAS, réglez la hauteur de remplissage (**FILL-H**) du réservoir (niveau maximum de liquide au fond du réservoir).
4. Pour entrer la valeur, appuyez et maintenez la touche OK pendant 2 secondes et relâchez. **SAVED** s'affichera.
5. Sélectionnez **EXIT** pour revenir au MENU TOP-LEVEL.

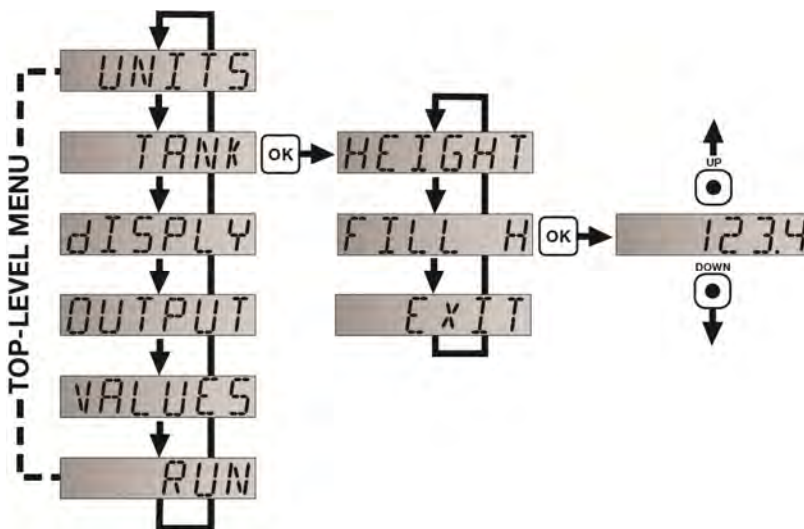

Remarque: Le paramètre de hauteur de remplissage (**FILL-H**) détermine la portée de courant de 20 mA. Pour inverser la sortie de courant avec 4mA en haut du réservoir, utilisez la fonction **REV MA**.

Remarque: Pour accélérer le défilement des valeurs sur l'affichage, maintenez la touche OK enfoncée tout en maintenant enfoncés les boutons UP ou DOWN.

ÉTAPE 5 - COMMENT SÉLECTIONNER UNE SORTIE ACTUELLE FAIBLE (LOST)

Dans le cas où le capteur ne reçoit pas d'écho, le réglage de sortie de courant sans échec ou **LOST** peut être configuré pour afficher un courant de **4mA**, **20mA**, **21mA**, **22mA** ou **Hold** (dernière valeur connue). En cas de panne de sécurité, l'affichage se lire **LOST**.

1. En mode TOP-LEVEL MENU, sélectionnez **OUTPUT**.
2. Sélectionnez **SAFE**.
3. Sélectionnez **4mA**, **20mA**, **21mA**, **22mA** ou **HOLD**.
 - a. Appuyez et maintenez OK sur le réglage sélectionné pendant 3 secondes, puis relâchez.
 - b. Pour annuler **SAFE**, sélectionnez **EXIT**.
4. Sélectionnez **EXIT** pour revenir au MENU TOP-LEVEL.

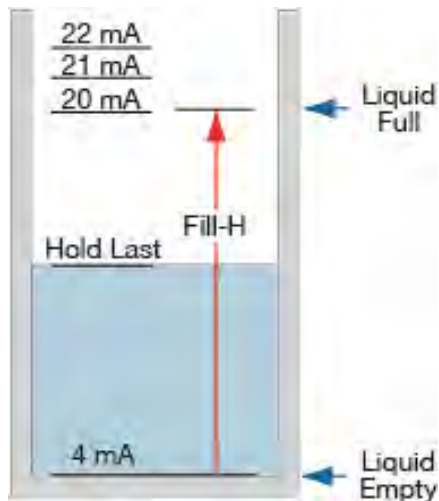
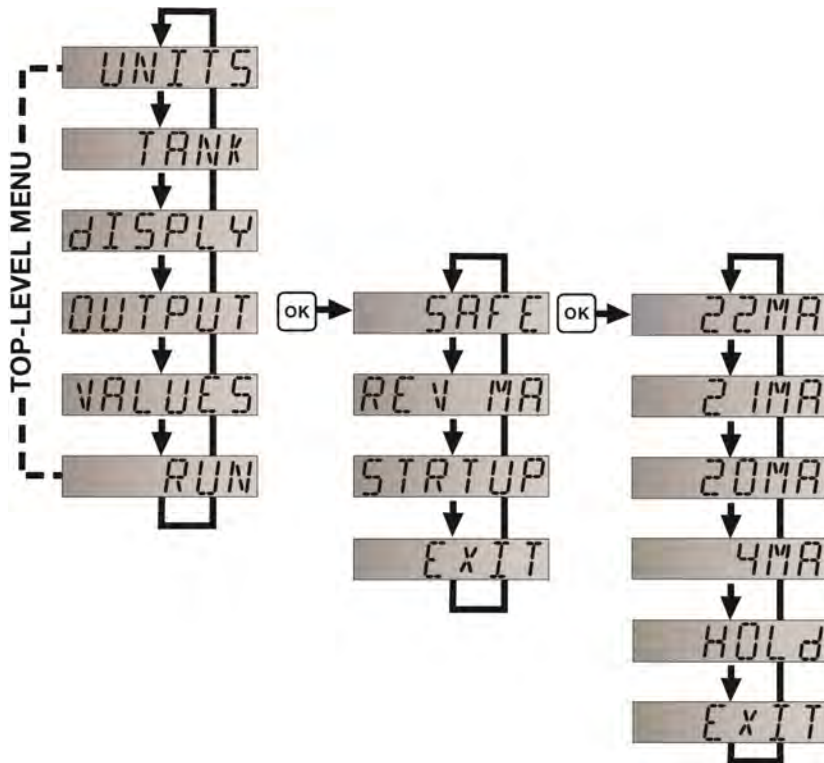

EchoTouch® should always be mounted perpendicular to the liquid surface (use the provided Viton® mounting gasket for G threaded versions only). Make sure that the fitting and transmitter threads are not damaged or worn. Always *hand-tighten* the transmitter within the fitting. Perform an installed leak test under normal process conditions prior to system start up.

⚠ Warning - Potential Electrostatic Charging Hazard (Handling Static-Sensitive Circuits/Devices): When handling the transmitter, the technician should follow these guidelines to reduce any possible electrostatic charge build-up on the technician's body and the electronic part.

1. Always touch a known good ground source before handling the part. This should be repeated while handling the part and more frequently after sitting down from a standing position, sliding across the seat or walking a distance.
2. Avoid touching electrical terminals of the part unless making connections.
3. DO NOT open the unit cover until it is time to calibrate.

MOUNTING GUIDE

1. Do not mount at an angle
2. Liquid should never enter the dead band
3. Side Wall:
 - a. Mount at least 3" from the side wall
4. Do not mount where obstacles will intrude on sensor's beam width
 - a. mount at least 3" from the side wall
5. Do not mount in a vacuum
6. Do not mount in the center of a dome top tank.
7. In cone bottom tank, position the sensor over the deepest part of the tank.

Installation in existing fittings: If the existing fitting is larger than the threads of the EchoTouch®, select a reducer bushing such as the LM52-2400 (3" thread x 2" thread) or LM52-3400 (4" thread x 2" thread).



LM52-2400

<p><i>Do not install at an angle relative to the liquid.</i></p>	
<p><i>Do not install within 3" of tank sidewall.</i></p>	
<p><i>Do not install with objects in the beam.</i></p>	
<p><i>Do not install in applications with vacuum.</i></p>	
<p><i>Do not install in the center of a dome top tank.</i></p>	

EchoTouch® doit toujours être monté perpendiculairement à la surface du liquide (utilisez le joint de fixation Viton® fourni uniquement pour les versions filetées G). Assurez-vous que les fils de montage et d'émetteur ne sont pas endommagés ou usés. Toujours serrer à la main l'émetteur dans le raccord. Effectuer un test d'étanchéité installé dans des conditions de processus normales avant le démarrage du système.

GUIDE DE MONTAGE

1. Ne pas monter à angle
2. Le liquide ne devrait jamais entrer dans la bande morte
3. Mur latéral:
 - a. Montez au moins 3 "de la paroi latérale
4. Ne pas monter où les obstacles s'immisceront sur la largeur du faisceau du capteur.
 - a. monter au moins 3 "de la paroi latérale
5. Ne pas monter sous vide
6. Ne pas monter au centre d'un réservoir en forme de dôme.
7. Dans le réservoir inférieur cône, positionnez le capteur sur la partie la plus profonde du réservoir.

Installation dans les raccords existants: si le raccord existant est plus grand que les fils de l'EchoTouch®, sélectionnez une douille réductrice telle que le LM52-2400 (filetage 3 "x 2") ou LM52-3400 (filetage 4 "filetage x 2")



LM52-2400

<p><i>Ne pas installer à un angle par rapport au liquide.</i></p>	
<p><i>Ne pas installer à moins de 3 po de la paroi latérale du réservoir.</i></p>	
<p><i>Ne pas installer avec des objets dans la poutre.</i></p>	
<p><i>Ne pas installer dans des applications avec vide.</i></p>	
<p><i>Ne pas installer au centre d'un réservoir en forme de dôme.</i></p>	

FITTING SELECTION

Check the part number to determine the required fitting mount size and thread type. EchoTouch® is commonly installed in tank adapters, flanges, brackets or standpipes. **Note:** Always include the gasket when installing the “G” threaded EchoTouch®.

1. **Tank Adapter:** Select a tank adapter fitting, such as the LM52-2890 tank adapter for 2” sensors or the LM52-3890 for 3” sensors.
 - a. For best results, select a 3” tank adapter and add a reducer bushing such as the LM52-2400, thread x thread, reducer bushing.
 - b. Avoid tank adapter (thread x thread) styles and/or pipe stops forward of the installed transducer.
 - c. Always mount the tank adapter so the majority of fitting is outside the tank.
 - i. **Note:** Never mount the tank adapter upside down or where the bulk of the material is inside the tank.

**2” Tank Adapter
Socket x Thread
(LM52-2890)**



**Tank Adapter
w/ 3”x2” Reducer Bushing
(LM52-3890 w/LM52-2800)**



**3” Tank Adapter
Socket x Thread
(LM52-3890)**



**Tank Adapter
Thread x Thread**



Do not use thread x thread

2. **Riser:** Installations with tall, narrow risers can impede the acoustic signal.
 - a. **Core Out Concrete:** Applications where a tank with a concrete ceiling that has been cored out can also be considered as a riser type application. In these applications follow a 2:1 ratio (Inner Diameter to Core Height) for the diameter of the core.
 - a. 3” (7.6 cm) diameter risers should be no taller than 6” (15 cm). Larger diameter risers should be no taller than 12” (30 cm).

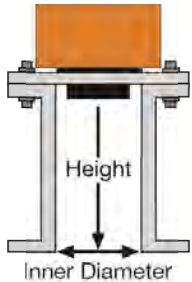
	Riser Specifications	
	Inner Diameter	Maximum Height
	3” (7.6cm)	6” (15cm)
	4” (10cm)	8” (20cm)
	5” (12.5cm)	10” (25cm)
	6” (15cm)	12” (30cm)

Note: Do not exceed the dimensions listed above.



Note: If attempting to raise the sensor above the top of the tank to allow for a higher fill capacity, avoid the use of tall and narrow risers. The example to the left exceeds the dimensions listed in the **Riser Specifications** chart. Use a larger tank adapter which takes into account the **Riser Specifications**.

3. **Flange:** If installing on a flange, select a flange with a thread that is above the plane of the flange, such as the LM52-2850.
 - a. Use a flange with a 3" thread and add a 3" to 2" reducer bushing to complete the installation.

2" Flange w/
(LM52-2850)



3" Flange w/ Reducer Bushing
(LM52-3800)



3" Flange
(LM52-3850)



4. **Side Mount Bracket:** For installations in open tanks and sumps, use the LM50-1001 series side mount bracket.

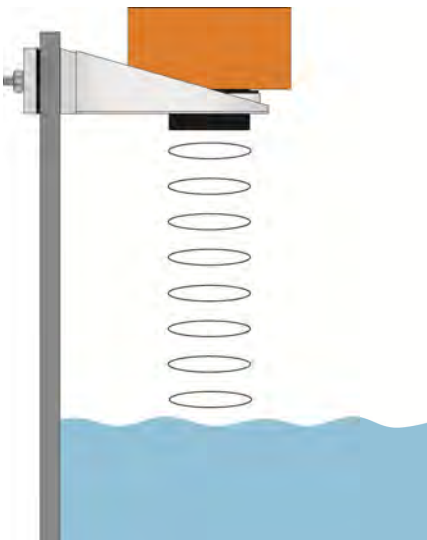

LM50-1001 Shown

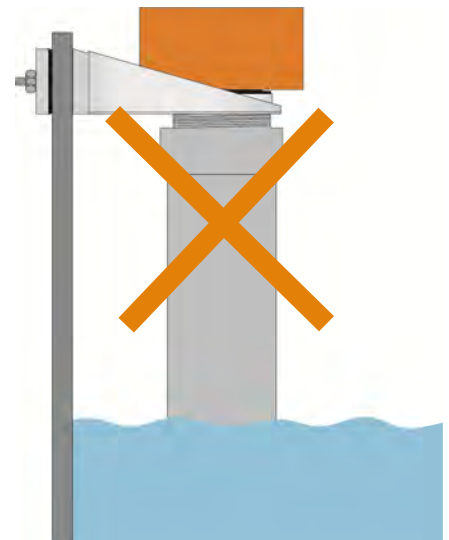

Note: The Side Mount Bracket (LM50 series) is not designed for use with stand pipes or as a method to secure stand pipes. There are too few threads to properly hold the sensor and the stand pipe.

- 5. Stand Pipe:** A standpipe may be used to dampen turbulence or when foam is present in the application.
- a) Pipe can be constructed from any material.
 - b) Select a minimum 3" ID pipe or greater for the stand pipe.
 - i) Select a minimum 4" IS for the US12 series.
 - c) Use a coupling and reducer bushing to attach the EchoTouch® to the pipe.
 - i) Use a reducer bushing such as LM52-2400 (3" Thread x 2" Thread) fitting or the LM52-2410 (3" Slip x 2" Thread) fitting.
 - d) The pipe length should run the measurement span. The bottom of the pipe should remain submerged at all times to prevent foam from entering the pipe.
 - e) Cut a 45° notch at the bottom of the pipe. Drill a 1/4" pressure equalization hole in the dead band.
 - f) The pumps should not drive liquid past the open end of the stand pipe which causes the liquid in the pipe to oscillate.

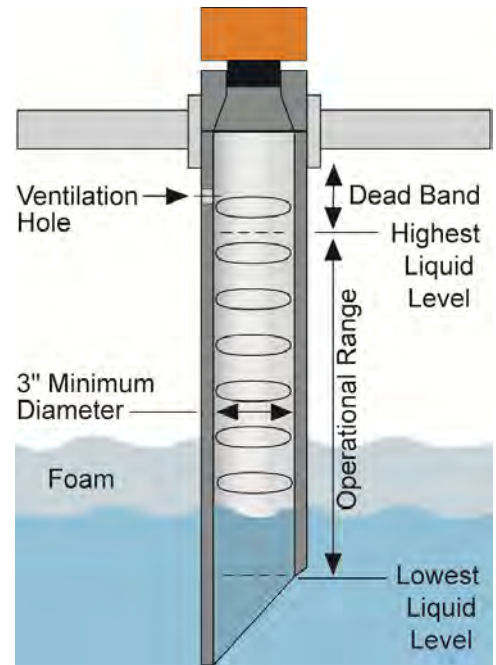

Note: Never allow the bottom of the stand pipe to become exposed to air. This will break the liquid seal which will prevent echoes from returning back to the sensor.

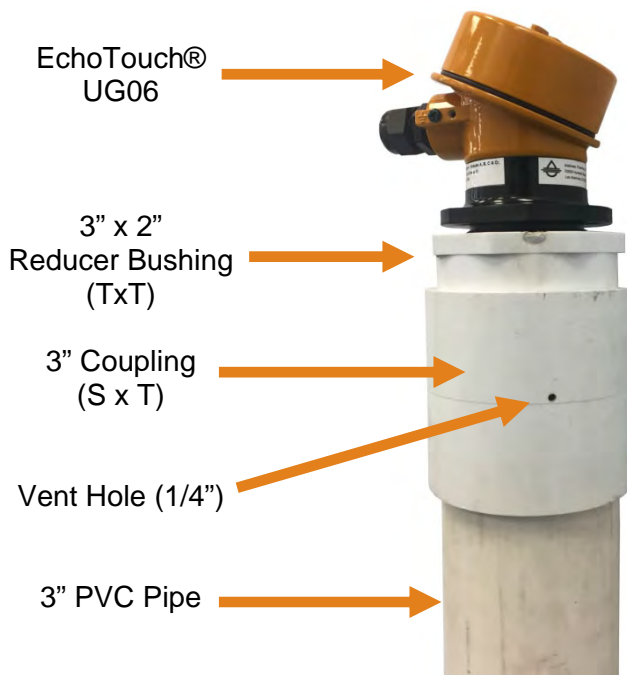

EchoTouch® attached to a LM52-2400 (3" x 2" reducer bushing) to a Slip x Thread 3" Coupling.



Avoid the use of a tee within the stand pipe. A tee can create false signals impeding the sensor's performance.

WIRE CONNECTIONS

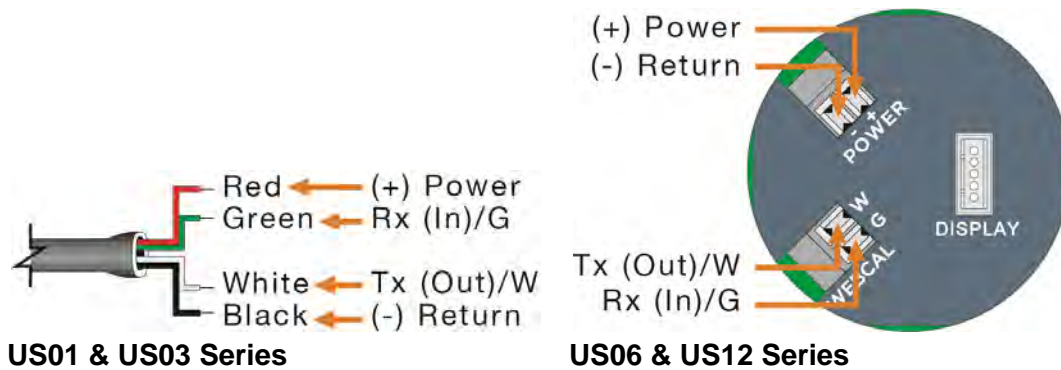

(+) Power & (-) Return: (+) Power and (-) Return leads are for connection to a 24 VDC power supply or to a 4-20 mA loop power source. The (+) and (-) wires can be extended up to 1,000 feet using a 22-gauge or larger wire.

Tx (Out)/W & Rx (In)/G: Tx (Out)/White and Rx (In)/Green leads are reserved for use with WebCal[®]. **Note:** The Green wire is not the Ground for the transmitter. In addition, these wires should not be connected to WebCal[®] while power is supplied from any source other than the LI99 series Fob. The maximum cable distance between the computer and Echotouch[®] is 15' (4.6m). **Note:** Never allow the white or green wires to touch any power supply.

GENERAL NOTES FOR ELECTRICAL CONNECTIONS, USAGE AND SAFETY

- **Where personal safety or significant property damage can occur due to a spill, the installation must have a redundant backup safety system.**
- Wiring should always be completed by a licensed electrician.
- Supply voltage should never exceed 28 VDC.
- Use 16 to 24 AWG for connecting to terminals.
- Protect the sensor from excessive electrical spikes by isolating the power, whenever possible.
- The sensor materials must be chemically compatible with the liquids to be measured.
- Design a fail-safe system for possible sensor and/or power failure.
 - During power failure, relays will remain in their current state and will not change until power is restored and the signal is reacquired.

ACCESSING THE TERMINALS (US06 & US12 SERIES ONLY)

To access the terminals, gently remove the display from the housing.

When wiring is completed, restore the display to the housing and replace the cover.

The US06 & US12 series can operate without the display. When wired and powered correctly, the sensor will continue to provide a proportional 4-20 mA signal.

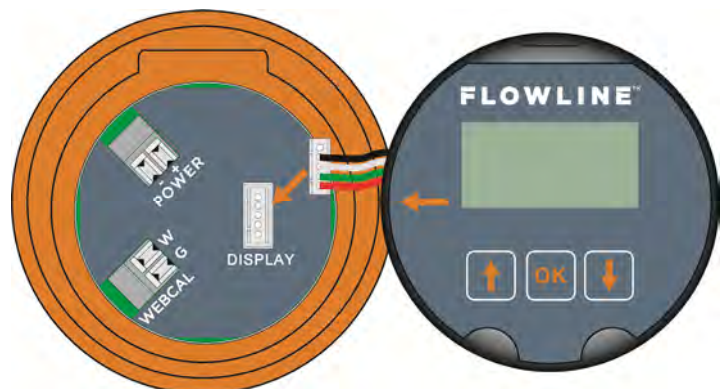

CONNEXIONS DE FIL

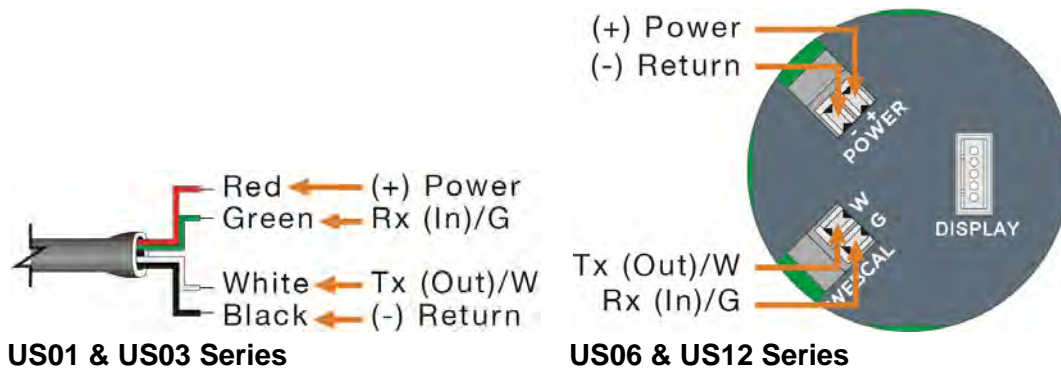

(+) Alimentation et (-) Retour: (+) Alimentation et (-) Les fils de retour sont destinés à être connectés à une alimentation 24 V cc ou à une source d'alimentation en boucle 4-20 mA. Les fils (+) et (-) peuvent être prolongés jusqu'à 1000 pieds à l'aide d'un fil de calibre 22 ou supérieur.

Les connexions Tx (Sortie) / W & Rx (In) / G: Tx (Out) / White et Rx (In) / Green sont réservées pour une utilisation avec WebCal®. **Remarque:** le fil vert n'est pas la terre de l'émetteur. En outre, ces fils ne doivent pas être connectés à WebCal® lorsque l'alimentation est fournie par une source autre que la série LI99 Fob. La distance maximale du câble entre l'ordinateur et EchoTouch® est de 15' (4.6m). **Remarque:** N'autorisez jamais les fils blanc ou vert à toucher n'importe quelle alimentation électrique.

NOTES GÉNÉRALES POUR CONNEXIONS ÉLECTRIQUES, UTILISATION ET SÉCURITÉ

- **Lorsque la sécurité personnelle ou des dégâts matériels importants peuvent survenir en raison d'un déversement, l'installation doit comporter un système de sécurité de secours redondant.**
- Le câblage doit toujours être complété par un électricien autorisé.
- La tension d'alimentation ne doit jamais dépasser 28 VDC.
- Protégez le capteur contre les pointes électriques excessives en isolant l'alimentation, chaque fois que cela est possible.
- Les matériaux du capteur doivent être chimiquement compatibles avec les liquides à mesurer.
- Conception d'un système de sécurité pour détecter un éventuel capteur et / ou une panne de courant.
 - Pendant la panne de courant, les relais resteront dans leur état actuel et ne changeront pas jusqu'à ce que l'alimentation soit rétablie et que le signal soit réapprovisionné.

ACCÈS AUX TERMINAUX (US06 & US12 SERIES ONLY)

Pour accéder aux bornes, retirez doucement l'affichage du boîtier.

Lorsque le câblage est terminé, rétablissez l'affichage sur le boîtier et remettez le couvercle.

Les séries US06 & US12 peuvent fonctionner sans l'affichage. Lorsqu'il est câblé et alimenté correctement, le capteur continuera à fournir un signal proportionnel à 4-20 mA.

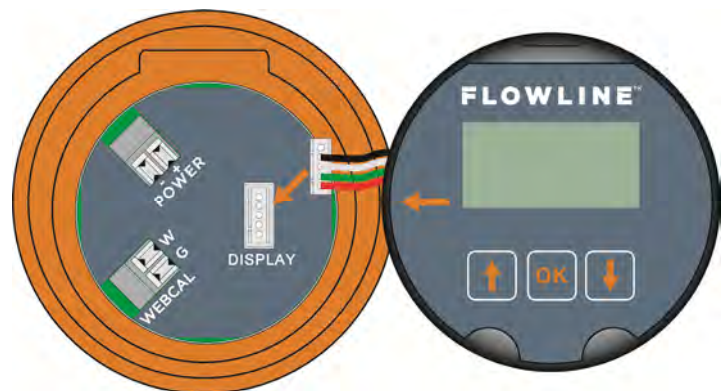

COMMON WIRING TO DISPLAY, CONTROLLERS & PLC'S

Below is a quick review of wiring the EchoTouch® to common display, controllers and PLC's.

DataView™ LI55 Series Level Controller

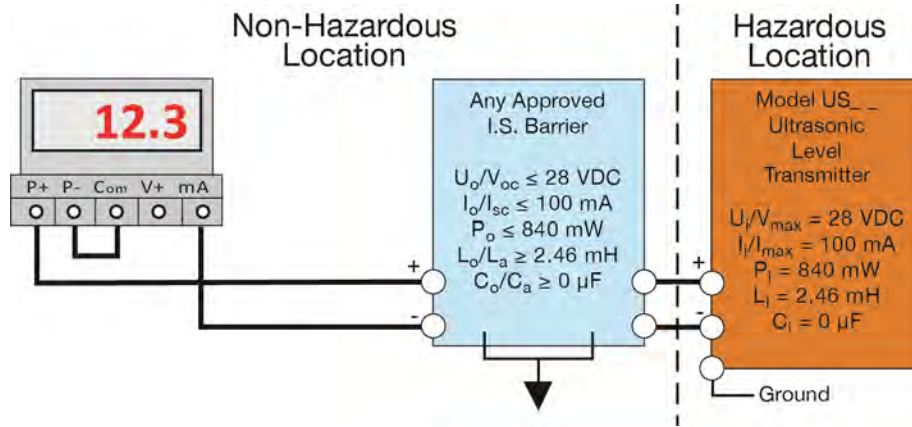

DataLoop™ LI23 Series Level Indicator without the backlight

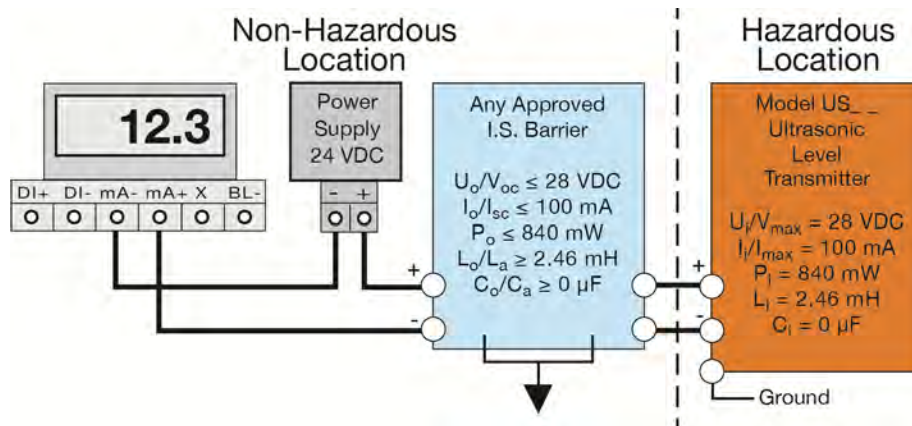

DataLoop™ LI23 Series Level Indicator with the backlight

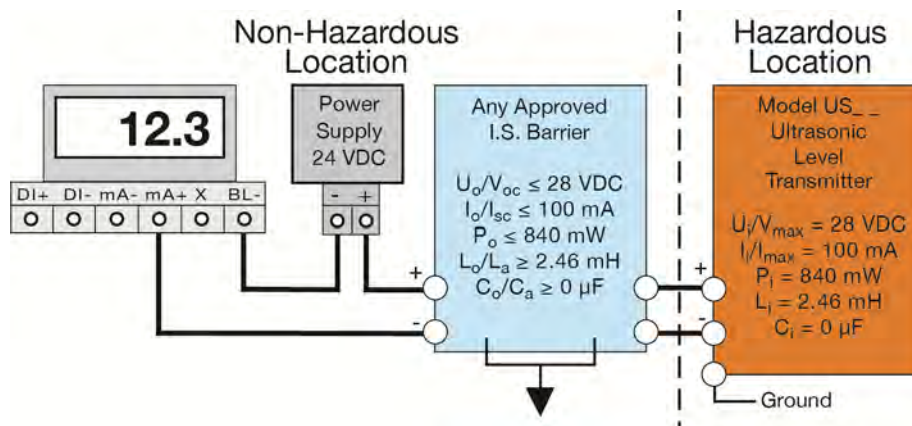

Note: Always refer to control drawing 600820 for the UG06 & US12 series and control drawing 610125 for UG01 and UG03 series.

COMMON WIRING TO DISPLAY, CONTROLLERS & PLC'S

Below is a quick review of wiring the EchoTouch® to common display, controllers and PLC's.

Commander™ LI90 Series Multi-Tank Level Controller

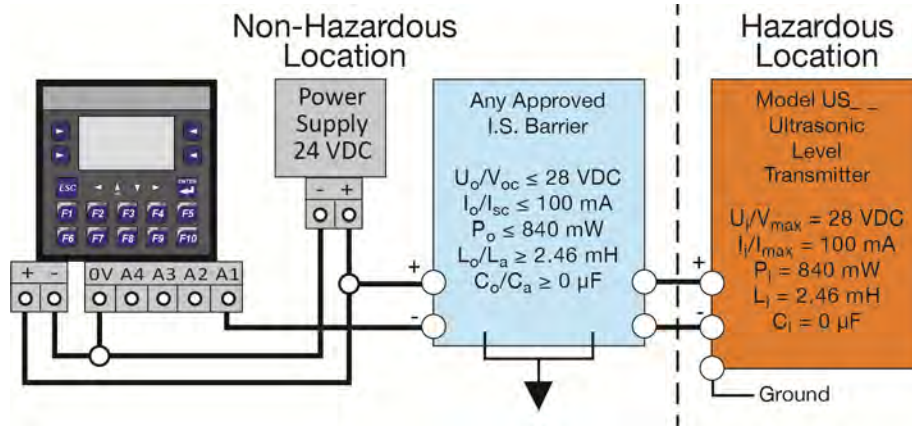

DataPoint™ LC52 Series Level Controller JWA mode (Factory Setting)

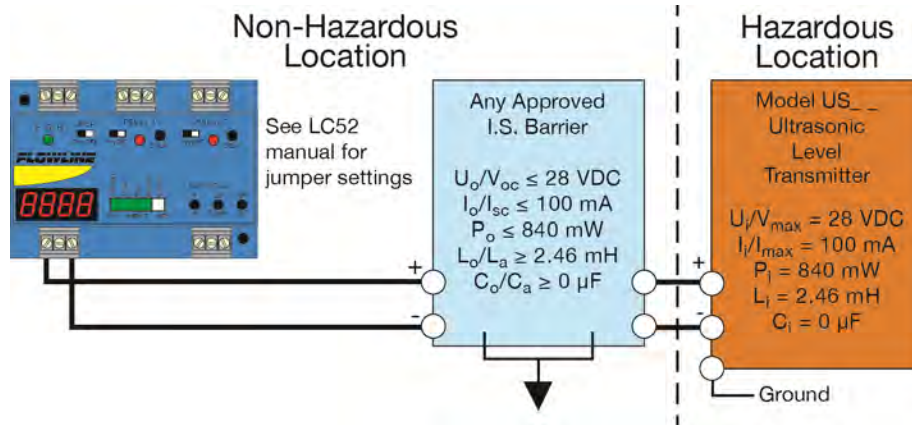

Generic Loop Powered Display

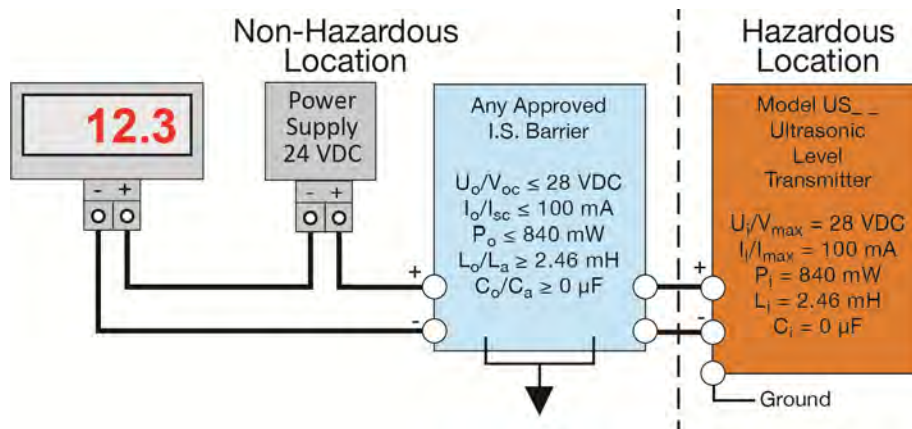

Note: Always refer to control drawing 600820 for the UG06 & US12 series and control drawing 610125 for UG01 and UG03 series.

COMMON WIRING TO DISPLAY, CONTROLLERS & PLC'S

Below is a quick review of wiring the EchoTouch® to common display, controllers and PLC's.

Generic PLC

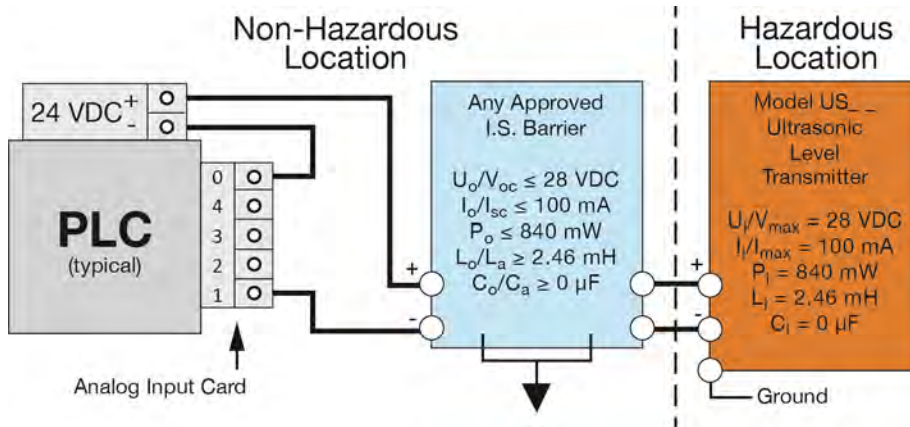

Note: Always refer to control drawing 600820 for the UG06 & US12 series and control drawing 610125 for UG01 and UG03 series.

This section of WebCal® is where you select the sensor configuration settings. Start from the top and work to the bottom, choosing the selections that are applicable to your application. All configuration settings must be selected before you can continue to the next step.

SENSOR CONFIGURATION

Config

Loop Fail-Safe

Overfill (22 mA)

Output at Empty

4 mA at Bottom

Startup Condition

Empty

Config #0

LOOP FAIL-SAFE

This feature allows you to select the fail-safe current output if the sensor loses echo confidence (LOST). When the sensor regains echo confidence, the output current will revert back to the current level condition.

- **Hold Last Value** - The output will remain in the same state as the last validated echo detected. Example: If the output was 6.7mA just prior to the lost signal, the sensor will continue to output 6.7mA until echo confidence is regained.
- **Empty** - The output will revert to the current value for an empty condition. When **4 mA at Bottom** is selected, the sensor will output 4 mA during a fail-safe condition. If **20 mA at Bottom** is selected, the sensor will output 20 mA during a fail-safe condition.
- **Full** - The output will revert to the current value for a full condition. When **4 mA at Bottom** is selected, the sensor will output 20 mA during a fail-safe condition. If **20 mA at Bottom** is selected, the sensor will output 4 mA during a fail-safe condition.
- **Overfill (21mA)** - The sensor will output 21mA during a fail-safe condition.
- **Overfill (22mA)** - The sensor will output 22mA during a fail-safe condition.

OUTPUT AT EMPTY

This feature allows you to select the orientation of the 4 to 20mA output (4 to 20 mA or 20 to 4 mA). Choose which output setting best fits the application. Factory default is 4mA at bottom and 20mA at top, as this configuration scenario is an industry standard. *When connecting your sensor to a display, you must account for your output orientation setting.*

- **4mA at Bottom** - The output current will be 4mA when the sensor measures an empty tank and 20mA when the sensor measures a full tank.
- **20mA at Bottom** - The output current will be 20mA when the sensor measures an empty tank and 4mA when the sensor measures a full tank. **Note:** Right click on any item to open the help menu.

Note: Right click on any item to open the help menu.

Note: To reset the configuration table, press the Clear Screen button

SENSOR CONFIGURATION (CONTINUED)

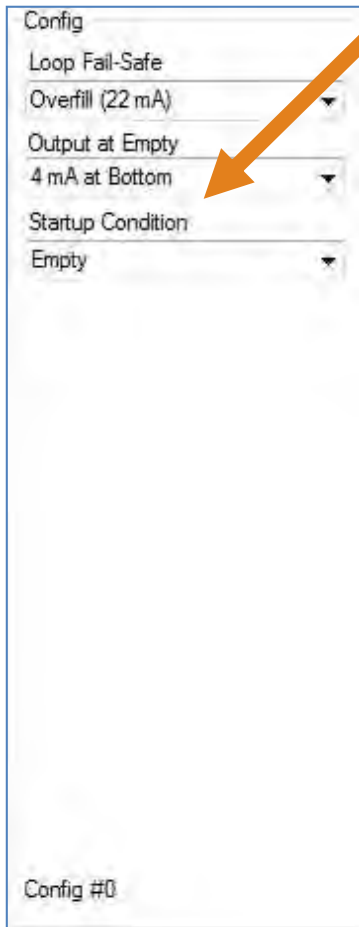

Config

Loop Fail-Safe

Overfill (22 mA)

Output at Empty

4 mA at Bottom

Startup Condition

Empty

Config #0

STARTUP CONDITION

This feature allows you to select the startup current when power is first applied to the sensor. The sensor will consume the selected power while it is acquiring the liquid level. When the correct level has been identified, the output will adjust to the level output. Use this feature to avoid false alarms with the controller when power is first applied to the sensor.

- **Empty** - The current output will revert to the selected current value for an empty condition.
 - **4 mA at Bottom** - The sensor will output 4 mA while the sensor powers up.
 - **20 mA at Bottom** - The sensor will output 20 mA while the sensor powers up.
- **Mid Tank (12 mA)** – The sensor will output 12 mA while the sensor powers up.
- **Full** - The output will revert to the selected current value for a full condition.
 - **4 mA at Bottom** - The sensor will output 20 mA while powering up.
 - **20 mA at Bottom** - The sensor will output 4 mA while the sensor powers up.
- **Overflow (22mA)** - The sensor will output 22mA while the sensor powers up.

Note: Right click on any item to open the help menu.

Note: To reset the configuration table, press the Clear Screen button

VOLUMETRIC CONFIGURATION

The sensor may be configured in volumetric units (Gallons or Liters) or Distance (Height of Liquid) units (inches, cm, feet or meters). WebCal® will default to Distance (Height of Liquid) with units of Inches. To change units or change from Distance to Volume, press the Volumetric Mode button as located near the center of the window.

Distance (Height of Liquid): When this is selected, the sensor will always output a linear output proportional to the height of liquid (regardless of the tank shape). In the two drawings below, the Sensor High is set to 64" and Fill-Height is set to 60". If the tank is empty, the sensor will output 4mA. If the level is at 30", then the sensor will output 12mA. Either tank can be configured with a display from 0" to 60" and the sensor will always output the height of liquid.

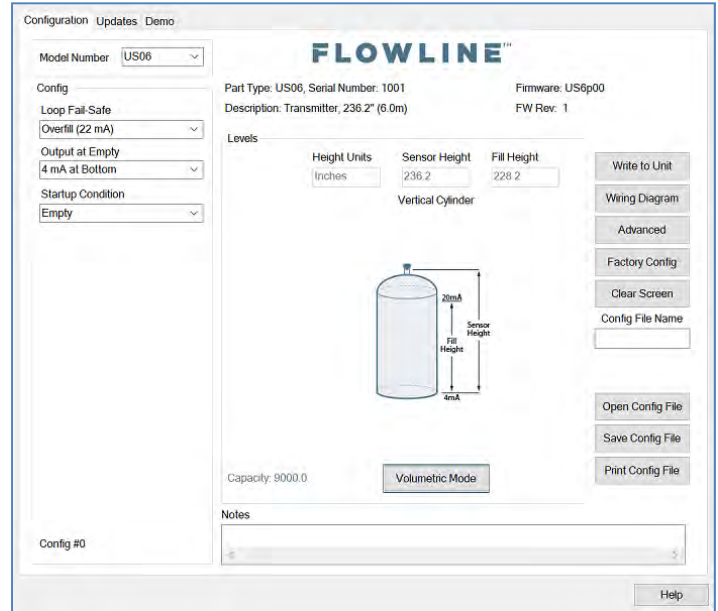

Volume: When volume is selected, the 4-20 mA output from the sensor will be proportional to the volume of the tank, not the height of the tank. This means that the current output will track the volume of the tank (in gallons or liters). Depending on the shape of the tank, the values may be a linear or non-linear scale. In the same examples below, the sensors are also configured with SH = 64" and FH = 60". The current output in a linear tank will act as expected with volume increase matching equal changes to level. However, the current output in the Non-Linear tank will reflect the actual changes in volume. So even though the liquid height changes incrementally the same amount, the volume change will adjust throughout the entire span of the tank. The advantage of this is that sensor does all the math so you can read tank volume using a simple two-point display/controller such as the DataLoop™ LI25 series or DataView™ LI55 series.

Linear Tank Example

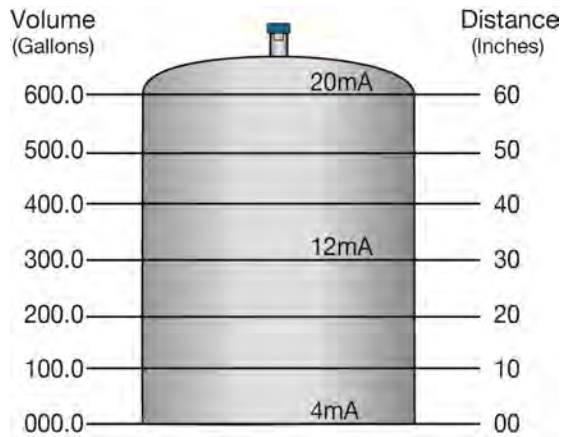

Note: In the above illustration, 10" of liquid will always be equal to 100 gallons of liquid (1" = 10 gallons).

Non-Linear Tank Example

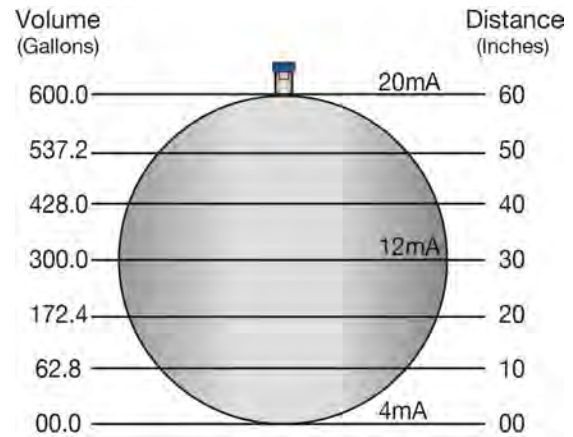

Note: In the above illustration, 1" of liquid does not equal 10 gallons. The 10" at the bottom represents a rise of 62.8 gallons. As a change between 10" and 20" represents an increase of 109.6 gallons (i.e. 172.4 gallons – 62.8 gallons).

Shape Selection Window: This window will show the different tank shape options available in WebCal®.

- **Vertical Cylinder**
- **Vertical Cylinder with Cone Bottom**
- **Horizontal Cylinder with End caps**
- **Horizontal Cylinder with Spherical Ends**
- **Spherical**
- **Rectangular**
- **Strapping Table** – Use this feature for manual entry of measured tank distances and volumes.

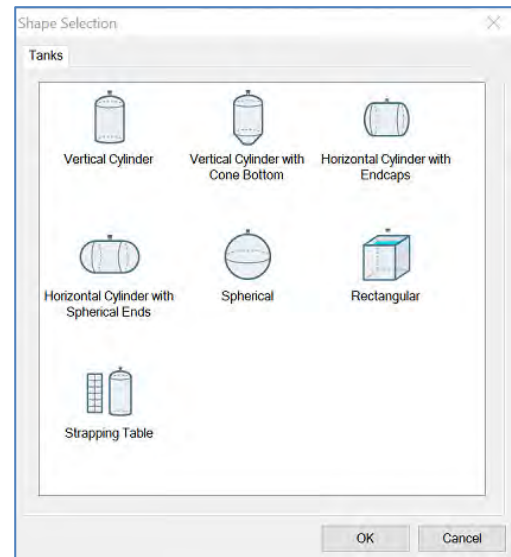

Select any of the above tank shapes and press OK to confirm.

A. Dimensional Entry – Vertical Cylinder Example: Choose the Sensor Output Units as Distance or Volume. After choosing the Sensor Output Units, select the units of measurement in the pull down to the left.

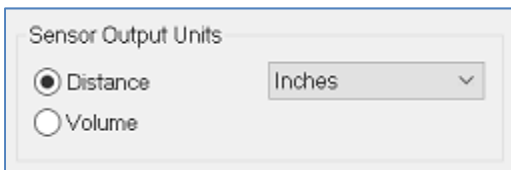

Units of Measurement	
Distance	Volume
Inches	Gallons Liters
Cm	
Feet	
Meters	

Distance – Sensor Output Units (Vertical Cylinder Example):

Enter the dimensions of the tank. You must enter data in all fields shown.

Sensor Height: Distance from the bottom of the tank to the bottom of the sensor.

Fill Height: Distance from the bottom of the tank to the operational full level of liquid (20mA). This setting defines the location of full current output and is the top of the sensor’s measurement range.

Riser Height: Distance the sensor is above the top of the tank (including all fittings). Measured from the bottom of the sensor.

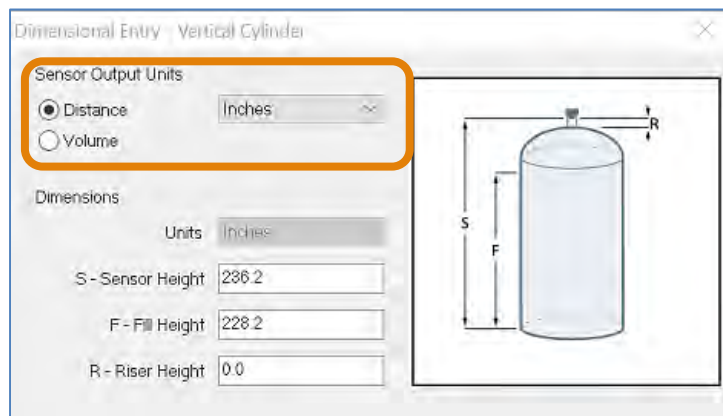

Volume – Sensor Output Units (Vertical Cylinder Example):

Enter the dimensions of the tank. You must enter data in all fields shown.

Sensor Height: Distance from the bottom of the tank to the bottom of the sensor.

Fill Height: Distance from the bottom of the tank to the operational full level of liquid (20mA). This setting defines the location of full current output and is the top of the sensor’s measurement range.

Riser Height: Distance the sensor is above the top of the tank (including all fittings). Measured from the bottom of the sensor.

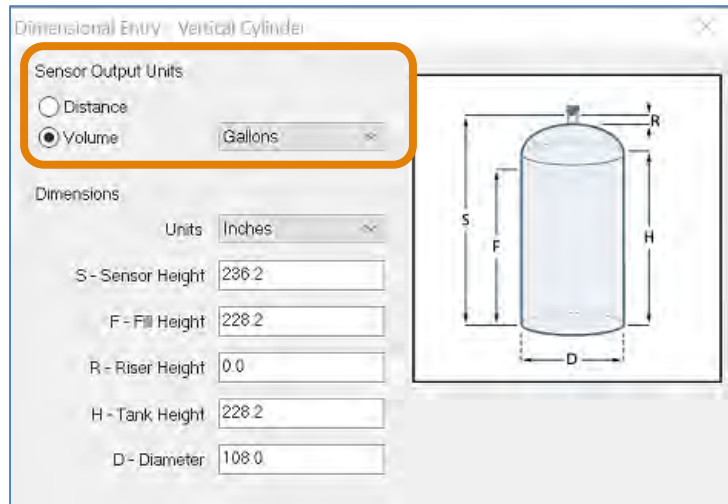

Tank Height: Distance from the bottom of the tank to the top of the straight side wall.

Diameter: Distance of the inside tank diameter.

Volume – Tank Capacity (Vertical Cylinder Example): After entering the dimensions, press the Capacity button to show the Calculated Capacity of the tank. If the Calculated Capacity is slightly different than the expected capacity, click on the Adjust Capacity box and enter the expected capacity of the tank. If the Adjusted Capacity is more than 10% of the Calculated Capacity, recheck the dimensions information entered above.

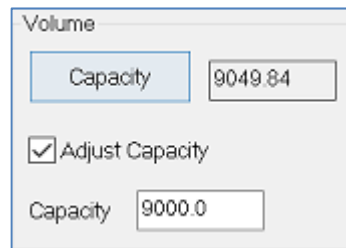
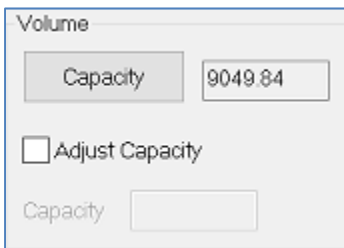

When all dimensions are entered, press the Apply button to return to the previous Configuration window.

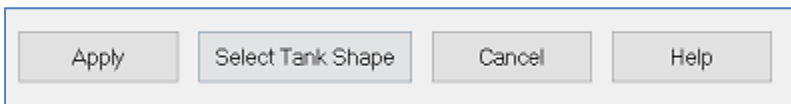

- **Apply** – Transfers the dimensions to the original Configuration window.
- **Tanks** – Returns to the previous Shape Selection window.
- **Cancel** – Returns to the Configuration window without saving any information.
- **Help** – Jumps to the Help menu.

TANK LEVEL CONFIRMATION:

This section of WebCal® is where you confirm the values set in the previous step. The values were entered under the Dimensional entry window. To edit these settings, you must go back to the Dimensional entry window via the Volumetric Mode button.

- **Height Units:** Units selected for configuration. When used as a device to measure the distance (height of liquid), the options are inches, cm, feet or m. When used as a device to measure the volume of liquid, the options are gallons or liters.
- **Sensor Height:** Distance from the bottom of the tank to the bottom of the sensor.
- **Fill-Height:** Distance from the bottom of the tank to the operational full level of liquid (20mA). This setting defines the location of full current output and is the top of the sensor’s measurement range.
- **Capacity:** The total volume of the tank. Only shown when gallons or liters are selected.

Note: By extending the empty (4mA) to the bottom of the tank, the 4-20 mA output will track the volume of the tank. This allows any local display to read the actual volume of liquid without the need for any unique configuration. This feature is very useful with any non-linear tanks such as horizontal, spherical or tanks with cone bottoms.

The screenshot displays the 'Levels' configuration window. At the top, there are three input fields: 'Height Units' set to 'Inches', 'Sensor Height' set to '236.2', and 'Fill Height' set to '228.2'. Below these is a dropdown menu set to 'Vertical Cylinder'. In the center is a diagram of a vertical cylinder tank. The bottom of the tank is labeled '4mA', the top of the liquid level is labeled '20mA', and the distance between them is labeled 'Fill Height'. Below the tank diagram is a 'Volumetric Mode' button, which is highlighted in blue. At the bottom left of the window, the 'Capacity' is set to '9000.0'. A callout box on the right states: 'Volumetric Sensor Output: The volumetric mode button will be highlighted in Blue when a volume output is selected.'

WRITE TO UNIT

After you have entered configurations, selected and configured the Tank Shape and entered the Tank Values, click **“Write to Unit”** and load the configuration into the memory of the sensor. When completed, this configuration will remain inside the sensor memory and will not change unless the sensor is connected to WebCal® and a new configuration is written to the sensor. Loss of power will not change or lose the configuration within sensor memory.

Next, use the file management features to save your configuration by clicking **“Save Config File”** and print your wiring diagram by clicking **“Wiring Diagram.”**

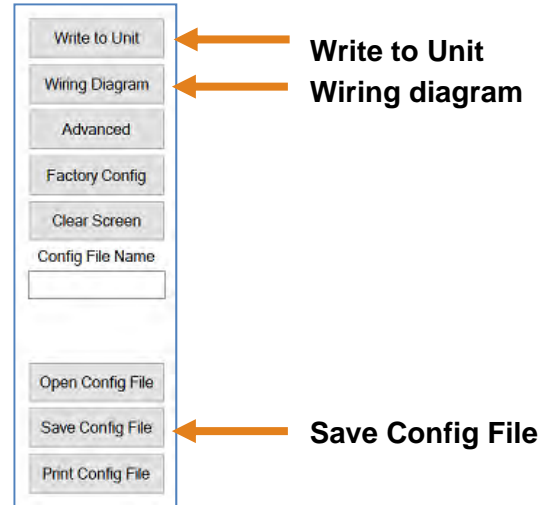

“Save Config File” will save this configuration as a text file which can be loaded back into WebCal® by pressing the **“Open Config File”** button. It is good practice to save the configuration file for each different configuration with a unique name for easy identification. If using multiple sensors in identical applications, then use of a single configuration file is recommended.

“Wiring Diagram” will display a PDF file showing the unique wiring for the specific configuration created in WebCal™. The PDF can be printed or emailed. It is good practice to save the wiring diagram as a backup.

“Advanced” is a feature setting designed to help solve performance or operational issues for specific applications. Changing these setting will alter the factory default performance or operation, of your sensor.

- **Increase Output Filtering:** Placing a check mark in the box will increase the filtering (averaging) of the analog output. Use this filter if the 4 to 20 mA output requires a smoother output for the application such as open channel flow measurement.
- **Decrease Output Filtering:** Placing a check mark in the box will eliminate all filtering (averaging) of the analog output which enables a pulse by pulse level reading. Use this filter to see changes in level after every echo pulse.



Note: Never check increase output filtering and decrease output filtering at the same time.

- **Stabilize Output in Dead Band:** Placing a check mark in the box will activate a filter to hold the output at Full if the level enters the dead band of the EchoPod®. This filter requires the level to leave the dead band at a smooth and steady rate.
- **Reduce Fast Level Jump Response Time:** Changes the sensor’s response time from 60 seconds to 10 seconds. This filter prevents the sensor from making a quick jump in level if a false signal suddenly appears. Change the response time if application involves expected quick level changes.
- **Increase LOST Response Time:** Changes the sensor’s response time from 60 seconds to 180 seconds. This filter sets the time the sensor waits before entering a LOST state. Change the response time if you want to delay the sensor from stating LOST.

AIR GAP VS. LIQUID LEVEL (HOW TO SELECT THE DISPLAY SETTING)

The display can be made to display either the height of liquid in the tank (**LIQUID** mode) or the amount of air in the tank (**AIR** mode). This function does not influence the current output, just the display on the sensor.

1. In TOP-LEVEL MENU mode, select **DISPLAY**.
2. Select **LIQUID** or **AIR**.
 - a. Press and hold OK on the selected setting for 3 seconds then release.
 - b. To cancel **DISPLAY**, Select **EXIT**.
3. Select **EXIT** to return to TOP-LEVEL MENU.

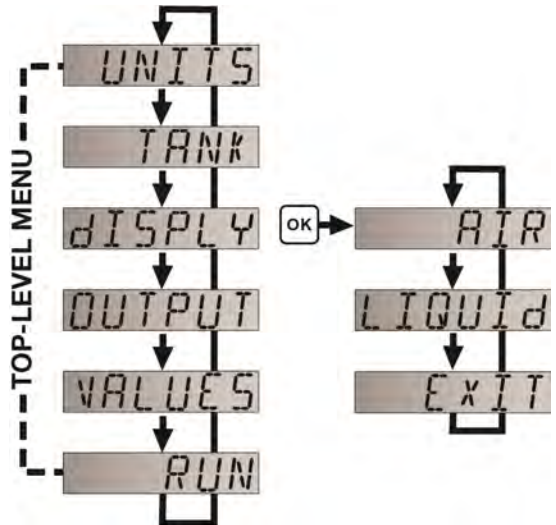
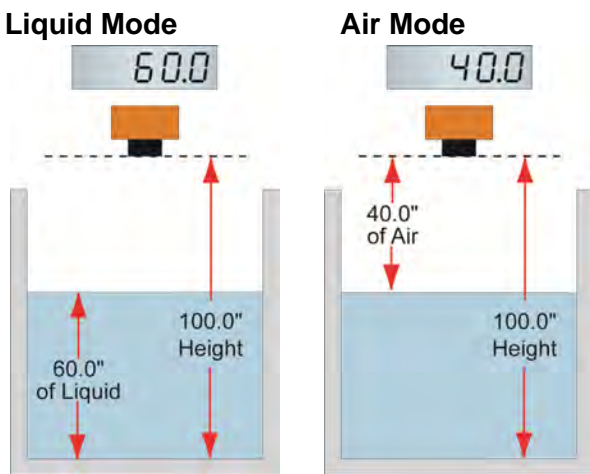

HOW TO REVERSE THE CURRENT OUTPUT

The factory setting for Echotouch® has 4mA set at the bottom of the tank and 20mA at the top. If the application requires this output to be reversed (20mA at bottom and 4mA at top), then use the REV MA setting to reverse the current output.

- With **REV MA** set to **NORM** (factory default), 4mA will be at the bottom and 20 mA at the top of the tank.
- With **REV MA** set to **REV**, 20mA will be at the bottom and 4mA at the top of the tank.

1. In TOP-LEVEL MENU mode, select **OUTPUT**.
2. Select **REV MA**.
3. Select **4 BOTT** or **4 TOP**.
 - a. Press and hold OK on the selected setting for 3 seconds then release.
 - a. To cancel **REV MA**, Select **EXIT**.
4. Select **EXIT** to return to TOP-LEVEL MENU.

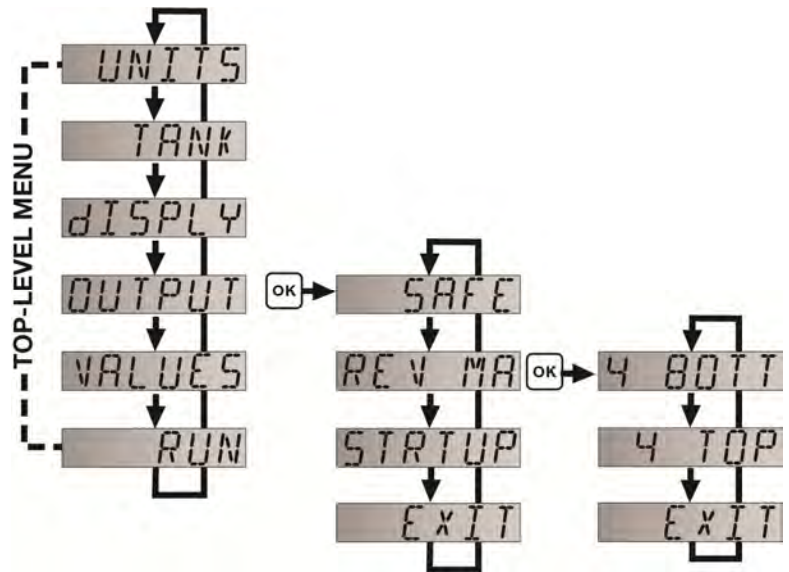
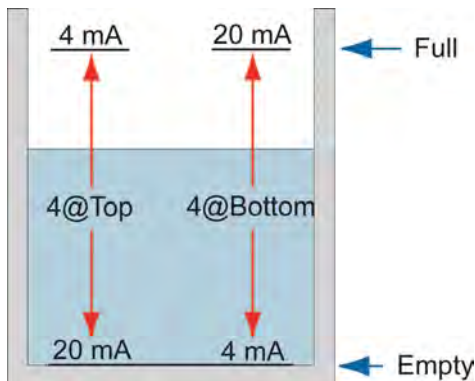

HOW TO SETUP THE START-UP POWER (STRTUP):

During the window of time between when power is first applied to the sensor and the sensor acquires the level reading, the output current can be preset in order to avoid any false alarms during this window. The options for start-up are 4mA, 12mA, 20mA or 22mA.

1. In TOP-LEVEL MENU mode, select **OUTPUT**.
2. Select **STRTUP**.
3. Select **4mA**, **12mA**, **20mA** or **22mA**.
 - a. Press and hold OK on the selected setting for 3 seconds then release.
 - a. To cancel **STRTUP**, Select **EXIT**.
4. Select **EXIT** to return to TOP-LEVEL MENU.

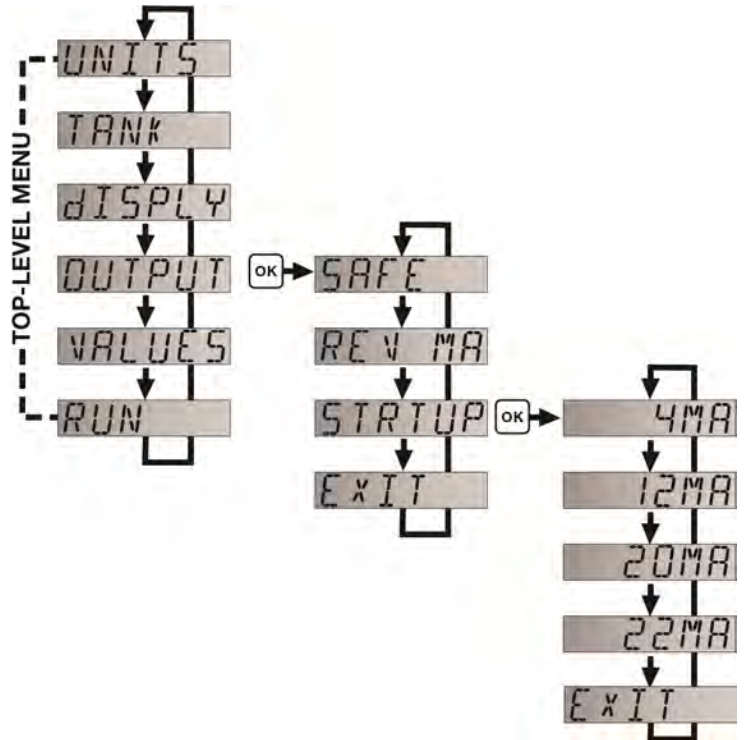
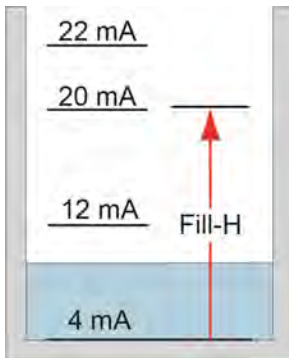

VALUES MENU

Functions include providing setup information (SETUP), a diagnostic to be used in conjunction with a Flowline Representative (DIAG) and the ability to reset the Echotouch® (RESET).

SETUP

Will display the configuration settings for EchoTouch®.

1. In TOP-LEVEL MENU mode, select **VALUES**.
2. Select **SETUP**.
3. Setup will list the following information:
 - a. **UNITS**,
 - b. **DISPLY**,
 - c. **REV MA**,
 - d. **SAFE**,
 - e. **HEIGHT**,
 - f. **FILL-H**
 - g. **START UP**
4. Select **EXIT** to return to TOP-LEVEL MENU.

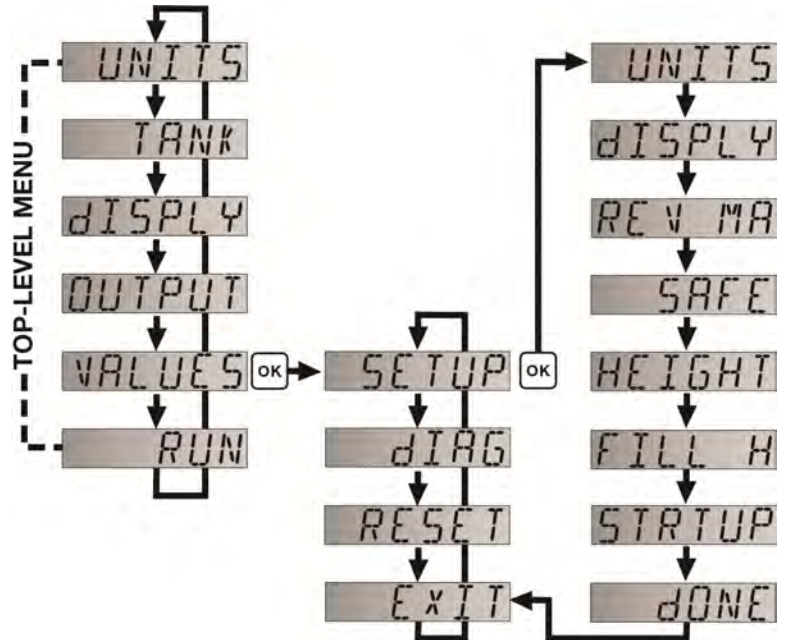

DIAGNOSTIC (DIAG) PARAMETERS

This mode runs diagnostic tests that confirm operation of EchoTouch®. This is a production test feature used by the factory to confirm operation.

1. In TOP-LEVEL MENU, select **VALUES**.
2. Select **DIAG**.
3. DIAG will list the following settings:
 - a. **Display Test**
 - b. **RANGE**
 - c. **TEMP**
 - d. **ECHO**
 - e. **POWER**
 - f. **VER**
4. Select **EXIT** to return to TOP-LEVEL MENU.

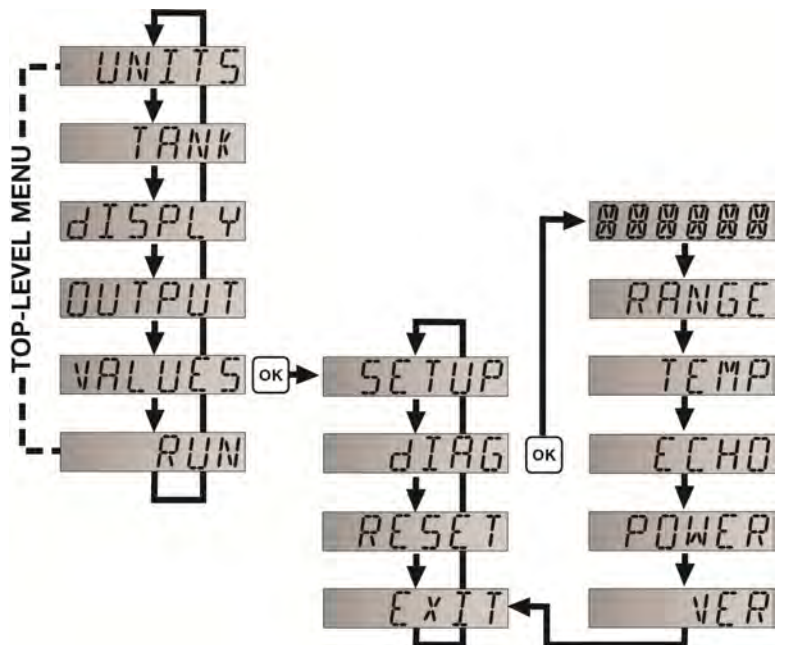

Note: This mode should only be used when supervised by a Flowline representative.

RESET

EchoTouch® enables the end user to reset the entire configuration back to the original factory settings.

2. In TOP-LEVEL MENU mode, select **VALUES**.
3. Select **RESET**.
4. Select **YES**.
 - a. To cancel the reset, Select **NO**.
5. Select **EXIT** to return to TOP-LEVEL MENU.

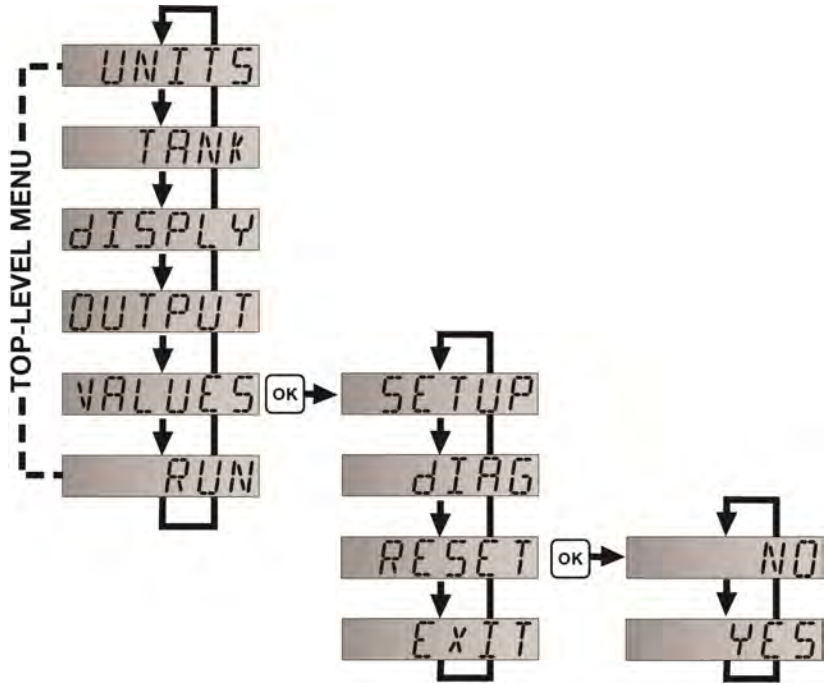

FACTORY SETTINGS

Echotouch®	Sensor Height	Fill-Height	Loop Fail-Safe	Output @ Empty	Startup Condition
US12 Series	472.4" (1200 cm)	454.4" (1154.3 cm)	Hold last	4mA at Bottom	Empty
US06 Series	236.2" (600 cm)	228.2" (579.7 cm)			
US03 Series	118.1" (300 cm)	114.1" (290 cm)			
US01 Series	59.1" (150 cm)	57.6" (146.2 cm)			

USER SETTINGS

Fill out the chart below and keep as a record of your configuration.

Tank

Height =	Fill-H =
----------	----------

Units

Inches	Feet	cm	Meter
--------	------	----	-------

Display

Air	Liquid
-----	--------

Safe

22mA	21 mA	20mA	Hold Last	4mA
------	-------	------	-----------	-----

Rev mA

4mA @ Bottom	4mA at Top
--------------	------------

Start-up

4mA	12mA	20mA	22mA
-----	------	------	------

TROUBLESHOOTING

PROBLEM	SOLUTION
No Unit Detected in WebCal®.	If WebCal® cannot detect EchoTouch® when connected to the computer: <ul style="list-style-type: none"> • Check that the LI99-2001 Fob is connected to the USB® port. • Check that all four wires (Red, Black, White and Green) are securely attached to the Fob. • Check Device Manager and confirm that both drivers (WebCal® Configuration & EchoFob) are present. • If the above do not work, reinstall the WebCal® software while the computer is in Safe Mode.
Display shows FULL :	Level of liquid is above the FILL-H setting: Check the FILL-H setting, making sure the FILL-H setting is high enough so the level of liquid is below the FILL-H setting. The Fill-H setting is the distance from the bottom of the tank to the Full level of liquid.

TROUBLESHOOTING

PROBLEM	SOLUTION
Display shows EMPTY :	Level of liquid is beyond the HEIGHT setting: Check the HEIGHT setting, making sure the HEIGHT setting is low enough so the level of liquid is above the HEIGHT setting.
Display shows LOST :	Sensor is in a Fail-Safe state. The return sound pulses are not reaching the transducer. First, cycle power off and on, waiting 10 seconds between the off and on states. If problem persists, check the installation fitting against the Installation instructions in the manual.
Display shows WARMUP :	WARMUP appears when power is being applied to transmitter and the sensor cannot acquire a valid return signal. This is similar to LOST state. Make sure the liquid level is within the operational range configured within the transmitter (i.e. Level is not further than HEIGHT setting and not above the FILL-H setting). If problem persists, check the installation fitting against the Installation instructions in the manual as well as check for a weak power supply or bad wire connections.
Display is opposite of the measured value:	Check the DISPLAY setting. AIR mode indicates the distance from the liquid to the sensor. LIQUID mode indicates the height of liquid in the tank. Change the DISPLAY mode from AIR to LIQUID or vice versa to correct.
Transmitter indicates a current of 0 mA:	Check the wiring for an open circuit. An open circuit is the most common issue with a 0 mA signal.
Transmitter jumps to a current reading between 19 and 20 mA:	Check the installation of the transmitter. Bad installation fittings will cause false signals near the top of the tank, which typically translates to a signal between 19 and 20 mA. Also look for interference just below the transmitter. If the transmitter is installed in a metal fitting, switch to a plastic fitting.
Transmitter indicates a current over 23 mA:	Immediately check the wiring for a short circuit. The Echotouch® is current limited to 22 mA. Anything above 23 mA indicates a short circuit.
No unit detected error 1	Both errors can occur when the Display is still plugged in when connecting to WebCal. Remove the display from its plug and try again.
Data page read error 2	
Data page read error X (X is any number greater than 2)	Make sure display is removed. If issue persists, contact a Flowline representative.
-1 No device is attached to the USB Fob, or it is attached incorrectly. Please correct and try again.	<ol style="list-style-type: none"> 1. Check the wires connected to the USB Fob as well as to the EchoPod terminals. 2. Make sure the cable length between the sensor and the computer is less than 15' of total cable. 3. Make sure the display was removed from its plug. 4. If this persists, reboot computer in SAFE mode and re-install the WebCal® installer program.
-2 Program to loader error open wires	Check the wires connected to the USB Fob as well as to the EchoPod terminals.

WARRANTY

Flowline warrants to the original purchaser of its products that such products will be free from defects in material and workmanship under normal use and service in accordance with instructions furnished by Flowline for a period of two years from the date of manufacture of such products. Flowline's obligation under this warranty is solely and exclusively limited to the repair or replacement, at Flowline's option, of the products or components, which Flowline's examination determines to its satisfaction to be defective in material or workmanship within the warranty period. Flowline must be notified pursuant to the instructions below of any claim under this warranty within thirty (30) days of any claimed lack of conformity of the product. Any product repaired under this warranty will be warranted only for the remainder of the original warranty period. Any product provided as a replacement under this warranty will be warranted for the full two years from the date of manufacture.

RETURNS

Products cannot be returned to Flowline without Flowline's prior authorization. To return a product that is thought to be defective, go to flowline.com, and submit a customer return (MRA) request form and follow the instructions therein. All warranty and non-warranty product returns to Flowline must be shipped prepaid and insured. Flowline will not be responsible for any products lost or damaged in shipment.

LIMITATIONS

This warranty does not apply to products which: 1) are beyond the warranty period or are products for which the original purchaser does not follow the warranty procedures outlined above; 2) have been subjected to electrical, mechanical or chemical damage due to improper, accidental or negligent use; 3) have been modified or altered; 4) anyone other than service personnel authorized by Flowline have attempted to repair; 5) have been involved in accidents or natural disasters; or 6) are damaged during return shipment to Flowline. Flowline reserves the right to unilaterally waive this warranty and dispose of any product returned to Flowline where: 1) there is evidence of a potentially hazardous material present with the product; or 2) the product has remained unclaimed at Flowline for more than 30 days after Flowline has dutifully requested disposition. This warranty contains the sole express warranty made by Flowline in connection with its products. **ALL IMPLIED WARRANTIES, INCLUDING WITHOUT LIMITATION, THE WARRANTIES OF MERCHANTABILITY AND FITNESS FOR A PARTICULAR PURPOSE, ARE EXPRESSLY DISCLAIMED.** The remedies of repair or replacement as stated above are the exclusive remedies for the breach of this warranty. **IN NO EVENT SHALL FLOWLINE BE LIABLE FOR ANY INCIDENTAL OR CONSEQUENTIAL DAMAGES OF ANY KIND INCLUDING PERSONAL OR REAL PROPERTY OR FOR INJURY TO ANY PERSON. THIS WARRANTY CONSTITUTES THE FINAL, COMPLETE AND EXCLUSIVE STATEMENT OF WARRANTY TERMS AND NO PERSON IS AUTHORIZED TO MAKE ANY OTHER WARRANTIES OR REPRESENTATIONS ON BEHALF OF FLOWLINE.** This warranty will be interpreted pursuant to the laws of the State of California. If any portion of this warranty is held to be invalid or unenforceable for any reason, such finding will not invalidate any other provision of this warranty.

For complete product documentation, video training, and technical support, go to flowline.com. For phone support, call 562-598-3015 from 8am to 5pm PST, Mon - Fri. (Please make sure you have the Part and Serial number available.)