

Operating Instructions

Cerabar M, Deltapilot M

Pressure / hydrostatics
IO-Link



Cerabar M



Deltapilot M





A0023555

- Make sure the document is stored in a safe place such that it is always available when working on or with the device.
- To avoid danger to individuals or the facility, read the "Basic safety instructions" section carefully, as well as all other safety instructions in the document that are specific to working procedures.
- The manufacturer reserves the right to modify technical data without prior notice. Your Endress+Hauser distributor will supply you with current information and updates to this manual.

Table of contents

1	About this document	5	6.7	Resetting to factory settings (reset)	40
1.1	Document function	5	7	System integration	41
1.2	Symbols used	5	7.1	Process data	41
1.3	List of abbreviations	7	7.2	Reading out and writing device data (ISDU – Indexed Service Data Unit)	42
1.4	Turn down calculation	7	8	Commissioning	50
1.5	Registered trademarks	8	8.1	Function check	50
2	Basic safety instructions	9	8.2	Unlocking/locking configuration	50
2.1	Requirements for personnel	9	8.3	Commissioning without an operating menu ..	51
2.2	Designated use	9	8.4	Commissioning with an operating menu	53
2.3	Workplace safety	9	8.5	Configuring level measurement	55
2.4	Operational safety	9	8.6	Configuring pressure measurement	59
2.5	Product safety	10	8.7	Backing up or duplicating the device data	61
3	Incoming acceptance and product identification	11	9	Maintenance	62
3.1	Incoming acceptance	11	9.1	Information on cleaning	62
3.2	Product identification	11	9.2	Exterior cleaning	62
3.3	Identification of the measuring cell type	12	10	Diagnostics and troubleshooting ...	63
3.4	Storage and transport	12	10.1	Diagnostic events	63
3.5	Scope of delivery	12	10.2	Behavior of the current output in the event of an error	66
4	Installation	13	10.3	Locking/unlocking operation	66
4.1	Mounting requirements	13	10.4	Resetting to factory settings (reset)	67
4.2	Mounting measuring cell modules with PVDF thread	13	10.5	Software history	67
4.3	Installing the Cerabar M	14	11	Repair	69
4.4	Installing the Deltapilot M	24	11.1	General information	69
4.5	Mounting of the profile seal for universal process adapter	27	11.2	Spare parts	69
4.6	Closing the housing cover	28	11.3	Return	70
4.7	Post-mounting check	28	11.4	Disposal	70
5	Electrical connection	29	12	Overview of the operating menu	71
5.1	Connecting the device	29	13	Description of device parameters ...	73
5.2	Connecting the measuring unit	29	13.1	Expert → System	73
5.3	Terminals	30	13.2	Expert → System → Instrument info	73
5.4	Cable specification	30	13.3	Expert → System → Display	75
5.5	Load for current output	30	13.4	Expert → System → Management	75
5.6	Field Xpert SMT70, SMT77	30	13.5	Expert → Measurement	76
5.7	FieldPort SFP20	31	13.6	Expert → Measurement → Basic setup	76
5.8	Post-connection check	31	13.7	Expert → Measurement → Pressure	78
6	Operation	32	13.8	Expert → Measurement → Level	80
6.1	Operation methods	32	13.9	Expert → Measurement → Sensor limits	82
6.2	Operation without an operating menu	33	13.10	Expert → Measurement → Sensor trim	82
6.3	Operation with an operating menu	34	13.11	Expert → Output → Current output	83
6.4	Operation with device display (optional)	35	13.12	Expert → Communication	86
6.5	Operation using Endress+Hauser operating program	39	13.13	Expert → Diagnosis	86
6.6	Locking/unlocking operation	39	13.14	Expert → Diagnosis → Diagnostic list	87

13.15	Expert → Diagnosis → Event logbook	88
13.16	Expert → Diagnosis → Simulation	88
13.17	Backing up or duplicating the device data	89
14	Technical data	91
14.1	Pressure specifications	91
14.2	Additional technical data	91
Index	92





1 About this document

1.1 Document function



These Operating Instructions contain all the information that is required in various phases of the life cycle of the device: from product identification, incoming acceptance and storage, to mounting, connection, operation and commissioning through to troubleshooting, maintenance and disposal.

1.2 Symbols used



1.2.1 Safety symbols

Symbol	Meaning
	DANGER! This symbol alerts you to a dangerous situation. Failure to avoid this situation will result in serious or fatal injury.
	WARNING! This symbol alerts you to a dangerous situation. Failure to avoid this situation can result in serious or fatal injury.
	CAUTION! This symbol alerts you to a dangerous situation. Failure to avoid this situation can result in minor or medium injury.
	NOTICE! This symbol contains information on procedures and other facts which do not result in personal injury.



1.2.2 Electrical symbols



Symbol	Meaning	Symbol	Meaning
	Protective ground connection A terminal which must be connected to ground prior to establishing any other connections.		Ground connection A grounded terminal which, as far as the operator is concerned, is grounded via a grounding system.

1.2.3 Tool symbols

Symbol	Meaning
	Allen key
	Open-ended wrench

1.2.4 Symbols for certain types of information

Symbol	Meaning
	Permitted Procedures, processes or actions that are permitted.
	Forbidden Procedures, processes or actions that are forbidden.

Symbol	Meaning
	Tip Indicates additional information.
	Visual inspection

1.2.5 Symbols in graphics

Symbol	Meaning
1, 2, 3 ...	Item numbers
1., 2., 3. ...	Series of steps
A, B, C, ...	Views
A-A, B-B, C-C, ...	Sections

1.2.6 Symbols at the device

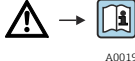
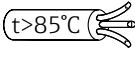
Symbol	Meaning
 A0019159	Safety instructions Observe the safety instructions contained in the associated Operating Instructions.
 A0029423	Connecting cable immunity to temperature change Indicates that the connecting cables have to withstand a temperature of 85°C at least.

1.3 List of abbreviations

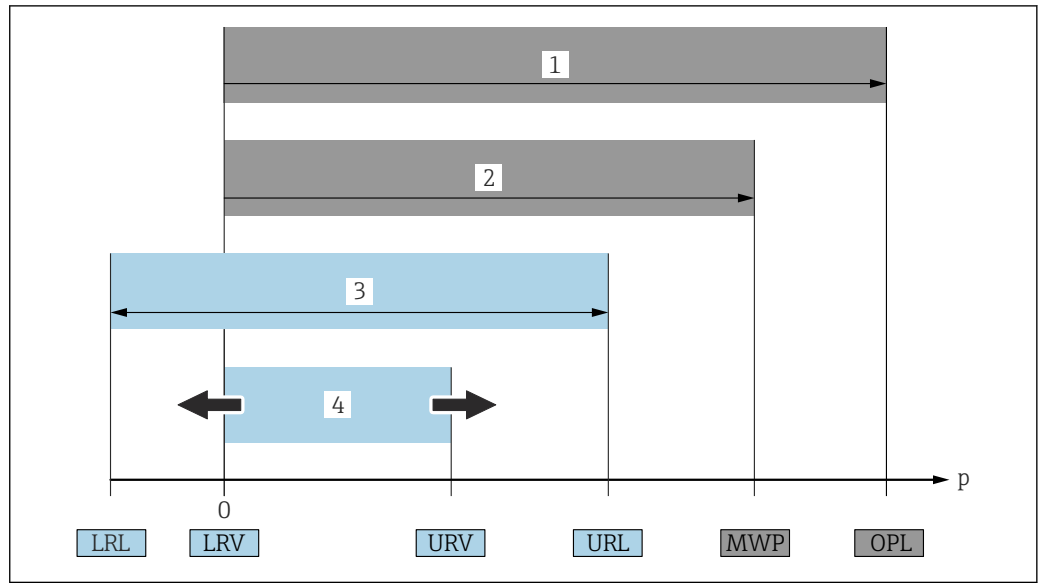

- 1 OPL: The OPL (overpressure limit = measuring cell overload limit) for the device depends on the lowest-rated element, with regard to pressure, of the selected components, i.e. the process connection has to be taken into consideration in addition to the measuring cell. Observe pressure-temperature dependency.
 - 2 MWP: The MWP (maximum working pressure) for the measuring cells depends on the lowest-rated element, with regard to pressure, of the selected components, i.e. the process connection has to be taken into consideration in addition to the measuring cell. Observe pressure-temperature dependency. The MWP may be applied at the device for an unlimited period of time. The MWP can be found on the nameplate.
 - 3 The maximum measuring range corresponds to the span between the LRL and URL. This measuring range is equivalent to the maximum calibratable/adjustable span.
 - 4 The calibrated/adjusted span corresponds to the span between the LRV and URV. Factory setting: 0 to URL. Other calibrated spans can be ordered as customized spans.
- p Pressure
 LRL Lower range limit
 URL Upper range limit
 LRV Lower range value
 URV Upper range value
 TD Turn down. Example - see the following section.

1.4 Turn down calculation

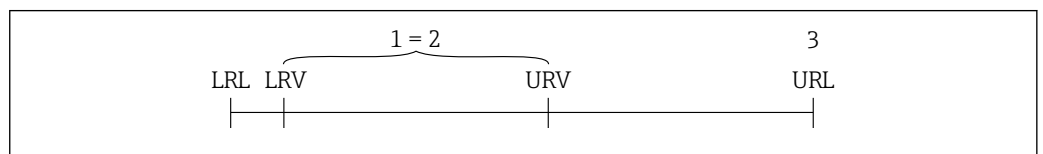

- 1 Calibrated/adjusted span
- 2 Zero point-based span
- 3 Upper range limit

Example:

- Measuring cell: 10 bar (150 psi)
- Upper range limit (URL) = 10 bar (150 psi)
- Calibrated/adjusted span: 0 to 5 bar (0 to 75 psi)
- Lower range value (LRV) = 0 bar (0 psi)
- Upper range value (URV) = 5 bar (75 psi)

$$TD = \frac{URL}{|URV - LRV|}$$

In this example, the TD is 2:1. This span is based on the zero point.

1.5 Registered trademarks

- KALREZ®
Registered label of E.I. Du Pont de Nemours & Co., Wilmington, USA
- TRI-CLAMP®
Registered label of Ladish & Co., Inc., Kenosha, USA
-  **IO-Link**
Registered trademark of the IO-Link Community.
- GORE-TEX® trademark of W.L. Gore & Associates, Inc., USA

2 Basic safety instructions

2.1 Requirements for personnel

The personnel for installation, commissioning, diagnostics and maintenance must meet the following requirements:

- ▶ Trained, qualified specialists must have a relevant qualification for this specific function and task
- ▶ Are authorized by the plant owner/operator
- ▶ Are familiar with federal/national regulations
- ▶ Before starting work, read and understand the instructions in the manual and supplementary documentation as well as the certificates (depending on the application)
- ▶ Follow instructions and comply with basic conditions

The operating personnel must meet the following requirements:

- ▶ Operating personnel are instructed and authorized according to the requirements of the task by the facility's owner-operator
- ▶ Follow the instructions in this manual

2.2 Designated use

The Cerabar M is a pressure transmitter for measuring level and pressure.

The Deltapilot M is a hydrostatic pressure sensor for measuring level and pressure.

2.2.1 Incorrect use

The manufacturer is not liable for damage caused by improper or non-designated use.

Verification for borderline cases:

- ▶ For special fluids and fluids for cleaning, Endress+Hauser is glad to provide assistance in verifying the corrosion resistance of fluid-wetted materials, but does not accept any warranty or liability.

2.3 Workplace safety

For work on and with the device:

- ▶ Wear the required personal protective equipment according to federal/national regulations.
- ▶ Switch off the supply voltage before connecting the device.

2.4 Operational safety

Risk of injury!

- ▶ Operate the device in proper technical condition and fail-safe condition only.
- ▶ The operator is responsible for interference-free operation of the device.

Conversions to the device

Unauthorized modifications to the device are not permitted and can lead to unforeseeable dangers:

- ▶ If, despite this, modifications are required, consult with Endress+Hauser.

Repair

To ensure continued operational safety and reliability:

- ▶ Carry out repairs on the device only if they are expressly permitted.
- ▶ Observe federal/national regulations pertaining to repair of an electrical device.

- ▶ Use original spare parts and accessories from Endress+Hauser only.

Hazardous area

To eliminate a danger for persons or for the facility when the device is used in the hazardous area (e.g. explosion protection, pressure vessel safety):

- ▶ Based on the nameplate, check whether the ordered device is permitted for the intended use in the hazardous area.
- ▶ Observe the specifications in the separate supplementary documentation that is an integral part of these Instructions.

2.5 Product safety

This measuring device is designed in accordance with good engineering practice to meet state-of-the-art safety requirements, has been tested, and left the factory in a condition in which they are safe to operate.

It fulfills general safety requirements and legal requirements. It also conforms to the EC directives listed in the device-specific EC declaration of conformity. Endress+Hauser confirms this fact by applying the CE mark.

3 Incoming acceptance and product identification

3.1 Incoming acceptance

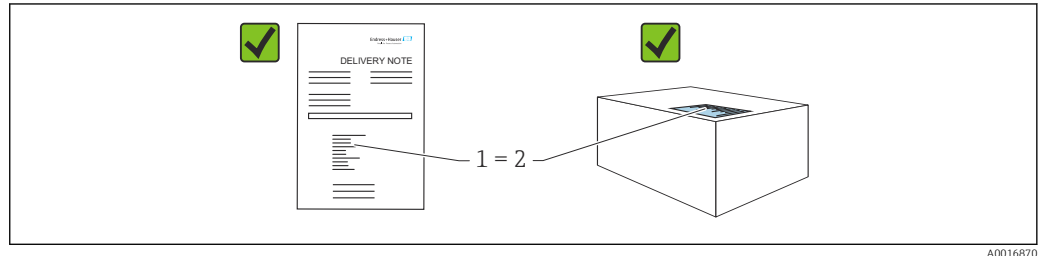

- Is the order code on the delivery note (1) identical to the order code on the product sticker (2)?
- Are the goods undamaged?
- Do the data on the nameplate correspond to the order specifications and the delivery note?
- Is the documentation available?
- If required (see nameplate): Are the safety instructions (XA) present?



If one of these conditions is not fulfilled, please contact your Endress+Hauser sales office.

3.2 Product identification

The following options are available to identify the measuring device:

- Nameplate specifications
- Order code with breakdown of the device features on the delivery note
- Enter the serial numbers from the nameplates in *W@M Device Viewer* (www.endress.com/deviceviewer): all the information about the measuring device is displayed.

For an overview of the technical documentation provided, enter the serial number from the nameplates in *W@M Device Viewer* (www.endress.com/deviceviewer)

3.2.1 Manufacturer address

Endress+Hauser SE+Co. KG
 Hauptstraße 1
 79689 Maulburg, Germany
 Place of manufacture: See nameplate.

3.2.2 Nameplates

Different nameplates are used depending on the device version.

The nameplates contain the following information:

- Manufacturer name and device name
- Address of the certificate holder and country of manufacture
- Order code and serial number
- Technical data
- Approval-specific information

Compare the data on the nameplate with your order.

3.2.3 Identification of the measuring cell type

In the case of gauge pressure measuring cells, the "Pos. zero adjust" parameter appears in the operating menu ("Setup" -> "Pos. zero adjust").

In the case of absolute pressure measuring cells, the "Calib. offset" parameter appears in the operating menu ("Setup" -> "Calib. offset").

3.3 Identification of the measuring cell type

In the case of gauge pressure measuring cells, the "Pos. zero adjust" parameter appears in the operating menu ("Setup" -> "Pos. zero adjust").

In the case of absolute pressure measuring cells, the "Calib. offset" parameter appears in the operating menu ("Setup" -> "Calib. offset").

3.4 Storage and transport

3.4.1 Storage conditions

Use original packaging.

Store the measuring device in clean and dry conditions and protect from damage caused by shocks (EN 837-2).

Storage temperature range



See the "Technical Information" document: www.endress.com → Download

3.4.2 Transporting the product to the measuring point

⚠ WARNING

Incorrect transport!

Housing and membrane may become damaged, and there is a risk of injury!

- ▶ Transport the measuring device to the measuring point in its original packaging or by the process connection.
- ▶ Follow the safety instructions and transport conditions for devices weighing more than 18 kg (39.6 lbs).
- ▶ Do not use capillaries as a carrying aid for the diaphragm seals.

3.5 Scope of delivery

The scope of delivery comprises:

- Device
- Optional accessories

Accompanying documentation:

- Brief Operating Instructions
- Final inspection report
- Additional Safety Instructions for devices with approvals (e.g. ATEX, IECEx, NEPSI, etc.)
- Optional: factory calibration certificate, inspection certificates



The Operating Instructions are available on the Internet at:

www.endress.com → Download

4 Installation

4.1 Mounting requirements

4.1.1 General installation instructions

- Devices with a G 1 1/2 thread:
When screwing the device into the tank, the flat seal has to be positioned on the sealing surface of the process connection. To avoid additional strain on the membrane, the thread should never be sealed with hemp or similar materials.
- Devices with NPT threads:
 - Wrap Teflon tape around the thread to seal it.
 - Tighten the device at the hexagonal bolt only. Do not turn at the housing.
 - Do not overtighten the thread when screwing. Max. tightening torque:
20 to 30 Nm (14.75 to 22.13 lbf ft)
- For the following process connections a tightening torque of max. 40 Nm (29.50 lbf ft) is required:
 - Thread ISO228 G1/2 (Order option "GRC" or "GRJ" or "GOJ")
 - Thread DIN13 M20 x 1.5 (Order option "G7J" or "G8J")

4.2 Mounting measuring cell modules with PVDF thread

⚠ WARNING

Risk of damage to process connection!

Risk of injury!

- ▶ Measuring cell modules with PVDF thread must be installed with the mounting bracket provided!

⚠ WARNING

Material fatigue from pressure and temperature!

Risk of injury if parts burst! The thread can become loose if exposed to high pressure and temperature loads.

- ▶ The integrity of the thread must be checked regularly. Also, the thread may need to be re-tightened with the maximum tightening torque of 7 Nm (5.16 lbf ft). Teflon tape is recommended for sealing the 1/2" NPT thread.

4.3 Installing the Cerabar M

- Due to the orientation of the Cerabar M, there may be a shift in the zero point, i.e. when the container is empty or partially full, the measured value does not display zero. You can correct this zero point shift → 34 "Funktion der Bedienelemente".
- The local display can be rotated in 90° stages.
- For PMP55, please refer to Section "Installation instructions for devices with diaphragm seals – PMP55" → 16.
- Endress+Hauser offers a mounting bracket for installing on pipes or walls. → 21, Section "Wall and pipe mounting (optional)".

4.3.1 Installation instructions for devices without diaphragm seals – PMP51, PMC51

NOTICE

Damage to the device!

If a heated device is cooled during a cleaning process (e.g. by cold water), a vacuum develops for a short time and, as a result, moisture can enter the measuring cell through the pressure compensation element (1).

- ▶ Mount the device as follows.

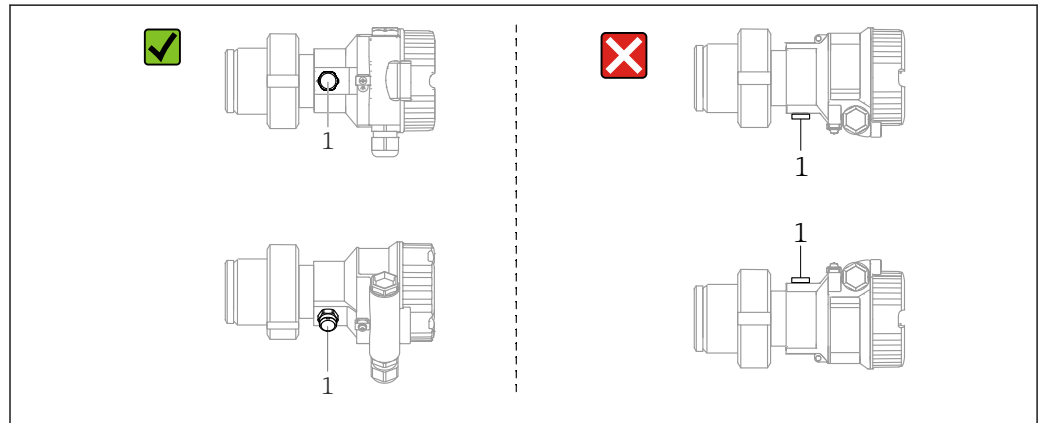

A0028471

- Keep the pressure compensation and GORE-TEX® filter (1) free from contamination.
- Cerabar M transmitters without diaphragm seals are mounted as per the norms for a manometer (DIN EN 837-2). We recommend the use of shutoff devices and water pocket pipes. The orientation depends on the measuring application.
- Do not clean or touch the membrane with hard or pointed objects.
- The device must be installed as follows in order to comply with the cleanability requirements of the ASME-BPE (Part SD Cleanability):

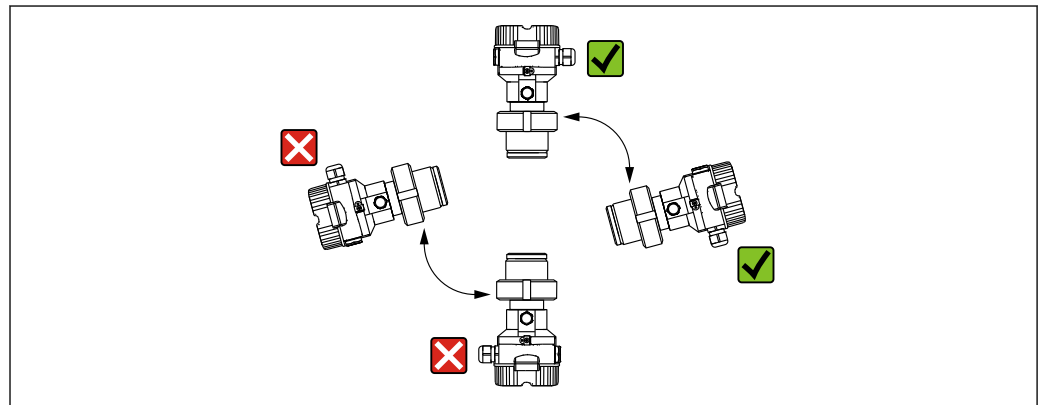

A0028472

Pressure measurement in gases

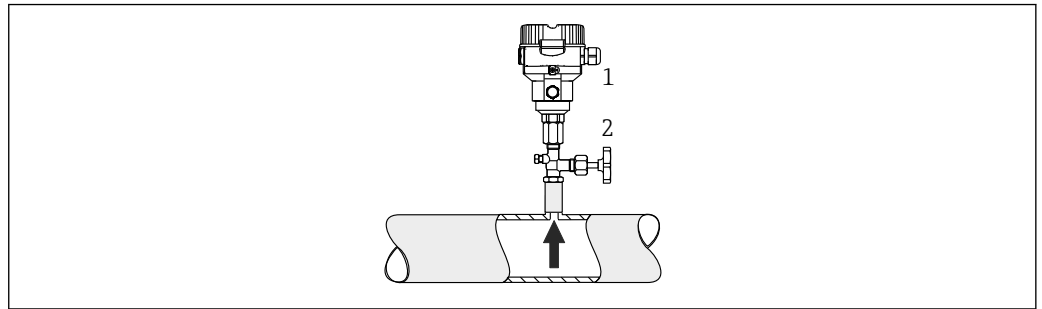

A0028473

- 1 Cerabar M
- 2 Shutoff device

Mount the Cerabar M with the shutoff device above the tapping point so that any condensate can flow into the process.

Pressure measurement in vapors

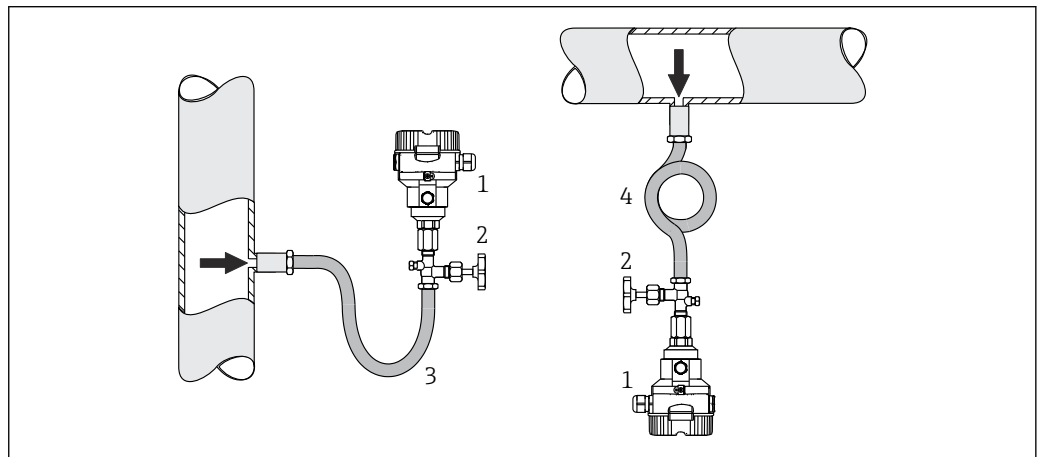

A0028474

- 1 Cerabar M
- 2 Shutoff device
- 3 U-shaped water pocket pipe
- 4 O-shaped water pocket pipe

- Mount the Cerabar M with the water pocket pipe below the tapping point.
- Fill the water pocket pipe with liquid before commissioning. The water pocket pipe reduces the temperature to almost ambient temperature.

Pressure measurement in liquids

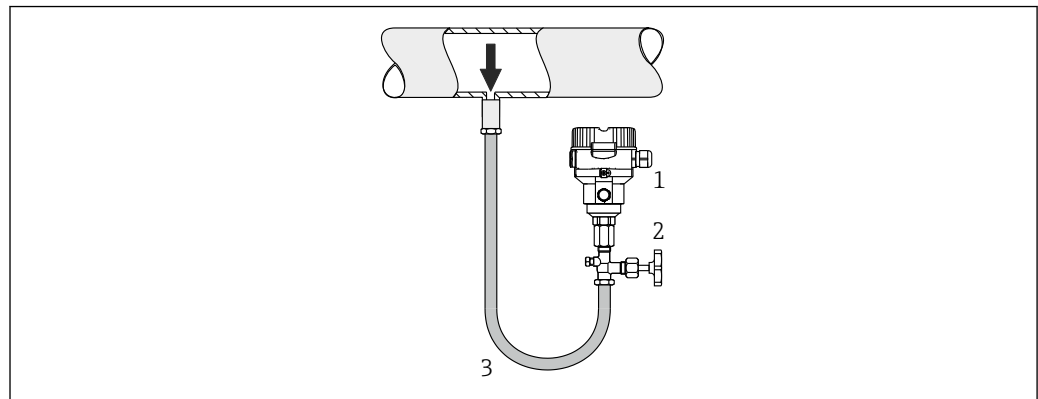

A002B491

- 1 Cerabar M
2 Shutoff device

Mount the Cerabar M with the shutoff device below or at the same level as the tapping point.

Level measurement

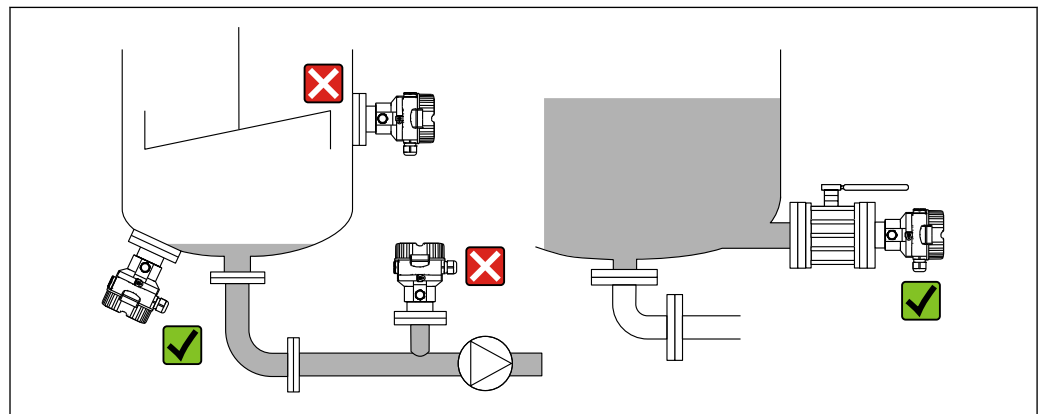

A002B492

- Always install the device below the lowest measuring point.
- Do not install the device at the following positions:
 - in the filling curtain
 - in the tank outlet
 - in the suction area of a pump
 - at a point in the tank which could be affected by pressure pulses from the agitator
- The calibration and functional test can be carried out more easily if you mount the device downstream of a shutoff device.

4.3.2 Installation instructions for devices with diaphragm seals – PMP55

- Cerabar M devices with diaphragm seals are screwed in, flanged or clamped, depending on the type of diaphragm seal.
- Please note that the hydrostatic pressure of the liquid columns in the capillaries can cause zero point shift. The zero point shift can be corrected.
- Do not clean or touch the membrane of the diaphragm seal with hard or pointed objects.
- Do not remove the protection on the membrane until just before installation.

NOTICE**Incorrect handling!**

Damage to the device!

- ▶ A diaphragm seal and the pressure transmitter together form a closed, oil-filled calibrated system. The fill fluid hole is sealed and may not be opened.
- ▶ If a mounting bracket is used, sufficient strain relief must be ensured for the capillaries in order to prevent them from buckling (bending radius ≥ 100 mm (3.94 in)).
- ▶ Please observe the application limits of the diaphragm seal fill fluid as detailed in the Technical Information for Cerabar M TI00436P, "Planning instructions for diaphragm seal systems" section.

NOTICE**In order to obtain more precise measurement results and to avoid a defect in the device, mount the capillaries as follows:**

- ▶ Vibration-free (in order to avoid additional pressure fluctuations)!
- ▶ Not in the vicinity of heating or cooling lines!
- ▶ Insulate if the ambient temperature is below or above the reference temperature!
- ▶ Mount with a bending radius ≥ 100 mm (3.94 in)!
- ▶ Do not use the capillaries as a carrying aid for the diaphragm seals!

Vacuum applications*Installation instructions*

In vacuum applications, ideally use pressure transmitters with a ceramic measuring membrane (oil-free).

For applications under vacuum, Endress+Hauser recommends mounting the pressure transmitter below the diaphragm seal. This prevents vacuum loading of the diaphragm seal caused by the presence of fill fluid in the capillary.

When the pressure transmitter is mounted above the diaphragm seal, the maximum height difference H1 in accordance with the following illustrations must not be exceeded. The following illustration shows installation above the lower diaphragm seal:

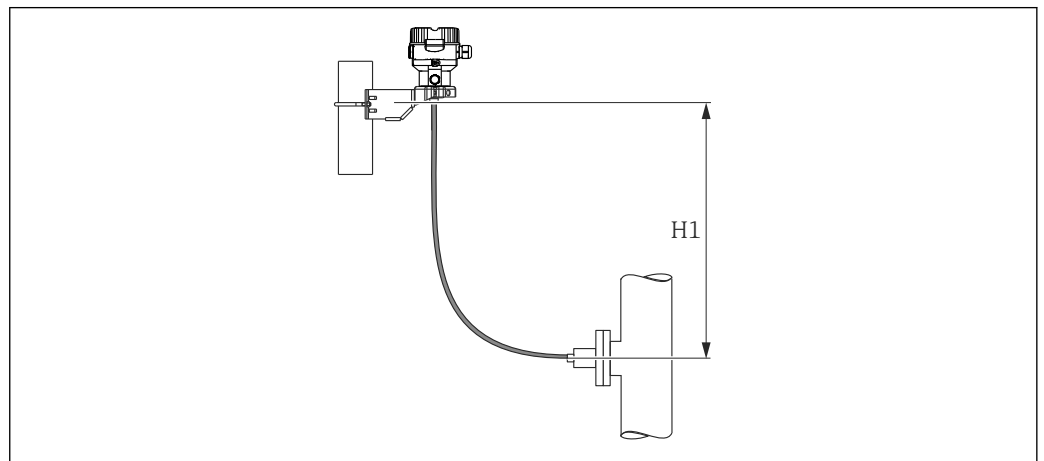

A0023994

The maximum height difference depends on the density of the fill fluid and the lowest pressure that is permitted to occur at the diaphragm seal (empty vessel). See illustration below. The following diagram shows the maximum installation height above the lower diaphragm seal for vacuum applications.

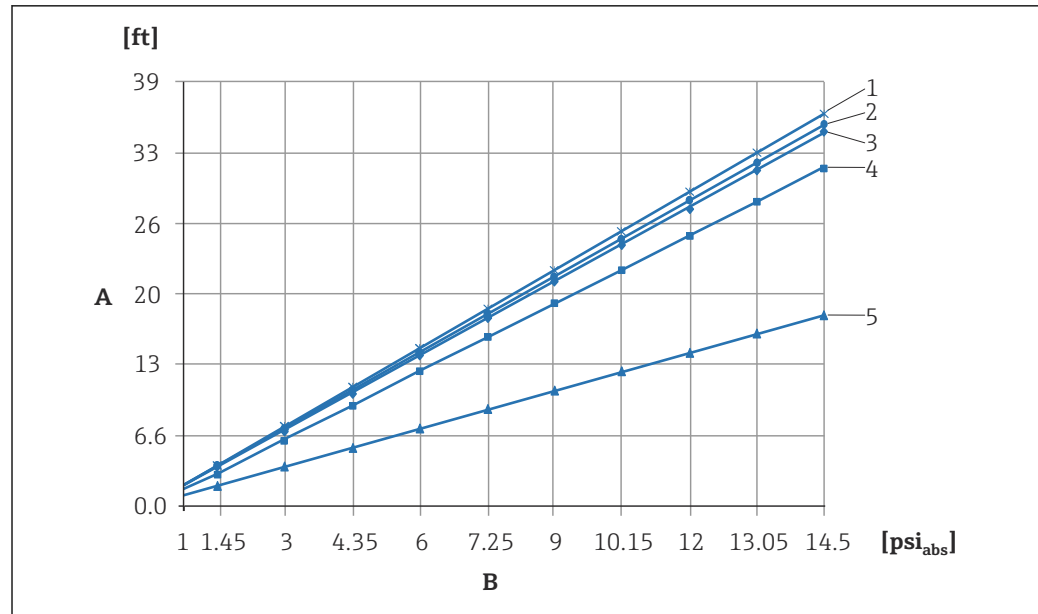

A0023986-EN

- A Height difference H1
 B Pressure at diaphragm seal
 1 Low-temperature oil
 2 Vegetable oil
 3 Silicone oil
 4 High-temperature oil
 5 Inert oil

Mounting with temperature isolator

Endress+Hauser recommends the use of temperature isolators in the event of constant extreme medium temperatures which cause the maximum permissible electronics temperature of +85 °C (+185 °F) to be exceeded. Depending on the fill fluid used, diaphragm seal systems with temperature isolators can be used for maximum temperatures of up to +400 °C (+752 °F), see Technical Information, section "Diaphragm seal fill fluids". To minimize the influence of rising heat, Endress+Hauser recommends the device be mounted horizontally or with the housing pointing downwards. The additional installation height causes a zero point shift of maximum 21 mbar (0.315 psi) due to the hydrostatic column in the temperature isolator. You can correct this zero point shift at the device.

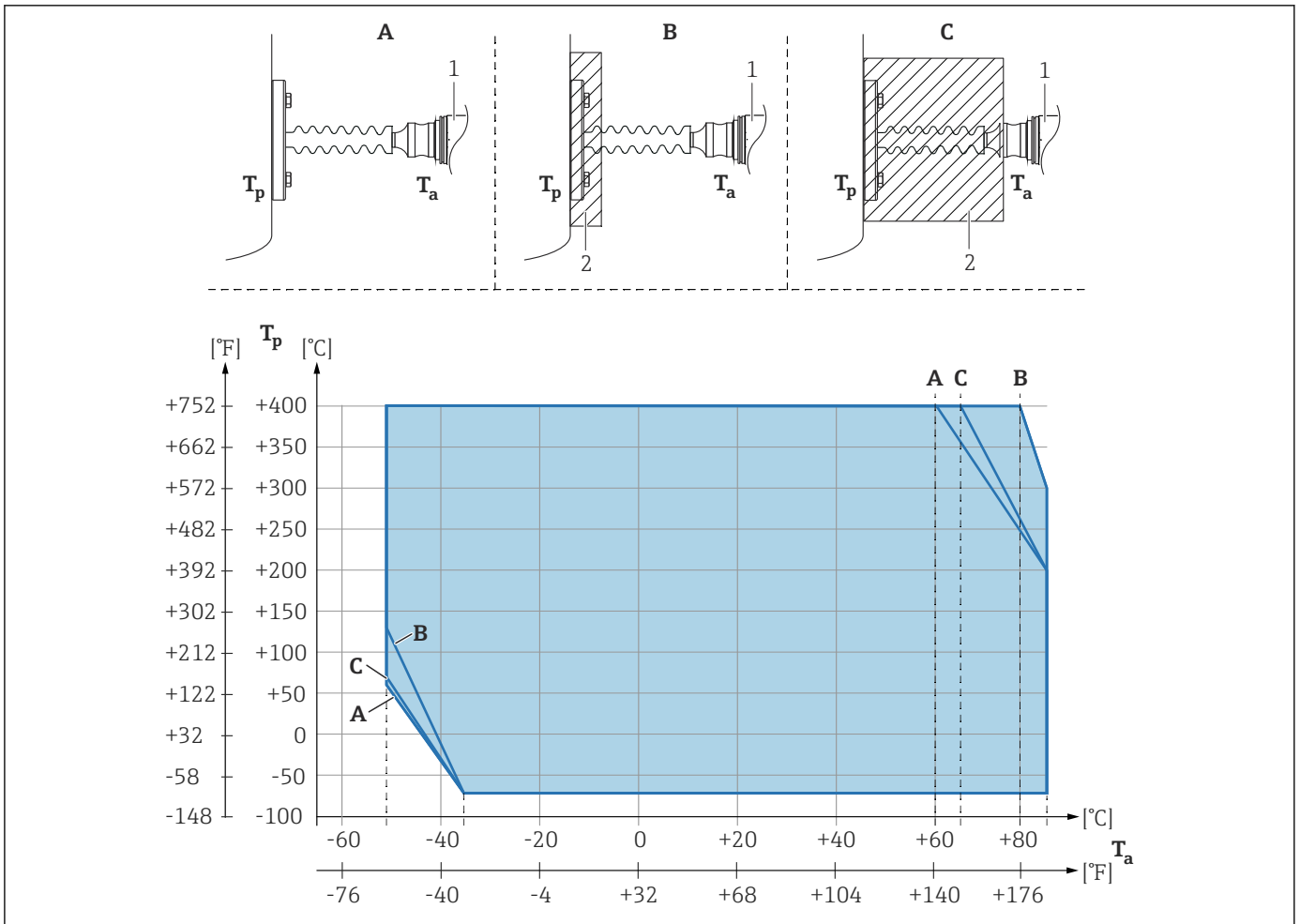

A0039378

- A No insulation
- B Insulation 30 mm (1.18 in)
- C Maximum insulation
- 1 Transmitter
- 2 Insulation material

Heat insulation

The PMP55 may only be insulated up to a certain height. The maximum permitted insulation height is indicated on the devices and applies to an insulation material with a heat conductivity $\leq 0.04 \text{ W}/(\text{m} \times \text{K})$ and to the maximum permitted ambient and process temperature. The data were determined under the most critical application "quiescent air". Maximum permitted insulation height, here indicated on a PMP55 with a flange:

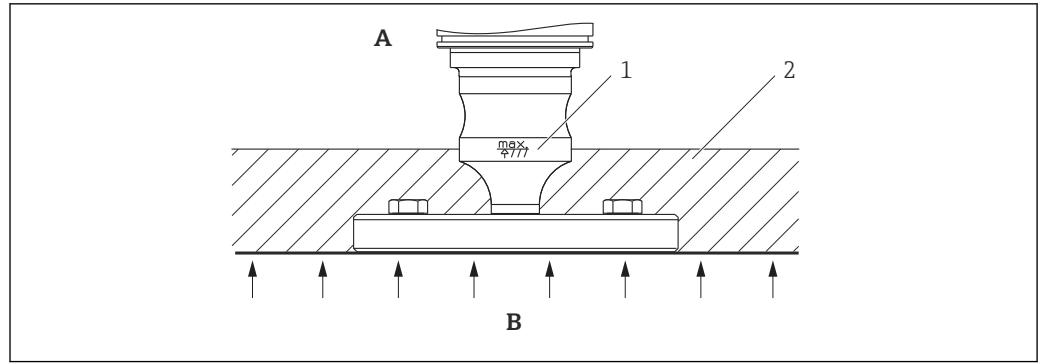

A0020474

- A Ambient temperature $\leq 70\text{ }^{\circ}\text{C}$ (158 $^{\circ}\text{F}$)
- B Process temperature
- 1 Maximum permitted insulation height
- 2 Insulation material

4.3.3 Seal for flange mounting

NOTICE

Incorrect measurement results.

The seal is not allowed to press against the membrane as this could affect the measurement result.

- Ensure that the seal is not touching the membrane.

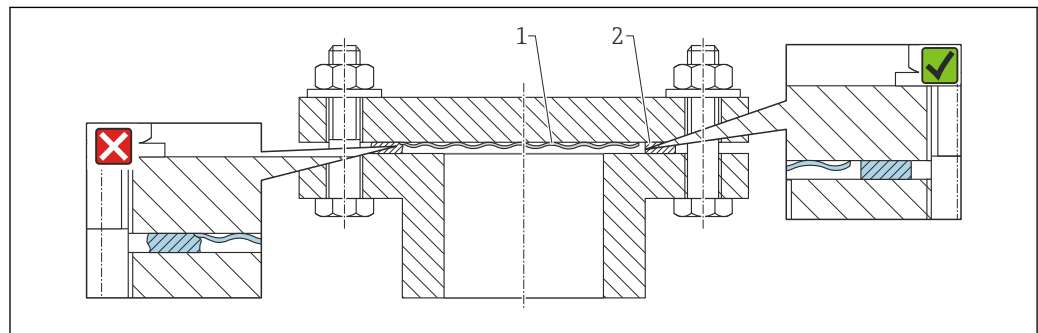

A0017743

- 1 Membrane
- 2 Seal

4.3.4 Wall and pipe mounting (optional)

Endress+Hauser offers a mounting bracket for installation on pipes or walls (for pipe diameters from 1 ¼" to 2").

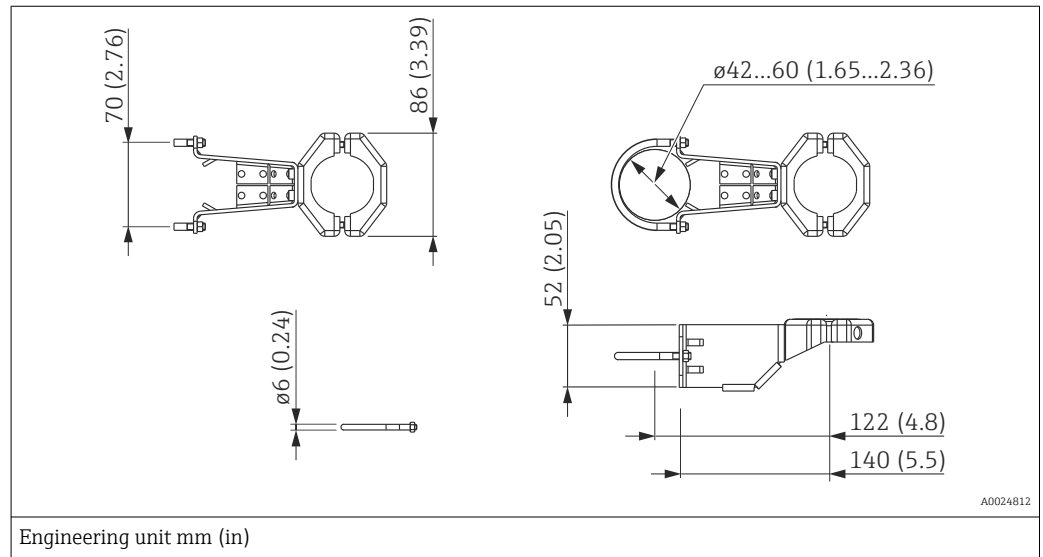

Please note the following when mounting:

- Devices with capillary tubes: mount capillaries with a bending radius \geq 100 mm (3.94 in).
- When mounting on a pipe, tighten the nuts on the bracket uniformly with a torque of at least 5 Nm (3.69 lbf ft).

4.3.5 Assembling and mounting the "separate housing" version

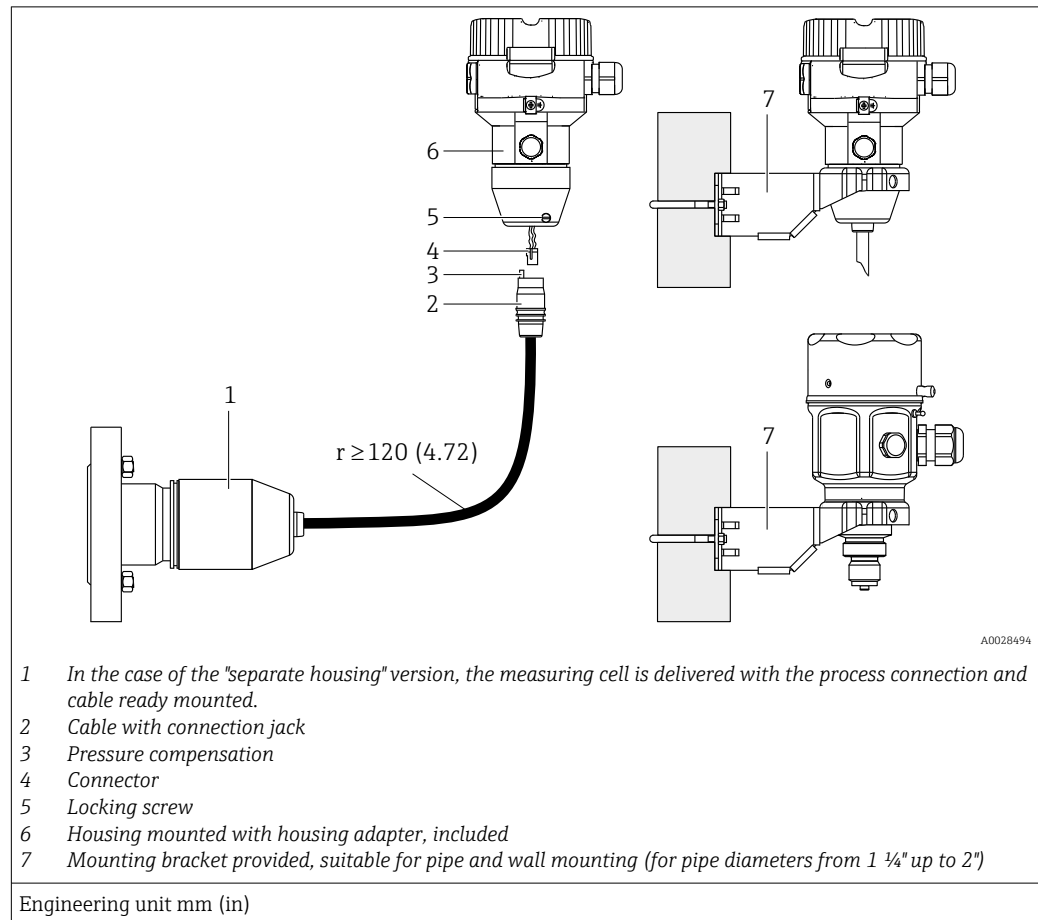

Assembly and mounting

1. Insert the connector (item 4) into the corresponding connection jack of the cable (item 2).
2. Plug the cable into the housing adapter (item 6).
3. Tighten the locking screw (item 5).
4. Mount the housing on a wall or pipe using the mounting bracket (item 7). When mounting on a pipe, tighten the nuts on the bracket uniformly with a torque of at least 5 Nm (3.69 lbf ft). Mount the cable with a bending radius (r) \geq 120 mm (4.72 in).

Routing the cable (e.g. through a pipe)

You require the cable shortening kit.

Order number: 71125862

For details on mounting, see SD00553P/00/A6.

4.3.6 PMP51, version prepared for diaphragm seal mount – welding recommendation

Version XSJ: prepared for diaphragm seal mount

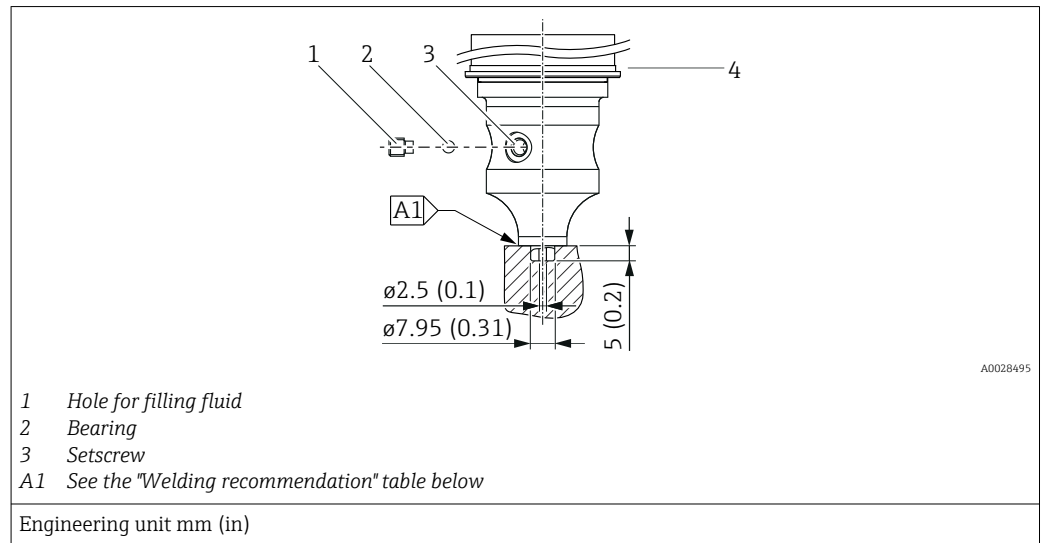

For the version "XSJ - Prepared for diaphragm seal mount" in feature 110 "Process connection" in the order code up to and including 40 bar (600 psi) measuring cells, Endress+Hauser recommends welding on the diaphragm seal as follows: the total welding depth of the fillet weld is 1 mm (0.04 in) with an outer diameter of 16 mm (0.63 in). Welding is performed according to the WIG method.

Consecutive seam no.	Sketch/welding groove shape, dimension as per DIN 8551	Base material matching	Welding method DIN EN ISO 24063	Welding position	Inert gas, additives
A1 for measuring cells ≤ 40 bar (600 psi)		Adapter made of AISI 316L (1.4435) to be welded to diaphragm seal made of AISI 316L (1.4435 or 1.4404)	141	PB	Inert gas Ar/H 95/5 Additive: ER 316L Si (1.4430)

Information on filling

The diaphragm seal must be filled as soon as it has been welded on.

- After welding into the process connection, the measuring cell assembly must be properly filled with a filling oil and sealed gas-tight with a sealing ball and lock screw. Once the diaphragm seal has been filled, at the zero point the device display should not exceed 10% of the full scale value of the cell measuring range. The internal pressure of the diaphragm seal must be corrected accordingly.
- Adjustment / calibration:
 - The device is operational once it has been fully assembled.
 - Perform a reset. The device must then be calibrated to the process measuring range as described in the Operating Instructions.

4.4 Installing the Deltapilot M

- Due to the orientation of the Deltapilot M, there may be a shift in the zero point, i.e. when the container is empty or partially full, the measured value does not display zero. You can correct this zero point shift → 34 "Function of the operating elements".
- The local display can be rotated in 90° stages.
- Endress+Hauser offers a mounting bracket for installing on pipes or walls. → 21, Section "Wall and pipe mounting (optional)".

4.4.1 General installation instructions

NOTICE

Damage to the device!

If a heated device is cooled during a cleaning process (e.g. by cold water), a vacuum develops for a short time and, as a result, moisture can enter the measuring cell through the pressure compensation (1).

- ▶ If this is the case, mount the device with the pressure compensation (1) pointing downwards.

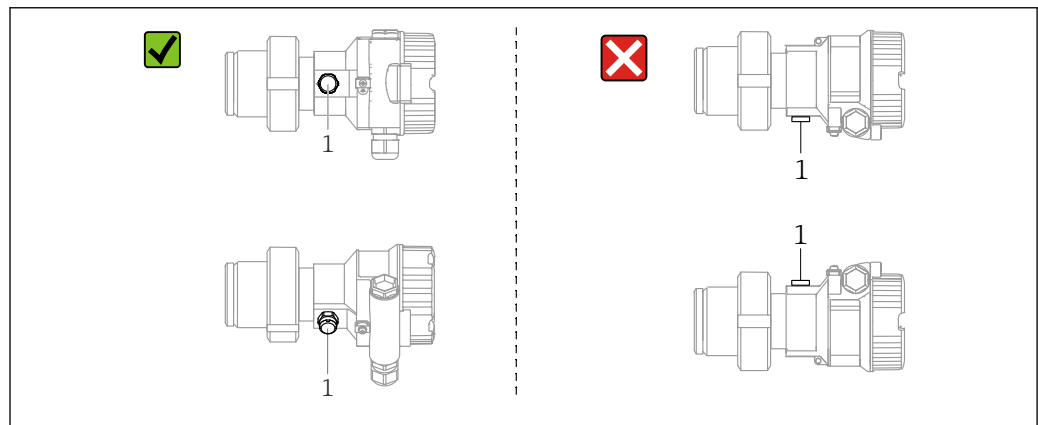

A0028471

- Keep the pressure compensation and GORE-TEX® filter (1) free from contamination.
- Do not clean or touch the membrane with hard or pointed objects.
- The membrane in the rod and cable version is protected against mechanical damage by a plastic cap.
- The device must be installed as follows in order to comply with the cleanability requirements of the ASME-BPE (Part SD Cleanability):

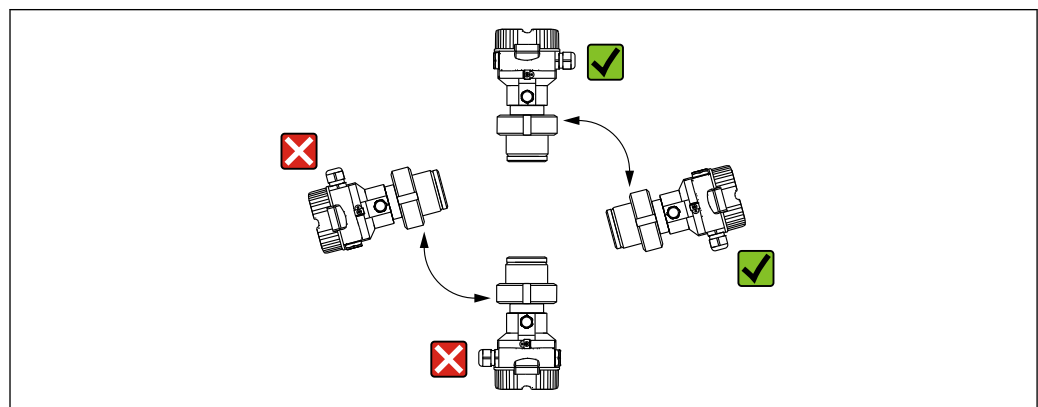

A0028472

4.4.2 FMB50

Level measurement

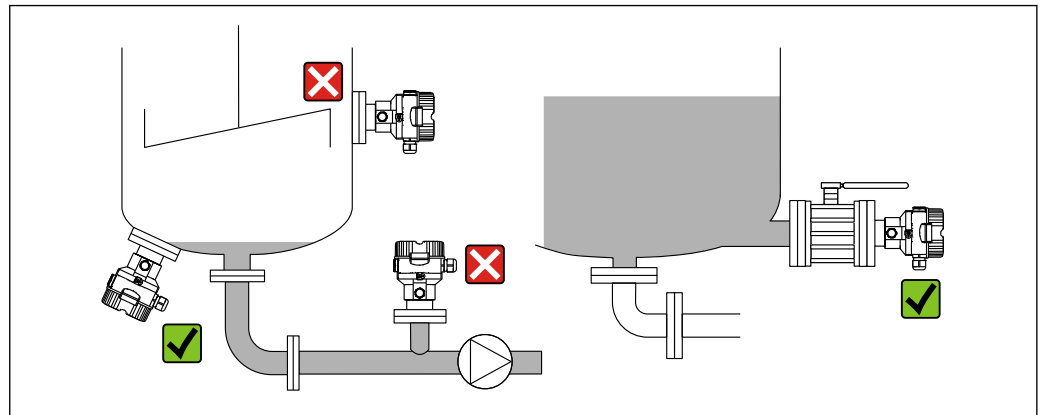

A0028492

- Always install the device below the lowest measuring point.
- Do not install the device at the following positions:
 - in the filling curtain
 - in the tank outlet
 - in the suction area of a pump
 - at a point in the tank which could be affected by pressure pulses from the agitator.
- The calibration and functional test can be carried out more easily if you mount the device downstream from a shutoff device.
- The Deltapilot M must also be insulated in the case of media that can harden when cold.

Pressure measurement in gases

Mount the Deltapilot M with the shutoff device above the tapping point so that any condensate can flow into the process.

Pressure measurement in vapors

- Mount the Deltapilot M with the siphon above the tapping point.
- Fill the siphon with liquid before commissioning. The siphon reduces the temperature to almost ambient temperature.

Pressure measurement in liquids

Mount the Deltapilot M with the shutoff device below or at the same level as the tapping point.

4.4.3 Supplementary installation instructions

Sealing the probe housing

- No moisture may enter the housing when installing or operating the device, or when establishing the electrical connection.
- Always firmly tighten the housing cover and the cable entries.

4.4.4 Seal for flange mounting

NOTICE

Incorrect measurement results.

The seal is not allowed to press against the membrane as this could affect the measurement result.

- ▶ Ensure that the seal is not touching the membrane.

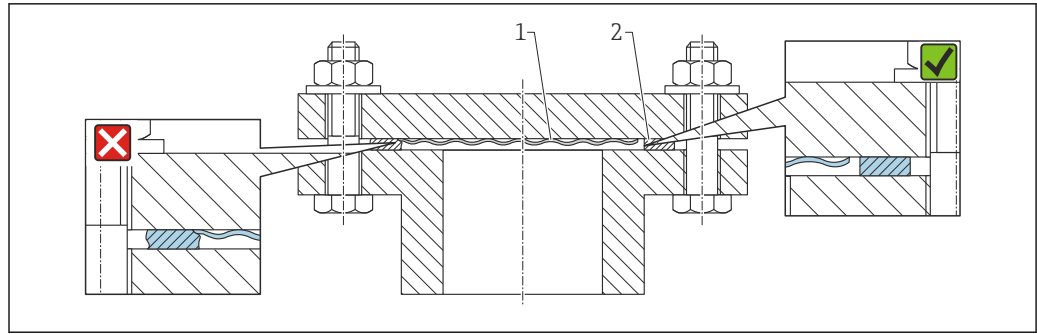

A0017743

- 1 Membrane
- 2 Seal

4.4.5 Wall and pipe mounting (optional)

Endress+Hauser offers a mounting bracket for installation on pipes or walls (for pipe diameters from 1 ¼" to 2").

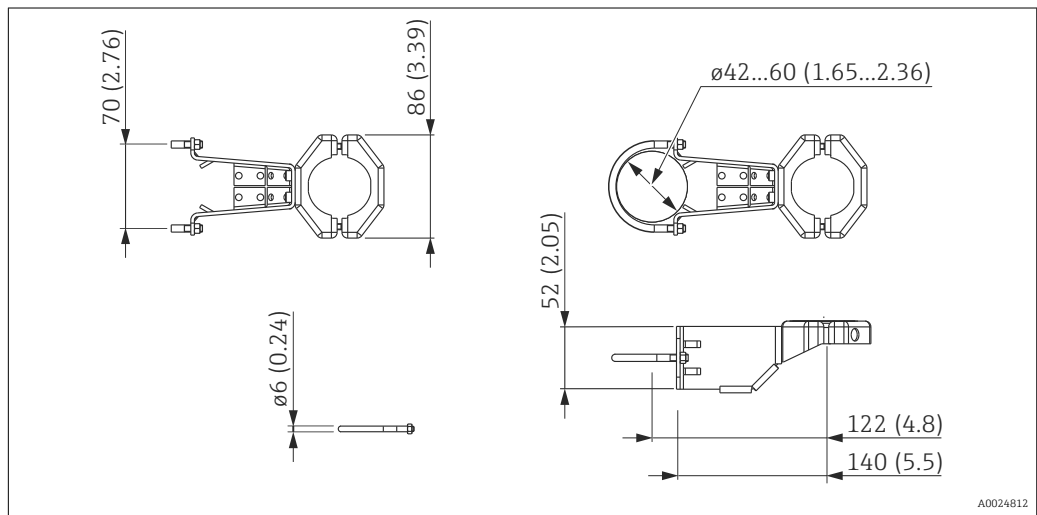

A0024812

Engineering unit mm (in)

Please note the following when mounting:

- Devices with capillary tubes: mount capillaries with a bending radius \geq 100 mm (3.94 in).
- When mounting on a pipe, tighten the nuts on the bracket uniformly with a torque of at least 5 Nm (3.69 lbf ft).

4.4.6 Assembling and mounting the "separate housing" version

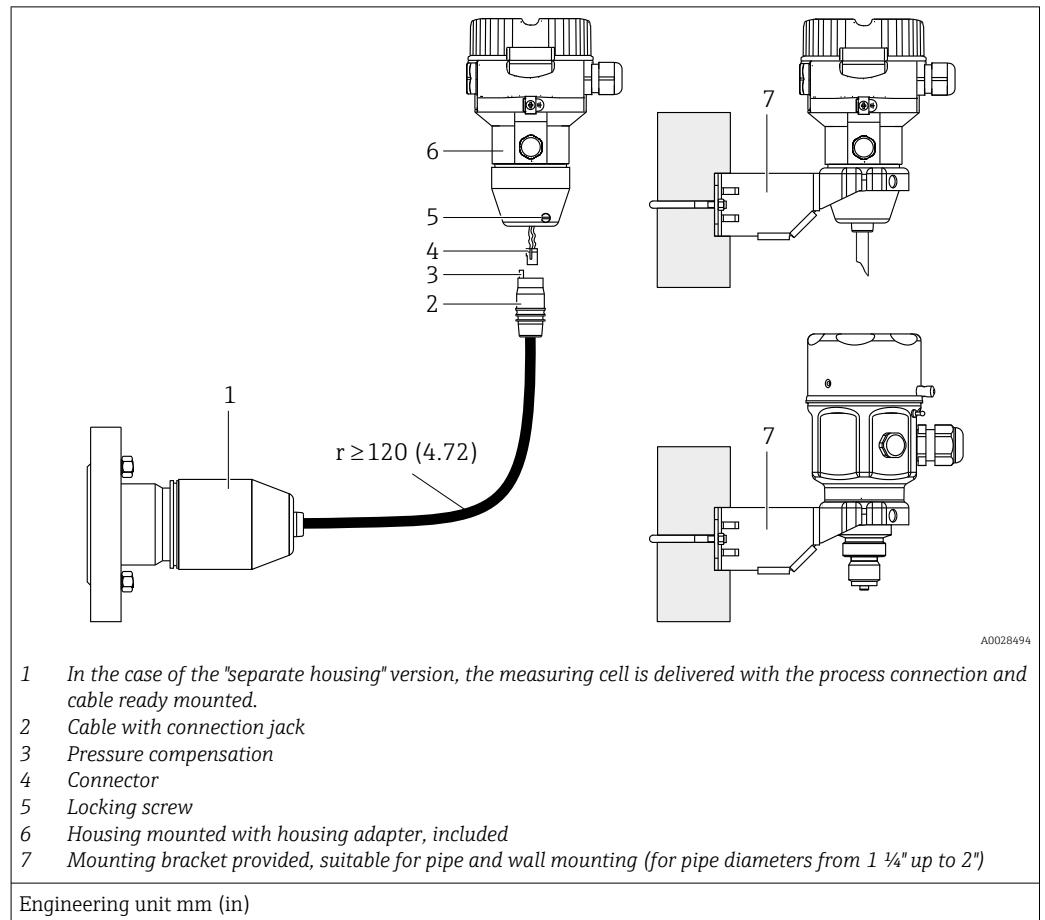

Assembly and mounting

1. Insert the connector (item 4) into the corresponding connection jack of the cable (item 2).
2. Plug the cable into the housing adapter (item 6).
3. Tighten the locking screw (item 5).
4. Mount the housing on a wall or pipe using the mounting bracket (item 7). When mounting on a pipe, tighten the nuts on the bracket uniformly with a torque of at least 5 Nm (3.69 lbf ft). Mount the cable with a bending radius (r) \geq 120 mm (4.72 in).

Routing the cable (e.g. through a pipe)

You require the cable shortening kit.

Order number: 71125862

For details on mounting, see SD00553P/00/A6.

4.5 Mounting of the profile seal for universal process adapter

For details on mounting, see KA00096F/00/A3.

4.6 Closing the housing cover

NOTICE

Devices with EPDM cover seal - transmitter leakiness!

Mineral-based, animal-based or vegetable-based lubricants cause the EPDM cover seal to swell and the transmitter to become leaky.

- ▶ The thread is coated at the factory and therefore does not require any lubrication.

NOTICE

The housing cover can no longer be closed.

Damaged thread!

- ▶ When closing the housing cover, please ensure that the thread of the cover and housing are free from dirt, e.g. sand. If you feel any resistance when closing the cover, check the thread on both again to ensure that they are free from dirt.

4.6.1 Closing the cover on the stainless steel housing

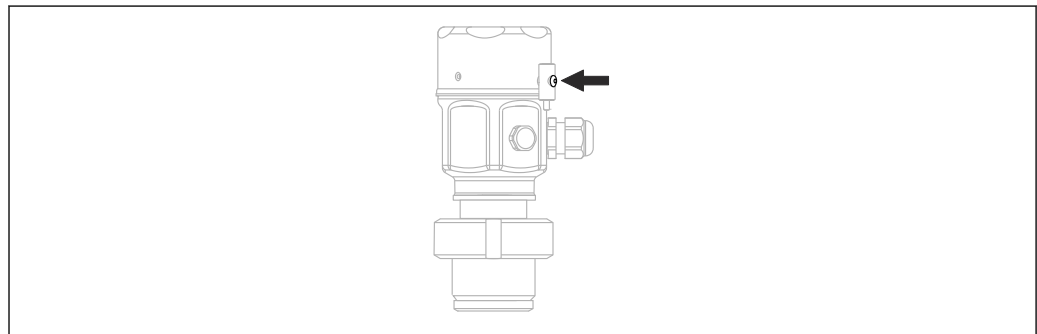

A0028497

The cover for the electronics compartment is tightened by hand at the housing until the stop. The screw serves as DustEx protection (only available for devices with DustEx approval).

4.7 Post-mounting check

<input type="checkbox"/>	Is the device undamaged (visual inspection)?
<input type="checkbox"/>	Does the measuring device meet the measuring point specifications? For example: <ul style="list-style-type: none"> ▪ Process temperature ▪ Process pressure ▪ Ambient temperature ▪ Measuring range
<input type="checkbox"/>	Are the measuring point identification and labeling correct (visual inspection)?
<input type="checkbox"/>	Is the device adequately protected from precipitation and direct sunlight?
<input type="checkbox"/>	Are the fixing screws and securing clamp tightened securely?

5 Electrical connection

5.1 Connecting the device

⚠ WARNING

Supply voltage might be connected!

Risk of electric shock and/or explosion!

- ▶ Make sure that no uncontrolled processes are triggered on the system.
- ▶ Switch off the supply voltage before connecting the device.
- ▶ When using the measuring device in hazardous areas, ensure compliance with the corresponding national standards and regulations and the Safety Instructions or Installation or Control Drawings.
- ▶ A suitable circuit breaker must be provided for the device in accordance with IEC/EN61010.
- ▶ Devices with integrated overvoltage protection must be grounded.
- ▶ Protective circuits against reverse polarity, HF influences and overvoltage peaks are integrated.
- ▶ The power unit must be tested to ensure it meets safety requirements (e.g., PELV, SELV, Class 2).

Connect the device in the following order:

1. Check that the supply voltage corresponds to the supply voltage indicated on the nameplate.
2. Switch off the supply voltage before connecting the device.
3. Connect the device in accordance with the following diagram.
4. Switch on the supply voltage.

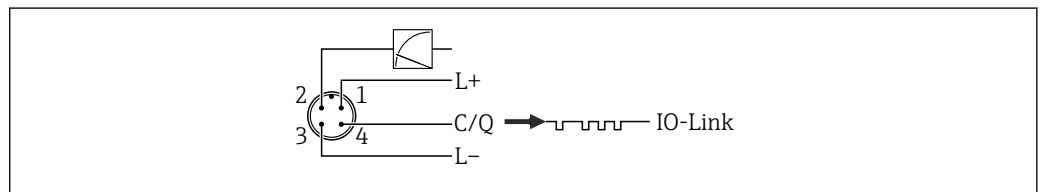

A0045628

- 1 Supply voltage +
- 2 4-20 mA
- 3 Supply voltage -
- 4 C/Q (IO-Link communication)

5.2 Connecting the measuring unit

5.2.1 Supply voltage

IO-Link

- 11.5 to 30 V DC if only the analog output is used
- 18 to 30 V DC if IO-Link is used

5.2.2 Current consumption

IO-Link < 60 mA

5.3 Terminals

- Supply voltage: 0.5 to 2.5 mm² (20 to 14 AWG)
- External ground terminal: 0.5 to 4 mm² (20 to 12 AWG)

5.4 Cable specification

5.4.1 IO-Link

Endress+Hauser recommends using twisted, four-core cable.

5.5 Load for current output

In order to guarantee sufficient terminal voltage, a maximum load resistance R_L (including line resistance) must not be exceeded depending on the supply voltage U_B of the supply unit.

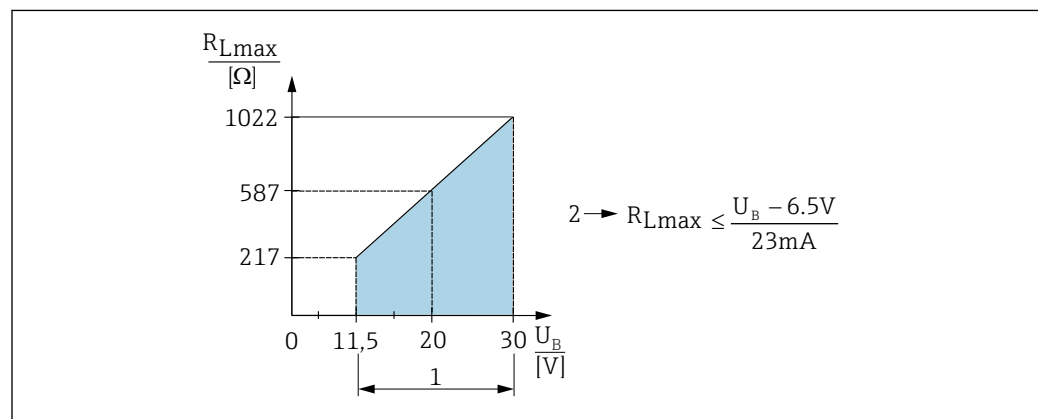

A0045615

- 1 Power supply 11.5 to 30 V_{DC}
 2 R_{Lmax} maximum load resistance
 U_B Supply voltage

If the load is too high, the device performs the following points:

- Output of failure current and display of "M803" (Output: MIN alarm current)
- Periodic checking to establish if it is possible to quit fault state

5.6 Field Xpert SMT70, SMT77

The Field Xpert SMT70 tablet PC for device configuration enables mobile plant asset management in hazardous (Ex Zone 2) and non-hazardous areas. It is suitable for commissioning and maintenance staff. It manages Endress+Hauser and third-party field instruments with a digital communication interface and documents the progress of the work. The SMT70 is designed as a complete solution. It comes with a pre-installed driver library and is an easy-to-use, touch-enabled tool for managing field devices throughout their entire life cycle.

The Field Xpert SMT77 for device configuration enables mobile plant asset management in areas categorized as Ex Zone 1. It is suitable for commissioning and maintenance staff for easy management of field instruments with a digital communication interface. The touch-enabled tablet PC is designed as a complete solution. It comes with comprehensive pre-installed driver libraries and offers users a modern software user interface to manage field instruments throughout the entire life cycle.

Required tool for IO-Link: "IO-Link IODD Interpreter DTM" on www.endress.com

5.7 FieldPort SFP20

The FieldPort SFP20 is a USB interface for the configuration of Endress+Hauser IO-Link devices, and also of devices from other vendors. Combined with the IO-Link CommDTM and the IO-Link Interpreter, the FieldPort SFP20 complies with the FDT/DTM standards.



5.8 Post-connection check

<input type="checkbox"/>	Is the device or cable undamaged (visual inspection)?
<input type="checkbox"/>	Do the cables comply with the requirements?
<input type="checkbox"/>	Do the mounted cables have adequate strain relief?
<input type="checkbox"/>	Are all cable glands installed, securely tightened and leak-tight?
<input type="checkbox"/>	Does the supply voltage match the specifications on the nameplate?
<input type="checkbox"/>	Is the terminal assignment correct?
<input type="checkbox"/>	If required: Has the protective ground connection been established?
<input type="checkbox"/>	If supply voltage is present, is the device ready for operation and do values appear on the display module?
<input type="checkbox"/>	Are all housing covers installed and firmly tightened?
<input type="checkbox"/>	Is the securing clamp tightened correctly?

6 Operation



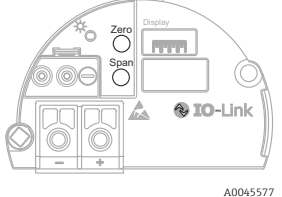

6.1 Operation methods

6.1.1 Operation without an operating menu

Operation methods	Explanation	Graphic	Description
Local operation without device display	The device is operated using the operating keys on the electronic insert.		→  33

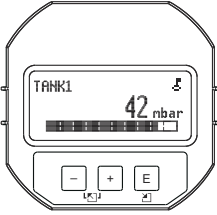
6.1.2 Operation with an operating menu

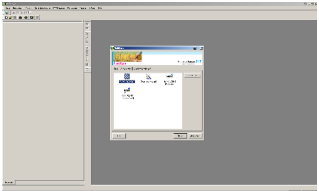
Operation with an operating menu is based on an operating concept with "user roles"
 →  34.

Operation methods	Explanation	Graphic	Description
Local operation with device display	The device is operated using the operating keys on the device display.		→  35
Remote operation via FieldCare	The device is operated using the FieldCare operating tool.		→  39

6.1.3 IO-Link

IO-Link information

IO-Link Smart Sensor Profile 2nd Edition

Supports

- Identification
- Diagnosis
- Digital Measuring Sensor (as per SSP 4.3.3)

IO-Link is a point-to-point connection for communication between the measuring device and an IO-Link master. The measuring device features an IO-Link communication interface type 2 (pin 4) with a second IO function on pin 2. This requires an IO-Link-compatible assembly (IO-Link master) for operation. The IO-Link communication interface enables direct access to the process and diagnostic data. It also provides the option of configuring the measuring device while in operation.

Characteristics of the IO-Link interface:

- IO-Link specification: Version 1.1
- IO-Link Smart Sensor Profile 2nd Edition
- Speed: COM2; 38.4 kBaud
- Minimum cycle time: 10 ms
- Process data width: 14 Byte
- IO-Link data storage: Yes
- Block configuration: Yes
- Device operational: The measuring device is operational 5 seconds after the supply voltage is applied

IO-Link download

<http://www.endress.com/download>

- Select "Device Driver" from the search options shown
- For "Type", select "IO Device Description (IODD)"
Select IO-Link (IODD)
IODD for Cerabar M PMC51, PMP51, PMP55
IODD for Deltapilot FMB50
- Under the product root, select the desired device and follow any further instructions.

<https://ioddfinder.io-link.com/>

Search by

- Manufacturer
- Article number
- Product type

6.2 Operation without an operating menu

6.2.1 Position of operating elements

The operating keys are located in the measuring device on the electronic insert.

IO-Link

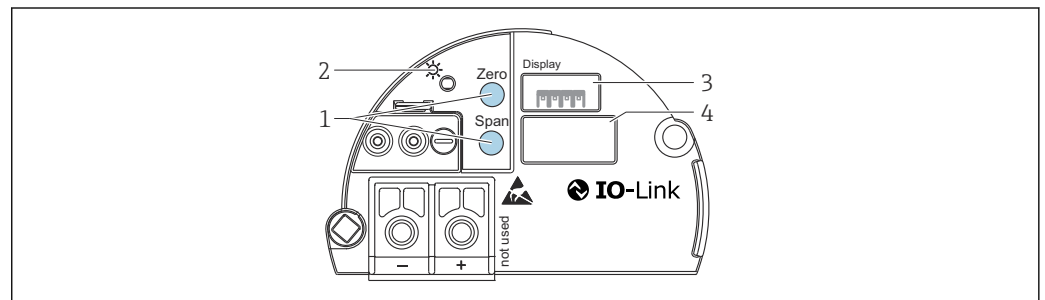

A0045576

- 1 Operating keys for lower range value (zero) and upper range value (span)
- 2 Green LED to indicate successful operation
- 3 Slot for optional local display
- 4 Slot for M12 plug

Function of the operating elements

Operating key(s)	Meaning
Zero pressed for at least 3 seconds	Get LRV <ul style="list-style-type: none"> ▪ "Pressure" measuring mode The pressure present is accepted as the lower range value (LRV). ▪ "Level" measuring mode, "In pressure" level selection, "Wet" calibration mode The pressure present is assigned to the lower level value ("Empty calibration").
Span pressed for at least 3 seconds	Get URV <ul style="list-style-type: none"> ▪ "Pressure" measuring mode The pressure present is accepted as the upper range value (URV). ▪ "Level" measuring mode, "In pressure" level selection, "Wet" calibration mode The pressure present is assigned to the upper level value ("Full calibration").
Zero and Span pressed simultaneously for at least 3 seconds	Position adjustment The measuring cell characteristic curve is shifted in parallel so that the pressure present becomes the zero value.
Zero and Span pressed simultaneously for at least 12 seconds	Reset All the parameters are reset to the order configuration.

6.2.2 Locking/unlocking operation

Once you have entered all the parameters, you can lock your entries against unauthorized and undesired access.

6.3 Operation with an operating menu

6.3.1 Operating concept

The operating concept makes a distinction between the following user roles:

User role	Meaning
Operator	Operators are responsible for the devices during normal "operation". This is usually limited to reading process values either directly at the device or in a control room. If the work with the devices goes beyond reading, it concerns simple, application-specific functions that are used in operation. Should an error occur, these users simply forward the information on the errors but do not intervene themselves.
Service engineer/ technician	Service engineers usually work with the devices in the phases following device commissioning. They are primarily involved in maintenance and troubleshooting activities for which simple settings have to be made on the device. Technicians work with the devices over the entire life cycle of the product. Thus, commissioning and advanced settings and configurations are some of the tasks they have to carry out.
Expert	Experts work with the devices over the entire life cycle of the device, but in some cases place high demands on the devices. Individual parameters/functions from the overall functionality of the devices are required for this purpose time and again. In addition to technical, process-oriented tasks, experts can also perform administrative tasks (e.g. user administration). "Experts" can access the entire parameter set.

6.3.2 Structure of the operating menu

User role	Sub-menu	Meaning/use
Operator	Language	Only consists of the "Language" parameter (000) where the operating language for the device is specified. The language can always be changed even if the device is locked.
Operator	Display/operat.	Contains parameters that are needed to configure the measured value display (selecting the values displayed, display format etc.). With this submenu, users can change the measured value display without affecting the actual measurement.
Maintenance	Setup	Contains all the parameters that are needed to commission measuring operations. This submenu has the following structure: <ul style="list-style-type: none"> ▪ Standard setup parameters A wide range of parameters, which can be used to configure a typical application, is available at the start. The measuring mode selected determines which parameters are available. After making settings for all these parameters, the measuring operation should be completely configured in the majority of cases. ▪ "Extended setup" submenu The "Extended setup" submenu contains additional parameters for more accurate configuration of the measurement, for converting the measured value and for scaling the output signal. This menu is split into additional submenus depending on the measuring mode selected.
Maintenance	Diagnosis	Contains all the parameters that are needed to detect and analyze operating errors. This submenu has the following structure: <ul style="list-style-type: none"> ▪ Diagnostic list Contains up to 10 currently active error messages. ▪ Event logbook Contains the last 10 error messages (no longer active). ▪ Instrument info Contains information for identifying the device. ▪ Measured values Contains all the current measured values ▪ Simulation Is used to simulate pressure, level, current and alarm/warning. ▪ Enter reset code
Expert	Expert	Contains all the parameters of the device (including those already in one of the other submenus). The "Expert" submenu is structured by the function blocks of the device. It thus contains the following submenus: <ul style="list-style-type: none"> ▪ System Contains all the device parameters that do not pertain either to the measurement or to integration into a control system. ▪ Measurement Contains all the parameters for configuring the measurement. ▪ Output Contains all the parameters for configuring the current output. ▪ Communication Contains all the parameters for configuring the communication interface. ▪ Application Contains all the parameters for configuring the functions that go beyond the actual measurement. ▪ Diagnosis Contains all the parameters that are needed to detect and analyze operating errors.

For an overview of the entire operating menu →  71.

6.4 Operation with device display (optional)

A 4-line liquid crystal display (LCD) is used for display and operation. The local display shows measured values, dialog texts, fault messages and notice messages. For easy operation the display can be taken out of the housing (see figure steps 1 to 3). It is connected to the device via a 90 mm (3.54 in) long cable. The display of the device can be turned in 90°

stages (see figure steps 4 to 6). Depending on the installation position of the device, this makes it easy to operate the device and read the measured values.

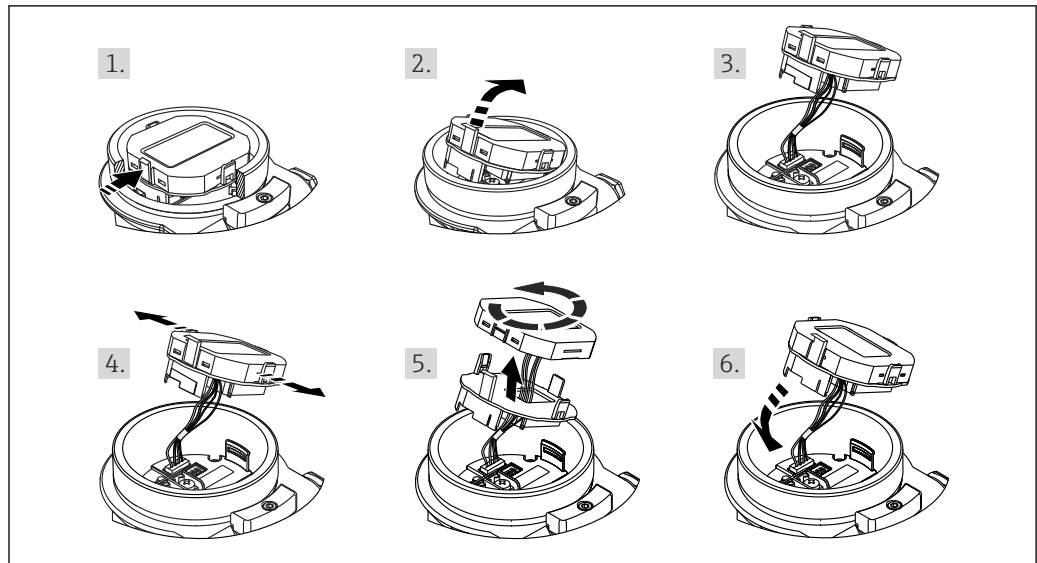

A0028500

Functions:



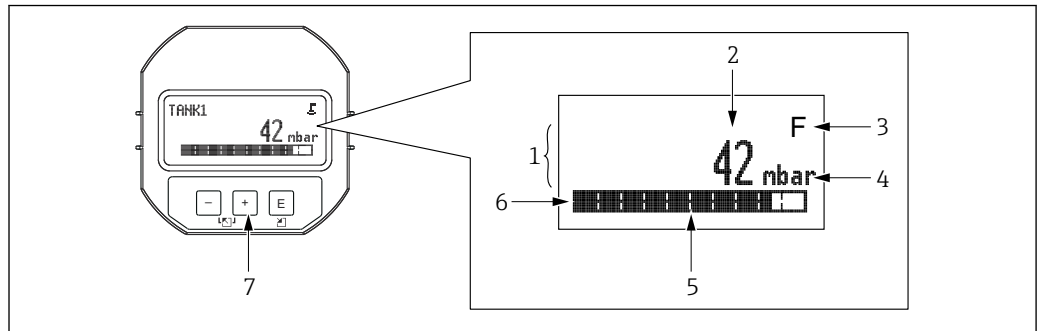



- 8-digit measured value display incl. sign and decimal point, bar graph for 4 to 20 mA as current display.
- Three keys for operation
- Simple and complete menu guidance as parameters are split into several levels and groups
- Each parameter is given a 3-digit parameter code for easy navigation
- Comprehensive diagnostic functions (fault and warning message etc.)











A0030013

- 1 Main line
- 2 Value
- 3 Symbol
- 4 Unit
- 5 Bar graph
- 6 Information line
- 7 Operating keys

The following table illustrates the symbols that can appear on the local display. Four symbols can occur at one time.



Symbol	Meaning
 A0018154	Lock symbol The operation of the device is locked. Unlock the device, →  39.
 A0018155	Communication symbol Data transfer via communication
 A0013958	Error message "Out of specification" The device is being operated outside its technical specifications (e.g. during warm-up or cleaning).
 A0013959	Error message "Service mode" The device is in the Service mode (e.g. during a simulation).
 A0013957	Error message "Maintenance required" Maintenance is required. The measured value is still valid.
 A0013956	Error message "Failure detected" An operating error has occurred. The measured value is no longer valid.



6.4.1 Operating keys on the display and operating module

Operating key(s)	Meaning
 A0017879	<ul style="list-style-type: none"> Navigate down in the picklist Edit the numerical values or characters within a function
 A0017880	<ul style="list-style-type: none"> Navigate up in the picklist Edit the numerical values or characters within a function
 A0017881	<ul style="list-style-type: none"> Confirm entry Jump to the next item Select a menu item and activate the edit mode
 and  A0017879 A0017881	Contrast setting of local display: darker
 and  A0017880 A0017881	Contrast setting of local display: brighter
 and  A0017879 A0017880	ESC functions: <ul style="list-style-type: none"> Exit the edit mode for a parameter without saving the changed value You are in the menu at a selection level: each time you press the keys simultaneously, you go up a level in the menu.

6.4.2 Operating example: Parameters with a picklist

Example: selecting "Deutsch" as the language of the menu.











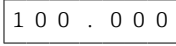
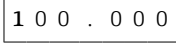

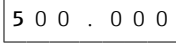

	Language	000	Operation
1	✓ English Deutsch		"English" is set as the menu language (default value). A ✓ in front of the menu text indicates the active option.
2	Deutsch ✓ English		Select "Deutsch" with  or  .

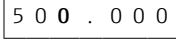
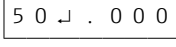
	Language 000	Operation
3	<ul style="list-style-type: none"> ✓ Deutsch English 	<ul style="list-style-type: none"> ▪ Select  to confirm. A ✓ in front of the menu text indicates the option that is currently active ("Deutsch" is the language selected). ▪ Use  to exit the edit mode for the parameter.

6.4.3 Operating example: User-definable parameters

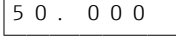
Example: setting the "Set URV (014)" parameter from 100 mbar (1.5 psi) to 50 mbar (0.75 psi).





Menu path: Setup → Extended setup → Current output → Set URV

	Set URV 014	Operation
1	 mbar	The local display shows the parameter to be changed. The "mbar" unit is defined in another parameter and cannot be modified here.
2	 mbar	Press  or  to enter the editing mode. The first digit is highlighted in black.
3	 mbar	Use the  key to change "1" to "5". Press the  key to confirm "5". The cursor jumps to the next position (highlighted in black). Confirm "0" with  (second position).
4	 mbar	The third digit is highlighted in black and can now be edited.
5	 mbar	Use the  key to change to the "  " symbol. Use  to save the new value and exit the edit mode. See next graphic.
6	 mbar	The new value for the upper range value is 50 mbar (0.75 psi). Use  to exit the edit mode for the parameter. Use  or  to return to the edit mode.

6.4.4 Operating example: Accepting the pressure present

Example: Setting pos. zero adjustment.

Menu path: Main menu → Setup → Pos. zero adjust

	Pos. zero adjust 007	Operation
1	<ul style="list-style-type: none"> ✓ Cancel Confirm 	The pressure for pos. zero adjustment is present at the device.
2	<ul style="list-style-type: none"> Cancel ✓ Confirm 	Use  or  to switch to the "Confirm" option. The active option is highlighted in black.
3	Adjustment has been accepted!	Use the  key to accept the applied pressure for pos. zero adjustment. The device confirms the adjustment and goes back to the "Pos. zero adjust" parameter.
4	<ul style="list-style-type: none"> ✓ Cancel Confirm 	Use  to exit the edit mode for the parameter.

6.5 Operation using Endress+Hauser operating program

The FieldCare operating program is an Endress+Hauser asset management tool based on FDT technology. With FieldCare, you can configure all Endress+Hauser devices as well as devices from other manufacturers that support the FDT standard.

Hardware and software requirements can be found on the Internet:

www.de.endress.com → Search: FieldCare → FieldCare → Technical data.

FieldCare supports the following functions:

- Configuration of transmitters in online/offline mode
- Documentation of the measuring point
- Offline parametrization of transmitters

Connection options:

FieldPort SFP20

- i
 - The configuration data can be uploaded to the DTM with the upload function, modified in the DTM and then downloaded to the download (FDT upload/download).
 - More information about FieldCare is available on the Internet (<http://www.de.endress.com>, Download, → Search for: FieldCare).

6.6 Locking/unlocking operation

Once you have entered all the parameters, you can lock your entries against unauthorized and undesired access.

Locked operation is indicated as follows:

- By the  symbol on the local display
- The parameters are grayed out in FieldCare and the handheld terminal, which means they cannot be edited. Information displayed in the " parameter.

Parameters which refer to how the display appears, e.g. "Language", can still be altered.

The "Operator code" parameter is used to lock and unlock the device.

Operator code (021)

Write permission	Operators/Service engineers/Expert
Description	Use this function to enter a code to lock or unlock operation.
User entry	<ul style="list-style-type: none"> ▪ To lock: Enter a number ≠ the release code (value range: 1 to 9999). ▪ To unlock: Enter the release code.
Note	The release code is "0" in the order configuration. Another release code can be defined in the "Code definition" (023) parameter. If the user has forgotten the release code, the release code can be visible by entering the number "5864".
Factory setting	0

6.7 Resetting to factory settings (reset)

Reset via the local display

By entering a certain code, you can completely, or partially, reset the entries for the parameters to the factory settings ¹⁾. Enter the code by means of the "Enter reset code" parameter (menu path: "Diagnosis" → "Reset" → "Enter reset code"). There are various reset codes for the device. The following table illustrates which parameters are reset by the particular reset codes. Operation must be unlocked to reset parameters → 39.

Reset via IO-Link

- Reset to factory setting:
System → Device Management → System Command → Restore Factory Setting
- Reset to factory setting as per IO-Link (switch device off and on):
System → Device Management → System Command → Back-To-Box
- Device reset:
System → Device Management → System Command → Device Reset

 Any customer-specific configuration carried out at the factory is not affected by a reset (customer-specific configuration remains). If you want to change the customer-specific configuration carried out at the factory, please contact Endress+Hauser Service. As no separate service level is provided, the order code and serial number may be changed without a specific access code (e.g. after replacing the electronics).

Enter the reset code ¹⁾ Display	IO-Link command	Description and effect
62 (Device Reset)	296 (Device Reset)	PowerUp reset (warm start) <ul style="list-style-type: none"> ▪ The device is restarted ▪ Data are read back from the EEPROM again (processor is initialized again) ▪ Any simulation which may be running is ended
7864 (Restore to Factory Settings)	297 (Restore to Factory Settings)	Total reset <ul style="list-style-type: none"> ▪ This code resets all the parameters apart from: <ul style="list-style-type: none"> ▪ Operating hours (162) ▪ Event logbook ▪ Lo Trim Sensor (131) ▪ Hi Trim Sensor (132) ▪ Any simulation which may be running is ended ▪ The device is restarted
-	131 (Back To Box)	Total Reset (Back To Box) <ul style="list-style-type: none"> ▪ This code resets all the parameters apart from: <ul style="list-style-type: none"> ▪ Operating hours (162) ▪ Event logbook ▪ Lo Trim Sensor (131) ▪ Hi Trim Sensor (132) ▪ Any simulation which may be running is ended ▪ Perform manual restart

1) in "Diagnosis" → "Reset" → "Enter reset code" (124)

1) The factory setting for the individual parameters is indicated in the parameter description .

7 System integration

7.1 Process data

The measuring device has a current output.

- In the IO-Link communication mode, pin 4 of the M12 plug is reserved exclusively for communication
- The current output at pin 2 of the M12 plug is always active and can be optionally deactivated via IO-Link
- The measuring device's process data are transmitted cyclically as per SSP 4.3.3

Name	Bit-offset	Data type	Permitted values	Offset / gradient	Description
Pressure	80	Float32	-	mbar: 0 / 0.01 bar: 0 / 0.00001 mmH2O: 0 / 0.101973 mH2O: 0 / 0.000101973 ftH2O: 0 / 0.00033456 inH2O: 0 / 0.00401477 Pa: 0 / 1 kPa: 0 / 0.001 MPa: 0 / 0.000001 psi: 0 / 0.0001450326 mmHg: 0 / 0.0075006 inHg: 0 / 0.0002953 kgf / cm ² : 0 / 0.0000101973	Current pressure
Level	48	Float32	-	-	Current level
Temperature	16	Float32	-	C: 0 / 0.01 F: +32 / 0.018 K: +273.15 / 0.01	Actual temperature
Summary status	8	8-bit UInteger	<ul style="list-style-type: none"> ■ 36 = Error ■ 60 = Function check ■ 120 = Outside specifications ■ 128 = Good ■ 129 = Simulation ■ 164 = Maintenance required 	-	Summary status as per PI specification
Level status	6	2-bit UInteger	<ul style="list-style-type: none"> ■ 0 = Default setting ■ 1 = Calibrated 	-	Current level status
Process Data Input.Switching Signal Channel 3.2 Temperature	5	1-bit UInteger	0 = False 1 = True	-	Switching Signal Status SSC 3.2
Process Data Input.Switching Signal Channel 3.1 Temperature	4	1-bit UInteger	0 = False 1 = True	-	Switching Signal Status SSC 3.1
Process Data Input.Switching Signal Channel 2.2 Level	3	1-bit UInteger	0 = False 1 = True	-	Switching Signal Status SSC 2.2
Process Data Input.Switching Signal Channel 2.1 Level	2	1-bit UInteger	0 = False 1 = True	-	Switching Signal Status SSC 2.1
Process Data Input.Switching Signal Channel 1.2 Pressure	1	1-bit UInteger	0 = False 1 = True	-	Switching Signal Status SSC 1.2
Process Data Input.Switching Signal Channel 1.1 Pressure	0	1-bit UInteger	0 = False 1 = True	-	Switching Signal Status SSC 1.1

7.2 Reading out and writing device data (ISDU – Indexed Service Data Unit)

Device data are always exchanged acyclically and at the request of the IO-Link master. Using the device data, the following parameter values or device statuses can be read out:

7.2.1 Endress+Hauser-specific device data

ISDU (dec)	Designation	ISDU (hex)	Size (byte)	Data type	Access	Default value	Value range	Offset / gradient	Data storage	Range limits
66	Sim. current	0x0042	4	Float32	r/w	0		-	No	3.6 - 23.0
67	Unit changeover	0x0043	1	UInteger	r/w	0 = mbar	0 ~ mbar 1 ~ bar 2 ~ mmH2O 3 ~ mH2O 4 ~ ftH2O 5 ~ inH2O 6 ~ Pa 7 ~ kPa 8 ~ MPa 9 ~ psi 10 ~ mmHg 11 ~ inHg 12 ~ kgf / cm ²	-	Yes	-
68	Zero point configuration (ZRO)	0x0044	4	Float32	r/w	0	0 mbar	-	Yes	-
69	Zero point adoption (GTZ)	0x0045	1	unit	w	-	-	-	No	-
70	Damping (TAU)	0x0046	4	Float32	r/w	2 sec.	in 000.0 sec Default 2.0 sec	-	Yes	0.0 - 999.0
73	Pressure applied for 4mA (GTL)	0x0049	1	unit	w	-	-	-	No	-
74	Pressure applied for 20mA (GTU)	0x004A	1	unit	w	-	-	-	No	-
75	Alarm current (FCU)	0x004B	1	unit	r/w	MAX	0 ~ MIN 1 ~ MAX 2 ~ HOLD	-	Yes	0 - 2
76	Simulation mode	0x004C	1	UInteger	r/w	0 = OFF	0 ~ OFF 1 ~ Sim. Pressure 2 ~ Sim current 3 ~ Sim. Error no. 4 ~ Sim. Level	-	No	0 - 4
77	Measuring mode	0x004D	1	UInteger	r/w	0 = Pressure	0 ~ Pressure 1 ~ Level	-	Yes	0 - 1
78	Temp Unit changeover	0x004E	1	UInteger	r/w	0 = °C	0 ~ °C 1 ~ °F 2 ~ K	-	Yes	0 - 2

ISDU (dec)	Designation	ISDU (hex)	Size (byte)	Data type	Access	Default value	Value range	Offset / gradient	Data storage	Range limits
79	Unit before lin.	0x004F	1	UInteger	r/w	0 = %	0 ~ % 1 ~ mm 2 ~ cm 3 ~ m 4 ~ inch 5 ~ ft 6 ~ m ³ 7 ~ inch ³ 8 ~ ft ³ 9 ~ l 10 ~ hl 11 ~ kg 12 ~ t 13 ~ lb 14 ~ (US) gal 15 ~ (Imp) gal	-	Yes	0 - 15
80	Calibration mode	0x0050	1	UInteger	r/w	0 = Wet	0 ~ Wet 1 ~ Dry	-	No	0 - 1
81	Reset peakhold	0x0051	1	UInteger	w	-	-	-	No	-
82	Hi Max value (maximum indicator)	0x0052	4	Float32	r	-	-	-	No	-
83	Lo Min value (minimum indicator)	0x0053	4	Float32	r	-	-	-	No	-
84	Revisioncounter (RVC)	0x0054	2	UInteger16	r	-	-	-	No	-
94	Unlocking code	0x005E	2	UInteger	w	0000	-	-	Yes	-
256	Device Type	0x0100	2	UInteger16	r	Cerabar = 0x9219 Deltapilot = 0x9123	-	-	-	-
257	ENP_VERSION	0x0101	16	String	r	02.03.00	-	-	No	-
259	Extended order code	0x0103	60	String	r	-	-	-	No	-
262	Order code	0x0106	32	String	r	-	-	-	No	-
263	Electr.serial no	0x0107	16	String	r	-	-	-	No	-
264	Sensor serial no	0x0108	16	String	r	-	-	-	No	-
265	Sim. pressure	0x0109	4	Float32	r/w	0	-	-	No	-
266	Sim. level	0x010A	4	Float32	r/w	0	-	-	No	-
267	Sim. error no.	0x010B	2	UInteger	r/w	0	-	-	No	-
268	LRL sensor	0x010C	4	Float32	r	0	-	-	No	-
269	URL sensor	0x010D	4	Float32	r	0	-	-	No	-
270	Meas. Pressure	0x010E	4	Float32	r	0	-	-	No	-
271	Sensor pressure	0x010F	4	Float32	r	0	-	-	No	-
272	Corrected press.	0x0110	4	Float32	r	0	-	-	No	-
273	Pressure af.damp	0x0111	4	Float32	r	0	-	-	No	-
274	Empty calib.	0x0112	4	Float32	r/w	0	-	-	Yes	-
275	Empty pressure	0x0113	4	Float32	r/w	0	-	-	Yes	-
276	Empty pressure	0x0114	4	Float32	r	0	-	-	No	-
277	Full calib.	0x0115	4	Float32	r/w	100.0	-	-	Yes	-
278	Full pressure	0x0116	4	Float32	r/w	0	-	-	Yes	-
279	Full pressure	0x0117	4	Float32	r	0	-	-	No	-

ISDU (dec)	Designation	ISDU (hex)	Size (byte)	Data type	Access	Default value	Value range	Offset / gradient	Data storage	Range limits
280	Level before Lin	0x0118	4	Float32	r	0	-	-	No	-
283	Output current	0x011B	4	Float32	r	0	-	-	No	-
284	Sensor temperature	0x011C	4	Float32	r	0	-	-	No	-
285	Operating hours	0x011D	4	UInteger	r	0	-	-	No	-
286	Lower Trim measured value	0x011E	4	Float32	r	0	-	-	No	-
287	Upper Trim measured value	0x011F	4	Float32	r	0	-	-	No	-
288	Lower Sensor trim	0x0120	4	Float32	r/w	0	-	-	No	-
289	Upper Sensor trim	0x0121	4	Float32	r/w	0	-	-	No	-
291	Current Output	0x0123	1	UInteger	r/w	1 = ON	0 ~ OFF 1 ~ ON	-	Yes	0 - 1
292	Device search	0x0124	1	UInteger	r/w	0 = OFF	0 ~ OFF 1 ~ ON	-	No	0 - 1
293	Alarm behaviour for pressure	0x0125	1	UInteger	r/w	0 = Warning	0 ~ Warning 1 ~ Error 2 ~ NAMUR	-	No	0 - 2
298	Display measured value format	0x012A	1	UIntegerT	r/w	-	0 = x 1 = x.x 2 = x.xx 3 = x.xxx 4 = x.xxxx 5 = x.xxxxx 6 = Auto	-	No	-
71 294	Lower Range Value for 4 mA	0x0047 0x0126	4	Float32	r/w	0	-	-	Yes	-
71 295	Upper Range Value for 20 mA	0x0048 0x0127	4	Float32	r/w	100.0	-	-	Yes	-

The parameter settings can be made via IO-Link and the display. The following table lists the fault responses if incorrect parameter values are set or if a limit value is overshoot due to a correction of the calibration offset.

Setting via IO-Link

Parameter	Check against	Fault response
LRV	Current output limits	Value is rejected
URV	Current output limits	Value is rejected
Switch point ¹⁾	Switch output limits	Value is rejected
Calibration offset ²⁾	Current output limits	M431 is displayed
Calibration offset ²⁾	Switch output limits	Value is rejected

1) Switch point can only be configured via IO-Link.

2) The check is also performed if the current output and/or switch output is disabled.

Configuration via local display

Parameter	Check against	Fault response
LRV	Current output limits	M431 is displayed
URV	Current output limits	M431 is displayed

Parameter	Check against	Fault response
Calibration offset ¹⁾	Current output limits	M431 is displayed
Calibration offset ¹⁾	Switch output limits	M431 is displayed

1) The check is also performed if the current output and/or switch output is disabled.

7.2.2 IO-Link-specific device data

ISDU (dec)	Designation	ISDU (hex)	Size (byte)	Data type	Access	Default value	Value range	Data storage
7 ... 8	VendorId	0x0007 to 0x0008			r	17		No
9 ... 11	DeviceID	0x0009 to 0x000B			r	Cerabar: 0x000800 Deltapilot: 0x000900		
12	Device Access Locks.Local Parameterization	0x000C	2	UIntegerT	r/w	0	0 = Unlocked 1 = Locked	No
16	VendorName	0x0010	max. 64	String	r	Endress+Hauser		-
17	VendorText	0x0011	max. 64	String	r	People for Process Automation		-
18	ProductName	0x0012	max. 64	String	r	Cerabar Deltapilot		-
19	ProductID	0x0013	max. 64	String	r	PMx5x FMB50		-
20	ProductText	0x0014	max. 64	String	r	Absolute and gauge pressure		-
21	Serial number	0x0015	max. 16	String	r	-		-
22	Hardware Revision	0x0016	max. 64	String	r	-		-
23	Firmware Version	0x0017	max. 64	String	r	-		-
24	Application Specific Tag	0x0018	32	String	r/w	-		Yes
25	Function Tag	0x0019	32	String	r/w	***		-
26	Location Tag	0x001A	32	String	r/w	***		-
36	Device status	0x0024	1	UIntegerT	r/w	-	0 ~ Device is OK 1 ~ Maintenance required 2 ~ Out of specification 3 ~ Functional check 4 ~ Failure	No
37	Detailed Device Status	0x0025	5 (per 1 byte)	OctetString	r	-	-	No
260	Actual Diagnostics (STA)	0x0104	4	String	r	-		No
261	Last Diagnostic (LST)	0x0105	4	String	r	-		No
Teach - Single value								
58	Teach Select	0x003A	1	UIntegerT	r/w	1	-	No
59	Teach Result State	0x003B	1	UIntegerT	r/w	-	-	No
Switching Signal Channel 1.1 Pressure								
60	SSC1.1 Param.SP1	0x003C	4	Float32T	r/w	Sensor/product-dependent	Sensor/product-dependent	Yes

ISDU (dec)	Designation	ISDU (hex)	Size (byte)	Data type	Access	Default value	Value range	Data storage
60	SSC1.1 Param.SP2	0x003C	4	Float32T	r/w	Sensor/product-dependent	Sensor/product-dependent	Yes
61	SSC1.1 Config.Logic	0x003D	1	UIntegerT	r/w	0	0 = High active 1 = Low active	Yes
61	SSC1.1 Config.Mode	0x003D	1	UIntegerT	r/w	0	0 = Deactivated 1 = Single point 2 = Window 3 = Two-point	Yes
61	SSC1.1 Config.Hyst	0x003D	4	Float32T	r/w	10.0	Sensor/product-dependent	Yes
Switching Signal Channel 1.2 Pressure								
62	SSC1.2 Param.SP1	0x003E	4	Float32T	r/w	Sensor/product-dependent	Sensor/product-dependent	Yes
62	SSC1.2 Param.SP2	0x003E	4	Float32T	r/w	Sensor/product-dependent	Sensor/product-dependent	Yes
63	SSC1.2 Config.Logic	0x003F	1	UIntegerT	r/w	0	0 = High active 1 = Low active	Yes
63	SSC1.2 Config.Mode	0x003F	1	UIntegerT	r/w	0	0 = Deactivated 1 = Single point 2 = Window 3 = Two-point	Yes
63	SSC1.2 Config.Hyst	0x003F	4	Float32T	r/w	10.0	Sensor/product-dependent	Yes
Switching Signal Channel 2.1 Level								
16396	SSC2.1 Param.SP1	0x400C	4	Float32T	r/w	100.0	Sensor/product-dependent	Yes
16396	SSC2.1 Param.SP2	0x400C	4	Float32T	r/w	0.0	Sensor/product-dependent	Yes
16397	SSC2.1 Config.Logic	0x400D	1	UIntegerT	r/w	0	0 = High active 1 = Low active	Yes
16397	SSC2.1 Config.Mode	0x400D	1	UIntegerT	r/w	0	0 = Deactivated 1 = Single point 2 = Window 3 = Two-point	Yes
16397	SSC2.1 Config.Hyst	0x400D	4	Float32T	r/w	10.0	Sensor/product-dependent	Yes
Switching Signal Channel 2.2 Level								
16398	SSC2.2 Param.SP1	0x400E	4	Float32T	r/w	100.0	Sensor/product-dependent	Yes
16398	SSC2.2 Param.SP2	0x400E	4	Float32T	r/w	0.0	Sensor/product-dependent	Yes
16399	SSC2.2 Config.Logic	0x400F	1	UIntegerT	r/w	0	0 = High active 1 = Low active	Yes
16399	SSC2.2 Config.Mode	0x400F	1	UIntegerT	r/w	0	0 = Deactivated 1 = Single point 2 = Window 3 = Two-point	Yes
16399	SSC2.2 Config.Hyst	0x400F	4	Float32T	r/w	10.0	Sensor/product-dependent	Yes
Switching Signal Channel 3.1 Temperature								
16412	SSC3.1 Param.SP1	0x401C	4	Float32T	r/w	100.0	Sensor/product-dependent	Yes
16412	SSC3.1 Param.SP2	0x401C	4	Float32T	r/w	0.0	Sensor/product-dependent	Yes
16413	SSC3.1 Config.Logic	0x401D	1	UIntegerT	r/w	0	0 = High active 1 = Low active	Yes

ISDU (dec)	Designation	ISDU (hex)	Size (byte)	Data type	Access	Default value	Value range	Data storage
16413	SSC3.1 Config.Mode	0x401D	1	UIntegerT	r/w	0	0 = Deactivated 1 = Single point 2 = Window 3 = Two-point	Yes
16413	SSC3.1 Config.Hyst	0x401D	4	Float32T	r/w	5.0	Sensor/product-dependent	Yes
Switching Signal Channel 3.2 Temperature								
16414	SSC3.2 Param.SP1	0x401E	4	Float32T	r/w	100.0	Sensor/product-dependent	Yes
16414	SSC3.2 Param.SP2	0x401E	4	Float32T	r/w	0.0	Sensor/product-dependent	Yes
16415	SSC3.2 Config.Logic	0x401F	1	UIntegerT	r/w	0	0 = High active 1 = Low active	Yes
16415	SSC3.2 Config.Mode	0x401F	1	UIntegerT	r/w	0	0 = Deactivated 1 = Single point 2 = Window 3 = Two-point	Yes
16415	SSC3.2 Config.Hyst	0x401F	4	Float32T	r/w	5.0	Sensor/product-dependent	Yes
16512	Pressure Descr. Lower limit	0x4080	4	Float32T	r	0	-	No
16512	Pressure Descr. Upper limit	0x4080	4	Float32T	r	0	-	No
16512	Pressure Descr. Unit	0x4080	2	UIntegerT	r	1137 (bar)	-	No
16512	Pressure Descr. Scale	0x4080	1	Integer T	r	0	-	No
16513	Level Descr. Lower limit	0x4081	4	Float32T	r	0	-	No
16513	Level Descr. Upper limit	0x4081	4	Float32T	r	100	-	No
16513	Level Descr. Unit	0x4081	2	UIntegerT	r	1142 (%)	-	No
16513	Level Descr. Scale	0x4081	1	IntegerT	r	0	-	No
16514	Temperature Descr. Lower limit	0x4082	4	Float32T	r	0	-	No
16514	Temperature Descr. Upper limit	0x4082	4	Float32T	r	0	-	No
16514	Temperature Descr. Unit	0x4082	2	UIntegerT	r	1001 (C°)	-	No
16514	Temperature Descr. Scale	0x4082	1	IntegerT	r	0	-	No

7.2.3 System commands

ISDU (dec)	Designation	ISDU (hex)	Value range	Access
2	Teach SP1	0x0002	65	w
2	Teach SP2	0x0002	66	w
2	Reset to factory settings (RES)	0x0002	130	w
2	Device Reset	0x0002	128	w
2	Back-To-Box	0x0002	131	w

7.2.4 Switching signals

The switching signals provide a simple way of monitoring the measured values for limit violations.

Each switching signal is clearly assigned to a process value and provides a status. This status is transmitted with the process data (process data link). The switching behavior of this status must be configured using the configuration parameters of a "Switching Signal Channel" (SSC). In addition to manual configuration for switch points SP1 and SP2, a teach mechanism is available in the "Teach" menu. This writes the current process value into the selected SSC via a system command. The following section describes the different behaviors of the modes that can be selected. The "Logic" parameter is always "High active". If the logic is to be inverted, the "Logic" parameter can be set to "Low active".

7.2.5 Single Point Mode

SP2 is not used in this mode.

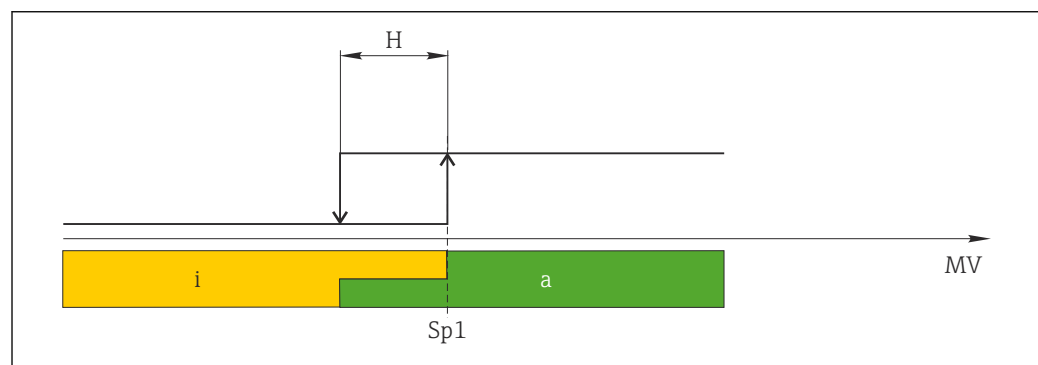

1 SSC, Single Point

H Hysteresis
Sp1 Switch point 1
MV Measured value
i inactive (orange)
a active (green)

7.2.6 Window Mode

SP_{hi} always corresponds to whichever value is higher, SP1 or SP2, and SP_{lo} always corresponds to whichever value is lower, SP1 or SP2.

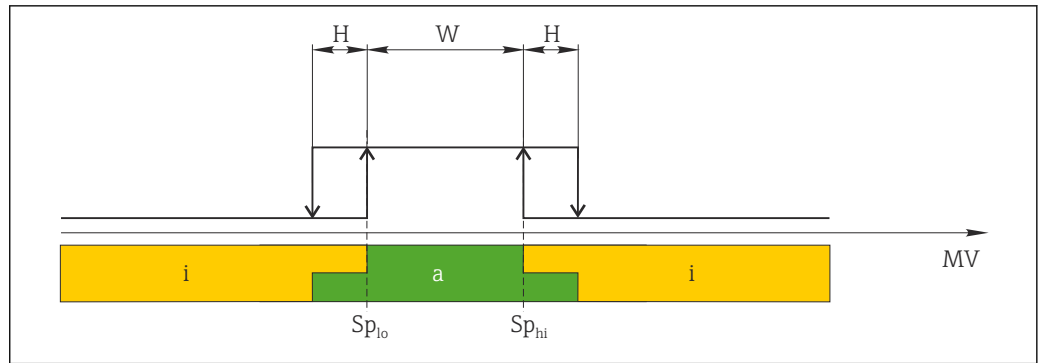

A0046579

2 SSC, Window

- H Hysteresis
- W Window
- Sp_{lo} Switch point with lower measured value
- Sp_{hi} Switch point with higher measured value
- MV Measured value
- i inactive (orange)
- a active (green)

7.2.7 Two-point Mode

Sp_{hi} always corresponds to whichever value is higher, $SP1$ or $SP2$, and Sp_{lo} always corresponds to whichever value is lower, $SP1$ or $SP2$.

Hysteresis is not used.

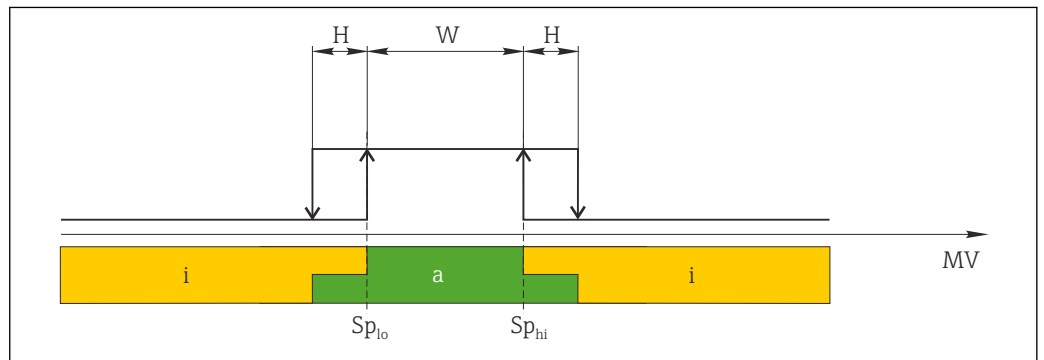

A0046579

3 SSC, Two-Point

- Sp_{lo} Switch point with lower measured value
- Sp_{hi} Switch point with higher measured value
- MV Measured value
- i inactive (orange)
- a active (green)

8 Commissioning

The device is configured for the "Pressure" measuring mode (Cerabar) or "Level" measuring mode (Deltapilot) as standard.

The measuring range and the unit in which the measured value is transmitted correspond to the specifications on the nameplate.

⚠ WARNING

The permitted process pressure is exceeded!

Risk of injury if parts burst! Warnings are displayed if the pressure is too high.

- ▶ If a pressure smaller than the minimum permitted pressure or greater than the maximum permitted pressure is present at the device, the following messages are output in succession (depending on the setting in the "Alarm behavior" (050) parameter): "S140 Working range P" or "F140 Working range P" "S841 Sensor range" or "F841 Sensor range" "S971 Adjustment"
- ▶ Only use the device within the measuring cell range limits!

NOTICE

The permitted process pressure is undershot!

Messages are displayed if the pressure is too low.

- ▶ If a pressure smaller than the minimum permitted pressure or greater than the maximum permitted pressure is present at the device, the following messages are output in succession (depending on the setting in the "Alarm behavior" (050) parameter): "S140 Working range P" or "F140 Working range P" "S841 Sensor range" or "F841 Sensor range" "S971 Adjustment"
- ▶ Only use the device within the measuring cell range limits!

8.1 Function check

Before commissioning your measuring point, ensure that the post-installation and post-connection checks have been performed:

- "Post-installation check" checklist → 📄 28
- "Post-connection check" checklist → 📄 31

8.2 Unlocking/locking configuration

If the device is locked to prevent configuration, it must first be unlocked.





8.2.1 Locking/unlocking software

If the device is locked via the software (device access code), the key symbol appears in the measured value display. If an attempt is made to write to a parameter, a prompt for the device access code appears. To unlock, enter the user-defined device access code.

8.3 Commissioning without an operating menu

8.3.1 Pressure measuring mode

The following functions are possible via the keys on the electronic insert:

- Position adjustment (zero point correction)
- Setting the lower range value and upper range value
- Device reset →  40
-  ▪ Operation must be unlocked →  39
- The device is configured for the "Pressure" measuring mode as standard. You can change the measuring mode via the "Measuring mode" parameter →  53.
- The pressure applied must be within the nominal pressure limits of the measuring cell. See information on the nameplate.

WARNING

Changing the measuring mode affects the span (URV)!

This situation can result in product overflow.

- ▶ If the measuring mode is changed, the span setting (URV) must be verified and, if necessary, reconfigured!

Carrying out position adjustment

1. Make sure that pressure is present at the device. In doing so, pay attention to the nominal pressure limits of the measuring cell.
2. Press the **Zero** and **Span** keys simultaneously for at least 3 s.

LED on the electronic insert is lit briefly.

The applied pressure for position adjustment has been accepted.

Setting lower range value

1. Make sure the desired pressure for the lower range value is present at the device. In doing so, pay attention to the nominal pressure limits of the measuring cell.
2. Press the **Zero** key for at least 3 s.

LED on the electronic insert is lit briefly.

The applied pressure for the lower range value has been accepted.

Setting upper range value





1. Make sure the desired pressure for the upper range value is present at the device. In doing so, pay attention to the nominal pressure limits of the measuring cell.
2. Press the **Span** key for at least 3 s.

LED on the electronic insert is lit briefly.

The applied pressure for the upper range value has been accepted.

8.3.2 Level measuring mode

The following functions are possible via the keys on the electronic insert:

- Position adjustment (zero point correction)
 - Setting the lower and upper pressure value and assigning to the lower and upper level value
 - Device reset →  40
-  ■ The "Zero" and "Span" keys only have a function with the following setting: "Level selection" = "In pressure", "Calibration mode" = "Wet"
The keys have no function in other settings.
- The device is configured for the "Pressure" measuring mode as standard. You can change the measuring mode via the "Measuring mode" parameter →  53.
The following parameters are set to the following values at the factory:
 - "Level selection" = "In pressure"
 - "Calibration mode": wet
 - "Unit before lin": %
 - "Empty calib.": 0.0
 - "Full calib.": 100.0
 - "Set LRV": 0.0 (corresponds to 4 mA value)
 - "Set URV": 100.0 (corresponds to 20 mA value)
 - Operation must be unlocked →  39.
 - The pressure applied must be within the nominal pressure limits of the measuring cell. See information on the nameplate.

WARNING

Changing the measuring mode affects the span (URV)!

This situation can result in product overflow.

- ▶ If the measuring mode is changed, the span setting (URV) must be verified and, if necessary, reconfigured!

Carrying out position adjustment

1. Make sure that pressure is present at the device. In doing so, pay attention to the nominal pressure limits of the measuring cell.
2. Press the **Zero** and **Span** keys simultaneously for at least 3 s.

LED on the electronic insert is lit briefly.

The applied pressure for position adjustment has been accepted.

Setting lower pressure value

1. Make sure that the desired lower pressure value ("Empty pressure value") is present at the device. In doing so, pay attention to the nominal pressure limits of the measuring cell.
2. Press the **Zero** key for at least 3 s.

LED on the electronic insert is lit briefly.

The applied pressure was saved as the lower pressure value ("Empty pressure") and assigned to the lower level value ("Empty calibration").

Setting upper pressure value





1. Make sure that the desired upper pressure value ("Full pressure value") is present at the device. In doing so, pay attention to the nominal pressure limits of the measuring cell.
2. Press the **Span** key for at least 3 s.

LED on the electronic insert is lit briefly.

The applied pressure was saved as the upper pressure value ("Full pressure") and assigned to the upper level value ("Full calibration").



8.4 Commissioning with an operating menu

Commissioning comprises the following steps:

- Function check →  50
- Selection of the language, measuring mode and pressure unit →  53
- Position adjustment/zero adjustment →  54
- Configuring measurement:
 - Pressure measurement →  59
 - Level measurement →  55

8.4.1 Selection of the language, measuring mode and pressure unit

Language (000)

Navigation	  Main menu → Language
Write permission	Operator/Maintenance/Expert
Description	Select the menu language for the local display.
Selection	<ul style="list-style-type: none"> ■ English ■ Another language (as selected when ordering the device) ■ A third language where applicable (language of the place of manufacture)
Factory setting	English

Measuring mode (005)



Write permission	Operator/Maintenance/Expert
Description	<p>Select the measuring mode. The operating menu is structured differently depending on the measuring mode selected.</p> <p> WARNING</p> <p>Changing the measuring mode affects the span (URV) This situation can result in product overflow.</p> <ul style="list-style-type: none"> ▶ If the measuring mode is changed, the setting for the span (URV) must be checked in the "Setup" operating menu and readjusted if necessary.
Selection	<ul style="list-style-type: none"> ■ Pressure ■ Level
Factory setting	Pressure or according to order specifications

Press. eng. unit (125)

Write permission	Operator/Maintenance/Expert
-------------------------	-----------------------------

Description	Select the pressure unit. If a new pressure unit is selected, all pressure-specific parameters are converted and displayed with the new unit.
Selection	<ul style="list-style-type: none"> ■ mbar, bar ■ mmH₂O, mH₂O ■ inH₂O, ftH₂O ■ Pa, kPa, MPa ■ psi ■ mmHg, inHg ■ kgf/cm² V
Factory setting	mbar or bar depending on the nominal measuring range of the measuring cell, or as per order specifications.

8.4.2 Pos. zero adjust

Corrected press. (172)	
Navigation	  Setup → Corrected press.
Write permission	Operator/Maintenance/Expert
Description	Displays the measured pressure after sensor trim and position adjustment.
Note	If this value is not equal to "0", it can be corrected to "0" by the position adjustment.

Pos. zero adjust (007) (gauge pressure measuring cells)	
Write permission	Operator/Maintenance/Expert
Description	Pos. zero adjustment – the pressure difference between zero (set point) and the measured pressure need not be known.
Example	<ul style="list-style-type: none"> ■ Measured value = 2.2 mbar (0.033 psi) ■ You correct the measured value via the "Pos. zero adjust" parameter with the "Confirm" option. This means that you are assigning the value 0.0 to the pressure present. ■ Measured value (after pos. zero adjust) = 0.0 mbar ■ The current value is also corrected.
Selection	<ul style="list-style-type: none"> ■ Confirm ■ Cancel
Factory setting	Cancel

Pos. zero adjust (007) (gauge pressure measuring cells)



Write permission	Operator/Maintenance/Expert
Description	Pos. zero adjustment – the pressure difference between zero (set point) and the measured pressure need not be known.
Example	<ul style="list-style-type: none"> ▪ Measured value = 2.2 mbar (0.033 psi) ▪ You correct the measured value via the "Pos. zero adjust" parameter with the "Confirm" option. This means that you are assigning the value 0.0 to the pressure present. ▪ Measured value (after pos. zero adjust) = 0.0 mbar ▪ The current value is also corrected.
Selection	<ul style="list-style-type: none"> ▪ Confirm ▪ Cancel
Factory setting	Cancel

8.5 Configuring level measurement

8.5.1 Information on level measurement

-  The limit values are not checked, i.e. the values entered must be appropriate for the measuring cell and the measuring task for the device to be able to measure correctly.
 - Customer-specific units are not possible.
 - There is no unit conversion.
 - The values entered for "Empty calib./Full calib.", "Empty pressure/Full pressure" and "Set LRV/Set URV" must be at least 1% apart. The value will be rejected, and a message displayed, if the values are too close together.

8.5.2 Overview of level measurement

Measuring task	Level selection	Measured variable options	Description	Measured value display
Calibration is performed by entering two pressure-level value pairs.	"In pressure"	Via the "Output unit" parameter: %, level, volume or mass units.	<ul style="list-style-type: none"> ▪ Calibration with reference pressure (wet calibration) →  55 ▪ Calibration without reference pressure (dry calibration) →  57 	The measured value display shows the measured value.

8.5.3 "In pressure" level selection: calibration with reference pressure (wet calibration)

Example:

In this example, the level in a tank should be measured in "m". The maximum level is 3 m (9.8 ft).

The pressure range is derived from the level and the density of the medium. In this case, the device sets the pressure range to 0 to 300 mbar (0 to 4.5 psi).

Prerequisite:

- The measured variable is in direct proportion to the pressure.
- The tank can be filled and emptied.

i The values entered for "Empty calib./Full calib." and "Set LRV/Set URV" and the applied pressures must be at least 1% apart. The value will be rejected, and a message displayed, if the values are too close together. Additional limit values are not checked, i.e. the values entered must be appropriate for the measuring cell and the measuring task for the device to be able to measure correctly.

Description	
1	Perform a "position adjustment" → 54.
2	Select the "Level" measuring mode via the "Measuring mode" parameter. Menu path: Setup → Measuring mode WARNING Changing the measuring mode affects the span (URV) This situation can result in product overflow. ► If the measuring mode is changed, the setting for the span (URV) must be checked in the "Setup" operating menu and readjusted if necessary.
3	Select a pressure unit via the "Press eng. unit" parameter, here "mbar" for example. Menu path: Setup → Press eng. unit
4	Select the "In pressure" level mode via the "Level selection" parameter. Menu path: Setup → Extended setup → Level → Level selection.
5	Select a level unit via the "Output unit" parameter, e.g. here "m" for example. Menu path: Setup → Extended setup → Level → Output unit
6	Select the "Wet" option via the "Calibration mode" parameter. Menu path: Setup → Extended setup → Level → Calibration mode
7	If the calibration is performed with a medium other than the process medium, enter the density of the calibration medium in the "Adjust density" parameter. Menu path: Setup → Extended setup → Level → Adjust density
8	The pressure for the lower calibration point is present at the device, here "0 mbar" for example. Select the "Empty calib." parameter. Menu path: Setup → Extended setup → Level → Empty calib. Enter the level value, here 0 m for example. By confirming the value, you assign the pressure value present to the lower level value.
9	The pressure for the upper calibration point is present at the device, here 300 mbar (4.35 psi) for example. Select the "Full calib." parameter. Menu path: Setup → Extended setup → Level → Full calib. Enter the level value, here 3 m (9.8 ft) for example. By confirming the value, you assign the pressure value present to the upper level value.
10	Use the "Set LRV" parameter to set the level value for the lower current value (4 mA), here "0 m" for example. Menu path: Setup → Extended setup → Current output → Set LRV
11	Use the "Set URV" parameter to set the level value for the upper current value (20 mA) (3 m (9.8 ft)). Menu path: Setup → Extended setup → Current output → Set URV

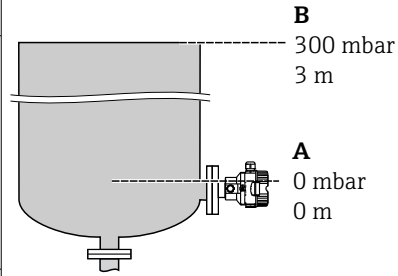

A See table, step 7.
B See table, step 8.

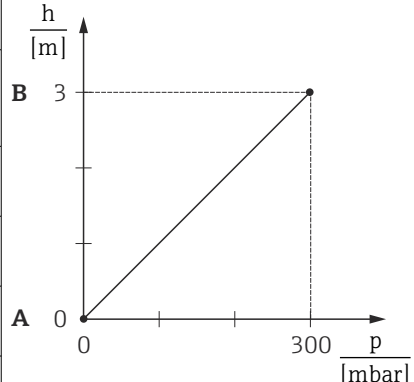

A0017658

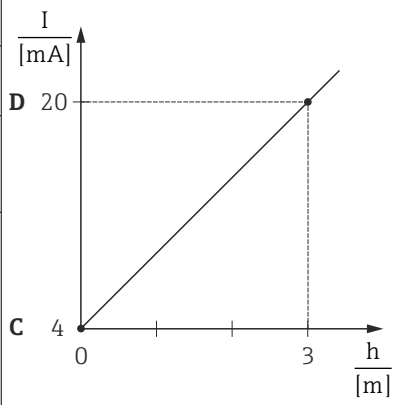

A See table, step 8.
B See table, step 9.
C See table, step 10.
D See table, step 11.

A0031063

Description	
12	If the process uses a different medium to the medium on which the calibration was based, the new density must be specified in the "Process density" parameter. Menu path: Setup → Extended setup → Level → Process density.
13	Result: The measuring range is configured for 0 to 3 m (0 to 9.8 ft).

i In this level mode, you can choose from the measured variables %, level, volume and mass, see the "Output unit" → 80.

8.5.4 "In pressure" level selection: calibration without reference pressure (dry calibration)

Example:

In this example, the volume in a tank should be measured in liters. The maximum volume of 1000 l (264 gal) corresponds to a pressure of 450 mbar (6.75 psi).
The minimum volume of 0 liters corresponds to a pressure of 50 mbar (0.75 psi), since the device is mounted below the start of the level measuring range.

Prerequisite:

- The measured variable is in direct proportion to the pressure.
 - This is a theoretical calibration i.e. the pressure and volume values for the lower and upper calibration point must be known.
- i**
- The values entered for "Empty calib./Full calib.", "Empty pressure/Full pressure" and "Set LRV/Set URV" must be at least 1% apart. The value will be rejected, and a message displayed, if the values are too close together. Additional limit values are not checked, i.e. the values entered must be appropriate for the measuring cell and the measuring task for the device to be able to measure correctly.
 - Due to the orientation of the device, there may be pressure shifts in the measured value, i.e. when the vessel is empty or partly filled, the measured value is not zero. For information on how to perform position adjustment, see → 54.

Description	
1	Select the "Level" measuring mode via the "Measuring mode" parameter. Menu path: Setup → Measuring mode ⚠ WARNING Changing the measuring mode affects the span (URV) This situation can result in product overflow. ► If the measuring mode is changed, the setting for the span (URV) must be checked in the "Setup" operating menu and readjusted if necessary.
2	Select the "In pressure" level mode via the "Level selection" parameter. Menu path: Setup → Extended setup → Level → Level selection.
3	Select a pressure unit via the "Press eng. unit" parameter, here "mbar" for example. Menu path: Setup → Press eng. unit
4	Select a volume unit via the "Output unit" parameter, here "l" (liters) for example. Menu path: Setup → Extended setup → Level → Output unit
5	Select the "Dry" option via the "Calibration mode" parameter. Menu path: Setup → Extended setup → Level → Calibration mode

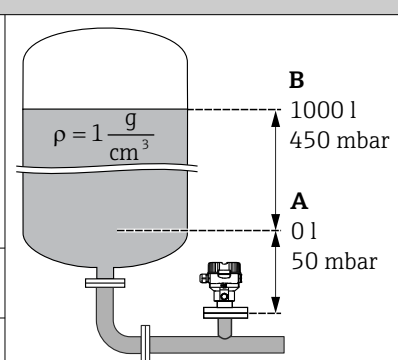



A See table, steps 6 and 7.

B See table, steps 8 and 9.

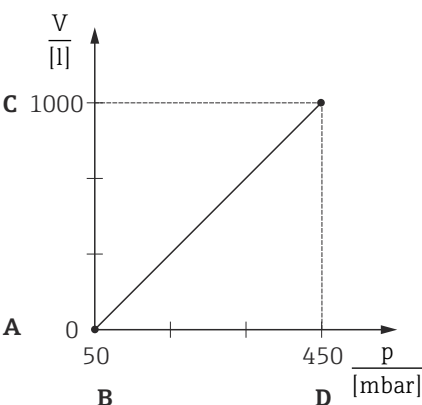
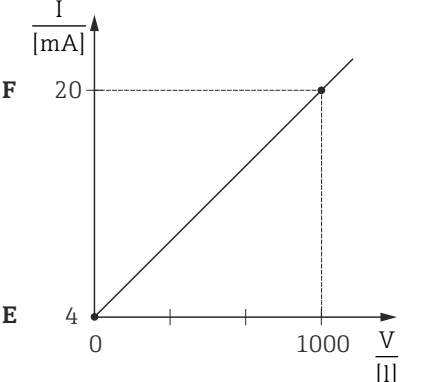
A0030030

	Description	
6	Enter the volume value for the lower calibration point via the "Empty calib." parameter, here 0 liters for example. Menu path: Setup → Extended setup → Level → Empty calib.	 <p>A0031028</p>
7	Enter the pressure value for the lower calibration point via the "Empty pressure" parameter, here "50 mbar (0.75 psi)" for example. Menu path: Setup → Extended setup → Level → Empty pressure	
8	Enter the volume value for the upper calibration point via the "Full calib." parameter, here 1000 l (264 gal) for example. Menu path: Setup → Extended setup → Level → Full calib.	
9	Enter the pressure value for the upper calibration point via the "Full pressure" parameter, here 450 mbar (6.75 psi) for example. Menu path: Setup → Extended setup → Level → Full pressure	
10	"Adjust density" contains the factory setting 1.0 but can be changed if required. The value pairs subsequently entered must correspond to this density. Menu path: Setup → Extended setup → Level → Adjust density	 <p>A0031064</p>
11	Set the volume value for the lower current value (4 mA) via the "Set LRV" parameter (0 l). Menu path: Setup → Extended setup → Current output → Set LRV	
12	Set the volume value for the upper current value (20 mA) via the "Set URV" parameter (1000 l (264 gal)). Menu path: Setup → Extended setup → Current output → Set URV	
13	If the process uses a different medium to the medium on which the calibration was based, the new density must be specified in the "Process density" parameter. Menu path: Setup → Extended setup → Current output → Process density.	
14	Result: The measuring range is configured for 0 to 1000 l (0 to 264 gal).	<p>E See table, step 11 F See table, step 12</p>

 In this level mode, you can choose from the measured variables %, level, volume and mass, see the "Output unit" →  80.

8.5.5 Calibration with partially filled vessel (wet calibration)

Example:

This example explains a wet calibration for situations in which it is not possible to empty the vessel and then fill it to 100%.

During this wet calibration, a level of 20% is used as the calibration point for "Empty" and a level of "25%" is used as the calibration point for "Full".

The calibration is then extended to 0% to 100% and the lower range value (LRV)/upper range value (URV) are adapted accordingly.

Prerequisite:

- The default value in the level mode for the calibration mode is "Wet".
- This value can be configured: Menu path: Setup → Extended setup → Level → Calibration mode

Description	
<p>1 Select the "Level" measuring mode via the "Measuring mode" parameter. Menu path: Setup → Measuring mode</p> <p>⚠ WARNING</p> <p>Changing the measuring mode affects the span (URV) This situation can result in product overflow.</p> <ul style="list-style-type: none"> ▶ If the measuring mode is changed, the setting for the span (URV) must be checked in the "Setup" operating menu and readjusted if necessary. 	<p style="text-align: right; font-size: small;">A0030031</p> <p>A See table, step 2 B See table, step 3</p>
<p>2 Set the value for "Empty calib." with the differential pressure for the level, e.g. 20% Menu path: Setup → Extended setup → Level → Empty calib.</p>	
<p>3 Set the value for "Full calib." with the differential pressure for the level, e.g. 25%. Menu path: Setup → Extended setup → Level → Full calib.</p>	
<p>4 The values for the pressure when the vessel is full or empty are measured automatically during adjustment. As the transmitter automatically sets the pressure values that are best suited for an "Empty calibration" and a "Full calibration" to the minimum and maximum pressure that triggers the output current, the correct upper range value (URV) and lower range value (LRV) must be set.</p>	

8.6 Configuring pressure measurement

8.6.1 Calibration without reference pressure (dry calibration)

Example:

In this example, a device with a 400 mbar (6 psi) measuring cell is configured for the 0 to +300 mbar (0 to 4.5 psi) measuring range, i.e. the 4 mA value and 20 mA value are assigned 0 mbar and 300 mbar (4.5 psi) respectively.

Prerequisite:

This is a theoretical calibration, i.e. the pressure values for the lower and upper range are known.

- i** Due to the orientation of the device, there may be pressure shifts in the measured value, i.e. the measured value is not zero in an unpressurized state. For information on how to perform position adjustment, see → 54.

Description	
1	<p>Select the "Pressure" measuring mode via the "Measuring mode" parameter. Menu path: Setup → Measuring mode</p> <p>⚠ WARNING Changing the measuring mode affects the span (URV) This situation can result in product overflow. ► If the measuring mode is changed, the setting for the span (URV) must be checked in the "Setup" operating menu and readjusted if necessary.</p>
2	Select a pressure unit via the "Press eng. unit" parameter, here "mbar" for example. Menu path: Setup → Press eng. unit
3	<p>Select the "Set LRV" parameter. Menu path: Setup → Set LRV</p> <p>Enter the value for the "Set LRV" parameter (here 0 mbar) and confirm. This pressure value is assigned to the lower current value (4 mA).</p>
4	<p>Select the "Set URV" parameter. Menu path: Setup → Set URV</p> <p>Enter the value for the "Set URV" parameter (here 300 mbar (4.5 psi)) and confirm. This pressure value is assigned to the upper current value (20 mA).</p>
5	<p>Result: The measuring range is configured for 0 to +300 mbar (0 to 4.5 psi).</p>

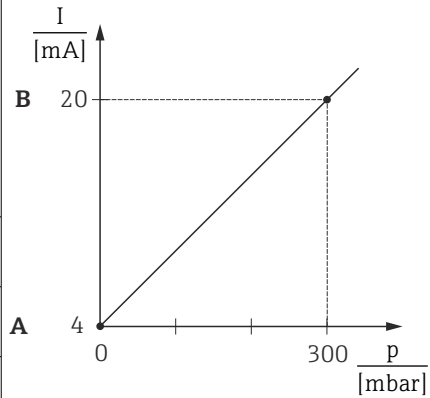

A See table, step 3.
B See table, step 4.

A0031032

8.6.2 Calibration with reference pressure (wet calibration)

Example:

In this example, a device with a 400 mbar (6 psi) measuring cell module is configured for the 0 to +300 mbar (0 to 4.5 psi) measuring range, i.e. the 4 mA value and 20 mA value are assigned 0 mbar and 300 mbar (4.5 psi) respectively.

Prerequisite:

The pressure values 0 mbar and 300 mbar (4.5 psi) can be specified. For example, the device is already installed.

 For a description of the parameters mentioned, see .

Description	
1	Perform a position adjustment →  54
2	Select the "Pressure" measuring mode via the "Measuring mode" parameter. Menu path: Setup → Measuring mode WARNING Changing the measuring mode affects the span (URV) This situation can result in product overflow. ► If the measuring mode is changed, the setting for the span (URV) must be checked in the "Setup" operating menu and readjusted if necessary.
3	Select a pressure unit via the "Press eng. unit" parameter, here "mbar" for example. Menu path: Setup → Press eng. unit
4	The pressure for the lower range value (4 mA value) is present at the device, here 0 mbar for example. Select the "Get LRV" parameter. Menu path: Setup → Extended setup → Current output → Get LRV Confirm the value present at the device by selecting "Confirm". The pressure value present is assigned to the lower current value (4 mA).
5	The pressure for the upper range value (20 mA value) is present at the device, here 300 mbar (4.5 psi) for example. Select the "Get URV" parameter. Menu path: Setup → Extended setup → Current output → Get URV Confirm the value present at the device by selecting "Confirm". The pressure value present is assigned to the upper current value (20 mA).
6	Result: The measuring range is configured for 0 to +300 mbar (0 to 4.5 psi).

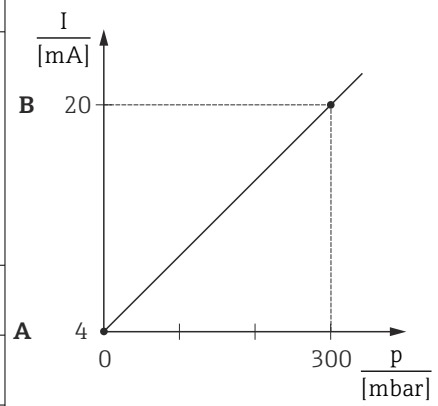

A See table, step 4.
B See table, step 5.

A0031032

8.7 Backing up or duplicating the device data

The device does not have a memory module. However, with an FDT technology-based operating tool (e.g. FieldCare) you can do the following:

- Save/recover configuration data
- Duplicate device configurations
- Transfer all relevant parameters when replacing electronic inserts
- The mechanism is based on IO-Link Data Storage

For more information, read the operating manual for the FieldCare operating program.

9 Maintenance

, keep the pressure compensation and GORE-TEX® filter (1) free from dirt.

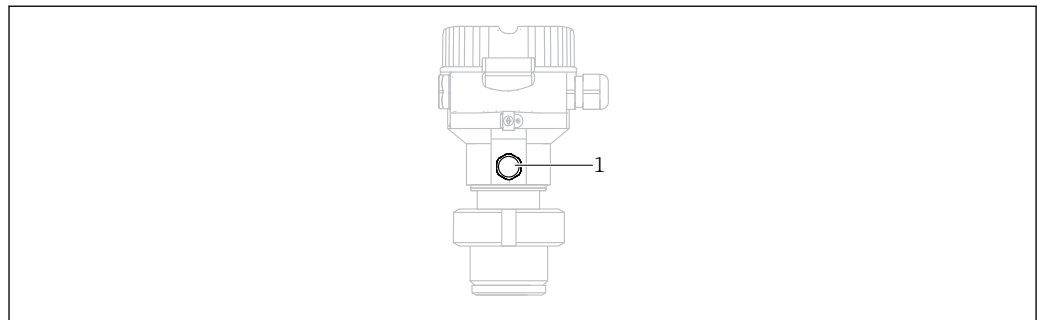

A0028502

9.1 Information on cleaning

Endress+Hauser provides flushing rings as an accessory to enable the membrane to be cleaned without removing the transmitter from the process.

For further information please contact your local Endress+Hauser Sales Center.

9.1.1 Cerabar M PMP55

We recommend you perform CIP (cleaning in place (hot water)) before SIP (sterilization in place (steam)) for pipe diaphragm seals. Frequent use of SIP cleaning increases the stress and strain on the membrane. Under unfavorable conditions, frequent changes of temperature can lead to membrane material fatigue and potentially leaks over the long term.

9.2 Exterior cleaning

Please note the following points when cleaning the device:

- The cleaning agents used should not corrode the surface and the seals.
- Mechanical damage to the membrane, e.g. due to pointed objects, must be avoided.
- Observe the degree of protection of the device. See the nameplate if necessary → 11.

10 Diagnostics and troubleshooting

10.1 Diagnostic events

10.1.1 Diagnostic message

Faults detected by the self-monitoring system of the measuring device are displayed as a diagnostic message in alternation with the measured value display.

Status signals

The messages that can occur are listed in the table. The ALARM STATUS parameter shows the message with the highest priority. The device has four different status information codes according to NE107:

F <small>A0013956</small>	"Failure" A device error has occurred. The measured value is no longer valid.
M <small>A0013957</small>	"Maintenance required" Maintenance is required. The measured value is still valid.
C <small>A0013959</small>	"Function check" The device is in the service mode (e.g. during a simulation).
S <small>A0013958</small>	"Out of specification" The device is being operated: <ul style="list-style-type: none"> ▪ Outside its technical specifications (e.g. during warm-up or cleaning). ▪ Outside of the configuration performed by the user (e.g. level outside the configured range)

Diagnostic event and event text

The fault can be identified by means of the diagnostic event.

The event text helps you by providing information about the fault.

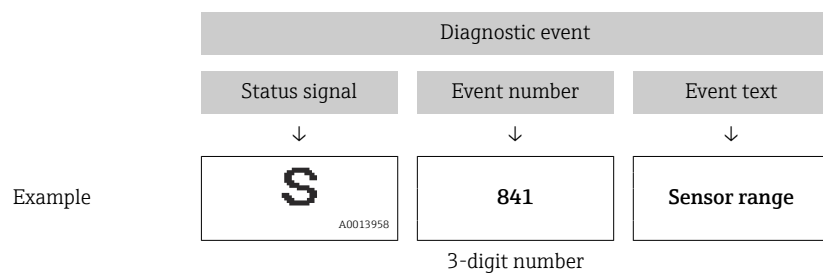

If two or more diagnostic events occur simultaneously, only the diagnostic message with the highest priority is shown.

Other diagnostic messages that are pending can be viewed in the **Diagnostic list** submenu.

 Past diagnostic messages that are no longer pending are shown in the **Event logbook** submenu.

10.1.2 List of diagnostic events

"C" messages

Diagnostic event		Cause	Remedial measure
Code	Description		
C482	Simul. output	Simulation of the current output is switched on, i.e. the device is not measuring at present.	End the simulation
C484	Error simul.	Fault state simulation is switched on, i.e. the device is not measuring at present.	End the simulation
C485	Measure simul.	Simulation is switched on, i.e. the device is not measuring at present.	End the simulation
C824	Process pressure	<ul style="list-style-type: none"> ▪ Overpressure or low pressure present. ▪ Electromagnetic effects are greater than specifications in the technical data. This message normally only appears briefly. 	<ul style="list-style-type: none"> ▪ Check the pressure value ▪ Restart the device ▪ Perform a reset

"F" messages

Diagnostic event		Cause	Remedial measure
Code	Description		
F002	Sens. unknown	Measuring cell does not suit the device (electronic measuring cell nameplate).	Contact Endress+Hauser Service
F062	Sensor conn.	<ul style="list-style-type: none"> ▪ Cable connection between measuring cell and main electronics disconnected. ▪ Measuring cell defective. ▪ Electromagnetic effects are greater than specifications in the technical data. This message normally only appears briefly. 	<ul style="list-style-type: none"> ▪ Check the measuring cell cable ▪ Replace the electronics module ▪ Contact Endress+Hauser Service ▪ Replace the measuring cell (snap-on version)
F081	Initialization	<ul style="list-style-type: none"> ▪ Cable connection between measuring cell and main electronics disconnected. ▪ Measuring cell defective. ▪ Electromagnetic effects are greater than specifications in the technical data. This message normally only appears briefly. 	<ul style="list-style-type: none"> ▪ Perform a reset ▪ Check the measuring cell cable ▪ Contact Endress+Hauser Service
F083	Memory content	<ul style="list-style-type: none"> ▪ Measuring cell defective. ▪ Electromagnetic effects are greater than specifications in the technical data. This message normally only appears briefly. 	<ul style="list-style-type: none"> ▪ Restart the device ▪ Contact Endress+Hauser Service
F140	Working range P	<ul style="list-style-type: none"> ▪ Overpressure or low pressure present. ▪ Electromagnetic effects are greater than specifications in the technical data. This message normally only appears briefly. ▪ Measuring cell defective. 	<ul style="list-style-type: none"> ▪ Check the process pressure ▪ Check the measuring cell range
F261	Electronics module	<ul style="list-style-type: none"> ▪ Main electronics defective. ▪ Fault in the main electronics. 	<ul style="list-style-type: none"> ▪ Restart the device ▪ Replace the electronics module
F282	Memory	<ul style="list-style-type: none"> ▪ Fault in the main electronics. ▪ Main electronics defective. 	<ul style="list-style-type: none"> ▪ Restart the device ▪ Replace the electronics module
F283	Memory content	<ul style="list-style-type: none"> ▪ Main electronics defective. ▪ Electromagnetic effects are greater than the specifications in the technical data. ▪ The supply voltage is disconnected when writing. ▪ An error occurred when writing. 	<ul style="list-style-type: none"> ▪ Perform a reset ▪ Replace the electronics module
F419	Current cycle	The Back-To-Box command is executed.	Restart the device
F841	Sensor range	<ul style="list-style-type: none"> ▪ Overpressure or low pressure present. ▪ Measuring cell defective. 	<ul style="list-style-type: none"> ▪ Check the pressure value ▪ Contact Endress+Hauser Service

"M" messages

Diagnostic event		Cause	Remedial measure
Code	Description		
M002	Sens. unknown	Measuring cell does not suit the device (electronic measuring cell name-plate). Device continues measuring.	Contact Endress+Hauser Service
M283	Memory content	<ul style="list-style-type: none"> ▪ Cause as indicated for F283 ▪ Correct measurement can continue as long as you do not need the peakhold indicator function. 	<ul style="list-style-type: none"> ▪ Perform a reset ▪ Replace the electronics module
M431	Calibration	The calibration performed would cause the measuring cell nominal range to be exceeded or undershot.	<ul style="list-style-type: none"> ▪ Check the measuring range ▪ Check the position adjustment ▪ Check the setting
M434	Scaling	<ul style="list-style-type: none"> ▪ Values for calibration (e.g. lower range value and upper range value) are too close together. ▪ Lower range value and/or upper range value exceed or fall below the range limits of the measuring cell. ▪ The measuring cell was replaced and the customer-specific configuration does not suit the measuring cell. ▪ Unsuitable download carried out. 	<ul style="list-style-type: none"> ▪ Check the measuring range ▪ Check the setting ▪ Contact Endress+Hauser Service
M438	Data record	<ul style="list-style-type: none"> ▪ The supply voltage is disconnected when writing. ▪ An error occurred when writing. 	<ul style="list-style-type: none"> ▪ Check the setting ▪ Restart the device ▪ Replace the electronics module
M803	Current loop	Impedance of the load resistor at the analog output is too high	<ul style="list-style-type: none"> ▪ Check the wiring and the load at the current output ▪ If the current output is not required, switch it off via the configuration ▪ Connect the current output to the load



"S" messages

Diagnostic event		Cause	Remedial measure
Code	Description		
S110	Working range T	<ul style="list-style-type: none"> ▪ High temperature or low temperature present. ▪ Electromagnetic effects are greater than specifications in the technical data. ▪ Measuring cell defective. 	<ul style="list-style-type: none"> ▪ Check the process temperature ▪ Check the temperature range
S140	Working range P	<ul style="list-style-type: none"> ▪ Overpressure or low pressure present. ▪ Electromagnetic effects are greater than specifications in the technical data. ▪ Measuring cell defective. 	<ul style="list-style-type: none"> ▪ Check the process pressure ▪ Check the measuring cell range
S822	Process temp.	<ul style="list-style-type: none"> ▪ The temperature measured in the measuring cell is greater than the upper nominal temperature of the measuring cell. ▪ The temperature measured in the measuring cell is smaller than the lower nominal temperature of the measuring cell. 	<ul style="list-style-type: none"> ▪ Check the temperature ▪ Check the setting
S841	Sensor range	<ul style="list-style-type: none"> ▪ Overpressure or low pressure present. ▪ Measuring cell defective. 	<ul style="list-style-type: none"> ▪ Check the pressure value ▪ Contact Endress+Hauser Service
S971	Calibration	<ul style="list-style-type: none"> ▪ The current is outside the permitted range from 3.8 to 20.5 mA. ▪ The present pressure value is outside the configured measuring range (but may be within the measuring cell range). 	<ul style="list-style-type: none"> ▪ Check the pressure value ▪ Check the measuring range ▪ Check the setting

10.2 Behavior of the current output in the event of an error

The response of the current output to errors is defined by the following parameters:

Output fail mode (051)/(190)

Navigation	  Setup → Extended setup → Current output → Output fail mode (051)/(190) Expert → Output → Current output → Output fail mode (051)/(190)
Write permission	Operator/Maintenance/Expert
Description	Select Output fail mode. In the event of an alarm, the current and the bar graph assume the current value specified with this parameter.
Selection	<ul style="list-style-type: none"> ▪ Max alarm: can be set from 21 to 23 mA ▪ Hold measured value: last measured value is held. ▪ Min: 3.6 mA
Factory setting	Max. alarm (22 mA)

10.3 Locking/unlocking operation

Once you have entered all the parameters, you can lock your entries against unauthorized and undesired access.

Locked operation is indicated as follows:

- By the  symbol on the local display
- The parameters are grayed out in FieldCare and the handheld terminal, which means they cannot be edited. Information displayed in the " parameter.

Parameters which refer to how the display appears, e.g. "Language", can still be altered.

The "Operator code" parameter is used to lock and unlock the device.

Operator code (021)

Write permission	Operators/Service engineers/Expert
Description	Use this function to enter a code to lock or unlock operation.
User entry	<ul style="list-style-type: none"> ▪ To lock: Enter a number ≠ the release code (value range: 1 to 9999). ▪ To unlock: Enter the release code.
Note	The release code is "0" in the order configuration. Another release code can be defined in the "Code definition" (023) parameter. If the user has forgotten the release code, the release code can be visible by entering the number "5864".
Factory setting	0

10.4 Resetting to factory settings (reset)

Reset via the local display

By entering a certain code, you can completely, or partially, reset the entries for the parameters to the factory settings²⁾. Enter the code by means of the "Enter reset code" parameter (menu path: "Diagnosis" → "Reset" → "Enter reset code"). There are various reset codes for the device. The following table illustrates which parameters are reset by the particular reset codes. Operation must be unlocked to reset parameters →  39.

Reset via IO-Link

- Reset to factory setting:
System → Device Management → System Command → Restore Factory Setting
- Reset to factory setting as per IO-Link (switch device off and on):
System → Device Management → System Command → Back-To-Box
- Device reset:
System → Device Management → System Command → Device Reset

 Any customer-specific configuration carried out at the factory is not affected by a reset (customer-specific configuration remains). If you want to change the customer-specific configuration carried out at the factory, please contact Endress+Hauser Service. As no separate service level is provided, the order code and serial number may be changed without a specific access code (e.g. after replacing the electronics).

Enter the reset code ¹⁾ Display	IO-Link command	Description and effect
62 (Device Reset)	296 (Device Reset)	PowerUp reset (warm start) <ul style="list-style-type: none"> ■ The device is restarted ■ Data are read back from the EEPROM again (processor is initialized again) ■ Any simulation which may be running is ended
7864 (Restore to Factory Settings)	297 (Restore to Factory Settings)	Total reset <ul style="list-style-type: none"> ■ This code resets all the parameters apart from: <ul style="list-style-type: none"> ■ Operating hours (162) ■ Event logbook ■ Lo Trim Sensor (131) ■ Hi Trim Sensor (132) ■ Any simulation which may be running is ended ■ The device is restarted
-	131 (Back To Box)	Total Reset (Back To Box) <ul style="list-style-type: none"> ■ This code resets all the parameters apart from: <ul style="list-style-type: none"> ■ Operating hours (162) ■ Event logbook ■ Lo Trim Sensor (131) ■ Hi Trim Sensor (132) ■ Any simulation which may be running is ended ■ Perform manual restart

1) in "Diagnosis" → "Reset" → "Enter reset code" (124)

10.5 Software history

Device	Date	Software version	Software modifications	Operating Instructions
Cerabar	01.2021	01.00.zz	Original software. Compatible with: FieldCare SW V01.00.00 or higher	BA02136P

2) The factory setting for the individual parameters is indicated in the parameter description .

Device	Date	Software version	Software modifications	Operating Instructions
Deltapilot	01.2021	01.00.zz	Original software. Compatible with: FieldCare SW V01.00.00 or higher	BA02136P

11 Repair

11.1 General information

11.1.1 Repair concept

Under the Endress+Hauser repair concept, devices have a modular design and repairs are carried out by Endress+Hauser Service or by properly trained customers.

Spare parts are grouped into logical kits with the associated replacement instructions.

For more information on service and spare parts, please contact Endress+Hauser Service.

11.1.2 Repair of Ex-certified devices

WARNING

Incorrect repairs can reduce electrical safety!

Explosion Hazard!

- ▶ Only specialist personnel or Endress+Hauser-Service can carry out repairs to Ex certified devices.
- ▶ Relevant standards and national regulations as well as safety instructions (XA) and certificates must be observed.
- ▶ Only original Endress+Hauser spare parts may be used.
- ▶ When ordering spare parts, please check the device designation on the nameplate. Parts may only be replaced by identical parts.
- ▶ Carry out repairs according to the instructions. Following the repair, the individual testing specified for the device must be carried out.
- ▶ A certified device may be converted to another certified device version by Endress +Hauser Service only.
- ▶ All repairs and modifications must be documented.

11.2 Spare parts

- Some replaceable measuring device components are identified by means of a spare part nameplate. This contains information about the spare part.
- All the spare parts available for the measuring device are listed in the *W@M Device Viewer* (www.endress.com/deviceviewer) along with the order code and can be ordered. If available, users can also download the associated Installation Instructions.



Measuring device serial number:

- Located on the device and spare part nameplate.
- Can be read out via the "Serial number" parameter in the "Instrument info" submenu.

11.3 Return

The measuring device must be returned in the event of a factory calibration, or if the wrong device has been ordered or delivered.

As an ISO-certified company and due to legal requirements,

Endress+Hauser is required to follow certain procedures when handling returned products that have been in contact with a medium. To ensure swift, safe and professional device returns, please read the return procedures and conditions on the Endress+Hauser website at www.services.endress.com/return-material

- ▶ Select country.
 - ↳ The web site of the sales organization responsible for your area opens with all of the relevant information relating to returns.
- 1. If the desired country is not listed:
 - Click on the "Choose your location" link.
 - ↳ An overview of Endress+Hauser sales organizations and representatives opens.
- 2. Contact your Endress+Hauser sales office or representative.

11.4 Disposal

When disposing, separate and recycle the device components based on the materials.

12 Overview of the operating menu

			Direct access	Description	
Parameters in italics cannot be edited (read only parameters). The settings, such as the measuring mode, dry or wet calibration or hardware locking, determine whether these parameters are displayed.					
Expert	System	Operator code	021	→ 39	
		Instrument info	Device tag	022	→ 73
			Serial number	096	→ 73
			Firmware version	095	→ 73
			Ext. order code	097	→ 74
			Order code	098	→ 74
			ENP version	099	→ 74
			Electr. serial no.	121	→ 74
			Sensor serial no.	122	→ 74
		Display	Language	000	→ 53
			Format 1st value	004	→ 75
		Management	Enter reset code	124	→ 75
	Measurement	Measuring mode	005	→ 53	
		Basic setup	Pos. zero adjust (gauge pressure sensors)	007	→ 54
			Calib. offset (absolute pressure sensors)	008	→ 76
			Damping value	017	→ 77
			Press. eng. unit	125	→ 53
			Temp. eng. unit	126	→ 77
			Sensor temp.	110	→ 53
		Pressure	Set LRV	013	→ 78
			Set URV	014	→ 78
			Meas. pressure	020	→ 78
			Sensor pressure	109	→ 79
			Corrected pressure	172	→ 54
			Pressure af. damp	111	→ 79
		Level	Unit before lin	025	→ 80
			Calibration mode	027	→ 80
			Empty calib.	028	→ 80
			Empty pressure	029	→ 81
			Empty pressure (read only)	185	
			Full calib.	031	→ 81
			Full pressure	032	→ 81
			Full pressure (read only)	187	
			Level before Lin.	019	→ 82
		Sensor limits	LRL sensor	101	→ 82
			URL sensor	102	→ 82
		Sensor trim	Lo trim measured	129	→ 82
			Hi trim measured	130	→ 82
			Lo trim sensor	131	→ 83

		Direct access	Description	
		Hi trim sensor	132 → 83	
Output	Current output	Output current (read only)	054 → 83	
		Output fail mode	190 → 83	
		Get LRV (only "Pressure")	015 → 83	
		Set LRV	013 168 → 84	
		Get URV (only "Pressure")	016 → 84	
		Set URV	014 169 → 84	
Communication	Manufacturer ID	103		
	Device type code	104	→ 86	
Diagnosis	Diagnostic code	071	→ 86	
	Last diag. code	072	→ 86	
	Min. meas. press.	073	→ 86	
	Max. meas. press.	074	→ 86	
	Reset peakhold	161	→ 87	
	Operating hours	162	→ 87	
	Config. counter	100	→ 87	
	Diagnostic list	Diagnostic 1	075	→ 87
		Diagnostic 2	076	→ 87
		Diagnostic 3	077	→ 87
		Diagnostic 4	078	→ 87
		Diagnostic 5	079	→ 87
		Diagnostic 6	080	→ 87
		Diagnostic 7	081	→ 87
		Diagnostic 8	082	→ 87
		Diagnostic 9	083	→ 87
		Diagnostic 10	084	→ 87
	Event logbook	Last diag. 1	085	→ 88
		Last diag. 2	086	→ 88
		Last diag. 3	087	→ 88
Last diag. 4		088	→ 88	
Last diag. 5		089	→ 88	
Last diag. 6		090	→ 88	
Last diag. 7		091	→ 88	
Last diag. 8		092	→ 88	
Last diag. 9		093	→ 88	
Last diag. 10		094	→ 88	
Simulation	Simulation mode	112	→ 88	
	Sim. pressure	113	→ 88	
	Sim. level	115	→ 89	
	Sim. current	117	→ 89	
	Sim. error no.	118	→ 89	

13 Description of device parameters

 This section describes the parameters in the order they are arranged in the "Expert" operating menu.



13.1 Expert → System

Operator code (021)

Write permission	Operators/Service engineers/Expert
Description	Use this function to enter a code to lock or unlock operation.
User entry	<ul style="list-style-type: none"> ■ To lock: Enter a number ≠ the release code (value range: 1 to 9999). ■ To unlock: Enter the release code.
Note	The release code is "0" in the order configuration. Another release code can be defined in the "Code definition" (023) parameter. If the user has forgotten the release code, the release code can be visible by entering the number "5864".
Factory setting	0

13.2 Expert → System → Instrument info

Device tag (022)

Navigation	  Setup → Extended setup → Device tag
Write permission	Operator/Maintenance/Expert
Description	Enter the device tag e.g. TAG number (max. 32 alphanumeric characters).

Serial number (096)

Write permission	Parameter is read only. Only Endress+Hauser Service has write permission.
Description	Displays the serial number of the device (11 alphanumeric characters).

Firmware version (095)

Write permission	No write permissions. Parameter is read only.
-------------------------	---

Description Displays the firmware version.

Ext. order code (097)

Write permission Parameter is read only. Only Endress+Hauser Service has write permission.

Description Displays extended order number.

Factory setting According to order specifications

Order code (098)

Navigation  Diagnosis → Instrument info → Order code

Write permission Parameter is read only. Only Endress+Hauser Service has write permission.

Description Displays the order code.

Factory setting According to order specifications

ENP version (099)

Write permission No write permissions. Parameter is read only.

Description Displays the ENP version
(ENP = electronic nameplate)

Electr.serial no (121)

Write permission No write permissions. Parameter is read only.

Description Displays the serial number of the main electronics (11 alphanumeric characters).



Ser.no. sensor (122)

Write permission No write permissions. Parameter is read only.



Description Displays the serial number of the sensor (11 alphanumeric characters).

13.3 Expert → System → Display

Language (000)

Navigation	  Main menu → Language
Write permission	Operator/Maintenance/Expert
Description	Select the menu language for the local display.
Selection	<ul style="list-style-type: none"> ▪ English ▪ Another language (as selected when ordering the device) ▪ A third language where applicable (language of the place of manufacture)
Factory setting	English

Format 1st value (004)

Navigation	  Display/operat. → Format 1st value (004)
Write permission	Operator/Maintenance/Expert
Description	Specify the number of places after the decimal point for the value displayed in the main line.
Selection	<ul style="list-style-type: none"> ▪ Auto ▪ x ▪ x.x ▪ x.xx ▪ x.xxx ▪ x.xxxx ▪ x.xxxxx
Factory setting	Auto

13.4 Expert → System → Management

Enter reset code (124)

Write permission	Operators/Service engineers/Expert
Description	Reset parameters completely or partially to the factory values or order configuration by entering a reset code, "Resetting to factory settings (reset)". →  40.

Factory setting: 0

13.5 Expert → Measurement

Measuring mode (005)

Write permission Operator/Maintenance/Expert

Description Select the measuring mode.
The operating menu is structured differently depending on the measuring mode selected.

⚠ WARNING

Changing the measuring mode affects the span (URV)

This situation can result in product overflow.

- ▶ If the measuring mode is changed, the setting for the span (URV) must be checked in the "Setup" operating menu and readjusted if necessary.

Selection

- Pressure
- Level

Factory setting Pressure or according to order specifications

13.6 Expert → Measurement → Basic setup

Pos. zero adjust (007) (gauge pressure measuring cells)

Write permission Operator/Maintenance/Expert

Description Pos. zero adjustment – the pressure difference between zero (set point) and the measured pressure need not be known.

Example

- Measured value = 2.2 mbar (0.033 psi)
- You correct the measured value via the "Pos. zero adjust" parameter with the "Confirm" option. This means that you are assigning the value 0.0 to the pressure present.
- Measured value (after pos. zero adjust) = 0.0 mbar
- The current value is also corrected.

Selection

- Confirm
- Cancel

Factory setting Cancel

Calib. offset (008) (absolute pressure sensors)

Write permission	Maintenance/Expert
Description	Position adjustment – the pressure difference between the set point and the measured pressure must be known.
Example	<ul style="list-style-type: none"> ■ Measured value = 982.2 mbar (14.73 psi) ■ You correct the measured value with the value entered, e.g. 2.2 mbar (0.033 psi) via the "Calib. offset" parameter. This means that you are assigning the value to the pressure present 980.0 mbar (14.7 psi). ■ Measured value (after pos. zero adjustment) = 980.0 mbar (14.7 psi) ■ The current value is also corrected.
Factory setting	0.0

Damping value (017)

Write permission	Operators/Service engineers/Expert (if the "Damping" DIP switch is set to "on")
Description	Enter the damping time (time constant τ). The damping affects the speed at which the measured value reacts to changes in pressure.
Input range	0,0...999,0 s
Factory setting	2.0 or as per order specifications

Press. eng. unit (125)

Write permission	Operator/Maintenance/Expert
Description	Select the pressure unit. If a new pressure unit is selected, all pressure-specific parameters are converted and displayed with the new unit.
Selection	<ul style="list-style-type: none"> ■ mbar, bar ■ mmH₂O, mH₂O ■ inH₂O, ftH₂O ■ Pa, kPa, MPa ■ psi ■ mmHg, inHg ■ kgf/cm² V
Factory setting	mbar or bar depending on the nominal measuring range of the measuring cell, or as per order specifications.

Temp. eng. unit (126)

Write permission	Maintenance/Expert
Description	Select the unit for the temperature measured values.
Selection	<ul style="list-style-type: none"> ■ °C ■ °F ■ K
Note	The setting affects the unit for the "Sensor temp." parameter.
Factory setting	°C

Sensor temp. (110)

Write permission	No write permissions. Parameter is read only.
Description	Displays the temperature that is currently measured in the measuring cell. This can deviate from the process temperature.

13.7 Expert → Measurement → Pressure

Set LRV (013)

Write permission	Operator/Maintenance/Expert
Description	Set the lower-range value – without reference pressure. Enter the pressure value for the lower current value (4 mA).
Factory setting	0.0 or as per order specifications

Set URV (014)

Write permission	Operator/Maintenance/Expert
Description	Set the upper-range value – without reference pressure. Enter the pressure value for the upper current value (20 mA).
Factory setting	Upper range limit or as per order specifications

Meas. pressure (020)

Write permission No write permissions. Parameter is read only.

Description Displays the measured pressure after sensor recalibration, position adjustment and damping.

Sensor pressure (109)

Write permission No write permissions. Parameter is read only.

Description Displays the measured pressure before the sensor trim and position adjustment.

Corrected press. (172)

Navigation   Setup → Corrected press.

Write permission Operator/Maintenance/Expert

Description Displays the measured pressure after sensor trim and position adjustment.

Note If this value is not equal to "0", it can be corrected to "0" by the position adjustment.

Pressure af. damp (111)

Write permission No write permissions. Parameter is read only.

Description Displays the measured pressure after sensor trim, position adjustment and damping.

13.8 Expert → Measurement → Level

Unit before lin. (025)

Description	Select the unit for the measured value display for the level .
Note	The purpose of the selected unit is to describe the measured value only, i.e., the measured value is not converted if a new output unit is selected.
Example	<ul style="list-style-type: none"> ■ Current measured value: 0.3 ft ■ New output unit: m ■ New measured value: 0.3 m
Selection	<ul style="list-style-type: none"> ■ % ■ mm, cm, m ■ ft, inch ■ m³, in³ ■ l, hl ■ ft³ ■ gal, lgal ■ kg, t ■ lb
Factory setting	%

Calibration mode (027)

Write permission	Operator/Maintenance/Expert
Description	Select the calibration mode.
Selection	<ul style="list-style-type: none"> ■ Wet Wet calibration is performed by filling and emptying the vessel. In the event of two different levels, the level, volume, mass or percentage value entered is assigned to the pressure measured at this point in time ("Empty calib." and "Full calib." parameters). ■ Dry Dry calibration is a theoretical calibration. For this calibration, you specify two pressure/level value pairs via the following parameters: "Empty calib.", "Empty pressure", "Full calib.", "Full pressure".
Factory setting	Wet

Empty calib. (028)

Write permission	Operator/Maintenance/Expert
-------------------------	-----------------------------

Description	Enter the output value for the lower calibration point (vessel empty). The unit defined in "Output unit" must be used.
Note	<ul style="list-style-type: none"> ■ In the case of wet calibration, the level (e.g. vessel empty or partially filled) must actually be available. The associated pressure is then automatically recorded by the device. ■ In the case of dry calibration, the level (vessel empty) does not have to be available. For the "In pressure" level selection, the associated pressure must be entered in the "Empty pressure" parameter.
Factory setting	0.0

Empty pressure (29)

Write permission	Operators/Service engineers/Expert
Description	Enter the pressure value for the lower calibration point (vessel empty). See also "Empty calib.".
Prerequisite	<ul style="list-style-type: none"> ■ "Level selection" = In pressure ■ "Calibration mode" = Dry -> entry ■ "Calibration mode" = Wet -> display
Factory setting	0.0

Full calib. (031)

Write permission	Operator/Maintenance/Expert
Description	Enter the output value for the upper calibration point (vessel full). The unit defined in "Output unit" must be used.
Note	<ul style="list-style-type: none"> ■ In the case of wet calibration, the level (e.g. vessel full or partially filled) must actually be available. The associated pressure is then automatically recorded by the device. ■ In the case of dry calibration, the level (vessel full) does not have to be available. For the "In pressure" level selection, the associated pressure must be entered in the "Full pressure" parameter.
Factory setting	100.0

Full pressure (032)

Write permission	Operator/Maintenance/Expert
Description	Enter the pressure value for the upper calibration point (vessel full). See also "Full calib.".

Prerequisite	<ul style="list-style-type: none"> ▪ "Level selection" = In pressure ▪ "Calibration mode" = Dry -> entry ▪ "Calibration mode" = Wet -> display
Factory setting	Upper range limit (URL) of the measuring cell module

Level before lin. (019)

Write permission	No write permissions. Parameter is read only.
Description	Displays the level value prior to linearization.

13.9 Expert → Measurement → Sensor limits

LRL sensor (101)

Write permission	No write permissions. Parameter is read only.
Description	Displays the lower range limit of the measuring cell.

URL sensor (102)

Write permission	No write permissions. Parameter is read only.
Description	Displays the upper range limit of the measuring cell.

13.10 Expert → Measurement → Sensor trim

Lo trim measured (129)

Write permission	Parameter is read only. Only Endress+Hauser Service has write permission.
Description	Displays the reference pressure present to be accepted for the lower calibration point.

Hi trim measured (130)

Write permission	Parameter is read only. Only Endress+Hauser Service has write permission.
Description	Displays the reference pressure present to be accepted for the upper calibration point.

Lo trim sensor (131)

Description	Sensor recalibration by entering a target pressure while simultaneously and automatically accepting a reference pressure present for the lower calibration point.
--------------------	---

Hi trim sensor (132)

Description	Sensor recalibration by entering a target pressure while simultaneously and automatically accepting a reference pressure present for the upper calibration point.
--------------------	---

13.11 Expert → Output → Current output

Output current (054)

Write permission	Operators/Service engineers/Expert
Description	Displays the current current value.

Output fail mode (190)

Write permission	Operators/Service engineers/Expert
Description	Select Output fail mode. In the event of an alarm, the current assumes the current value specified with this parameter.
Options	<ul style="list-style-type: none"> ■ Max: can be set from 21 to 23 mA, see also "High alarm curr." ■ Hold: last measured value is held. ■ Min: 3.6 mA
Factory setting	Max (22 mA)

Get URV (pressure measuring mode) (015)

Write permission	Operators/Service engineers/Expert
Description	Set the upper-range value – reference pressure is present at the device. The pressure for the upper current value (20 mA) is present at the device. Use the "Confirm" option to assign the applied pressure value to the upper current value.
Prerequisite:	Pressure measuring mode
Options	<ul style="list-style-type: none"> ■ Cancel ■ Confirm
Factory setting	Cancel

Set LRV (013, 168)

Write access	Operator/Service engineer/Expert
Description	Set the pressure value, level or content for the lower current value (4 mA).
Factory setting	<ul style="list-style-type: none"> ■ 0.0 % in Level measuring mode ■ 0.0 mbar/bar or in accordance with ordering information in Pressure measuring mode ■ 0.0 m³/h in Flow measuring mode

Get URV (pressure measuring mode) (016)

Write permission	Operators/Service engineers/Expert
Description	Set the upper-range value – reference pressure is present at the device. The pressure for the upper current value (20 mA) is present at the device. Use the "Confirm" option to assign the applied pressure value to the upper current value.
Prerequisite:	Pressure measuring mode
Options	<ul style="list-style-type: none"> ■ Cancel ■ Confirm
Factory setting	Cancel

Set URV (014, 169)

Write permission	Operator/Maintenance/Expert
Description	Set the pressure value, level or content for the upper current value (20 mA).

Factory setting

- 100.0 % in Level measuring mode
- URL Sensor or according to ordering information in Pressure measuring mode
- 3600 m³/h in Flow measuring mode

13.12 Expert → Communication

Device type code (104)

Write permission No write permissions. Parameter is read only.

Description Cerabar M = 0x9219
Deltapilot M = 0x9123

13.13 Expert → Diagnosis

Diagnostic code (071)

Write permission No write permissions. Parameter is read only.

Description Displays the diagnostic message with the highest priority currently present.

Last diag. code (072)

Write permission No write permissions. Parameter is read only.

Description Displays the last diagnostic message that occurred and was rectified.

Note

- Digital communication: the last message is displayed.
- Use the "Reset logbook" parameter to clear the messages listed in the parameter "Last diag. code".

Min. meas. press. (073)

Write permission No write permissions. Parameter is read only.

Description Displays the lowest pressure value measured (peakhold indicator). You can reset this indicator by means of the "Reset peakhold" parameter.

Max. meas. press. (074)

Write permission No write permissions. Parameter is read only.

Description Displays the highest pressure value measured (peakhold indicator). You can reset this indicator by means of the "Reset peakhold" parameter.

Reset peakhold (161)

Write permission Service engineers/Expert

Description You can reset the "Min. meas. press." and "Max. meas. press." indicators with this parameter.

Options

- Cancel
- Confirm

Factory setting Cancel

Operating hours (162)

Write permission No write permissions. Parameter is read only.

Description Displays the hours of operation. This parameter cannot be reset.

Config. counter (100)

Write permission Operators/Service engineers/Expert

Description Displays the configuration counter.
This counter is increased by one every time a parameter or group is changed. The counter counts up to 65535 and then starts again at zero.

13.14 Expert → Diagnosis → Diagnostic list

Diagnostic 1 (075)
 Diagnostic 2 (076)
 Diagnostic 3 (077)
 Diagnostic 4 (078)
 Diagnostic 5 (079)
 Diagnostic 6 (080)
 Diagnostic 7 (081)
 Diagnostic 8 (082)
 Diagnostic 9 (083)
 Diagnostic 10 (084)

Navigation  Diagnosis → Diagnostic list

Write permission No write permissions. Parameter is read only.

Description This parameter contains up to ten diagnosis messages that are currently pending, arranged in order of priority.

13.15 Expert → Diagnosis → Event logbook

Last diag. 1 (085)
 Last diag. 2 (086)
 Last diag. 3 (087)
 Last diag. 4 (088)
 Last diag. 5 (089)
 Last diag. 6 (090)
 Last diag. 7 (091)
 Last diag. 8 (092)
 Last diag. 9 (093)
 Last diag. 10 (094)

Navigation  Diagnosis → Event logbook

Write permission No write permissions. Parameter is read only.

Description This parameter contains the last 10 diagnosis messages to occur and be rectified. They can be reset using the "Reset logbook" parameter. Errors which have occurred multiple times are displayed once only.

13.16 Expert → Diagnosis → Simulation

Simulation mode (112)

Write permission Operator/Maintenance/Expert

Description Switch on simulation and select the simulation mode. When the measuring mode is changed or when the device is restarted, any simulation running is switched off.

Selection

- None
- Pressure → see this table, "Sim. pressure" parameter
- Level → see this table, "Sim. level" parameter
- Tank content → see this table, "Sim. tank cont." parameter
- Alarm/warning, → see this table, "Sim. error no." parameter

Factory setting None

Sim. pressure (113)

Write permission	Operators/Service engineers/Expert
Description	Enter the simulation value. See also "Simulation mode".
Prerequisite	"Simulation mode" = Pressure
Value at switch-on	Current pressure measured value

Sim. level (115)

Write permission	Operators/Service engineers/Expert
Description	Enter the simulation value. See also "Simulation mode".
Prerequisite	"Measuring mode" = Level and "Simulation mode" = Level

Sim. current (117)

Write permission	Operator/Maintenance/Expert
Description	Enter the simulation value. See also "Simulation mode".
Prerequisite	"Simulation mode" = Current value
Factory setting	Actual current value

Sim. error no. (118)

Write permission	Operators/Service engineers/Expert
Description	Enter the diagnostic message number. See also "Simulation mode".
Prerequisite	"Simulation mode"= Alarm/warning
Switch on value:	484 (simulation active)

13.17 Backing up or duplicating the device data

The device does not have a memory module. However, with an FDT technology-based operating tool (e.g. FieldCare) you can do the following:

- Save/recover configuration data
- Duplicate device configurations
- Transfer all relevant parameters when replacing electronic inserts
- The mechanism is based on IO-Link Data Storage

For more information, read the operating manual for the FieldCare operating program.

14 Technical data

14.1 Pressure specifications

WARNING

The maximum pressure for the measuring device depends on the lowest-rated element with regard to pressure (components are: process connection, optional mounted parts or accessories).

- ▶ Only operate the measuring device within the prescribed limits of the components!
- ▶ MWP (maximum working pressure): The MWP is specified on the nameplate. This value refers to a reference temperature of +20 °C (+68 °F) and may be applied to the device for an unlimited time. Note temperature dependence of MWP. For flanges, refer to the following standards for the permitted pressure values at higher temperatures: EN 1092-1 (with regard to their stability/temperature property, the materials 1.4435 and 1.4404 are grouped together under EN 1092-1; the chemical composition of the two materials can be identical.), ASME B 16.5a, JIS B 2220 (the latest version of the standard applies in each case). MWP data that deviate from this are provided in the relevant sections of the Technical Information.
- ▶ The overload limit is the maximum pressure a device may be subjected to during a test. It is greater than the maximum working pressure by a certain factor. This value refers to a reference temperature of +20 °C (+68 °F).
- ▶ The Pressure Equipment Directive (2014/68/EU) uses the abbreviation "PS". The abbreviation "PS" corresponds to the MWP (maximum working pressure) of the measuring device.
- ▶ In the case of measuring range and process connection combinations where the overpressure limit (OPL) of the process connection is smaller than the nominal value of the measuring cell, the device is set at the factory, at the very maximum, to the OPL value of the process connection. If the entire measuring range must be used, a process connection with a higher OPL value must be selected.
- ▶ Oxygen applications: The values for "p_{max} and T_{max} for oxygen applications" may not be exceeded.
- ▶ Devices with ceramic membrane: avoid steam hammering! Steam hammering can cause zero point drifts. Recommendation: Residue (water droplets or condensation) may remain on the membrane following CIP cleaning and can result in local steam hammering the next time steam cleaning takes place. In practice, drying the membrane (e.g. by blowing off excess moisture) has proven to be a successful way of avoiding steam hammering.

14.1.1 Burst pressure

Device	Measuring range	Burst pressure
PMP51 ¹⁾	400 mbar (6 psi)...10 bar (150 psi)	100 bar (1 450 psi)
	40 bar (600 psi)	250 bar (3 625 psi)
	100 bar (1 500 psi)	1 000 bar (14 500 psi)
	400 bar (6 000 psi)	2 000 bar (29 000 psi)

- 1) Excluding PMP55 with mounted diaphragm seal system, PMC51 with ceramic membrane, and the universal adapter process connection.

14.2 Additional technical data

For the technical data, see the Technical Information for Cerabar M TI00436P / Deltapilot M TI00437P.

Index

C

Calib. offset (008) (absolute pressure sensors)	76
Calibration mode (027)	80
CE mark (declaration of conformity)	10
Cleaning	62
Config. counter (100)	87
Configuration of a level measurement	55
Configuration of a pressure measurement	59
Configure language	53
Configure measuring mode	53
Configure pressure engineering unit	53
Configuring level measurement	55
Configuring pressure measurement	59
Corrected press. (172)	54, 79

D

Damping value (017)	77
Declaration of conformity	10
Designated use	9
Device tag (022)	73
Device type code (104)	86
Diagnosis	
Symbols	63
Diagnostic 1 (075)	87
Diagnostic 2 (076)	87
Diagnostic 3 (077)	87
Diagnostic 4 (078)	87
Diagnostic 5 (079)	87
Diagnostic 6 (080)	87
Diagnostic 7 (081)	87
Diagnostic 8 (082)	87
Diagnostic 9 (083)	87
Diagnostic 10 (084)	87
Diagnostic code (071)	86
Diagnostic event	63
Diagnostic events	63
Diagnostic message	63

E

Electr. serial no (121)	74
Empty calib. (028)	80
Empty pressure (29)	81
ENP version (099)	74
Enter reset code (124)	75
Event text	63
Ext. order code (097)	74
Exterior cleaning	62

F

Firmware version (095)	73
Format 1st value (004)	75
Full calib. (031)	81
Full pressure (032)	81

G

Get URV (pressure measuring mode) (015)	83
Get URV (pressure measuring mode) (016)	84

H

Hi trim measured (130)	82
Hi trim sensor (132)	83

L

Last diag. 1 (085)	88
Last diag. 2 (086)	88
Last diag. 3 (087)	88
Last diag. 4 (088)	88
Last diag. 5 (089)	88
Last diag. 6 (090)	88
Last diag. 7 (091)	88
Last diag. 8 (092)	88
Last diag. 9 (093)	88
Last diag. 10 (094)	88
Last diag. code (072)	86
Level before lin. (019)	82
Lo trim measured (129)	82
Lo trim sensor (131)	83
Local display	
see Diagnostic message	
see In alarm condition	
LRL sensor (101)	82

M

Maintenance	62
Max. meas. press. (074)	86
Meas. pressure (020)	78
Measuring mode (005)	53, 76
Menu	
Overview	71
Parameter description	73
Min. meas. press. (073)	86

N

Nameplate	11
---------------------	----

O

Operating hours (162)	87
Operating menu	
Overview	71
Parameter description	73
Operational safety	9
Operator code (021)	39, 66, 73
Order code (098)	74
Output current (054)	83
Output fail mode (051)/(190)	66
Output fail mode (190)	83

P

Pos. zero adjust (007) (Deltabar M and gauge pressure measuring cells)	54, 76
Pos. zero adjust (007) (gauge pressure measuring cells)	54
Press. eng. unit (125)	53, 77
Pressure af. damp (111)	79
Product safety	10

R

Repair concept	69
Requirements for personnel	9
Reset peakhold (161)	87

S

Safety instructions	
Basic	9
Sensor pressure (109)	79
Sensor temp. (110)	78
Ser.no. sensor (122)	74
Serial number (096)	73
Set LRV (013, 168)	84
Set LRV (013)	78
Set URV (014, 169)	84
Set URV (014)	78
Sim. current (117)	89
Sim. error no. (118)	89
Sim. level (115)	89
Sim. pressure (113)	88
Simulation mode (112)	88
Spare parts	69
Nameplate	69
Status signals	63

T

Temp. eng. unit (126)	77
---------------------------------	----

U

Unit before lin. (025)	80
URL sensor (102)	82
Using measuring device	
Borderline cases	9
Incorrect use	9
see Designated use	

W

W@M Device Viewer	69
Workplace safety	9



71581313

www.addresses.endress.com
