



**EE771**

**FLOW SENSOR for  
COMPRESSED AIR and GASES**

# **User Manual**

## **Hardware and Software**

*YOUR PARTNER IN SENSOR TECHNOLOGY*



**ELEKTRONIK®**  
*Ges.m.b.H.*

E+E Elektronik® Ges.m.b.H. doesn't accept warranty and liability claims neither upon this publication nor in case of improper treatment of the described products.

The document may contain technical inaccuracies and typographical errors. The content will be revised on a regular basis. These changes will be implemented in later versions. The described products can be improved and changed at any time without prior notice.

**© Copyright E+E Elektronik® Ges.m.b.H.  
All rights reserved.**

#### **USA FCC notice:**

This equipment has been tested and found to comply with the limits for a Class B digital device, pursuant to part 15 of the FCC Rules. These limits are designed to provide reasonable protection against harmful interference in a residential installation. This equipment generates, uses and can radiate radio frequency energy and, if not installed and used in accordance with the installation manual, may cause harmful interference to radio communications. However, there is no guarantee that interference will not occur in a particular installation. If this equipment does cause harmful interference to radio or television reception, which can be determined by turning the equipment off and on, the user is encouraged to try to correct the interference by one or more of the following measures:

- Reorient or relocate the receiving antenna.
- Increase the separation between the equipment and receiver.
- Connect the equipment into an outlet on a circuit different from that to which the receiver is connected.
- Consult the dealer or an experienced radio/TV technician for help.

#### Caution:

Any changes or modifications not expressly approved by the party responsible for compliance could void the user's authority to operate this device.

#### **CANADIAN ICES-003 notification:**

This Device B digital apparatus complies with Canadian ICES-003.  
Cet appareil numérique de la classe B est conforme à la norme NMB-003 du Canada.

## Table of Contents - HARDWARE

<b>1. GENERAL</b>	4
1.1. Safety Instructions	4
1.1.1. Intended Use	4
1.1.2. Installation, Start-up and Control	5
1.2. Environmental Aspects	5
<b>2. PRODUCT DESCRIPTION</b>	6
<b>3. INSTALLATION</b>	7
3.1. Mounting Dimensions	7
3.1.1. Compact Type (EE771 Type T19 and T20)	7
3.1.2. Remote Sensing Probe Type (EE771 Type T3)	7
3.2. Determining Installation Site	8
3.2.1. Process Pressure	8
3.3. Installation Position	9
3.4. Required Length of Straight Pipe	10
3.5. Assembly of the Measurement Ball Valve	11
3.5.1. Assembly without Flow Sensor, but With Screw Cap Instead (Blind Cap)	11
3.5.2. Shut off the Measurement Ball Valve	11
3.6. Installation of the Flow Sensing Probe	12
3.6.1. Flow Direction	12
3.6.2. Installation of the Sensing Probe	12
<b>4. ELECTRICAL CONNECTIONS</b>	13
4.1. Connection Diagram	13
4.1.1. Relay and Pulse Output, Internal Switching	13
4.1.2. Connection with Optional Plug for Power Supply and Outputs (Order Code E4)	13
4.2. Bus Output (Optional)	14
4.2.1. M-Bus (Meter-Bus)	14
4.2.2. Modbus RTU	15
4.2.3. Data Transmission	15
4.2.4. Addressing	15
<b>5. CONTROL COMPONENTS</b>	16
5.1. Jumper J1 and J2	16
5.2. Digital Interface USB (For Configuration)	16
5.3. Display / Indicator with Keypad (Optional)	16
5.3.1. Indication of the Analogue and Pulse Output	17
5.3.2. Indication of the Switch Output	17
5.3.3. Indication of the MIN / MAX Values	17
5.3.4. Reset of the Consumption Counter or the MIN / MAX Value	18
5.3.5. Maximum Consumption Counter	18
<b>6. ERROR MESSAGES</b>	18
<b>7. MAINTENANCE</b>	19
7.1. Removal of the Sensing Probe of the Flow Sensor	19
7.2. Cleaning the Flow Sensor's Sensing Element	19
<b>8. REPLACEMENT PARTS / ACCESSORIES</b>	19
8.1. Order Code Replacement Sensor	19
8.2. Order Code Miscellaneous	20
<b>9. TECHNICAL DATA</b>	20
9.1. Factory Setting of Outputs	21

## Table of Contents - SOFTWARE

<b>1. General</b>	22
<b>2. Installation</b>	23
2.1. Configuration of the USB Interface (VirtualCOM)	23
<b>3. User Interface</b>	24
<b>4. Menu Toolbar</b>	25
4.1. File	25
4.2. Transmitter	25
4.3. Extras	25
<b>5. Input Screen</b>	25
5.1. Output 1, Output 2	25
5.1.1. Output Mode	25
5.1.2. Measurand	25
5.1.3. Units	25
5.1.4. Output Mode – Analogue	26
5.1.5. Output Mode – Switch (Relay)	26
5.1.6. Output Mode – Pulse	27
5.2. Minimum Flow Shutdown	27
5.3. Display	28
5.4. Adjustment	28
5.4.1. 1-point Adjustment	28
5.4.2. 2-point Adjustment	29
5.4.3. Reset to Factory Settings	29
5.5. Measuring Values Overview	30
5.5.1. Reset of the MIN / MAX Values	30
5.5.2. Reset of the Consumption Counter (Totalizer)	30
5.6. Setting up Process Parameters	30
5.6.1. Change the Process Gas	30
5.6.2. Changing the Standard Conditions	31
5.6.3. Pressure Compensation	31
5.7. External Pressure Sensor for Pressure Compensation	31
5.8. Bus Configuration	31

# 1. GENERAL

This manual is a part of the scope of supply and serves to ensure optimal operation and functioning of the equipment.

For this reason, the manual must be read before start-up.

Therefore, it is necessary that this manual is read and understood by those responsible for the handling, installation, and maintenance of the equipment.

This manual may not be used for competitive purposes or passed on to third parties without the written consent of E+E Elektronik® Ges.m.b.H.

It is permitted to make copies for personal use.

All information, technical data and illustrations contained in these instructions are based on information available at the time of publication.

## ***Explanation of Symbols***



**This symbol indicates safety instructions.**

The safety instructions have to be carried out unconditionally. If disregarded loss, injury, or damage may be inflicted to people and property. In any case E+E Elektronik® Ges.m.b.H. cannot be hold responsible.



**This symbol indicates attention.**

The note should be observed to achieve an optimal functioning of the equipment.

## **1.1. Safety Instructions**

### ***1.1.1. Intended Use***

The flow sensor is intended to be used for the measurement of air and other non-corrosive gases in pipelines only. Consult the factory first before the measurement of wet or filthy gases.

The design of the flow sensor allows for the EE771 to be installed in a pressurized system up to PN16 – is 16 bar (230 psi).



**Prior to the start of the installation, the system has to be depressurized. Before the installation or removal of the sensing probe or the screw cap, the measurement ball valve should be closed.**

Mounting, electrical installation, putting in operation and maintenance should only be done by qualified personnel.

The use of the flow sensor EE771 in any other way than described in this manual bears a safety risk for people and the entire measurement installation and is therefore not allowed.

The manufacturer cannot be hold responsible for damages as a result of incorrect handling, installation, and maintenance of the equipment.

To avoid health risks or damage to the equipment, the installation should not be operated on with tools, which are not specifically mentioned or described in this manual.

Excessive mechanical stress and inappropriate handling must be avoided.

A short interruption of the flow using the measurement ball valve cannot be avoided when exchanging the sensing probe.

The flow sensor can only be utilized in accordance with the conditions defined in the technical data. Otherwise, inaccuracies of the measurement will occur and equipment failures cannot be ruled out.

For the safety of the user and for the functionality of the equipment the recommended steps by the manufacturer to put into operation, to test and to maintain should be taken and completed.

### 1.1.2. Installation, Start-up and Control

The flow sensor is designed and built in accordance with the latest state in technology, tested adequately and has been shipped from the factory in good order and condition.

As the user, you are responsible to comply with all applicable safety regulations amongst others:

- Instruction for the installation
- Local standards and codes

The manufacturer has taken all measures to assure safe operation. The user has to make sure that the equipment is positioned and installed in such a way that safe operation is not impaired. The equipment is tested in the factory and shipped in good order and condition. This manual contains information and notes of caution, which have to be adhered to by the user to assure a safe operation.

- Mounting, electrical installation, putting into operation and maintenance should only be done by qualified personnel. The plant operator should authorize qualified personnel to operate on the installation.
- It is necessary that this manual is read and understood by these professionals and that they follow the instructions as detailed in this manual.
- Check all connections of the entire installation thoroughly, before putting the system into operation.
- Disconnect the device from power supply before opening or closing to avoid damages.
- Do not put a damaged product into operation and make sure that that does not happen inadvertently.
- A malfunction of the equipment should only be handled and fixed by authorized and qualified personnel
- If it is not possible to repair the malfunction, put the equipment out of operation and make sure that it cannot be put back into operation again.
- Repairs not described in this manual may only be carried out by the manufacturer or by the respective service organization.

#### Disclaimer of Liability

The manufacturer or their delegated representative is only liable in case of intend or gross negligence. The accountability is limited to the value of the order issued at the time to the manufacturer.

The manufacturer is not liable for damages, originated from disregarding the safety instructions or violating the instructions of the manual or operating conditions.

Consequential damages are excluded from the any liability.

## 1.2. Environmental Aspects

 The products from E+E Elektronik® are developed and designed in due consideration to the importance of the protection of the environment. Therefore, disposal of the product also should not lead to pollution of the environment.

 The single-variety components must be separated before the sensor is disposed of. The electronic components must be collected and as electronic scrap properly be disposed of.

## 2. PRODUCT DESCRIPTION

The flow sensor of the series EE771, based on the measurement principle of thermal mass flow, is suited for the measurement of flow of air and gases in pipelines. Measurement of for instance the consumption of compressed air, nitrogen, argon, CO<sub>2</sub> or other non-corrosive and non-flammable gases.

The EE771 measures the volume flow at standard conditions according to DIN 1343 ( $P_0 = 1023.25 \text{ mbar}$ ;  $t_0 = 273.15 \text{ K}$  or  $0 \text{ °C}$  ( $32 \text{ °F}$ )). In addition to the standard volume flow, the measurand mass flow, norm flow and temperature are available.

The EE771 has an integrated consumption counter. The consumption quantity is indicated in the display and is not lost after a power failure. Two signal outputs are available. Depending on the application, the outputs can be configured as analogue (current or voltage), switch output or as pulse output for the measurement of the consumption.

### 1 Signal conditioning with optional display

The enclosure with the signal conditioning is mounted either on the measurement probe (type T19 or T20 compact) or is remote with a plugable sensor cable up to 10 meter (33 feet) (type T3 with remote probe).

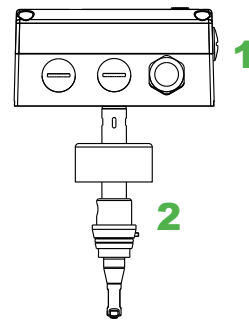

### 2 Sensing probe with measurement electronics

The interchangeable sensing probe contains the sensor element and the measurement electronics, in which the data of the factory calibration is stored. The sensing probe is easy and quickly interchangeable in the field, independent of the electronics for the signal conditioning. After the exchange, the configuration of the outputs is unchanged.

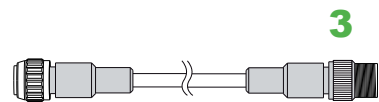

### 3 Sensor cable (only for type T3 with remote sensing probe)

The sensor cable allows for the remote installation, up to 10 meter (33 feet), of the sensing probe from the housing with the signal conditioning.

### 4 Measurement valve with shut-off function

The measurement ball valve assembly allows for the easy and reliable installation within the pipeline. During installation in the pipeline, observe the required inlet and outlet paths (see page 10). The nominal size of the measurement ball valve assembly must match the nominal size of the pipe.

The measurement valve with shut-off function allows for the instalment and removal of the sensing probe with only interrupting the process flow for a short moment. The measurement ball valve assembly is suitable for pressures up to 16 bar (PN16) and available for pipe diameters DN15 (1/2") to DN50 (2").

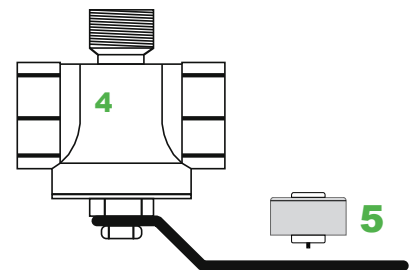

### 5 Screw cap

The screw cap, with female thread, is screwed in place if the flow sensor is not installed and the pipeline has to be used.

### 3. INSTALLATION

#### 3.1. Mounting Dimensions

##### 3.1.1. Compact Type (EE771 Type T19 and T20)

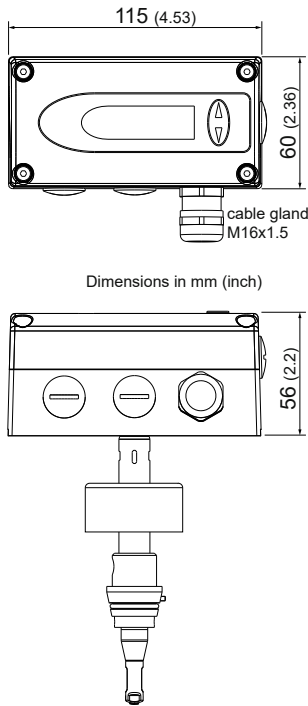

Measurement valve with shut-off function

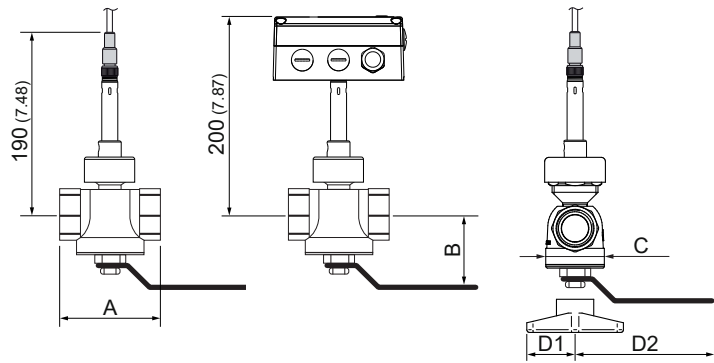

Valve	Thread <sup>1)</sup>	A	B	C	D1	D2	ISO	NPT
DN15	R <sub>p</sub> 1/2"	100±8 (3.94±0.32) <sup>2)</sup>	55 (2.28)	43 (1.69)	36 (1.46)	–	HA075015	n.a.
DN20	R <sub>p</sub> or NPT 3/4"	73 (2.83)	55 (2.28)	43 (1.69)	36 (1.46)	–	HA075020	HA175020
DN25	R <sub>p</sub> or NPT 1"	88 (3.27)	67 (2.28)	52 (2.00)	48 (1.73)	–	HA075025	HA175025
DN32	R <sub>p</sub> 1 1/4"	100 (3.94)	77 (2.64)	62 (2.44)	–	125 (4.88)	HA075032	n.a.
DN40	R <sub>p</sub> or NPT 1 1/2"	110 (4.33)	83 (3.27)	74 (2.91)	–	147 (5.79)	HA075040	HA175040
DN50	R <sub>p</sub> or NPT 2"	131 (5.16)	88 (3.46)	90 (3.54)	–	147 (5.79)	HA075050	HA175050

1) Female thread: BSP thread acc. to EN 10226 (old DIN 2999) or NPT  
 2) Including reduction 3/4"-1/2"

##### 3.1.2. Remote Sensing Probe Type (EE771 Type T3)

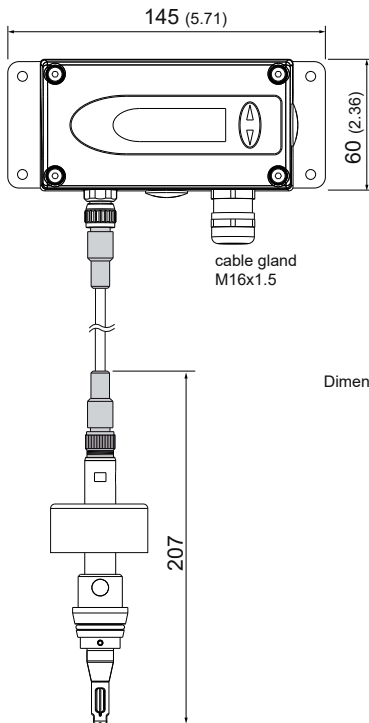

Cross-section bore hole:

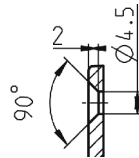

Dimensions in mm (inch)

Drilling Plan:

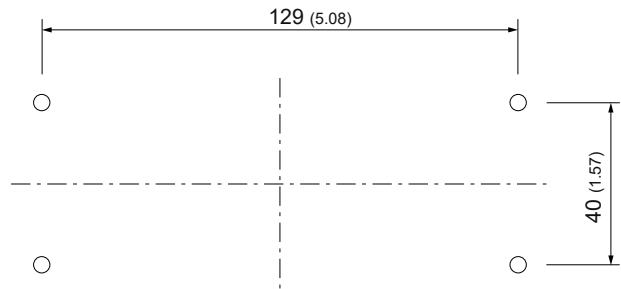

The bottom part of the housing is mounted with 4 screws (not in the scope of supply)  
 Max. screw diameter: 4.5 mm (0.17 inch).  
 e.g. 4.2 x 38 mm DIN 7938H Screws

## 3.2. Determining Installation Site

- The installation site should be easy to access and free of vibrations and shocks
- Observe at least 120 mm (5 inch) clearance above the enclosure with the signal conditioning, in order to be able to remove the sensing probe if necessary.
- The ambient temperature should not exceed the value as stated in the specifications (see page 20) – consider heating by radiation.
- Air purity on the installation site according to ISO 8573-1:2010: at least class 3.4.4
- The fluid should not condense at the installation site. Condensation on the tip of the sensing probe must be avoided.
- In compressed air systems, the installation must be downstream of the dryer. If there is no dryer, at least steam trap and suitable filter must be present.
- Observe the direction of the flow by the installation (see page 11).
- Observe the recommended straight pipe lengths up and downstream, in order to warrant the specified measurement accuracy.
- The flow sensor should be installed as far as possible from any flow disturbance. Valves or check-valves should be installed in a respective distance from the flow sensor.

### 3.2.1. Process Pressure

Because of the measuring principle the thermal mass flow sensor EE771 is largely independent of the process pressure and is factory calibrated at a pressure of 7 bar (100 psi).

In order to achieve the highest measurement accuracy, the slight dependence on process pressure can be compensated for in two ways:

- If the process pressure is stable, by programming the pressure value in the configuration software (see page 30).
- In case of strong fluctuations of the process pressure (e.g. 3 to 10 bar (40 to 150 psi)), an external pressure sensor can be installed and connected to the pressure compensation input (see page 31).

 **In order to install or remove the measurement section the pipeline system should be depressurized.**



### 3.3. Installation Position

Make sure that the arrow on the tip of the sensing probe is pointing in the direction of the flow.

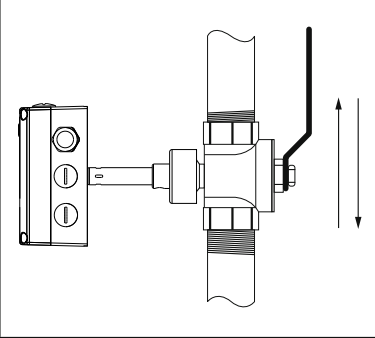
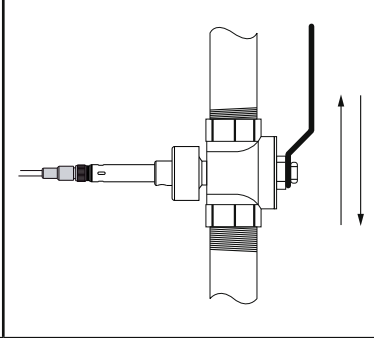
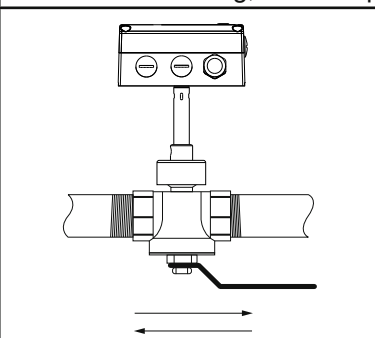
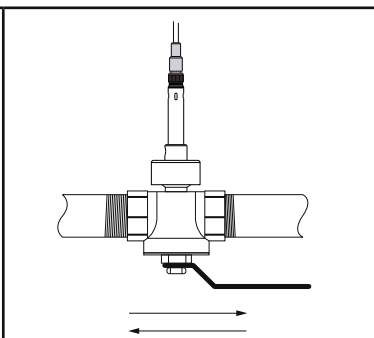
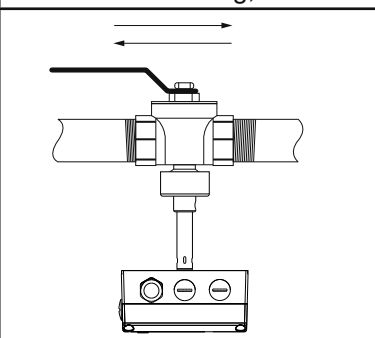
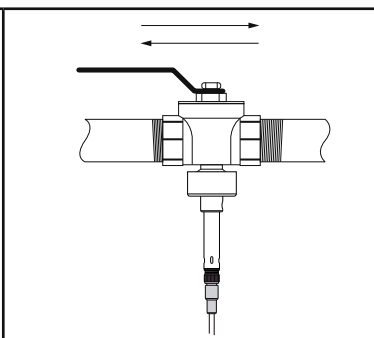
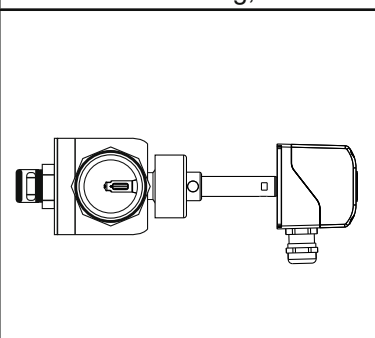
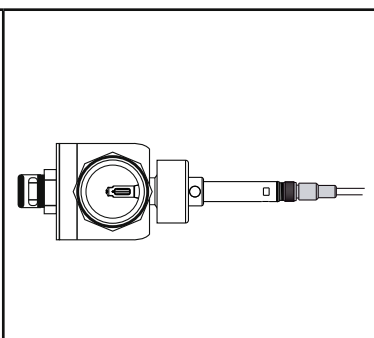
		Type	
		Compact	Remote
Vertical Mounting			
		+	++
Horizontal Mounting, sensor upwards			
		++	++
Horizontal Mounting, sensor downwards			
		-	-
Horizontal Mounting, sensor across			
		+	++



- ++ ... recommended installation position
- + ..... not recommended if there is vibration on the pipeline
- ..... not recommended

### 3.4. Required Length of Straight Pipe

The flow sensor should be installed as far as possible from disturbances of the flow. The causes for disturbance of the flow are for instance, reducers, elbows, T-pieces, valves, gate valves, etc. The specified measurement accuracy can be achieved only when the following straight inlet and outlet pipe lengths are installed:

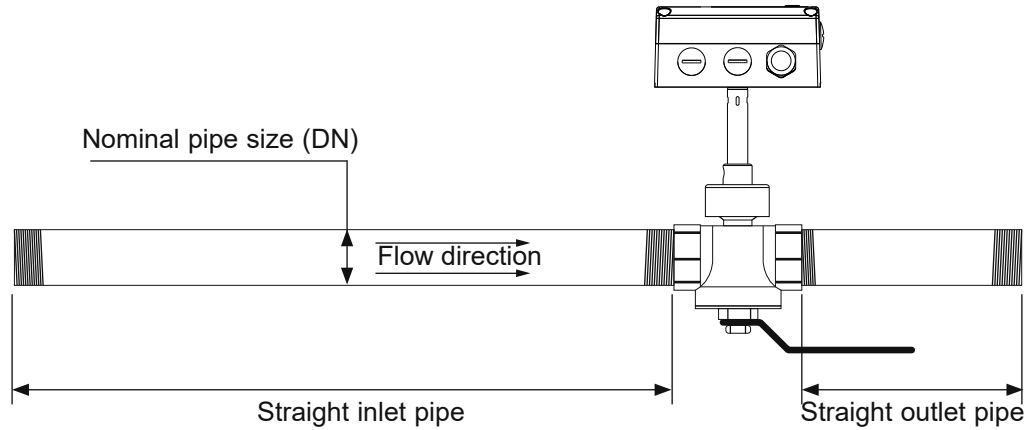
- The wall thickness of the inlet and outlet pipe should be 2,6 mm.
- The stated values are as a minimum. If possible, allow for greater distances.
- Valves or gate valves should be installed downstream of the flow sensor.
- With lighter gases the inlet straight pipe should be longer.

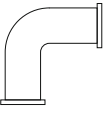
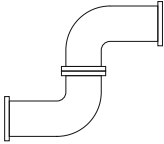
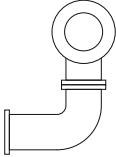
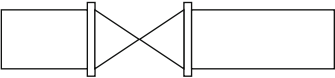

	Type	(DN = Nominal Pipe Size)	
		Straight inlet pipe	Straight outlet pipe
	Extension	15 x DN	5 x DN
	Reduction	15 x DN	5 x DN
	90° - elbow	20 x DN	5 x DN
	Two 90° - elbows, in one level	25 x DN	5 x DN
	Two 90° - elbows, in two levels, T-piece	30 x DN	5 x DN
	Valve, gate valve	50 x DN	5 x DN

### 3.5. Assembly of the Measurement Ball Valve



- All connections to be made with appropriated sealing material on the threads.
- The sealing material should not change the area of the inner cross section of the pipe. It must be warranted that the connections after installation are free of leaks.
- All fittings must be tested on seal tightness.
- Make sure during the assembly of the measurement section that the arrows on the pipe section and the measurement ball valve are pointing in the same direction as the flow.
- The recess for the alignment pin must be at the side of the outlet.

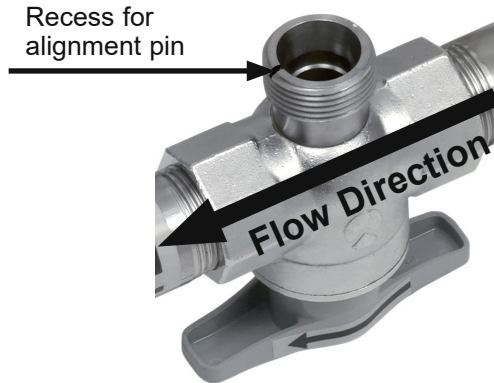

#### 3.5.1. Assembly without Flow Sensor, but With Screw Cap Instead (Blind Cap)

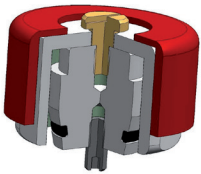

In order to use the measurement section without the flow sensor, the blind screw cap (in the scope of supply) must be screwed tight onto the opening of the measurement ball valve.

Tighten the red coloured retainer nut by hand. Tightening by hand should be sufficient. However, if the seal is not leak tight carefully tighten the nut with an appropriate tool a bit further.

**Maximum torque 25 Nm!**

If not needed the screw cap can be screwed and stored on the handle of the measurement valve with shut-off function.

#### 3.5.2. Shut off the Measurement Ball Valve

The measurement ball valve assembly allows for the installation and removal of the flow sensor within seconds, with only a very short interruption of the flow.

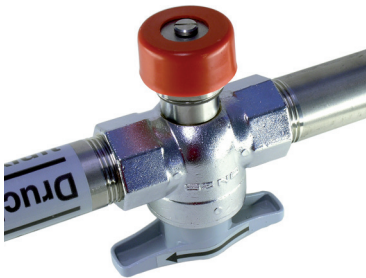

**OPEN**



**CLOSED**



**Never remove the flow sensor or the blind screw cap while the measurement ball valve is open.**

**That is extremely dangerous!**

### 3.6. Installation of the Flow Sensing Probe

#### 3.6.1. Flow Direction

The flow direction is indicated with an arrow on the tip of the probe. Due to the alignment pin in the installation of the sensing probe in the measurement ball valve only possible in the direction of the flow. After a removal, the sensing probe will be re-installed in the measurement section in exactly the same position as done at the factory. Hence, the highest reproducibility is guaranteed.

#### 3.6.2. Installation of the Sensing Probe

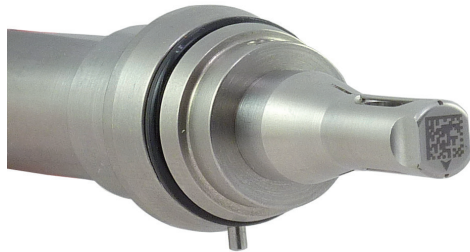

**Make sure that the measurement ball valve is shut off.**

- Remove transport protection cap of the head of the sensing probe.
- Mount the sensing probe in the measurement valve with shut-off function in such a way that the alignment pin fits in the recess on the measurement ball valve.
- Screw the retainer nut by hand so far that a certain resistance is noticeable.



- Check the correct installation position of the flow sensor. The alignment pin must fit in the recess on the measurement ball valve.



- Tighten the red coloured retainer nut by hand. Tightening by hand should be sufficient. However, if the seal is not leak tight carefully tighten the nut with an appropriate tool a bit further.  
**Maximum torque 25 Nm!**
- The mechanical installation of the flow sensor is therewith completed.



## 4. ELECTRICAL CONNECTIONS

Before electrical connections are made turn off the power supply first. If not observed the electronics can be damaged as a result.

Only a qualified electrotechnical engineer may install the device.

- Unscrew the four screws and remove the cover of the housing.
- The screw terminals are located in the bottom part of the housing.
- For the electrical connection of the flow sensor a six-wire cable is needed (e.g. 6 x 1 mm<sup>2</sup> (AWG 17))

### 4.1. Connection Diagram

**Important note:**  
 The manufacturer cannot be held responsible for personal injuries or damage to property as a result of incorrect handling, installation, wiring, power supply and maintenance of the device.

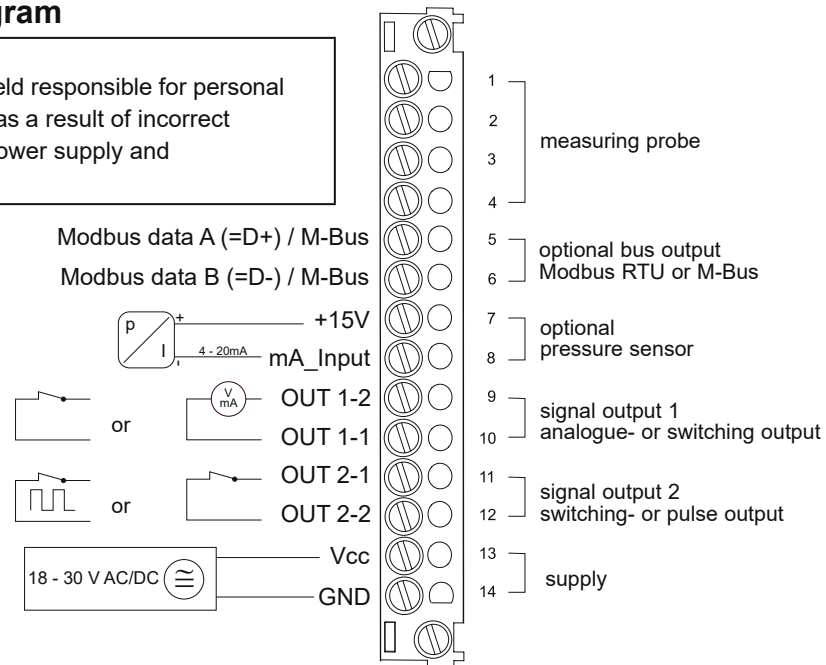

- Screw terminal OUT 1-1 for the analogue output is internally connected with GND.
- The housing should be grounded to achieve optimal electromagnetic compliance.

#### 4.1.1. Relay and Pulse Output, Internal Switching

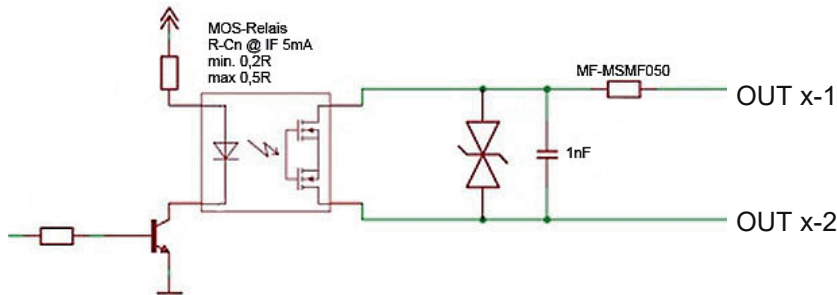

The relay switch and pulse outputs are both potential free.

#### 4.1.2. Connection with Optional Plug for Power Supply and Outputs (Order Code E4)

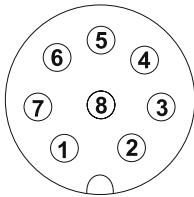

**Connection plug for the power supply and analogue outputs** (rear view of the terminals)

Pin	Assignment
1	OUT 2-2
2	OUT 1-2
3	OUT 1-1
4	GND
5	OUT 2-1
6	n.c.
7	Vcc
8	n.c.

## 4.2. Bus Output (Optional)

### 4.2.1. M-Bus (Meter-Bus)

The M-Bus (Meter Bus) is a field bus for recording consumption data. Transmission is carried out serially on a reverse polarity protected two-wire line. The flow sensor as M-Bus slave requires a separate supply voltage. No specific topology (line or star) is prescribed for the cabling. Normal telephone cable of type J-Y(St)Y Nx2x0.8 mm can be used. A maximum of 250 meters is permitted per segment (primary addressed).

#### Read-out of the current measurement/consumption data

The following measurement/consumption values are transmitted during a standard query:

- Standard volumetric flow (32 Bit Real)
- Temperature (32 Bit Real)
- Mass flow (32 Bit Real)
- Consumption meter status (32 Bit Real)
- Flow velocity (32 Bit Real)
  
- Standard volumetric flow (32 Bit Integer)
- Temperature (32 Bit Integer)
- Mass flow (32 Bit Integer)
- Consumption meter status (64 Bit Integer)
- Flow velocity (32 Bit Integer)

The table below shows the package structure of the measurement/consumption data sent by the EE77x sensor:

Header	
68	Start of telegram
4F 4F	L-field (length)
68	Second starting signal
08	C-field (RSP_UD)
XX	A-field (Adresse)
Start User data	
72	CI-field (variable data structure)
XX XX XX XX	Identification number
A5 16	Producer (0x16A5 ... EUE)
01	Version
09	Medium (9 ... compressed air)
XX	Access number (continuous)
00	Status
00 00	Signature
Data record 1: Volumenstrom	
05	DIF (32 Bit Real)
3E	VIF (Volume flowmesse in m <sup>3</sup> /h)
XX XX XX XX	Act. measuring value
Data record 2: Temperature	
05	DIF (32 Bit Real)
5B	VIF (Temperature in °C)
XX XX XX XX	Act. measuring value
Data record 3: Mass flow	
05	DIF (32 Bit Real)
53	VIF (Mass flow in kg/h)
XX XX XX XX	Act. measuring value
Data record 4: Consumption meter reading	
05	DIF (32 Bit Real)
16	VIF (Volume in m <sup>3</sup> )
XX XX XX XX	Act. measuring value
Data record 5: Flow rate	
05	DIF (32 Bit Real)
7F	VIF (manufacturer specific in m/s)
XX XX XX XX	Act. measuring value

Data record 6: Pressure	
05	DIF (32 Bit Real)
6B	VIF (Pressure in bar)
XX XX XX XX	Act. measuring value
Data record 7: Volume flow	
04	DIF (32 Bit Integer)
3B	VIF (Volume flow in 10 <sup>-3</sup> m <sup>3</sup> /h)
XX XX XX XX	Act. measuring value
Data record 8: Temperatur	
04	DIF (32 Bit Integer)
59	VIF (Temperature in 10 <sup>-2</sup> °C)
XX XX XX XX	Act. measuring value
Datenrecord 9: Mass flow	
04	DIF (32 Bit Integer)
51	VIF (Mass flow in 10 <sup>-2</sup> kg/h)
XX XX XX XX	Act. measuring value
Datenrecord 10: Consumption meter reading	
07	DIF (64 Bit Integer)
13	VIF (Volume in 10 <sup>-3</sup> m <sup>3</sup> )
XX XX XX XX	Akt. consumption data
XX XX XX XX	
Datenrecord 11: Flow rate	
04	DIF (32 Bit Integer)
7F	VIF (manufacturer specific in 10 <sup>-2</sup> m/s)
XX XX XX XX	Act. measuring value
Data record 12: Pressure	
04	DIF (32 Bit Real)
68	VIF (Pressure in 10 <sup>-3</sup> bar)
XX XX XX XX	Act. measuring value
End of user data	
XX	Check sum
16	End of telegram

## Secondary addressing

In addition to primary addressing, the EE77x transmitter provides the option of secondary addressing. The fields of identification number, manufacturer, version and medium are used together as the secondary address. The exact sequence of the secondary addressing is described in detail in the M-Bus Standard: <https://m-bus.com/assets/downloads/MBDOC48.PDF>.

### 4.2.2. Modbus RTU

The measured values are stored as 32 Bit float value (FLOAT32). Depending on the measurement unit selected, the measurements are saved in SI or US/GB units. The measurement unit can be changed using the configuration software.

For resetting the MIN/MAX-Values write 0 to the corresponding write register.

For Modbus protocol setting please see Application Note AN0103 available at [www.epluse.com/ee771](http://www.epluse.com/ee771).

### Modbus Map:

Register Number	Register Address	Measuring Value	SI Unit	US/GB Unit
Read Registers (Function Code 0x03 / 0x04) / FLOAT32				
30026	19	Standardized Flow	m/s	SFPM
30028	1B	Standardized Volumetric Flow	m <sup>3</sup> /h	SCFPM
30030	1D	Temperature	°C	°F
30032	1F	Massflow	kg/h	kg/h
30034	21	Consumption reading	m <sup>3</sup>	ft <sup>3</sup>
30036	23	Pressure	bar	psi
30261	104	MIN-Value Standardized Flow	m/s	SFPM
30263	106	MAX-Value Standardized Flow	m/s	SFPM
30265	108	MIN-Value Standardized Volumetric Flow	m <sup>3</sup> /h	SCFPM
30267	10A	MAX-Value Standardized Volumetric Flow	m <sup>3</sup> /h	SCFPM
30269	10C	MIN-Value Temperature	°C	°F
30271	10E	MAX-Value Temperature	°C	°F
30273	110	MIN-Value Massflow	kg/h	kg/h
30275	112	MAX-Value Massflow	kg/h	kg/h
30277	114	MIN-Value Pressure	bar	psi
30279	116	MAX-Value Pressure	bar	psi
Write Registers (Function Code 0x06) / INT16				
60261	104	Reset MIN/MAX-Value Standardized Flow		
60262	105	Reset MIN/MAX-Value Standardized Volumetric Flow		
60263	106	Reset MIN/MAX-Value Temperature		
60264	107	Reset MIN/MAX-Value Massflow		
60265	108	Reset MIN/MAX-Value Pressure		

### 4.2.3. Data Transmission

	Factory Setting M-Bus	Factory Setting Modbus	Adjustable Values	
			M-Bus	Modbus RTU
Baud Rate	2400	9600	600...9600	9600...57600
Data Bits	8	8	8	8
Parity	EVEN	EVEN	None, Odd, Even	None, Odd, Even
Stop Bits	1	1	1 or 2	1 or 2
Address	1	1	0...254	1...247

### 4.2.4. Addressing

The flow sensors are factory-set to address 1. The address can be set via switches on the PCB.

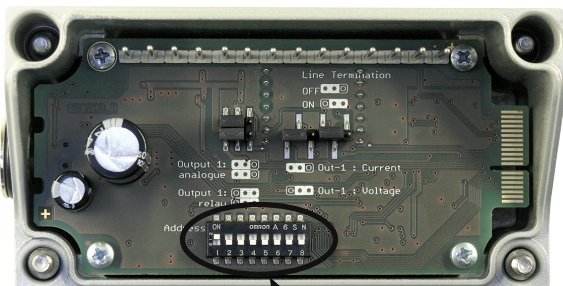

**Dip-Switch for address setting**



Factory Setting:  
Address = 1

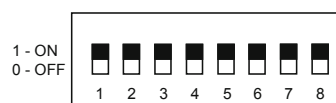

Address = 255  
The address set using the configurator software is used.



## 5. CONTROL COMPONENTS

### 5.1. Jumper J1 and J2

If the signal output is altered from relay to analogue output or vice versa, Jumper **Output 1** has to be relocated.

If the analogue output is altered from a current to a voltage output or vice versa, Jumper **Out-1** has to be relocated.

signal output 1 =  
switching output

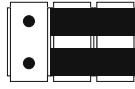

signal output 1 =  
analogue output



**Modbus RTU only**



Line Termination = OFF



Line Termination = ON  
150 Ohm parallel to  
bus output A and B

**Jumper Output 1**

**Jumper Line Termination**

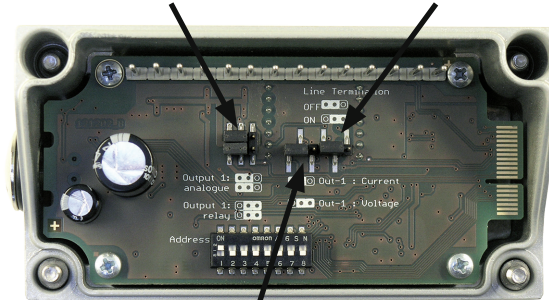

**Jumper Out-1**

analogue output = current signal (e.g. 4-20 mA) 

analogue output = voltage signal (e.g 0-10 V) 

### 5.2. Digital Interface USB (For Configuration)

The USB connector is behind the blind screw cap, at the side of the housing.

- remove the blind screw cap with a screwdriver
- plug in the USB connector



Install the configuration software, which is in the scope of supply. The configuration software is available for downloading as well from our website at [www.epluse.com](http://www.epluse.com)

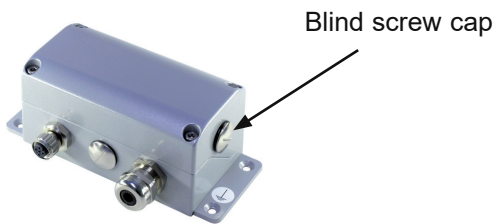

Blind screw cap

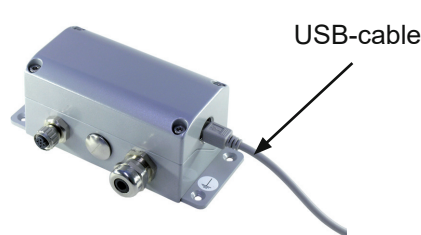

USB-cable

### 5.3. Display / Indicator with Keypad (Optional)

An optional two-line display is available for the flow sensor EE771. The display is an integral part of the cover of the housing and has two soft-keys for the control of the indicator.

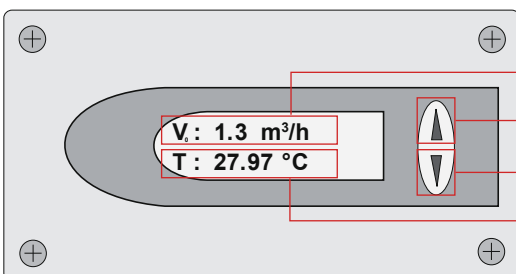

line 1

pushbutton - UP

pushbutton - DOWN

line 2



Depending on the configuration of the outputs either the measured values, the status of the relay or the consumption is indicated.

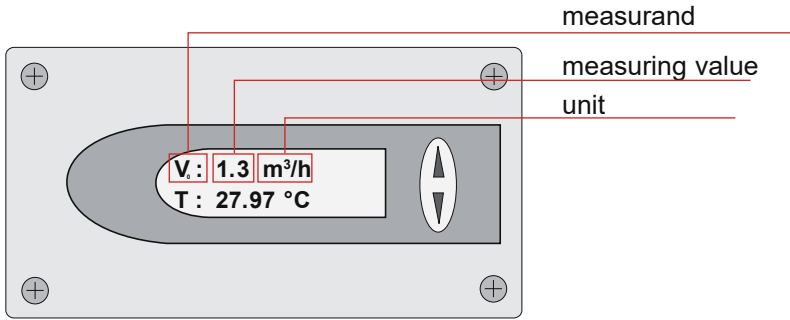

Measurand		SI Unit	US Unit
$v_0$	Standardized Flow	m/s	SFPM
T	Temperature	°C	°F
$\dot{V}_0$	Standardized Volumetric Flow	m <sup>3</sup> /h; m <sup>3</sup> /min; l/min	SCFM; SLPM
m	Massflow	kg/h; kg/min; kg/s	kg/h; kg/min; kg/s
Q	Consumption	m <sup>3</sup>	ft <sup>3</sup>
p	Pressure	bar	psi

### 5.3.1. Indication of the Analogue and Pulse Output

Line 1 indicates always the configured measurand at output 1. In line 2 the desired measurement value can be indicated using the UP and DOWN keys.

### 5.3.2. Indication of the Switch Output

Line 1 indicates the status of the switch output. In line 2 the desired measurement value can be indicated using the UP and DOWN keys.

The display shows an inverse image if the relay output is active (relay has switched).

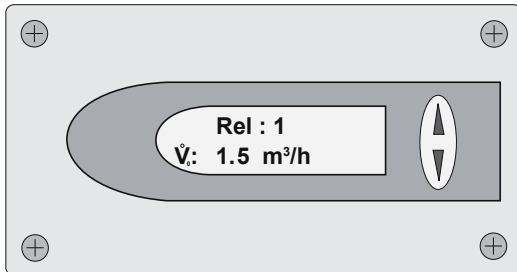

Switch output inactive (relay has not switched)

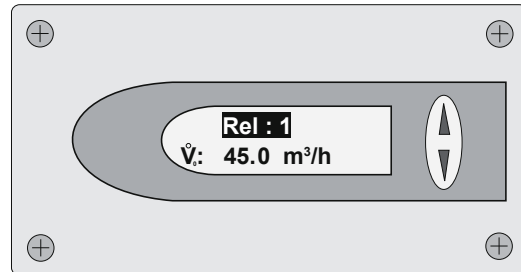

Switch output active (relay has switched)

### 5.3.3. Indication of the MIN / MAX Values

Keep the DOWN key pressed for > 3 sec to indicate the MIN value.

Keep the UP key pressed for > 3 sec to indicate the MAX value.

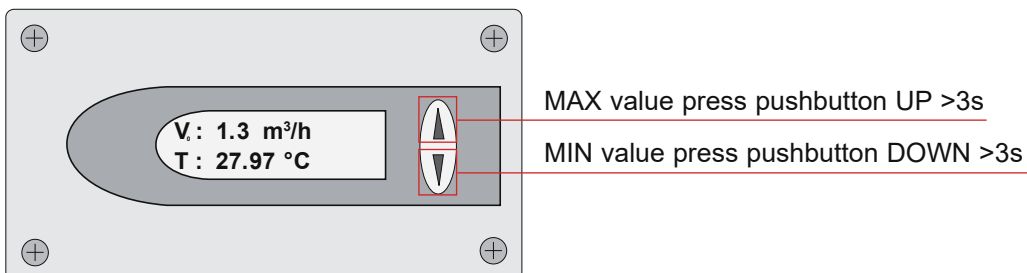

After that the several different measurement values can be indicated using the UP or DOWN keys.  
Keep the DOWN or UP key pressed for > 3 sec to exit the MIN / MAX mode.

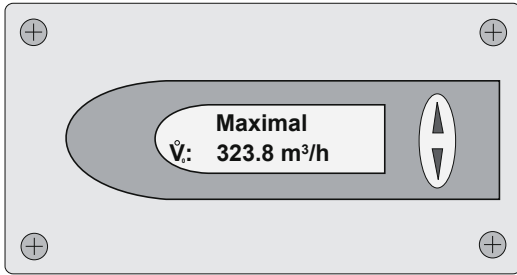

#### 5.3.4. Reset of the Consumption Counter or the MIN / MAX Value

Keep both the UP and DOWN key pressed for > 3 sec to enter the menu for resetting the consumption counter or the MIN / MAX value. Select the desired menu item by pressing the UP or DOWN key briefly.

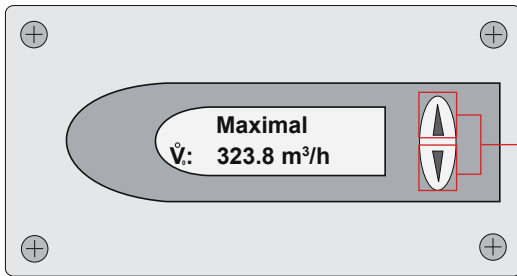

Press pushbutton UP and DOWN at the same time for >3s

To confirm the selected choice of the menu keep the DOWN or UP key pressed for > 3 sec.  
Select menu item "NO" or "EXIT" to cancel without resetting.

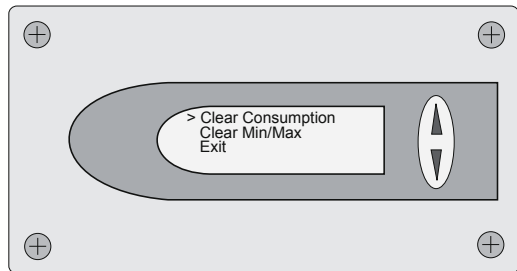

#### 5.3.5. Maximum Consumption Counter

The maximum consumption counter readout on the display is 999,999,999.0 m<sup>3</sup> or 99,999,999.0 ft<sup>3</sup>. Then it shows "LCD maximum". The internal memory continues counting. The maximum counter reading is  $3.4 \cdot 10^{38}$  m<sup>3</sup>. It is possible to read-out the counter reading with the configuration software.

## 6. ERROR MESSAGES

In case the flow sensor is equipped with the optional display, the following error message can be indicated.

ERROR 01: sensing probe is not detected

- Cause: the sensing probe is not connect or is defect  
Effect: the display indicates "0" for all measurand. The analogue output defaults to the lowest configured value.  
Action: check the head of the sensing probe for visual damage.  
check the sensor cable from the sensing probe to the electronics of the signal conditioning.

ERROR 02: the EEPROM is defect

- Cause: the EEPROM for the storing of the consumption counter and MIN /MAX value is defect.  
Effect: the consumption counter and MIN / MAX values are no longer available. All measurement values though are still indicated. The analogue, relay and pulse output are still functional.  
Action: return the flow sensor to the manufacturer.

## 7. MAINTENANCE

Regular cleaning of the sensor is necessary is used in applications with wet or filthy gases. Cleaning of the sensor is necessary prior to calibration or evaluation.

### 7.1. Removal of the Sensing Probe of the Flow Sensor

- Shut off the measurement valve with shut-off function (see page 11).
- Turn off the power supply, remove the cover and disconnect the power wires on the screw terminal.
- Loose the retainer nut and pull the sensor probe from the measurement section.



**Never remove the flow sensor while the measurement ball valve is open. That is extremely dangerous!**



- Operation without the flow sensor installed page 11.

### 7.2. Cleaning the Flow Sensor's Sensing Element



Do not use an abrasive cleaning agent, an organic solvent containing halogen or acetone.

- Clean the head of the sensor probe by carefully swirling in warm water or isopropyl alcohol. It is recommended to use isopropyl alcohol if the pollution is crease or oil.



The sensor should not be touch by fingers or solid objects like screwdrivers or brushes!

- Leave the sensor to dry in ambient air.

## 8. REPLACEMENT PARTS / ACCESSORIES

### 8.1. Order Code Replacement Sensor

Replacement Sensor		PE771-	
Type	Compact ri-le	flow direction right to left	T19
	Compact le-ri	flow direction left to right	T20
	Remote probe		T3
Measuring range	Low - 0...100 m/s (328.1 ft/s)		HV31
	High - 0...200 m/s (656.2 ft/s)		HV33
Measurement valve for pipe diameter	DN15		N15
	DN20		N20
	DN25		N25
	DN32		N32
	DN40		N40
	DN50		N50
Electrical connection	Cable gland and screw terminals		no code
	1 plug for power supply and outputs		E4

## Order Example

### PE771-T19HV31DN25E4

Type: Compact ri-le  
 Measuring range: Low  
 Measurement valve for pipe diameter: DN25  
 Electrical connection: 1 plug for power supply and outputs

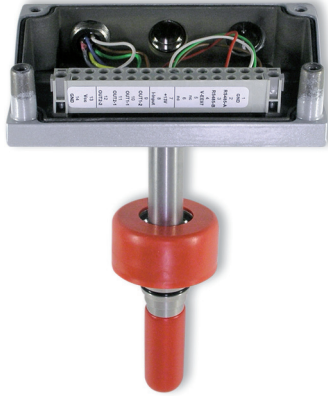

## Order Example

### PE771-T3HV31DN25

Type: Remote probe  
 Measuring range: Low  
 Measurement valve for pipe diameter: DN25  
 Electrical connection: Cable gland and screw terminals



## 8.2. Order Code Miscellaneous

<b>Measurement ball valve</b>	DN15 - Measurement ball valve	<b>HA075015</b>
	DN20 - Measurement ball valve	<b>HA075020</b>
	DN25 - Measurement ball valve	<b>HA075025</b>
	DN32 - Measurement ball valve	<b>HA075032</b>
	DN40 - Measurement ball valve	<b>HA075040</b>
	DN50 - Measurement ball valve	<b>HA075050</b>
<b>Probe cable (for type T3)</b>	<b>Cable length</b>	
	2 m	<b>HA010816</b>
	5 m	<b>HA010817</b>
	10 m	<b>HA010818</b>
<b>Screw cap (blind cap)</b>		<b>HA070201</b>

## 9. TECHNICAL DATA

### Measurands

#### Flow

Volumetric flow at standard conditions acc. to DIN 1343  
 $p_0 = 1013.25 \text{ mbar (14.7 psi)}$ ;  $T_0 = 0 \text{ °C (32 °F)}$

Measuring range		HV31		HV33	
Standardized volumetric flow in air	DN15 (1/2"):	0.32...63 m <sup>3</sup> /h	0.19...37.1 SCFM	0.32...126 m <sup>3</sup> /h	0.19...74.1 SCFM
	DN20 (3/4"):	0.57...113 m <sup>3</sup> /h	0.34...66.5 SCFM	0.57...226 m <sup>3</sup> /h	0.34...133 SCFM
	DN25 (1"):	0.90...176 m <sup>3</sup> /h	0.53...103.5 SCFM	0.90...352 m <sup>3</sup> /h	0.53...207.1 SCFM
	DN32 (1 1/4"):	1.45...289 m <sup>3</sup> /h	0.85...170.0 SCFM	1.45...578 m <sup>3</sup> /h	0.85...340 SCFM
	DN40 (1 1/2"):	2.26...452 m <sup>3</sup> /h	1.33...265.9 SCFM	2.26...904 m <sup>3</sup> /h	1.33...531.8 SCFM
Standardized flow in air, CO <sub>2</sub> , nitrogen, argon	DN50 (2"):	3.50...700 m <sup>3</sup> /h	2.06...411.8 SCFM	3.50...1400 m <sup>3</sup> /h	2.06...823.6 SCFM
	≤DN50 (2"):	0.5...100 m/s	100...19685 SFPM	0.5...200 m/s	100...39370 SFPM
	DN65 (2 1/2"):			0.5...117 m/s	100...23031 SFPM
O <sub>2</sub>	≤DN25 (1"):	0.5...100 m/s	100...19685 SFPM	0.5...200 m/s	100...39370 SFPM
Accuracy in air at 7 bar (abs) (101.5 psi) and 23°C (73°F) <sup>1)</sup>		± (1.5 % of measuring value + 0.5 % of full scale)			
Temperature dependency		± (0.1 % of measuring value/°C)			
Pressure dependency <sup>2)</sup>		0.5 % of measuring value / bar			
Response time t <sub>90</sub>		< 1 s			
Sample rate		0.1 s			
<b>Temperature</b>					
Measuring range		-20...80 °C (-4...176 °F)			
Accuracy at 20°C (68°F)		± 0.7 °C (1.26 °F)			

### Outputs

Signal range and measurands are freely configurable

Analogue output	Voltage	0 - 10 V	$0 < I_L < 1 \text{ mA}$
	Current (3-wire)	0 - 20 mA and 4 - 20 mA	$R_L < 500 \text{ Ohm}$
Switch output		Potential-free, max. 44 V DC, 500 mA switching capacity	
Pulse output		Totalizer, pulse length: 0.02...2 s	

**Digital interface (optional)**

RS485	(EE771 = 1 unit load)
Protocol	Modbus RTU
Default settings	Baud rate 9600 <sup>3)</sup> , parity even, 1 stop bit, Modbus address 1
Protocol	M-Bus
Default settings	Baud rate 2400 <sup>4)</sup> , parity even, 1 stop bit, M-Bus address 1

**Input**

Dynamic pressure compensation	4 - 20 mA (2-wire; 15 V) input for pressure sensor
-------------------------------	--

**General**

Supply voltage	18 - 30 V AC/DC	
Current consumption, max	200 mA (with display)	
Temperature range	Ambient, storage:	-20...60 °C (-4...140 °F)
	Medium:	-20...80 °C (-4...176 °F)
Nominal pressure	16 bar (232 psi)	
Humidity	0...100 %RH, non-condensing	
Electrical connection	Cable gland M16 and screw terminals max. 1.5 mm <sup>2</sup> (AWG 16), optional with connector M12x1, 8 pole	
Electromagnetic compatibility	EN 61326-1 Industrial Environment FCC Part15 Class A	EN 61326-2-3 ICES-003 Class A
Material	Enclosure Metal (AlSi <sub>3</sub> Cu)	
	Probe	Stainless steel
	Sensor head	Stainless steel / glass
	Measurement valve	Brass
Enclosure protection rating	IP65 / NEMA 4	



- 1) The accuracy statement includes the uncertainty of the factory calibration with an enhancement factor k=2 (2-times standard deviation). The accuracy was calculated in accordance with EA-4/02 and with regard to GUM (Guide to the Expression of Uncertainty in Measurement). The accuracy specifications apply when using inlet and outlet sections of suitable length, see accessories and User Manual
- 2) The flow sensor is calibrated at 7 bar (abs) (101.5 psi). At other working pressure the error can be compensated by setting the actual pressure with the configuration software.
- 3) Supported baud rates: 9600, 19200, 38400 and 57600; find more details about communication setting in the User Manual and the Modbus Application Note at [www.epluse.com/EE771](http://www.epluse.com/EE771).
- 4) Supported baud rates: 600, 1200, 2400, 4800 and 9600; find more details about communication setting in the User Manual.

**9.1. Factory Setting of Outputs****SI Unit**

Analogue output [0 - 10 V / 0(4) - 20 mA]		from	to		unit
			Low (HV31)	High (HV32)	
Standardized volumetric flow	DN15:	0	60	120	m <sup>3</sup> /h
	DN20:	0	110	220	m <sup>3</sup> /h
	DN25:	0	175	350	m <sup>3</sup> /h
	DN32:	0	285	570	m <sup>3</sup> /h
	DN40:	0	450	900	m <sup>3</sup> /h
	DN50:	0	700	1400	m <sup>3</sup> /h
Mass flow	DN15:	0	75	150	kg/h
	DN20:	0	140	280	kg/h
	DN25:	0	220	440	kg/h
	DN32:	0	360	720	kg/h
	DN40:	0	570	1140	kg/h
	DN50:	0	890	1780	kg/h
Standardized flow	≤DN50	0	100	200	m/s
Temperature	all Ø	-20	80	80	°C

**Switching output**

		[switching point/hysteresis]			
Standardized volumetric flow	DN15	50/5	100/10		m <sup>3</sup> /h
	DN20	90/9	180/18		m <sup>3</sup> /h
	DN25:	150/15	300/30		m <sup>3</sup> /h
	DN32:	230/23	460/46		m <sup>3</sup> /h
	DN40:	360/36	720/72		m <sup>3</sup> /h
	DN50:	560/56	1120/112		m <sup>3</sup> /h
Mass flow	DN15:	60/6	120/12		kg/h
	DN20:	110/11	220/22		kg/h
	DN25:	200/20	400/40		kg/h
	DN32:	290/29	580/58		kg/h
	DN40:	460/46	920/92		kg/h
	DN50:	700/70	1400/140		kg/h
Standardized flow	≤DN50	80/8	180/18		m/s
Temperature	all Ø	30/3	70/7		°C

Pulse output	pulse-value = 1 m <sup>3</sup>	pulse duration = 0.1 s
--------------	--------------------------------	------------------------

## US Unit

Analogue output [0 - 10 V / 0(4) - 20 mA]

		from	to		unit
			Low (HV31)	High (HV33)	
Standardized volumetric flow	DN15:	0	35	70	SCFM
	DN20:	0	60	120	SCFM
	DN25:	0	100	200	SCFM
	DN32:	0	165	330	SCFM
	DN40:	0	260	520	SCFM
	DN50:	0	410	820	SCFM
Mass flow	DN15:	0	75	150	kg/h
	DN20:	0	140	280	kg/h
	DN25:	0	220	440	kg/h
	DN32:	0	360	720	kg/h
	DN40:	0	570	1140	kg/h
	DN50:	0	890	1780	kg/h
Standardized flow	≤DN50	0	20000	40000	SFPM
Temperature	alle Ø	-4	176	176	°F

## Switching output

		[switching point/hysteresis]			
Standardized volumetric flow	DN15	30/3		60/6	SCFM
	DN20	50/5		100/10	SCFM
	DN25:	80/8		160/16	SCFM
	DN32:	130/13		260/26	SCFM
	DN40:	210/21		420/42	SCFM
	DN50:	330/33		660/66	SCFM
Mass flow	DN15:	60/6		120/12	kg/h
	DN20:	110/11		220/22	kg/h
	DN25:	200/20		400/40	kg/h
	DN32:	290/29		580/58	kg/h
	DN40:	460/46		920/92	kg/h
	DN50:	700/70		1400/140	kg/h
Standardized flow	≤DN50	15000/1500		30000/3000	SFPM
Temperature	all Ø	90/9		150/15	°F

Pulse output

pulse-value = 1CF

pulse-duration = 0.1 sec.

## CONFIGURATION SOFTWARE

### LIMITED LIABILITY

E+E Elektronik shall not be held liable for any damages or consequential damages (for example, but not restricted to, loss of earnings, interruption of business, loss of information and data or any other financial losses) resulting from the installation, use or impossibility of use of an E+E Elektronik software product and any associated support services or non-performance of support services.

## 1. General

The configuration software can be downloaded free of charge at [www.epluse.com/EE771](http://www.epluse.com/EE771)

The configuration software, allows for a user-friendly adaptation of the flow sensor to the application. In addition, the measurement values for flow and temperature can be calibrated / adjusted.

The system requirements for the installation and execution of the software are:

- Windows XP with SP3, Windows Vista or Windows 7
- .NET framework 3.5 with SP1
- USB 2.0 interface



During setup there will be no installation of .NET Framework 3.5 SP1 – if the required version is not already



installed on the computer the following error message will appear at the start of the configuration software. .NET Framework 3.5 SP1 can be installed using Windows Update.

## 2. Installation

In order to set up a smooth installation of the configuration software of the EE771, admin authorization for the personal computer is required.

- During installation of the software the EE771 should NOT be connected with the USB cable to the computer.
- With Setup.exe the InstallShield-Wizard for the EE771 configurator will be started.
- Follow the instructions on the screen to install the software.

**i** At first, the configuration software will be installed and then the installation of the USB driver activated – except if the user has defined that USB setup is disabled.  
The USB driver will be automatically installed the moment the first connection is made with the EE771.  
The appearing dialog boxes can be dealt with the settings “No. do not download driver from the internet” and “Install the hardware automatically”.

If the EE771 configuration software and the USB driver are installed correctly, and the EE771 is connected via the USB interface with the personal computer, a connection “Silicon Labs C210x USB to UART Bridge” should have been created in the device manager.

See: Start => Settings => Control Panel => System => Hardware => Device Manager

### 2.1. Configuration of the USB Interface (VirtualCOM)

After the startup of the software, the correct VirtualCOM interface for the USB driver must be configured

The number for the used USB interface can be found under:

Start => Settings => Control Panel => System => Hardware => Device Manager

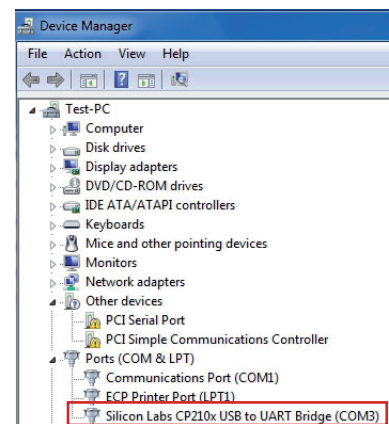
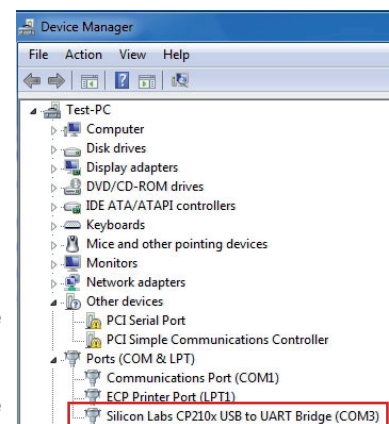

The setting is done under menu “Extras” and menu item “Optional extras ...”

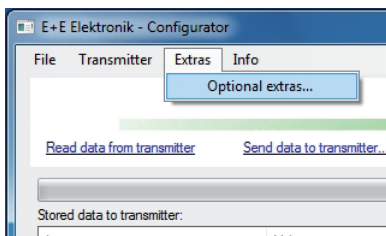

Select the COM-port number as shown in the device manager.

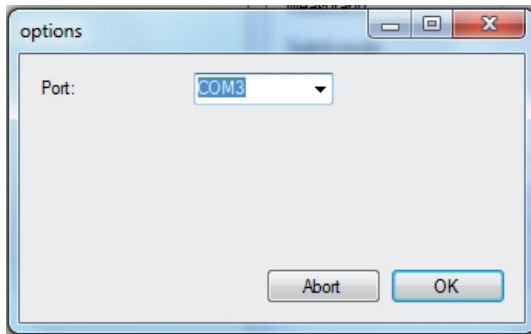

**i** These settings are done only once and at the first start of the configuration software. The settings are stored for future use.

### 3. User Interface

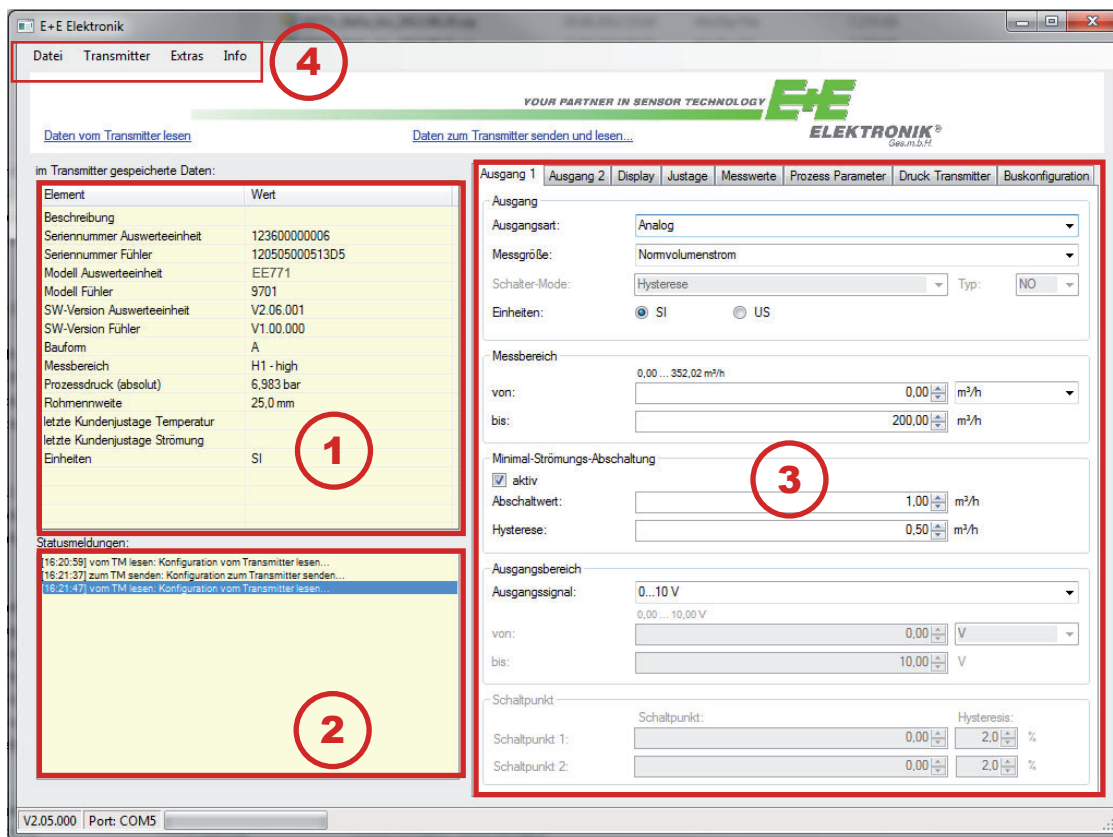

- 1** Basic information:  
After retrieving the data from the sensor, the basic information of the device is shown here.
- 2** Status message:  
Here are the messages shown about the status and other information.
- 3** Input screen:  
Input screen for the configuration or adjustment of the flow sensor.
- 4** Menu tool bar:  
Selection of menu items.



## 4. Menu Toolbar

### 4.1. File

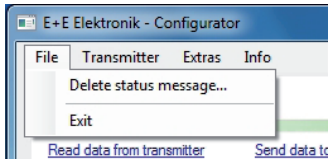

**Delete status message** deletes the status messages.

**Exit** closes the configuration software.

### 4.2. Transmitter

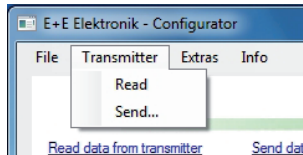

**i** Please note: The term “Transmitter” is used synonymously with “Sensor” in this user manual.

**Read** reads the actual configuration of the transmitter.

**Send** uploads the ‘new’ configuration to the transmitter. The following settings are uploaded to the transmitter

- Units
- Output 1
- Output 2
- Display mode
- Pressure transmitter

Prior to uploading the ‘new’ configuration to the transmitter, a dialog box will show a summary of the changes. Click on the button ‘OK’ and the configuration will be uploaded to the transmitter; click ‘Cancel’ to cancel the operation.

### 4.3. Extras

Configurations of the VirtualCOM interface (see page 23).

## 5. Input Screen

### 5.1. Output 1, Output 2

In this screen the actual settings of the transmitter for the output 1 and 2, resp. relay 1 and 2 are shown. The user can alter and upload these settings to the transmitter, together with other changes of the configuration.

#### 5.1.1. Output Mode

Here the mode of signal output can be determined.

Output 1: analogue or switch (relay) output

Output 2: switch (relay) or pulse output

**i** NOTE:  
In case the mode of output 1 is changed, the Jumper J1 on the board of the signal conditioning electronics has to be relocated as well (see page 25)

#### 5.1.2. Measurand

Here is determined which measurand will be represented at the particular output.

#### 5.1.3. Units

Choice of the engineering units of the selected measurand in either SI- (m/s; °C; m<sup>3</sup>/h) or US-units (SFPM; °F; SCFM).

**i** NOTE:  
The setting “Units” on the tabs for Output 1 and Output 2 are in sync with each other. If the units are changed on one of the output tabs, automatically the units on the other output tab are changed accordingly.

### 5.1.4. Output Mode – Analogue

Within the limits of measurement range and the scaling of the output, the analogue output can be freely configured and scaled. Either a standard output signal (0 – 5 V, 0 – 10 V, 0 – 20 mA, 4 – 20 mA) can be selected or a user defined range for the current / voltage output (e.g. 1 – 9 V).

**i** NOTE:  
In case the analogue output is changed (from current to voltage or vice versa), the Jumper J2 on the board of the signal conditioning electronics has to be relocated as well (see page 25).

### 5.1.5. Output Mode – Switch (Relay)

In the field for the “Switch-mode”, one can select “Hysteresis” or “Window”.

The field for “Type” is to determine the switch action of the relay, NO = Normally Open (activate to close), NC = Normally Close (activate to open).

Under “Measuring range” in the field “From” the low value of the measuring range can be entered and in the field “To” the high value.

The hysteresis of the set point is entered as a percentage of the measuring range.  
[measuring range] = high measuring value – low measuring value

e.g. hysteresis  
set point = 500 m<sup>3</sup>/h and reset point is 450 m<sup>3</sup>/h

Hysteresis = 50 m<sup>3</sup>/h = 0.5 % of measuring range

### Hysteresis

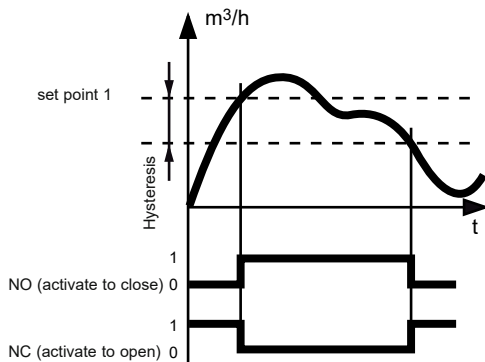

When the measurement value reaches **set point 1**, the relay will be activated. The value at the reset point is the value at set point 1 minus the hysteresis.

e.g. set point 1 = 100 m<sup>3</sup>/h and the hysteresis 5 m<sup>3</sup>/h.  
the relay switches at 100 m<sup>3</sup>/h. The reset point is at 96 m<sup>3</sup>/h.

Hysteresis = 5 m<sup>3</sup>/h = 5% of the measuring range

## Window

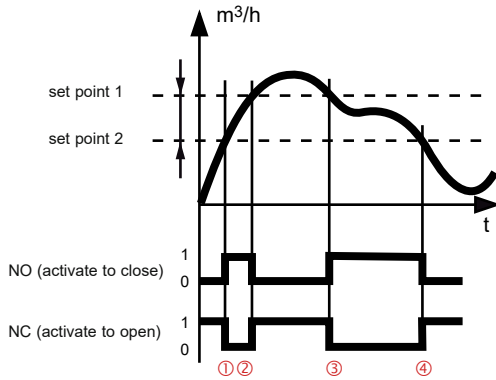

The relay is activated as long as the measuring value is between the values of **set point 1** and **set point 2**. The hysteresis of each set point is fixed at 0.2% of the measuring range.

e.g.: set point 1 = 100 m<sup>3</sup>/h; set point 2 = 80 m<sup>3</sup>/h;  
hysteresis of each set point is 1 m<sup>3</sup>/h (0.2% of 500 m<sup>3</sup>/h)

set point		Hysteresis		Measuring range	
set point 1:	100.0000	0.2	%	From:	0.0000
set point 2:	80.0000	0.2	%	To:	500.0000

- ① 80 m<sup>3</sup>/h = set point 2
- ② 100 m<sup>3</sup>/h = set point 1
- ③ 99 m<sup>3</sup>/h = set point 1 - hysteresis
- ④ 79 m<sup>3</sup>/h = set point 2 - hysteresis

### 5.1.6. Output Mode – Pulse

If output 2 is configured for pulse, the measurand can be consumption only. Under “Pulse”, the duration of the pulse and the pulse value (Significance level of pulse) can be freely configured.

$$\frac{\text{Volume Flow [m}^3\text{/h]}}{\text{Pulse Value [m}^3\text{/Pulse]}} = \frac{\text{Number of Pulses}}{\text{Hour}}$$

The duration of the pulse can be set between 0.02 and 2 seconds.

Pulse	
Pulse duration:	0.02 ... 2.00 sec
	0.10 sec
pulse-value:	0.001 ... 1,000,000.000 m <sup>3</sup>
	1.000 m <sup>3</sup>

e.g. Duration of pulse = 100ms; one pulse for each m<sup>3</sup> consumed

The pulse – interval – ratio must be at least 1 : 2, meaning that the duration of the pulse interval must be at least twice the duration of the pulse itself.

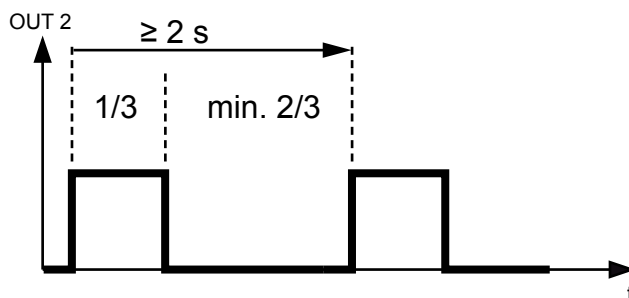

### Calculation of the minimum “pulse value” or the maximum “pulse duration”.

$$\text{IMPW\_MIN} = \text{NORMV\_MAX [m}^3\text{/h]} * \text{IMPL [s]} / 1200$$

$$\text{IMPL\_MAX} = \text{IMPW [m}^3\text{]} * 1200 / \text{NORMV\_MAX [m}^3\text{/h]}$$

IMPW	pulse value [m <sup>3</sup> ]
IMPL	pulse length (duration) [s]
IMPW_MIN	minimum pulse value [m <sup>3</sup> ]
IMPL_MAX	maximum pulse length (duration)
NORMV_MAX	expected maximum volume flow (m <sup>3</sup> /h)

## 5.2. Minimum Flow Shutdown

The minimum flow shutdown is switched on and off using the “active” checkbox.

If the output signal is ≤ than the set “Shutdown value”, the flow sensor issues 0 on the analogue output.

Low flow cut-off	
<input checked="" type="checkbox"/> active	
Threshold:	50.00 m <sup>3</sup> /h
Hysteresis:	10.00 m <sup>3</sup> /h

### 5.3. Display

If an optional display is installed, at the tab Display the following items can be entered:

Drop-down input field "Display-Mode"

- Single spaced
- Double spaced (default)

Checkbox "Backlight"

- Checked = ON
- Unchecked = OFF

Item	Value
Description	Halle 1
Serial number EE771	999999999993
Serial number probe	0000/P00000.0000
Model EE771	E771
Model probe	9701
SW-Version EE771	V0.00.010
SW-Version probe	V1.00.007

In the input field "Description (free text)", a user specific name (max. 16 characters) for the transmitter can be entered.  
e.g.: HALL 1

With the button "send" only the description will be uploaded to the transmitter.

### 5.4. Adjustment

The user can perform an adjustment for the measurands **normflow** and **temperature** in air.

The configuration software distinguishes between a 1-point and a 2-point adjustment automatically, depending on how many reference points for adjustments are entered.

The values entered for the customer's adjustment are stored in the electronics of the sensing probe and are therefore not lost if the electronics of the signal conditioning are replaced (see page 6)

If the checkbox "Performing customer-adjustment" is checked, the adjustment mode will be activated and the actual measuring value in the set interval automatically retrieved from the flow sensor (transmitter).

**i** NOTE: At first change to "Calibration gas" in the tab "Process parameters". While the customer-adjustment is active all other pages, functions and commands are deactivated.

In the field "Adjustment" the measurand to be adjusted is selected.

In the field "Measuring value" the actual measurement value of the transmitter is indicated.

The update-interval can be set.

In the field "Reference value" the measurement value of the standard is entered.

After clicking the button "send" a control dialog box appears in which the values can be corrected if needed. Then the reference value will be uploaded to the flow sensor (transmitter) and is the adjustment procedure complete.

The reference point of the customer-adjustment must be within the determined measuring range.

The customer-adjustment results in a slight rotation of the characteristic line, in such a way that the measurement deviation at the upper and lower adjustment points equals zero.

The configuration software determines, depending on its position, if it is an upper or lower adjustment point.

#### 5.4.1. 1-point Adjustment

	lower adjustment point	upper adjustment point
possibility 1	0 - 50 % of m.r.	100 % of m.r.
possibility 2	0 % of m.r.	>50 - 100 % of m.r.

m.r. ... measuring range

**upper adjustment point at 80% of measuring range**  
 lower adjustment point automatically at 0% of m.r.

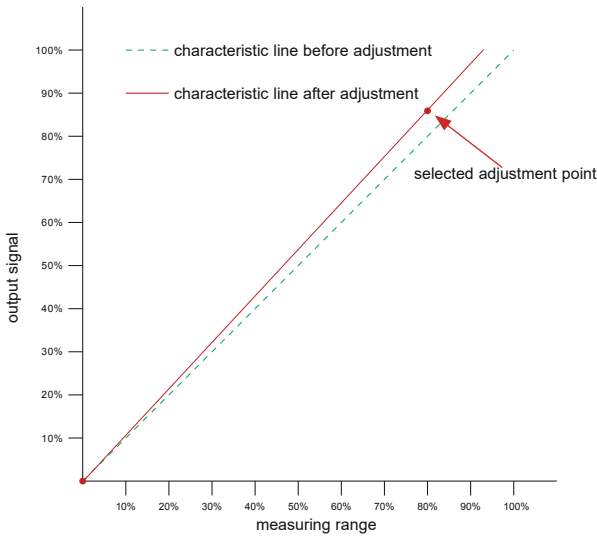

**lower adjustment point at 20% of measuring range**  
 upper adjustment point automatically at 100% of m.r.

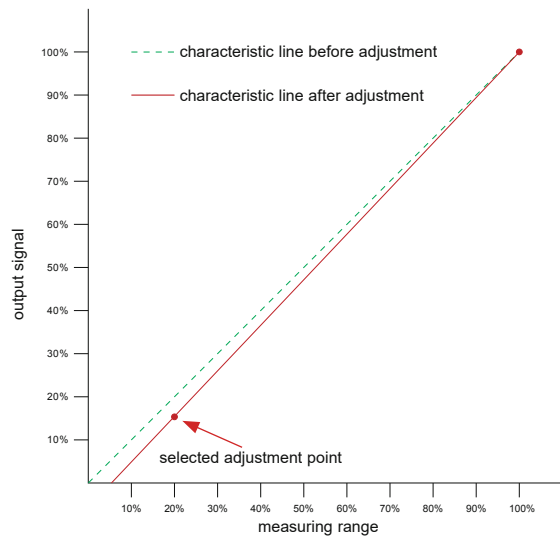

### 5.4.2. 2-point Adjustment

With a 2-point adjustment procedure the lower adjustment point must be between 0 and 40% of the measuring range, and the upper adjustment point between 60 and 100% of the measuring range. If the adjustment point is between 40 and 60% of the measuring range, automatically a 1-point adjustment procedure will be executed instead.

	lower adjustment point	upper adjustment point
possibility 1	0 - <40% of m.r.	60 - 100% of m.r.
possibility 2	40 - <50% of m.r.	100% of m.r.
possibility 3	0% of m.r.	50 - <60% of m.r.

**lower adjustment point at 10% of measuring range**  
 upper adjustment point at 90% of measuring range

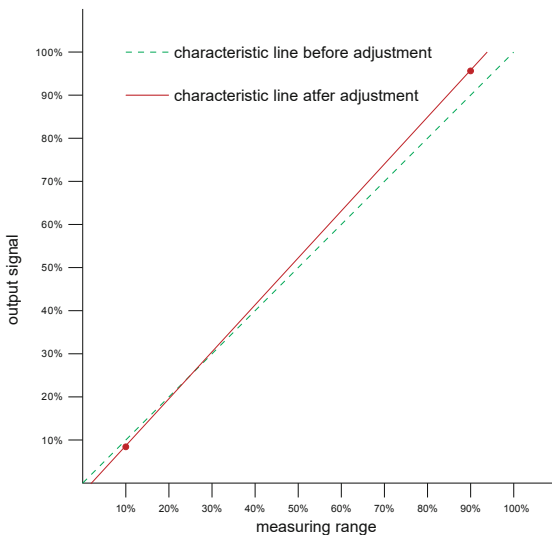

### 5.4.3. Reset to Factory Settings

Customer-adjustment can be reset to the factory settings by checking the appropriate checkbox and subsequently clicking the "reset" button.

Reset to factory adjustment

Temperature customer-adjustment

Air velocity customer-adjustment

## 5.5. Measuring Values Overview

The tab **measuring values** provides an overview of the retrieved actual measurement values of the flow sensor (transmitter). Clicking on “Fetch values” will retrieve the actual measurement and MIN / MAX values for flow, volume flow, temperature, mass flow and pressure (only if a pressure transmitter is connected) from the transmitter – additionally the reading of the consumption meter is retrieved as well. Checking the “Polling” checkbox will retrieve the measuring data from the transmitter at the selected interval.

Measurand	Actual	Min	Max	Unit
Air velocity	1,279	0,500	1,412	m/sec
Volumetric flow rate	9,006	0,247	9,939	m³/h
Temperature	23,58	16,05	26,66	°C
Mass flow	11,483	0,315	12,672	kg/h
Pressure	2,029	0,000	2,047	bar

### 5.5.1. Reset of the MIN / MAX Values

The MIN/ MAX values of each measurand, as stored in the flow sensor (transmitter), can be reset by checking the appropriate checkbox and subsequently clicking the “Clear MIN / MAX” button.

### 5.5.2. Reset of the Consumption Counter (Totalizer)

The reading of the consumption meter can be reset by clicking the “Reset meter” button.

## 5.6. Setting up Process Parameters

In the tab **Process Parameters** you can change the Process gas (medium) and set the pressure compensation

### 5.6.1. Change the Process Gas

**i** *NOTE: This function is only active if the flow sensor for a medium different from air has been ordered (see order code Medium in the data sheet)*

**Calibration-Gas:** Is the gas (medium) in which the flow sensor was calibrated in the factory. Unless otherwise specified, the flow sensor is calibrated at the factory always in air.

**Process-Gas:** Is the gas (medium) in the measured process. The adjustable process gases are set at the factory and can be selected from a list.

The flow sensor is factory set to the ordered gas (medium).

If the setting for the process-gas modified or changed between calibration- and process gas, the changed setting has to be sent to the transmitter. Use “send data to the transmitter and read ...” button.

The “active gas” to which the flow sensor is set, you can see in the field basic information.

Units	US
Process gas	CO2
Active gas	Calibration gas
Computation version	1

### 5.6.2. Changing the Standard Conditions

The flow sensor is factory-set to standard conditions conforming to DIN 1343.

**Factory setting:  $P_0 = 1013.25 \text{ mbar}$ ,  $t_0 = 0^\circ\text{C}$  (273.15 K)**

The corrected volume flow measured value is calculated in line with the standard conditions set.

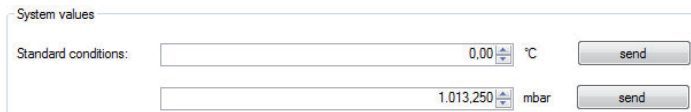

System values

Standard conditions:  °C

mbar

### 5.6.3. Pressure Compensation

The flow sensor is factory-adjusted to 7 bar (abs). At an operating pressure other than 7 bar (abs), the error can be corrected via the pressure coefficient of +0.5% of the measured value per bar by entering the actual system pressure.

The "Send" button is used only to send the process pressure to the transmitter.



Cycle pressure (absolute)  bar

### 5.7. External Pressure Sensor for Pressure Compensation

In order to achieve the highest accuracy, the input from an external pressure transmitter will be very useful if the pressure fluctuates strongly (e.g. 3 to 10 bar (45 to 150 psi)). An absolute pressure transmitter with a 2-wire loop powered 4 – 20 mA output should be used.

On the tab "Pressure transmitter" the measuring range can be entered.



Measuring range

Transmitter type:

From:  bar

To:

Output range

Output signal:

### 5.8. Bus Configuration

If the flow sensor is equipped with an optional bus module, the data transfer rate and the network address can be set on the "Bus configuration" tab.

The network address set is only used when the dip switches on the flow sensor PCB are set to 255 (see page 14).



Communication parameter

Baud rate:

Parity:

Stop bits:

Bus protocol:

Network address:



#### HEADQUARTERS

##### **E+E Elektronik Ges.m.b.H.**

Langwiesen 7  
4209 Engerwitzdorf  
Austria  
Tel.: +43 7235 605-0  
E-mail: [info@epluse.com](mailto:info@epluse.com)  
Web: [www.epluse.com](http://www.epluse.com)

#### SUBSIDIARIES

##### **E+E Elektronik China**

18F, Kaidi Financial Building,  
No.1088 XiangYin Road  
200433 Shanghai  
Tel.: +86 21 6117 6129  
E-mail: [info@epluse.cn](mailto:info@epluse.cn)

##### **E+E Elektronik France**

47 Avenue de l'Europe  
92310 Sèvres  
Tel.: +33 4 74 72 35 82  
E-mail: [info@epluse.fr](mailto:info@epluse.fr)

##### **E+E Elektronik Germany**

Obere Zeil 2  
61440 Oberursel  
Tel.: +49 6171 69411-0  
E-mail: [info@epluse.de](mailto:info@epluse.de)

##### **E+E Elektronik India**

801, Sakhi Vihar Road  
400072 Mumbai  
Tel.: +91 990 440 5400  
E-mail: [info.in@epluse.com](mailto:info.in@epluse.com)

##### **E+E Elektronik Italy**

Via Alghero 17/19  
20128 Milano (MI)  
Tel.: +39 02 2707 86 36  
E-mail: [info@epluse.it](mailto:info@epluse.it)

##### **E+E Elektronik Korea**

Suite 2001, Heungdeok IT  
Valley Towerdong, 13,  
Heungdeok 1-ro, Giheung-gu  
16954 Yongin-si, Gyeonggi-do  
Tel.: +82 31 732 6050  
E-mail: [info@epluse.co.kr](mailto:info@epluse.co.kr)

##### **E+E Elektronik USA**

333 East State Parkway  
Schaumburg, IL 60173  
Tel.: +1 847 490 0520  
E-mail: [office@epluse.com](mailto:office@epluse.com)

YOUR PARTNER IN SENSOR TECHNOLOGY

**E+E**  
**ELEKTRONIK®**  
Ges.m.b.H.