

Operating Instructions

RIA452

Process indicator
with pump control



Table of contents

1	Document information	4	10.4	Disposal	47
1.1	Document conventions	4	11	Accessories	47
2	Safety instructions	6	11.1	Device-specific accessories	47
2.1	Requirements for the personnel	6	12	Technical data	48
2.2	Intended use	6	12.1	Input	48
2.3	Operational safety	7	12.2	Output	49
2.4	Product safety	7	12.3	Power supply	51
2.5	IT security	7	12.4	Performance characteristics	53
3	Incoming acceptance and product identification	7	12.5	Installation	54
3.1	Product identification	8	12.6	Environment	54
3.2	Storage and transport	8	12.7	Mechanical construction	55
3.3	Certificates and approvals	9	12.8	Operability	57
4	Installation	9	12.9	Certificates and approvals	58
4.1	Installation conditions	9	12.10	Supplementary documentation	58
4.2	Mounting the indicator	9	13	Appendix	58
5	Electrical connection	10	13.1	Flow conversion	58
5.1	Universal input option	12	Index	59	
5.2	Connecting the process indicator	12			
5.3	Post-connection check	15			
6	Operation options	15			
6.1	Overview of operation options	15			
6.2	Structure and function of the operating menu	17			
6.3	Access to the operating menu via the local display	18			
7	Commissioning	21			
7.1	Function check	21			
7.2	Switching on the measuring device	21			
7.3	Configuring the measuring device	21			
8	Diagnostics and troubleshooting ...	43			
8.1	Troubleshooting instructions	43			
8.2	Process error messages	43			
8.3	Firmware history	44			
9	Maintenance	45			
9.1	Cleaning	45			
10	Repair	45			
10.1	General information	45			
10.2	Spare parts	45			
10.3	Return	47			

1 Document information

1.1 Document conventions

1.1.1 Safety symbols

DANGER

This symbol alerts you to a dangerous situation. Failure to avoid this situation will result in serious or fatal injury.

WARNING

This symbol alerts you to a dangerous situation. Failure to avoid this situation can result in serious or fatal injury.





CAUTION

This symbol alerts you to a dangerous situation. Failure to avoid this situation can result in minor or medium injury.







NOTICE







This symbol contains information on procedures and other facts which do not result in personal injury.

1.1.2 Electrical symbols





Symbol	Meaning
	Direct current
	Alternating current
	Direct current and alternating current
	Ground connection A grounded terminal which, as far as the operator is concerned, is grounded via a grounding system.
	Potential equalization connection (PE: protective earth) Ground terminals that must be connected to ground prior to establishing any other connections. The ground terminals are located on the interior and exterior of the device: <ul style="list-style-type: none"> ▪ Interior ground terminal: potential equalization is connected to the supply network. ▪ Exterior ground terminal: device is connected to the plant grounding system.

1.1.3 Symbols for certain types of information

Symbol	Meaning
	Permitted Procedures, processes or actions that are permitted.
	Preferred Procedures, processes or actions that are preferred.
	Forbidden Procedures, processes or actions that are forbidden.
	Tip Indicates additional information.
	Reference to documentation
	Reference to page

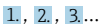
Symbol	Meaning
	Reference to graphic
	Notice or individual step to be observed
	Series of steps
	Result of a step
	Help in the event of a problem
	Visual inspection

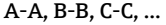
1.1.4 Symbols in graphics

Symbol	Meaning	Symbol	Meaning
	Item numbers		Series of steps
	Views		Sections
	Hazardous area		Safe area (non-hazardous area)

1.1.5 Documentation

 For an overview of the scope of the associated Technical Documentation, refer to the following:

- *Device Viewer* (www.endress.com/deviceviewer): Enter the serial number from the nameplate
- *Endress+Hauser Operations app*: Enter serial number from nameplate or scan matrix code on nameplate.

Document function

The following documentation may be available depending on the version ordered:

Document type	Purpose and content of the document
Technical Information (TI)	Planning aid for your device The document contains all the technical data on the device and provides an overview of the accessories and other products that can be ordered for the device.
Brief Operating Instructions (KA)	Guide that takes you quickly to the 1st measured value The Brief Operating Instructions contain all the essential information from incoming acceptance to initial commissioning.
Operating Instructions (BA)	Your reference document The Operating Instructions contain all the information that is required in the various phases of the life cycle of the device: from product identification, incoming acceptance and storage, to mounting, connection, operation and commissioning through to troubleshooting, maintenance and disposal.
Description of Device Parameters (GP)	Reference for your parameters The document provides a detailed explanation of each individual parameter. The description is aimed at those who work with the device over the entire life cycle and perform specific configurations.

Document type	Purpose and content of the document
Safety Instructions (XA)	Depending on the approval, safety instructions for electrical equipment in hazardous areas are also supplied with the device. The Safety Instructions are an integral part of the Operating Instructions.  Information on the Safety Instructions (XA) relevant to the device is provided on the nameplate.
Supplementary device-dependent documentation (SD/FY)	Always comply strictly with the instructions in the relevant supplementary documentation. The supplementary documentation is an integral part of the device documentation.

1.1.6 Registered trademarks

HART®

Registered trademark of HART Communication Foundation, Austin, USA

Applicator®, FieldCare®, Field Xpert™, HistoROM®

Registered or registration-pending trademarks of the Endress+Hauser Group

2 Safety instructions

2.1 Requirements for the personnel

The personnel for installation, commissioning, diagnostics and maintenance must fulfill the following requirements:

- ▶ Trained, qualified specialists must have a relevant qualification for this specific function and task.
- ▶ Are authorized by the plant owner/operator.
- ▶ Are familiar with federal/national regulations.
- ▶ Before starting work, read and understand the instructions in the manual and supplementary documentation as well as the certificates (depending on the application).
- ▶ Follow instructions and comply with basic conditions.

The operating personnel must fulfill the following requirements:

- ▶ Are instructed and authorized according to the requirements of the task by the facility's owner-operator.
- ▶ Follow the instructions in this manual.

2.2 Intended use

The process indicator evaluates analog process variables and displays them on its multicolored screen. Processes can be monitored and controlled with the device's outputs and limit relays. The device is equipped with a wide array of software functions for this purpose. Power can be supplied to 2-wire sensors with the integrated transmitter power supply.

- The device is an associated apparatus and may not be installed in the hazardous area.
- The manufacturer accepts no liability for damages resulting from improper or non-designated use. The device may not be converted or modified in any way.
- The device is designed for installation in a panel and must only be operated in an installed state.

2.3 Operational safety

Risk of injury!

- ▶ Operate the device only if it is in proper technical condition, free from errors and faults.
- ▶ The operator is responsible for interference-free operation of the device.

Modifications to the device

Unauthorized modifications to the device are not permitted and can lead to unforeseeable dangers:

- ▶ If modifications are nevertheless required, consult with the manufacturer.

Repair

To ensure continued operational safety and reliability:

- ▶ Carry out repairs on the device only if they are expressly permitted.
- ▶ Observe federal/national regulations pertaining to the repair of an electrical device.
- ▶ Use only original spare parts and accessories from the manufacturer.

2.4 Product safety

This measuring device is designed in accordance with good engineering practice to meet state-of-the-art safety requirements, has been tested, and left the factory in a condition in which it is safe to operate.

It meets general safety standards and legal requirements. It also complies with the EC directives listed in the device-specific EC Declaration of Conformity. The manufacturer confirms this by affixing the CE mark to the device.

2.5 IT security

Our warranty is valid only if the product is installed and used as described in the Operating Instructions. The product is equipped with security mechanisms to protect it against any inadvertent changes to the settings.

IT security measures, which provide additional protection for the product and associated data transfer, must be implemented by the operators themselves in line with their security standards.

3 Incoming acceptance and product identification

Proceed as follows on receipt of the device:

1. Check whether the packaging is intact.
2. If damage is discovered:
Report all damage immediately to the manufacturer.
3. Do not install damaged components, as the manufacturer cannot otherwise guarantee the material resistance or compliance with the original safety requirements, and can also not be held responsible for the consequences that may result.
4. Compare the scope of delivery against the contents of your order.
5. Remove all the packaging material used for transportation.
6. Do the data on the nameplate match the ordering information on the delivery note?

7. Are the technical documentation and all other necessary documents provided, e.g. certificates?

 If one of the conditions is not satisfied, contact your Sales Center.

3.1 Product identification

The following options are available for identification of the device:

- Nameplate specifications
- Enter the serial number from the nameplate in the *Device Viewer* (www.endress.com/deviceviewer): all the information about the device and an overview of the Technical Documentation supplied with the device are displayed.
- Enter the serial number on the nameplate into the *Endress+Hauser Operations App* or scan the 2-D matrix code (QR code) on the nameplate with the *Endress+Hauser Operations App*: all the information about the device and the technical documentation pertaining to the device is displayed.

3.1.1 Nameplate

The right device?

The nameplate provides you with the following information on the device:

- Manufacturer identification, device designation
- Order code
- Extended order code
- Serial number
- Tag name (TAG)
- Technical values: supply voltage, current consumption, ambient temperature, communication-specific data (optional)
- Degree of protection
- Approvals with symbols

► Compare the information on the nameplate with the order.

3.1.2 Name and address of manufacturer

Name of manufacturer:	Endress+Hauser Wetzlar GmbH + Co. KG
Address of manufacturer:	Obere Wank 1, D-87484 Nesselwang or www.endress.com

3.2 Storage and transport

Storage temperature

-30 to +70 °C (-22 to +158 °F)



Maximum relative humidity: < 95 % as per IEC 60068-2-30

 Pack the device for storage and transportation in such a way that it is reliably protected against impact and external influences. The original packaging offers the best protection.

Avoid the following environmental influences during storage:

- direct sunlight
- proximity to hot objects
- mechanical vibration
- aggressive media

3.3 Certificates and approvals



-  For certificates and approvals valid for the device: see the data on the nameplate
-  Approval-related data and documents: www.endress.com/deviceviewer → (enter the serial number)

4 Installation

4.1 Installation conditions

The permitted ambient conditions must be observed during installation and operation (see the "Technical data" section of the Operating Instructions). The device must be protected from exposure to heat.

4.1.1 Installation dimensions

Required panel cutout 92 mm (3.62 in)x92 mm (3.62 in). Ensure an installation depth of 150 mm (5.91 in) for the device plus cable. For additional dimensions, see →  1,  9 and the "Technical data" section of the Operating Instructions.

4.1.2 Mounting location

Installation in a panel. The mounting location must be free from vibrations. A suitable electrical, fire-proof and mechanical enclosure must be provided.

4.1.3 Orientation

Horizontal, $\pm 45^\circ$ in every direction.

4.2 Mounting the indicator

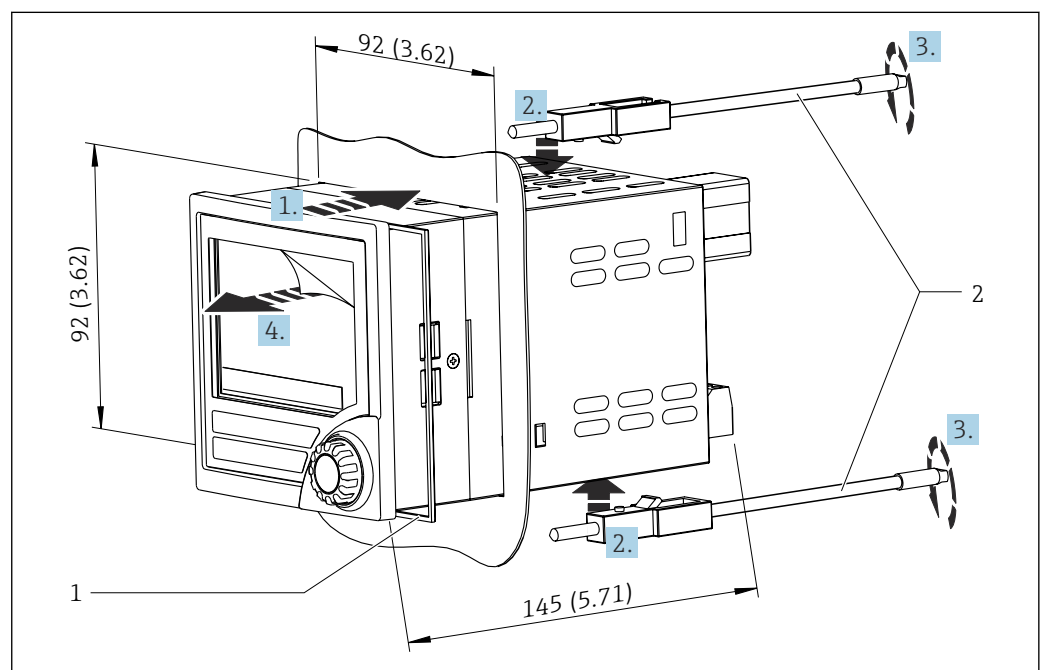

 1 Installation in a panel

A0031247

Mounting the indicator

1. Push the device with the sealing ring (item 1) through the panel cutout from the front.
2. Hold the device level and clip the fastening clips (item 2) into the openings provided.
3. Tighten the screws of the fastening clips uniformly using a screwdriver.
4. Remove the protective foil from the display.

5 Electrical connection

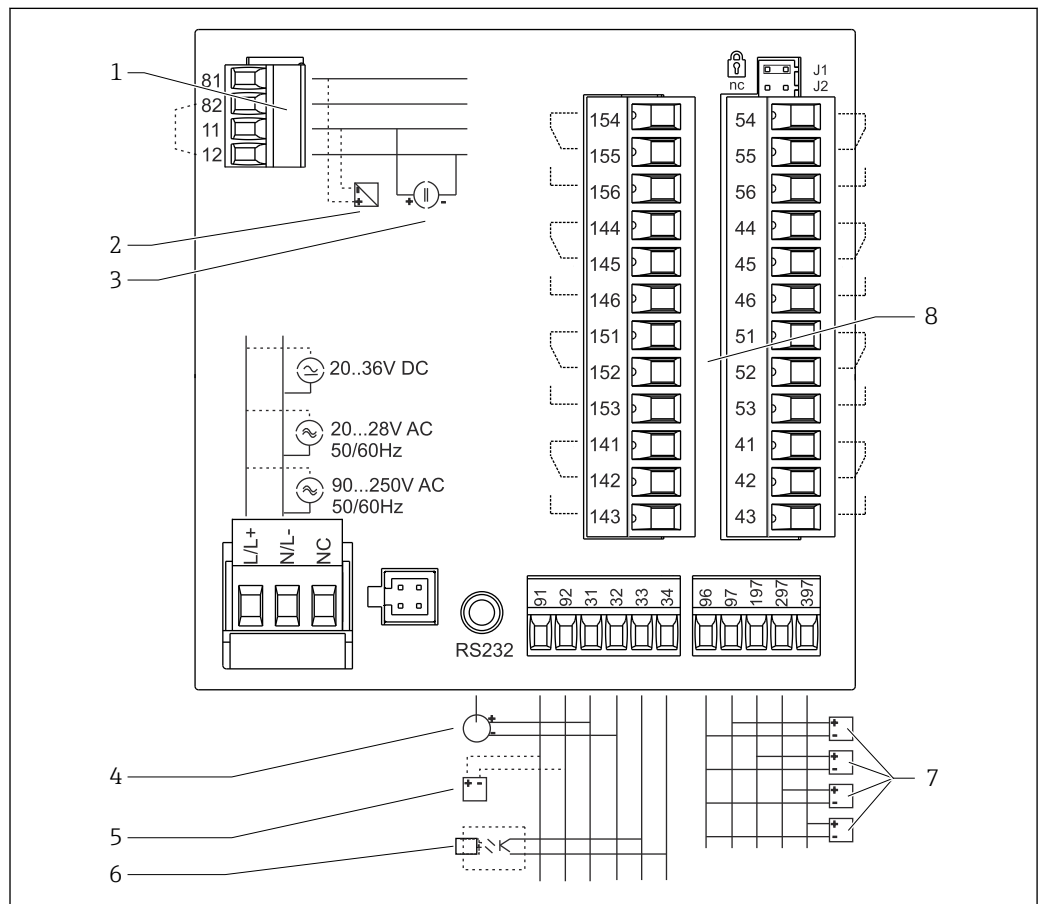

2 Terminal assignment of process indicator. Internal circuits illustrated as dotted lines.

- | | |
|--|---|
| <ol style="list-style-type: none"> 1 Current input, terminals 12 and 82 jumpered internally. 2 Current loop, transmitter power supply max. 22 mA current input 3 Current input 0 to 20 mA 4 Analog output 0 to 20 mA, 0 to 10 V_{DC} 5 Transmitter power supply, 24 V, ≤250 mA. | <ol style="list-style-type: none"> 6 Digital output, passive open collector, max. 28 V, 200 mA 7 Digital inputs according to DIN 19240; voltage level: -3 to 5 V low, 12 to 30 V high, input current typ. 3 mA (with overload and polarity reversal protection), input voltage max. 34.5 V, scanning frequency max. 10 Hz 8 Relay output: relay 1-8; 250 V_{AC}/30 V_{DC}, 3 A |
|--|---|

Terminal	Terminal assignment	Description
L/L+	L for AC L+ for DC	Power supply
N/L-	N for AC L- for DC	

Terminal	Terminal assignment	Description
NC	Not connected	
J1	Jumper for locking device operation via hardware. If the jumper is set to J1, the setting cannot be modified.	The device can always be configured with the PC software via RS232 even if the jumper is set to J1.
J2	Not connected	
11	+0/4 to 20 mA	Current input
12	Signal ground (current)	
81	24 V sensor power supply 1	Transmitter power supply (intrinsically safe if required)
82	Ground, sensor power supply 1	
41	Normally closed (NC)	Relay 1
42	Common (COM)	
43	Normally open (NO)	
51	Normally closed (NC)	Relay 2
52	Common (COM)	
53	Normally open (NO)	
44	Normally closed (NC)	Relay 3
45	Common (COM)	
46	Normally open (NO)	
54	Normally closed (NC)	Relay 4
55	Common (COM)	
56	Normally open (NO)	
141	Normally closed (NC)	Relay 5
142	Common (COM)	
143	Normally open (NO)	
151	Normally closed (NC)	Relay 6
152	Common (COM)	
153	Normally open (NO)	
144	Normally closed (NC)	Relay 7
145	Common (COM)	
146	Normally open (NO)	
154	Normally closed (NC)	Relay 8
155	Common (COM)	
156	Normally open (NO)	
96	Ground for digital status inputs	Digital inputs
97	+ digital status input 1	
197	+ digital status input 2	
297	+ digital status input 3	
397	+ digital status input 4	
31	+ analog output	Analog output (optional)
32	Ground, analog output	
33	+ digital output	Digital output (optional)
34	Ground, digital output	

Terminal	Terminal assignment	Description
91	24 V sensor power supply 2	Transmitter power supply
92	Ground, sensor power supply 2	

5.1 Universal input option

The device can be optionally equipped with a universal input instead of the current input.

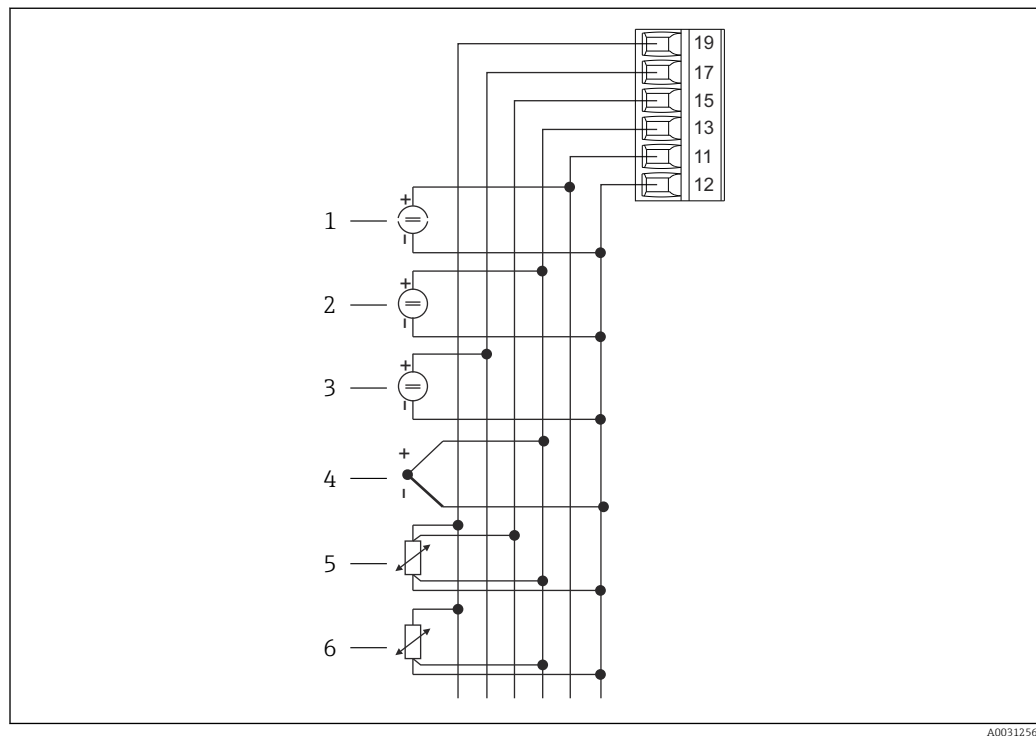

3 Universal input terminal assignment

- | | | | |
|---|----------------------------|---|----------------------|
| 1 | Current input 0/4 to 20 mA | 4 | Thermocouples |
| 2 | Voltage input ± 1 V | 5 | RTD assembly, 4-wire |
| 3 | Voltage input ± 30 V | 6 | RTD assembly, 3-wire |

Terminal	Terminal assignment
11	+0/4 to 20 mA signal
12	Signal ground (current, voltage, temperature)
13	+1 V, + thermocouples, - RTD assembly signal (3-wire/4-wire)
15	+ RTD assembly signal (4-wire)
17	+30 V
19	+ RTD assembly power supply (3-wire/4-wire)

5.2 Connecting the process indicator

⚠ WARNING

Danger! Electric voltage!

- ▶ The entire connection of the device must take place while the device is de-energized.

5.2.1 Connecting the power supply

- Before wiring the device, ensure that the supply voltage corresponds to the specification on the nameplate.
- For the 90 to 250 V_{AC} version (mains connection), a switch marked as a circuit breaker, as well as an overload protection device (rated power ≤ 10 A) must be fitted in the supply line near the device (easy to reach).
- For version 20 to 35 V_{DC} or 20 to 28 V_{AC}: The device must be powered only by a power unit that operates using a limited energy circuit in accordance with UL/EN/IEC 61010-1, Section 9.4 and the requirements in Table 18.

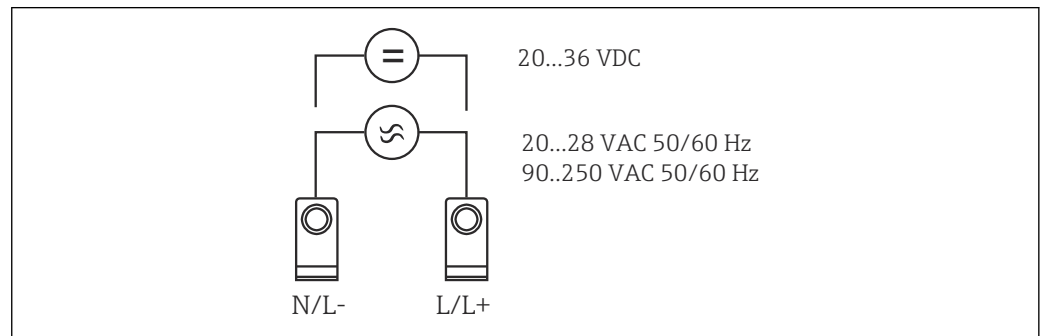

A0031259

4 Connecting the power supply

5.2.2 Connecting the external sensors

- i** Active and passive sensors with analog, TC, resistance and RTD sensors can be connected to the device.

Current input 0/4 to 20 mA

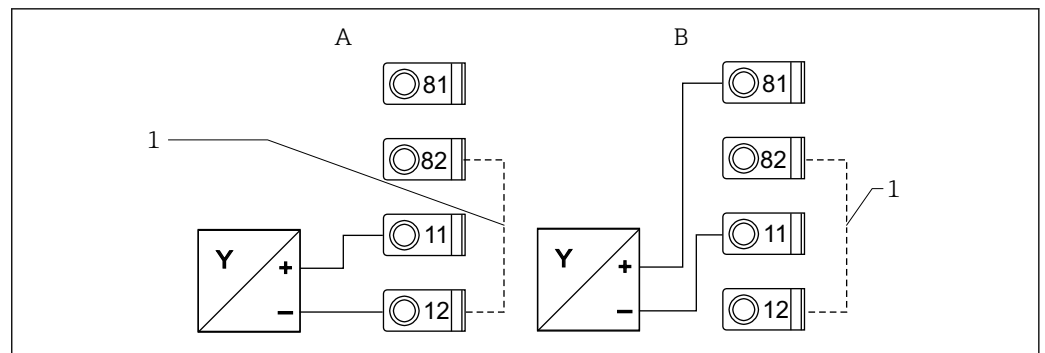

A0031272

5 Connection of 2-wire sensor to current input 0/4 to 20 mA

- A Active sensor
 B Passive sensor
 1 Terminal 12 and 82 jumpered internally

Universal input

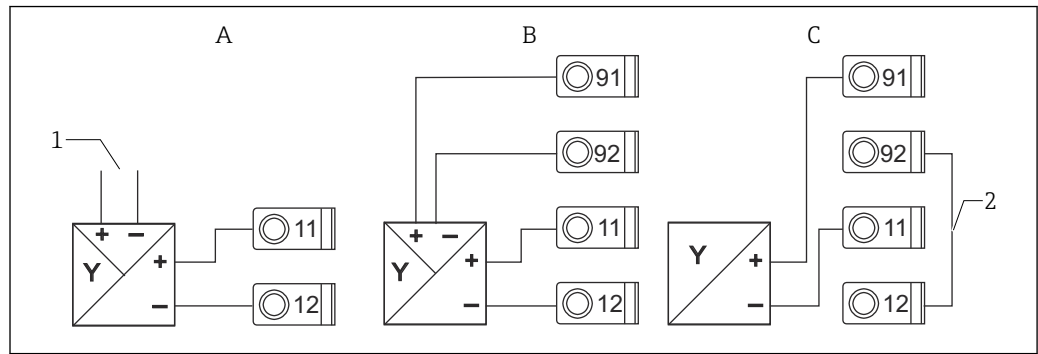

A0031273

6 Connection of 4-wire sensor, transmitter power supply and universal input

- A Active sensor, 4-wire
- 1 Supply
- B Active sensor, 4-wire - Power supply via RIA452
- C Passive sensor, 2-wire
- 2 Terminal 12 and 92 jumpered externally

Power supply in the hazardous area

RIA452 + RB223

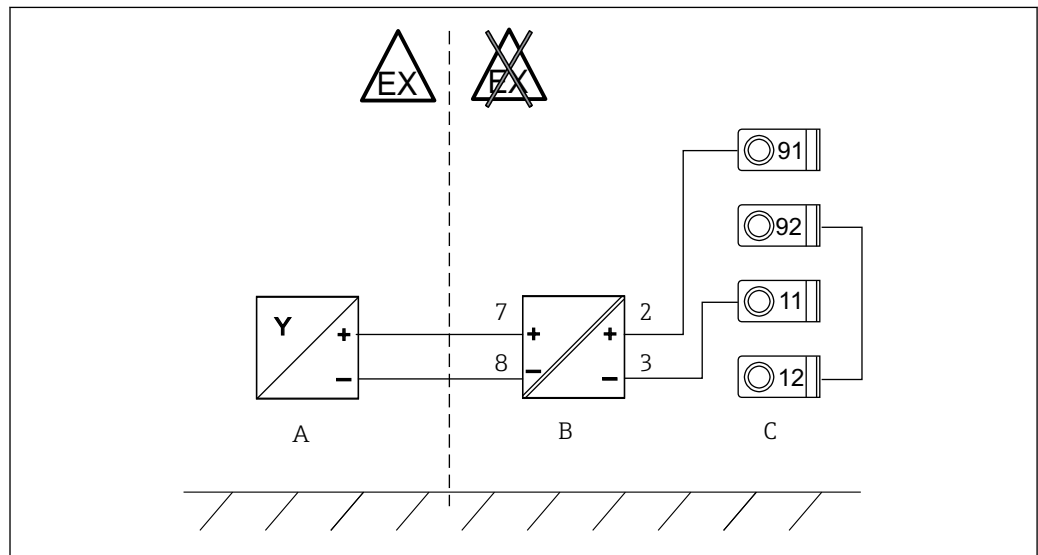

A0045169

7 Connection of 2-wire sensor in the hazardous area to current input 0/4 to 20 mA via RB223

- A Passive sensor, 2-wire
- B RB223 Ex passive barrier
- C Process indicator RIA452 (jumper required for terminal 12 and 92)

i Pay attention to the transmitter power supply! A loop check should also be carried out at the maximum loop current.

RIA452 + RN22

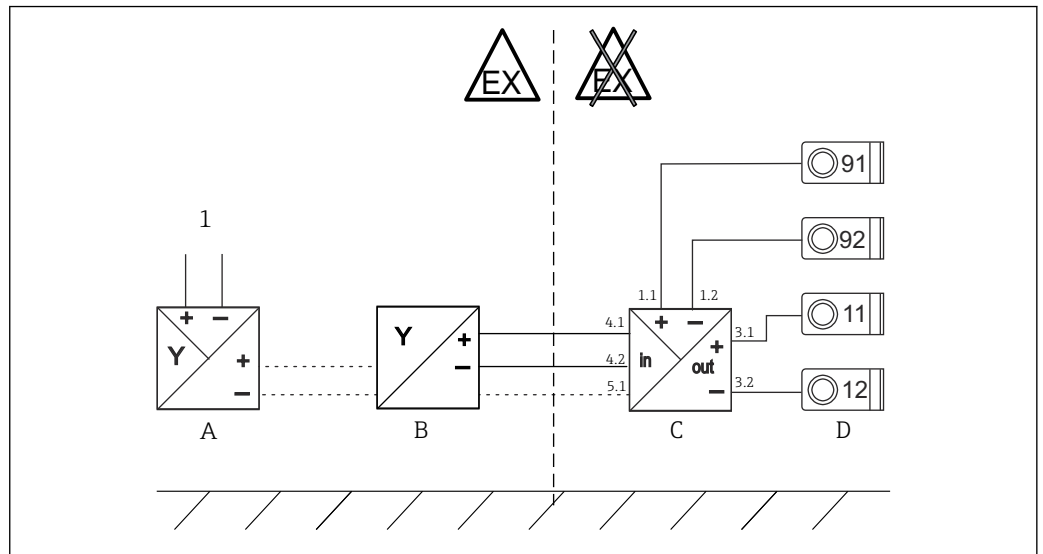

A0051932

8 Connection of 2- or 4-wire sensor in the hazardous area to current input 0/4 to 20 mA via RN22

- A Active sensor, 4-wire
- 1 Supply
- B Passive sensor, 2-wire
- C RN22 Ex passive barrier
- D Process indicator RIA452

i Pay attention to the transmitter power supply! A loop check should also be carried out at the maximum loop current.

5.3 Post-connection check

Device condition and specification	Notes
Is the device or cable damaged (visual inspection)?	-

Electrical connection	Notes
Does the supply voltage match the specifications on the nameplate?	90 to 250 V _{AC} (50/60 Hz) 20 to 36 V _{DC} 20 to 28 V _{AC} (50/60 Hz)
Are all terminals firmly engaged in their correct slot? Is the coding on the individual terminals correct?	-
Are the mounted cables strain-relieved?	-
Are the power supply and signal cables correctly connected?	See wiring diagram on the housing
Are all of the screw terminals well tightened?	-

6 Operation options

6.1 Overview of operation options

6.1.1 Display and operating elements

i Remove the protective film from the display as this would otherwise affect the readability of the display.

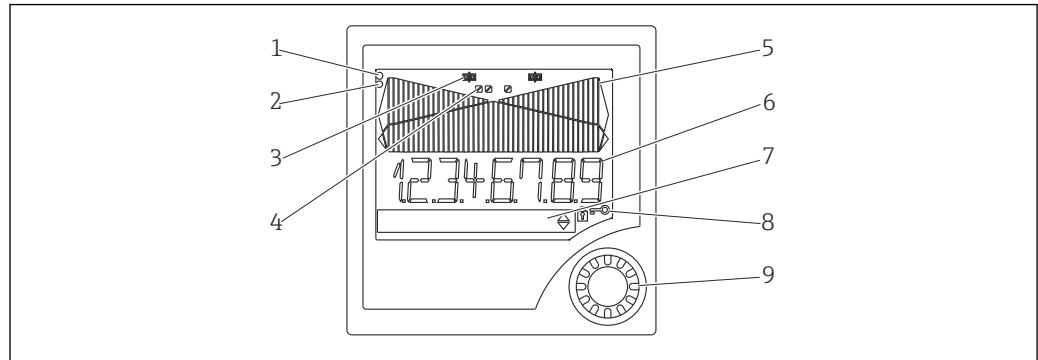

A0031274

9 Display and operating elements

- 1 Operational indicator, green, is lit when supply voltage is applied
- 2 Fault indicator, red, flashes in the event of a sensor or device error
- 3 Limit indicator: the symbol is displayed if a relay is energized.
- 4 Status of digital inputs: green indicates ready for operation, yellow indicates a signal is pending
- 5 Bar graph, yellow, 42-part, with overranging and underranging in orange/red
- 6 7-digit, 14-segment display, white for measured values
- 7 9x77 dot matrix display, white, for texts, units and menu icons
- 8 Key and padlock symbols, indicate whether device operation is locked (see Section 5.3.3)
- 9 Jog/shuttle dial for local display operation

6.1.2 Display

i For troubleshooting information, see the "Troubleshooting" section → 43.

Range	Display	Relay	Analog output	Integration
Input current is below lower error limit	Display	Fault condition	Configured failure mode	No integration
Input current above lower error limit and below lower limit of validity	Display	Normal limit value behavior	Normal behavior with max. 10% overrange. No output < 0 mA/0 V possible	Normal behavior (negative integration not possible)
Input current in valid range	Display scaled measured value	Normal limit value behavior	Normal behavior with max. 10% overrange. No output < 0 mA/0 V possible	Normal behavior (negative integration not possible)
Input current below upper error limit and above upper limit of validity	Display	Normal limit value behavior	Normal behavior with max. 10% overrange. No output < 0 mA/0 V possible	Normal behavior (negative integration not possible)
Input current above upper error limit	Display	Fault condition	Configured failure mode	No integration

Relay indicator

- Relay not energized: nothing indicated
- Relay energized: (symbol is lit)

Status display for digital inputs

- Digital input configured: (green)
- Signal at digital input: (yellow)

6.2 Structure and function of the operating menu

M1	Analog input INPUT	Signal type	Connection type*	Curve	Signal damping		
		Signal type	Connection	Curve	Damp		
		Unit	Decimal point	0% value	100% value		
	Dimension	Dec. point	0% value	100% value			
	Offset	Comparison temp*	Fixed comparison temperature*	Cable open circuit detection			
	Offset	Comp. temp.	Const. temp.	Open circ.			
M2	Display DISPLAY	Assignment numeric display	Alternating measured value display	Bar graph assignment	Decimal point bar graph		
		Ref. num.	Displ. sw.	Ref. bargraph	Dec. point		
		Bar graph 0% value	Bar graph 100% value	Bar graph assignment			
	Bar 0%	Bar 100%	Ref. bargraph				
M3	Analog output* ANALOG OUT	Assignment	Damping	Output range	Decimal point		
		Ref. num.	Out damp	Out range	Dec. point		
		0% value	100% value	Offset	Output in event of error		
	Out 0%	Out 100%	Offset	Fail mode			
	Failure value	Simulation mA	Simulation volt				
	Fail value	Simu mA	Simu V				
M5	Digital input 1-4 DIGITAL INP	Function digital input 1-4	Active level 1-4	Sampling duration pump monitoring			
	Function	Level		Sampl. time			
M10- M17	Limit 1-4 (8)* LIMIT	Assignment	Function 1-4 (8)	Decimal point	Switch point A	Switch point B	
		Ref. num	Function	Dec. point	Setpoint A	Setpoint B	
		Hysteresis or switch-back gradient	Switching delay 1-4 (8) in seconds	Alternating function 1-4	1st power-up after 24 h delayed by	1st power-up after 24 h switch-on duration	
	Hysteresis	Delay	Alternate	Sw. delay	Sw. period		
	Display the run time 1-8	Display the switching frequency 1-8	Reset the switching frequency and run time	Relay simulation			
	Runtime	Count	Reset	Simu relay			
M18	Integration* Integration	Signal source for integration	Preset counter	Integration base	Decimal point factor	Conversion factor	
		Ref. Integr.	Pre-counter	Integr. base	Dec. factor	Factor	
		Dimension totalizer	Decimal point totalizer	Set preset counter	Set preliminary alarm	Display totalizer	
		Dimension	Dec. point T	Set count A	Set count B	Totalizer	
		Reset totalizer	Flow calculation	Dimension input signal	Dimension of linearized value	Decimal point for formula	
	Reset total	Calc flow	Dim. Input	Dim. flow	Dec. flow		
	Decimal point for display	Alpha value	Beta value	Gamma value	C value		
	Dec. point	Alpha	Beta	Gamma	C		
	Khafagi-Venturi flumes	Iso-Venturi flumes	Venturi flumes as per British Standard	Parshall flumes	Parshall-Bowlus flumes		

		Kha Venturi	Iso-Venturi	BST-Venturi	Parshall	Parshall-Bow
		Rectangular weirs	Rectangular weirs with constriction	Rectangular weirs as per NFX	Rectangular weirs as per NFX with constriction	Trapezoidal weirs
		Rect. WTO	Rect. WThr	NFX Rect. WTO	NFX Rect. WThr	Trap. WTO
		Triangular weirs	Triangular weirs as per British Standard	Triangular weirs as per NFX	Width	
		V. weir	BST V. weir	NFX V. weir	width	
M19	Pulse output* PULSE OUT	Decimal point pulse value	Pulse value	Pulse width	Pulse output simulation	
		Dec value	Unit value	Pulse width	Sim pulseout	
M20	Min/Max memory MIN/MAX	Signal source for Min/ Max	Decimal point	Display minimum value		
		Ref. Min/Max	Dec. point	Min. value		
		Display maximum value	Reset minimum value	Reset maximum value		
		Max. value	Reset min	Reset max		
M21	Linearization table LIN-TABLE	Number of points	Dimension of linearized value	Decimal point Y-axis	Delete all linearization points	Show all linearization points
		Counts	Dimension	Dec. Y value	Del points	Show points
M23- Mxx	Lin. points NO 01 NO 32	X-axis	Y-axis			
		X value	Y value			
M55	Operating parameters PARAMETERS	Operator code	Limit value locking	Program name	Program version	Function pump rotation
		User code	Limit lock	Prog. name	Version	Func. alt.
		Relay lock time	Relay failure mode	Time for gradient evaluation	Failure mode at 4-20 mA input	Error limit 1
		Lock time	Rel. mode	Grad. time	Namur	Range 1
		Error limit 2	Error limit 3	Error limit 4	Display contrast	
		Range 2	Range 3	Range 4	Contrast	
M56	SERVICE	Only for Service staff. The Service code must be entered.				
M57	EXIT	Exit the menu. If you have changed parameters, a message appears asking you whether the changes should be saved.				
M58	SAVE	Changes are saved and the menu is exited.				
*) Only available if the corresponding option is installed in the device						

6.3 Access to the operating menu via the local display

The operating menu is activated by pressing the jog/shuttle dial for at least 3 seconds.

6.3.1 Operation via the jog/shuttle dial

A) 3-key function

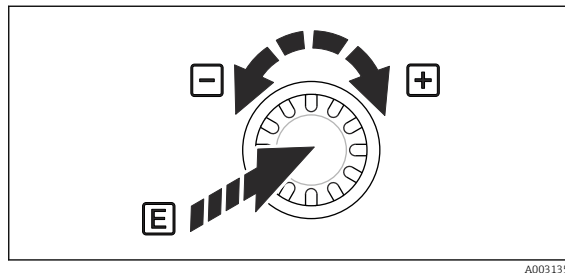

- Press = "Enter"
- Turn clockwise = "+"
- Turn counterclockwise = "-"

10 Operation via jog/shuttle dial

B) List selection

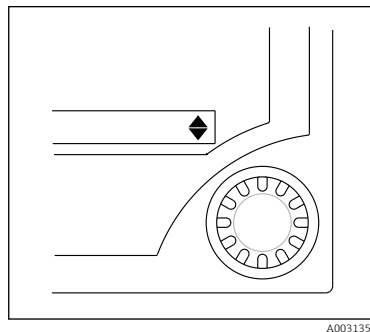

- ▼ Arrow points down:
Selection is at the start of the picklist. Turning the jog/shuttle dial to the right displays additional entries.
- ▲ Both arrows are visible:
▼ User is in the middle of the picklist.
- ▲ Arrow points up:
End of picklist has been reached. By turning the jog/shuttle dial to the left, the user starts moving to the top of the list.

11 List selection via jog/shuttle dial

6.3.2 Entering text

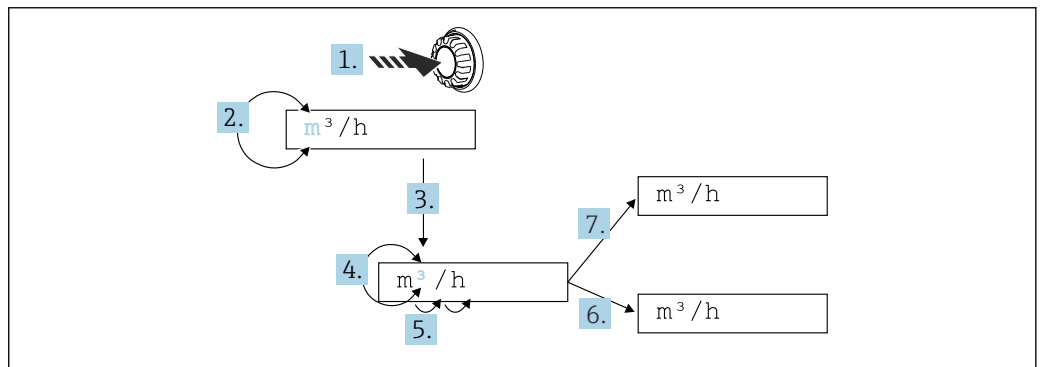

12 Entering text at the process indicator

1. Press and hold the jog/shuttle dial for at least 3 s.
↳ The first character starts flashing.
2. To change the character, turn the dial to the left or right.
3. Press the jog/shuttle dial briefly.
↳ Characters are accepted and the next character flashes.
4. To change the character, turn the dial to the left or right. Select the "◀" character to return to the previous character.
5. Press the jog/shuttle dial briefly.
↳ Characters are accepted and the next character flashes.

6. Set/change all the characters in this way. Once you have set the last character, press the jog/shuttle dial briefly.
 - ↳ The entry is accepted.
7. Alternatively, press and hold the jog/shuttle dial at any point for longer than 1 s and then release.
 - ↳ The entry is rejected.

Possible characters

Text can be entered using the following characters:

Space

+ABCDEFGHIJKLMNOPQRSTUVWXYZabcdefghijklmnopqrstuvwxyz0123456789/!%
 °23+-.;:*()◀ (return symbol)

6.3.3 Locking the configuration

User code

The configuration can be locked against unauthorized access by entering a four-digit code. This code is defined in item 55 "Parameter/User Code". All the operating parameters remain visible but can only be modified by first entering the user code. The "Key" symbol appears on the display.

If the limit values are also to be locked, set the "Limit Code" to "On" in menu item 55. Limit values can then only be changed after entering the user code. If the limit code is set to "Off", limit values can be changed without entering the user code. All other parameters are locked, however.

Hardware locking

Configuration can also be locked using a plug on the back of the device (→ 13, 20). This locking is indicated by a "padlock" symbol on the display. For hardware device locking, set the jumper in the top right-hand corner on the back to position J1.

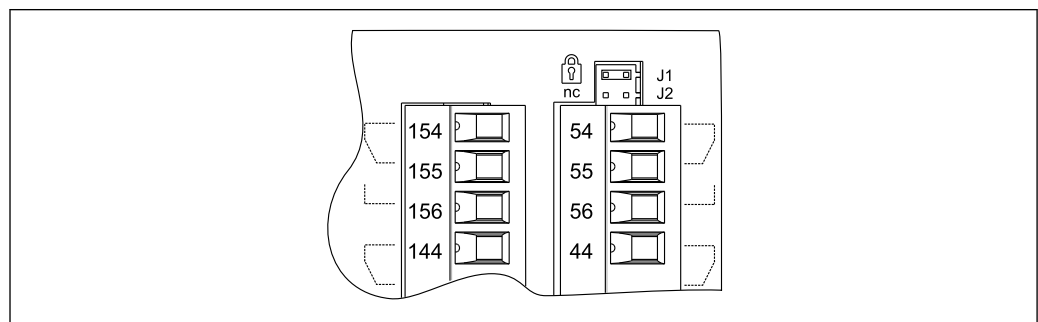

A0031364

13 Position of the jumper on the back of the device

i Hardware locking does not affect the PC operating software.

7 Commissioning

7.1 Function check

Make sure that all post-connection checks have been carried out before you commission your device:

Checklist connection check →  15



Remove the protective strip from the display as this restricts display legibility otherwise.

7.2 Switching on the measuring device

Once the operating voltage is applied, the green LED indicates that the device is operational.

- When the unit is delivered, the device parameters are used as per the factory settings.
- When commissioning a device already configured or preset, measuring is immediately started as per the settings. The limit values only switch once the first measured value has been determined.
- The limit values are only activated as per their configuration once a valid measured value is present.

7.3 Configuring the measuring device

This section describes all the configurable device parameters with the associated value ranges and factory settings (default values, shown in bold).

7.3.1 Analog input - INPUT/M1

The Analog input menu, displayed as INPUT in the device, contains all the parameters that can be selected for the input.

Function (menu item)	Parameter setting	Description
Signal type	4 - 20 mA 0 - 20 mA 0 - 5 mA ^(*) 0 - 100 mV ^(*) 0 - 200 mV ^(*) 0 - 1 V ^(*) 0 - 10 V ^(*) ± 150 mV ^(*) ± 1 V ^(*) ± 10 V ^(*) ± 30 V ^(*) Type B (IEC584) ^(*) Type J (IEC584) ^(*) Type K (IEC584) ^(*) Type L (DIN43710) ^(*) Type L (GOST) ^(*) Type N (IEC584) ^(*) Type R (IEC584) ^(*) Type S (IEC584) ^(*) Type T (IEC584) ^(*) Type U (DIN43710) ^(*) Type D (ASTME998) ^(*) Type C (ASTME998) ^(*) PT50 (GOST) ^(*) PT100 (IEC751) ^(*) PT100 (JIS1604) ^(*) PT100 (GOST) ^(*) PT500 (IEC751) ^(*) PT500 (JIS1604) ^(*) PT500 (GOST) ^(*) PT1000 (IEC751) ^(*) PT1000 (JIS1604) ^(*) PT1000 (GOST) ^(*) Cu50 (GOST) ^(*) Cu100 (GOST) ^(*) 30 - 3000 Ohm ^(*)	Use this function to select the signal type of the connected sensor. (*) Can only be selected with the universal input option.
Connection	3 Wire 4 Wire	Setting for the sensor connection in 3-wire or 4-wire technology. Can only be selected for "Signal type" 30-3000 Ω, PT50/100/ 1000, Cu50/100.
Curve	Linear Quad. °C °F Kelvin	Linear or quadratic (Quad.) curve of the sensor used; can be selected for analog signals. °C, °F, Kelvin physical measured variable, can be selected for temperature sensors.
Damp	0 to 99.9 0	Signal damping of the measuring input with first order low pass filter. Time constant can be selected from 0 to 99.9 s.
Dimension	XXXXXXXXX %	Use this function to configure the technical unit or a customized text for the measured value of the sensor. Max. length: 9 characters.
Dec. point	XXXXX XXXX.X XXX.XX XX.XXX X.XXXX	Number of decimal places for displaying the measured value.
0% value	-99999 to 99999 0.0	Start value of measured value, can be selected for analog signal types.

Function (menu item)	Parameter setting	Description
100% value	-99999 to 99999 100.0	End value of measured value, can be selected for analog signal types.
Offset	-99999 to 99999 0.0	Shifts the zero point of the response curve. This function is used to adjust the sensor.
Comp. temp	Intern Const	Reference temperature for thermocouple measurement. An internal reference junction (=Intern) or a constant value (=Const) can be selected.
Const. temp	9999.9 20.0	Fixed reference temperature. Can only be selected if "Const" is set for "Cmp. Temp".
Open circ.	No Yes	Switch cable open circuit detection off or on for thermocouples

Adjusting the analog input

The input can be adjusted to the sensor using the following parameters. For current, voltage and resistance sensors, a scaled value is calculated from the sensor signal.

For temperature outputs, the scaled value is calculated from linearization tables. The temperature value can be converted to degrees Celsius, degrees Fahrenheit or Kelvin. In addition, the temperature value can be corrected via an offset.

 The signal types 4 to 20 mA, thermocouples and RTD assemblies are monitored for a cable open circuit. Long response times can occur in the case of RTD assemblies.

7.3.2 Display - DISPLAY/M2

All the display settings are grouped under this menu item.

Function (menu item)	Parameter setting	Description
Ref. num.	Input Lin.table Total(*) Inp.+Lint. Inp.+Tot.(*) Lint.+Tot.(*) In+Lin+Tot(*) Batch(*)	Use this function to select the display value shown on the display (if a combination is selected, e.g. "Inp.+Lint", the display alternates between the selected display values, e.g. measured value (Inp.) and linearized measured value (Lint.)) <ul style="list-style-type: none"> ▪ Input = measured value ▪ Lin. table = linearized measured value or current flow for calculation of channel ▪ Total = integrated value ▪ Inp.+Lint. = display alternates between measured value and linearized measured value ▪ Inp.+Tot. = display alternates between measured value and integrated value ▪ Lint.+Tot. = display alternates between linearized measured value and integrated value ▪ In+Lin+Tot = measured value, linearized measured value or integrated value ▪ Batch = preset counter <p>Settings marked with an asterisk (*) can only be selected if the "Pulse output" or "Integration" option is available and has been configured.</p>
Display sw.	0 to 99 s 0	Configurable period for displaying the individual values if combinations of display values have been selected under "Ref. num". This setting can only be selected if the "Pulse output" or "Integration" option is available and has been configured.
Ref. bargraf	Input Lintab	Selection of the signal source for the bar graph.

Function (menu item)	Parameter setting	Description
Dec. point	XXXXX XXXX.X XXX.XX XX.XXX X.XXXX	Number of decimal places for bar graph scaling.
Bar 0%	-99999 to 99999 0.0	Start value for the bar graph
Bar 100%	-99999 to 99999 100.0	End value for the bar graph
Bar rise	Right Left	Bar graph orientation. <ul style="list-style-type: none"> ▪ Right = 100% value right (rising from left to right) ▪ Left = 100% value left (falling from left to right)

7.3.3 Analog output - ANALOG OUT/M3

 This menu item is only displayed if your device is equipped with the "Analog output" option.

Function (menu item)	Parameter setting	Description
Ref. num.	Input Lintab	Use this function to select which value is output at the analog output. <ul style="list-style-type: none"> ▪ Input = measured value ▪ Lintab = linearized measured value or current flow with calculation of channel
Out damp	0 to 99.9 0	Signal damping of the measuring input with first order low pass filter. Time constant can be selected from 0 to 99.9 s.
Out range	Off 0 - 20 mA 4 - 20 mA 0 - 10 V 2 - 10 V 0 - 1 V	Signal type of the output. "Off" switches the output signal off completely.
Dec. point	XXXXX XXXX.X XXX.XX XX.XXX X.XXXX	Number of decimal places for outputting the measured value. Can be selected for analog signal types
Out 0%	-99999 to 99999 0.0	Start value of the output signal
Out 100%	-99999 to 99999 100.0	End value of the output signal
Offset	-999.99 to 999.99 0.00	Shifts the zero point of the output curve in mA or V
Fail mode	Hold Const Min Max	Output value if a sensor or device error occurs. <ul style="list-style-type: none"> ▪ Hold = last valid value ▪ Const = user-defined value ▪ Min = output value 3.5 mA for 4 to 20 mA, otherwise 0 V or 0 mA ▪ Max = output value 22.0 mA for 0/20 mA, otherwise 1.1 V or 11 V
Fail value	0 to 999.99 0.00	The user-defined value for "Fail mode = Const" is configured here. <ul style="list-style-type: none"> ▪ Current output: 0 to 22 mA ▪ Voltage output: 0 to 11 V

Function (menu item)	Parameter setting	Description
Simu mA	OFF 0.0 mA 3.6 mA 4 mA 10 mA 12 mA 20 mA 21 mA	Simulates the current output and outputs the selected current at the output, irrespective of the input value. Is automatically switched "OFF" when the "Simu mA" menu item is exited. The parameter is only available if the ". mA" parameter is set in "Out range".
Simu V	OFF 0.0 V 5.0 V 10.0 V	Simulates the voltage output and outputs the selected voltage at the output, irrespective of the input value. Is automatically switched "OFF" when the "Simu V" menu item is exited. The parameter is only available if the ". V" parameter is set in "Out range".

7.3.4 Digital input - DIGITAL INP./M5

The settings for the digital status inputs, e.g. for monitoring pumps, starting/stopping the counter or resetting the min/max value memory, are grouped in this section.

-  In the PUMP function, the assignment of the digital inputs 1 to 4 to the relays 1 to 4 is fixed. Relay 1 is monitored by digital input 1, relay 2 by digital input 2 etc.
- When the "Batch" function is used, digital input 1 is permanently assigned to a preset value count function. Parameter configuration is then not possible for this digital input.

Function (menu item)	Parameter setting	Description
Function	Off Pump Res Tot. (*) Start/Stop(*) Res MinMax	Function of the selected digital input. <ul style="list-style-type: none"> ▪ Off = off ▪ Pump = pump monitoring (see Pump monitoring function) ▪ Res Tot. = reset the totalizer ▪ Start/Stop = start or stop the totalizer ▪ Res MinMax = reset the min/max memory values Parameters marked with an asterisk (*) are only available for the "Pulse output" option or if this function has been configured.
Level	Low High	Selects the side for evaluation. <ul style="list-style-type: none"> ▪ Low = decreasing side ▪ High = increasing side
Sampl. time	0 to 99 0	Defines the time (in seconds) within which pump feedback should be expected at the digital input. If there is no feedback within the defined time, an error message is generated and a second pump is activated if more than one pump is available. The setting for the "Sampl. time" defines the monitoring behavior of the digital input! <ul style="list-style-type: none"> ▪ Sampl. time = 0 means fault monitoring ▪ Sampl. time > 0 means startup monitoring

Pump monitoring function

If pump monitoring is to be implemented, digital inputs 1 to 4 are permanently assigned to relays 1 to 4. This function is activated for the relevant digital input using the "Function" parameter. "Pump" must be selected here.

In general, two different types of monitoring are possible. The setting for "Sampl. Time" determines the operating mode chosen.

- **Fault monitoring: Sampl. Time = 0**
In the case of fault monitoring, the level at the digital input is changed by a fault at the pump.
- **Startup monitoring: Sampl. Time > 0**
In the case of startup monitoring, correct start-up of the pump is reported back to the process indicator via a level change at the digital input.

a) Fault monitoring operating mode

In the fault monitoring operating mode, the status signal indicates the availability of the pump. If a fault occurs, the status signal changes accordingly.

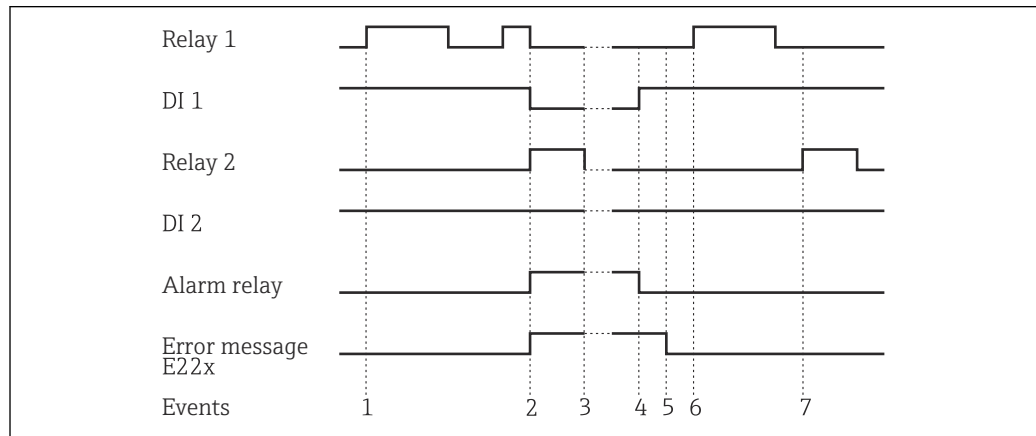

14 Fault monitoring operating mode

In event 1, pump 1 is activated because the level has violated the limit value. Pump 1 remains active until the level has dropped as much as required.

In event 2, an error occurs at pump 1 during operation, the status signal at DI1 changes. This activates pump 2 and the alarm relay (if configured accordingly) and the pump fault is shown as a message on the display.

In event 3, the level has dropped to such an extent that pumping is no longer necessary and pump 2 stops operation.

The fault at pump 1 has been rectified, and the status signal at DI1 changes once more. The alarm relay is reset, see event 4.

In event 5, the alarm relay and the error message on the display are acknowledged by pressing the jog/shuttle dial.

Events 6 and 7 show trouble-free operation of the system.

b) Startup monitoring

In the case of the startup monitoring mode, a change in the status signal is expected at the relevant digital input after a pump has been activated. A waiting time is defined for this (Sampl. Time, T). Alternating pump control is activated. If the status signal does not change within the time indicated, the pump is considered to be faulty.

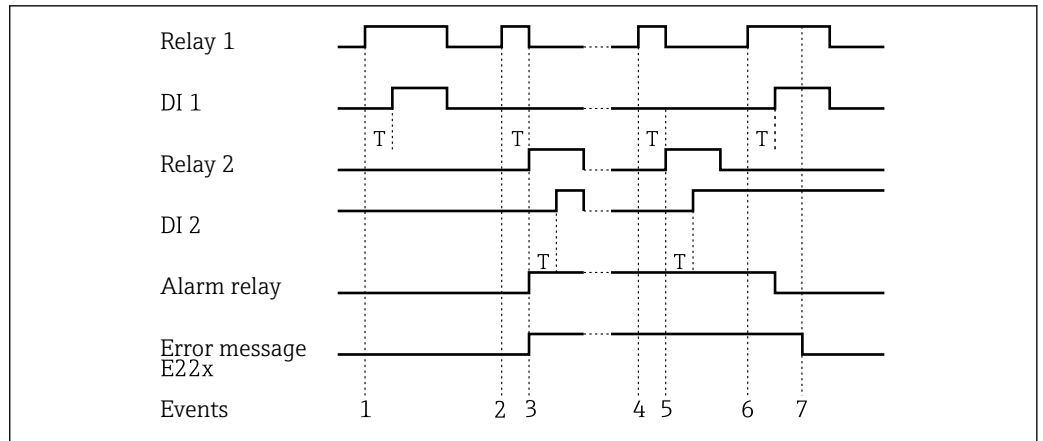

A0032766-EN

15 Startup monitoring operating mode

Event 1 shows trouble-free operation of pump 1. Pump 1 is activated by a demand signal due to a limit value violation. The status signal at DI1, which changes within T, indicates that the pump is operating correctly, pump 1 continues pumping.

In event 2, there is no feedback at DI1 after pump 1 has been activated and is therefore this pump is considered to be faulty. The alarm relay is activated and an error message is output on the display.

Pump 2 takes over pumping, event 3. This pump sends feedback to DI2 within the defined waiting time. Pumping continues until the level drops below the limit value violation level.

A new limit value violation occurs in event 4. A new attempt is made to start pump 1 due to alternating pump control. Pump 2 takes over (event 5), as no feedback is received after the waiting time has elapsed. If the alarm relay and error message were not already active on the display, they are now.

In event 6, the level is exceeded again and a pump is required. Following alternating pump control, pump 1 is tried again. This time pump 1 sends feedback. The alarm relay is reset.

In event 7, the error message is acknowledged on the display. The status signal at DI has no effect on the acknowledgment of the error message on the display.

- i** In the PUMP function, the assignment of the digital inputs 1 to 4 to the relays 1 to 4 is fixed. Relay 1 is monitored by digital input 1, relay 2 by digital input 2 etc.
- A faulty pump is always put back into operation depending on the signal at the relevant digital input. The acknowledgment of the error message on the display has no effect on the resumption of pump operation. If a pump is faulty for more than 10 minutes, an attempt is made to restart it when the limit value is violated.

The following parameters must be configured:

Menu	Function (menu item)	Setting value
DIGITAL INP./M5	Function	Pump
	Level	Low or High
	Sampl. time	Sampling time in seconds
LIMIT 1 to 8	Alternate	Yes

7.3.5 Limit values - LIMIT 1 to 8/M10 to 17

- i** If the "Batch" function is used, limit values 1 and 2 are permanently assigned activation in the event of a "preset counter" and "preliminary alarm" limit value. These limit values then cannot be configured and they are not shown in the menu structure.

Function (menu item)	Parameter setting	Description
Ref. num.	Input Lin. table	Use this function to select which value is used: <ul style="list-style-type: none"> Input: scaled value from analog input Lin. table: value from linearization table or current flow for calculation of channel
Function	Off Min Max Grad In band Out band Alarm Alarm inverse	Use this function to select limit value and fault monitoring. In the event of device errors or incorrect input values (see error limits range 1 to 4 in → 42), the relays are switched according to the failure mode (→ 42) set in Rel. Mode. <ul style="list-style-type: none"> Min: minimum with hysteresis → 29 Max: maximum with hysteresis → 29 Grad: gradient → 30 In band: validity range within two values Out band: validity range outside two values Alarm: relay is used as an alarm relay → 31 Alarm inverse: relay is used as an alarm relay; the switching behavior of the relay is safety-oriented so that the relay is de-energized if the power supply fails or if a fault occurs with the display unit.
Dec. point	XXXXX XXXX.X XXX.XX XX.XXX X.XXXX	Number of decimal places for the limit value.
Setpoint A	-99999 to 99999 0.0	Measured value at which a change in the switch state occurs (slope for gradient).
Setpoint B	-99999 to 99999 99999	The second setpoint can be configured for the "In band" and "Out band" operating modes and is only visible if one of these two functions was selected for this relay.
Hysteresis	-99999 to 99999 99999	Use this function to enter the hysteresis for the switching threshold at minimum / maximum as an absolute value.
Delay	0 to 99 0	Setting for the limit value event delay once the switch threshold is reached (in seconds) → 31.
Alternate	No Yes	Determines the switching function for this relay: <ul style="list-style-type: none"> No: no alternating function; switch point permanently assigned to the relay Yes: alternating function → 32 Relays 1-4 can be used for the alternating function.
Sw. delay	0 to 99 0	The starting time for 24-hour counting can be selected with Sw. delay. Every time the device is reset, the process of measuring 24 hours and the delay time is restarted. Example → 33
Sw. period	0 to 999 0	The limit value is activated cyclically every 24 h for 0 to 999 s. By changing the hour value, activation is delayed by [Sw.delay] hours (example → 33).
Runtime		Displays the run time of the connected device, e.g. pump, in hours [h].
Count		Records the switching frequency of the limit value.
Reset	No Yes	Resets the run time and switching frequency for this limit value.
Simu Relay	Off Low High	Simulation of the selected limit value. Is automatically switched "OFF" when the menu item is exited.

Min operating mode

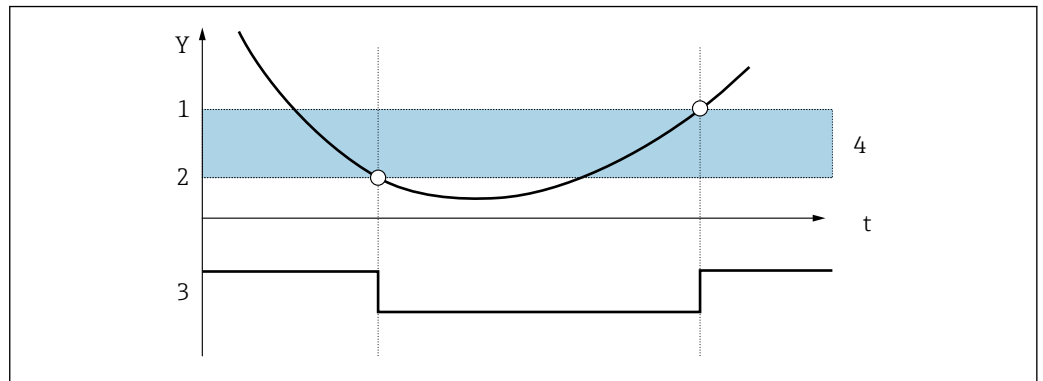

A0032767

16 Min operating mode

- Y Measured value
- t Time
- 1 Threshold+hysteresis
- 2 Threshold
- 3 Relay
- 4 Hysteresis

The following parameters must be configured:

Menu	Function (menu item)	Setting value
LIMIT 1 to 8/M10 to 17	Function	Min
	Setpoint A	Value for switching threshold
	Hysteresis	Value for hysteresis

Max operating mode

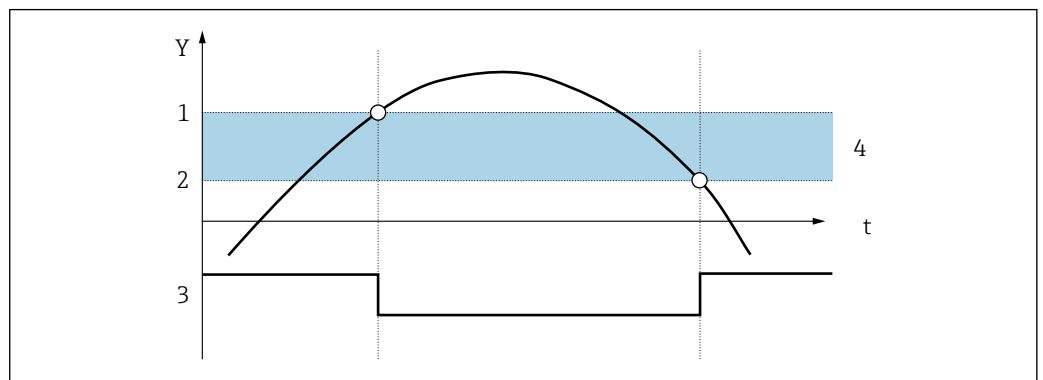

A0032768

17 Max operating mode

- Y Measured value
- t Time
- 1 Threshold
- 2 Threshold-hysteresis
- 3 Relay
- 4 Hysteresis

The following parameters must be configured:

Menu	Function (menu item)	Setting value
LIMIT 1 to 8/M10 to 17	Function	Min
	Setpoint A	Value for switching threshold
	Hysteresis	Value for hysteresis

Grad operating mode

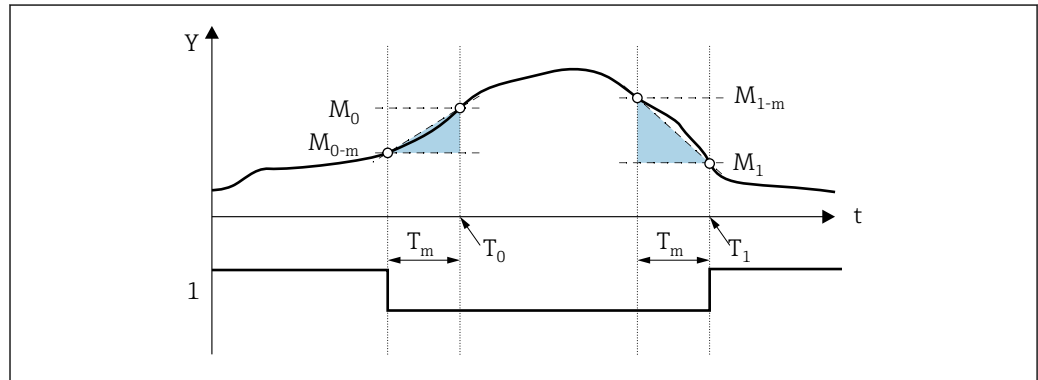

18 Grad operating mode

- Y Measured value
- t Time
- T_m Time for gradient evaluation
- M_0 Measured value at time T_0
- M_{0-m} Measured value at time $(T_0 - T_m)$
- M_1 Measured value at time T_1
- M_{1-m} Measured value at time $(T_1 - T_m)$
- 1 Relay

The "Grad" operating mode is used to monitor the change of the input signal over time. The time basis T_m for monitoring is set in the "PARAMETER/M55 -> Grad. time" menu.

The difference between the lower-range value M_{0-m} and the upper-range value M_0 of the interval is calculated. If the calculated value is greater than the value set under "Setpoint A", the relay is switched according to the failure mode (\rightarrow 42) set in "Rel. Mode".

The relay is switched on again if the difference between M_{1-m} and M_1 drops below the value set in "Hysteresis". The sign determines the direction of the signal change. Positive values monitor an increase in the measured value, negative values monitor a decrease. A new value is calculated every second (floating interval).

The following parameters must be configured:

Menu	Function (menu item)	Setting value
LIMIT 1 to 8/M10 to 17	Function	Min
	Setpoint A	Value for switching threshold
	Hysteresis	Value for hysteresis
	Grad. time	Interval time in seconds

Alarm operating mode

A relay with the "Alarm" operating mode is activated if the following events occur:

- Analog input (4 to 20 mA) < 3.6 mA (lower Namur limit) or > 21.0 mA (upper Namur limit)
- HW error EEPROM (E101)
The relay remains energized even after acknowledgment.
- Calibration data not plausible (E103)
The relay remains energized even after acknowledgment.
- Bus error when reading the min/max data following power-up (E104)
The relay remains energized even after acknowledgment.
- Bus error when reading the relay data following power-up (E105)
The relay remains energized even after acknowledgment.
- HW error universal card (E106)
The relay remains energized even after acknowledgment.
- Pulse buffer overflow (E210)
The relay is de-energized after acknowledgment.
- Pump error at corresponding digital input x (E22x)
The relay remains energized even after acknowledgment.

Delay

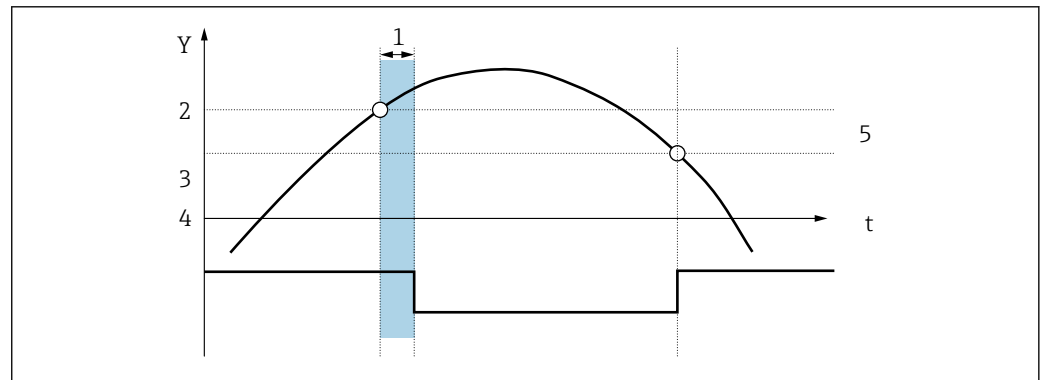

19 Delay

- Y Measured value
- t Time
- 1 Delay
- 2 Threshold max
- 3 Threshold-hysteresis
- 4 Relay
- 5 Hysteresis

The following parameters must be configured:

Menu	Function (menu item)	Setting value
LIMIT 1 to 8/M10 to 17	Setpoint A	Value for switching threshold
	Hysteresis	Value for hysteresis
	Delay	Delay time in [s]

Alternate

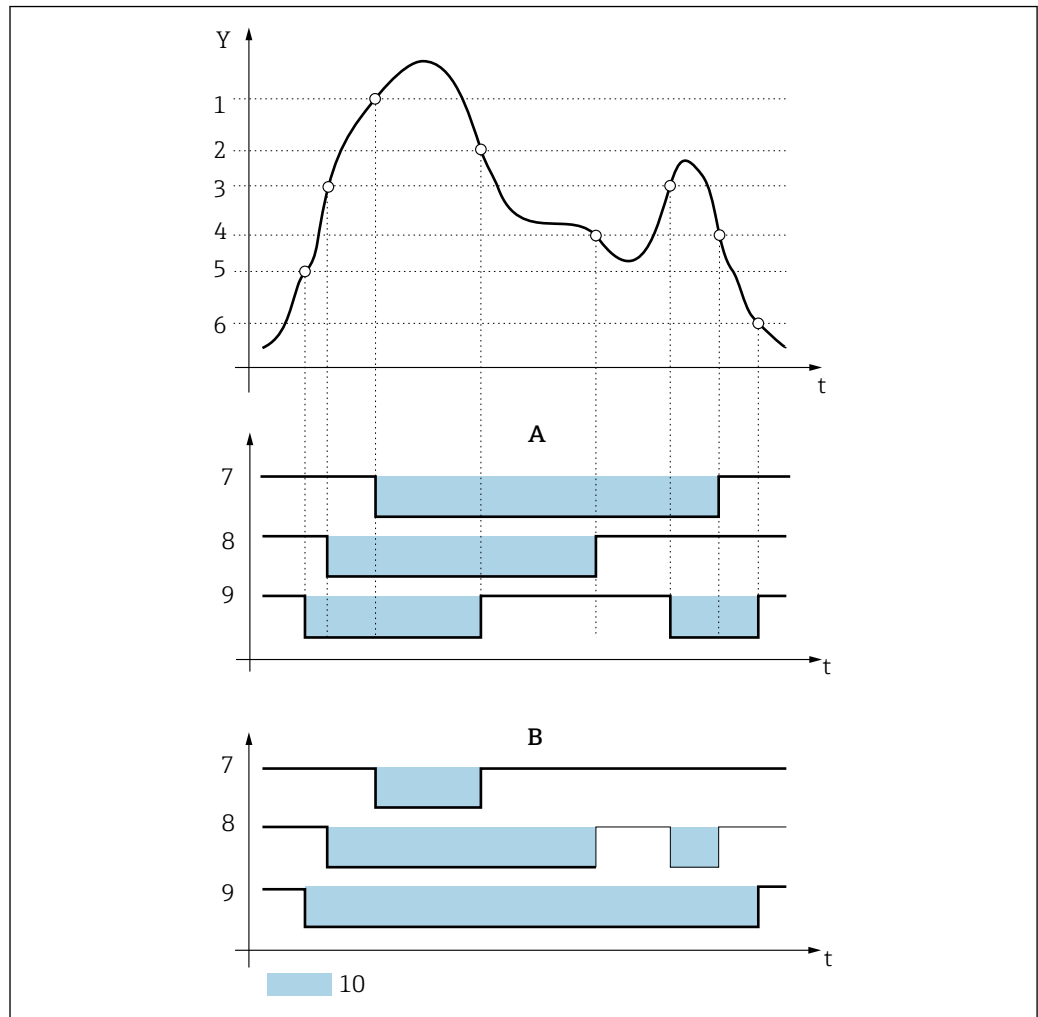

A0032771

20 Alternating pump control

- A With alternating pump control
- B Without alternating pump control

Y	Measured value	3	Setpoint A2	7	Relay 3 switching state
t	Time	4	Setpoint A2 - hysteresis 2	8	Relay 2 switching state
1	Setpoint A3	5	Setpoint A1	9	Relay 1 switching state
2	Setpoint A3 - hysteresis 3	6	Setpoint A1 - hysteresis 1	10	Relay current-free

If several pumps are used for level control, the alternating switching function ensures that all pumps are utilized evenly. The operating time of the pumps, rather than a permanently assigned switch-on value, is the main factor that determines when a certain pump is switched on.

In total, the first 4 relays (LIMIT 1 to 4) can be included in the alternating pump control system.

i Any relays not included in alternating pump control are available as usual.

This function cannot be applied to individual relays. Relays that are not included are not assessed according to the switch-on and switch-off duration.

The following parameters must be configured for the example above:

Menu	Function (menu item)	Setting value
LIMIT 1 to 3/M10 to 12	In each case: setpoint A	Value for switching threshold
	In each case: hysteresis	Value for hysteresis
	In each case: alternate	Yes

24-hour activation function

Pumps with long downtimes can be activated cyclically with the 24-hour activation function for the time defined in "Sw. period" (0 to 999 s).

The starting time for the 24 h step interval can be postponed by 0 to 23 hours with the "Sw. delay" setting.

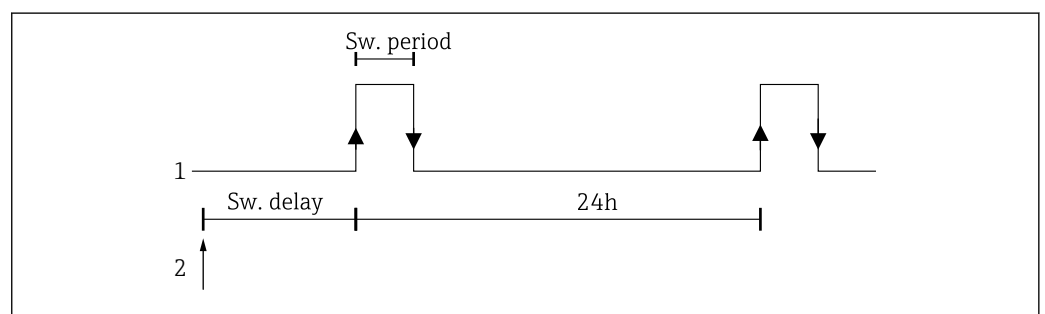

21 24-hour activation function

- 1 Relay
- 2 Start

Example: time at the time of configuration is 12 midday; preferred starting time of 24-hour counting 22:00 (10 p.m.) → set "Sw. delay" to 10.

i If the power is switched off, the time for the 24-hour activation function starts again.

The following parameters must be configured for the example above:

Menu	Function (menu item)	Setting value
LIMIT	Sw. period	Activation duration
	Sw. delay	Activation delay

7.3.6 Integration - INTEGRATION/M18

i If the preset counter ("Batch") function is used, digital input 1 and relays 1 and 2 are permanently assigned to this function. Parameter configuration is then not possible for these inputs/outputs.

This function can only be selected if the "Pulse output" option is available in the device.

Function (menu item)	Parameter setting	Description
Ref. integr.	Input Lintab	Use this function to select which value should be integrated. <ul style="list-style-type: none"> Input = measured value Lintab = linearized measured value or current flow with calculation of channel
Pre-counter	Off Count up Count down	Activation of the preset counter <ul style="list-style-type: none"> Off = preset counter off Count up = count up from zero to the end value Count down = count down from the start value to zero
Integr. base	Off sec min hour day	Time basis for integration
Dec. factor	XXXXX XXXX.X XXX.XX XX.XXX X.XXXX	Decimal point position of the conversion factor
Factor	0 to 99999 1.0	Conversion factor
Dimension	XXXXXXXXXX	The dimension is selected from a list or entered as customized text (max. length: 9 characters).
Dec. Point T	XXXXX XXXX.X XXX.XX XX.XXX X.XXXX	Decimal point of totalizer
Set count A	99999 0.0	End value/start value for preset counter; refers permanently to relay 1.
Set count B	99999 0.0	Value for preliminary alarm; refers permanently to relay 2.
Totalizer	9999999	The totalizer can be displayed and edited (e.g. assigned a default value) in this position. If the maximum value of 9999999 is exceeded, the counter starts again at 0.
Reset Total	No Yes	Reset totalizer Cannot be configured via the PC operating software.
Calc. Flow	No Curve Formula	Use this function to select the method of calculating a flow rate based on the channel type or via a formula using the analog input signal (e.g. level signal) <ul style="list-style-type: none"> No = no integration Curve = flow calculation with channel type. If "Curve" is selected, the menu only shows possible channel types for configuration (e.g. Venturi flumes, Parshall flumes, weirs etc.) Formula = flow calculated using a formula If "Formula" is selected, the menu only shows possible configuration parameters for entering the formula (e.g. alpha, beta, gamma, C). Here, the flow is calculated here according to the following formula: $Q = C * (h^a + \gamma * h^b)$
Dim. Input	mm inch	Dimension of the channel size
Dec. flow	XXXXX XXXX.X XXX.XX XX.XXX X.XXXX	Decimal point for display

Function (menu item)	Parameter setting	Description
Dim. flow	m ³ /s, l/s, hl/s, iganal/s, usgal/s, barrels/s, inch ³ /s, ft ³ /s, Usmgal/s, Ml/s, m ³ /smin, l/ min, hl/min, iganal/ min, usgal/ min, barrels/min, inch ³ / min, ft ³ / min, Usmgal/ min, Ml/min, m ³ /h, l/ h, hl/h, iganal/h, usgal/h, barrels/h, inch ³ /h, ft ³ /h, Usmgal/h, Ml/h, Usmgal/d, Usgal/d	<p>Dimension of linearized value</p> <ul style="list-style-type: none"> ■ l = liter ■ hl = hectoliter ■ m³ = cubic meter ■ Ml = megaliter ■ USgal = US gallon ■ USKgal = US kilogallon ■ USMgal = US megagallon ■ USbl = US barrel ■ iganal = imperial gallon ■ ibl = imperial barrel ■ inch = inch ■ ft = feet <p>1 hl = 100 l 1 m³ = 1 000 l 1 Ml = 1 000 000 l 1 USgal = 3.79 l 1 USKgal = 3 785.411 l 1 USMgal = 3 785 411.78 l 1 USbl = 119.24 l 1 iganal = 4.55 l 1 ibl = 163.66 l 1 in = 25.4 mm 1 ft = 304.8 mm</p>
Dec. point	XXXXX XXXX.X XXX.XX XX.XXX X.XXXX	Decimal point for formula (only if formula-based flow calculation is selected)
Alpha	-99.99999	Flow exponent α (see "Calc.flow")
Beta	-99.99999	Flow exponent β (see "Calc.flow")
Gamma	-99.99999	Weighting factor γ (see "Calc.flow")
C	-100	Scaling constant C (see "Calc.flow")
Flumes Weir	Kha Venturi ISO Venturi BST Venturi Parshall Palmer-Bow Rect. WTO Rect WThr NFXRectWTO NFXRectWThr Trap.W TO V-weir BST V-weir NFX V-weir	<p>Kha-Venturi = Khafagi-Venturi flumes</p> <p>ISO Venturi = ISO Venturi flumes</p> <p>BST Venturi = Venturi flumes according to British Standard</p> <p>Parshall = Parshall flumes</p> <p>Palmer-Bow = Parshall-Bowlus flumes</p> <p>Rect. WTO = rectangular weirs (w)</p> <p>Rect WThr = rectangular weir with constriction (w)</p> <p>NFXRectWTO = rectangular weir as per NFX (w)</p> <p>NFXRectWThr = rectangular weir as per NFX with constriction (w)</p> <p>Trap.WTO = trapezoidal weir (w)</p> <p>V-weir = triangular weir (w)</p> <p>BST V-weir = triangular weir as per British Standard</p> <p>NFX V-weir = triangular weir as per NFX</p> <p>Configure (w) width additionally</p>
Width	99999	Value for width, can only be selected for channel types marked with (w) (see "Flumes-Weir")
Kha-Venturi	QV 302 QV 303 QV 304 QV 305 QV 306 QV 308 QV 310 QV 313	<p>Khafagi-Venturi flumes</p> <p>QV 302 = Khafagi-Venturi flume QV 302</p> <p>QV 303 = Khafagi-Venturi flume QV 303</p> <p>QV 304 = Khafagi-Venturi flume QV 304</p> <p>QV 305 = Khafagi-Venturi flume QV 305</p> <p>QV 306 = Khafagi-Venturi flume QV 306</p> <p>QV 308 = Khafagi-Venturi flume QV 308</p> <p>QV 310 = Khafagi-Venturi flume QV 310</p> <p>QV 313 = Khafagi-Venturi flume QV 313</p>

Function (menu item)	Parameter setting	Description
	QV 316	QV 316 = Khafagi-Venturi flume QV 316
ISO Venturi	415 425 430 440 450 480	ISO Venturi flumes 415 = ISO Venturi flume 415 425 = ISO Venturi flume 425 430 = ISO Venturi flume 430 440 = ISO Venturi flume 440 450 = ISO Venturi flume 450 480 = ISO Venturi flume 480
BST Venturi	4" 7" 12" 18" 30"	Venturi flumes as per British Standard 4" = Venturi flume as per British Standard 4 in 7" = Venturi flume as per British Standard 7 in 12" = Venturi flume as per British Standard 12 in 18" = Venturi flume as per British Standard 18 in 30" = Venturi flume as per British Standard 30 in
Parshall	1" 2" 3" 6" 9" 1 ft 1.5 ft 2 ft 3 ft 4 ft 5 ft 6 ft 8 ft	Parshall flumes 1" = Parshall flume 1 in 2" = Parshall flume 2 in 3" = Parshall flume 3 in 6" = Parshall flume 6 in 9" = Parshall flume 9 in 1 ft = Parshall flume 1 ft 1.5 ft = Parshall flume 1.5 ft 2 ft = Parshall flume 2 ft 3 ft = Parshall flume 3 ft 4 ft = Parshall flume 4 ft 5 ft = Parshall flume 5 ft 6 ft = Parshall flume 6 ft 8 ft = Parshall flume 8 ft
Palmer-Bow.	6" 8" 10" 12" 15" 18" 21" 24" 27" 30"	Palmer-Bowlus flumes 6" = Palmer-Bowlus flume 6 in 8" = Palmer-Bowlus flume 8 in 10" = Palmer-Bowlus flume 10 in 12" = Palmer-Bowlus flume 12 in 15" = Palmer-Bowlus flume 15 in 18" = Palmer-Bowlus flume 18 in 21" = Palmer-Bowlus flume 21 in 24" = Palmer-Bowlus flume 24 in 27" = Palmer-Bowlus flume 27 in 30" = Palmer-Bowlus flume 30 in
Rect.WTO	5H T5	Rectangular weirs 5H = rectangular weir WTO/5H T5 = rectangular weir WTO/T5

Function (menu item)	Parameter setting	Description
Rect.WThr		Rectangular weir with constriction
	2H	2H = rectangular weir with constriction 2H
	3H	3H = rectangular weir with constriction 3H
	4H	4H = rectangular weir with constriction 4H
	5H	5H = rectangular weir with constriction 5H
	6H	6H = rectangular weir with constriction 6H
	8H	8H = rectangular weir with constriction 8H
	TO	TO = rectangular weir with constriction TO
	T5	T5 = rectangular weir with constriction T5
2T	2T = rectangular weir with constriction 2T	
NFXRect. WTO		Rectangular weirs NFX
	5H	5H = NFX rectangular weir TO/5H
	T5	T5 = NFX rectangular weir TO/T5
NFXRect. WThr		NFX rectangular weirs with constriction
	2H	2H = NFX rectangular weir with constriction 2H
	3H	3H = NFX rectangular weir with constriction 3H
	4H	4H = NFX rectangular weir with constriction 4H
	5H	5H = NFX rectangular weir with constriction 5H
	6H	6H = NFX rectangular weir with constriction 6H
	8H	8H = NFX rectangular weir with constriction 8H
	TO	TO = NFX rectangular weir with constriction TO
Trap. W TO		Trapezoidal weirs
	3H	3H = trapezoidal weir W TO/3H
	T5	T5 = trapezoidal weir W TO/T5
V-weir		Triangular weirs
	22.5	22.5 = triangular weir 22.5
	30	30 = triangular weir 30
	45	45 = triangular weir 45
	60	60 = triangular weir 60
90	90 = triangular weir 90	
BST V-weir		Triangular weir as per British Standard
	22.5	22.5 = triangular weir as per British Standard 22.5
	45	45 = triangular weir as per British Standard 45
90	90 = triangular weir as per British Standard 90	
NFX V-weir		NFX triangular weirs
	30	30 = NFX triangular weir 30
	45	45 = NFX triangular weir 45
	60	60 = NFX triangular weir 60
90	90 = NFX triangular weir 90	

Calculation formula for flow measurement

If you have selected "Formula" under "Calc. flow" for flow measurement, the flow is calculated using the following formula:

$$Q = C * (h^\alpha + \gamma * h^\beta)$$

Where:

- Q: flow in m³/h
- C: scaling constant
- h: upstream level
- α, β: flow exponents
- γ: weighting factor

i The scaling constant C must always refer to Q in m³/h, i.e. if Q is present in another flow unit, C must be converted.

Examples:

- Q in l/h with C = 2.11
1 l/h = 0.001 m³/h
→ C = 2.11 * 0.001 = 0.00211
- Q in USKgal/s with C = 0.35
1 USKgal/s = 13 627.4444 m³/h
→ C = 0.35 * 13 627.4444 = 4 769.60554

A table with values for converting various flow units to m³/h is provided in the Appendix.

Integration function/totalizer

With this function, the computed value from the linearization table, or of the current flow rate for channel calculation or of the analog input can be numerically integrated to create a totalizer for example.

The totalizer is calculated as follows:

$$\text{Totalizer}_{\text{new}} = \text{Totalizer}_{\text{old}} + \text{value} * \frac{\text{Measuring interval}}{\text{Integration base}} * \text{conversion factor}$$

The measuring interval is 0.1 s.

In most cases, the integration base is the same time unit as the time base of the signal to be integrated.

Example: analog input l/s → integration base s !

Simple preset counter

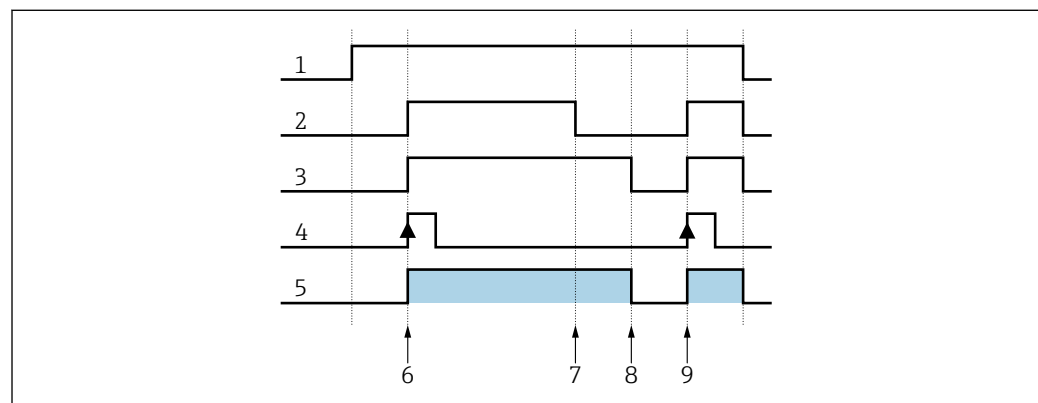

22 Simple preset counter

A0032773

1	Power on	4	Digital input 1	7	Limit value B
2	Relay 2	5	Counter run time	8	Limit value A
3	Relay 1	6	Restart counter	9	Restart counter

When the preset counter is activated, limit values 1 and 2 are permanently assigned to the preset counter function (output 1 = main switchoff, output 2 = preliminary switchoff). Digital input 1 is permanently assigned to the "Reset and restart preset counter" function.

Accordingly, this reduces the number of free relays that are available. The operating menus for these inputs/outputs are then not displayed.

"Set count B" (limit value B) defines the preliminary switchoff, "Set count A" (limit value A) defines the main switchoff. Limit value (or start value, see "Pre-counter" function →  33) for limit value A and preliminary alarm value for limit value B are user-configurable.

A positive counting direction is defined as follows: from the fixed starting value of zero, start counting up until the set limit value is reached ("Set count A").

A negative counting direction is defined as follows: from the user-configurable starting value ("Set count A"), start counting down until the fixed limit value of zero is reached.

The counter is reset and simultaneously restarted via digital input 1 ("Digital Inp.1"). Edge "Digital Inp.1": Low-High = reset and start counter.

 The display of the preset counter can be configured under DISPLAY/M2 ... "Ref.num" = "Batch".

7.3.7 Pulse output - PULSE OUT/M19

All the possible settings for the pulse output can be found in this menu item. This menu item can only be selected if your device is fitted with this option.

Function (menu item)	Parameter setting	Description
Dec. value	XXXXX XXXX.X XXX.XX XX.XXX X.XXXX	Decimal point position of the pulse value.
Unit value	0 to 99999 1.0	Pulse value with which the pulses should be output at the output.
Pulse width	0.04 to 2000ms 1000.00	Setting for the pulse width at the pulse output. The maximum output frequency depends on the pulse width. $f(\max) = 1/(2 \cdot \text{pulse width})$
Sim pulseout	Off 1 Hz 10 Hz 100 Hz 1000 Hz 10000 Hz	Outputs the selected pulses at the pulse output, irrespective of the input value. Is automatically set to "OFF" when exited.

7.3.8 Min/Max memory - MIN MAX/M20

The process indicator can save a minimum and a maximum measured value. The input signal or the signal processed using the linearization table are available as the signal source. The memories are reset manually or using the digital input (→  25).

Function (menu item)	Parameter setting	Description
Ref. Min/Max	Input Lintab	Signal source for the min/max value memory. <ul style="list-style-type: none"> Input = input signal Lintab = linearized input signal or current flow for calculation of channel
Dec. point	XXXXX XXXX.X XXX.XX XX.XXX X.XXXX	Number of decimal places for the min/max value memory.
Min. value	0 to 99999	Displays the current minimum value in the memory.
Max. value	0 to 99999	Displays the current maximum value in the memory.
Reset min	No Yes	Resets the minimum value memory.
Reset Max	No Yes	Resets the maximum value memory.

7.3.9 Linearization table - LIN. TABLE/M21

To linearize input variables, a linearization table can be saved in the device, e.g. to correct the level signal of a vessel for volume display.

Function (menu item)	Parameter setting	Description
Counts	2 to 32 2	Number of linearization points required. At least two points must be entered.
Dimension	XXXXXXXXX	The dimension is selected from a list or entered as customized text (max. length: 9 characters).
Dec. Y value	XXXXX XXXX.X XXX.XX XX.XXX X.XXXX	Decimal position for the Y-values of the linearization table.
Del. points	No Yes	Delete all programmed linearization points.
Show points	No Yes	Display all the programmed linearization points.

Tank linearization

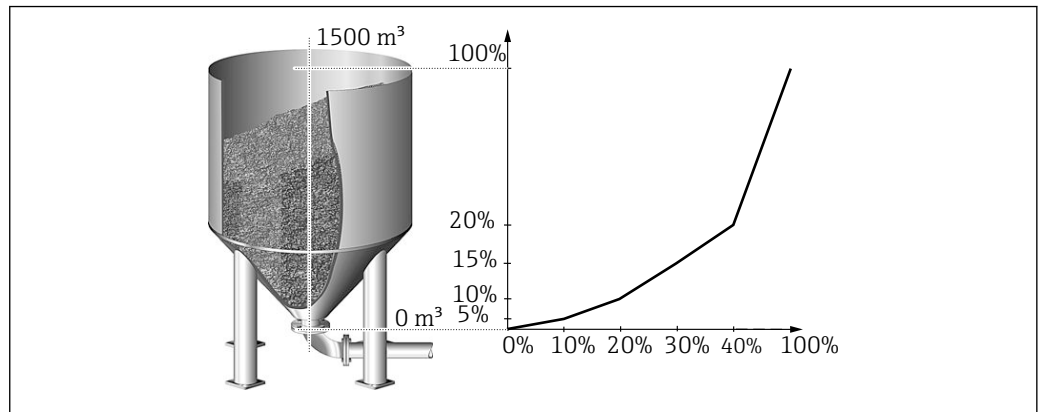

23 Example of tank linearization

You want to determine the amount of grain filled into a silo, display this information on site and transmit it to a process control system. A 4 to 20 mA level sensor determines the level in the vessel, the relationship between the level (m) and volume (m³) is known and the level is proportional to the sensor current. The calculated volume is output as a 0 to 20 mA signal at the analog output in proportion to the volume. In the event of an error in the system, the analog output outputs an error signal of 21.0 mA.

- Vessel empty:
 - Sensor signal 4 mA
 - Level 0 m
 - Numeric display should show 0 (m³)
 - Bar graph should show 0%
 - 0 mA should be present at the analog output
- Vessel full:
 - Sensor signal 20 mA
 - Level 10 m
 - Numeric display should show 1500 (m³)
 - Bar graph should show 100%
 - 20 mA should be present at the analog output

	Point									
	1	2	3	4	5	6	7	8	9	10
Sensor signal (mA)	X value 4.0	X value 4.32	X value 4.64	X value 4.96	X value 5.28	X value 5.6	X value 5.92	X value 6.24	X value 6.56	X value 20
Display value (m ³)	Y value 0	Y value 20	Y value 50	Y value 85	Y value 115	Y value 160	Y value 210	Y value 280	Y value 400	Y value 1500

The following parameters must be configured for the example above:

Menu	Function (menu item)	Setting value
LIN. TABLE / M 21	Counts	Number of points (10)
	Dimension	Dimension of the lin. value (m ³)
	Show points	Show the linearization points (Yes)
LINPOINTS 1 to 10 / M23 to 32	Each point	Use point (Used)
	Each X value	X-value (as in table above)
	Each Y value	Y-value (as in table above)

Menu	Function (menu item)	Setting value
ANALOG OUT / M 3	Ref. num	Output value (Lintab)
	Out range	Signal type (0-20 mA)
	Fail mode	Failure mode (const)
	Fail value	Value in event of error (21.0 mA)
DISPLAY / M 2	Ref. num.	Reading on display (Lin. table)
	Ref. bar graph	Signal source for bar graph (Lintab)



The PC operating software supports the generation of a tank linearization table.

The software contains a tank linearization generator which you can use to generate a linearization table for standard tanks and specific tanks.

7.3.10 Linearization points of linearization table - LINPOINTS 1..X/M23..MXX

Displays the value pairs configured for the linearization table. This menu item is only visible if a linearization table has been configured (→ 40) and "Yes" is selected in the "Show points" parameter in the "LIN. TABLE/M21" menu.

Function (menu item)	Parameter setting	Description
Point	Used Discard	Use or discard the linearization point.
X value	-99999 to 99999	X value of the linearization table. Corresponds to the input value.
Y value	-99999 to 99999	Y value which belongs to the previous X value. Corresponds to the converted measured value.

7.3.11 Operating parameters - PARAMETER/M55

In this menu item it is possible to configure settings such as the user code, process indicator failure mode according to NAMUR etc.

Function (menu item)	Parameter setting	Description
User code	9999	The option of editing the operating parameters is locked after a 4-digit digital sequence is entered. This locking is indicated on the display by a "key" symbol.
Limit code	Off On	<ul style="list-style-type: none"> ▪ Off: It is not necessary to enter the user code to change the limit values ▪ On: Limit values are protected by a user code. The menu item is only displayed if a user code has been assigned.
Prog. name	ILU10xA	Displays the name of the device software currently installed.
Version	V X.XX.XX	Version of the device software currently installed.
Func. alt.	Time Count	Setting for controlling pump rotation in alternating pump control. <ul style="list-style-type: none"> ▪ Time = switching duration of the relay ▪ Count = switching frequency of the relay
Lock time	99.9	Relay locking time, 0 to 99.9 s

Function (menu item)	Parameter setting	Description
Rel. mode	Off On	Switching behavior of the relays. <ul style="list-style-type: none"> Off = relays are de-energized in the event of a limit value violation On = relays are energized in the event of a limit value violation
Grad. Time	1 to 100	Time setting for gradient evaluation, 1 to 100 s
Namur	No Yes	Sensor evaluation according to NAMUR (e.g. cable open circuit). Only for 4 to 20 mA current signal.
Range 1	0.0 to 22.0 3.6 (NAMUR)	Error limits for the input signal. In the "NAMUR=Yes" operating mode, Range 1 to 4 are assigned the limits specified by Namur NE 43 and cannot be changed. In the "NAMUR=No" operating mode, the error limits can be freely defined by the user. Here, please note that the following applies: Range 1 < Range 2 < Range 3 < Range 4. The violation of these limits can be evaluated with a relay, for example ("Alarm" and "Alarm inverse" operating mode).
Range 2	0.0 to 22.0 3.8 (NAMUR)	
Range 3	0.0 to 22.0 20.5 (NAMUR)	
Range 4	0.0 to 22.0 21.0 (NAMUR)	
Contrast	1 to 30	Setting for the display contrast. <ul style="list-style-type: none"> 1 = low contrast 30 = high contrast

8 Diagnostics and troubleshooting



8.1 Troubleshooting instructions

NOTICE

Explosion hazard from open device in Ex environment

- In the case of Ex devices, error diagnosis cannot be performed on an open device as this invalidates the type of protection.

Display	Cause	Solution
No measured value displayed	No power supply connected	Check the power supply to the device.
	Power is supplied, device is defective	The device must be replaced.
The red marking for overranging/underranging on the bar graph is flashing.	The analog output is > 10% above or below the scaled range.	Check the scaling of the analog output (Out 100% or Out 0%).

 Errors for which an error code appears on the display are described in the following section →  43.

More information about the display is provided in the "Display" section →  16.

8.2 Process error messages

 Faults have the highest priority. The corresponding error code is displayed. A fault has occurred if the memory module for writing and reading data is defective or the data could not be read correctly.

8.2.1 Device failure

Error code	Cause	Effect	Solution
E101	Bus error when reading the config/calibration data following power-up	Incorrect device functioning	Device error, notify Service
E102	Implausible operating data (checksum)	Configuration is lost	Perform a preset
E103	Implausible calibration data	Incorrect device functioning	Device error, notify Service
E104	Bus error when reading the min/max data following power-up	Incorrect min/max values	Reset min/max values
E105	Bus error when reading the relay data following power-up	Incorrect relay data	Reset relay data
E106	Universal card bus error	Incorrect universal input functioning	Replace universal card, notify Service
E210	Pulse output Pulse buffer overflow	A maximum of 10 pulses are buffered	Set the parameters of the pulse output in such a way that the maximum frequency is not exceeded
E221	Pump failure Digital input 1	Relay adopts failure mode	Acknowledge the error via operation or switch power off and on
E222	Pump failure Digital input 2		
E223	Pump failure Digital input 3		
E224	Pump failure Digital input 4		
E290	Number overshoot due to decimal point shift	Decimal point position cannot be changed	Check decimal point position and number range

 The errors listed above can be evaluated with a relay in the "Alarm" and "Alarm inverse" operating mode.

8.2.2 Incorrect entries

Error code	Description	Reaction at device
E290	The number of decimal places cannot be increased due to number overflow of dependent parameters.	Error code continues to be shown on the display until a button is pressed.

8.3 Firmware history

Revision history

The version number on the nameplate and in the Operating Instructions indicates the device release: XX.YY.ZZ (example 01.02.01).

XX	Change to main version. No longer compatible. The device and Operating Instructions change.
YY	Change to functions and operation. Compatible. The Operating Instructions change.
ZZ	Fixes and internal changes. No changes to the Operating Instructions.

Date	Software version	Software modification	"ReadWin 2000" PC operating software	Documentation
06/2008	2.01.zz	Original software	V1.23.2	BA00265R/09/en/06.08
02/2013	2.01.zz	Fixes and internal changes	V1.27.8	BA00265R/09/en/13.13
01/2017	2.01.zz	Fixes and internal changes	V1.27.14	BA00265R/09/en/14.16
12/2019	2.02.zz	Function upgrade	V1.27.15	BA00265R/09/en/15.19
02/2021	2.02.zz	Fixes and internal changes	V1.27.15	BA00265R/09/en/16.21
01/2023	2.02.zz	Fixes and internal changes	V1.27.18	BA00265R/09/en/17.23

9 Maintenance

No special maintenance work is required for the device.

9.1 Cleaning

A clean, dry cloth can be used to clean the device.

10 Repair

10.1 General information

In accordance with the Endress+Hauser repair principle, the devices have a modular design and repairs can be carried out by the customer. Contact the supplier for more information on servicing and spare parts.

10.2 Spare parts

Spare parts currently available for the device can be found online at: http://www.products.endress.com/spareparts_consumables. Always quote the serial number of the device when ordering spare parts!

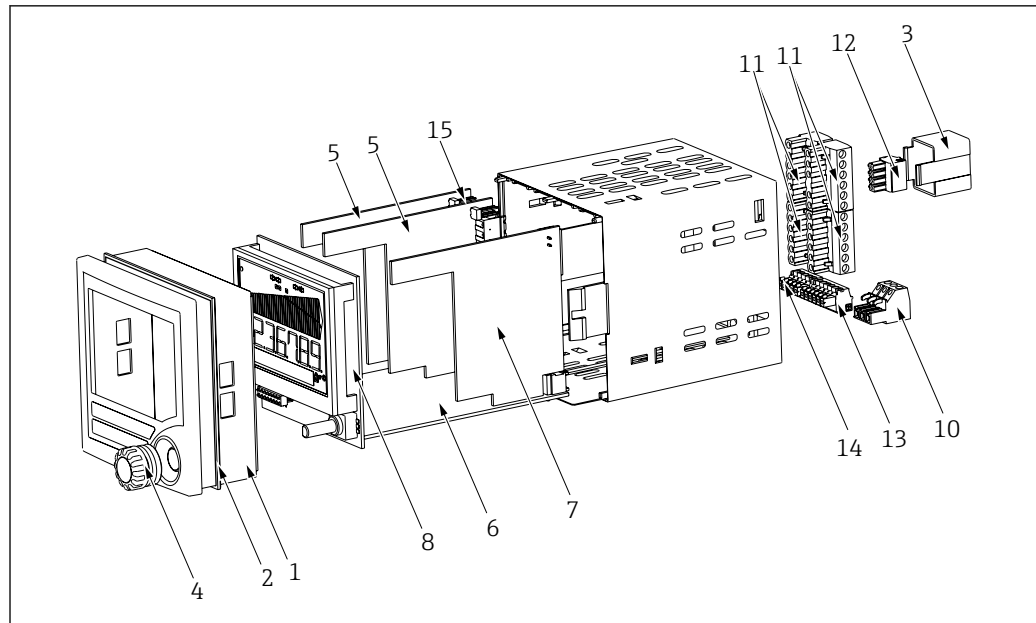

A0032775

24 Spare parts of the process indicator

Item no.	Designation	Order no.
1	Housing front	RIA452X-HA
2	Housing seal	50070730
3	Ex cover (rear panel)	51008272
4	Rotary knob with seal	RIA452X-HB
5	Relay board	RIA452X-RA
6	Mainboard 90 to 250 V, 50/60 Hz	RIA452X-MA
	Mainboard 20 to 36 V DC; 20 to 28 V AC, 50/60 Hz	RIA452X-MB
	Mainboard 90-253VAC + analog output	RIA452X-MC
	Mainboard 10-36VDC/20-27VAC + analog output	RIA452X-MD
	Mainboard 90-253VAC + integration + pulse output	RIA452X-ME
	Mainboard 10-36VDC/20-27VAC + integration + pulse output	RIA452X-MF
	Mainboard 90-253VAC + output + integr. (pulse output + analog output)	RIA452X-MG
	Mainboard 10-36VDC + output + integr. (pulse output + analog output)	RIA452X-MH
7	Standard input card	RIA452X-IA
	Standard input card ATEX, FM, CSA approval	RIA452X-IB
	Multifunction input card	RIA452X-IC
8	Display board, complete	RIA452X-DA
10	Terminal (mains) 3-pin	50078843
11	Terminal (relay 1-8) 6-pin	51005104
12	Terminal (analog input) 4-pin	51009302
13	Terminal (analog output, open collector, transmitter power supply) 6-pin	51008588
14	Terminal (digital inputs) 5-pin	51008587
15	Jumper operating lock	50033350
W/O. No.	Casing fastening clip RIA452 (1 pc.)	71035359

10.3 Return

The requirements for safe device return can vary depending on the device type and national legislation.

1. Refer to the web page for information:
<http://www.endress.com/support/return-material>
 ↳ Select the region.
2. Return the device if repairs or a factory calibration are required, or if the wrong device was ordered or delivered.

10.4 Disposal





If required by the Directive 2012/19/EU on waste electrical and electronic equipment (WEEE), the product is marked with the depicted symbol in order to minimize the disposal of WEEE as unsorted municipal waste. Do not dispose of products bearing this marking as unsorted municipal waste. Instead, return them to the manufacturer for disposal under the applicable conditions.

11 Accessories

Various accessories, which can be ordered with the device or subsequently from Endress+Hauser, are available for the device. Detailed information on the order code in question is available from your local Endress+Hauser sales center or on the product page of the Endress+Hauser website: www.endress.com.

11.1 Device-specific accessories

Designation	Order No.
PC configuration software ReadWin 2000 and serial configuration cable with 3.5 mm jack plug for RS232 port	RIA452A-VK
PC configuration software ReadWin 2000 and serial configuration cable for USB port with CDI connector	TXU10-AA
Field housing in IP65 →  25,  48	51009957
Current simulator active 4-20mA 1-channel, compact housing, 9V block battery	SONDST-S1

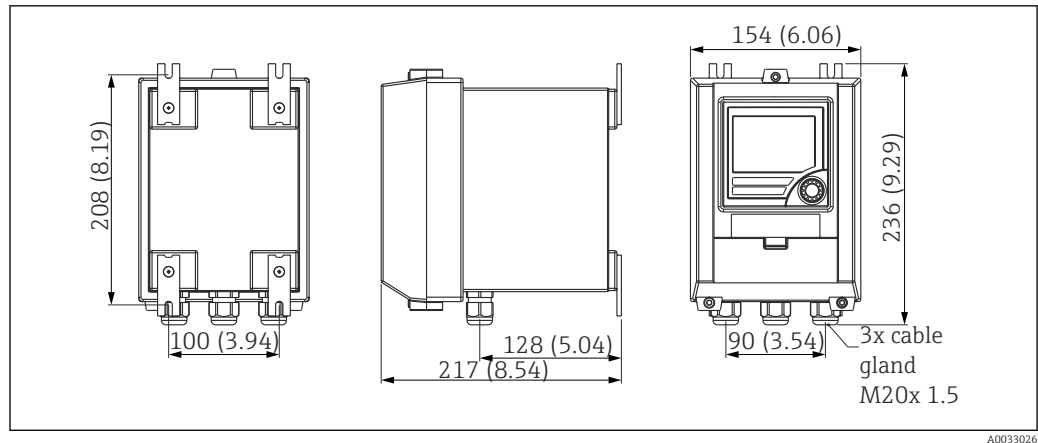

25 Field housing dimensions

12 Technical data

12.1 Input

12.1.1 Measured variable

- Current (standard)
- Digital inputs (standard)
- Current/voltage, resistance, RTD assembly, thermocouples (universal input option)

12.1.2 Measuring range

Current input:

Current:

- 0/4 to 20 mA +10% overrange, 0 to 5 mA
- Short-circuit current: max. 150 mA
- Input impedance: $\leq 5 \Omega$
- Response time: $\leq 100 \text{ ms}$

Universal input:

Current:

- 0/4 to 20 mA + 10% overrange, 0 to 5 mA
- Short-circuit current: max. 100 mA
- Input impedance: $\leq 50 \Omega$

Voltage:

- $\pm 150 \text{ mV}$, $\pm 1 \text{ V}$, $\pm 10 \text{ V}$, $\pm 30 \text{ V}$, 0 to 100 mV, 0 to 200 mV, 0 to 1 V, 0 to 10 V
- Input impedance: $\geq 100 \text{ k}\Omega$

Resistance:

30 to 3 000 Ω in 3/4-wire technology

RTD assembly:

- Pt100/500/1000, Cu50/100, Pt50 in 3/4-wire technology
- Measuring current for Pt100/500/1000 = 0.25 mA

Thermocouple types:

- J, K, T, N, B, S, R as per IEC584
- D, C as per ASTM E998
- U, L as per DIN43710/GOST
- Response time: ≤ 100 ms

Digital input:

Digital input:

- Voltage level –3 to 5 V low, 12 to 30 V high (as per DIN19240)
- Input voltage max. 34.5 V
- Input current typ. 3 mA with overload and reverse polarity protection
- Sampling frequency max. 10 Hz

12.1.3 Galvanic isolation

Towards all other circuits

12.2 Output

12.2.1 Output signal

- Relay, transmitter power supply (standard)
- Current, voltage, pulse, intrinsically safe transmitter power supply (option)

12.2.2 Signal on alarm

No measured value visible on the LC display, no background illumination, no sensor power supply, no output signals, relays behave in safety-oriented manner.

12.2.3 Current/voltage output

Analog output range:

0/4 to 20 mA (active), 0 to 10 V (active)

Load:

- $\leq 600 \Omega$ (current output)
- Max. output current 22 mA (voltage output)

Signal characteristics:

Freely scalable signal

Galvanic isolation towards all other circuits

12.2.4 Pulse output (open collector)

Pulse output (open collector):

- Frequency range to 2 kHz
- $I_{\max} = 200$ mA
- $U_{\max} = 28$ V
- $U_{\text{low}/\max} = 2$ V at 200 mA
- Pulse width = 0.04 to 2 000 ms

12.2.5 Relay output

Signal characteristics:

Binary, switches when the limit value is reached

Switch function: limit relay switches for the operating modes:

- Minimum/maximum safety
- Alternating pump control function
- Batch function
- Time control
- Window function
- Gradient
- Device malfunction
- Sensor malfunction

Switching threshold:

Freely programmable

Hysteresis:

0 to 99%

Signal source:

- Analog input signal
- Integrated value
- Digital input

Number:

4 in basic unit (can be extended to 8 relays, option)

Electrical specifications:

- Relay type: changeover
- Relay switching capacity: 250 V_{AC} / 30 V_{DC}, 3 A
- Switch cycles: typically 10⁵
- Switching frequency: max. 5 Hz
- Minimum switching load: 10 mA / 5 V_{DC}

Galvanic isolation towards all other circuits

 Mixed assignment of low and extra-low voltage circuits is not permitted for neighboring relays.

12.2.6 Transmitter power supply

Transmitter power supply 1, terminal 81/82 (optionally intrinsically safe):

Electrical specifications:

- Output voltage: 24 V ±15%
- Output current: max. 22 mA (for U_{out} ≥ 16 V, sustained short-circuit proof)
- Impedance: ≤ 345 Ω

Transmitter power supply 2, terminal 91/92:

Electrical specifications:

- Output voltage: 24 V ±15%
- Output current: max. 250 mA (sustained short-circuit proof)

Transmitter power supply 1 and 2:

Galvanic isolation:

Towards all other circuits

HART®

HART® signals are not affected

12.3 Power supply

12.3.1 Terminal assignment

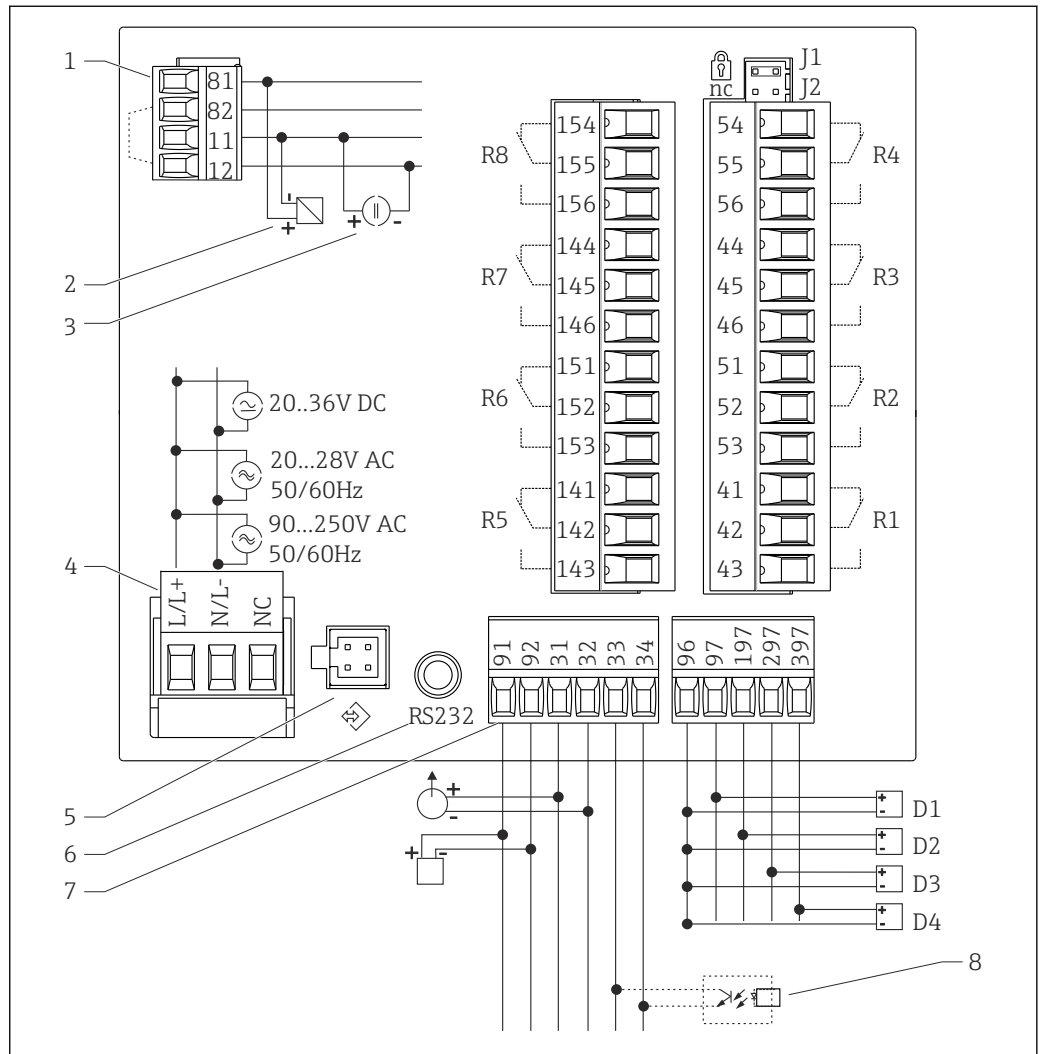

26 Terminal assignment of process indicator

A0028439

- | | | | |
|---|---|----------|--|
| 1 | Current input (12 and 82 jumpered internally) | 7 | Transmitter power supply and analog output |
| 2 | - passive sensor | 8 | Open collector output |
| 3 | - active sensor | D1 to D4 | Digital inputs |
| 4 | Power supply | R1 to R4 | Relay outputs |
| 5 | Interface for PC operating software | R5 to R8 | Relay outputs (optional) |
| 6 | RS232 interface | J1 | Hardware write protection |

Universal input option

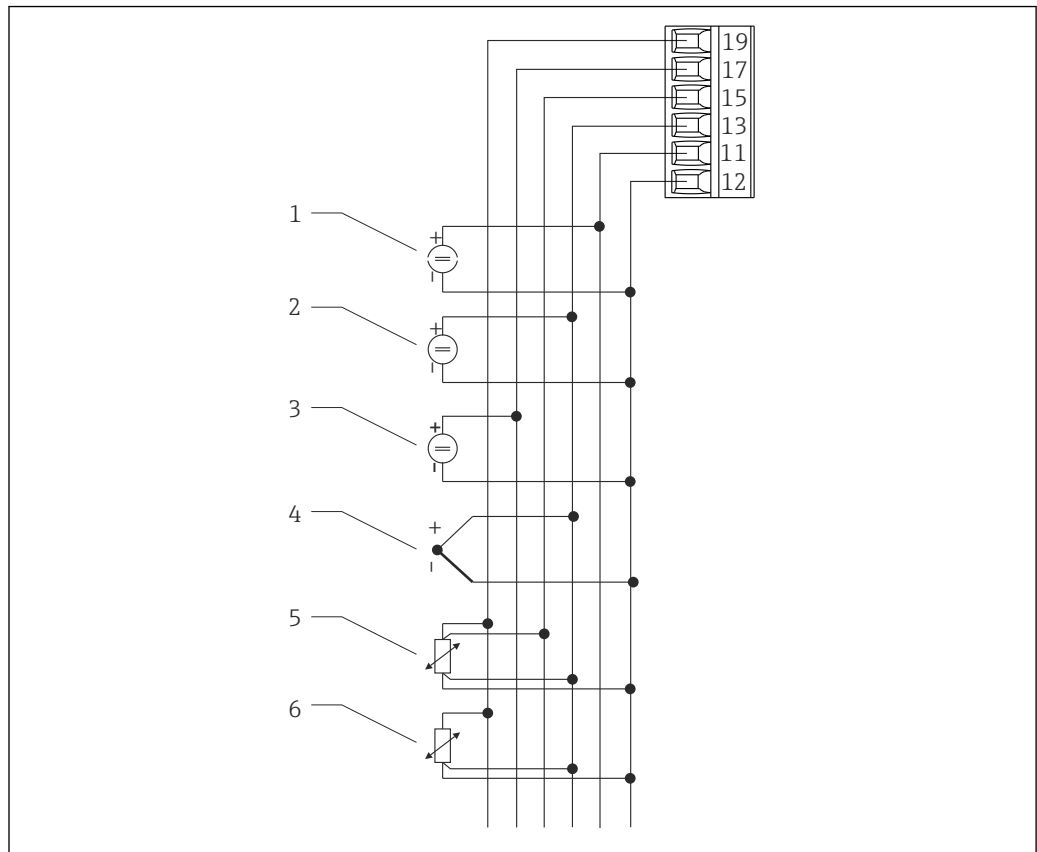

A0028457

27 Universal input terminal assignment

- | | | | |
|---|----------------------------|---|----------------------|
| 1 | Current input 0/4 to 20 mA | 4 | Thermocouples |
| 2 | Voltage input ±1 V | 5 | RTD assembly, 4-wire |
| 3 | Voltage input ±30 V | 6 | RTD assembly, 3-wire |

Interface connection data

RS232

- Connection: jack socket 3.5 mm, rear of device
- Transmission protocol: ReadWin 2000
- Transmission rate: 38 400 Baud

12.3.2 Supply voltage

- Low voltage power unit 90 to 250 V_{AC} 50/60 Hz
 - Extra-low voltage power unit 20 to 36 V_{DC} or 20 to 28 V_{AC} 50/60 Hz
- The device must be powered only by a power unit that operates using a limited energy circuit in accordance with UL/EN/IEC 61010-1, Section 9.4 and the requirements in Table 18.

12.3.3 Power consumption

Power consumption max. 24 VA

12.4 Performance characteristics

12.4.1 Reference operating conditions

Power supply: 230 V_{AC} ±10%, 50 Hz ±0.5 Hz

Warm-up period: 90 min

Ambient temperature: 25 °C (77 °F)

12.4.2 Maximum measured error

Current input

Accuracy	0.1% of full scale
Resolution	13 bit
Temperature drift	≤ 0.4%/10 K (18 °F)

Universal input

	Input:	Range:	Maximum measured error of measuring range (oMR):
Accuracy	Current	0 to 20 mA, 0 to 5 mA, 4 to 20 mA; overrange: to 22 mA	±0.10%
	Voltage > 1 V	0 to 10 V, ±10 V, ±30 V	±0.10%
	Voltage ≤ 1 V	±1 V, 0 to 1 V, 0 to 200 mV, 0 to 100 mV, ±150 mV	±0.10%
	Resistance thermometer	Pt100, -200 to 600 °C (-328 to 1 112 °F) (IEC751, JIS1604, GOST) Pt500, -200 to 600 °C (-328 to 1 112 °F) (IEC751, JIS1604) Pt1000, -200 to 600 °C (-328 to 1 112 °F) (IEC751, JIS1604)	4-wire: ± (0.10% oMR + 0.3 K (0.54 °F)) 3-wire: ± (0.15% oMR + 0.8 K (1.44 °F))
		Cu100, -200 to 200 °C (-328 to 392 °F) (GOST) Cu50, -200 to 200 °C (-328 to 392 °F) (GOST) Pt50, -200 to 600 °C (-328 to 1 112 °F) (GOST)	4-wire: ± (0.20% oMR + 0.3 K (0.54 °F)) 3-wire: ± (0.20% oMR + 0.8 K (1.44 °F))
	Resistance measurement	30 to 3 000 Ω	4-wire: ± (0.20% oMR + 0.3 K (0.54 °F)) 3-wire: ± (0.20% oMR + 0.8 K (1.44 °F))
	Thermocouples	Typ J (Fe-CuNi), -210 to 999.9 °C (-346 to 1 382 °F) (IEC584)	± (0.15% oMR + 0.5 K (0.9 °F)) from -100 °C (-148 °F)
		Typ K (NiCr-Ni), -200 to 1 372 °C (-328 to 2 502 °F) (IEC584)	± (0.15% oMR + 0.5 K (0.9 °F)) from -130 °C (-234 °F)
		Typ T (Cu-CuNi), -270 to 400 °C (-454 to 752 °F) (IEC584)	± (0.15% oMR + 0.5 K (0.9 °F)) from -200 °C (-328 °F)
		Typ N (NiCrSi-NiSi), -270 to 1 300 °C (-454 to 2 372 °F) (IEC584)	± (0.15% oMR + 0.5 K (0.9 °F)) from -100 °C (-148 °F)
		Typ B (Pt30Rh-Pt6Rh), 0 to 1 820 °C (32 to 3 308 °F) (IEC584)	± (0.15% oMR + 1.5 K (2.7 °F)) from 600 °C (1 112 °F)
		Typ D (W3Re/W25Re), 0 to 2 315 °C (32 to 4 199 °F) (ASTME998)	± (0.15% oMR + 1.5 K (2.7 °F)) from 500 °C (932 °F)
		Typ C (W5Re/W26Re), 0 to 2 315 °C (32 to 4 199 °F) (ASTME998)	± (0.15% oMR + 1.5 K (2.7 °F)) from 500 °C (932 °F)
Typ L (Fe-CuNi), -200 to 900 °C (-328 to 1 652 °F) (DIN43710, GOST)		± (0.15% oMR + 0.5 K (0.9 °F)) from -100 °C (-148 °F)	

	Input:	Range:	Maximum measured error of measuring range (oMR):
		Typ U (Cu-CuNi), -200 to 600 °C (-328 to 1 112 °F) (DIN43710)	± (0.15% oMR + 0.5 K (0.9 °F)) from -100 °C (-148 °F)
		Typ S (Pt10Rh-Pt), 0 to 1768 °C (32 to 3 214 °F) (IEC584)	± (0.15% oMR + 3.5 K (6.3 °F)) for 0 to 100 °C (32 to 212 °F) ± (0.15% oMR + 1.5 K (2.7 °F)) for 100 to 1 768 °C (212 to 3 214 °F)
		Typ R (Pt13Rh-Pt), -50 to 1 768 °C (-58 to 3 214 °F) (IEC584)	± (0.15% oMR + 1.5 K (2.7 °F)) for 100 to 1 768 °C (212 to 3 214 °F)
Resolution		16 bit	
Temperature drift		Temperature drift: ≤ 0.1%/10 K (18 °F)	

Current output

Linearity	0.1% of full scale
Resolution	13 bit
Temperature drift	Temperature drift: ≤ 0.1%/10 K (18 °F)
Output Ripple	10 mV at 500 Ω for frequencies ≤ 50 kHz

Voltage output

Linearity	0.1% of full scale
Resolution	13 bit
Temperature drift	Temperature drift: ≤ 0.1%/10 K (18 °F)

12.5 Installation

12.5.1 Mounting location

Panel, cut-out 92 x 92 mm (3.62x3.62 in) (see 'Mechanical construction').

12.5.2 Orientation

Horizontal +/- 45° in every direction

12.6 Environment

12.6.1 Ambient temperature range

-20 to 60 °C (-4 to 140 °F)

12.6.2 Storage temperature

-30 to 70 °C (-22 to 158 °F)

12.6.3 Altitude

Non-Ex version: < 3 000 m (9 840 ft) over MSL

Ex version: < 2 000 m (6 562 ft) over MSL

12.6.4 Climate class

To IEC 60654-1, Class B2

12.6.5 Degree of protection

IP 65/NEMA 4

Device casing IP 20

12.6.6 Shock and vibration resistance

2 Hz (+3/-0) to 13.2 Hz: ± 1 mm (± 0.04 in)

13.2 to 100 Hz: 0.7 g

12.6.7 Electromagnetic compatibility (EMC)

CE compliance

Electromagnetic compatibility in accordance with all the relevant requirements of the IEC/EN 61326 series and NAMUR Recommendation EMC (NE21). For details refer to the EU Declaration of Conformity.

Maximum measured error $< 1\%$ of measuring range.

Interference immunity as per IEC/EN 61326 series, industrial requirements.

Interference emission as per IEC/EN 61326 series, Class A equipment.

12.6.8 Electrical protection class

IEC 60529 (IP code)/NEMA 250

12.6.9 Condensation

Front: permitted

Device casing: not permitted

12.7 Mechanical construction

12.7.1 Design, dimensions

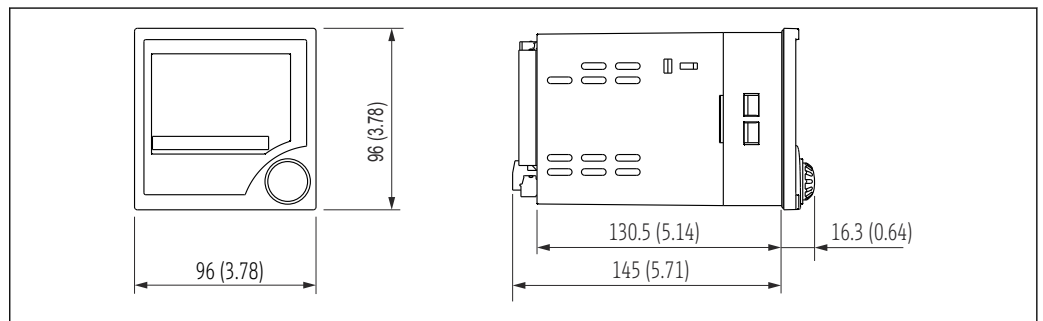

28 Dimensions of the process indicator in mm (in)

A0028475

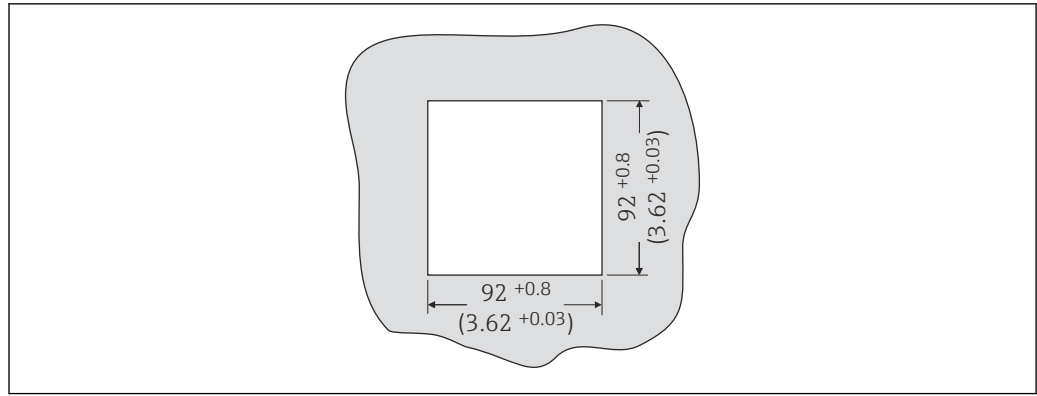

A0028476

29 Panel cutout, dimensions in mm (in)

12.7.2 Weight

500 g (17.64 oz)

12.7.3 Materials

- Housing front: ABS plastic
- Housing casing: ABS GF plastic

12.7.4 Terminals

Plug-in screw terminals, clamping range 1.5 mm^2 (16 AWG) solid, 1 mm^2 (18 AWG) strand with wire ferrule

12.8 Operability

12.8.1 Local operation

Display elements

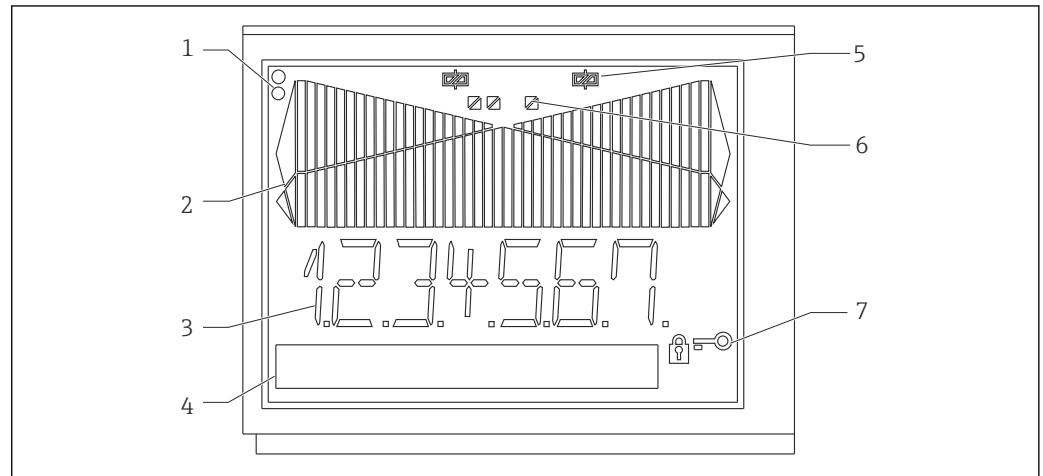

A0028477

30 Display elements of the process indicator

- 1 Device status LEDs: green - device ready for operation; red - device or sensor malfunction
- 2 Bar graph with overrange and underrange
- 3 7-digit 14-segment display
- 4 Unit and text field 9x77 dot matrix
- 5 Relay status indicator: if power is supplied to a relay, the symbol is displayed
- 6 Status indicator for digital inputs
- 7 Symbol for "device operation locked"

- Display range
 - -99999 to +99999 for measured values
 - 0 to 9999999 for counter values
- Signalization
 - Relay activation
 - Overrange/underrange

Operating elements

Jog/shuttle dial

12.8.2 Remote operation

Configuration

The device can be configured with the ReadWin 2000 PC software.

Interface

CDI interface at device; connection to PC via USB box (see "Accessories")

RS232 interface at device; connection with serial interface cable (see "Accessories")

12.9 Certificates and approvals

12.9.1 CE mark

The product meets the requirements of the harmonized European standards. As such, it complies with the legal specifications of the EC directives. The manufacturer confirms successful testing of the product by affixing to it the CE-mark.

12.9.2 Ex approval

Information about currently available Ex versions (ATEX, FM, CSA. etc.) can be supplied by your Endress+Hauser sales organization on request. All explosion protection data are given in a separate documentation which is available upon request.

12.9.3 Other standards and guidelines

The manufacturer confirms compliance with all the relevant external standards and guidelines.

12.10 Supplementary documentation

- System components and data manager - solutions to complete your measuring point:
FA00016K/09
-
- Ex-related additional documentation:
ATEX II(1)GD: XA00053R/09/a3

13 Appendix

13.1 Flow conversion

Conversion of various units to m³/h

Liter

- 1 l/s = 3.6 m³/h
- 1 l/min = 0.06 m³/h
- 1 l/h = 0.001 m³/h

Hectoliter

- 1 hl/s = 360 m³/h
- 1 hl/min = 6 m³/h
- 1 hl/h = 0.1 m³/h

Cubic meter

- 1 m³/s = 3 600 m³/h
- 1 m³/min = 60 m³/h

Megaliter

- 1 Ml/s = 3 600 000 m³/h
- 1 Ml/min = 6 000 m³/h
- 1 Ml/h = 1 000 m³/h

US gallon

- 1 USgal/s = 13.6274 m³/h
- 1 USgal/min = 0.2271 m³/h
- 1 USgal/h = 0.003785 m³/h

US kilogallon

- 1 US kgal/s = 13 627.4444 m³/h
- 1 US kgal/min = 0.2271 m³/h
- 1 US kgal/h = 0.003785 m³/h

US megagallon

- 1 USMgal/s = 13 627 481.6155 m³/h
- 1 USMgal/min = 2 271 246 936 m³/h
- 1 USMgal/h = 3 785.4118 m³/h

US barrel

- 1 US bl/s = 429.264 m³/h
- 1 US bl/min = 7.1544 m³/h
- 1 US bl/h = 0.1192 m³/h

Imperial gallon

- 1 Imp.gal/s = 16.3659 m³/h
- 1 Imp.gal/min = 0.2728 m³/h
- 1 Imp.gal/h = 0.004546 m³/h

Imperial barrel

- 1 Imp.bl/s = 589.1955 m³/h
- 1 Imp.bl/min = 9.8195 m³/h
- 1 Imp.gal/h = 0.1637 m³/h

Cubic inch

- 1 in³/s = 0.05899 m³/h
- 1 in³/min = 0.00098322 m³/h
- 1 in³/h = 0.000016387 m³/h

Cubic foot

- 1 ft³/s = 101.9406 m³/h
- 1 ft³/min = 1.699 m³/h
- 1 ft³/h = 0.0283 m³/h

Index

0 ... 9

24-hour activation function 33

A

Adjusting the analog input 23

Alarm 31

Alternating pump control 32

Analog input 22

Analog output 24

C

Calculation formula for flow measurement 38

CE mark 7, 58

Configuring the measuring device 21

D

Declaration of Conformity 7

Delay 31

Device failure 44

Digital input 25

Display 23

E

Error messages 44

F

Flow

 Calculation 38

I

Incorrect entries 44

Integration 33

Integration function 38

L

Limit values 27

 Alarm operating mode 31

 Alternate 32

 Delay 31

 Grad operating mode 30

 Max operating mode 29

 Min operating mode 29

Linearization table 40

 Points 42

M

M1/INPUT 22

M2/DISPLAY 23

M3/ANALOG OUT 24

M5/DIGITAL INP. 25

M10 to 17/LIMIT 1 to 8 27

M18/INTEGRATION 33

M19/PULSE OUT 39

M20/MIN MAX 40

M21/LIN. TABLE 40

M23...MXX/LINPOINTS 1...X 42

M55/PARAMETER 42

Menu

ANALOG OUT 24

DIGITAL INP. 25

DISPLAY 23

INPUT 22

INTEGRATION 33

LIMIT 1 to 8 27

LIN. TABLE 40

LINPOINTS 1...X 42

MIN MAX 40

PARAMETER 42

PULSE OUT 39

Min/Max memory 40

O

Operating parameters 42

Operational safety 7

P

Points 42

Preset counter 38

Process error messages 43

Product safety 7

Pulse output 39

Pump monitoring 25

R

Registered trademarks 6

Requirements for personnel 6

Return 47

S

Spare parts 45

T

Tank linearization 41

Totalizer 38

Troubleshooting 43



71602335

www.addresses.endress.com
