

D4T Data Logger Setup and Operations User's Guide



D4T™



WATLOW®

Powered by Possibility



ISO 9001



Registered Company
Winona, Minnesota USA

1241 Bundy Boulevard., Winona, Minnesota USA 55987
Phone: +1 (507) 454-5300, Fax: +1 (507) 452-4507
<http://www.watlow.com/F4T.cfm>

1247-5282 Rev. C



January 2020

Made in the U.S.A.

Safety Information

We use note, caution and warning symbols throughout this document to draw your attention to important operational and safety information.









A “NOTE” marks a short message to alert you to an important detail.

A “CAUTION” safety alert appears with information that is important for protecting your equipment and performance. Be especially careful to read and follow all cautions that apply to your application.

- A “WARNING” safety alert appears with information that is important for protecting you, others and equipment from damage. Pay very close attention to all warnings that apply to your application.

The safety alert symbol, (an exclamation point in a triangle ⚠) precedes a general CAUTION or WARNING statement.

The electrical hazard symbol, (a lightning bolt in a triangle ⚡) precedes an electric shock hazard CAUTION or WARNING safety statement. Further explanations follow:

Symbol	Explanation
 CAUTION WARNING	CAUTION: Warning or Electrical Hazard that needs further explanation than label on unit can provide. Consult QSG for further information.
 Electrical Shock Hazard	AVERTISSEMENT: mise en garde ou danger qui demande plus de précisions que l'information sur l'étiquette de l'unité. Consultez le manuel de l'utilisateur pour plus d'informations.
	Unit can be powered with either alternating current (ac) voltage or direct current (dc) voltage.
	ESD Sensitive product, use proper grounding and handling techniques when installing or servicing product.
	Do not throw in trash, use proper recycling techniques or consult manufacturer for proper disposal.
	Enclosure made of Polycarbonate material. Use proper recycling techniques or consult manufacturer for proper disposal.
	Unit is a Listed device per Underwriters Laboratories®. It has been evaluated to United States and Canadian requirements for Process Control Equipment. CSA 22.2#14, File 158031, UL 61010, File E185611 QUXX, QUXX7. See: www.ul.com
	Unit is compliant with European Union directives. See Declaration of Conformity for further details on Directives and Standards used for Compliance.
	Unit has been reviewed and approved by Factory Mutual as a Temperature Limit Device per FM Class 3545 standard. See: www.fmglobal.com

Symbol	Explanation
	Unit has been reviewed and approved by CSA International for use as Temperature Indicating-Regulating Equipment per CSA C22.2 No. 24. See: www.csa-international.org

This D4T User's Guide is copyrighted by Watlow Electric Manufacturing Company, © 2016-2020 with all rights reserved.

- © 1996 -2020, Curl and libcurl. All rights reserved.
- © 2008 -2014, Crank Software Inc. All rights reserved.
- Watlow® and Composer® are registered trademarks of Watlow Electric Manufacturing Company.
- UL® is a registered trademark of Underwriter's Laboratories Incorporated.
- Modbus® is a registered trademark of Schneider Automation Incorporated.
- Vaisala® is a registered trademark of Vaisala OY Corporation.
- Microsoft® and Windows® are registered trademarks of the Microsoft Corporation.
- Quencharc® is a registered trademark of ITW Paktron.

- 10-14628 Rev. C



Table of Contents

- Table of Contents** **1**
- Technical Assistance 3
- Chapter 1: Overview** **3**
- Available D4T Literature and Resources 3
- Document Overview and Purpose 4
- A Conceptual View of the D4T System 5
- Inputs 6
- Functions 6
- Outputs 7
- Data Logging 7
- Chapter 2: Composer[®] Software** **8**
- Installing Composer[®] Software 8
- Using Composer[®] Software 9
- Overview Screen 11
- Device Details 16
- Configuring Pluggable Flex Modules 17
- Configuring the Application using the Function Block Diagram 19
- Personalizing the User Interface (UI) Using Composer[®] 26
- Setting Up Data Log Files Using Composer[®] 26
- Chapter 3: Using the D4T Front Panel** **35**
- Navigating and Understanding the User Interface (UI) 35
- Front Panel Navigational Buttons 35
- Understanding F4T Menus 36
- Multiple Languages 37
- Event Driven Menus 38
- Home Screen Described 39
- Configuring Ethernet Communications 40
- Default Ethernet Parameters and Settings 40
- Personalizing the Home Screen Using the UI 41
- Front Panel Usage From the Home Screen 43
- Changing Data Logger Operational Parameters 43
- F4T with USB Mouse Feature 43
- Batch Processing Programming - Batch Menu 44
- Batch Processing Programming - 3 Simple "How To" Programming Steps 44
- Batch Processing Programming - 3 Simple "How To" Programming Steps (con't) . . . 45
- Batch Processing Programming - 3 Simple "How To" Programming Steps (con't) . . 46
- Export Data Log Report - Via USB Stick 47
- Using the Output Widget 48

Table of Contents (cont.)

Email and Text Alerts	52
Step 1: Email Server Settings	53
Step 2: Send an Alert Test Message	54
Step 3: Defining Contacts	55
Step 4: Configuring Alerts	56
Chapter 4: Application Examples	58
Applications	58
Process Alarm	58
Deviation Alarm	59
Sensor Backup	61
Chapter 5: Function Block Reference	62
D4T Functions Described	65
Alarm	66
Analog Outputs	73
Compare	75
Counter	79
Digital Inputs/Outputs (I/O)	82
Digital Outputs	85
Key	88
Linearization	89
Logic	96
Math	104
Signals	106
Process Value	118
Special Output	130
Thermistor Input	133
Timer	136
Universal Input	143
Variable	154
Chapter 6: Appendix	157
Communications	157
Introduction to Standard Commands for Programmable Instruments (SCPI)	157
Modbus Table Orientation	158
D4T Base Specifications	205
Flex Modules and Limit I/O Specifications	209
Flex Modules - High Density I/O Specifications	213
Flex Module - High Density Ordering Information	216
Flex Module - Communications Ordering Information	216

1

Chapter 1: Overview

Available D4T Literature and Resources

Document Title and Part Number	Description
D4T Installation and Troubleshooting User Guide, part number: 0600-0104-0000	Provides detailed specifications and information regarding mounting the D4T base, flex module wiring and troubleshooting.
D4T Specification Sheet, part number: WIN-D4T-0419	Describes D4T hardware options, features, benefits and technical specifications.
Watlow Application Guide	Comprehensive guide to understanding thermal principles, electrical noise, best practises for wiring industrial controls and much more.
Watlow Support Tools DVD, part number: 0601-0001-0000	Contains all product related user documents and software (Composer™), video tutorials, application notes and more.

To acquire one or more of these documents navigate to the Watlow website where you will have a choice to download free copies or purchase printed versions. Click on the link below to find your document of choice: <http://www.watlow.com/d4t>

Your Comments are Appreciated

In an effort to continually improve our technical literature and ensuring that we are providing information that is useful to you, we would very much appreciate your comments and suggestions. Please send any comments you may have to the following e-mail address:

TechlitComments@watlow.com

Technical Assistance

If you encounter a problem with your Watlow data logger, review your configuration information to verify that your selections are consistent with your application: inputs, outputs, alarms, etc. If the problem persists, you can get technical assistance from your local Watlow representative (see the Appendix in this User's Guide), by e-mailing your questions to wintechsupport@watlow.com or by dialing +1 (507) 494-5656 between 7 a.m. and 5 p.m., Central Standard Time (CST). Ask for for an Applications Engineer. Please have the following information available when calling:

- Complete model number
- User's Guide
- All configuration information

Warranty

This product is warranted by Watlow for a period of 36 months in accordance with the terms and conditions set forth on Watlow's website, which can be accessed at www.watlow.com/terms.

Return Material Authorization (RMA)

1. Call Watlow Customer Service, (507) 454-5300, for a Return Material Authorization (RMA) number before returning any failed product to Watlow. If you do not know why the product failed, contact an Application Engineer or Product Manager. All RMA's require:
 - Ship-to address
 - Bill-to address
 - Contact name
 - Phone number
 - Method of return shipment
 - Your P.O. number
 - Detailed description of the problem
 - Any special instructions
 - Name and phone number of person returning the product.
2. Prior approval and an RMA number from the Customer Service Department is required when returning any product. Make sure the RMA number is on the outside of the carton and on all paperwork returned. Ship on a Freight Prepaid basis.
3. After we receive your return, we will examine it to verify the reason for the product failure. Unless otherwise agreed to in writing, Watlow's standard warranty provisions, which can be located at www.watlow.com/terms, will apply to any failed product.
4. In the event that the product is not subject to an applicable warranty, we will quote repair costs to you and request a purchase order from you prior to proceeding with the repair work.
5. Watlow reserves the right to charge for no trouble found (NTF) returns.

Document Overview and Purpose

This document looks deeper at the system configuration using Composer™ software and the D4T function blocks and their associated connections. Common product usage is described and illustrated through application examples.

A Conceptual View of the D4T System

The flexibility of the D4T data logger hardware and software (Composer™) allows for a large range of configurations. Composer software is a graphically based tool used to program the D4T data logger in its entirety. To learn more about installing and using Composer software see Chapter 2 of this document in the section titled "[Installing Composer Software](#)".

Acquiring a better understanding of the data logger's overall functionality and capabilities while at the same time planning out how the data logger can be used will deliver maximum effectiveness in your application.

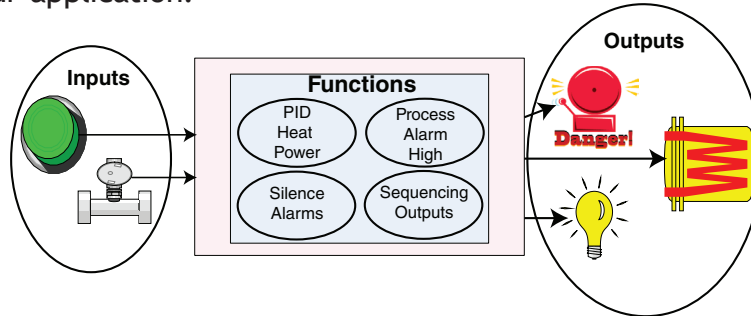

It is useful to think of the data logger in three parts: inputs, functions and outputs. For the control itself, information flows from an input to a function to an output when the data logger is properly configured. The D4T system can carry out several functions at the same time; such as, monitoring and acting upon various inputs (temperature sensing devices, pressure transducers and digital inputs), PID control, monitoring for several different alarm situations and then driving output devices such as heaters, audible alarms, and lights. Each process needs to be thought out carefully and the data logger's inputs, functions and outputs set up properly. As an example, the graphic below illustrates the Function Block Diagram as seen when using Composer software. The application requirements in this example are simple and defined below:

- Need two thermocouple inputs.
- Monitor both thermocouple inputs for high process alarms.
- Drive an output (alarm) device if either input is higher than expected.
- Use one thermocouple input to drive the PID loop (Heat output) with a switched DC output.

In the graphic below the following is true:

- Universal Input 1 is connected to the Process Value (PV) input of the control loop.
- When the control loop sees that the PV is less than the user defined set point it will drive the output to the load through its heat (HT) output.
- Two unique high process alarms are configured to monitor Universal Inputs 1 and 2.
- The logic function block (FB) is configured as an OR where its output will come on if either input comes on driving the real-world digital output (alarm) it's connected to.

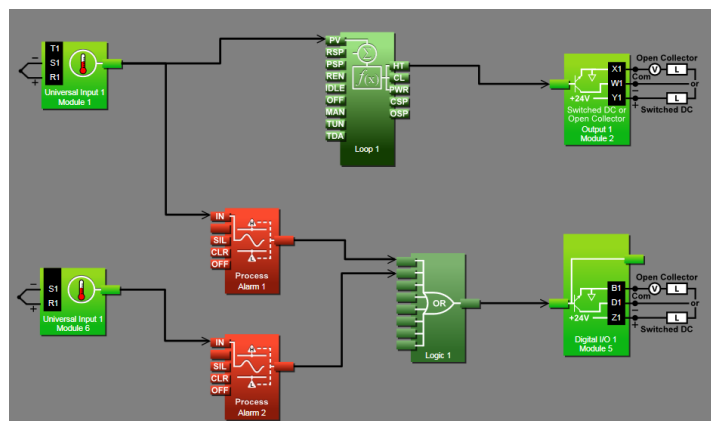

Note:

In this configuration, the heat output of the control function would be uninterrupted if an alarm were to occur.

You will find more detailed information regarding the function blocks and how they work further on in this document.

Inputs

The inputs provide the information that any given programmed function can act upon. In a simple form, this information may come from an operator pushing a button, or as part of a more complex function it may represent a remote set point being received from another zone.

Each universal input can be configured for thermistors, thermocouples, or RTDs to read the process variable. They can also read mV/volts, current or resistance, enabling usage of various devices to read humidity, air pressure, operator inputs and other values. The settings associated to each analog input must be configured to match the device connected to that input.

Each digital input reads whether a device is on or off (voltage or resistance) and each system can be equipped with multiple digital I/O modules. Each I/O point must be configured to function as either an input or output.

Functions

Functions use input signals to calculate a value and or performs an action. A function may be as simple as reading a digital input as on or off, or reading an analog value (temperature) to set an alarm state to on or off. As an example, a user could use sensor backup to avoid an unwanted shutdown if a failure with the primary sensing device should occur.

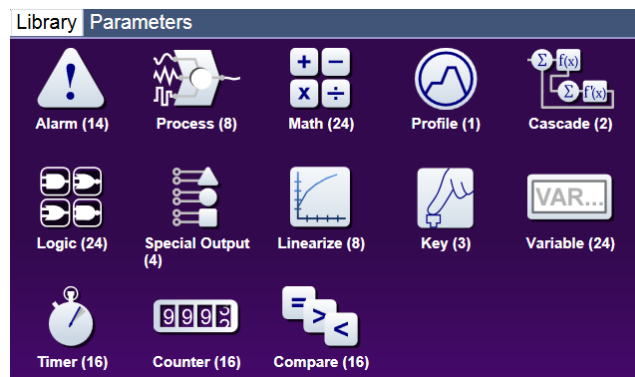

Keep in mind that a FB can be a purely internal function (i.e., control loop, alarm, logic, etc...), while they can also serve as a connection point between real-world devices (i.e., thermocouple, heater etc...) and internal functions like a Universal Input connected to the Control Loop PV input. To have an effect outside of the data logger, an output FB must be configured to respond to some other function. Functions and all associated dependencies would be configured using Composer software. To learn more about setting up function blocks see Chapter 2 of this document in the section titled "[Configuring the Application with the Function Block Diagram View](#)".

Outputs

Outputs respond to information provided by a function such as, driving a digital output to turn a light on or off, unlocking a furnace door or turning on a buzzer.

More than one output can be assigned to respond to any given function, i.e., more than one output device could be connected to the heat output of the control block. Another example (not shown), could use the (internal) output of the alarm function and connect it to any available real-world output to trigger a flashing light and another real-world output that might be connected to a siren.

Data Logging

Data loggers will have the letter [J, K, L or M] in the fifth character of its part number (see: D4T Ordering Information). Logging can be enabled at any time and is intended to capture real-time data for a user selectable list of data points. With firmware revision 3.0 and above, several new features are available.

1. User can determine if logged files will be moved automatically and or manually.
2. Destination of the saved file can be directed to internal memory, USB thumb drive, TFTP server or a Samba shared drive.
3. Based on user choice, files can now be encrypted (filename.enc) for security purposes and or saved as comma separated values (filename.csv). Creating both file types allows viewing of the csv file while maintaining the integrity of the encrypted file.

To learn more about configuring these options see the section in this user's guide entitled [Setting Up Data Log Files Using Composer](#).

2

Chapter 2: Composer® Software

Data Logger Configuration and Setup

Installing Composer® Software

Locating the Software and System Requirements

Composer software is included on the "Watlow Support Tools" DVD which ships with the product. As an alternative, the software can also be downloaded at: [http:// D4T.watlow.com](http://D4T.watlow.com) or <http://www.watlow.com/downloads/en/software/composer.cfm>

In order to install and run this software successfully there are some baseline requirements for PC hardware and operating systems that must be observed. These requirements are listed below:

- 250 Megabytes or more of available hard disk drive space
- 300 Megabytes of available RAM
- Supported operating systems include: Windows® 7 / 8 / 8.1 / 10 (32 or 64 bit)
- Requires Microsoft® .NET Framework 4.0 (this installs automatically if not already on target machine)

Installing the Software

To install the software:

1. Double-click the Setup.exe.
2. Select the language of choice and click the **OK** to proceed.
3. Click the **Next** button to proceed.
4. After reading the Composer® software license agreement click the **I accept the terms in the License Agreement** radio button and then click on the **Next** button to proceed.
5. The next dialog box that will appear shows the default directory in which the software will be installed. The install location can be changed by clicking the **Browse** button and then point to the preferred location.
6. Click **Next** and then **Install**.
7. Clicking the **Finish** button will conclude the installation.

Note:

If experiencing difficulties installing or using Composer software, prior to contacting Watlow technical support, be prepared to send the user log file to the tech support team. This text file can be found here: C:\Users\username\AppData\Roaming\Watlow\Composer\Logs

The red text above will change to the user's Windows login name.

Using Composer® Software

Connecting the PC to the Data logger - Physical Connections

Physical connections (hardware and cabling) will vary depending on the data logger in use.

1. To find instructions connecting an D4T data logger to a PC see: Chapter 3 of the D4T Installation and Troubleshooting User's Guide.

Starting Composer Software:

1. Click the **Start** button and then type composer.exe in the search box.

Composer Welcome Screen Orientation

The graphic below illustrates and defines some points of interest as seen on the Composer Dashboard screen and describes the functionality, numbered correspondingly.

Dashboard (Systems)

- Displays options for on-line connections between PC and a data logger or opening previously saved system image.

Data Logs Menu

- Decrypt Log File: allows for decryption of an encrypted data log file.
- View: displays the contents of a data logged file (enc or csv). Depending on files size this may take several minutes to open.

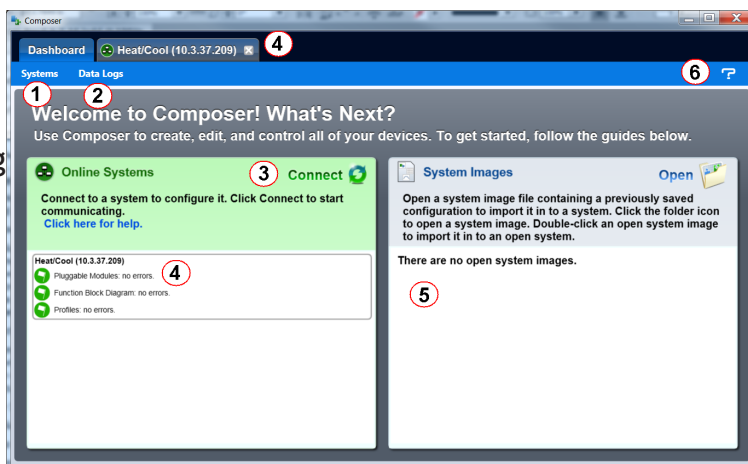

To decrypt an encrypted file follow the steps below:

1. If data logging has not yet been stopped do so now by pushing: **Main Menu -> Data Logging -> Stop** buttons.

Note:

When data logging is stopped, allow at a minimum, six minutes for closure of all files and movement of those files to the selected destination before attempting decryption.

2. Open up Composer software and click on **Data Logs** and then **Decrypt Log Files**.
3. Locate the encrypted files and open them one-by-one (click on one *.enc file and click **Open**), or by selecting more than one and click the **Open** button.

Note:

If logged file is sent to USB, the *.csv and the *.enc file are written directly to USB constantly. If the File Size Limit is set to 10MB or larger, the csv will continue to be written continuously while the encrypted portion (*.enc) is chunked into 7.5MB files, buffered internally and then written out as 7.5MB chunks. If the maximum file size is set to 10MB, there will be two *.enc files for each csv (7.5MB and 2.5MB). If File Size Limit is set to 15MB, there would be two 7.5MB *.enc files for each *.csv file.

Note:

As noted above, if a csv file is greater than 10MB there will be more than one encrypted file for the associated csv file. When decrypting these files, it is recommended that all encrypted files be selected in the decryption process. Each of the encrypted files will be concatenated into one csv file.

- After selecting the desired encrypted files and then clicking **Open**, the window below will appear. Notice the filename of the original csv and the one suggested in the dialog box highlighted yellow below. The one within parentheses (1) is inserted to avoid overwriting the original csv file. You may name the file to your liking.

Note:

The largest file size allowed is 1GB. If decrypting a file of this size it could take up to 10 minutes to complete.

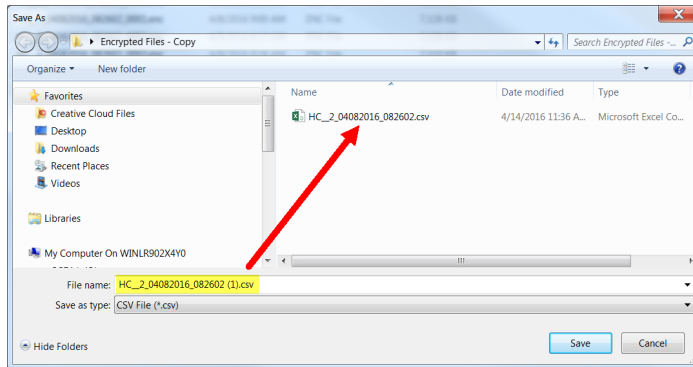
**Connect to a System**

- Opens a window showing all available communications ports.

Online Systems

- Displays all connected systems.

Open a System Image

- Opens a dialog box showing the default folder structure.

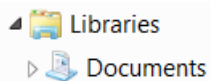

To import a system image follow the steps below:

1. Connect to the desired online system described above
2. Click **Open** to search storage device and find the desired system image
4. Double-click on the desired system image
5. Once the system image is opened click on the button below:

Import image to system

6. Select the system to be configured and click **continue**

Note:

Use caution when considering this option, once initiated, data logger memory will be overwritten in its entirety and replaced with the new system image.

System Images

- Displays all opened system images.

Question Mark (?)

- Allows a user to do the following:
 - Update Settings, Change automatic software update settings
 - Check For Updates, Initiate an immediate check for software updates (internet connection is required)
 - Dashboard Help, Provides description and information pertaining to the Dashboard
 - About, Displays technical support contact information as well as the current versions of the installed software and installed modules.

Overview Screen

Topics discussed in this section follow:

Connecting to an Online System: from the Dashboard connect to an online system.

Overview Screen Orientation: visually identifies all devices connected to the system.

System Menu: when clicked, a drop down submenu will appear.

Device Menus: when clicked, a unique drop down submenu will appear for each device or data logger on the system. The menus provide access to device specific screens.

Global Settings: set temperature units and AC line frequency for the system.

Security: allows for multiple levels of password protection.

Saving a System Image: save a system image to a storage device.

Import System Image: restore a system image from a storage device to the data logger.

The graphic below, shows the first displayed screen (System Overview) after connecting to a system.

Connecting to an Online System

To connect to a system:

1. On the Dashboard screen click **Connect**.
2. Select the communications port that the system is connected to and then click **Continue**.
3. Double-click on the desired online system.

To view the system overview:

1. On the Dashboard under Online Systems, double-click the desired system.

Overview Screen Orientation

The graphic below illustrates and defines some points of interest as seen in the system overview with each identified by a corresponding circled number. Further information for each can be found just below the orientation.

This screen can be accessed from within any Composer® view always rendering a visual display of all devices connected on the system while also providing navigation to and from each device.

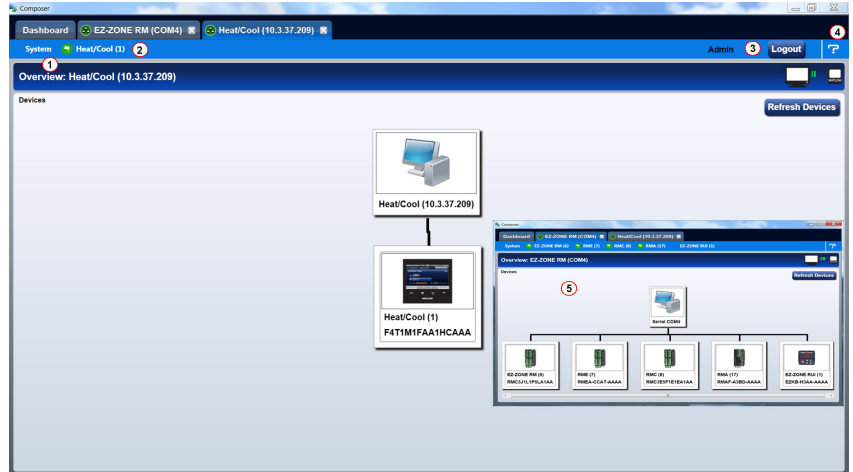

System Menu

- Overview: displays the screen shown at the right.
- Save Image: saves a previously saved system image using the same name and the same destination folder.
- Save Image As: saves system image with a new name to the user specified folder.
- Import Image: select a previously saved system image to download to the device.
- Print: active when viewing the function block diagram. What's printed will be exactly what can be seen on the canvas. If all FBs are not visible, scale the canvas using the Navigator plus and minus buttons and then click the **System** tab and then **Print**.
- Global Settings: for use throughout the data logger changes settings for Temperature units, AC Line Frequency, and Date and Time.
- Security: allows the administrator to determine and set security privileges to avoid unwanted changes.



Device Menus

- When clicked, a drop down submenu will appear allowing navigation to device level menus. Each device will have one of three flags displayed immediately to its left. Those flags are described in the following table.

Symbol	Menu Item	Description
	Pluggable Modules	All expected modules and no unexpected modules are present (D4T only).
	Function Block Diagram	No signals have errors.
	Pluggable Modules	A module has been detected in a slot the data logger expects to be empty (D4T only).
	Function Block Diagram	At least one unexpected module has been detected, however, all expected modules are present.
	Pluggable Modules	At least one expected module is missing (D4T only).

Security

- When enabled, displays current level of access with the ability to logout.

Question Mark (?)

- Provides help for each of the options mentioned above.

Inset Picture of Rail Mount (RM) modules connected as a system.

Global Settings

Each of the settings below will be used and applied throughout the data logger.

- **Temperature Units:** will determine how the temperature is displayed (Fahrenheit or Celsius) on the front panel of the data logger as well as throughout all configuration screens within Composer®.
- **AC Line Frequency:** set this to the line frequency of the power applied to loads such as heaters (50 Hz or 60 Hz) so that the current sensing and variable time-base features will work correctly.
- **Date and Time:** sets the date, time and time zone to the current computer settings or whatever the user enters.

Security

The security feature is used to protect the system's configuration and settings from unwanted changes. The Admin user sets what access other users have to the system's features. When security is enabled, a user must enter a password to gain access to protected features through the data logger's user interface or Composer software.

There are three configurable user groups and an admin account:

- **User:** no password required, admin sets feature access
- **User with Password:** requires a password, admin sets feature access, is permitted to change the password for this user group.
- **Maintenance User:** requires a password, admin sets feature access, is permitted to change the password for this user group.
- **Admin:** requires a password, has unlimited access to features, sets permissions and passwords for all user groups.

The Admin user can set permissions for each user group to allow full, read-only or no access to the following features:

- **Home:** controls access to data logger's home screen.*
- **Control Mode:** controls access to setting the control mode, set points and PID parameters.
- **Autotune:** controls access to running the autotune feature.
- **PID Settings:** controls access to the PID settings.
- **Global Settings:** controls access to the system's global settings, temperature units, AC line frequency and real time clock setting.
- **Network:** controls access to communications settings.
- **Operations:** controls access to operational parameter settings.*
- **Personalization:** controls access to customizing the data logger's home screen.
- **Data Logging Setup:** determines frequency of logging, location of saved files and other general information.
- **File Transfer:** allows a user to transfer files (Configuration and Data log) to/from the data logger.
- **Diagnostics and Troubleshooting:** controls access to the device details and calibration.

- Setup: controls access to the pluggable module configuration and the function block diagram.

**This setting limits access to the data logger's User Interface (UI) only, not via Composer®.*

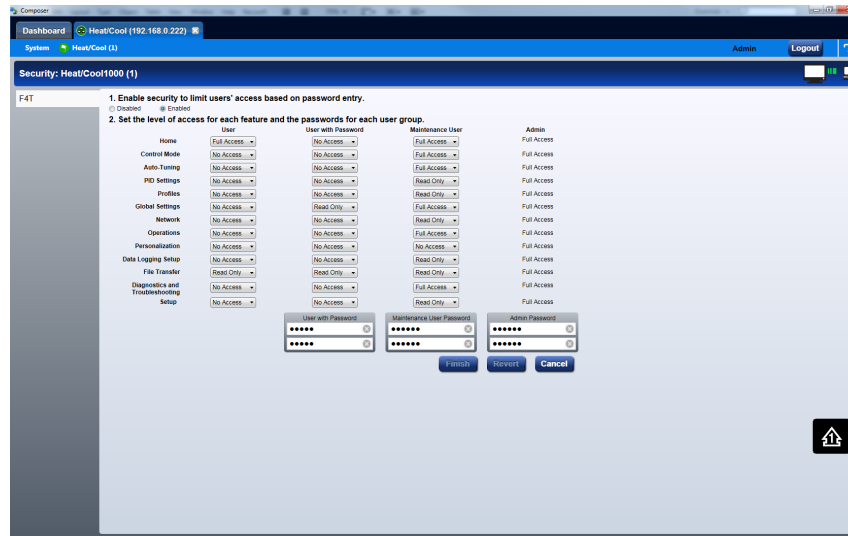

Note:

After making all of the desired security settings, ensure that the security enabled radio button (top left in the graphic above) is selected Enabled.

Note:

If the passwords have been misplaced or forgotten it will be necessary to contact the OEM or as a last resort [Watlow Technical Assistance](#).

Note:

Once security is applied to the data logger, only the administrator (Admin) can reconfigure or remove the security.

Note:

When the system file is saved, any applied security will be saved with it.

Save Image

After clicking on save image as, the save button will become active (gray to white). This allows a user to make changes to the system image and simply save it to the same location using the same filename. Everything that will be saved is as listed below:

- Device Details
- Pluggable Modules (D4T only)
- Function Block Diagram in its entirety
- System Security
- All parameters that can be read and written to

Save Image As

- Allows user to specify a name and storage location while saving everything in the list above.

Saving a System Image

To save a system image the first time:

1. From any screen click on the System Menu tab to drop down a submenu.
2. Click the **Save Image As** button.
3. Use the save as dialog to select the destination folder for the image.
4. Enter the desired filename.
5. Click **Save**.

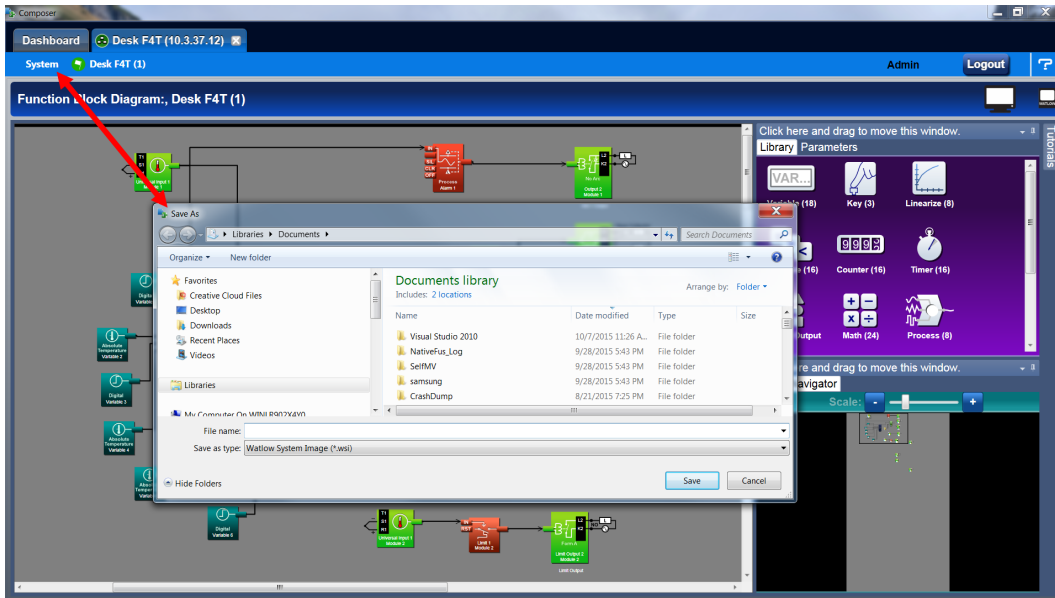

Note:

The system image filename will always have the extension wsi for Watlow System Image and cannot be changed.

Note:

The real-time clock values are not saved or imported.

Import Image

- Restore a system image from a storage device to the data logger. The list below shows what is restored:
 - Device Details
 - Pluggable Modules (D4T only)
 - Function Block Diagram in its entirety
 - System Security
 - All parameters that can be read and written to

Importing a System Image

To import a system image:

1. From any screen click on the System menu tab to drop down a submenu.
2. Click the **Import Image** button.
2. Use the open dialog to select the folder location for the previously saved system image.
3. Double-click the desired filename or single-click the filename and then click the **Open** button.

Note:

Importing a system image will overwrite the data logger in its entirety. Careful thought should be applied prior to importing.

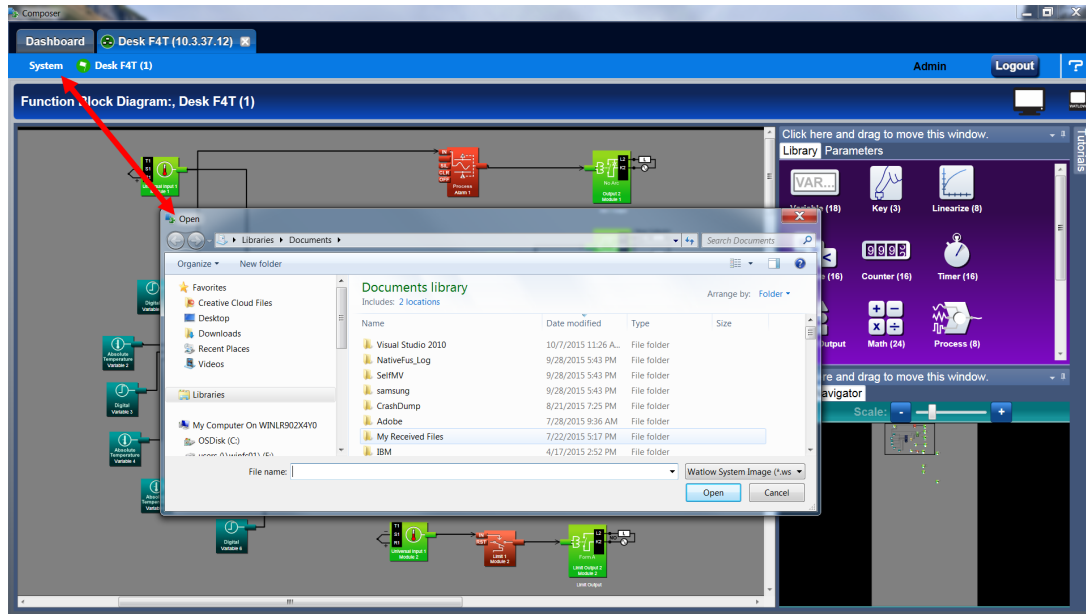

Device Details

The Device Details allows a user to make changes to the system settings described below. Descriptions are numbered correspondingly in the graphic that follows.

Navigate to Device Details:

1. From any screen click on the Device menu tab to drop down a submenu.
2. Click the **Device Details** button.

Device Name - change the name (32 characters maximum) of the data logger for easy identification.

Note:

This name will also be displayed in the upper left corner of the user interface.

Restore Settings From

- None: no action.
- Factory: allows a user to bring the data logger back to the factory default state.



Configuring Pluggable Flex Modules

This data logger can have up to six Flex Modules (FM) installed in the chassis. The presence of each FM must be confirmed and accepted using Composer® software. FMs can be fully configured as installed hardware or the user can type in a valid FM part number for later installation. For more detail regarding the module installation process, see the Installation and Troubleshooting User's Guide for the data logger in use.

Note:

Typing in a valid part number without the presence of the module is intended for the sole purpose of building the FBD (connecting function blocks on the canvas). Errors may be generated and all outputs will be off until the module is inserted.

Topics discussed in this section follow:

Screen Orientation: detailed description of the Pluggable Module configuration screen and associated characteristics.

Symbols Related to Pluggable Modules: description of the symbols that may be displayed when using Composer software.

Configuring Flex Modules: configuration process described.

Entering FM Information Before Module Installation: detailed description of the why and how a user would do this prior to acquiring the module.

Note:

The graphic below represents a data logger that first had its flex modules installed with the data logger and then being connected to a computer. Because of this scenario each slot appears with no *expected* modules. This screen and symbols that are displayed will look different using a different scenario.

Navigate to Pluggable Modules screen:

1. From any screen click on the **Device Menu** tab to drop down a submenu.
2. Click the **Pluggable Modules** button.

Pluggable Flex Modules - Screen Orientation

Module Slot - Location

- The blue box (on the right) and the slot highlight will move with the mouse to bring focus to the slot/module.

Use Detected Part Number

- Click this button to accept the module that the system sees as being present in the slot and displayed in the field identified as "Detected Part Number".



Set Expected To None

- Click on the X to tell the system there will be no module installed in this slot. Taking this action will turn the power off for this slot after the data logger is reset.

Detect Modules

- The data logger will shut off all outputs and initiate an evaluation of each slot to see if any modules are present.

Note:

In the graphic above, if a module were inserted in slot 3, clicking detect modules will turn the power on for the slot and report back with the module part number installed.

Finish





- Will cause the data logger to restart and take the user to the Function Block Diagram.

Note:

There are some FM slot dependencies. If there is a question as to whether or not an FM is in an acceptable slot, refer to the Installation and Troubleshooting Guide for the data logger in use.

Symbols Related to Pluggable Modules

As viewed from the Menu bar, the symbol that will be displayed to the left of the Pluggable Modules button will be of the most significance. The red exclamation will always take precedence.

Symbol	Description
	The expected module has been detected.
	No module has been detected in a slot the data logger expects to be empty.
	A module has been detected in a slot the data logger expects to be empty.
	The data logger expects a module, but that module is missing or a different module has been detected.

Configuring Flex Modules

To accept the detected modules:

Note:

If modules were plugged in after powering up or resetting the data logger, click on the **Detect Modules** button to restart the data logger and detect all of the modules that are present.

1. On the right side of the screen click the **Use Detected Part Number** button.
2. Repeat step 1 for each slot to be configured.
3. Click the **Finish** button to restart the data logger and exit to the Function Block Editor.

Note:

Exiting the pluggable modules screen after any changes are made will cause the data logger to restart. A restart will stop all data logger activities while turning off all outputs.

Entering Flex Module Information Prior to Installation

Function blocks associated with hardware will not be available until the hardware is expected to be present. Entering a part number for any slot (even though the module is not currently installed) allows the programmer access to the associated function blocks. As an example, if an FMMA-UEKA-AAAA is installed in slot one, the function blocks that would be available are shown in the red box. After entering a part number such as FMLA-YEBA-AAAA in slot 2, additional hardware dependent function blocks will appear as shown in the blue box.

Note:

When configuring modules as described above (not installed), all outputs will be off.

To configure the data logger to expect a module that is not yet installed:

1. Select the desired slot and enter a valid part number in the **Expected Part Number** field.
2. On the keyboard, push the **Enter** key.
3. Click **Finish** when complete to restart the data logger. After the restart process is complete the **Function Block Diagram** will appear.

Once the module is acquired, simply plug it into its assigned slot and click the **Detect Modules** button. After doing so, the data logger will restart and a green flag 🟢 will be displayed for that slot number.

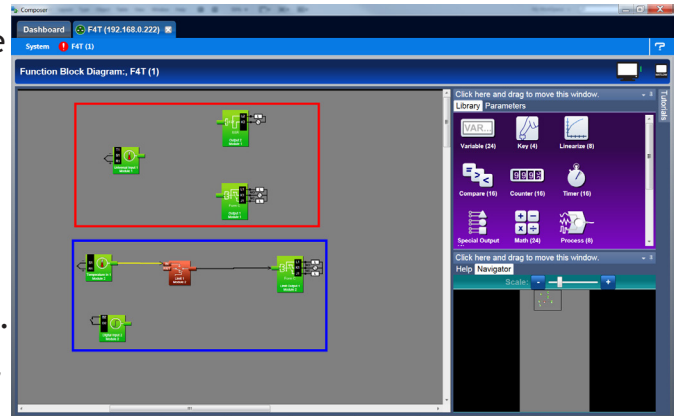

Configuring the Application using the Function Block Diagram

The Function Block Diagram (FBD) view is used to connect the real-world inputs and outputs to internal data logger functions.

To enter the Function Block Diagram:

1. Click on the desired Device menu.
2. From the drop down menu click **Function Block Diagram**.

Topics discussed in this section follow:

Screen Orientation: detailed description of the FBD screen and associated characteristics.

Customizing the FBD Environment: change default canvas settings to user preference.

Window Anchor Points: defines a new docking location.

Getting Started: things a user will encounter on the canvas while building the application.

Selecting and Placing FBs on the Canvas: describes where to find and then place selected FBs on the canvas.

Moving FBs on the Canvas: describes how to move selected FBs on the canvas.

Connecting FBs Together: describes how to make the application come to life by interconnecting FBs.

Viewing Signal Values and Errors: describes how to view signal values and errors as they occur.

Troubleshooting Signal Errors: suggestions in how to evaluate a signal error.

Adjusting FB Behavior with Parameter Settings: change the functionality of a FB based on its parameter settings.

Finding Help for FBs: describes how to acquire embedded help for each FB.

Changing and Deleting Signals: making modifications to the program through new and revised FB connections.

Removing FBs from the Canvas: describes how to delete FBs on the canvas.

Using Auto Hide: maximize visibility of available screen space by hiding infrequently used windows.

Floating a Window: move a window from its docked location to a user defined location.

Docking a Window: describes how to create new or return to previous docking locations.

Turning Floating Windows Off and On: describes how to enable and disable floating screens.

Function Block Diagram View - Screen Orientation

The FBD View has the following features, numbered correspondingly in the graphic below.

Function Block Diagram

- All FBs are placed and connected on the canvas.



Function Block Library

- Shows the available FBs for this data logger. The number below each icon indicates how many FBs of that type remain available for use with this data logger. As is displayed in this graphic, this window is movable and dockable.

Parameter List

- Used to view and set the FBs parameters customizing its behavior for the application. This window is movable and dockable.

Navigator

- Allows the user to adjust the view of the canvas. Drag the box to reposition the view.
- Use the slide bar or the min+us  and plus  buttons to adjust the zoom level. This window is movable and dockable.

Help

- To view detailed FB information click on any FB. This window is movable and dockable.

Tutorials

- Topic based video help files.

Function Blocks (FBs)

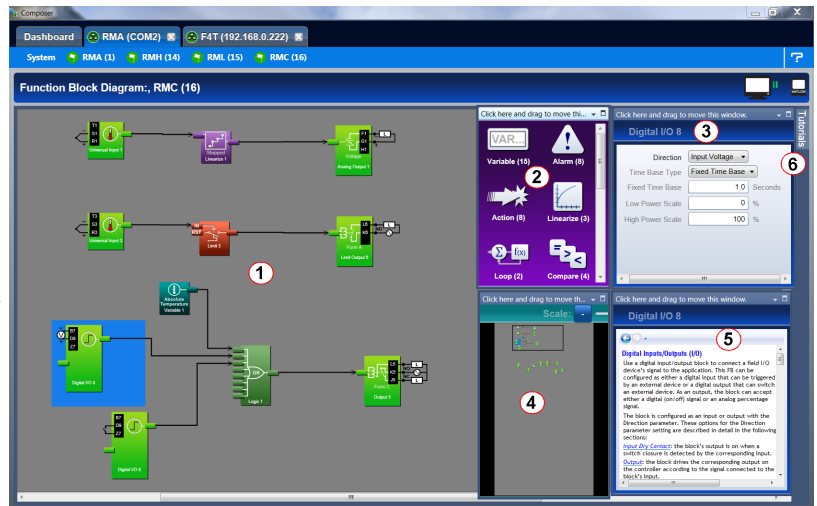

- Allows the user to customize the functionality of the data logger for a specific application. Some FBs are interfaces to real-world I/O devices and some serve as the interface to internal functions such as, the compare, logic and math FBs.

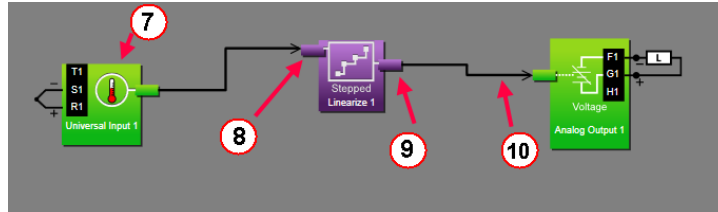

Receiver

- The part of a FB to which a signal can be connected in order to supply data to the function.

Transmitter

- The part of a FB from which a signal can be connected in order to carry data to another FB.

Signal

- A line that represents the connection of data from one FB to another.

Customizing the Function Block Diagram Environment

The Parameter, Help, Library and Navigator windows can be moved from their default locations to allow a user to maximize the visibility of the FBD diagram. See the procedures below regarding how to float, hide and dock these windows.

Window Anchor Points

While dragging a window or a grouping of windows to a new docking location Anchor Points will appear on the screen. The anchor points in the graphic are numbered corresponding to their associated descriptions below:

- g Drag the window here to add to the window group.
- h Drag window here to dock above the window group.
- e Drag window here to dock to the right of the window group.
- r Drag window here to dock at the right of the screen.

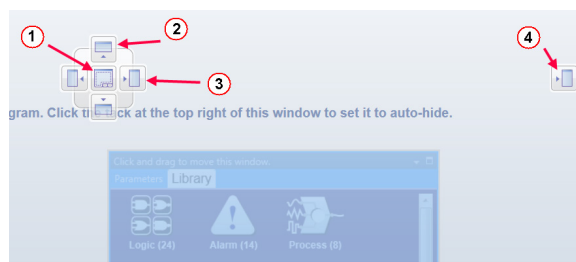
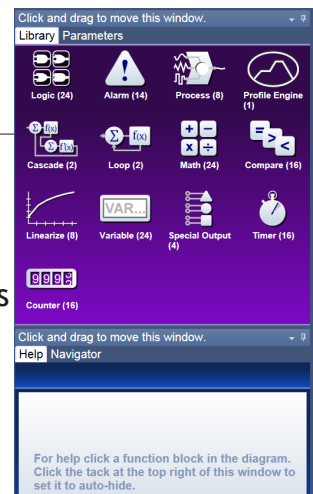

Getting Started with the Function Block Diagram (FBD)

The basic steps for creating the function block diagram for any application are:

1. Add the function blocks from the library to the canvas that are needed to interpret the signals from the physical inputs and set the physical outputs. Typically, these will include Alarm function blocks.
2. Connect the transmitters on the FBs that source data to the receivers on the FBs that need the data.
3. Set each function block's parameters as needed for the application to perform as expected.

Detailed descriptions of each function block including all the function block's parameters can be accessed in the online help for the function block and in the User's Guide, chapter entitled Function Block Reference.

The FBs that represent the physical inputs and outputs from the data logger and are associated with the flex modules that are expected in the configuration are always on the canvas. These FBs can only be removed by changing which modules are expected using the Pluggable Modules view.

Other FBs can be added to the canvas from the library. See the Application Examples chapter in this User's Guide for more on these functions. Other function blocks such as Math and Logic perform fundamental functions that can be combined to add custom behaviors to the data logger for specific applications.

The signals that carry data between function blocks normally appear as black lines in the diagram, but when the block that transmits the signal cannot determine what the correct value should be, the signal changes to yellow indicating the error. Each FB's response to errors received is explained in the description of the function block.

Warning:

Once an output FB receiver is connected to another block, the output on the flex module turns on according to the received signal. Do not connect outputs until it is safe to do so.

Notable facts about the FBD:

- How a FB responds to its inputs and drives its output is dependent on its parameter settings. Set the parameters for each function block as needed for the application.
- Signals cannot be moved after they are created; to change where a signal gets data or where it delivers it, delete the signal and create the desired connection.
- There are several ways to do many things. Try right-clicking to see options or short cuts.
- FBs from the library that have no signals connected are returned to the library when Composer® is closed.
- The location of dockable windows is not saved; windows return to their default locations when the system is closed.
- The selection of signal values displayed in the diagram is not saved; all signal value displays are turned off when the system is closed.

Hints:

- Click-and-drag any blank spot on the canvas to change the view.
- Use the scroll bars.

- Use the Navigator to reposition the view of the canvas and to zoom in or out.
- Use the mouse wheel to scroll the view. Hold the shift key to use the mouse wheel to pan. Hold the Control key to use the mouse wheel to zoom.

Selecting and Placing Function Blocks on the Canvas

To place a FB on the Canvas:

1. Find the desired FB within the library (using scroll bars if present).
2. Click-and-drag the FB to the canvas.

Moving Function Blocks

To move a FB on the Canvas:

- Click-and-drag the FB to the desired location on the canvas.

Hints:

- Click the main body of the FB not one of its transmitters or receivers. Clicking a transmitter or receiver begins to draw a signal rather than move the FB.
- The canvas will scroll if the mouse pointer is close to the edge but not outside the diagram window.
- To make a long move, click the block to select it, then zoom out to make it easier to move the block to the desired location.

Connecting Function Blocks Together

To connect a transmitter to a receiver:

- Click and drag a signal from a FB's transmitter to a receiver on another FB.

Hint:

- This can also be accomplished in reverse, i.e., click and drag from a receiver to a transmitter.

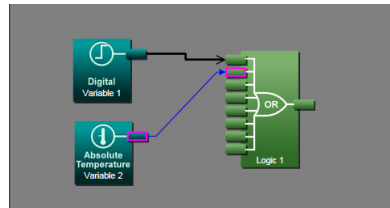

Viewing Signal Values and Errors

To momentarily display a signal's value:

- Mouse over (point the mouse cursor at) the signal.

To display a signal's value continuously:

1. Right-click the signal.
2. Click **Show/Hide Data**

To cancel (turn off) the signal display:

1. Right-click the signal.

2. Click Show/Hide Data

Note:

The values displayed are not in real-time.

Troubleshooting Signal Errors

While building the FB diagram, or during operation, there may be occasions when the signal from the transmitter of a FB is displayed yellow. This may reflect that the FB has encountered an error or some other anomaly has occurred. From the user perspective, an evaluation of the cause should be done to ensure that unexpected operation does not occur. Suggested steps to evaluate the cause of a yellow link are listed below:

To evaluate the cause of a yellow signal:

1. Trace the yellow signal back to the source (first occurrence of a yellow link) FB.
2. Place the mouse over the signal which will display the error.
3. In this particular example, the error is identified as an Open sensor.
4. Click on the selected FB and view the Help window.
5. Search ("Ctrl-F") the help file for the word "Open".
6. Once found, evaluate, make note or correct the cause of the problem.

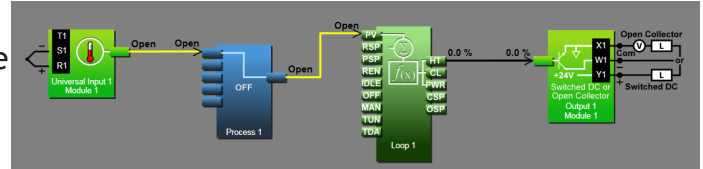

If further assistance is needed review the associated product User's Guides or contact the Watlow Technical Support team (1-800-492-8569 or 1-507-494-5656).

Adjusting Function Block Behavior with Parameter Settings

To change a FB parameter:

1. Double-click on the FB.
2. In the Parameters window locate and change the parameter.

Note:

If names are applied here, those names will appear on the FBD and if selected, the output view of the Personalization screen.

Select the content for each position on the output view:

1:	Heat	2:	Cool Output
3:	Profile Disable	4:	Manual On/Off

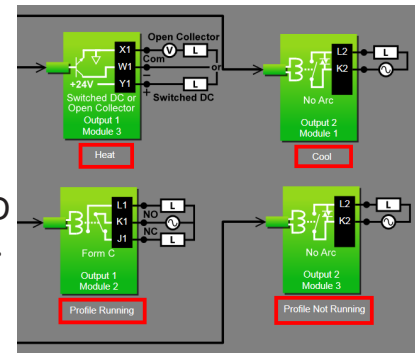

Finding Help for Function Blocks

To locate the help topic for a FB on the Canvas:

- Click the FB and view the help window.

Hints:

- Many function blocks can be configured to perform one of several functions. For these

FBs, the help topic has a section for each function. Locate and click the link for the desired function.

Changing and Deleting Signals

To delete a signal:

1. Click the signal to select it.
2. Press the **Delete** key on the keyboard.

Note:

To change where a signal connects, first delete it then make the desired connection.

Removing Function Blocks from the Canvas

To remove a FB from the Canvas:

1. Delete all signals connected to the FB.
 2. Click the FB to select it.
 3. Press the **Delete** key on the keyboard.
-

Using Auto Hide

To toggle the auto hide option for a window or a group of windows:

- Click the pin (auto hide) icon in the window's title bar.

To use a window that is hidden:

- Mouse over (point the mouse cursor at) the window name.

Floating Windows

To float a window or a group of windows:

- Click-and-drag the window's title bar to the desired location.

To separate a window from a group:

- Click-and-drag the window name to the desired location.
-

Docking Windows

To return a floating window or a group of windows to its previous docking location:

- Double-click the title bar.

To change where a window or a group of windows is docked:

1. Click-and-drag the window's title bar until the anchor points appear
2. Drag the window until the mouse pointer is at the desired anchor point.
3. Release the mouse.

Hint:

- Some anchor points dock the window at the sides of the FBD view and others dock or group the window with other windows.
-

Turn Floating Windows Off or On

To avoid the possibility of inadvertent window movement, this feature can be turned off.

To turn floating windows off:

- Right-click anywhere on the canvas and choose **Turn off float** in the pop-up menu.

To turn floating windows on:

- Right-click anywhere on the canvas and choose **Turn on float** in the pop-up menu.

Personalizing the User Interface (UI) Using Composer®

The home screen of the D4T data logger can be personalized to show multiple pages and multiple content blocks within each (4 maximum). Until personalized, the home screen will be blank. Features that are available on the Personalization screen are numbered corresponding to their associated descriptions below:

Home screen can be modified in accordance with installed hardware and named FBs on the FBD.

Modify user interface (UI) button colors.

e Create a customized menu to be viewed on the UI.

r Change the user interface screen brightness.

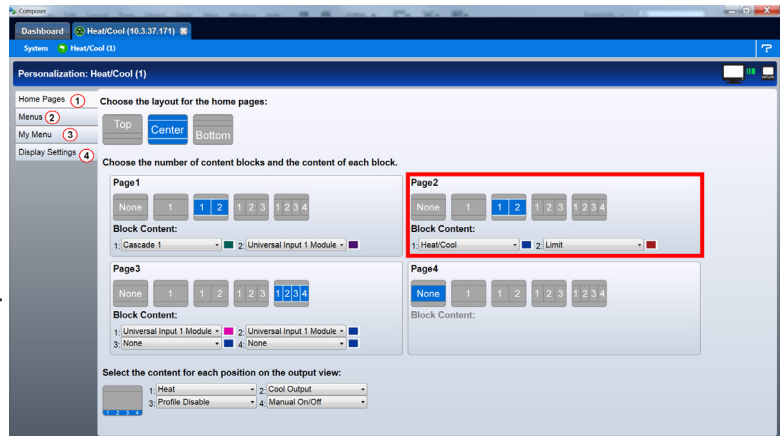

To personalize the home screen:

- From the device menu choose **Personalization** from the drop down menu.

Much, if not all of what is displayed on the home pages comes from the FBD. Therefore, it would make sense to first configure the FBD prior to personalizing the home screen.

The personalization settings shown above would produce a home page like the one below. Because it was the second page configured as shown above (red box), notice the arrow buttons on the right and left of screen capture below allowing navigation to page 1 and 3.

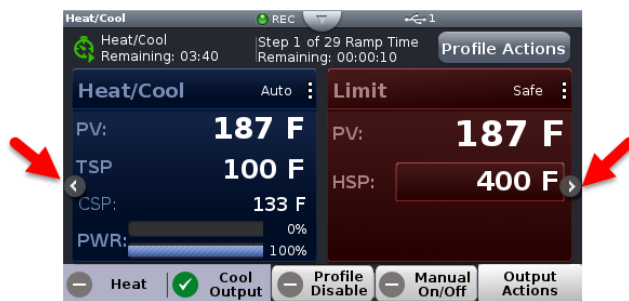

Setting Up Data Log Files Using Composer®

Data Logging can be enabled at any time and will log a user selectable list of data points. While data logging is enabled, the data log file is stored within either the USB device memory or internal memory. Once the file reaches a specified size (if being transferred automatically), it will be sent directly to one of three other destinations (USB, TFTP server or a Samba server). The file transfer can also be initiated manually at any time. The file transfer process from

internal memory, whether completed automatically or manually, will move all log files from internal memory to the selected destination. To learn more about data logging see "[Data Logging](#)" in the Overview Section of this User Guide.

Note:

Data logging can also be enabled/configured through Modbus. There are specific Modbus registers for each of the parameters defined below. If interested in identifying those registers, see the section entitled "[Enabling Data Logging Using Modbus](#)" in the Appendix of this User's Guide.

Topics discussed in this section follow:

[Setup Data Logging](#): discusses required fields that must be set prior to starting data logging.

[Configuring a Samba Shared Folder](#): identifies and gives illustrations in defining the necessary user account and the shared folder.

[Configuring a TFTP Server](#): details required setup fields while illustrating steps to successfully move files from the D4T to the TFTP destination.

Note:

Data logging is terminated when power is lost while the data log file itself will be maintained where it was captured.

Setup Data Logging

To setup data logging, follow the steps below:

1. Click on the **Device Menu** tab.
2. From the drop down menu click on **Data Logging**.
3. Select and add all of the desired **Data Points** for the data log file.

Note:

Selected data points will be used whenever data logging is enabled.

4. Click on the **Setup** button.
 - Logging Status: indicates whether or not recording is active or not.
 - File Name: any alphanumeric characters, 63 maximum.

Note:

When transferring files via TFTP, do not create a file on the server called "testfile". Communications between the D4T and the TFTP server is tested prior to starting a transfer using this filename while then verifying the response from the server.

- Log To: USB or Internal Memory.

Note:

When transferring files via TFTP or Samba, internal memory must be selected here.

Note:

There are many USB memory devices available. Watlow does not recommend using micro SD or SD card to USB adapters in the USB slots. Be aware that we have not tested all of the variations of USB memory devices but we have tested and validated those that are listed below:

- Lexar, Kingston, Toshiba and Verbatim

Note:

Supported USB file systems: FAT16 and FAT32.

Note:

Due to wear-leveling operations of flash memory devices (internal - D4T and external - USB), there may be some gaps within the data logged file.

Note:

If logged file is sent to USB, the *.csv and the *.enc file are written directly to USB constantly. If the File Size Limit is set to 10MB or larger, the csv will continue to be written continuously while the encrypted portion (*.enc) is chunked into 7.5MB files, buffered internally and then written out as 7.5MB chunks. If the maximum file size is set to 10MB, there will be two *.enc files for each csv (7.5MB and 2.5MB). If File Size Limit is set to 15MB, there would be two 7.5MB *.enc files for each *.csv file.

- Log Interval: defines the frequency in which the log will be written, 0.1 second to 60 minutes.
- File Type: Encrypted (filename.enc), comma separated values (filename.csv) or Both.
- File Size Limit: 20MB maximum when using internal memory, 1GB when using USB.
- Memory Full Action: when selected log to device is full, Overwrite or Stop.

Note:

Logging to USB allows for Stop only, when memory is full.

- Date Format: MM/DD/YYYY or DD/MM/YYYY.

Note:

Applies to each individual log entry alone, does not apply to filename.

- Time Format: 12 or 24 hour clock.

Note:

Applies to each individual log entry alone, does not apply to filename.

5. Click on the File Transfer button.

- Auto Transfer Type: None, TFTP, Samba or USB.

Note:

When automatic file transfer is enabled, the file as it's being created, will be buffered in internal memory. The file will be moved to its destination when it either reaches the maximum file size setting or the user stops data logging. If automatic transfer fails for any reason, data logging will continue and the files will be stored in internal memory until internal memory fills up. The setting for Memory Full Action (Overwrite or Stop) will then be implemented.

Note:

A user can initiate a file transfer manually at any time if one or more of the available destinations (USB, TFTP or Samba) have been configured.

- Samba User Name: Windows user account name with access to shared directory.

Note:

If using Asian fonts, you may need to create a Latin character set login for use with Samba transfers.

- Samba Password: Windows user account password.

Note:

If using Asian fonts, you may need to create a user, and password, using the Latin character set.

- Samba Path: shared directory path and name.

Note:

If using Asian fonts in the path name, please try using latin characters, or numbers as your folder name, and share name.

- Remote IP Address: the IP address of the remote computer.
- Remote Host Name: the name of the remote computer.
- Transfer Progress: when a transfer is initiated this will reflect its progress from 0% to 100%.

Note:

If an error were to occur, as described below, this value could exceed 100.

- Transfer Results, will return the enumerated values shown below:

Enumerated Value	Description	Possible Causes	Corrective Action
Blank	Nothing to report	<ul style="list-style-type: none"> • Not configured, no activity. • Transfer not initiated. 	- - - -
No Files to Transfer	No data log files in internal memory	<ul style="list-style-type: none"> • Data logging has not yet been started. • Files have already been moved from internal memory. 	- - - -
Transfer Complete	All data log files have been moved from internal memory	<ul style="list-style-type: none"> • File transfer initiated and completed successfully. 	- - - -
Transferring Files	Data log files being moved from internal memory	<ul style="list-style-type: none"> • File transfer initiated and in progress. 	- - - -
Server Down	Connectivity from client to server not present	<ul style="list-style-type: none"> • Server not present. • Server not configured or configured incorrectly. 	<p>Samba</p> <ul style="list-style-type: none"> • Check and ensure user account info (name and password) is correct. • Check and ensure that the shared folder name is correct and shared with the user account mentioned above. <p>TFTP</p> <ul style="list-style-type: none"> • Ensure server is running and configured for read/write capability.
Need Host IP	IP address not present	<ul style="list-style-type: none"> • No connectivity between PC and D4T. • Incorrect IP address entered. 	<p>TFTP</p> <ul style="list-style-type: none"> • Verify a physical connection between PC and D4T. • Check the data logger IP address from the D4T front panel: push Main Menu > Settings > Network > Ethernet. • Ping the D4T to verify its presence on the network.

Enumerated Value	Description	Possible Causes	Corrective Action
Need Host Name and IP	Missing host name or IP address	<ul style="list-style-type: none"> • Not configured. • Incorrect IP address or host name entered. 	Samba <ul style="list-style-type: none"> • Ensure the computer name (Host) is correct. Click on the Windows Start button and type my computer in the search field. • Verify IP address (see: Need IP Address above).
Error	File transfer did not occur successfully	<ul style="list-style-type: none"> • TFTP server configuration not correct. 	TFTP <ul style="list-style-type: none"> • Server not configured with overwrite capability, reconfigure server. • Ensure server is not set for read only.
Check Directory Permissions, Host Name and IP Address		<ul style="list-style-type: none"> • Not configured. • Incorrect IP address or host name entered. • Shared folder does not have correct permissions. 	Samba <ul style="list-style-type: none"> • Ensure the shared folder name exists and that it is being shared with the user account (Samba User Name). • Verify IP address (see: Need IP Address above). • See the section entitled Configuring a Samba Shared Folder below.

Configuring a Samba Shared Folder

Samba, also known as Server Message Block (SMB)/Common Internet File System (CIFS), is fully supported by Windows File Sharing. Within this document, SMB/CIFS will be referred to as Samba.

Samba, when in use, creates a directory on the D4T device that maps to a shared directory on the user's PC. There are several ways that a Windows shared drive can be configured. With this in mind, one of those ways will be discussed and used for demonstration purposes below.

Note:

If a user account already exists with full Administrator rights, steps 1 through 12 can be skipped.

Setting up a Windows shared drive:

1. Click the Windows **Start** button and type user accounts in the search box.
2. When the Make changes to your user account window opens, click on **Manage User Accounts**.
3. When the User Accounts window opens, click on the **Advance** tab.
4. Under Advance user management, click on the **Advance** button.
5. Under the Name column right-click on **Users** and then **New User**.
6. In this example the new user will be identified as "Samba" and will be entered into the User name field as shown to the right.

Note:

To ensure that there will be no changes required regarding the password, check Password never expires.

7. Click on **Create** and then **Close**.
8. Click on the X (top right corner) to close the users window.
9. If not already open, navigate to Manage user accounts and click on it. Once there, the new user account should be visible as shown to the right.
10. Click the **OK** button.
11. Click on the X (top right corner) to close the User Account window.
12. Navigate to Windows Explorer and create a new folder.

Note:

The name of the shared folder must not contain any slashes, or back-slashes.

Note:

If the folder being created is a sub-folder off of the root directory, right click on the created folder > select **Properties > Sharing > Advanced Sharing** and check **Share this folder**. Doing this will allow the sub-folder path to be defined as if it were in the root directory of the selected domain. Lastly, click on **Permissions** and ensure that all boxes under Allow are checked as shown below.

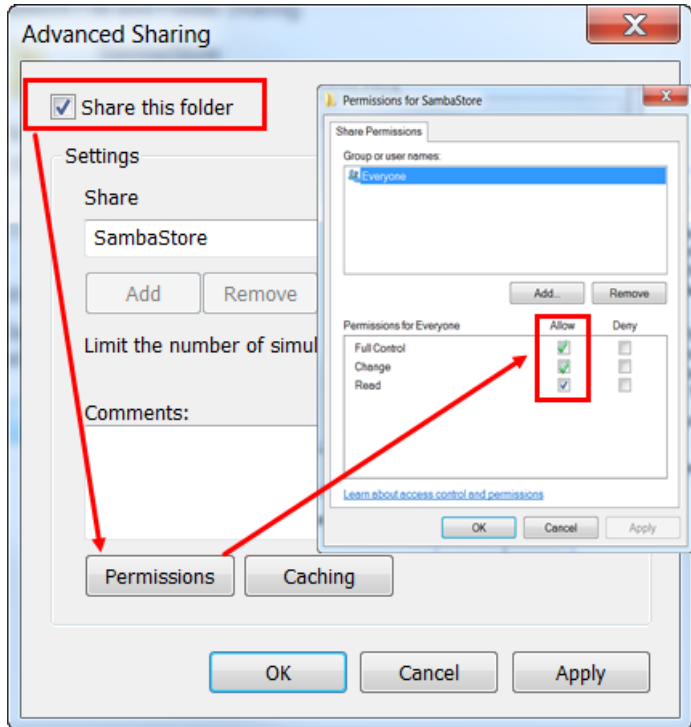
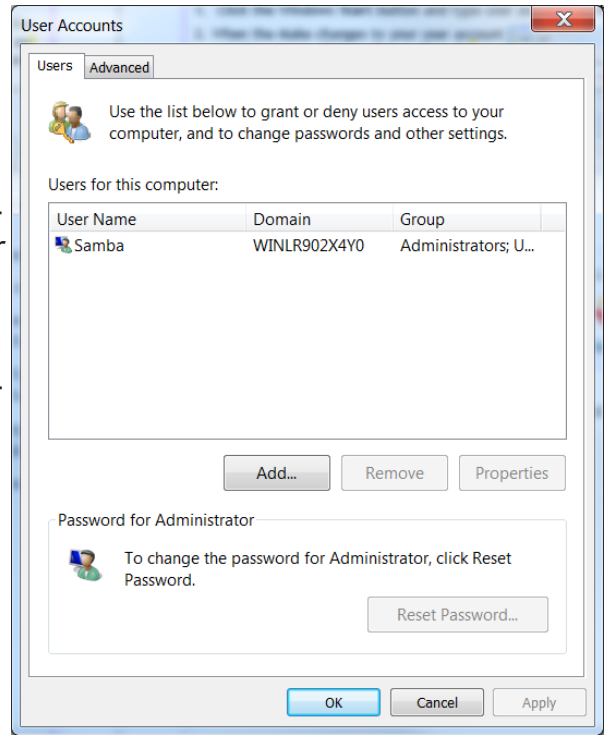

13. Right-click on the folder created above and then mouse over Share with and click on **Specific People**.
14. Click on the drop down button and then **Find people**.
15. Enter the object name "Samba" and then click on the **Check Names** button.

16. Click the **OK** button.

17. Click on the drop down button and ensure the folder is set for Read/Write capabilities as shown below.

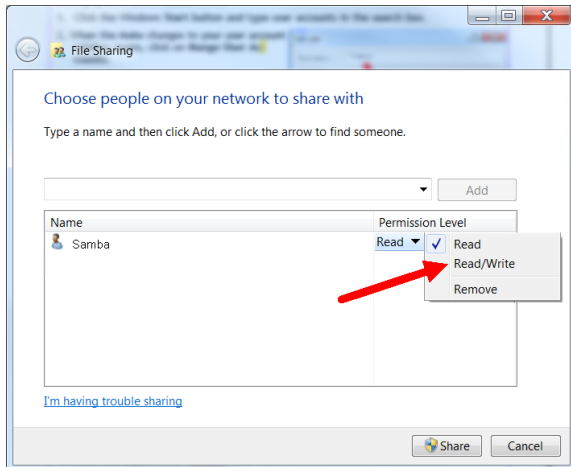

18. Click **Share**.

The graphic below shows the folder as being shared.

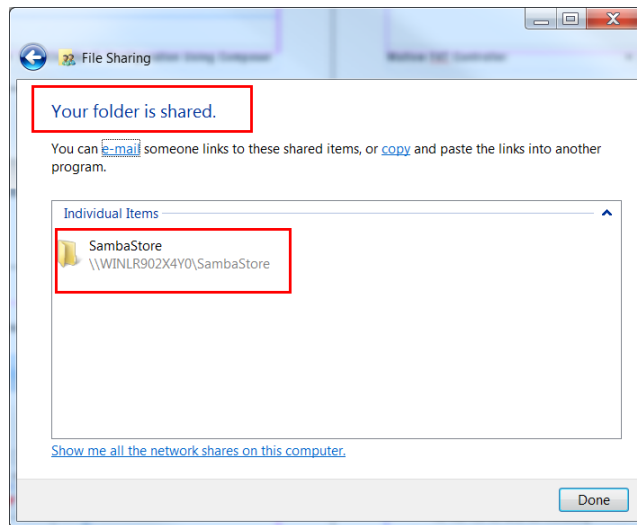

After the user account has been identified or created and the shared folder has been setup it is time to configure the File Transfer function within the data logger. The graphics below show all fields that must be filled in to do an automatic transfer of the data logged file to the shared folder identified in this example as SambaStore.

Note:

Transferring files via Samba may be accomplished by 2 methods; Auto-transfer, and a user initiated transfer. Once the automatic transfer is enabled this function will move the file to the remote computers shared folder whenever data logging is running and the set file size has been reached. The graphics that follow illustrate automatic transfer.

First, a couple of fields (parameters) within Setup must be addressed, identified in the red boxes below.

Log to - must be set to internal memory to automatically move the files to the shared folder.

File Size Limit - defines the maximum file size that will be moved to the shared drive.

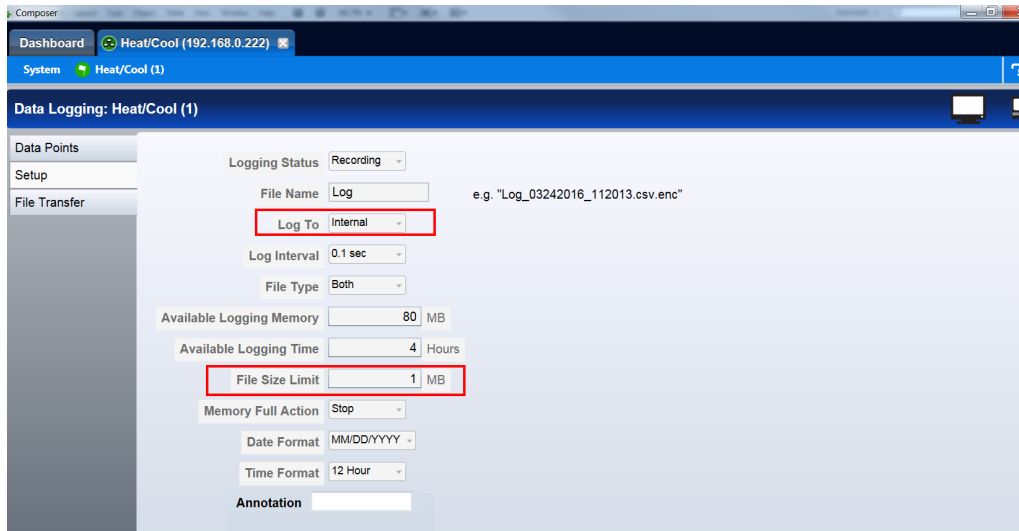

Second, based on the example entries made above, the File Transfer fields need to be filled in accordingly.

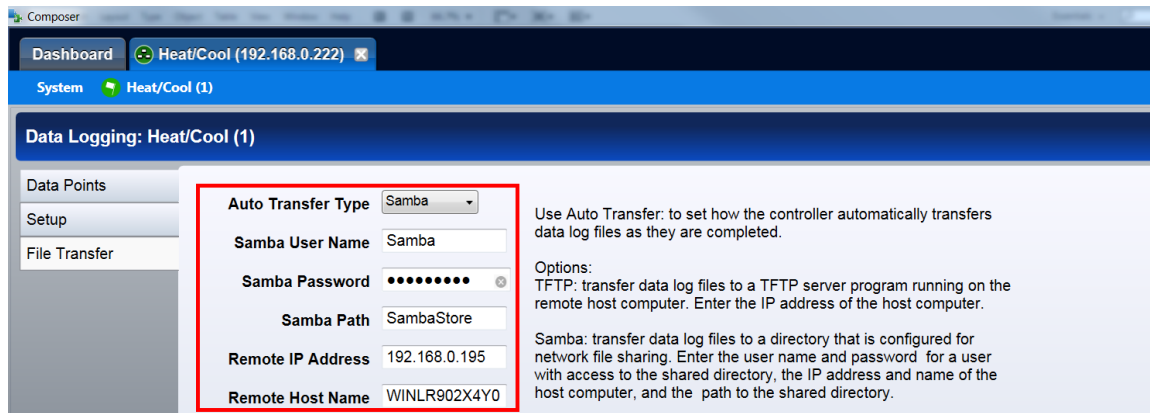

After these screens have been populated as shown, data logged files, once they reach approximately 1MB in size, will be moved from internal memory to the shared folder (SambaStore).

Configuring a Trivial File Transfer Protocol (TFTP) Server

In order to use the TFTP file transfer option, a TFTP server must be setup and running on your computer to service the TFTP transfers from the D4T. The user will need to specify the IP address of the remote computer, and also the remote computer name.

TFTP requires no authentication and can transfer a file as large as 20MB to a remote host computer. There are many TFTP servers available and many can be downloaded off the internet free of charge. To enable a TFTP transfer, within Composer or via the UI, simply enter the IP address for the remote computer and ensure the TFTP server is running on the remote computer.

Configuring the TFTP Transfer:

1. Because there are several TFTP servers available note that naming may be different. What is most important from the server standpoint is that the appropriate IP bindings are set while the security allows for read/write capability as shown below.

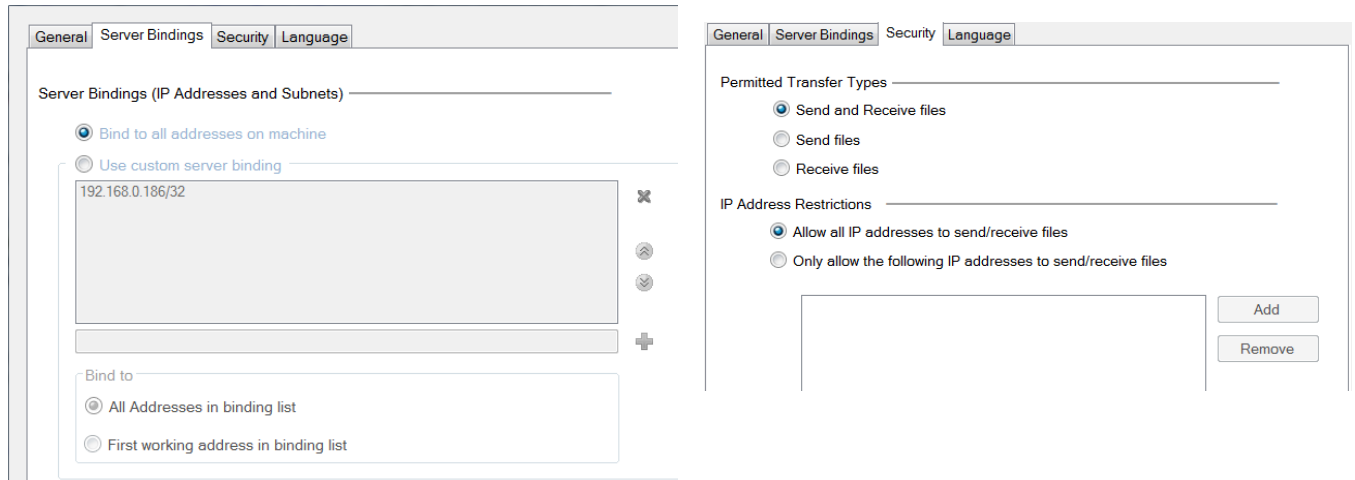

2. Navigate back to the section entitled [Setup Data Logging](#) and follow the procedure to define what it is to be captured within the file. Within this same procedure (step 5), it will be important to define the IP address of the remote computer while also determining whether the file will be transferred manually or automatically.
3. Start the TFTP server and then start data logging by pushing the following buttons on the D4T front panel: **Main Menu > Data Logging > Start**

If the file does not seem to be transferring as expected check out the parameter identified above as [Transfer Results](#) and the table that follows it for some assistance.

3

Chapter 3: Using the D4T Front Panel

Navigating and Understanding the User Interface (UI)

This chapter is designed to give the user a better understanding of the structure and navigation of the D4T menus as viewed from the front panel.

Front Panel Navigational Buttons

When looking at the front panel of the D4T, at the bottom of the display, four push buttons are displayed as icons shown below. The text in this graphic was placed there for clarity only and is not present on the front panel.



- *Home*: regardless of the screen currently in view, when pushed, will always return to the Home screen which displays the following:
 - Loop name: user designated (Chamber Temp, as shown above).
 - Control mode: (Auto, as shown above).
 - Process Value: input connected to the PV receiver of the loop function block.
 - Set Point: which represents the desired value to be maintained by the controller.
 - PWR: output power levels for heat and cool if both are configured.
 - Output Actions: allows a user to monitor the on/off status of user defined inputs or outputs.
- *Menu*: as shown below, will provide access to other settings and functions within the controller.















- *Return*: when pushed, this button will take the user back to the previous screen until the top level of either the home screen or the main menu are reached.
- *Help*: displays information about the controller such as: part number, software revision etc...

Note:

Depending on ordered options and configured features the Menu screen may have other buttons that are not visible. The red arrow above shows a scroll bar that will appear when this is the case. Swipe the screen upwards to view more.

Understanding D4T Menus

The following section illustrates the structure of the D4T menus at a high level. Press the Main Menu button below the display screen to access the menu buttons available.

Menu Item	Item Options	Menu Item	Item Options
 My Menu	User-selected parameters	 Email and Text	Email Server Settings Contacts Alert Settings Send Test Message
 Operations	Control PID loops Events Inputs/Outputs Alarms Machine Controls	 Login	Location depends on security settings and installed hardware
 Settings	Settings for all Menu Items	 Logout	Location depends on security settings and installed hardware
 Data Logging	Start Annotation - Logged Data Points Select Data Points - Setup - Data Log File Transfer	 Service	Calibration
 Trending	Actions	 Personalize	Home screen and menu personalization
 Batch	Batch Entry Batch Settings Batch File Transfer	 Help	About - Pluggable Modules - Installed Features Screenshot Enable/Disable
 File Transfer	Import/Export Samba TFTP		

Multiple Languages

The D4T Data Logger can be configured to display the following languages on the screens: English, German, French, Italian, Spanish, Japanese, Korean and Chinese.

How to set the desired language:

Press the Menu button below the Main screen to access the Main Menu screen.



Press the Settings button on the Main Menu to access the Settings screen. Press the Global button to access the screen to make changes to the Global settings.

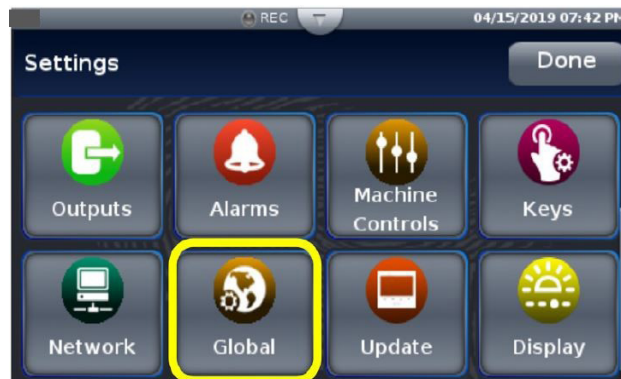

Select the desired language on the Global settings screen and then press the Done button to return to the Main Menu.



Event Driven Menus

During normal operation it is possible that an event can occur that will present the user with indications, pop-up windows and menu selections that are not shown above. As an example, if an alarm occurs the status bar (top of screen shot shown below) will indicate its existence by blinking yellow. If the user pushes the status bar down button to view the alarm message, and then pushes the alarm tab, menu options may appear (silence or clear) depending on the alarm settings. A representative alarm display is shown below.

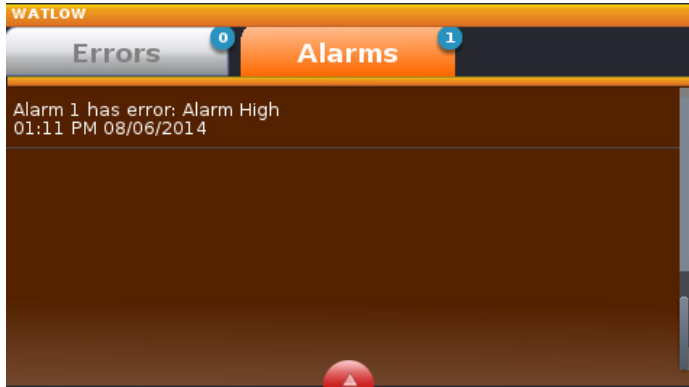

As another example, if an input sensor opens, an error message will be displayed on the screen requiring user intervention. Once the error is acknowledged (Dismiss), the status bar will continue to blink red until the open sensor has been fixed. Once fixed, the status bar will return to its normal operational display as shown below.

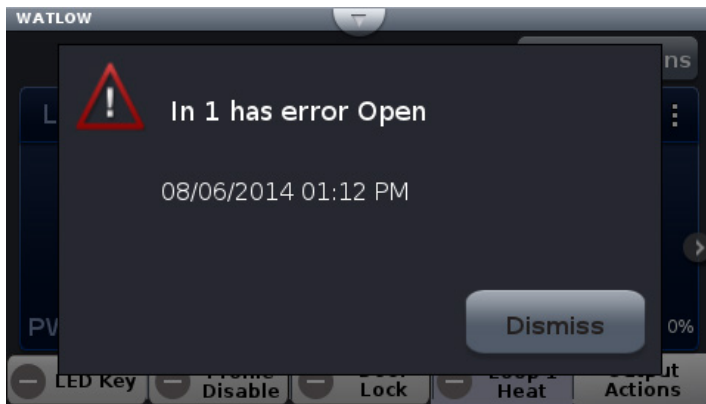

Navigation Keys and Displays

After initially powering up the data logger a white initialization screen will appear first. Once the startup process is complete the splash screen (shown below) will appear.

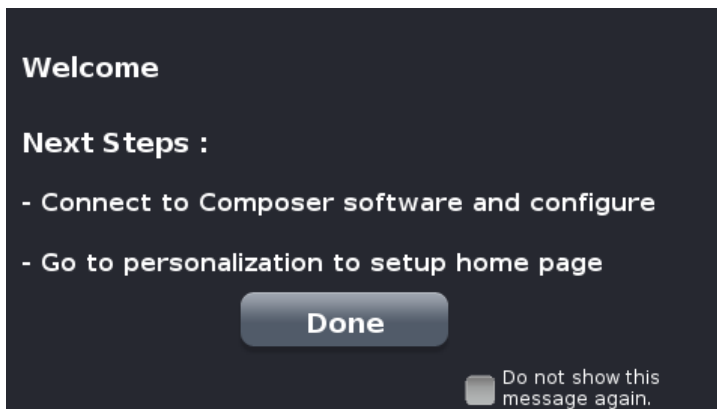

As described in the splash screen above...

After first time power-up, do the following:

1. Configure the data logger using Composer software (see: [Configuring Pluggable Flex Modules](#))
2. Using the **Menu** button setup the Home screen (see: [Personalizing the Home Screen](#)).
3. If the above steps have already been completed simply push the **Done** button to go to the home screen.

The screen above will appear each time the data logger power is cycled. If it is desired that the splash screen no longer appear, check the box "Don't show this again" (shown in red box for emphasis only).

Home Screen Described

The screen shot below shows a configured Home screen to include two content blocks (loops) and two or more pages (notice next page indicators). Any given page can have up to four content blocks configured.

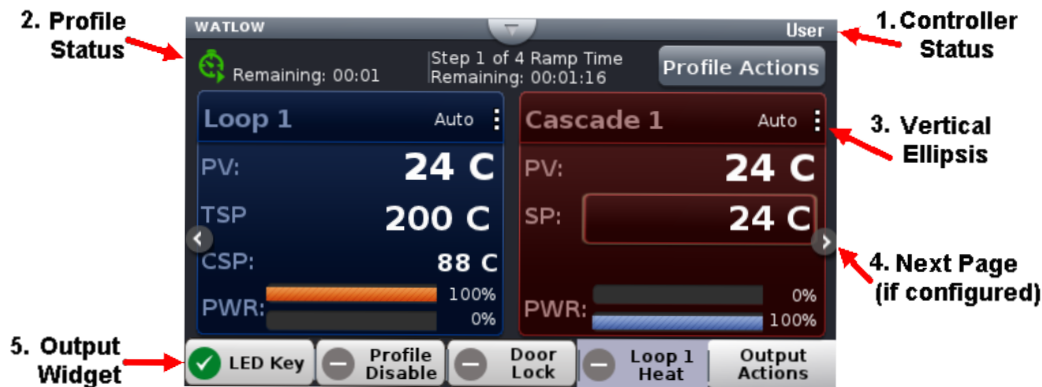

1. *Data logger Status*: indicates alarms and errors if they occur while also showing the current security level if enabled (see: [Security](#)) and the name (upper left corner) given by the user (see: [Device Details](#)). The button shown in the center of the status bar allows a user to view alarm and error messages when pushed.
2. *Vertical Ellipsis*: displays current control mode while also providing access to other operational parameters such as the Closed Loop Set Point, Autotune, PID settings, etc...(see: [Control Mode](#)).
3. *Next Page*: if the data logger has more than one page and the Home screen has been set-up (Push **Menu** button to Personalization) to display multiple pages, the left and right arrows on each side of the home screen provides navigation from one to the other.
4. *Output Widget Bar*: user configurable events, function keys or output status (on/off). This can be relocated on the screen (see: [Personalizing the Home Screen](#)).

Configuring Ethernet Communications

To change Ethernet parameters:

1. Push the **Menu**, **Settings** and **Network** buttons, in that order.
2. Push **Ethernet**.
3. Change desired settings.

For Ethernet connectivity options and step-by-step instructions on connecting the D4T into an Ethernet network, see chapter 3 of the D4T Installation and Troubleshooting User's Guide.

Default Ethernet Parameters and Settings

The bracketed bold settings below represent the defaults as delivered from the factory:

- IP Address Mode: [**DHCP**], Fixed
 - DHCP: Dynamic Host Configuration Protocol, allows for dynamic distribution of network settings by a DHCP server.
 - Fixed: also referred to as a static IP address, is configured manually for a specified network.
- Actual IP Address: [**192.168.0.222**]
- Actual IP Subnet: [**255.255.255.0**]
 - Subnet: a method used to logically divide and isolate networks.

Note:

The Actual IP Address and Actual IP Subnet addresses shown above will be the default addresses if IP Address Mode is set for Fixed.

- Actual IP Gateway: [**0.0.0.0**]
 - Gateway: is a device used on the network to route messages with IP addresses that do not exist on the local network.
- MAC Address: xx:xx:xx:xx:xx:xx (Will be different and unique for each data logger)
 - MAC address: is a manufacturer supplied address for the network interface card.
- Display Units: [**°F**] (Fahrenheit), °C (Celsius)
- Modbus® TCP Enable: [**Yes**], No
 - Modbus is an industrially hardened field bus protocol used for communications from the data logger to other devices on the network; only one connection via Modbus is allowed.
- Modbus Word Order: [**High**], Low
 - Modbus allows a user to select the word order of two 16-bit words in floating point values.
- Data Map: [**1**], 2
 - Data Map, the user can switch Modbus registers from the comprehensive listing of D4T registers to a limited set of the legacy F4 controller registers (1 = D4T, 2 = F4 compatibility).

Personalizing the Home Screen Using the UI

Placement of objects on the home screen can be modified by the user.

Note:

Prior to personalizing the Home screen first configure pluggable modules and at least one control loop.

To personalize the Home screen, do the following:

1. From any screen push the **Menu** button.
2. Push **Personalize**.
3. Push **Basic Personalization**.
4. Select the desired Home Layout by pushing **Main Top**, **Main Center** or **Main Bottom**.

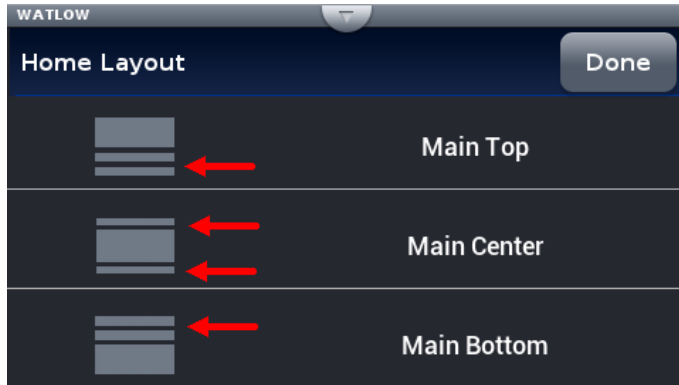

The red arrows were placed on this graphic for emphasis only and represent what the focus of this operation is; that being, defining the location of the output widget bars. As shown above, the options include placing them on the bottom, split screen top and bottom or on the top.

5. Push each page (through 4) in which loop information will be displayed.
In the graphic that follows, each page has been configured to display from 1 to 4 loops on each page.

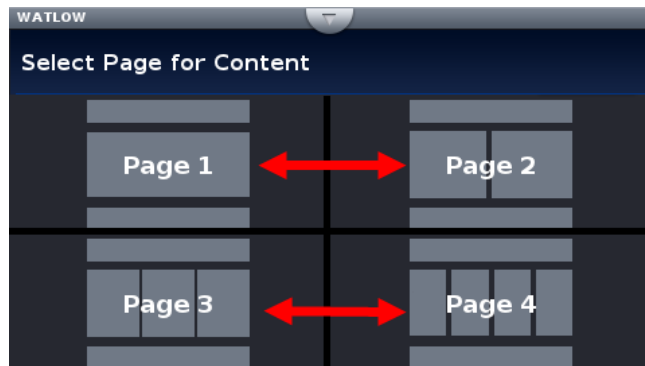

6. Define the content blocks (number of loops) that will be displayed on each page.

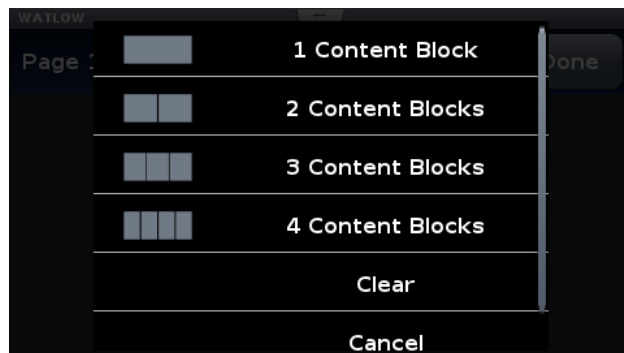

Redefining page 1 to display two loops (content blocks):

1. From any screen, push the **Menu** button.
2. Push **Personalize**.
3. Push **Basic Personalization**.
4. Select the desired Home Layout by pushing **Main Top**, **Main Center** or **Main Bottom**.
5. Push **Page 1**.
6. Select two content blocks.

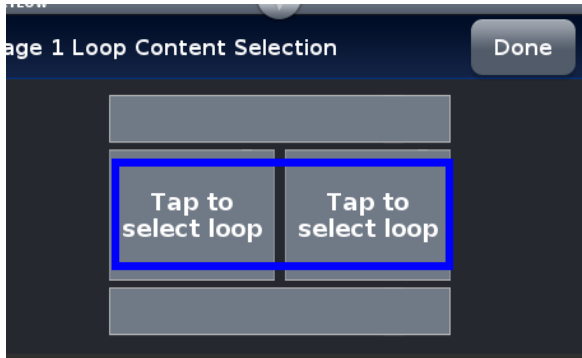

7. Tap on each content block above selecting **Loop 1** for the left and **Cascade 1** for the right.

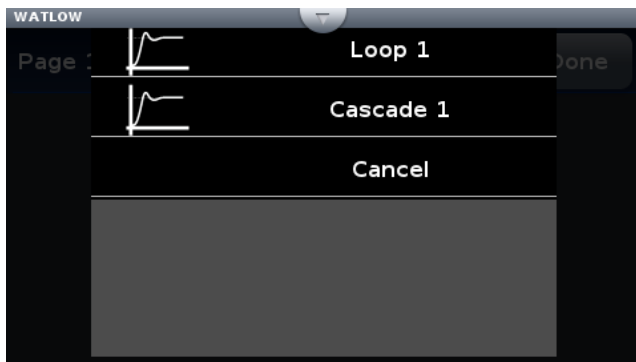

8. Push the Home screen button to see the result of this operation.

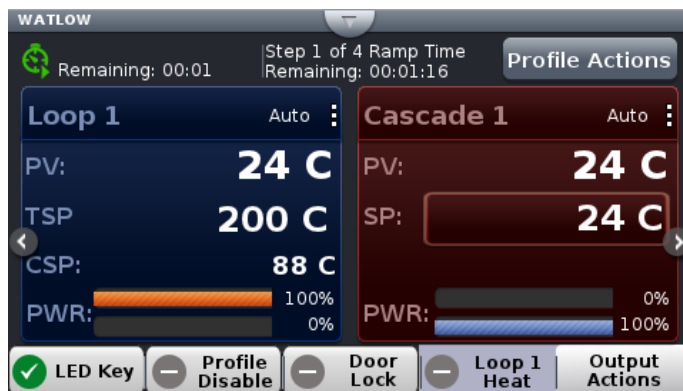

Front Panel Usage From the Home Screen

Changing Data Logger Operational Parameters

Pushing the vertical ellipsis or anywhere within the red box shown below will provide access to the data logger name and many other parameters.

Some of the available options accessible through this access point are shown below. Be aware

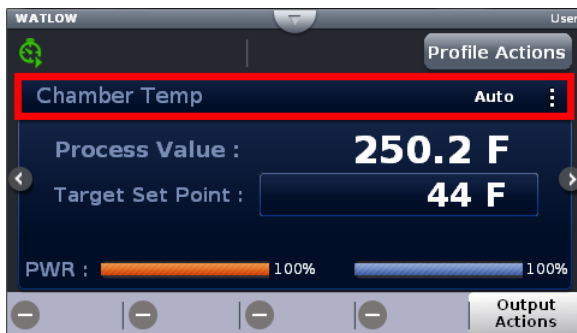

that what is visible and accessible here varies based on user settings.

F4T with USB Mouse Feature



Use pop-up mouse pointer for point and click rather than finger touch for user interface

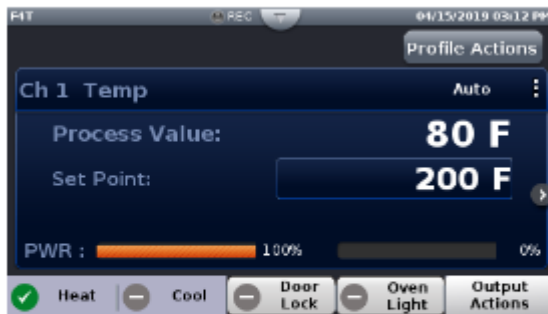

Typical USB wired mouse or wireless mouse with USB dongle plugged in the F4T USB port

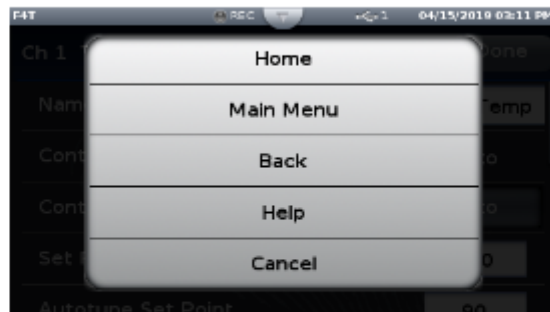

Right click on mouse for pop-up of 4 front panel keys

Batch Processing Programming - Batch Menu



Batch Processing Programming - 3 Simple "How To" Programming Steps

Step 1

- Admin. or Manager
 - Set up
 1. Set up **Load Batch** and **Unload Batch** fields the end user will be prompted to scan for the job
- Line Operator
 - Daily Operations
 2. Batch Entry - Load: Operator will scan in bar code fields being requested by controller
 3. Batch Entry - Unload: Operator will scan in bar code fields being requested by controller



Up to 25 different custom named fields can be added

Set up of batch processing complete

Batch Processing Programming - 3 Simple "How To" Programming Steps (con't)

Step 2

Admin. or Manager

- Set up
1. Set up Load Batch and Unload Batch fields the end user will be prompted to scan for the job

Line Operator

- Daily Operations
2. Batch Entry - Load: Operator will scan in bar code fields being requested by controller
 3. Batch Entry - Unload: Operator will scan in bar code fields being requested by controller

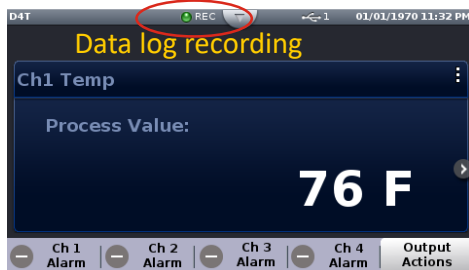
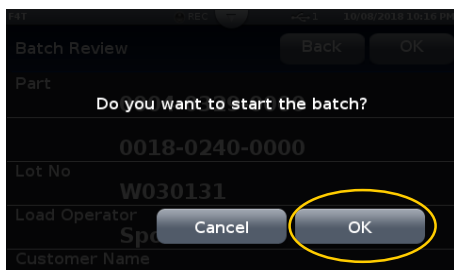
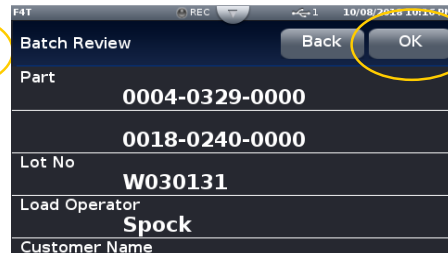
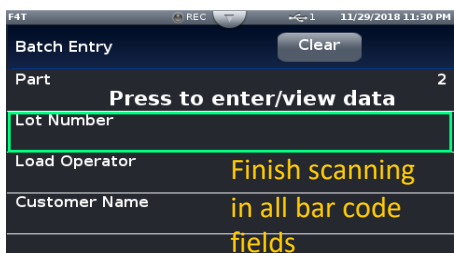
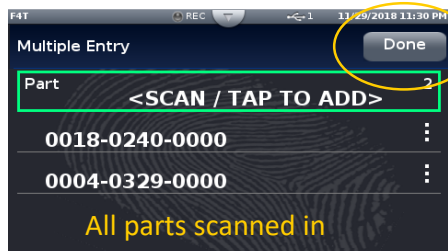
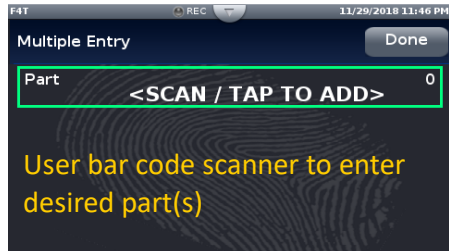
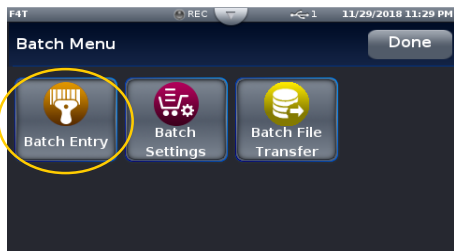

Batch Processing Programming - 3 Simple "How To" Programming Steps (con't)

Step 3

Admin. or Manager

Set up

1. Set up Load Batch and Unload Batch fields the end user will be prompted to scan for the job

Line Operator

Daily Operations

2. Batch Entry - Load: Operator will scan in bar code fields being requested by controller
3. Batch Entry - Unload: Operator will scan in bar code fields being requested by controller

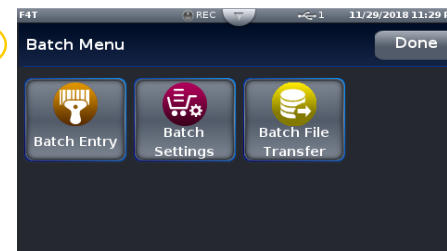
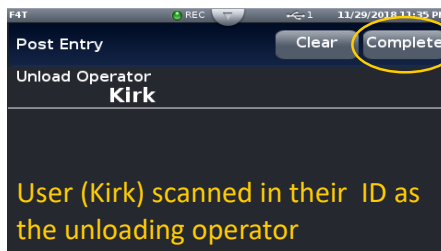
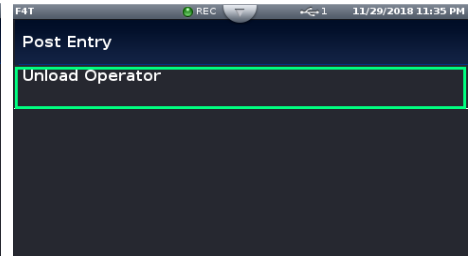
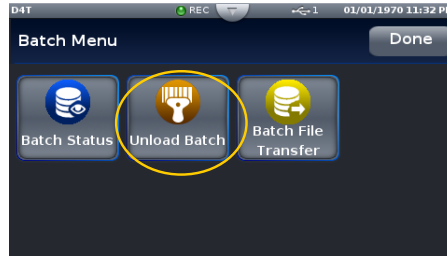
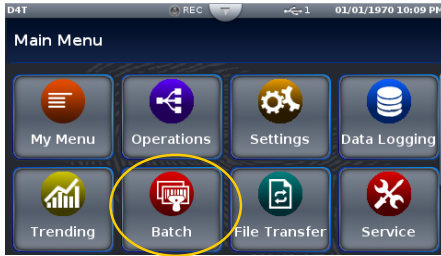

Batch report is automatically generated by controller

Export Data Log Report - Via USB Stick

Use existing "File Transfer" method to export data log file now formatted as a Batch Report (configuration, profiles, data log)

Scenario described below: Export via USB stick plugged into F4T/D4T controller.

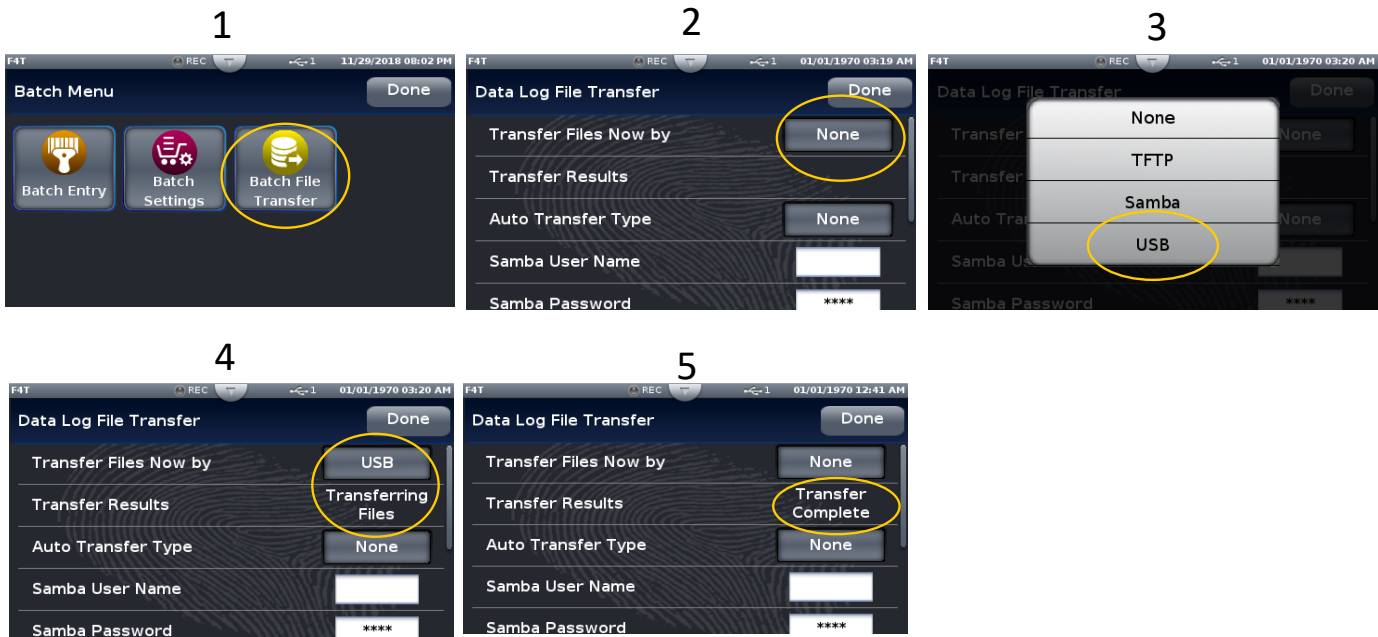

Microsoft Excel view of Batch Report (.CSV file format)

Transfer file on USB stick into a PC to view file

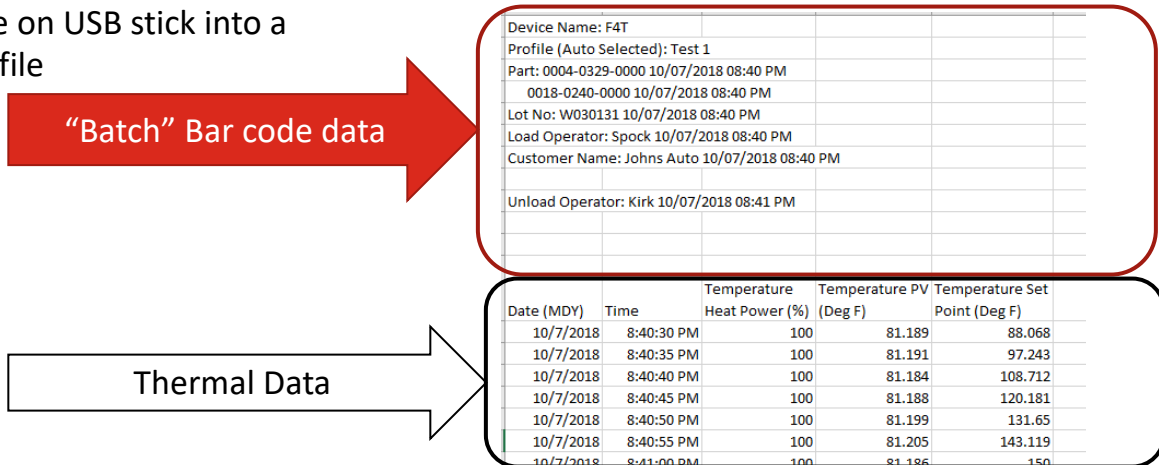

Creating and viewing encrypted data files are also available.

Details covered in Watow F4T videos available on line.

Want to learn more:

- Data logging video: <https://www.youtube.com/watch?v=QC-dnzoKEXQ&t=0s&index=2&list=PLaQIQSMB2FG3K7m-mnhLubeh9W6bJcBZJ>
- Data log/batch report file transfer video: https://www.youtube.com/watch?v=Sg_eoNXQcus&index=3&list=PLaQIQSMB2FG3K7m-mnhLubeh9W6bJcBZJ

Using the Output Widget

In the graphic below, the output widget is located at the bottom of the screen within the red box. The buttons within the red box can be configured to display the status of an output or they can be used as inputs via a function key.

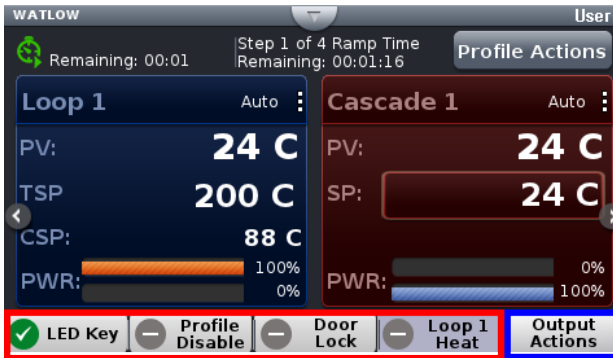

Configuring the Output Widget:

1. Push **Output Actions** (blue box above).
 - View All Outputs, displays all connected outputs by their name (if given).
 - Change View, defines widget location.
 - Cancel, Returns to the Home screen.
2. Push the **Change View** button.



3. Push the desired position (1 to 4) and define its function.

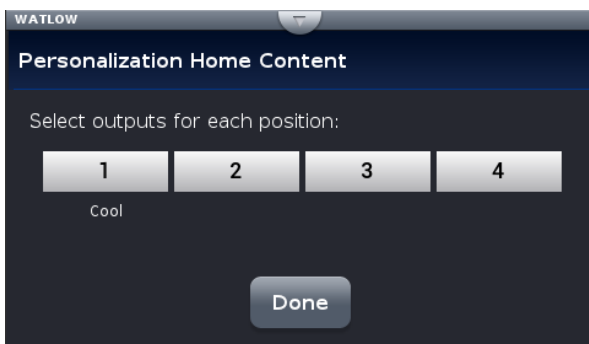

4. Push the **Done** button when complete.

Data Logging

Data Logging can be enabled at any time and will log a user selectable list of data points. While data logging is enabled, the data log file is stored within either the USB device memory or internal memory. Once the file reaches a specified size (if being transferred automatically),

it will be sent directly to one of three other destinations (USB, TFTP server or a Samba server). The file transfer can also be initiated manually at any time. The file transfer process from internal memory, whether completed automatically or manually, will move all log files from internal memory to the selected destination. To learn more about data logging see "[Data Logging](#)" in the Overview Section of this User Guide.

From the UI, there are two ways to setup and initiate data logging:

To setup and run data logging using the UI:

1. Push the **Menu** button.
2. Push the **Data Logging** button.
3. Push the **Select Data Points** button to select the data points that will be captured in the log.
4. Push the **Done** button when complete.
5. Push the **Setup** button to define the following:

- Logging Status: indicates whether or not recording is active or not.
- File Name: any alphanumeric characters, 63 maximum.

Note:

A new dedicated file is created when data logging starts and the filename format will be "file name" "date stamp" "time stamp".csv or enc".

- Log To: USB or Internal Memory.
- Log Interval: defines the frequency in which the log will be written, 0.1 second to 60 minutes.
- File Type: Encrypted (*.enc), Comma Separated Values (*.csv) or Both.
- File Size Limit: 20MB when using TFTP or Samba, 1GB when using USB.
- Memory Full Action: when log to device defined above is full, Overwrite or Stop.

Note:

Logging to USB allows for Stop only, when memory is full.

- Date Format: MM/DD/YYYY or DD/MM/YYYY.
- Time Format: 12 or 24 hour clock.

6. Push the **Done** button when complete.

Note:

Although this completes the setup it may be desired to configure the file transfer function before starting data logging (see [Transferring Data Log Files](#) below).

7. If desired push the **Annotation** button. Annotation allows for time specific entry of up to 32 alphanumeric characters to a specific entry (line) within the log file. The maximum speed at which annotation can be written to the log file is approximately once every 20 seconds. Once written to the file, the annotation field on the UI will be deleted where a new value can be entered and written again.

8. Push the **Start** button to begin data logging.

Note:

Data logging is terminated when power is lost, however, the file as it was prior to the loss of power will be retained.

Transferring Data Log Files via the UI

A user can transfer data log files manually or automatically.

Note:

All closed data log files are transferred. If a file is open during the logging process, that file will not transfer until closed.

To transfer files manually:

1. Push the **Menu** button.
2. Push the **File Transfer** button.

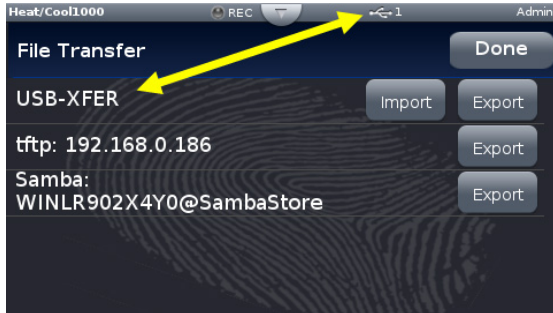
**Note:**

The graphic above may or may not look similar when viewed on your D4T. To appear as shown, a USB thumb drive must be installed and both a TFTP and Samba server must be configured.

3. Push the **Export** button for the desired destination.

To transfer files automatically:

1. Push the **Menu** button.
2. Push the **Data Logging** button.
3. Push the **Data Log File Transfer** button.
4. Select Auto Transfer Type, **TFTP**, **Samba** or **USB**.

If TFTP or Samba is selected above, the server must be configured. For instructions on how to configure either or both, click on the server of choice: [TFTP](#) or [Samba](#)

Flashing the Data Logger Firmware

On occasion, the D4T firmware may be updated. When flashing the firmware ensure that power to the data logger is not disrupted and allow the process to proceed to completion. Once the process is complete, the data logger will come back up with the same configuration (in its entirety) prior to flashing.

To flash the data logger to the latest firmware version:

1. Copy the file "D4TUpdate" to the root directory of a USB thumb drive.
2. Insert the USB thumb drive into either of the USB ports on the back of the D4T.

Note:

Prior to initiating this process ensure that there is only one thumb drive connected.

3. Push the **Menu** button.
4. Push the **Settings** button.
5. Push the **Update** button.
6. Push the **Install Update** button.

Note:

Cycling the power to the data logger after step two will also initiate an immediate update.

After executing step 6 above, the three screen shots below will appear on screen as the flashing activity proceeds.

Copy files:



File Update:



File Update Complete:



When this last screen appears, it will remain on screen for approximately 15 seconds.

Note:

The data logger will be restored to reflect the same state it was in when the flashing activity was started. For example, if the data logger was in auto mode it will be returned to auto mode.

Email and Text Alerts

The Email/Text Alert feature provides a method to send an Email and/or an Email-to-SMS message (text message) to defined contacts when specified events occur. Up to 10 unique alerts can be configured. 10 Contacts can be predefined to receive alerts (with 2 addresses available per Contact).

When the specified conditions occur for any enabled Alert, the D4T will automatically send an Alert message to each Recipient that has been selected within the respective Alert.

An Email or Text alert informs the recipient that an event has occurred for which they can be re-active or proactive in their response to the application. For example, a notification may be desired when a step has completed to allow the contact to begin preparing material for a future step in the process.

Alerts can be configured for:

- Alarm conditions
- When an analog input error has occurred

Note: The D4T controller is only capable of sending Alerts when the following conditions are met:

- The D4T is properly connected to a network via Ethernet
- The Email Server Settings are configured to allow the connection to an email server
- Email/Text Enabled is set to YES (in Email Server Settings)

Note: The timing and delivery of the Email and Text alerts is dependent on a variety of components for delivery. The failure of the internet connection, email server, power supply, or other components can prevent the delivery of the Alert. As a safety precaution, DO NOT rely on the delivery of an Alert for an event.

From the D4T Main Menu, press the Email and Text button to access the Email and Text screen.

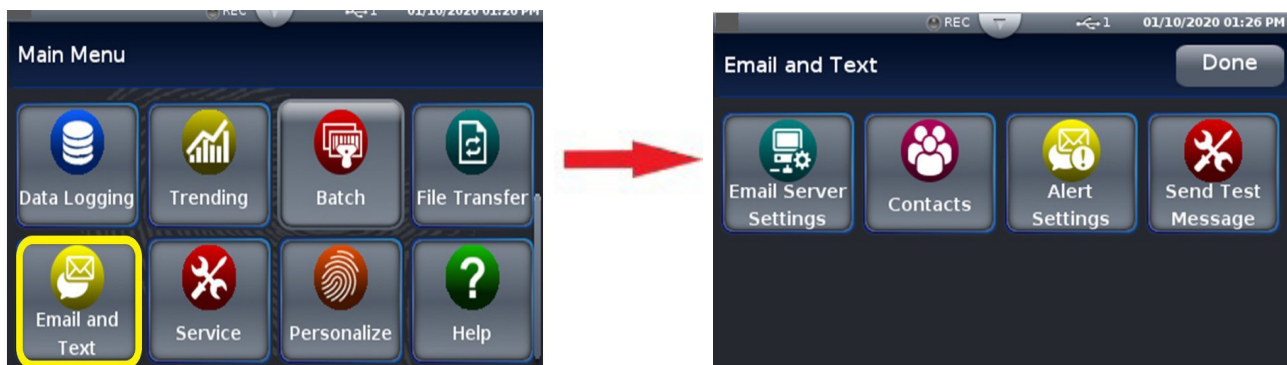

Step 1: Email Server Settings

You must enter the server settings to enable the D4T controller to send alert messages. Press the Email Server Settings button to access the Server Settings screen.



Touch each field to edit the data for that field and enter the appropriate information. If you do not know the correct information for your email server, contact your system administrator for assistance.

The bracketed bold settings below represent the defaults as delivered from the factory:

- **Email/Text Enabled:** Yes, **[No]** Enables the Email Text feature.
 - Yes: Email/Text feature is enabled. Allows the D4T to send Alerts when the Alert conditions are met.
 - No: Email/Text feature is not enabled. No Alerts will be sent.
- **Email Server:** **[mail.company.com]** Enter the name of the email server that will be used for sending email. Typical format is: mail.company.com. This information, along with the SSL/TLS, Port, Username & Password settings, must be configured properly, to allow the D4T to send messages. Contact your system administrator for assistance.
- **Use SSL/TLS:** **[Yes]**, No
 - Yes: use Secure Socket Layer (SSL) / Transport Security Layer (TLS) functionality.
 - No: SSL/TLS is not used.
- **Port:** **[587]** Enter the Port number used by the SMTP (email) server. Typically, the standard port number used would be the following:
 - Port **587** when Use SSL/TLS = **Yes**
 - Port **25** when Use SSL/TLS = **No**This may be different depending on your company's server settings. Contact your system administrator for assistance.
- **Username:** **[user@example.com]**
 - This must be a valid username that will be used to log in to your company's email server. This will be the sender email address when alerts are sent from the D4T.
- **Password:** **[]**
 - Enter the password, if required by your network, that corresponds to the Username entered above.

Press the Done button in the upper right corner to save the server settings and return to the Email and Text Main screen.

Step 2: Send an Alert Test Message

Send Test Message can be used as a diagnostic feature to determine if the Email Server Settings and network connection are configured properly to allow the D4T to send Alert messages. No configuration of the Contacts or Alert Settings is required to use Send Test Message.

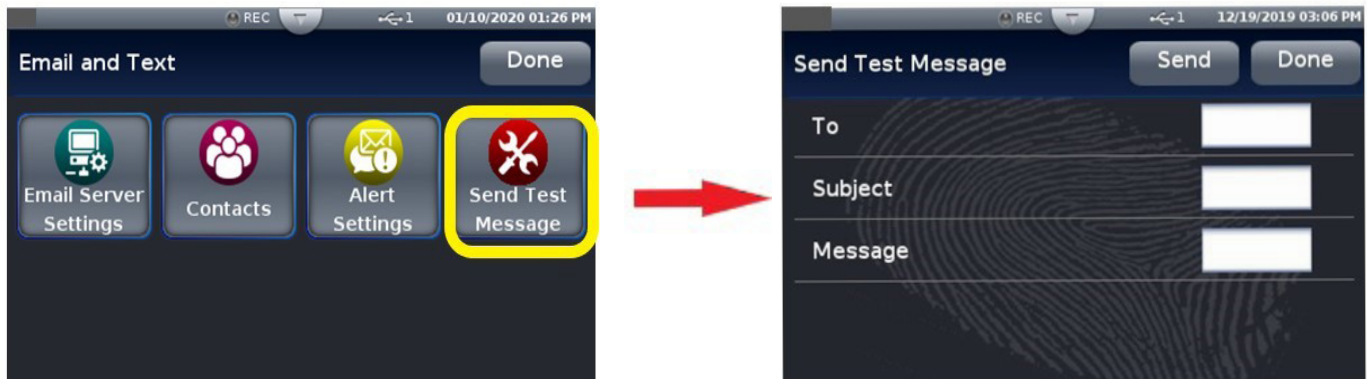

To: The Email address that the Test Message will be sent to.

Subject: Subject line of the Test Message

Message: Body of the Test Message.

Note: The email will appear as if it comes from the email account that is used for the Username in Email Server Settings.

Enter the appropriate information in the fields and then press the Send button. When the confirmation screen is shown, press the Send button to send the test message or Cancel to dismiss without sending.

Note: The Send Test Message function will only work if the Email/Text Enabled field is set to YES in the Email Server Settings

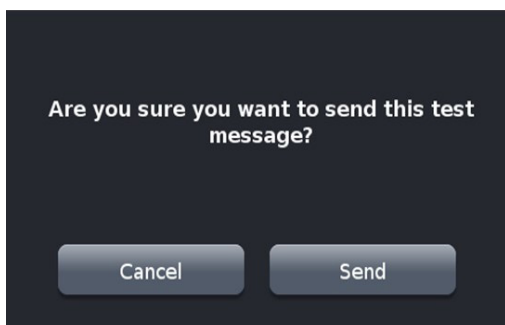

Step 3: Defining Contacts

Before alerts can be sent, you must define the people or contacts to which the messages will be sent. Press the Contacts button on the main Email and Text screen to access the Contacts screen.

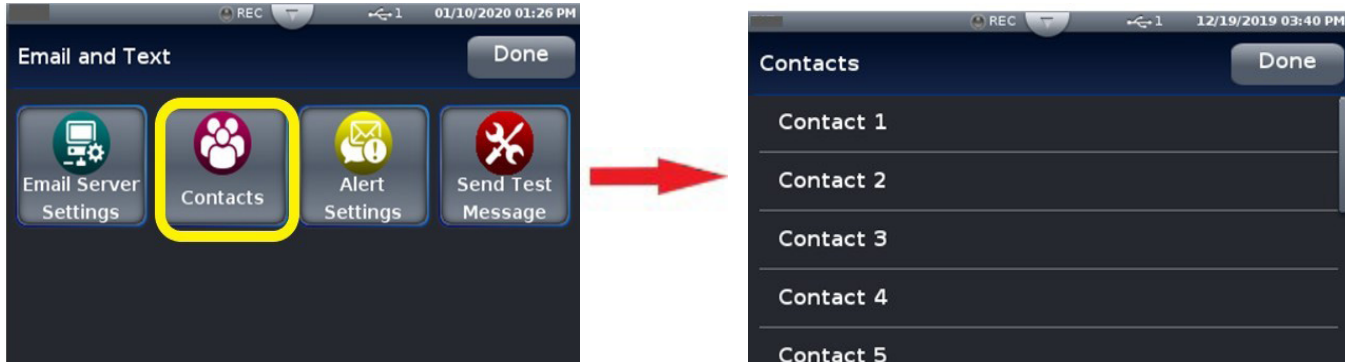

You can define up to 10 contacts to receive alerts. Touch a Contact line to configure a contact for that number. The Contact Configuration screen is shown for the contact line that you selected. Note that the Address fields contain example text to show what type of address should be entered in the field.



Enter a name in the Name field to identify the contact. If this field is left blank, the default Contact # will be used. Enter an Email or Email-to-SMS address in the fields provided. Two address fields can be defined for each Contact.

To send the Alert as a text message to a recipient's phone, an Email-to-SMS address must be entered. The format of this address is specific to each recipient's cellular service provider. Contact the service provider for the proper format.

Some examples of formats for common cellular service providers are:

<u>Carrier</u>	<u>SMS gateway domain</u>
AT&T	10-digit number@txt.att.net
Sprint	10-digit number@messaging.sprintpcs.com
U.S. Cellular	10-digit number@email.uscc.net
Verizon	10-digit number@vtext.com

When the contact information has been entered, press the Done button in the upper right corner to save the contact information and return to the Email and Text Main screen.

Step 4: Configuring Alerts

Once the Email Server Settings and Contacts have been defined, the Alerts can be configured. Press the Alerts Settings button on the main Email and Text screen to access the Alerts Settings screen.

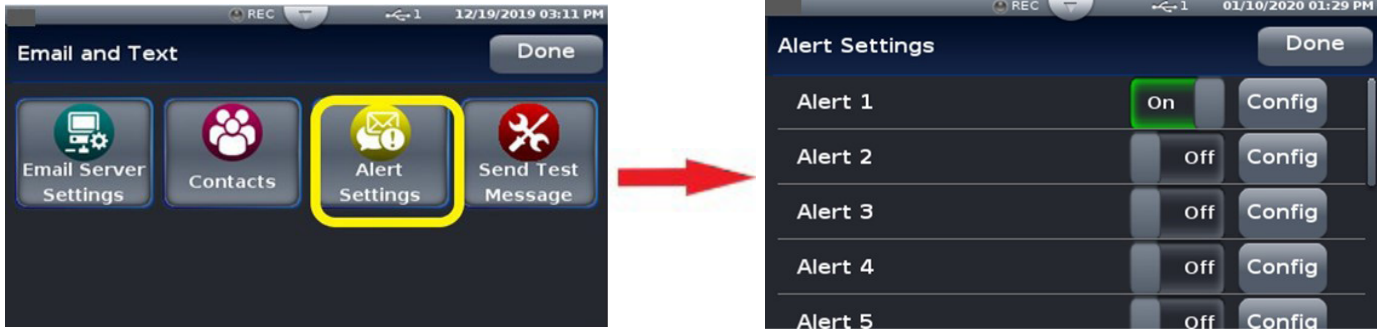

Each Alert has a toggle switch on the alert definition line to turn the alert on and off. Slide the toggle switch to the desired position once the alert has been completely configured. To define an Alert, press the Config button beside an alert number to access the configuration screen for that alert.

Press the Config button on the Recipients line to define the Recipients that will receive this Alert. Set the toggle button to Yes next to any Contact to notify them of this Alert condition. If All Contacts is set to Yes, the Alert will be sent to All Contacts that have valid email addresses defined.

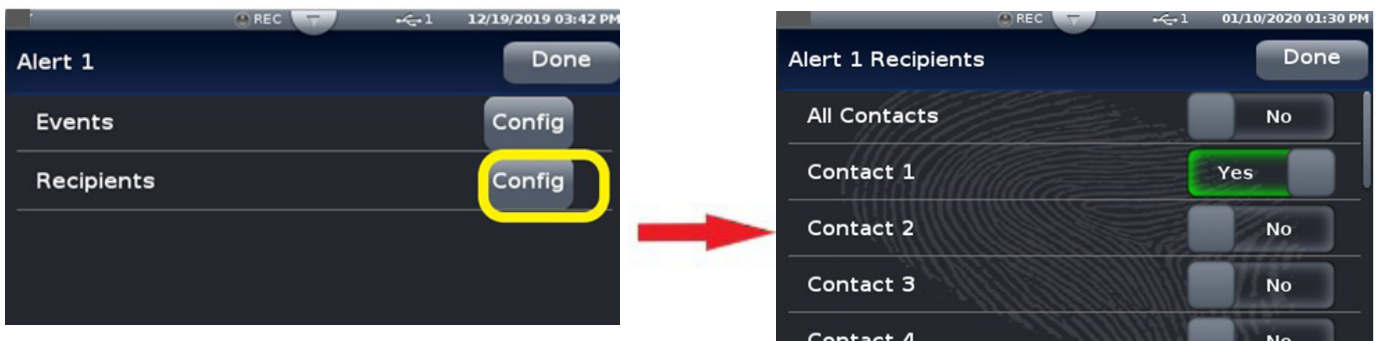

Press the Config button on the Events line to define the events that will trigger this alert to be sent. Press the Done button to return to the Alert configuration screen.

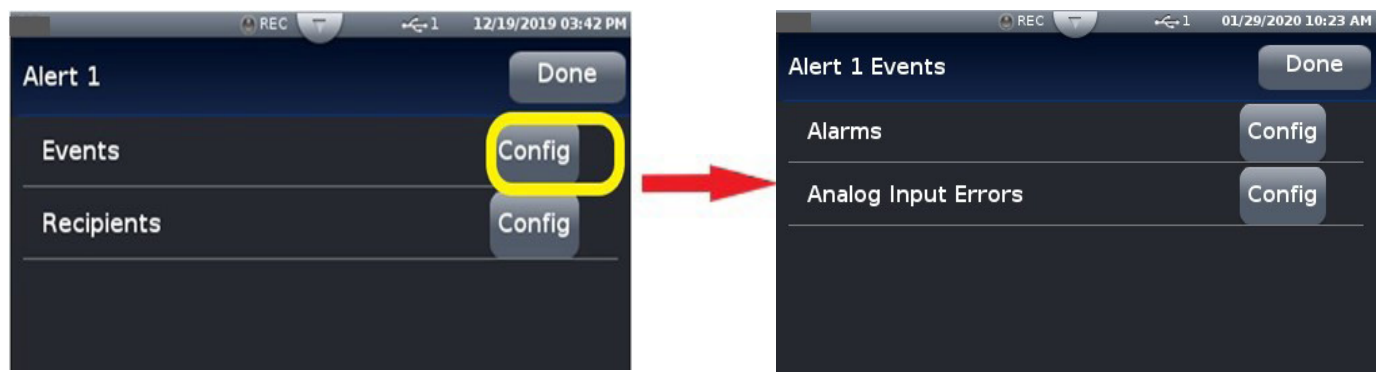

Alarm Settings Configuration

Press the Alarms Config button on the Alert Events screen to access the Alert Alarms Settings screen. Select the appropriate settings and then press the Done button to return to the Alerts Event screen.

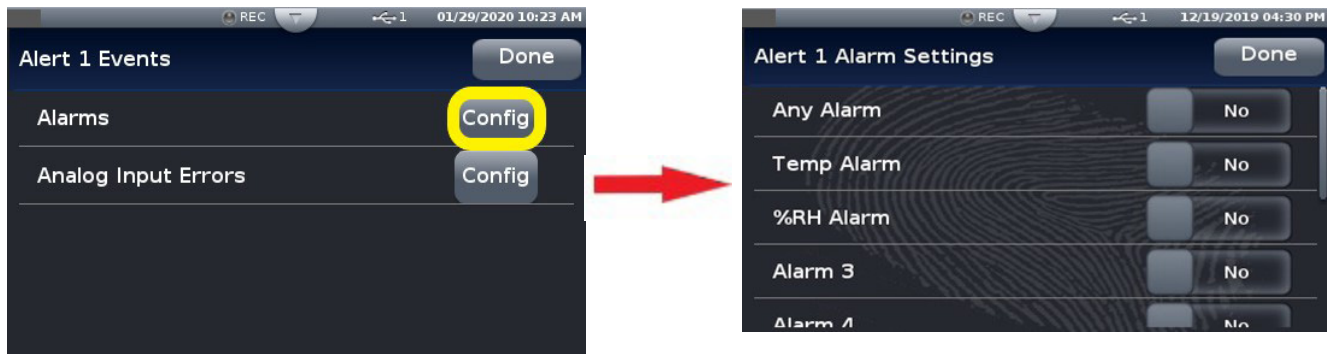

Analog Input Errors Settings Configuration

Press the Analog Input Errors Config button on the Alert Events screen to access the Alert Analog Input Errors Settings screen. Select the appropriate settings and then press the Done button to return to the Alerts Event screen.

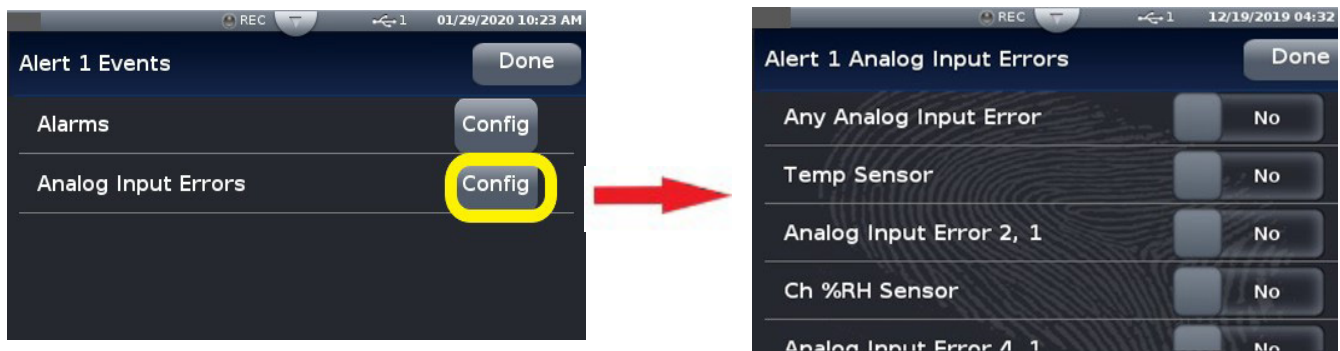

4

Chapter 4: Application Examples

Applications

This chapter contains the basic instructions for configuring sample applications. Refer to Chapter 5 for detailed descriptions of the function blocks and parameters.

Process Alarm

In this example Universal Input 1 on module 1 measures the temperature of a chamber or oven with a thermocouple. Alarm 1 monitors the temperature from the universal input which is also used by the control loop as feedback for heat control. When the temperature goes outside the normal range defined by the user-adjustable, alarm set points, output 1 on module 4, a form C relay energizes an audible alarm and an indicator lamp to get the operator's attention.

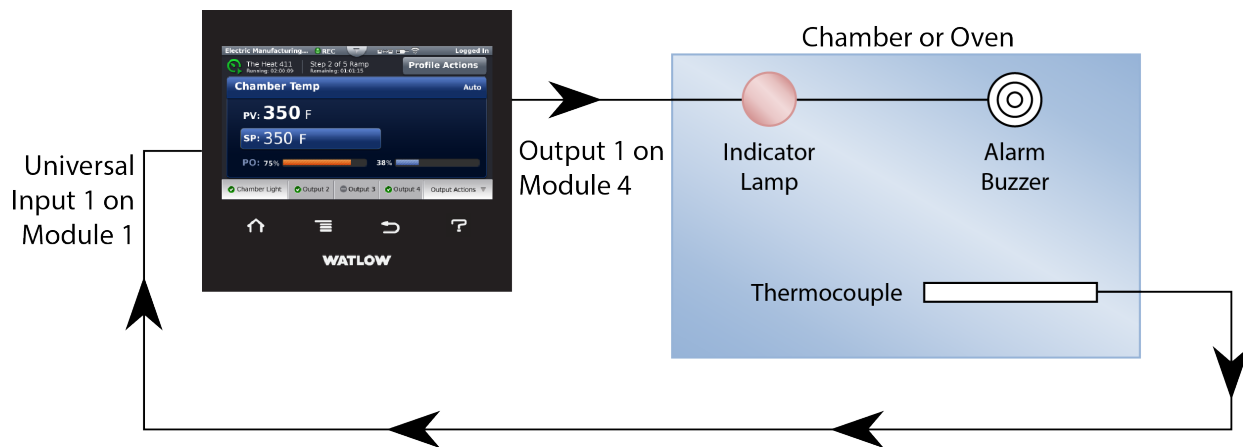

Function Block Diagram

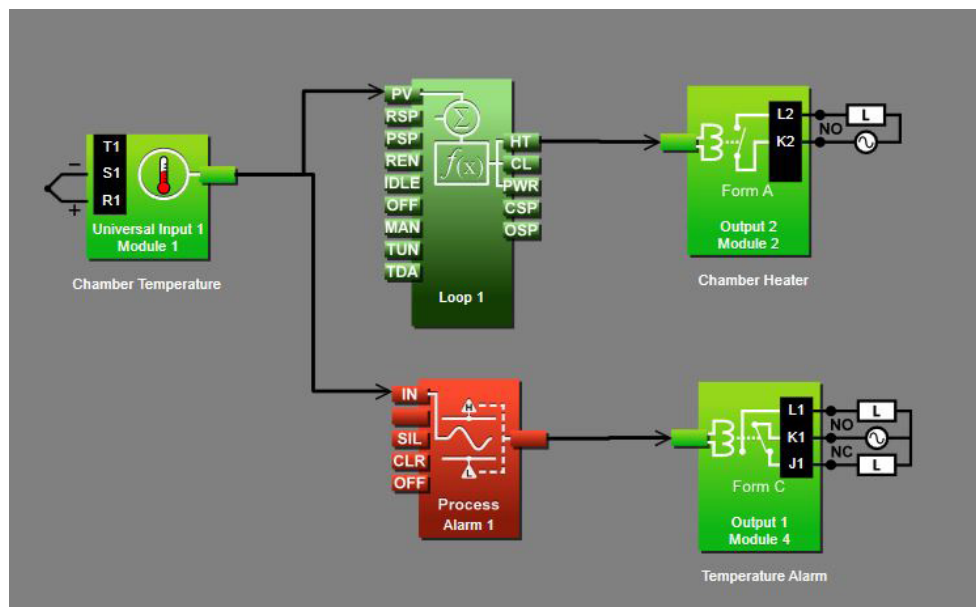

Application Tips:

- Alarm blocks are initially located in the library and can be dragged to the canvas.
- The signal from the universal input to IN on the alarm is the one the alarm monitors against the alarm set point.
- The signal from the alarm to the output indicates when the alarm has occurred. The alarm is indicated on the data logger whether or not there is an output attached; the output on the alarm block is for use with additional logic in the application diagram or to drive external devices as is shown in this example.
- Enter names for blocks where possible to make the application easier to understand.
- The control loop is not necessary for the alarm; it is shown here just to make it clear that more than one function block can receive the analog input signal.
- Make sure the input block's Sensor Type and other parameters are set correctly for your sensor.
- By default the alarm's type setting is Off. Set it to Process Alarm.
- Set the alarm's Sides setting to High or Low if you want to monitor only for the process value going too high or too low, or set Sides to Both if you want the alarm to occur when the process value is either too high or too low.
- For more information on alarm parameters see the section entitled "[Alarm](#)" in Chapter 5.

Deviation Alarm

In this example Universal Input 1 on module 1 measures the temperature of a chamber or oven with a thermocouple. Alarm 1 monitors the temperature from the universal input which is also used by the control loop as feedback for heat control. When the temperature gets farther from set point than the user-adjustable, alarm set points, output 1 on module 4, a form C relay energizes an audible alarm and an indicator lamp to get the operator's attention.

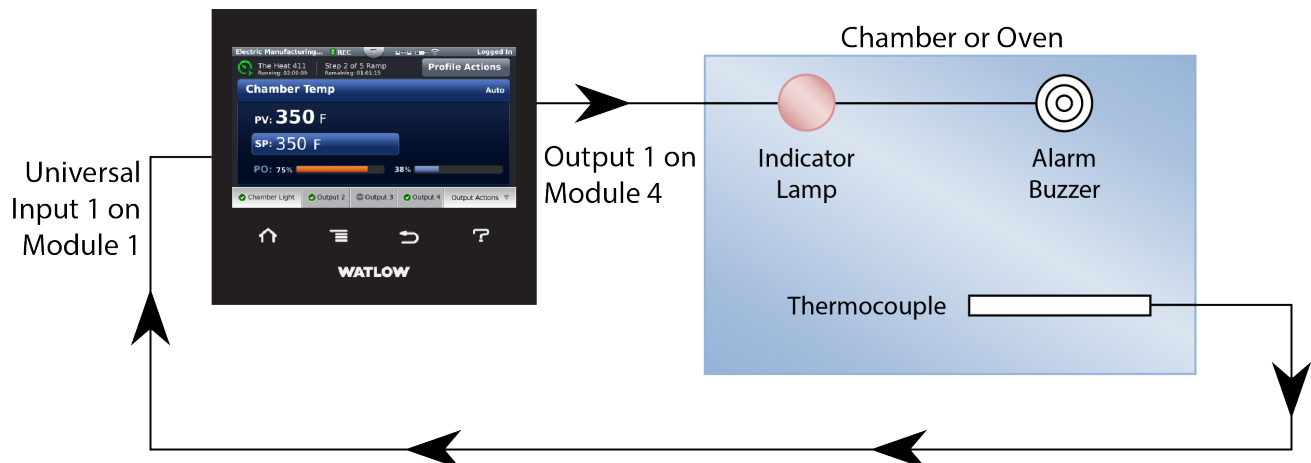

Function Block Diagram

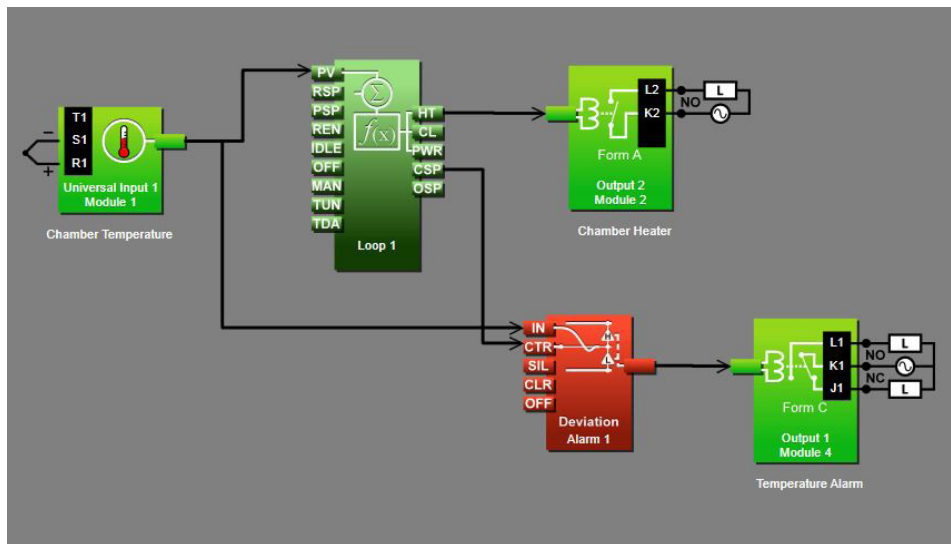

Application Tips:

- Alarm blocks are initially located in the library and can be dragged to the canvas.
- The signal from the universal input to IN on the alarm is the one the alarm monitors against the alarm set point.
- The signal from CSP on the loop to CTR on the alarm transmits the loop's set point to the alarm so that the deviation alarms can be relative to the loop's set point.
- The signal from the alarm to the output indicates when the alarm has occurred. The alarm is indicated on the data logger whether or not there is an output attached; the output on the alarm block is for use with additional logic in the application diagram or to drive external devices as is shown in this example.
- Enter names for blocks where possible to make the application easier to understand.
- A deviation alarm uses the signal received at CTR as the center of the deviation band. The high and low alarm set points are relative to that center value. In most deviation alarm applications users want the alarm deviation centered on a control loop's set point as shown in this example, but any analog signal could be used.
- Make sure the input block's Sensor Type and other parameters are set correctly for your sensor.
- By default the alarm's type setting is Off. Set it to Deviation Alarm.
- Set the alarm's Sides setting to High or Low if you want to monitor only for the process value going too high or too low, or set Sides to Both if you want the alarm to occur when the process value is either too high or too low.
- For more information on alarm parameters see the section entitled "[Alarm](#)" in Chapter 5.

Sensor Backup

In this example there are two thermocouples measuring the temperature of an oven. Normally one provides feedback to a control loop that drives the heater. In the event the first thermocouple fails, the data logger switches automatically to the second providing uninterrupted control.

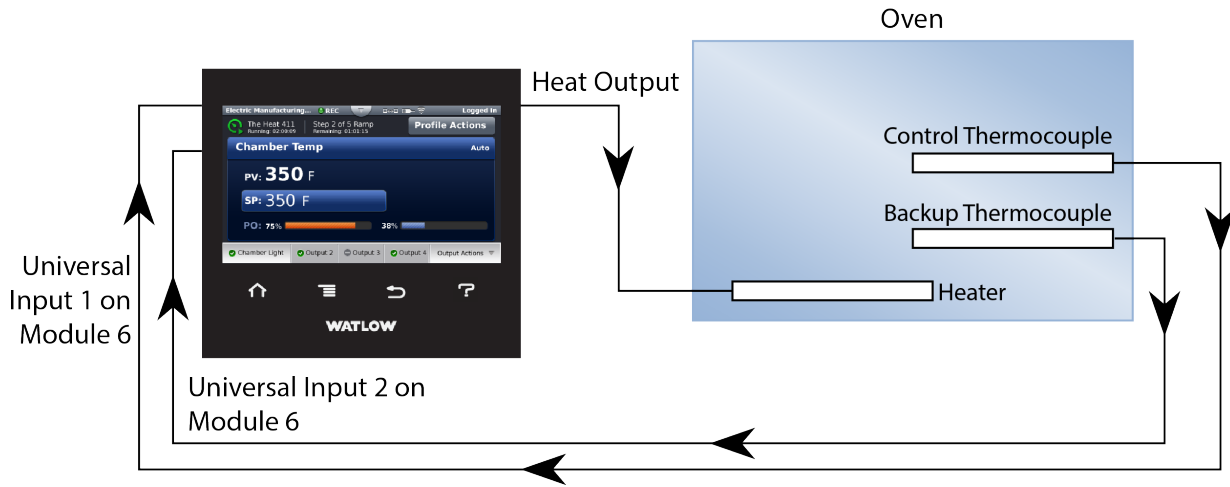

Function Block Diagram

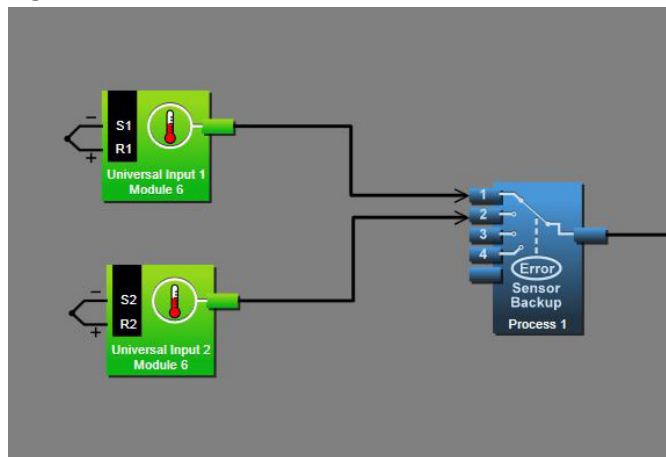

Application Tips:

- Process blocks are initially located in the library and can be dragged to the canvas.
- You can connect up to four sensors to the Process block. The process block passes along the signal from the lowest number receiver that has no error on its sensor signal.
- The signal transmitted by the process block can be used by a control loop or any other function as if it was received directly from a universal input block.
- Make sure the input blocks' Sensor Type settings and other parameters are set correctly for your sensors.
- Set the Process block's Function to Sensor Backup.

5

Chapter 5: Function Block Reference

D4T Functions Described	58
Alarm	59
Off	60
Process Alarm.....	60
Deviation Alarm.....	62
Analog Outputs	66
Compare	68
Off	68
Greater Than	68
Less Than	69
Equal To	69
Not Equal To	70
Greater or Equal	71
Less or Equal	71
Counter	72
UP	72
Down.....	74
Digital Inputs/Outputs (I/O)	75
Input Dry Contact	75
Output	76
Input Voltage.....	77
Digital Outputs	78
Solid-State Relay - Switched DC/Open Collector.....	78
Electromechanical Relays	80
Key	81
Momentary	81
Toggle	81
On Pulse	82
Linearization	82
Off	82
Interpolated.....	83
Stepped.....	85
Logic	89
Off	89
And	89
Nand	90
Equal To	91
Not Equal To	92
Or	93

5

Chapter 5: Function Block Reference

Function Block Reference (cont.)

Nor	94
Latch	95
RS Flip Flop	96
Math	97
Off	98
Average	99
Switch Over	99
Process Scale	100
Deviation Scale	102
Differential	103
Ratio	104
Add	104
Multiply	105
Absolute Difference	105
Minimum	106
Maximum	107
Square Root	107
Sample and Hold	108
Pressure to Altitude	108
Dew Point	109
Process Value	111
Off	112
Sensor Backup	112
Average	113
Crossover	113
Wet Bulb / Dry Bulb	114
Switch Over	115
Differential	116
Ratio	116
Add	117
Multiply	117
Absolute Difference	118
Minimum	118
Maximum	119
Square Root	119
Vaisala® RH Compensation	120
Pressure to Altitude	120

5

Chapter 5: Function Block Reference

Function Block Reference (cont.)

Special Output	123
Off	123
Compressor Control	123
Thermistor Input	126
Timer	129
Off	129
On Pulse	130
Delay	131
One Shot	132
Retentive	134
Universal Input	136
Millivolts/Volts	137
Off	139
Thermocouple	140
Milliamps	141
Resistance Temperature Device (RTD) 100 and 1000 Ohm	143
1K Potentiometer	144
Variable	147
Analog	147
Digital	149

D4T Functions Described

The data logger is customized by connecting function blocks (FB) as needed for the application. A transmitter of one function is commonly connected to a receiver of another using Composer's function block diagram editor. The connections between blocks, referred to as signals, carry information from one function block to another.

Each signal carries three pieces of information:

1. Value

- The value is either analog (floating point numbers) or digital (on, off, true or false). Most function blocks expect a specific type of value to be received at each receiver and produce a specific type of value at each transmitter. Depending on the context, the value of a digital signal may be thought and spoken of in various terms. The table below lists the various terms that occur in the various contexts.

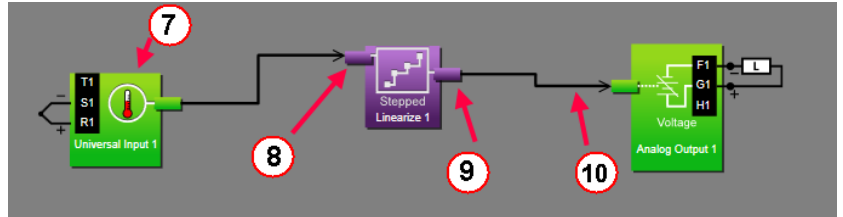

Analog Value	Digital Values	Logic	*Active Signal Parameter Settings
0%	Off	False	Low
100%	On	True	High

* When the state of a digital signal that triggers an action is configurable, the values are referred to as Active and Inactive and a parameter is provided for choosing which state triggers the action.

2. Units

- An analog signal can be in units of absolute or relative temperature (Celsius or Fahrenheit), percent power or relative humidity. Values may have no units or unspecified units, indicated as *process*. Digital signals have no units associated with them.

Units	Description
Absolute Temperature	The value is a temperature on the Celsius or Fahrenheit scale. For example, 33° F as an absolute temperature is one degree above the freezing point of water. An absolute temperature can be used as a set point or compared with other temperatures to determine which is hotter or colder
Relative Temperature	The value is a relative number of degrees, not an absolute temperature. For example, the difference between the two measured temperatures, 120° C and 100° C is 20 degrees, but it is not the temperature 20° C. A relative temperature is appropriate for use as a calibration offset or a deviation alarm set point
Relative Humidity	The value is a measurement of percent relative humidity (%RH)
Power	The value is a percentage with 100% representing full power and 0% representing no power
Process	The value is in units of measure other than degrees Fahrenheit, degrees Celsius or relative humidity
None	The value is a pure number without units

3. Error Status

- A signal's error status indicates whether or not the value can be relied on. A signal with no errors (error status is none), is displayed as a black line in Composer. When something is wrong such that a function block cannot determine an appropriate value to transmit, the signal is displayed as a yellow line in Composer. You can determine the specific error status by mousing over the signal in the diagram. The table below lists the possible errors that could be presented to the user. Any error status other than *none* is considered an error.

Error Status	Description
None	No error is detected.
Open	A sensor is broken or disconnected.
Shorted	A sensor has failed or is shorted.
Measurement Error	A measurement error has occurred.
Bad Calibration	The data logger has not been calibrated.
Ambient Error	The ambient temperature is outside of the data logger's operating range.
RTD Error	An RTD sensor error has occurred.
Fail	A measurement failure has occurred.
Not Sourced	The source FB is missing a required signal at one of its receivers.
Stale Data	Data sourced from another data logger has become unavailable.
Math Error	A calculation has no defined result (such as divide by zero).

This chapter describes in detail each of the available functions as well as their associated parameters.

Note:

The addresses and other information required to read or set FB parameter values via a field bus protocol is located in the "Communications" section of the Appendix to this User's Guide.

Alarm

Use an alarm to monitor an analog signal and set an output when that signal goes above or below the user-set alarm conditions. This block is found in the Function Block Diagram editor's Library when working with a data logger that offers the Alarm block. The number of these blocks available is shown within the parenthesis.

Use the Type parameter to set the block's behavior. These options for Type are described in detail in the following sections:

Off: no alarms occur. The block's output is off.

Process Alarm: monitors an analog signal for specified alarm conditions.

Deviation Alarm: monitors an analog signal for alarm conditions relative to another signal.

Off

When Type is set to Off, the output is off.

Process Alarm

A Process Alarm sets its output when the receiver (IN) rises above the High Set Point or drops below the Low Set Point. The alarm's behavior can be customized with Logic, Latching, Blocking, Silencing and Delay Time parameters.

Signals

Direction	Label	Type	Function
Receivers	IN	Analog	Monitored for alarm conditions
			Not used
	SIL	Digital	True silences the alarm (see Silencing)
	CLR	Digital	True clears the alarm if the condition that caused it no longer exists (See Latching)
	OFF	Digital	True makes the function act as if Alarm Type was set to off
Transmitter	- - - -	Digital	Indicates the alarm state (see Logic)

Name

Uniquely identify this FB using up to 20 alphanumeric characters.

Type

To monitor an analog signal for alarm conditions, set Type to *Process Alarm*.

Sides

Select whether the receiver (IN) is monitored for high, low or both high and low alarms.

Options:

- *Both*: IN is monitored for high, low or both high and low alarms.
- *High*: IN is monitored for a high alarm only. The low alarm is not monitored.
- *Low*: IN is monitored for a low alarm only. The high alarm is not monitored.

Hysteresis

Set how far the process must return into the normal range before the alarm can be cleared. Hysteresis defines how far the signal must drop below the High Alarm Set Point before a high alarm can be cleared and how far the signal must rise above the Low Alarm Set Point before a low alarm can be cleared.

Range: 1 to 9,999 °F or units
2 to 5,555 °C

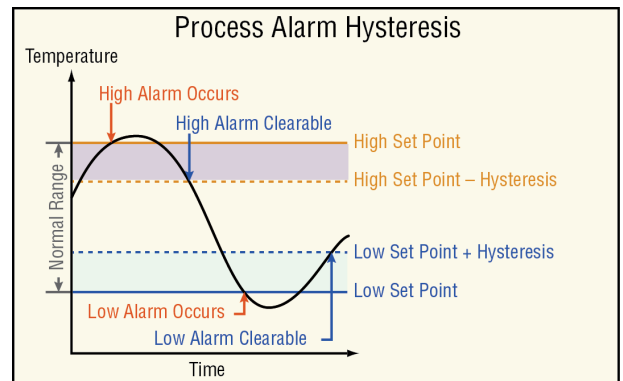

Silencing

Set whether or not the output can be returned to the non-alarm state (*silenced*) before the input returns to the normal range. Silencing an alarm returns the alarm's output to its inactive state without requiring the alarm state to be cleared. Once the alarm is silenced, the output remains inactive until the alarm is cleared and the alarm condition reoccurs.

Options:

- *Yes*: alarm can be silenced by connecting a digital signal to SIL or by using the Silence Alarm parameter
- *No*: alarm cannot be silenced. After an alarm occurs, the function's output returns to its non-alarm state only when the alarm is cleared

Latching

Select whether an alarm state is maintained (latched) or clears automatically when the process value returns to an acceptable level.

Options:

- *Latching*: alarm remains active until the condition that caused it no longer exists and the alarm is reset by the CLR receiver or the Clear Alarm parameter.
- *Non-latching*: alarm clears automatically once the condition that caused it no longer exists.

Blocking

Alarm blocking allows a system to warm-up after being powered up or to be adjusted without experiencing nuisance alarms. Set alarm blocking to prevent alarms before IN has first come within the normal operating range.

Options:

- *Both*: alarms are blocked when the data logger powers up and deviation alarms are blocked when the alarm's High Set Point or Low Set Point is changed.
- *Off*: alarms are not blocked.
- *Startup*: alarms are blocked when the data logger powers up.

Display

Provides the ability to display alarm activity to the user interface (UI).

Options:

- *On*: when an alarm is active will cause the data logger status bar on the UI to flash yellow.
- *Off*: when an alarm is active there will be no indication on the UI.

Logic

Set which state (on or off) of the alarm function's transmitter indicates there is an alarm.

Options:

- *Close on Alarm*: the alarm function's transmitter is off when there is no alarm and on when there is an alarm.
- *Open on Alarm*: the alarm function's transmitter is on when there is no alarm and off when there is an alarm.

Delay Time

Set a length of time, in seconds, that an alarm condition must be present before the alarm state and output are triggered. This setting determines the minimum time that the value at IN must be continuously above the High Set Point or below the Low Set Point before the alarm state and alarm function's output indicate an alarm. If the value at IN returns within the normal range before this time, no alarm occurs. This feature can be used to minimize nuisance alarms.

Range: 0 to 9,999 seconds

Low Set Point

Set the process value or temperature that triggers the low process alarm.

Range: -99,999 to 99,999

High Set Point

Set the process value or temperature that triggers the high process alarm.

Range: -99,999 to 99,999

Clear Alarm

Set this parameter to *clear* to reset the alarm state after correcting the condition that caused the alarm.

Options: Ignore, Clear

Silence Alarm

Set this parameter to *silence alarms* to deactivate the output after the alarm occurs.

Options: Ignore, Silence Alarms

Deviation Alarm

A Deviation Alarm's transmitter becomes active when the receiver (IN) rises above CTR (center) by more than the High Set Point or drops below CTR by more than the Low Set Point. The alarm conditions define a deviation window relative to CTR. CTR is typically connected to a set point so that when it changes, the deviation alarm window moves with it. The alarm's behavior can be further customized with Logic, Latching, Blocking, Silencing and Delay Time parameters.

Signals

Direction	Label	Type	Function
Receivers	IN	Analog	Monitored for alarm conditions
	CTR	Analog	Defines the center value relative to which the alarms are evaluated
	SIL	Digital	On silences the alarm (see Silencing)
	CLR	Digital	On clears the alarm if the condition that caused it no longer exists (See Latching)
	OFF	Digital	On makes the function act as if Type was set to off
Transmitter	- - -	Digital	Indicates the alarm state (see Logic)

Name

Uniquely identify this FB using up to 20 alphanumeric characters.

Type

To monitor an analog signal for alarm conditions relative to another signal, set Type to *Deviation Alarm*.

Sides

Select whether the receiver (IN) is monitored for high, low or both high and low alarms.

Options:

- *Both*: IN is monitored for high, low or both high and low alarms.
- *High*: IN is monitored for a high alarm only. The low alarm is not monitored.
- *Low*: IN is monitored for a low alarm only. The high alarm is not monitored.

Hysteresis

Set how far the process must return into the normal range before the alarm can be cleared. Hysteresis defines how far below the point at which a high alarm occurs the signal must drop before a high alarm can be cleared and how far above the point at which a low alarm occurs the signal must rise before a low alarm can be cleared.

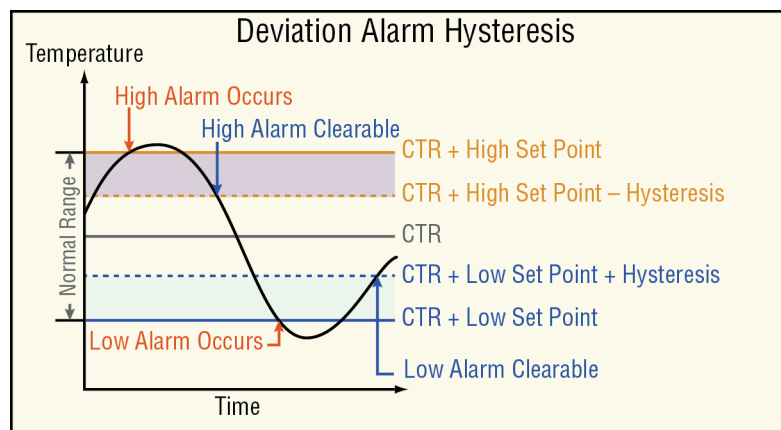

Range: 1 to 9,999 °F or units
2 to 5,555 °C

Silencing

Set whether or not the output can be returned to the non-alarm state (*silenced*) before the input returns to the normal range. Silencing an alarm returns the alarm's output to its inactive state without requiring the alarm state to be cleared. Once the alarm is silenced, the output remains inactive until the alarm is cleared and the alarm condition reoccurs.

Options:

- *Yes*: alarm can be silenced by connecting a digital signal to SIL or by using the Silence Alarm parameter
- *No*: alarm cannot be silenced. After an alarm occurs, the function's output returns to its non-alarm state only when the alarm is cleared

Latching

Select whether an alarm state is maintained (latched) or clears automatically when the process value returns to an acceptable level.

Options:

- *Latching*: alarm remains active until the condition that caused it no longer exists and the alarm is reset by the CLR receiver or the Clear Alarm parameter.
- *Non-latching*: alarm clears automatically once the condition that caused it no longer exists.

Blocking

Alarm blocking allows a system to warm-up after being powered up or to be adjusted without experiencing nuisance alarms. Set alarm blocking to prevent alarms before IN has first come within the normal operating range.

Options:

- *Both*: alarms are blocked when the data logger powers up and deviation alarms are blocked when the alarm's High Set Point or Low Set Point is changed.
- *Off*: alarms are not blocked.
- *Set Point*: deviation alarms are blocked when the alarm's High Set Point or Low Set Point is changed.
- *Startup*: alarms are blocked when the data logger powers up.

Display

Provides the ability to display alarm activity to the user interface (UI).

Options:

- *On*: when an alarm is active will cause the data logger status bar on the UI to flash yellow.
- *Off*: when an alarm is active there will be no indication on the UI.

Logic

Set which state (on or off) of the alarm function's transmitter indicates there is an alarm.

Options:

- *Close on Alarm*: the alarm function's transmitter is off when there is no alarm and on when there is an alarm.
- *Open on Alarm*: the alarm function's transmitter is on when there is no alarm and off when there is an alarm.

Delay Time

Set a length of time, in seconds, that an alarm condition must be present before the alarm state and output are triggered. This setting determines the minimum time that the value at IN must be continuously above CTR by more than the high alarm set point or below CTR by more than the low alarm set point before the alarm state and alarm function's output indicate an alarm. If the value at IN returns within the normal range before this time, no alarm occurs. This feature can be used to minimize nuisance alarms.

Range: 0 to 9,999 seconds

Low Set Point

Set how far the value at IN must drop below CTR to trigger a low deviation alarm. The low deviation alarm occurs when the value at IN is below the center's value (CTR) plus this parameter's setting. A negative value for Low Set Point sets the alarm condition below the center and a positive value sets the alarm condition above the center.

Range: -99,999 to 99,999

High Set Point

Set how far the value at IN must rise above CTR to trigger a high deviation alarm. The high deviation alarm occurs when the value at IN is above the center's value (CTR) plus this parameter's setting. A negative value for High Set Point sets the alarm condition below the center and a positive value sets the alarm condition above the center.

Range: -99,999 to 99,999

Clear Alarm

Set this parameter to *clear* to reset the alarm state after correcting the condition that caused the alarm.

Options: Ignore, Clear

Silence Alarm

Set this parameter to *silence alarms* to deactivate the output after the alarm occurs.

Options: *Ignore*, *Silence Alarms*

Error Handling Rules

When the alarm's receiver (IN) has an error the alarm is triggered. The Alarm function never generates an error and the output's error status is always None.

Error Condition	Result
Input has an error	The Alarm State indicates there is an error and the output is active.

Analog Outputs

Use this block to operate an external device that takes an analog or process signal such as 4 to 20 mADC or 0 to 10 VDC.

These FBs are found on the canvas in the Function Block Diagram editor. The number of these FBs available depends on the number of flex modules with analog outputs installed in the data logger.

These FBs can be used to operate a control element such as a proportional valve based on the output of a retransmit a signal proportional to a process value or set point to another instrument such as a chart recorder. The illustrations below show examples of these two uses. For a *power output* to a 4 to 20 mADC output, the value received is scaled proportionally from the 0 to 100% input range to the 4 to 20 output scale. When the input is 25%, the output is 8 mADC.

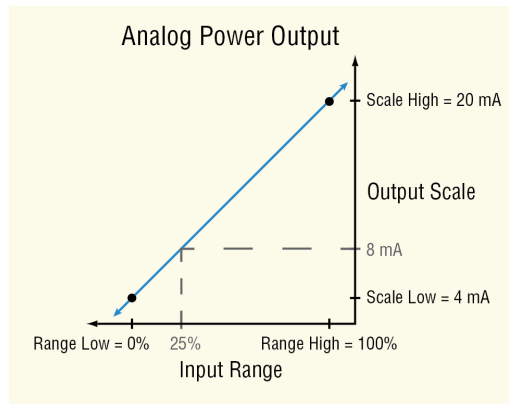

For a *retransmit output* to a 0 to 10 VDC output, the value received at input In is scaled proportionally from the 50 to 250° input range to the 0 to 10 output scale. When the input is 100°, the output is 2.5 VDC.

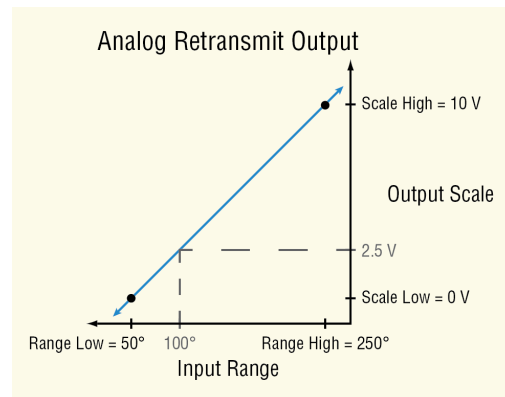

Note that the settings of the Range Low and Range High settings do not limit the physical output signal. The physical output is set according to the line defined by the range and scale parameters and is limited by the range of values input to the function and the electrical limitations of the hardware. If the input signal is limited to 0 to 100%, the Range Low is set to 0%, and the Range High is set to 100%, the output can be limited by setting the Scale Low and Scale High parameters to the desired minimum and maximum signal levels.

Signals

Direction	Label	Type	Function
Receiver	- - - -	Analog % or Digital	Drives the physical output associated with the block

Name

Uniquely identify this FB using up to 20 alphanumeric characters.

Output Type

Set whether the physical analog output supplies a voltage or current signal.

Options:

- *Volts*: the output supplies a voltage signal
- *Milliamps*: the output supplies a current signal

Scale Low

Set the desired value for the output in electrical units (mA DC or VDC) when the input to the block equals the Range Low setting. Scale Low and Range Low are the coordinates of a point on the line that relates the input to the scaled output.

Consult the hardware specifications for the signal range supported by the specific hardware.

Range: -100.0 to 100.0 mA DC (typically 0 mA DC or 4 mA DC)
-100.0 to 100.0 VDC (typically 0 VDC)

Scale High

Set the desired value for the output in electrical units (mA DC or VDC) when the input to the block equals the Range High setting. Scale High and Range High are the coordinates of a point on the line that relates the input to the scaled output.

Consult the hardware specifications for the signal range supported by the specific hardware.

Range: -100.0 to 100.0 mA DC (typically 20 mA DC)
-100.0 to 100.0 VDC (typically 1, 5, or 10 VDC)

Range Low

Set the value for the input to the block at which the Scale Low setting is the desired output value. When using the output to retransmit an analog signal, this is typically the low end of the range being retransmitted. When using the output for control, this is typically 0%.

Range: -99,999.000 to 99,999.000

Range High

Set the value for the input to the block at which the Scale High setting is the desired output value. When using the output to retransmit an analog signal, this is typically the high end of the range being retransmitted. When using the output for control, this is typically 100%.

Range: -99,999.000 to 99,999.000

Calibration Offset

Set an offset value for a process output.

Range: -1,999.000 to 9,999.000°F

-1,110.555 to 5,555.000°C

-99,999 to 99,999 units

Compare

Use a compare block to set an output based on comparing two analog signals.

This block is found in the Function Block Diagram editor's Library when working with a data logger that offers the Compare block. The number of these blocks that are available is shown within the parenthesis.

Choose the type of comparison with the *Function* parameter. These options for the Function parameter are described in detail in the following sections:

Off: the block's output is off

Greater Than: the block's output is on when input A is greater than input B

Less Than: the block's output is on when input A is less than input B

Equal To: the block's output is on when the two inputs are equal

Not Equal To: the block's output is on when the two inputs are not equal to each other

Greater or Equal: the block's output is on when input A is greater than or equal input B

Less or Equal: the block's output is on when input A is less than or equal to input B

Off

When the Compare block's function is set to Off, the output (T/F) is off.

Greater Than

The output (T/F) is on when receiver A is greater than B.

Signals

Direction	Label	Type	Function
Receivers	A	Analog	Signal to be compared to B
	B	Analog	Signal to be compared to A
Transmitter	T/F	Digital	On when A is greater than B, otherwise off

Function

To test if A is greater than B, set Function to *Greater Than*.

Error Handling

When an error exists on any receiver, the function cannot definitively determine the result of the comparison and an error will be generated. Use Error Handling to select the output's value.

Options:

- *True Good*: output true (on) and no output error
- *True Bad*: output true (on) and output error
- *False Good*: output false (off) and no output error
- *False Bad*: output false (off) and output error

Less Than

The output (T/F) is on when receiver A is less than B.

Signals

Direction	Label	Type	Function
Receiver	A	Analog	Signal to be compared to B
	B	Analog	Signal to be compared to A
Transmitter	T/F	Digital	On when A is less than B, otherwise off

Function

To test if A is less than B, set Function to *Less Than*.

Error Handling

When an error exists on any receiver, the function cannot definitively determine the result of the comparison and an error will be generated. Use Error Handling to select the output's value and error status.

Options:

- *True Good*: outputs value is true (on) with no error
- *True Bad*: outputs value is true (on) and has an error
- *False Good*: outputs value is false (off) with no error
- *False Bad*: outputs value is false (off) and has an error

Equal To

The output (T/F) is on when receivers A and B are equal to each other. See Tolerance.

Signals

Direction	Label	Type	Function
Receiver	A	Analog	Signal to be compared to B
	B	Analog	Signal to be compared to A
Transmitter	T/F	Digital	On when A and B are equal and within tolerance, otherwise off

Function

To test if A and B are equal to each other, set Function to *Equal To*.

Tolerance

Use Tolerance to set how precisely A and B must match to be considered equal. For example, with Tolerance set to 2, the values 10 and 12 are considered equal, but 10 and 12.5 are not.

Range: 0 to 99,999

Error Handling

When an error exists on any receiver, the function cannot definitively determine the result of the comparison and an error will be generated. Use Error Handling to select the output's value and error status.

Options:

- *True Good*: outputs value is true (on) with no error
- *True Bad*: outputs value is true (on) and has an error
- *False Good*: outputs value is false (off) with no error
- *False Bad*: outputs value is false (off) and has an error

Not Equal To

The output (T/F) is on when receivers A and B are not equal to each other. See Tolerance.

Signals

Direction	Label	Type	Function
Receiver	A	Analog	Signal to be compared to B
	B	Analog	Signal to be compared to A
Transmitter	T/F	Digital	On when A and B are not equal and within tolerance, otherwise off

Function

To test if A and B are not equal to each other, set Function to Not *Equal To*.

Tolerance

Use Tolerance to set how precisely A and B must match to be considered equal. For example, with Tolerance set to 2, the values 10 and 12 are considered equal, but 10 and 12.5 are not.

Range: 0 to 99,999

Error Handling

When an error exists on any receiver, the function cannot definitively determine the result of the comparison and an error will be generated. Use Error Handling to select the output's value and error status.

Options:

- *True Good*: outputs value is true (on) with no error
- *True Bad*: outputs value is true (on) and has an error
- *False Good*: outputs value is false (off) with no error
- *False Bad*: outputs value is false (off) and has an error

Greater or Equal

The output (T/F) is on when receiver A is greater than or equal to B. See Tolerance.

Signals

Direction	Label	Type	Function
Receiver	A	Analog	Signal to be compared to B
	B	Analog	Signal to be compared to A
Transmitter	T/F	Digital	On when A is greater than or equal to B and within tolerance, otherwise off

Function

To test if A is greater than or equal to B, set Function to *Greater or Equal*.

Tolerance

Use Tolerance to set how precisely A and B must match to be considered equal. For example, with Tolerance set to 2, the values 10 and 12 are considered equal, but 10 and 12.5 are not.

Range: 0 to 99,999

Error Handling

When an error exists on any receiver, the function cannot definitively determine the result of the comparison and an error will be generated. Use Error Handling to select the output's value and error status.

Options:

- *True Good*: outputs value is true (on) with no error
- *True Bad*: outputs value is true (on) and has an error
- *False Good*: outputs value is false (off) with no error
- *False Bad*: outputs value is false (off) and has an error

Less or Equal

The output (T/F) is on when receiver A is less than or equal to B. See Tolerance below.

Signals

Direction	Label	Type	Function
Receiver	A	Analog	Signal to be compared to B
	B	Analog	Signal to be compared to A
Transmitter	T/F	Digital	On when A is less than or equal to B and within tolerance, otherwise off

Function

To test if A is less than or equal to B, set Function to *Less or Equal*.

Tolerance

Use Tolerance to set how precisely A and B must match to be considered equal. For example, with Tolerance set to 2, the values 10 and 12 are considered equal, but 10 and 12.5 are not.

Range: 0 to 99,999

Error Handling

When an error exists on any receiver the function cannot definitively determine the result of the comparison and an error will be generated. Use Error Handling to select the output's value and error status.

Options:

- *True Good*: outputs value is true (on) with no error
- *True Bad*: outputs value is true (on) and has an error
- *False Good*: outputs value is false (off) with no error
- *False Bad*: outputs value is false (off) and has an error

Compare Errors

Error Condition	Result
Either or both inputs are in an error state.	The output will be set according to the selections made for error handling described above.

Counter

Use a counter to set an output when a digital signal's state changes a given number of times. A counter can count up or down from the load value. Its output turns on when the count equals the target value. The output turns off and the count is set equal to the load value when the reset signal is received.

This block is found in the Function Block Diagram editor's Library when working with a data logger that offers the Counter block. The number of these blocks that are available is shown within the parenthesis.

Choose whether the counter counts up or down with the Function parameter. These options for Function are described in detail in the following sections:

Up: Count is incremented by the CNT input.

Down: Count is decremented by the CNT input.

UP

This function counts up from the load value. The count is incremented by applying a signal to CNT. OUT turns on when the count equals the target value. OUT turns off and the count is set equal to the load value by RST (reset).

Signals

Direction	Label	Type	Function
Receivers	CNT	Digital	Increments the count
	RST	Digital	Resets the count to the load value
Transmitters	OUT	Digital	On when the count equals the target value

Function

To increment the count with CNT, set Function to Up.

Target Value

Set the count value at which OUT turns on.

Range: 0 to 9,999

Load Value

Set the value to which the Count parameter is set each time the data logger is powered up and whenever the counter is reset by RST.

Range: 0 to 9,999

Latching

Select the behavior for the output when Count exceeds the Target Value.

Options:

- *Yes*: output is latched on once the count reaches the target value and turns off only when the counter is reset
- *No*: the output is on only when the count equals the target value. Additional counts cause the output to turn off

Count Active Level

Set which state changes at CNT are counted.

Options:

- *Both*: the count increments when CNT changes from on to off and when it changes from off to on
- *High*: the count increments only when CNT changes from off to on
- *Low*: the count increments only when CNT changes from on to off

Reset Active Level

Set which state change at RST sets Count equal to Load Value.

Options:

- *High*: off to on
- *Low*: on to off

Count

Indicates the current count.

Range: 0 to 9,999

Note:

The count is not retained through a power loss; it is set equal to the Load Value upon power up.

Note:

The count value rolls over at the ends of its range. If the count is incremented at 9,999 it indicates 0 and additional increments count up from there

Down

This function counts down from the load value. The count is decremented by applying a signal to CNT. OUT turns on when the count equals the target value. OUT turns off and the count is set equal to the load value by RST (reset).

Signals

Direction	Label	Type	Function
Receivers	CNT	Digital	Decrements the count
	RST	Digital	Resets the count to the load value
Transmitters	OUT	Digital	On when the count equals the target value

Function

To decrement the count with the CNT, set Function to Down.

Target Value

Set the count value at which OUT turns on.

Range: 0 to 9,999

Load Value

Set the value to which the Count parameter is set each time the data logger is powered up and whenever the counter is reset by RST.

Range: 0 to 9,999

Latching

Select the behavior for the output when Count exceeds the Target Value.

Options:

- *Yes*: output is latched on once the count reaches the target value and turns off only when the counter is reset
- *No*: the output is on only when the count equals the target value. Additional counts cause the output to turn off

Count Active Level

Set which state changes at CNT are counted.

Options:

- *Both*: the count decrements when CNT changes from on to off and when it changes from off to on
- *High*: the count decrements only when CNT changes from off to on
- *Low*: the count decrements only when CNT changes from on to off

Reset Active Level

Set which state change at RST sets Count equal to Load Value.

Options:

- *High*: off to on
- *Low*: on to off

Count

Indicates the current count.

Range: 0 to 9,999

Note:

The count is not retained through a power loss; it is set equal to the Load Value upon power up.

Note:

The count value rolls over at the ends of its range. If the count is incremented at 9,999 it indicates 0 and additional increments count up from there

Counter Errors

If the CNT input has an error, the count will not increment or decrement. If the RST input has an error, the count cannot be reset. An error on one input does not impact the operation of the other input and its associated function. Regardless of errors on the inputs, the value of the output is set according to the count and target values and the output never has an error. The counter function never generates or propagates an error.

Error Condition	Result
- CNT has an error - RST has no error	The count does not increment or decrement but can be reset.
- CNT has no error - RST has an error	The count increments or decrements normally but cannot be reset.
Both inputs have errors	The count does not increment or decrement and cannot be reset.

Digital Inputs/Outputs (I/O)

Use a digital input/output block to connect a field I/O device's signal to the application. This FB can be configured as either a digital input that can be triggered by an external device or a digital output that can switch an external device. As an output, the block can accept either a digital (on/off) signal or an analog percentage signal.

The block is configured as an input or output with the Direction parameter. These options for the Direction parameter setting are described in detail in the following sections:

Input Dry Contact: the block's output is on when a switch closure is detected by the corresponding input on the flex module.

Output: the block drives the corresponding output on the flex module according to the signal connected to the block's input.

Input Voltage: the block's output is on when a sufficient voltage is detected by the corresponding input on the flex module.

Input Dry Contact

Use this function to integrate a signal from a switch or contact in a field I/O device into the application. For example, use a dry contact to detect the state of a door switch connected to a digital I/O point on the data logger.

This FB is found on the canvas of the FB diagram. The number of these FBs that are available depends on the number of digital I/O flex modules installed and configured as dry contact inputs.

Signals

Direction	Label	Type	Function
Transmitter	- - - -	Digital	Transmitter is inactive (off) when measured resistance is greater than 100KΩ and active (on) when less than 50Ω

Name

Uniquely identify this FB using up to 20 alphanumeric characters.

Direction

To configure the I/O point to detect a contact closure, set Direction to Input Dry Contact.

Output

Use this function to switch an external device. This FB is found on the canvas of the FB diagram. The number of these FBs that are available depends on the number of digital I/O flex modules installed and configured as outputs.

Signals

Direction	Label	Type	Function
Receiver	- - - -	Analog (%) or Digital	Off or 0%: the output is off. Between 0% and 100%: the output switches according to the Time Base Type setting. On or 100%: the output is on.

Name

Uniquely identify this FB using up to 20 alphanumeric characters.

Direction

To configure the I/O point to drive the physical output, set Direction to Output.

Time Base Type

Choose the method used to operate the output when the input is an analog percentage. With either of the methods, the output switches off and on such that the average amount of time the output is on equals the desired percentage.

Note:

The type of field device connected to the output determines how frequently it can be switched.

Options:

- **Fixed Time Base:** the percent output power is converted to a duty cycle over the Fixed Time Base. For example, if the Fixed Time Base is ten seconds and 75% power is called for, the output turns on for 7.5 seconds and off for 2.5 seconds, and repeats as illustrated below. This is appropriate for mechanical relays.

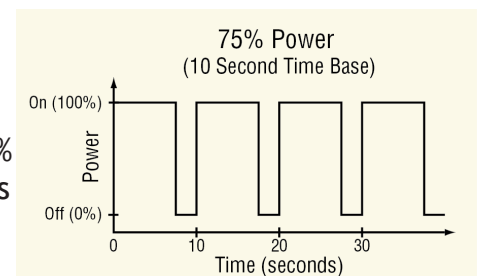

- **Variable Time Base:** the output switches as often as every three ac line cycles. For example, when 66% power is called for, the output is on for six ac cycles and off for

three, and when 50% power is called for, the output is on for three ac cycles and off for three. This method is appropriate for Solid-State Relays (SSR) or Silicon Controlled Rectifier (SCR) power data loggers. Do not use a variable time base output to control electromechanical relays, mercury displacement relays, inductive loads or heaters with unusual resistance characteristics.

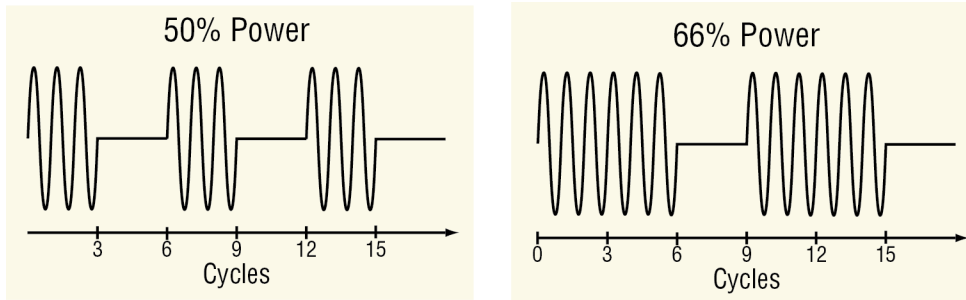

Fixed Time Base

Set the duration of one on-off cycle. This applies when the Time Base Type is set to Fixed Time Base.

Range: 0.1 to 60.0 seconds

Low Power Scale

Set the minimum power level for the output. When the input equals 0% (off), the output is equal to the value set here. When the input equals 100% (on), the output is equal to the value set with High Power Scale. Values between 0% and 100% are scaled proportionally. See the illustration to the right.

Range: 0.0 to 100.0%

High Power Scale

Set the maximum power level for the output. When the input equals 100% (on), the output is equal to the value set here. When the input equals 0% (off), the output is equal to the value set with Output Low Power Scale. Values between 0% and 100% are scaled proportionally. See the illustration to the right.

Range: 0.0 to 100.0%

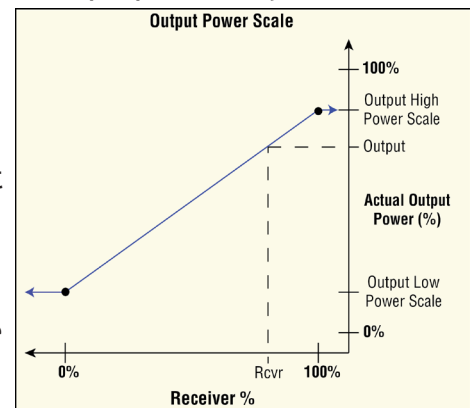

Input Voltage

Use this function to integrate a signal from a field I/O device that provides a high or low voltage signal indicating its state. This FB is found on the canvas of the FB diagram. The number of these FBs that are available depends on the number of digital I/O flex modules installed and configured as voltage inputs.

Signals

Direction	Label	Type	Function
Transmitter	- - - -	Digital	Transmitter is inactive (off) when measured voltage is less than 2V and active (on) when greater than 3V

Name

Uniquely identify this FB using up to 20 alphanumeric characters.

Direction

To configure the I/O point to detect a voltage level as a digital input, set Direction to *Input Voltage*.

Digital Outputs

Use a digital output block to drive an external device. Output blocks can accept either a digital (on/off) signal or an analog percentage signal. The following FBs are discussed in this section:

SSR and Switched DC/Open Collector: drive outputs on flex modules that are appropriate for loads that can be switched frequently.

Electromechanical and NO-ARC Relays: drive outputs on flex modules that are appropriate for loads that need not be switched frequently.

Solid-State Relay - Switched DC/Open Collector

These blocks are found on the canvas in the Function Block Diagram editor. The number of these blocks available depends on the number of solid state relays, switched DC outputs and open collector outputs on the flex modules installed in the data logger.

Signals

Direction	Label	Type	Function
Receiver	- - - -	Analog % or Digital	Off or 0%: the output is off. Between 0% and 100%: the output switches according to the Time Base Type setting. On or 100%: the output is on.

Name

Uniquely identify this FB using up to 20 alphanumeric characters.

Time Base Type

Choose the method used to operate the output when the input is an analog percentage. With either of the methods the output switches off and on such that the average amount of time the output is on equals the desired percentage.

Note:

The type of field device connected to the output determines how frequently it can be switched.

Options:

- **Fixed Time Base:** the percent output power is converted to a duty cycle over the Fixed Time Base. For example, if the Fixed Time Base is ten seconds and 75% power is called for, the output turns on for 7.5 seconds and off for 2.5 seconds, and repeats as illustrated below. This is appropriate for mechanical relays.

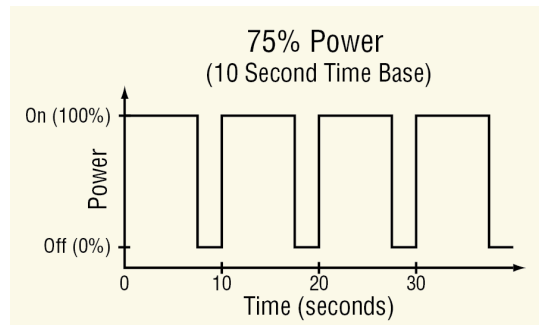

- **Variable Time Base:** the output switches as often as every three ac line cycles. For example, when 66% power is called for, the output is on for six ac cycles and off for three, and when 50% power is called for, the output is on for three ac cycles and off for three. This method is appropriate for solid-state relays but not for electromechanical relays, mercury displacement relays, inductive loads or heaters with unusual resistance characteristics.

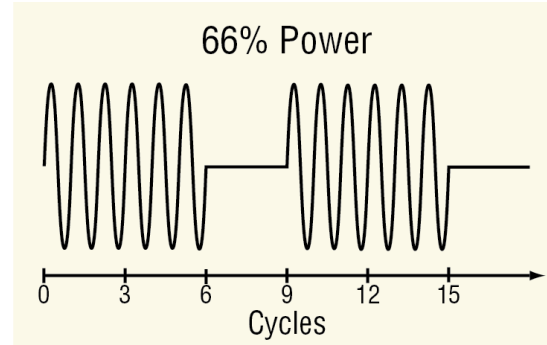
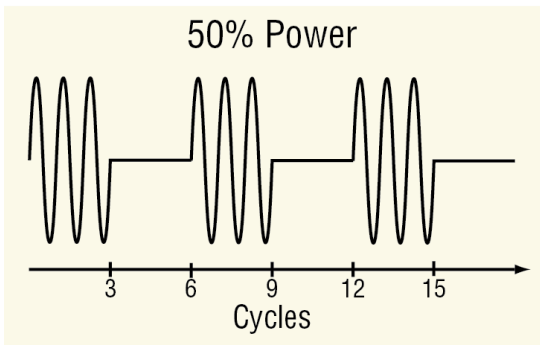

Fixed Time Base

Set the duration of one on-off cycle. This applies when the Time Base Type is set to Fixed Time Base.

Range: 0.1 to 60.0 seconds

Low Power Scale

Set the minimum power level for the output. When the input equals 0% (off), the output is equal to the value set here. When the input equals 100% (on), the output is equal to the value set with High Power Scale. Values between 0% and 100% are scaled proportionally. See the illustration to the right.

Range: 0.0 to 100.0%

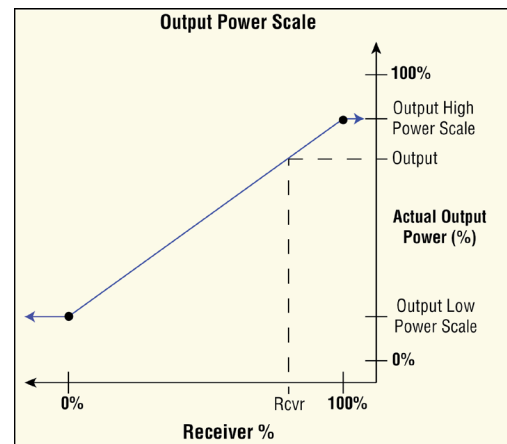

High Power Scale

Set the maximum power level for the output. When the input (Rcvr) is 100% (on), the output is equal to the value set here. When the input is 0% (off), the output is equal to the value set with Low Power Scale. Values between 0% and 100% are scaled proportionally.

Range: 0.0 to 100.0%

Electromechanical Relays

Use this block to drive a digital output in the data logger to switch an external device. These blocks are found on the canvas in the Function Block Diagram editor. The number of these blocks available depends on the number of electromechanical relays on the flex modules installed in the data logger.

Signals

Direction	Label	Type	Function
Receiver	- - - -	Analog % or Digital	Off or 0%: the output is off. Between 0% and 100%: the output switches according to the Fixed Time Base setting. On or 100%: the output is on.

Name

Uniquely identify this FB using up to 20 alphanumeric characters.

Fixed Time Base

Set the duration of one on-off cycle. A percent output power is converted to a duty cycle over the Fixed Time Base. For example, if the Fixed Time Base is ten seconds and 75% power is called for, the output turns on for 7.5 seconds and off for 2.5 seconds, and repeats as illustrated below. This is appropriate for mechanical relays.

Range: 5.0 to 60.0 seconds

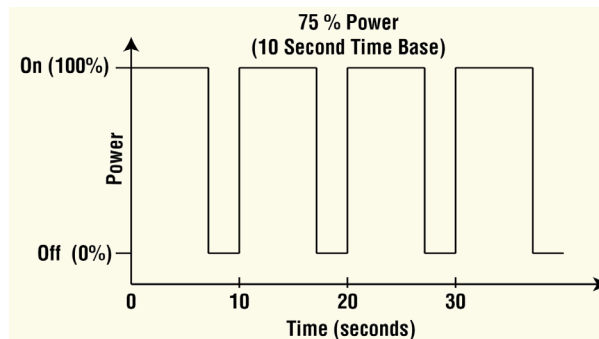

Low Power Scale

Set the minimum power level for the output. When the input equals 0% (off), the output is equal to the value set here. When the input equals 100% (on), the output is equal to the value set with High Power Scale. Values between 0% and 100% are scaled proportionally. See the illustration below.

Range: 0.0 to 100.0%

High Power Scale

Set the maximum power level for the output. When the input is 100% (on), the output is equal to the value set here. When the input is 0% (off), the output is equal to the value set with Low Power Scale. Values between 0% and 100% are scaled proportionally.

Range: 0.0 to 100.0%

Key

Use a key to allow an output to be operated by a soft key on the data logger user interface. When a key is connected to an output block, that output appears in the list of options for soft keys, for example on the output widget.

Choose how the key works with the Function parameter. These options for Function are described in detail in the following sections:

Momentary: the transmitted signal is on while the soft key is being pressed.

Toggle: the transmitted signal changes state each time the soft key is pressed.

On Pulse: the block transmits an on signal of a specified duration when it is pressed.

This function is found in the Function Block Diagram editor's Library.

The number of these blocks available to be added to the diagram is shown within the parenthesis.

Momentary

The transmitted signal is on while the soft key is being pressed.

Signals

Direction	Label	Type	Function
Transmitter	- - - -	Digital	On while the soft key is held and off while the soft key is not being pressed

Name

Uniquely identify this FB using up to 20 alphanumeric characters.

Function

To configure key to produce an on output only while it is held, set Function to *Momentary*.

Toggle

The transmitted signal changes state each time the soft key is pressed.

Signals

Direction	Label	Type	Function
Transmitter	- - - -	Digital	Initially off. Alternates between on and off with each press of the soft key.

Name

Uniquely identify this FB using up to 20 alphanumeric characters.

Function

To configure the key to change state each time the soft key is pressed, set Function to *Toggle*.

On Pulse

The transmitted signal is on for a user set period of time each time the soft key is pressed.

Signals

Direction	Label	Type	Function
Transmitter	- - - -	Digital	On for the specified duration after the soft key is pressed, otherwise off. Off when the pulse is canceled by a second key press.

Name

Uniquely identify this FB using up to 20 alphanumeric characters.

Function

To configure the key to produce a pulse of a specified duration when it is pressed, set Function to On Pulse.

Time

Set the length of time the output should remain on after the key is pressed.

Range: 0 to 99,999 seconds

Linearization

Use a linearize block to scale an analog signal according to a 10-point scaling curve and an offset. This block is found in the Function Block Diagram editor's Library when working with a data logger that offers the Linearize block. Within the Library, the number of these blocks available is shown in parenthesis.

Choose the type of scaling curve with the Function parameter. These options for the Function parameter are described in detail in the following sections:

Off: The output is equal to the input plus the offset.

Interpolated: The output is equal to the scaled input plus the offset. The scaling curve is composed of line-segments connecting ten points. The output changes gradually as the input increases or decreases.

Stepped: The output is equal to the scaled input plus the offset. The scaling curve is composed of horizontal line segments extending from each point connected vertically to the subsequent point. The output is constant as the input increases until the input reaches the next step at which point the output changes abruptly to the new value.

Off

When the Linearize block's function is set to Off, the output is off.

Interpolated

The output is equal to the scaled input plus the offset. The scaling curve is composed of line-segments connecting the ten points in numerical order as shown in the illustration below. The output changes gradually as the input increases or decreases.

The points of the scaling curve must be in ascending order of the input value such that Input Point 1 is the lowest value to be scaled, Input Point 2 is the next higher value and so on. If fewer than ten points are required, set the unused input points equal to the last point. For example, if the curve requires eight points, use points one to eight for the curve and set points nine and ten equal to point eight.

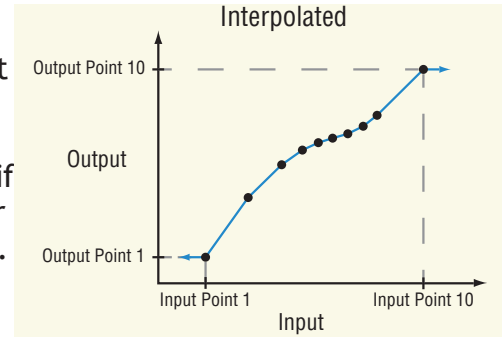

Signals

Direction	Label	Type	Function
Receiver	- - -	Analog	Signal to be scaled
Transmitter	- - -	Analog	Scaled signal with offset applied

Function

To scale the input according to a curve made up of interpolated line segments defined by ten points, set Function to *Interpolate*.

Units

Set the units of the output value.

Options:

- Source: the output has the same units as the signal connected to the top receiver.
- None: the output is a pure number without units.
- Absolute Temperature: the output is a temperature on the Celsius or Fahrenheit scale. For example, 33° F as an absolute temperature is one degree above the freezing point of water. An absolute temperature can be used as a set point or compared with other temperatures to determine which is hotter or colder.
- Relative Temperature: the output is a relative number of degrees, not an absolute temperature. For example, the difference between the two measured temperatures, 120° C and 100° C is 20 degrees, but it is not the temperature 20° C. A relative temperature is appropriate for use as a calibration offset or a deviation alarm set point.
- Power: the output is a percentage with 100% representing full power and 0% representing no power.
- Process: the output is in units of measure other than degrees Fahrenheit, degrees Celsius or relative humidity.
- Relative Humidity: the output is a measurement of percent relative humidity (%RH).

Input Point 1

Set the minimum input value to be scaled. This value and all lesser values are scaled to Output Point 1.

Range: -99,999.000 to 99,999.000

Output Point 1

Set the value to which the input is scaled when the input is equal to or less than Input Point 1.

Range: -99,999.000 to 99,999.000

Input Point 2

Set the second lowest input value on the scaling curve. This value is scaled to Output Point 2.

Range: -99,999.000 to 99,999.000

Output Point 2

Set the value to which the input is scaled when the input is equal to Input Point 2.

Range: -99,999.000 to 99,999.000

Input Point 3

Set the third lowest input value on the scaling curve. This value is scaled to Output Point 3.

Range: -99,999.000 to 99,999.000

Output Point 3

Set the value to which the input is scaled when the input is equal to Input Point 3.

Range: -99,999.000 to 99,999.000

Input Point 4

Set the fourth lowest input value on the scaling curve. This value is scaled to Output Point 4.

Range: -99,999.000 to 99,999.000

Output Point 4

Set the value to which the input is scaled when the input is equal to Input Point 4.

Range: -99,999.000 to 99,999.000

Input Point 5

Set the fifth lowest input value on the scaling curve. This value is scaled to Output Point 5.

Range: -99,999.000 to 99,999.000

Output Point 5

Set the value to which the input is scaled when the input is equal to Input Point 5.

Range: -99,999.000 to 99,999.000

Input Point 6

Set the sixth lowest input value on the scaling curve. This value is scaled to Output Point 6.

Range: -99,999.000 to 99,999.000

Output Point 6

Set the value to which the input is scaled when the input is equal to Input Point 6.

Range: -99,999.000 to 99,999.000

Input Point 7

Set the seventh lowest input value on the scaling curve. This value is scaled to Output Point 7.

Range: -99,999.000 to 99,999.000

Output Point 7

Set the value to which the input is scaled when the input is equal to Input Point 7.

Range: -99,999.000 to 99,999.000

Input Point 8

Set the eighth lowest input value on the scaling curve. This value is scaled to Output Point 8.

Range: -99,999.000 to 99,999.000

Output Point 8

Set the value to which the input is scaled when the input is equal to Input Point 8.

Range: -99,999.000 to 99,999.000

Input Point 9

Set the ninth lowest input value on the scaling curve. This value is scaled to Output Point 9.

Range: -99,999.000 to 99,999.000

Output Point 9

Set the value to which the input is scaled when the input is equal to Input Point 9.

Range: -99,999.000 to 99,999.000

Input Point 10

Set the tenth lowest input value on the scaling curve. This value is scaled to Output Point 10.

Range: -99,999.000 to 99,999.000

Output Point 10

Set the value to which the input is scaled when the input is equal to Input Point 10.

Range: -99,999.000 to 99,999.000

Offset

Set an adjustment to the final value, added after scaling.

Range: -99,999.000 to 99,999.000

Stepped

The output is equal to the scaled input plus the offset. The scaling curve is composed of horizontal segments extending from each point connected vertically to the subsequent point as shown in the illustration below. The output is constant as the input is increased until the input reaches the next point where the output changes abruptly to the next value.

Signals

Direction	Label	Type	Function
Receiver	- - - -	Analog	Signal to be scaled
Transmitter	- - - -	Analog	Scaled signal with offset applied

Function

To scale the input values to up to ten specific values, set Function to *Stepped*.

Units

Set the units of the output value.

Options:

- *Source*: the output has the same units as the signal connected to the top receiver.
- *None*: the output is a pure number without units.
- *Absolute Temperature*: the output is a temperature on the Celsius or Fahrenheit scale. For example, 33° F as an absolute temperature is one degree above the freezing point of water. An absolute temperature can be used as a set point or compared with other temperatures to determine which is hotter or colder.
- *Relative Temperature*: the output is a relative number of degrees, not an absolute temperature. For example, the difference between the two measured temperatures, 120° C and 100° C is 20 degrees, but it is not the temperature 20° C. A relative temperature is appropriate for use as a calibration offset or a deviation alarm set point.
- *Power*: the output is a percentage with 100% representing full power and 0% representing no power.
- *Process*: the output is in units of measure other than degrees Fahrenheit, degrees Celsius or relative humidity.
- *Relative Humidity*: the output is a measurement of percent relative humidity (%RH).

Input Point 1

Set the minimum input value to be scaled. Input values less than Input Point 2 are scaled to Output Point 1.

Range: -99,999.000 to 99,999.000

Output Point 1

Set the value to which the input is scaled when the input is less than Input Point 2.

Range: -99,999.000 to 99,999.000

Input Point 2

Set the second lowest input value to be scaled. Input values equal to or greater than this, but less than Input Point 3 are scaled to Output Point 2.

Range: -99,999.000 to 99,999.000

Output Point 2

Set the value to which the input is scaled when the input is greater than or equal to Input Point 2 and less than Input Point 3.

Range: -99,999.000 to 99,999.000

Input Point 3

Set the third lowest input value to be scaled. Input values equal to or greater than this, but less than Input Point 4 are scaled to Output Point 3.

Range: -99,999.000 to 99,999.000

Output Point 3

Set the value to which the input is scaled when the input is greater than or equal to Input Point 3 and less than Input Point 4.

Range: -99,999.000 to 99,999.000

Input Point 4

Set the fourth lowest input value to be scaled. Input values equal to or greater than this, but less than Input Point 5 are scaled to Output Point 4.

Range: -99,999.000 to 99,999.000

Output Point 4

Set the value to which the input is scaled when the input is greater than or equal to Input Point 4 and less than Input Point 5.

Range: -99,999.000 to 99,999.000

Input Point 5

Set the fifth lowest input value to be scaled. Input values equal to or greater than this, but less than Input Point 6 are scaled to Output Point 5.

Range: -99,999.000 to 99,999.000

Output Point 5

Set the value to which the input is scaled when the input is greater than or equal to Input Point 5 and less than Input Point 6.

Range: -99,999.000 to 99,999.000

Input Point 6

Set the sixth lowest input value to be scaled. Input values equal to or greater than this, but less than Input Point 7 are scaled to Output Point 6.

Range: -99,999.000 to 99,999.000

Output Point 6

Set the value to which the input is scaled when the input is greater than or equal to Input Point 6 and less than Input Point 7.

Range: -99,999.000 to 99,999.000

Input Point 7

Set the seventh lowest input value to be scaled. Input values equal to or greater than this, but less than Input Point 8 are scaled to Output Point 7.

Range: -99,999.000 to 99,999.000

Output Point 7

Set the value to which the input is scaled when the input is greater than or equal to Input Point 7 and less than Input Point 8.

Range: -99,999.000 to 99,999.000

Input Point 8

Set the eighth lowest input value to be scaled. Input values equal to or greater than this, but less than Input Point 9 are scaled to Output Point 8.

Range: -99,999.000 to 99,999.000

Output Point 8

Set the value to which the input is scaled when the input is greater than or equal to Input Point 8 and less than Input Point 9.

Range: -99,999.000 to 99,999.000

Input Point 9

Set the ninth lowest input value to be scaled. Input values equal to or greater than this, but less than Input Point 10 are scaled to Output Point 9.

Range: -99,999.000 to 99,999.000

Output Point 9

Set the value to which the input is scaled when the input is greater than or equal to Input Point 9 and less than Input Point 10.

Range: -99,999.000 to 99,999.000

Input Point 10

Set the tenth lowest input value to be scaled. Input values equal to or greater than this are scaled to Output Point 10.

Range: -99,999.000 to 99,999.000

Output Point 10

Set the value to which the input is scaled when the input is greater than or equal to Input Point 10.

Range: -99,999.000 to 99,999.000

Offset

Set an adjustment to the final value, added after scaling.

Range: -99,999.000 to 99,999.000

Linearization Errors

When the input has an error the signals connected to the output have the same error.

Error Condition	Result
Input has an error	The output propagates the same error.

Logic

Use a logic block to set an output based on one or more digital signals. The logic block performs logic operations on one or more inputs and sets its output based on the result.

This block is found in the Function Block Diagram editor's Library when working with a data logger that offers the Logic block. Within the Library, the number of these blocks available is shown in parenthesis.

Choose the logic operation with the Function parameter. These options for the Function parameter are described in detail in the following sections:

Off: the output is false.

And: If any input is false, the output is false. If all inputs are true, the output is true.

Nand: if any input is false, the output is true. If all inputs are true, the output is false.

Equal To: if all the inputs are false or all the inputs are true, the output is true. Otherwise, the output is false.

Not Equal To: if all the inputs are false or all the inputs are true, the output is false. Otherwise, the output is true.

Or: if any input is true, the output is true. If all inputs are false, the output is false.

Nor: if any input is true, the output is false. If all inputs are false, the output is true.

Latch: when the HOLD input is false, the output follows the IN input. When HOLD is true, the output is held (latched) at the value it had when HOLD became true.

RS Flip Flop: one input sets the output true; the other sets it false.

Off

The output is false (off, 0%).

And

If any input is false (off, 0%), the output is false (off, 0%).
If all inputs are true (on, 100%), the output is true (on, 100%).

Only connected inputs are considered by the logic operation; inputs that are not connected are ignored. The truth table at the right illustrates the outcomes for three inputs.

Inputs	Output
FFF	F
FFT	F
FTF	F
FTT	F
TFF	F
TFT	F
TTF	F
TTT	T
F = False (0%, off) T = True (100%, on)	

Signals

Direction	Label	Type	Function
Receivers	- - - -	Digital	Input to logic function
	- - - -	Digital	Input to logic function
	- - - -	Digital	Input to logic function
	- - - -	Digital	Input to logic function
	- - - -	Digital	Input to logic function
	- - - -	Digital	Input to logic function
	- - - -	Digital	Input to logic function
	- - - -	Digital	Input to logic function
Transmitter	- - - -	Digital	True when all the inputs are true, otherwise false

Function

To detect when all the inputs are true, set Function to *And*.

Error Handling

Use Error Handling to select the output's value and error status when the function cannot definitively determine the result.

Options:

- *True Good*: output's value is true (on) with no error
- *True Bad*: output's value is true (on) and has an error
- *False Good*: output's value is false (off) with no error
- *False Bad*: output's value is false (off) and has an error

Nand

If any input is false (off, 0%), the output is true (on, 100%). If all inputs are true (on, 100%), the output is false (off, 0%).

Only connected inputs are considered by the logic operation; inputs that are not connected are ignored. The truth table at the right illustrates the outcomes for three inputs.

Inputs	Output
FFF	T
FFT	T
FTF	T
FTT	T
TFF	T
TFT	T
TTF	T
TTT	F
F = False (0%, off) T = True (100%, on)	

Signals

Direction	Label	Type	Function
Receivers	- - - -	Digital	Input to logic function
	- - - -	Digital	Input to logic function
	- - - -	Digital	Input to logic function
	- - - -	Digital	Input to logic function
	- - - -	Digital	Input to logic function
	- - - -	Digital	Input to logic function
	- - - -	Digital	Input to logic function
	- - - -	Digital	Input to logic function
Transmitter	- - - -	Digital	True when at least one of the inputs is false, otherwise false

Function

To detect when at least one inputs is false, set Function to *Nand*.

Error Handling

Use Error Handling to select the output's value and error status when the function cannot definitively determine the result.

Options:

- *True Good*: output's value is true (on) with no error
- *True Bad*: output's value is true (on) and has an error
- *False Good*: output's value is false (off) with no error
- *False Bad*: output's value is false (off) and has an error

Equal To

If all the inputs are false (off, 0%) or all the inputs are true (on, 100%), the output is true (on, 100%). Otherwise, the output is false (off, 0%).

Only connected inputs are considered by the logic operation; inputs that are not connected are ignored. The truth table at the right illustrates the outcomes for three inputs.

Inputs	Output
FFF	T
FFT	F
FTF	F
FTT	F
TFF	F
TFT	F
TTF	F
TTT	T
F = False (0%, off) T = True (100%, on)	

Signals

Direction	Label	Type	Function
Receivers	- - - -	Digital	Input to logic function
	- - - -	Digital	Input to logic function
	- - - -	Digital	Input to logic function
	- - - -	Digital	Input to logic function
	- - - -	Digital	Input to logic function
	- - - -	Digital	Input to logic function
	- - - -	Digital	Input to logic function
	- - - -	Digital	Input to logic function
Transmitter	- - - -	Digital	True when each connected input has the same value, otherwise false

Function

To detect when all the inputs have the same value, set Function to *Equal To*.

Error Handling

Use Error Handling to select the output's value and error status when the function cannot definitively determine the result.

Options:

- *True Good*: output's value is true (on) with no error
- *True Bad*: output's value is true (on) and has an error
- *False Good*: output's value is false (off) with no error
- *False Bad*: output's value is false (off) and has an error

Not Equal To

If all the inputs are false (off, 0%) or all the inputs are true (on, 100%), the output is false (off, 0%). Otherwise, the output is true (on, 100%).

Only connected inputs are considered by the logic operation; inputs that are not connected are ignored. The truth table at the right illustrates the outcomes for three inputs.

Inputs	Output
FFF	F
FFT	T
FTF	T
FTT	T
TFF	T
TFT	T
TTF	T
TTT	F
F = False (0%, off) T = True (100%, on)	

Signals

Direction	Label	Type	Function
Receivers	- - - -	Digital	Input to logic function
	- - - -	Digital	Input to logic function
	- - - -	Digital	Input to logic function
	- - - -	Digital	Input to logic function
	- - - -	Digital	Input to logic function
	- - - -	Digital	Input to logic function
	- - - -	Digital	Input to logic function
	- - - -	Digital	Input to logic function
Transmitter	- - - -	Digital	True when not all of the inputs have the same value, otherwise false

Function

To detect when the inputs do not all have the same value, set Function to *Not Equal To*.

Error Handling

Use Error Handling to select the output's value and error status when the function cannot definitively determine the result.

Options:

- *True Good*: output's value is true (on) with no error
- *True Bad*: output's value is true (on) and has an error
- *False Good*: output's value is false (off) with no error
- *False Bad*: output's value is false (off) and has an error

Or

If any input is true (on, 100%), the output is true (on, 100%). If all inputs are false (off, 0%), the output is false (off, 0%).

Only connected inputs are considered by the logic operation; inputs that are not connected are ignored. The truth table at the right illustrates the outcomes for three inputs.

Inputs	Output
FFF	F
FFT	T
FTF	T
FTT	T
TFF	T
TFT	T
TTF	T
TTT	T
F = False (0%, off) T = True (100%, on)	

Signals

Direction	Label	Type	Function
Receivers	- - - -	Digital	Input to logic function
	- - - -	Digital	Input to logic function
	- - - -	Digital	Input to logic function
	- - - -	Digital	Input to logic function
	- - - -	Digital	Input to logic function
	- - - -	Digital	Input to logic function
	- - - -	Digital	Input to logic function
	- - - -	Digital	Input to logic function
Transmitter	- - - -	Digital	True when at least one of the inputs is true, otherwise false

Function

To detect when at least one of the inputs is true, set Function to Or.

Error Handling

Use Error Handling to select the output's value and error status when the function cannot definitively determine the result.

Options:

- *True Good*: output's value is true (on) with no error
- *True Bad*: output's value is true (on) and has an error
- *False Good*: output's value is false (off) with no error
- *False Bad*: output's value is false (off) and has an error

Nor

If any input is true (on, 100%), the output is false (off, 0%). If all the inputs are false (off, 0%), the output is true (on, 100%).

Only connected inputs are considered by the logic operation; inputs that are not connected are ignored. The truth table at the right illustrates the outcomes for three inputs.

Inputs	Output
FFF	T
FFT	F
FTF	F
FTT	F
TFF	F
TFT	F
TTF	F
TTT	F
F = False (0%, off) T = True (100%, on)	

Signals

Direction	Label	Type	Function
Receivers	- - - -	Digital	Input to logic function
	- - - -	Digital	Input to logic function
	- - - -	Digital	Input to logic function
	- - - -	Digital	Input to logic function
	- - - -	Digital	Input to logic function
	- - - -	Digital	Input to logic function
	- - - -	Digital	Input to logic function
	- - - -	Digital	Input to logic function
Transmitter	- - - -	Digital	True when all of the inputs are false, otherwise true

Function

To detect when all the inputs are false, set Function to *Nor*.

Error Handling

Use Error Handling to select the output's value and error status when the function cannot definitively determine the result.

Options:

- *True Good*: output's value is true (on) with no error
- *True Bad*: output's value is true (on) and has an error
- *False Good*: output's value is false (off) with no error
- *False Bad*: output's value is false (off) and has an error

Latch

When the HOLD input is false (off, 0%), the output follows the IN input value. When HOLD is true (on, 100%), the output does not change; it is held (latched) at the value that was present at IN when HOLD became true (on, 100%).

To understand the Latch's behavior consider these scenarios illustrated in the timing diagram below:

1. When Hold is false, the output follows IN.
2. If IN becomes true after Hold become true, the output remains false until Hold becomes false.
3. If Hold becomes true after IN becomes true, the output remains true as long as Hold is true even after IN becomes false.

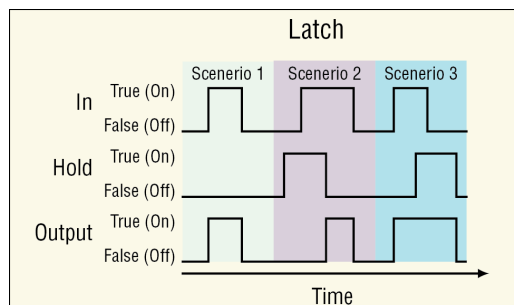

Signals

Direction	Label	Type	Function
Receivers	IN	Digital	The signal that sets the output
	Hold	Digital	The signal that holds the output
Transmitter	- - - -	Digital	Follows the input (IN) when HOLD is false. Latches at the value of the input (IN) when HOLD becomes true.

Function

To have an output that follows the input when another input is false and holds the last value when the latching input becomes true, set Function to *Latch*.

Error Handling

Use Error Handling to select the output's value and error status when the function cannot definitively determine the result.

Options:

- *True Good*: output's value is true (on) with no error
- *True Bad*: output's value is true (on) and has an error
- *False Good*: output's value is false (off) with no error
- *False Bad*: output's value is false (off) and has an error

RS Flip Flop

True (on, 100%) at the Set input sets the output to true (on, 100%) unless the reset (Rst) input is true (on, 100%). Whenever Rst is true (on, 100%) the output is false (off, 0%).

To understand the RS Flip Flop's behavior consider these scenarios illustrated in the timing diagram below:

1. Set turns the output on, Rst turns it off.
2. If Rst is true when Set becomes true, the output remains off until Rst becomes false.
3. Set has no effect when the output is already on.

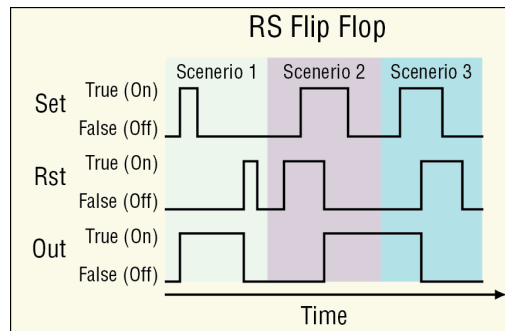

Signals

Direction	Label	Type	Function
Receivers	Set	Digital	Sets the output to true
	Rst	Digital	Sets the output to false, takes precedence over the Set input
Transmitter	- - - -	Digital	True after being set by the Set input and false after being reset by Rst

Function

To have an output that is set to true by one input and reset to false by another input, set Function to *RS Flip Flop*.

Error Handling

Use Error Handling to select the output's value and error status when the function cannot definitively determine the result.

Options:

- *True Good*: output's value is true (on) with no error
- *True Bad*: output's value is true (on) and has an error
- *False Good*: output's value is false (off) with no error
- *False Bad*: output's value is false (off) and has an error

Logic Errors

When the input has an error the signals connected to the output have the same error.

Function	Error Condition	Result
Off	One or more inputs has an error	The output is false with no error
Latch	In has an error Hold is off with no error	The output's value and error follow the input.
	In has an error Hold is on with no error	The output's value and error are the same as the input was at the time the Hold signal turned on.
	Hold has an error	The output's value and error follow the input.
RS Flip Flop	SET input gets an error while the output is false	The output stays false with no error.
	SET input gets an error while the output is true	The output stays true with no error until the RST input resets the output to false.
	RST input gets an error while the output is false	The output stays false with no error until the SET input sets the output to true.
	RST input gets an error while the output is true	The output stays true with no error.
All Others	One or more inputs has an error	If there is enough information to determine the output, all errors are ignored. Otherwise, the output value and error are determined by the setting of the Error Handling parameter.

Math

Use a Math block to set an output based by performing the selected math function on up to four inputs. A filter and offset may be applied to the calculated value. A digital input enables or disables some of the math functions. This block is found in the Function Block Diagram editor's Library when working with a data logger that offers the Math block. Within the Library, the number of these blocks available is shown in parenthesis.

Choose the math operation with the Function parameter. These options for the Function parameter are described in detail in the following sections:

Off: the output follows the filtered input plus the offset.

Average: calculates the average of up to four inputs.

Switch Over: selects one of two analog inputs with a digital input.

Process Scale: converts an input from its scale to another range.

Deviation Scale: adjusts an input by an amount proportional to another input.

Differential: subtracts one input from another.

Ratio: divides one input by another.

Add: sums up to four inputs.

Multiply: computes the product of up to four inputs.

Absolute Difference: calculates the absolute value of one input subtracted from another.

Minimum: outputs the lowest of up to four inputs.

Maximum: outputs the greatest of up to four inputs.

Square Root: calculates square root of an input.

Sample and Hold: freezes an analog signal with a digital input.

Pressure to Altitude: calculates the standard distance above sea level based on an atmospheric pressure.

Dew Point: calculates the temperature at which water vapor will condense based on the temperature and relative humidity of an environment.

Off

The output follows the top input. A filter and offset may be applied to the output value. The output has the units of the signal connected to the top input link.

Signals

Direction	Label	Type	Function
Receiver	- - - -	Analog	Value used for the output
Transmitter	- - - -	Digital	The filtered input plus the offset

Function

To filter and/or add an offset to a signal, set Function to Off.

Offset

Adjustment added to the input.

Range: -99,999.000 to 99,999

Filter

Set the amount of filtering to apply. Filtering smooths signal fluctuations. Increase the time to increase filtering. Excessive filtering slows the function's response.

Range: 0.0 to 60.0 seconds

Average

This function calculates the mean average of up to four inputs. Only inputs connected to a source are used in the calculation. A filter and offset may be applied to the calculated value. The output has the units of the signal connected to the top input link.

Signals

Direction	Label	Type	Function
Receivers	- - - -	Analog	Value to include in the average
	- - - -	Analog	Value to include in the average
	- - - -	Analog	Value to include in the average
	- - - -	Analog	Value to include in the average
Transmitter	- - - -	Analog	The filtered average of the inputs plus the offset

Function

To average the inputs, set Function to *Average*.

Offset

Adjustment added to the result of the calculation.

Range: -99,999.000 to 99,999

Filter

Set the amount of filtering to apply. Filtering smooths signal fluctuations. Increase the time to increase filtering. Excessive filtering slows the function's response.

Range: 0.0 to 60.0 seconds

Switch Over

When SW is off, the output equals input 1. When SW is on, the output equals input 2. A filter and offset may be applied to the output. The output has the same units as the selected input.

Signals

Direction	Label	Type	Function
Receivers	1	Analog	Selected as the output when SW is off
	2	Analog	Selected as the output when SW is on
	SW	Digital	Off selects input 1, on selects input 2
Transmitter	- - - -	Analog	The filtered value of the selected input plus the offset

Function

To select one of two analog inputs with a digital input, set Function to *Switch Over*.

Offset

Adjustment added to the selected value.

Range: -99,999.000 to 99,999

Filter

Set the amount of filtering to apply. Filtering smooths signal fluctuations. Increase the time to increase filtering. Excessive filtering slows the function's response.

Range: 0.0 to 60.0 seconds

Process Scale

When SW is off, the output equals the filtered, scaled value of input X plus the offset. When SW is on, the output equals the filtered value of input B plus the offset.

Scaling converts input X proportionally from the input scale to the output range according to the line defined by the Scale Low, Scale High, Range Low and Range High settings as shown in the illustration.

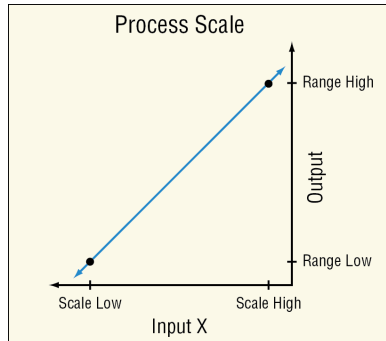

The definition of the scaling line is very flexible. The input scale is not limited by the Scale Low and Scale High values and the range of the scaling calculation is not limited to values between Range Low and Range High. Input values are converted according to the line defined by the two points. Scale High need not be greater than Scale Low and Range High need not be greater than Range Low. A filter and offset may be applied to the calculated value.

Process Scale can be used, for example, to convert from one set of units to another or to convert a sensor signal to engineering units if the signal is linear with the value it represents.

Signals

Direction	Label	Type	Function
Receivers	X	Analog	Signal to scale when SW is off
	B	Analog	Signal used without scaling when SW is on
	SW	Digital	When off, the output is based on the scaled value of input X, when on the output is based on input B (not scaled)
Transmitter	- - - -	Analog	The filtered result of the function plus the offset

Function

To convert an input from its scale to another range, set Function to *Process Scale*.

Scale Low

Set the value of input X at which the Range Low setting is the desired result of scaling. Scale Low and Range Low are the coordinates of a point on the line that relates input X to the scaled output.

Range: -99,999.000 to 99,999.000

Scale High

Set the value of input X at which the Range High setting is the desired result of scaling. Scale High and Range High are the coordinates of a point on the line that relates input X to the scaled output.

Range: -99,999.000 to 99,999.000

Units

Set the source units.

Options:

- *Source*: when SW is on, the output has the same units as input X. When SW is off, the output has the same units as input B.
- *None*: the output value is a pure number without units
- *Absolute Temperature*: the output value is a temperature value on the Celsius or Fahrenheit scale. For example, 33° F as an absolute temperature is one degree above the freezing point of water. An absolute temperature can be used as a set point or compared with other temperatures to determine which is hotter or colder.
- *Relative Temperature*: the output is a value is a relative number of degrees, not an absolute temperature. For example, the difference between the two measured temperatures, 120° C and 100° C is 20 degrees, but it is not the temperature 20° C. A relative temperature is appropriate for use as a calibration offset or a deviation alarm set point.
- *Power*: the output value is a percentage signal where 100% represents full power and 0% represents no power.
- *Process*: the output is in units of measure other than degrees Fahrenheit, degrees Celsius or relative humidity.
- *Relative Humidity*: the output is in percent relative humidity (%RH).

Range Low

Set the desired result of scaling at the point where input X equals the Scale Low setting. Scale Low and Range Low are the coordinates of a point on the line that relates input X to the scaled output.

Range: -99,999.000 to 99,999.000

Range High

Set the desired result of scaling at the point where input X equals the Scale High setting. Scale High and Range High are the coordinates of a point on the line that relates input X to the scaled output.

Range: -99,999.000 to 99,999.000

Offset

Adjustment added to the result of the calculation.

Range: -99,999.000 to 99,999.000

Filter

Set the amount of filtering to apply. Filtering smooths signal fluctuations. Increase the time to increase filtering. Excessive filtering slows the function's response.

Range: 0.0 to 60.0 seconds

Deviation Scale

When SW is off, the output equals the filtered, scaled value of input X plus DEV plus the offset. When SW is on, the output equals the filtered value of DEV plus the offset.

Scaling converts input X proportionally from the input scale to the output range according to the line defined by the Scale Low, Scale High, Range Low and Range High settings as shown in the illustration.

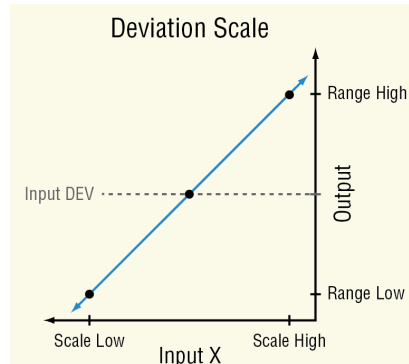

The definition of the scaling line is very flexible. The input scale is not limited by the Scale Low and Scale High values and, the range of the scaling calculation is not limited to values between Range Low and Range High. Input values are converted according to the line defined by the two points. Scale High need not be greater than Scale Low, and Range High need not be greater than Range Low. A filter and offset may be applied to the calculated value. The output has the same units as input DEV.

Deviation Scale may be used instead of Process Scale when it is desirable for the output range to be defined relative to a value that might change frequently or automatically.

Signals

Direction	Label	Type	Function
Receivers	X	Analog	Signal to scale when SW is off
	DEV	Analog	Signal added to the scaled value of X when SW is off, signal used without scaling when SW is on
	SW	Digital	When off, the output is based on DEV plus the scaled value of input X, when on the output is based on DEV (not scaled)
Transmitter	- - -	Analog	The filtered result of the function plus the offset

Function

To adjust an input by an amount proportional to another input, set Function to *Deviation Scale*.

Scale Low

Set the value of input X at which the Low Range setting plus the DEV value is the desired output. Scale Low and Range Low are the coordinates of a point on the line that relates input X to the adjustment added to input DEV to calculate the output.

Range: -99,999.000 to 99,999.000

Scale High

Set the value of input X at which the High Range setting plus the DEV value is the desired output. Scale High and Range High are the coordinates of a point on the line that relates input X to the adjustment added to input DEV to calculate the output.

Range: -99,999.000 to 99,999.000

Range Low

Set the adjustment be added to input DEV when input X equals the Scale Low setting. Scale Low and Range Low are the coordinates of a point on the line that relates input X to the adjustment added to input DEV to calculate the output.

Range: -99,999.000 to 99,999.000

Range High

Set the adjustment to be added to input DEV when input X equals the Scale High setting. Scale High and Range High are the coordinates of a point on the line that relates input X to the adjustment added to input DEV to calculate the output.

Range: -99,999.000 to 99,999.000

Offset

Adjustment added to the result of the calculation.

Range: -99,999.000 to 99,999.000

Filter

Set the amount of filtering to apply. Filtering smooths signal fluctuations. Increase the time to increase filtering. Excessive filtering slows the function's response.

Range: 0.0 to 60.0 seconds

Differential

This function calculates input X minus input Y. A filter and offset may be applied to the calculated value. The output has the units of input X.

Signals

Direction	Label	Type	Function
Receivers	X	Analog	Value from which Y is subtracted
	Y	Analog	Value subtracted from X
Transmitter	- - -	Analog	The filtered result of the calculation (X - Y) plus the offset

Function

To subtract one input from another, set Function to *Differential*.

Offset

Adjustment added to the result of the calculation.

Range: -99,999.000 to 99,999.000

Filter

Set the amount of filtering to apply. Filtering smooths signal fluctuations. Increase the time to increase filtering. Excessive filtering slows the function's response.

Range: 0.0 to 60.0 seconds

Ratio

This function calculates the quotient: input X divided by input Y. A filter and offset may be applied to the calculated value. If both inputs have the same units, the output has no units, otherwise the output has the units of input X.

Signals

Direction	Label	Type	Function
Receivers	X	Analog	Value divided by Y (numerator)
	Y	Analog	Value by which X is divided (denominator)
Transmitter	- - - -	Analog	The filtered result of the calculation ($X \div Y$) plus the offset

Function

To divide one input by another, set Function to *Ratio*.

Offset

Adjustment added to the result of the calculation.

Range: -99,999.000 to 99,999.000

Filter

Set the amount of filtering to apply. Filtering smooths signal fluctuations. Increase the time to increase filtering. Excessive filtering slows the function's response.

Range: 0.0 to 60.0 seconds

Add

This function sums up to four inputs. Only inputs connected to a source are used in the calculation. A filter and offset may be applied to the calculated value. If any input is an absolute temperature, the output is also an absolute temperature; otherwise the output's units are those of the signal connected to the top input.

Signals

Direction	Label	Type	Function
Receivers	- - - -	Analog	Value to be summed
	- - - -	Analog	Value to be summed
	- - - -	Analog	Value to be summed
	- - - -	Analog	Value to be summed
Transmitter	- - - -	Analog	The filtered sum of the inputs plus the offset

Function

To sum up to four inputs, set Function to *Add*.

Offset

Adjustment added to the result of the calculation.

Range: -99,999.000 to 99,999.000

Filter

Set the amount of filtering to apply. Filtering smooths signal fluctuations. Increase the time to increase filtering. Excessive filtering slows the function's response.

Range: 0.0 to 60.0 seconds

Multiply

This function multiplies up to four inputs. Only inputs connected to a source are used in the calculation. A filter and offset may be applied to the calculated value. If any input is an absolute temperature, the output is also an absolute temperature; otherwise the output's units are those of the signal connected to the top input.

Signals

Direction	Label	Type	Function
Receivers	- - - -	Analog	Value to be multiplied
	- - - -	Analog	Value to be multiplied
	- - - -	Analog	Value to be multiplied
	- - - -	Analog	Value to be multiplied
Transmitter	- - - -	Analog	The filtered product of the inputs plus the offset

Function

To compute the product of up to four inputs, set Function to *Multiply*.

Offset

Adjustment added to the result of the calculation.

Range: -99,999.000 to 99,999.000

Filter

Set the amount of filtering to apply. Filtering smooths signal fluctuations. Increase the time to increase filtering. Excessive filtering slows the function's response.

Range: 0.0 to 60.0 seconds

Absolute Difference

This function calculates the absolute value of input X minus input Y. A filter and offset may be applied to the calculated value. The output has the units of input x.

Signals

Direction	Label	Type	Function
Receivers	X	Analog	Value from which Y is subtracted
	Y	Analog	Value subtracted from X
Transmitter	- - - -	Analog	The filtered result of the absolute value of (X - Y) plus the offset

Function

To calculate the absolute value of one input subtracted from another, set Function to Absolute Difference

Offset

Adjustment added to the result of the calculation.

Range: -99,999.000 to 99,999.000

Filter

Set the amount of filtering to apply. Filtering smooths signal fluctuations. Increase the time to increase filtering. Excessive filtering slows the function's response.

Range: 0.0 to 60.0 seconds

Minimum

This function selects the minimum of up to four inputs. Only inputs connected to a source are considered. A filter and offset may be applied to the output. The output has the units of the signal with the minimum value.

Signals

Direction	Label	Type	Function
Receivers	- - - -	Analog	Compared with other inputs
	- - - -	Analog	Compared with other inputs
	- - - -	Analog	Compared with other inputs
	- - - -	Analog	Compared with other inputs
Transmitter	- - - -	Analog	The filtered lowest value of the inputs plus the offset

Function

To output the lowest of up to four inputs, set Function to *Minimum*.

Offset

Adjustment added to the result of the calculation.

Range: -99,999.000 to 99,999.000

Filter

Set the amount of filtering to apply. Filtering smooths signal fluctuations. Increase the time to increase filtering. Excessive filtering slows the function's response.

Range: 0.0 to 60.0 seconds

Maximum

This function selects the maximum of up to four inputs. Only inputs connected to a source are considered. A filter and offset may be applied to the output. The output has the units of the signal with the maximum value.

Signals

Direction	Label	Type	Function
Receivers	- - - -	Analog	Compared with other inputs
	- - - -	Analog	Compared with other inputs
	- - - -	Analog	Compared with other inputs
	- - - -	Analog	Compared with other inputs
Transmitter	- - - -	Analog	The filtered greatest value of the inputs plus the offset

Function

To output the greatest of up to four inputs, set Function to *Maximum*.

Offset

Adjustment added to the result of the calculation.

Range: -99,999.000 to 99,999.000

Filter

Set the amount of filtering to apply. Filtering smooths signal fluctuations. Increase the time to increase filtering. Excessive filtering slows the function's response.

Range: 0.0 to 60.0 seconds

Square Root

This function calculates the square root of input X. A filter and offset may be applied to the calculated value. The output has the same units as X.

Signals

Direction	Label	Type	Function
Receiver	X	Analog	Value of which to find the square root
Transmitter	- - - -	Analog	The filtered square root of input X plus the offset

Function

To calculate the square root of an input, set Function to *Square Root*.

Offset

Adjustment added to the result of the calculation.

Range: -99,999.000 to 99,999.000

Filter

Set the amount of filtering to apply. Filtering smooths signal fluctuations. Increase the time to increase filtering. Excessive filtering slows the function's response.

Range: 0.0 to 60.0 seconds

Sample and Hold

When the Hold input is off, the output follows the IN value. When Hold is on, the output stops changing; the output stays at the value it had at the time Hold turned on.

A filter and offset may be applied to the output value. Filtering holds when the Hold input is on. Changes to the offset are applied without filtering and are not affected by the Hold input. The output has the same units as the input (IN).

Signals

Direction	Label	Type	Function
Receivers	IN	Analog	Input to math function
	Hold	Digital	When off the output follows the input plus the offset. When on the output stops following the input and holds the input value present at the time hold turned on.
Transmitter	- - - -	Analog	Filtered value of input (IN) plus the offset when HOLD is off. Holds the output once HOLD turns on.

Function

To freeze the analog signal with a digital input, set Function to *Sample and Hold*.

Offset

Adjustment added to the result of the calculation.

Range: -99,999.000 to 99,999.000

Filter

Set the amount of filtering to apply. Filtering smooths signal fluctuations. Increase the time to increase filtering. Excessive filtering slows the function's response.

Range: 0.0 to 60.0 seconds

Pressure to Altitude

This function determines the altitude based on the atmospheric pressure. A filter and offset may be applied to the calculated value. The output has the units selected with the Altitude Units parameter.

The calculation is based on the International Standard Atmosphere 1976 and is accurate from sea level to 90,000 feet. It can be used beyond this range in both directions, but with loss of accuracy. The standard is based on an altitude of 0 feet (sea level) pressure of 14.6967 PSI and a temperature of 59 °F.

Signals

Direction	Label	Type	Function
Receiver	- - - -	Analog	Pressure (See Pressure Units parameter)
Transmitter	- - - -	Analog	The calculated altitude plus the offset (See Altitude Units parameter).

Function

To calculate the standard distance above sea level based on an atmospheric pressure, set Function to *Pressure to Altitude*.

Pressure Units

Set the units of pressure input.

Options: *PSI, mbar, Torr, Pascal, Atmosphere*

Altitude Units

Set the units for the altitude output.

Options: *Feet, Kilofeet*

Offset

Adjustment added to the result of the calculation.

Range: -99,999.000 to 99,999.000

Filter

Set the amount of filtering to apply. Filtering smooths signal fluctuations. Increase the time to increase filtering. Excessive filtering slows the function's response.

Range: 0.0 to 60.0 seconds

Dew Point

This function calculates the dew point based on temperature and relative humidity. A filter and offset may be applied to the calculated value. The output is an absolute temperature.

Signals

Direction	Label	Type	Function
Receivers	T	Analog	Temperature measurement
	RH	Analog	Relative humidity measurement
Transmitter	- - - -	Analog	Filtered calculated dew point plus the offset

Function

To calculate the temperature at which water vapor will condense based on the temperature and relative humidity of an environment, set Function to *Dew Point*.

Offset

Adjustment added to the result of the calculation.

Range: -99,999.000 to 99,999.000

Filter

Set the amount of filtering to apply. Filtering smooths signal fluctuations. Increase the time to increase filtering. Excessive filtering slows the function's response.

Range: 0.0 to 60.0 seconds

Math Errors

Inputs that are not connected are ignored. Otherwise error behavior is specific to the Function setting.

Function	Error Condition	Result
Off	Any or none	The output value and error follow the first input
Average	One or more, but not all inputs have errors	The output value is the average of the inputs that have no errors and the output has no error.
	All inputs have errors	The output has the last good value and has an error.
Switch Over	When SW has no error	The output's value and error follow the input selected by the digital input.
	When SW has an error	The output value and error follow input 1.
Deviation Scale	X or DEV or both have errors	The output is equal to the offset and has an error.
	SW has an error	The function considers the switch to be off.
Process Scale	X has an error	The output is equal to the offset and has an error.
	SW has an error	The function considers the switch to be off.
Differential	X or Y or both have errors	The output is equal to the offset and has an error.
Ratio	X or Y or both have errors	The output is equal to the offset and has an error.
	Y equals zero	The output is equal to the offset and has an error.
Add	Any or all inputs have errors	The output is equal to the offset and has an error.
Multiply	Any or all inputs have errors	The output is equal to the offset and has an error.
Absolute Difference	X or Y or both have errors	The output is equal to the offset and has an error.
Maximum	One or more, but not all inputs have errors	The output value is the maximum of the inputs with no errors and the output has no error.
	All inputs have errors	The output's value and error follow the first input.
Minimum	One or more, but not all inputs have errors	The output value is the minimum of the inputs with no errors and the output has no error.
	All inputs have errors	The output's value and error follow the first input.

Math Errors (cont.)		
Function	Error Condition	Result
Square Root	X has an error	The output is equal to the offset and has an error.
	X is less than zero	The output is equal to the offset and has an error.
Sample and Hold	IN has an error HOLD is off	The output's value and error follow IN.
	IN has an error HOLD is on with no error	The output value and error status are the same as IN at the time HOLD turned on.
	HOLD has an error	The output's value and error follow IN.
Pressure to Altitude	X has an error	The output's value is calculated as usual and has an error.
Dew Point	T, RH or both have errors	The output is equal to the offset and has an error.

Process Value

Use this block to produce a conditioned analog signal based on up to four analog signals and one digital signal. A filter and offset may be applied to the function's output. This block is found in the Function Block Diagram editor's Library. Within the Library, the number of these blocks available is shown in parenthesis and that number is determined by the data logger part number. The type of conditioning performed by the process block depends on the setting of the Function parameter. These options for the Function parameter are described in detail in the following sections:

Off: the output follows the filtered input plus the offset.

Sensor Backup: automatically switches to the next of up to three alternate inputs when a sensor fails.

Average: calculates the average of up to four inputs.

Crossover: gradually transitions from one input to another over a user-defined range.

Wet Bulb / Dry Bulb: calculates relative humidity based on two temperature measurements.

Switch Over: selects one of two analog inputs with a digital input.

Differential: subtracts one input from another.

Ratio: divides one input by another.

Add: sums up to four inputs.

Multiply: computes the product of up to four inputs.

Absolute Difference: calculates the absolute value of one input subtracted from another.

Minimum: outputs the lowest of up to four inputs.

Maximum: outputs the greatest of up to four inputs.

Square Root: calculates square root of an input.

Vaisala® RH Compensation: calculates the relative humidity based on the input from an un-compensated relative humidity sensor and a temperature measurement.

Pressure to Altitude: calculates the standard distance above sea level based on an atmospheric pressure.

Off

The output follows the top input. A filter and offset may be applied to the output value. The output has the units of the signal connected to the top input link.

Signals

Direction	Label	Type	Function
Receiver	- - - -	Analog	Value used for the output
Transmitter	- - - -	Analog	The filtered input plus the offset

Function

To filter and/or add an offset to a signal, set Function to *Off*.

Offset

Adjustment added to the input.

Range: -99,999.000 to 99,999.000

Filter

Set the amount of filtering to apply. Filtering smooths signal fluctuations. Increase the time to increase filtering. Excessive filtering slows the function's response.

Range: 0.0 to 60.0 seconds

Sensor Backup

This function passes the first input that has no error as the output. The inputs are considered as backups in numerical order. If input 1 has no error the output follows input 1. If input 1 has an error and input 2 does not, the output follows input 2 and so on. Only inputs connected to a source are considered as backups. A filter and offset may be applied to the output. The output has the same units as the selected input.

Signals

Direction	Label	Type	Function
Receivers	1	Analog	Primary input
	2	Analog	First backup
	3	Analog	Second backup
	4	Analog	Third backup
Transmitter	- - - -	Analog	The first input that has no error, filtered, plus the offset

Function

To automatically switch to the next of up to three alternate inputs when a sensor fails, set Function to *Sensor Backup*.

Offset

Adjustment added to the output.

Range: -99,999.000 to 99,999.000

Filter

Set the amount of filtering to apply. Filtering smooths signal fluctuations. Increase the time to increase filtering. Excessive filtering slows the function's response.

Range: 0.0 to 60.0 seconds

Average

This function calculates the mean average of up to four inputs. Only inputs connected to a source are used in the calculation. A filter and offset may be applied to the calculated value. The output has the units of the signal connected to the top input link.

Signals

Direction	Label	Type	Function
Receivers	- - - -	Analog	Value to include in the average
	- - - -	Analog	Value to include in the average
	- - - -	Analog	Value to include in the average
	- - - -	Analog	Value to include in the average
Transmitter	- - - -	Analog	The filtered average of the inputs plus the offset

Function

To average the inputs, set Function to *Average*.

Offset

Adjustment added to the result of the calculation.

Range: -99,999.000 to 99,999.000

Filter

Set the amount of filtering to apply. Filtering smooths signal fluctuations. Increase the time to increase filtering. Excessive filtering slows the function's response.

Range: 0.0 to 60.0 seconds

Crossover

The output of this function follows input A at the low end of the range, and, over a user-defined band as the input increases, the output gradually transitions to follow input B. A filter and offset may be applied to the calculated value. The output has the same units as input A.

The diagram below illustrates how the weighting of inputs A and B in determining the output changes over the input range. At the low end of the range only A is considered. As the value of A increases into the crossover band, A becomes less significant and B becomes more significant to the output until at the crossover point, the inputs are weighted equally, and the output is the average of A and B. At the high end of the range only B is considered.

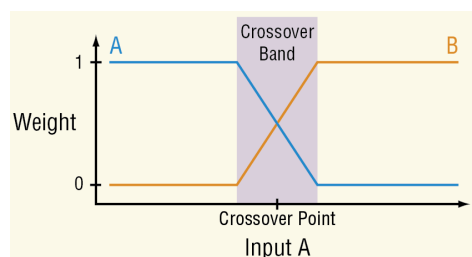

Signals

Direction	Label	Type	Function
Receivers	A	Analog	The input for the low end of the range
	B	Analog	The input for the high end of the range
Transmitter	- - - -	Analog	When A is below the crossover band the output is the filtered value of A plus the offset. When A is in the crossover band the output is the filtered weighted average of the inputs plus the offset. When A is above the crossover band, the output is the filtered value of B plus the offset.

Function

To gradually transition from one input to another over a user-defined range, set Function to *Crossover*.

Crossover Point

Set the middle of the band over which the function transitions between inputs A and B.

Range: -99,999.000 to 99,999.000 seconds

Crossover Band

Set the width of the transition between input A and B.

Range: -99,999.000 to 99,999.000 seconds

Offset

Adjustment added to the output.

Range: -99,999.000 to 99,999.000

Filter

Set the amount of filtering to apply. Filtering smooths signal fluctuations. Increase the time to increase filtering. Excessive filtering slows the function's response.

Range: 0.0 to 60.0 seconds

Wet Bulb / Dry Bulb

This function calculates the relative humidity of an environment based on two measured temperatures: the air temperature (dry bulb) and the temperature reached by evaporative cooling (wet bulb). A filter and offset may be applied to the calculated value. The output is in percent relative humidity.

This method for determining relative humidity applies in the temperature range 10 to 350°F (-12°C to 177°C).

Signals

Direction	Label	Type	Function
Receivers	DRY	Analog	The dry temperature measurement
	WET	Analog	The wet temperature measurement
Transmitter	- - - -	Analog	The filtered relative humidity plus the offset

Function

To calculate relative humidity based on wet and dry temperature measurements, set Function to *Wet Bulb / Dry Bulb*.

Barometric Pressure

Set the atmospheric pressure in pounds per square inch (psi) of the environment for which the humidity is calculated.

Range: 10.0 to 16.0 psi

Offset

Adjustment added to the result of the calculation.

Range: -99,999.000 to 99,999.000

Filter

Set the amount of filtering to apply. Filtering smooths signal fluctuations. Increase the time to increase filtering. Excessive filtering slows the function's response.

Range: 0.0 to 60.0 seconds

Switch Over

When SW is off, the output equals input 1. When SW is on, the output equals input 2. A filter and offset may be applied to the output. The output has the same units as the selected input.

Signals

Direction	Label	Type	Function
Receivers	DRY	Analog	Selected as the output when SW is off
	WET	Analog	Selected as the output when SW is on
	SW	Digital	Off selects input 1, on selects input 2
Transmitter	- - - -	Analog	The filtered value of the selected input plus the offset

Function

To select one of two analog inputs with a digital input, set Function to *Switch Over*.

Offset

Adjustment added to the selected value.

Range: -99,999.000 to 99,999.000

Filter

Set the amount of filtering to apply. Filtering smooths signal fluctuations. Increase the time to increase filtering. Excessive filtering slows the function's response.

Range: 0.0 to 60.0 seconds

Differential

This function calculates input X minus input Y. A filter and offset may be applied to the calculated value. The output has the units of input X.

Signals

Direction	Label	Type	Function
Receivers	X	Analog	Value from which Y is subtracted
	Y	Analog	Value subtracted from X
Transmitter	- - - -	Analog	The filtered result of the calculation (X - Y) plus the offset

Function

To subtract one input from another, set Function to *Differential*.

Offset

Adjustment added to the result of the calculation.

Range: -99,999.000 to 99,999.000

Filter

Set the amount of filtering to apply. Filtering smooths signal fluctuations. Increase the time to increase filtering. Excessive filtering slows the function's response.

Range: 0.0 to 60.0 seconds

Ratio

This function calculates the quotient, input X divided by input Y. A filter and offset may be applied to the calculated value. If both inputs have the same units, the output has no units, otherwise the output has the units of input X.

Signals

Direction	Label	Type	Function
Receivers	X	Analog	Value divided by Y (numerator)
	Y	Analog	Value by which X is divided (denominator)
Transmitter	- - - -	Analog	The filtered result of the calculation (X ÷ Y) plus the offset

Function

To divide one input by another, set Function to *Ratio*.

Offset

Adjustment added to the result of the calculation.

Range: -99,999.000 to 99,999.000

Filter

Set the amount of filtering to apply. Filtering smooths signal fluctuations. Increase the time to increase filtering. Excessive filtering slows the function's response.

Range: 0.0 to 60.0 seconds

Add

This function sums up to four inputs. Only inputs connected to a source are used in the calculation. A filter and offset may be applied to the calculated value. If any input is an absolute temperature, the output is also an absolute temperature; otherwise the output's units are those of the signal connected to the top input.

Signals

Direction	Label	Type	Function
Receivers	- - - -	Analog	Value to be summed
	- - - -	Analog	Value to be summed
	- - - -	Analog	Value to be summed
	- - - -	Analog	Value to be summed
Transmitter	- - - -	Analog	The filtered sum of the inputs plus the offset

Function

To sum up to four inputs, set Function to *Add*.

Offset

Adjustment added to the result of the calculation.

Range: -99,999.000 to 99,999.000

Filter

Set the amount of filtering to apply. Filtering smooths signal fluctuations. Increase the time to increase filtering. Excessive filtering slows the function's response.

Range: 0.0 to 60.0 seconds

Multiply

This function multiplies up to four inputs. Only inputs connected to a source are used in the calculation. A filter and offset may be applied to the calculated value. If any input is an absolute temperature, the output is also an absolute temperature; otherwise the output's units are those of the signal connected to the top input.

Signals

Direction	Label	Type	Function
Receivers	- - - -	Analog	Value to be multiplied
	- - - -	Analog	Value to be multiplied
	- - - -	Analog	Value to be multiplied
	- - - -	Analog	Value to be multiplied
Transmitter	- - - -	Analog	The filtered product of the inputs plus the offset

Function

To compute the product of up to four inputs, set Function to *Multiply*.

Offset

Adjustment added to the result of the calculation.

Range: -99,999.000 to 99,999.000

Filter

Set the amount of filtering to apply. Filtering smooths signal fluctuations. Increase the time to increase filtering. Excessive filtering slows the function's response.

Range: 0.0 to 60.0 seconds

Absolute Difference

This function calculates the absolute value of input X minus input Y. A filter and offset may be applied to the calculated value. The output has the units of input x.

Signals

Direction	Label	Type	Function
Receivers	X	Analog	Value from which Y is subtracted
	Y	Analog	Value subtracted from X
Transmitter	- - - -	Analog	The filtered result of the absolute value of (X - Y) plus the offset

Function

To calculate the absolute value of one input subtracted from another, set Function to *Absolute Difference*.

Offset

Adjustment added to the result of the calculation.

Range: -99,999.000 to 99,999.000

Filter

Set the amount of filtering to apply. Filtering smooths signal fluctuations. Increase the time to increase filtering. Excessive filtering slows the function's response.

Range: 0.0 to 60.0 seconds

Minimum

This function selects the minimum of up to four inputs. Only inputs connected to a source are considered. A filter and offset may be applied to the output. The output has the units of the signal with the minimum value.

Signals

Direction	Label	Type	Function
Receivers	- - - -	Analog	Compared with the other inputs
	- - - -	Analog	Compared with the other inputs
	- - - -	Analog	Compared with the other inputs
	- - - -	Analog	Compared with the other inputs
Transmitter	- - - -	Analog	The filtered lowest value of the inputs plus the offset

Function

To output the lowest of up to four inputs, set Function to *Minimum*.

Offset

Adjustment added to the result of the calculation.

Range: -99,999.000 to 99,999.000

Filter

Set the amount of filtering to apply. Filtering smooths signal fluctuations. Increase the time to increase filtering. Excessive filtering slows the function's response.

Range: 0.0 to 60.0 seconds

Maximum

This function selects the maximum of up to four inputs. Only inputs connected to a source are considered. A filter and offset may be applied to the output. The output has the units of the signal with the maximum value.

Signals

Direction	Label	Type	Function
Receivers	- - - -	Analog	Compared with the other inputs
	- - - -	Analog	Compared with the other inputs
	- - - -	Analog	Compared with the other inputs
	- - - -	Analog	Compared with the other inputs
Transmitter	- - - -	Analog	The filtered greatest value of the inputs plus the offset

Function

To output the greatest of up to four inputs, set Function to *Minimum*.

Offset

Adjustment added to the result of the calculation.

Range: -99,999.000 to 99,999.000

Filter

Set the amount of filtering to apply. Filtering smooths signal fluctuations. Increase the time to increase filtering. Excessive filtering slows the function's response.

Range: 0.0 to 60.0 seconds

Square Root

This function calculates the square root of input X. A filter and offset may be applied to the calculated value. The output has the same units as X.

Signals

Direction	Label	Type	Function
Receiver	X	Analog	Value of which to find the square root
Transmitter	- - - -	Analog	The filtered square root of input X plus the offset

Function

To calculate the square root of an input, set Function to *Square Root*.

Offset

Adjustment added to the result of the calculation.

Range: -99,999.000 to 99,999.000

Filter

Set the amount of filtering to apply. Filtering smooths signal fluctuations. Increase the time to increase filtering. Excessive filtering slows the function's response.

Range: 0.0 to 60.0 seconds

Vaisala® RH Compensation

This function calculates the relative humidity of an environment based on the input from an uncompensated relative humidity sensor and a temperature measurement. A filter and offset may be applied to the calculated value. The output is in percent relative humidity.

Signals

Direction	Label	Type	Function
Receivers	~RH	Analog	Uncompensated humidity measurement
	T	Analog	Temperature measurement
Transmitter	- - -	Analog %	Filtered calculated relative humidity plus the offset

Function

To calculate the relative humidity based on the input from an uncompensated relative humidity sensor and a temperature measurement, set Function to *Vaisala RH Compensation*.

Offset

Adjustment added to the result of the calculation.

Range: -99,999.000 to 99,999.000

Filter

Set the amount of filtering to apply. Filtering smooths signal fluctuations. Increase the time to increase filtering. Excessive filtering slows the function's response.

Range: 0.0 to 60.0 seconds

Pressure to Altitude

This function determines the altitude based on the atmospheric pressure. A filter and offset may be applied to the calculated value. The output has the units selected with the Altitude Units parameter.

The calculation is based on the International Standard Atmosphere 1976 and is accurate from sea level to 90,000 feet. It can be used beyond this range in both directions, but with loss of accuracy. The standard is based on an altitude of 0 feet (sea level) pressure of 14.6967 PSI and a temperature of 59 °F.

Signals

Direction	Label	Type	Function
Receiver	- - - -	Analog	Pressure (See Pressure Units parameter)
Transmitter	- - - -	Analog	The calculated altitude plus the offset (See Altitude Units parameter)

Function

To calculate the standard distance above sea level based on an atmospheric pressure, set Function to *Pressure to Altitude*.

Pressure Units

Set the units of the pressure input.

Options: *PSI, mbar, Torr, Pascal, Atmosphere*

Altitude Units

Set the units for the altitude output.

Options: *Feet, Kilofeet*

Offset

Adjustment added to the result of the calculation.

Range: -99,999.000 to 99,999.000

Filter

Set the amount of filtering to apply. Filtering smooths signal fluctuations. Increase the time to increase filtering. Excessive filtering slows the function's response.

Range: 0.0 to 60.0 seconds

Process Errors

Inputs that are not connected are ignored. Otherwise error behavior is specific to the Function setting.

Function	Error Condition	Result
Off	Any or none	The output value and error follow the first input.
Sensor Backup	One or more, but not all inputs have errors	The output's value follows the first input without an error.
	All inputs have errors	The output value and error follow the first input.
Average	One or more, but not all inputs have errors	The output value is the average of the inputs that have no errors and the output has no error.
	All inputs have errors	The output has the last good value and has an error.
Crossover	A or B has an error but not both	The output is equal to the error free input plus the offset
	A and B both have errors	The output's value and error follow input A.
Wet Bulb Dry Bulb	DRY or WET or both have errors	RH has an error

Process Errors (cont.)		
Function	Error Condition	Result
Switch Over	When SW has no error	The output's value and error follow the input selected by the digital input.
	When SW has an error	The output value and error follow input 1.
Differential	X or Y or both have errors	The output is equal to the offset and has an error.
Ratio	X or Y or both have errors	The output is equal to the offset and has an error.
	Y equals zero	The output is equal to the offset and has an error.
Add	Any or all inputs have errors	The output is equal to the offset and has an error.
Multiply	Any or all inputs have errors	The output is equal to the offset and has an error.
Absolute Difference	X or Y or both have errors	The output is equal to the offset and has an error.
Maximum	One or more, but not all inputs have errors	The output value is the maximum of the inputs with no errors and the output has no error.
	All inputs have errors	The output's value and error follow the first input.
Minimum	One or more, but not all inputs have errors	The output value is the minimum of the inputs with no errors and the output has no error.
	All inputs have errors	The output's value and error follow the first input.
Square Root	X has an error	The output is equal to the offset and has an error.
	X is less than zero	The output is equal to the offset and has an error.
Viasala	%RH or T or both have errors	%RH has an error
Pressure to Altitude	X has an error	The output's value is calculated as usual and has an error.

Special Output

Use this block to operate outputs for one of these applications: operating mechanical compressors. This FB is found in the Function Block Diagram editor's Library. Within the Library, the number of these blocks available is shown in parenthesis and that number is determined by the data logger part number.

Choose the algorithm with the Function parameter. These options for the Function parameter are described in detail in the following sections:

Off: the first output follows the input all others are off.

Compressor Control: operates a compressor to meet demands for cooling or dehumidification from one or two control loops while protecting it from excessive cycling.

Off

The first output follows the input, all others are off.

Compressor Control

This function coordinates the demands of one or two control loops for a single compressor and eliminates short cycling of the compressor. For example, when a compressor is used for controlling an environment, a control loop may adjust a bypass valve proportionally to the amount of cooling needed and another loop may adjust a valve proportionally for dehumidification. Both require the compressor to be on, but to save power and extend the life of the compressor, it is desirable for the compressor to be off when it is not needed. The output from this function turns the compressor on in anticipation of its use by either loop and turns it off when it is not needed. The need for the compressor is anticipated by monitoring the power outputs from the two loops (Input A for one loop and Input B for the second loop, if used).

The diagram below illustrates how the compressor control functions for a single heat/cool loop.

Compressor Settings:

Input A Turn On = -2%

Input A Turn Off = 2%

Minimum Off Time = 15 (sec)

Minimum On Time = 45 (sec)

Off Delay = 20 (sec)

Compressor Operation (Graphic Explained):

In this example, the power signal from the temperature loop is connected to Input A of the FB. When the power signal drops below its Turn On setting (-2%) and the Minimum Off Time (15 sec) has been satisfied, the output to the compressor turns on immediately and will remain on until the Minimum On Time is satisfied (45 sec).

w When the power level rises above 2% (Turn Off), the output to the compressor remains

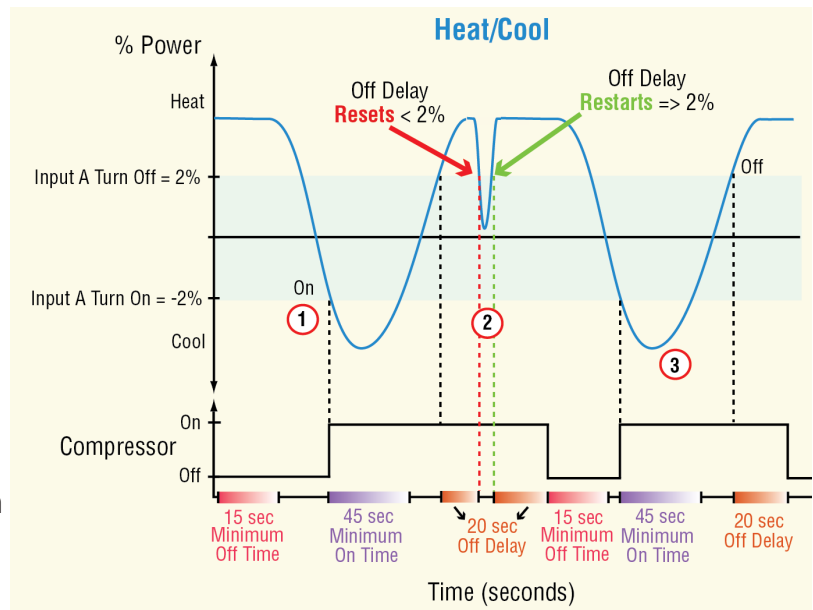

on until the Off Delay is satisfied. Note that in this example the power level momentarily drops below the 2% turn off, therefore the Off Delay is reset prior to reaching 20 seconds. As soon as the power level rises to 2%, the Off Delay again starts; after 20 seconds the output shuts off.

When the power signal drops below its Turn On setting (-2%) and the Minimum Off Time (15 sec) has been satisfied, the output to the compressor turns on immediately and will remain on until the Minimum On Time is satisfied (45 sec). As soon as the power level rises to 2%, the Off Delay again starts shutting the compressor off after 20 seconds.

The diagram below illustrates how the compressor control functions while coordinating the demands from two control loops.

Compressor Settings:

Input A Turn On = 0%

Input B Turn On = -5%

Input A Turn Off = 2%

Input B Turn Off = 5%

Minimum On Time = 45 (sec)

Minimum Off Time = 15 (sec)

Off Delay = 5 (sec)

Compressor Operation (Graphic Explained):

In this example, the power signal from the humidity loop is connecte to Input A and the power signal from the temperature loop is connected to Input B. When the humidity signal (A) drops below its Turn On setting (0%) and the Minimum Off Time has been satisfied, the output to the compressor turns on immediately.

- w When the temperature signal (B) drops below its Turn On setting (-5%), the compressor is already on. When the humidify/dehumidify loop (A) rises above its Turn Off (2%) the compressor remains on because it is still needed for the temperature loop (Input B).

When Input B rises above 5% (Turn Off), the output to the compressor remains on for an additional 5 seconds (Off Delay) to give the power signals time to stabilize. Notice that after the 5 second delay expires the output shuts off.

When Input B again drops below -5% (Turn On), the compressor turns on only after the Minimum Off Time is met to minimize wear on the compressor. Again, Input B is calling for the compressor to go off when it rises above 5%. In this case, the output will remain on until the Minimum On Time of 45 seconds is satisfied plus the Off Delay (5 seconds). In the event that Inputs A or B falls below their respective turn off percentages while the Off Delay is active, the Off Delay timer will reset as shown in the graphic above.

Once Input B rises above 5% the Off Delay timer is activated. When that time has been satisfied the compressor goes off.

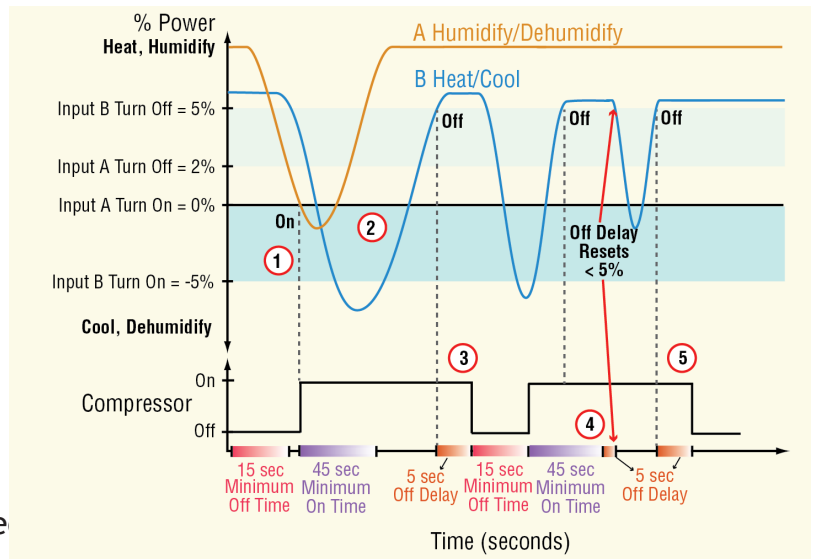

Signals

Direction	Label	Type	Function
Receivers	A	Analog %	Power output from one control loop that requires the compressor
	B	Analog %	Power output from a second control loop that requires the compressor
Transmitter	OUT	Digital	On indicates the compressor should be running

Function

To operate a compressor to meet demands for one or two control loops while protecting it from excessive cycling, set Function to *Compressor Control*.

Input A Turn On

Set the value of the signal at receiver A that indicates demand for the compressor to turn on. When A drops to or below this value and the Minimum Off Time condition has been met, the function turns on the output to the compressor.

Range: -100.0 to 100.0%

Input A Turn Off

Set the value of the signal at receiver A that indicates there is no demand for the compressor to be on. When A rises to or above this value and the Minimum On Time condition has been met, the function turns off the output to the compressor.

Range: -100.0 to 100.0%

Input B Turn On

Set the value of the signal at receiver B that indicates demand for the compressor to turn on. When B drops to or below this value and the Minimum Off Time condition has been met, the function turns on the output to the compressor.

Range: -100.0 to 100.0%

Input B Turn Off

Set the value of the signal at receiver B that indicates there is no demand for the compressor to be on. When B rises to or above this value and the Minimum On Time condition has been met, the function turns off the output to the compressor.

Range: -100.0 to 100.0%

Minimum On Time

Set the minimum amount of time the compressor must be on before it can be turned off again.

Range: 0 to 9,999 seconds

Minimum Off Time

Set the minimum amount of time the compressor is kept off before it can be turned on again.

Range: 0 to 9,999 seconds

Off Delay

Set an amount of time the output signal remains on after the Minimum On Time is satisfied and the signals at A and B indicate the compressor is no longer needed. This prevents the compressor from turning off prematurely due to a transient condition such as opening a door.

Range: 0 to 9,999 seconds

Note:

During the Off Delay, if either channel's power signal drops below its turn off setting, the compressor stays on and the Off Delay timer is reset. The timer starts again when A and B are each above their Turn Off levels.

Time Delay

Set how long the compressor remains on while 0% power is received from the control loops. This feature turns the compressor off when the power from the control loops is 0% for longer than the Time Delay setting. Use the Time Delay to distinguish between the case where the power is 0% because the loop is turned off, and the case where the power is 0% for a short time when a loop switches from heating to cooling. To ensure the compressor stays on when needed, but turns off when the control loops are off, set the Time Delay longer than the time the loop outputs are at 0% in normal operation. If two loops are connected to the Special Output function block, the Time Delay feature looks for both loops to output 0%. When the Time Delay is set to 0, this feature is disabled.

Range: 0 to 9,999 seconds

Thermistor Input

Use this block to condition a temperature measurement made with a thermistor. This FB is found on the canvas of the FB diagram. The number of these FBs that are available depends on the number of installed flex modules with thermistor inputs.

The module number shown on the block is the number of the data logger's slot that houses the flex module with the thermistor input. The Thermistor Input number indicates the specific input on the flex module.

Signals

Direction	Label	Type	Function
Transmitter	- - - -	Analog	The measured temperature with filter and offset applied

This function includes three curves pre-programmed for use with popular sensors selectable with the Thermistor Curve parameter. See the table. It also can be user-configured for other sensors by entering the Steinhart-Hart coefficients for the thermistor.

Thermistor Curve Setting	Resistance @ 25°C	Alpha Technics	Measurement Specialties (BetaTHERM)	YSI
Curve A	2,252 Ω	Curve A	2.2K3A	004
Curve B	10,000 Ω	Curve A	10K3A	016
Curve C	10,000 Ω	Curve C	10K4A	006
Custom	Use Steinhart-Hart equation coefficients (A, B and C) from thermistor manufacturer corresponding to the terms of the Steinhart-Hart equation: $\frac{1}{T} = A + B \ln(R) + C(\ln(R))^3$			

Name

Uniquely identify this FB using up to 20 alphanumeric characters.

Thermistor Curve

Set the curve for the thermistor used.

Options: *Custom, Curve A, Curve B, Curve C*

Coefficient A

Enter the custom resistance coefficient for the thermistor.

Range: -3.4000000E039 to 3.4000000E038

Coefficient B

Enter the custom resistance coefficient for the thermistor.

Range: -3.4000000E039 to 3.4000000E038

Coefficient C

Enter the custom resistance coefficient for the thermistor.

Range: -3.4000000E039 to 3.4000000E038

Resistance Range

Set the maximum resistance to be measured by the thermistor input. Higher settings yield a wider range with less precision.

Range: 5K, 10K, 20K, 40K

Display Precision

Set how many decimal places are displayed for the process value and associated parameters such as set points.

Options: *Whole, Tenths, Hundredths, Thousandths*

Calibration Offset

Set a value to add to the measured input value to compensate for sensor placement, lead wire resistance or other factors that cause the input to vary from the actual process value

Range: -99,999.000 to 99,999.000 °F or units
-55,555.000 to 55,555.000 °C

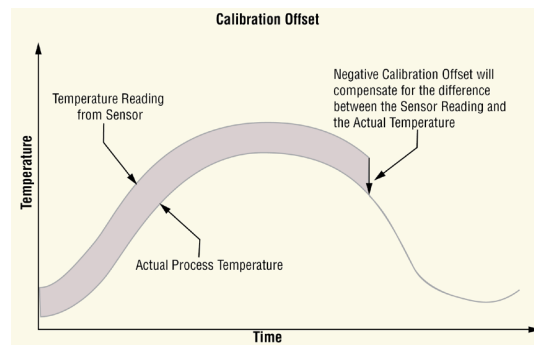

Filter

Set the amount of filtering to apply. Filtering smooths signal fluctuations. Increase the time to increase filtering. Excessive filtering slows the input's response.

Range: 0.0 to 60.0 seconds

Input Error Latching

Set whether an input error persists until it is cleared or clears automatically when the sensor signal returns to a normal level.

Options:

- *Off*: error clears automatically once the input returns to normal.
- *On*: error remains active until the input returns to normal and the error is cleared by the Clear Error parameter.

Clear Error

Set this parameter to *Clear* to reset the input error after correcting the condition that caused it.

Options: *Ignore*, *Clear*

Thermistor Input Errors

Error Status	Description
None	No error is detected.
Open	A sensor is broken or disconnected.
Shorted	A sensor has failed or is shorted.
Measurement Error	A measurement error has occurred.
Bad Calibration	The data logger has not been calibrated.
Ambient Error	The ambient temperature is outside of the data logger's operating range.
Fail	A measurement failure has occurred.
Not Sourced	An input signal is not connected to a function block's output.
Stale Data	Data sourced from another data logger has become unavailable.
Math Error	A calculation has no defined result (such as divide by zero).

Timer

Use a timer when applications require timed control of outputs or a delay to an output for a specific length of time. This block is found in the Function Block Diagram editor's Library when working with a data logger that offers the Timer block.

The number of these blocks available to be added to the diagram is shown within the parenthesis.

Choose the type of timer with the Function parameter. These options for the Function parameter are described in detail in the following sections:

Off: disables the timer and holds the output is in its inactive state.

On Pulse: sets the output for a specified time.

Delay: switches the output a specified time after the input changes states.

One Shot: triggers the output by setting the time, timer counts down while the input is active, output is active until time runs out.

Retentive: measures how long the input is active and triggers the output when the cumulative time reaches a specified duration

Off

When the Timer block's function is set to Off, the transmitter is in its inactive state. See Transmitter Active Level.

Signals

Direction	Label	Type	Function
Transmitter	- - - -	Digital	In the state selected with the Transmitter Active Level parameter

Function

To disable the timer and hold the output is in its inactive state, set Function to *Off*.

Transmitter Active Level

Choose the output's active state. When Function is set to *Off*, the output is in the inactive state, the opposite of the state selected here.

Options:

- *High*: the timer's output is off while the timer is disabled.
- *Low*: the timer's output is on while the timer is disabled.

On Pulse

This function produces an output pulse of a constant duration. This can be used as a minimum on time for devices that do not tolerate excessive cycling.

To understand the timer's behavior, consider these scenarios illustrated in the timing diagram below:

1. When input changes to its active state, the function sets the output to its active state and begins accumulating the elapsed time. Once the elapsed time reaches the value set for the Time parameter, the output returns to its inactive state and the elapsed time resets to zero.
2. The input need not stay active for the output to remain active for the specified time.
3. However, while the timer is running, if the input becomes inactive and then active again, the pulse length is increased.

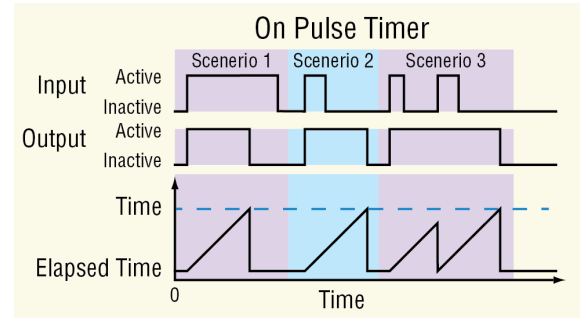

Note:

The *active* and *inactive* states are user configurable with the parameters described below. Therefore, the description of the timer's behavior for its inputs and outputs refers to the active and inactive states for each rather than on or off. For example, if the input's active state is set to High, the timer starts running (becomes active) when the input changes from low (off) to high (on). However, if the input's active state is set to Low, the timer starts running (becomes active) when the input changes from high (on) to low (off).

Signals

Direction	Label	Type	Function
Receiver	- - - -	Digital	Run signal for the timer. The output becomes active and the timer starts when this input becomes active.
Transmitter	- - - -	Digital	The output becomes active and the timer starts when the input becomes active. The output becomes inactive when specified time has elapsed.

Function

To set the output for a specified time, set Function to *On Pulse*.

Time

Set how long the output is held in its active state once the timer is triggered by the input.

Range: 0 to 99,999.000

Run Active Level

Set which state change at RUN sets the output to its active state and starts the timer.

Options:

- *High*: off to on
- *Low*: on to off

Transmitter Active Level

Set the state in which the output is held while the timer is running.

Options:

- *High*: On
- *Low*: Off

Elapsed Time

Indicates the amount of time since the timer was triggered while the timer is running. When the timer is not running, Elapsed Time reads zero.

Range: 0 to 99,999.000

Note:

The elapsed time is not retained through a power loss; it is set to zero upon power up.

Delay

The output follows the input, but only after the input is present for at least the specified time. This can be used to keep short input pulses from propagating through to logic or an output. It can also be used to trigger a secondary action following a primary action and a specific time delay, such as, turning on successive output devices. The timer can be configured as an on-delay or off-delay by setting the Active State and Active Level parameters appropriately.

To understand the timer's behavior, consider these scenarios illustrated in the timing diagram below:

1. When the input changes to its active state, the elapsed time begins to increment. Once the elapsed time reaches the value set for the Time parameter, the output changes to its active state and the elapsed time holds. When the input changes back to its inactive state, the output returns to its inactive state and the elapsed time resets to zero.
2. If the input is active for less than the Time setting, the output never becomes active.

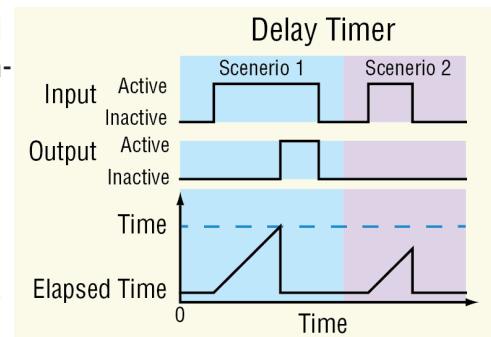

Note:

The *active* and *inactive* states are user configurable with the parameters described below. Therefore, the description of the timer's behavior for its inputs and outputs refers to the active and inactive states for each rather than on or off. For example, if the input's active state is set to High, the timer starts running (becomes active) when the input changes from low (off) to high (on). However, if the input's active state is set to Low, the timer starts running (becomes active) when the input changes from high (on) to low (off).

Signals

Direction	Label	Type	Function
Receiver	- - - -	Digital	Run signal for the timer. The timer starts when this input becomes active.
Transmitter	- - - -	Digital	Becomes active once the specified time has elapsed and becomes inactive again when the input becomes inactive.

Function

To switch the output a specified time after the input changes states, set Function to *Delay*.

Time

Set how long the input must be continuously active before the output becomes active.

Range: 0 to 99,999.000

Run Active Level

Set which state change at RUN starts the timer. This is the state change that is delayed.

Options:

- *High*: off to on
- *Low*: on to off

Transmitter Active Level

Set the state of the output that indicates the input has been active for at least the specified time.

Options:

- *High*: On
- *Low*: Off

Elapsed Time

Indicates the amount of time since the input became active up to the value set with the Time parameter, then holds at that value until the input becomes inactive. When the input becomes inactive, Elapsed Time is reset to zero.

Range: 0 to 99,999.000

Note:

The elapsed time is not retained through a power loss; it is set to zero upon power up.

One Shot

The One Shot timer behaves like an analog oven timer. The user sets the time and the timer counts down to zero without retaining the original time (hence the name one-shot). The output is active whenever the time is greater than zero, and the timer counts down while the input is active until the time reaches zero. This can be used in applications where the user may set a different time each time the process runs.

To understand the timer's behavior, consider these scenarios illustrated in the timing diagram below:

1. If the input is active when the time is set by the user, the output becomes active and the timer starts counting down immediately. The Time parameter counts down and Elapsed Time counts up until Time reaches zero and Elapsed Time reaches the value initially set for Time by the user. Once the time has elapsed, the output becomes inactive and the Elapsed Time resets to zero.

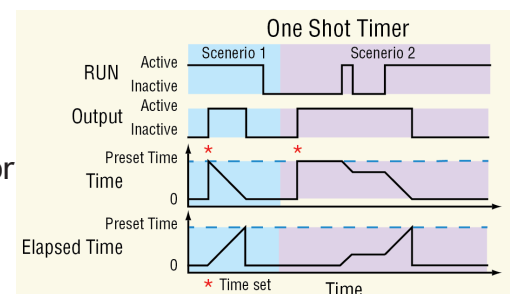

- If the input is not active when the user sets the time, the output becomes active, but the timer does not run. When the input becomes active, the output remains active until the timer counts down to zero. If the input becomes inactive at any point while the timer is running, the output remains active and the Time and Elapsed Time hold until the input becomes active again at which point the timer resumes running.

Note:

The *active* and *inactive* states are user configurable with the parameters described below. Therefore, the description of the timer’s behavior for its inputs and outputs refers to the active and inactive states for each rather than on or off. For example, if the input’s active state is set to High, the timer starts running (becomes active) when the input changes from low (off) to high (on). However, if the input’s active state is set to Low, the timer starts running (becomes active) when the input changes from high (on) to low (off).

Signals

Direction	Label	Type	Function
Receiver	RUN	Digital	Run signal for the timer. The timer runs when this input is active and holds when this input is inactive.
Transmitter	- - - -	Digital	Active whenever the time is greater than zero

Note:

The elapsed time is not retained through a power loss; it is set to zero upon power up.

Function

To trigger the output by setting the time, to have the timer count down while the input is active, and have the output active until the time runs out, set Function to *One Shot*.

Time

Set the amount of time to count down. While the input is active this parameter counts down until it reaches zero. The output is active whenever this parameter is greater than zero.

Range: 0 to 99,999.000

Run Active Level

Set in which state at RUN the timer counts down.

Options:

- *High*: on
- *Low*: off

Note:

The time is not retained through a power loss; it is set to zero upon power up.

Transmitter Active Level

Set the state of the output that indicates the timer is running or holding with a Time setting greater than zero.

Options:

- *High*: On
- *Low*: Off

Elapsed Time

Indicates how long the timer has been running not including holding time. The value holds whenever the input is inactive. The elapsed time resets to zero once the Time parameter has counted down to zero.

Range: 0 to 99,999.000

Retentive

A retentive timer is used to keep track of how much cumulative time the input has been active. For example, it can be used to time how long an alarm is on over the course of a day. The output can be used to trigger an event if the elapsed time is considered excessive.

To understand the timer's behavior consider these scenarios illustrated in the timing diagram below

1. While the RUN input is active, the elapsed time counts up. Whenever RUN is inactive, the elapsed time holds. When the elapsed time reaches the specified time, the output becomes active and remains active until the timer is reset. When the RST input becomes active, the output becomes inactive and the elapsed time is reset to zero.
2. If RST becomes active while the timer is running, the timer stops and the elapsed time is reset to zero.

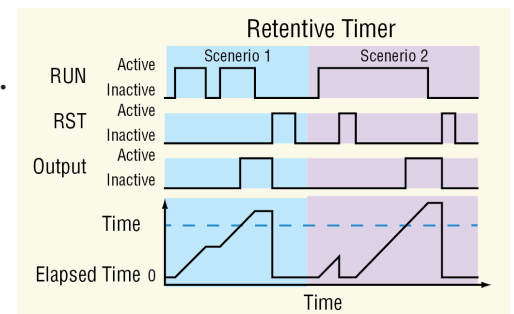

Note:

The elapsed time increments whenever the input is active and the reset is not, even if it exceeds the Time parameter setting.

Note:

The *active* and *inactive* states are user configurable with the parameters described below. Therefore, the description of the timer's behavior for its inputs and outputs refers to the active and inactive states for each rather than on or off. For example, if the input's active state is set to High, the timer starts running (becomes active) when the input changes from low (off to high (on)). However, if the input's active state is set to Low, the timer starts running (becomes active) when the input changes from high (on) to low (off).

Signals

Direction	Label	Type	Function
Receivers	RUN	Digital	Run signal. As long as RST is inactive, the timer runs when this input is active and holds when this input is inactive.
	RST	Digital	Reset signal. The output becomes inactive and the elapsed time is reset to zero when this input becomes active.
Transmitter	- - - -	Digital	Active whenever the elapsed time is greater than the specified time. Once on, the output remains on until the timer is reset.

Function

To measure how long the input is active and trigger the output when the cumulative time reaches a specified duration, set Function to *Retentive*.

Time

Set the cumulative amount of time the input must be active before the output becomes active.

Range: 0 to 99,999.000

Run Active Level

Set in which state at RUN the timer counts up.

Options:

- *High*: off
- *Low*: on

Reset Active Level

Set which state change at RST resets the timer.

Options:

- *High*: off to on
- *Low*: on to off

Transmitter Active Level

Set the state of the output that indicates the elapsed time is greater than or equal to the Time setting.

Options:

- *High*: On
- *Low*: Off

Elapsed Time

Indicates the cumulative time the input has been active since the timer was last reset.

Range: 0 to 99,999.000

Note:

The elapsed time is not retained through a power loss; it is set to zero upon power up.

Universal Input

Use this block to condition a temperature measurement made with a thermocouple or RTD or another analog process signal. Refer to the sections below for descriptions of the Universal Input and each sensor type it supports:

About the Universal Input: overview of this block.

Scaling Voltage and Current Inputs to Process Units: overview and example of linear scaling of process inputs.

Millivolts: use this sensor type to measure and condition and scale a voltage input.

Off: when set to off, the FB will be in error (Not Sourced).

Thermocouple: use this sensor type to condition a temperature measurement made with a thermocouple.

Volts: use this sensor type to measure, condition and scale a voltage input.

Milliamps: use this sensor type to measure, condition and scale a current input.

RTD 100 Ohm: use this sensor type to condition a temperature measurement made with an RTD.

RTD 1,000 Ohm: use this sensor type to condition a temperature measurement made with an RTD.

1K Potentiometer: use this sensor type to measure and scale a resistance input.

Universal Input Errors: this section describes the errors that may occur on the signal supplied by the Universal Input function block.

About the Universal Input

The Universal Input block scales the electrical signal received by the analog input hardware to a process value that can be used by other blocks such as an alarm. If the signal is from a thermocouple or RTD, once the Sensor Type, TC Linearization and RTD Leads parameters are set, the block scales the signal to an absolute temperature with no other configuration required.

Note:

Flex Modules can be ordered as Mixed I/O or High Density (HD) I/O. When HD modules are in use, the pinouts on the card are slightly different than Mixed I/O modules. Pinouts and the associated graphics are displayed for both.

Note:

Although the functionality and parameters for any given sensor type does not change with the selected Units, the graphic does. In the following descriptions, the associated graphics for the sensor type will be displayed for the selected units.

Scaling Voltage and Current Inputs to Process Units

If the signal is from a device that outputs a voltage or current proportional to the process value, set the Sensor Type, Units, Scale Low, Scale High, Range Low and Range High parameters to present the process value in the appropriate units. Scale Low and Range Low are the coordinates of one point and Scale High and Range High are the coordinates of another point defining the line relating the electrical signal to the conditioned process value produced by this block. See the figure below.

For example, a flow meter is connected to the universal input. The flow meter provides a current signal proportional to flow where 4 mA indicates 0 gallons per minute (gpm) and 20 mA indicates 10 gpm. With the scaling parameters set as listed below, when the universal input receives an 8 mA signal, the output of the block is 2.5 (gpm).

Sensor Type: Milliamps
 Units: Process
 Scale Low: 4 mA
 Scale High: 20 mA
 Range Low: 0 (gpm)
 Range High: 10 (gpm)

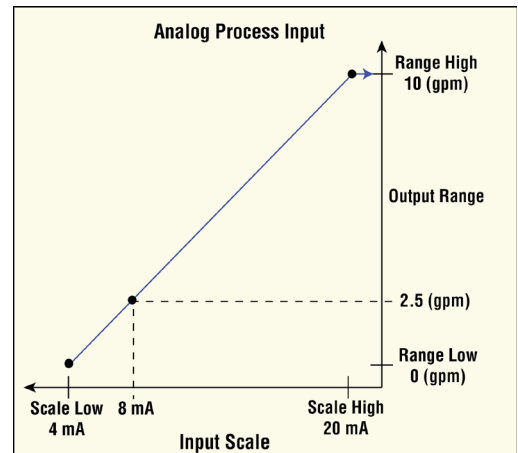

Millivolts/Volts

These FBs are found on the canvas of the FB diagram. The number of these FBs that are available depends on the number of flex modules with Universal Inputs installed and configured for voltage (millivolts or voltage).

The module number shown on the FB is the number of the data logger's slot that houses the flex module with the Universal Input. The Universal Input number indicates the specific input on the flex module.

Signals

Direction	Label	Type	Function
Transmitter	- - - -	Analog	The scaled electrical signal or process value with filter and offset applied

Name

Uniquely identify this FB using up to 20 alphanumeric characters.

Sensor Type

To detect and condition a voltage for use with other FBs, set Sensor Type to *Millivolts or Volts*.

Units

Set the units for the function's output.

Options:

- *Power*: the output is a percentage with 100% representing full power and 0% representing no power.
- *Process*: the output is in units of measure other than degrees Fahrenheit, degrees Celsius or relative humidity.
- *Relative Humidity*: the output is a measurement of percent relative humidity (%RH).
- *Absolute Temperature*: the output is a temperature on the Celsius or Fahrenheit scale.

Scale Low

Set the electrical signal level at which the Range Low setting is the desired indicated process value. Scale Low and Range Low are the coordinates of a point on the line that relates the electrical signal to the conditioned process value produced by this block. Consult the hardware specifications for the signal range supported by the specific hardware.

Use to set the minimum value of the process range in electrical units.

Range: -100.0 to 1000.0 VDC
-100.0 to 1000.0 mVDC

Scale High

Set the electrical signal level at which the Range High setting is the desired indicated process value. Scale High and Range High are the coordinates of a point on the line that relates the electrical signal to the conditioned process value produced by this block. Consult the hardware specifications for the signal range supported by the specific hardware.

Use to set maximum value of the process range in electrical units.

Range: -100.0 to 1000.0 VDC
-100.0 to 1000.0 mVDC

Range Low

Set the process value to be indicated when the electrical signal is equal to the Scale Low setting. Scale Low and Range Low are the coordinates of a point on the line that relates the electrical signal to the conditioned process value produced by this block.

Use to set the minimum value in process units.

Range: -99,999.000 to 99,999.000°F or units
-55,555 to 55,555°C

Range High

Set the process value to be indicated when the electrical signal is equal to the Scale High setting. Scale High and Range High are the coordinates of a point on the line that relates the electrical signal to the conditioned process value produced by this block.

Use to set the maximum value in process units.

Range: -99,999.000 to 99,999.000°F or units
-55,555 to 55,555°C

Process Error Enable

Set this parameter to enable low scale input error detection and response. Process inputs do not have intrinsic open/short detection. To enable detection of process errors set this parameter to Low.

Options: *Off, Low*

Process Error Low Value

When Process Error Enable is set to Low, set the minimum electrical signal level that is considered a good measurement. If the signal level to the hardware drops below this value, an error will be triggered.

Range: -100.0 to 1000.0 VDC
-100.0 to 1000.0 mVDC

Display Precision

Set how many decimal places are displayed for the process value and associated parameters such as set points.

Options: *Whole, Tenths, Hundredths, Thousandths*

Calibration Offset

Set a value to add to the measured input value to compensate for sensor placement, lead wire resistance or other factors that cause the input to vary from the actual process value.

Range: -99,999.000 to 99,999.000°F or units
-55,555 to 55,555°C

Filter

Set the amount of filtering to apply to the input. Filtering smooths signal fluctuations. Increase the time to increase filtering. Excessive filtering slows the input's response.

Range: 0.0 to 60.0 seconds

Input Error Latching

Set whether an input error persists until it is cleared or clears automatically when the sensor signal returns to a normal level.

Options:

- *Off*: error clears automatically once the input returns to normal.
- *On*: error remains active until the input returns to normal and the error is cleared by the Clear Error parameter.

Clear Error

Set this parameter to *Clear* to reset the input error after correcting the condition that caused it.

Options: *Ignore, Clear*

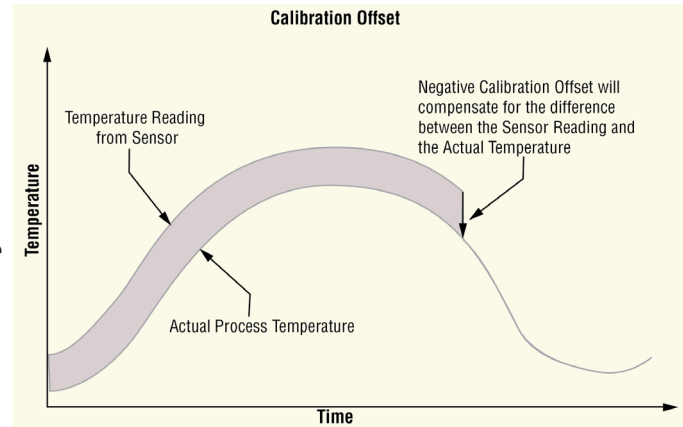

Off

When the Universal Input FB is set to Off, the output will have an indeterminate value.

Signals

Direction	Label	Type	Function
Transmitter	- - - -	Analog	No output when off.

Name

Uniquely identify this FB using up to 20 alphanumeric characters.

Sensor Type

To turn an input off, set Sensor Type to *Off*.

Thermocouple

This FB is found on the canvas of the FB diagram. The number of these FBs that are available depends on the number of flex modules with universal inputs installed and configured as a thermocouple.

The module number shown on the block is the number of the data logger's slot that houses the flex module with the universal input. The Universal Input number indicates the specific input on the flex module.

Signals

Direction	Label	Type	Function
Transmitter	- - - -	Analog	Supplies scaled, absolute temperature \pm the offset as a connection to another FB.

Name

Uniquely identify this FB using up to 20 alphanumeric characters.

Sensor Type

To detect and condition a temperature measurement set Sensor Type to *Thermocouple*.

TC Linearization

Select the Thermocouple type.

Options: *B, K, C, N, D, R, E, S, F, T, J*

Display Precision

Set how many decimal places are displayed for the process value and associated parameters such as set points.

Options: *Whole, Tenths, Hundredths, Thousandths*

Calibration Offset

Set a value to add to the measured input value to compensate for sensor placement, lead wire resistance or other factors that cause the input to vary from the actual process value

Range: -99,999.000 to 99,999.000°F or units
-55,555 to 55,555°C

Filter

Set the amount of filtering to apply to the input. Filtering smooths signal fluctuations. Increase the time to increase filtering. Excessive filtering slows the input's response.

Range: 0.0 to 60.0 second

Input Error Latching

Set whether an input error persists until it is cleared or clears automatically when the sensor signal returns to a normal level.

Options:

- *Off*: error clears automatically once the input returns to normal.
- *On*: error remains active until the input returns to normal and the error is cleared by the Clear Error parameter.

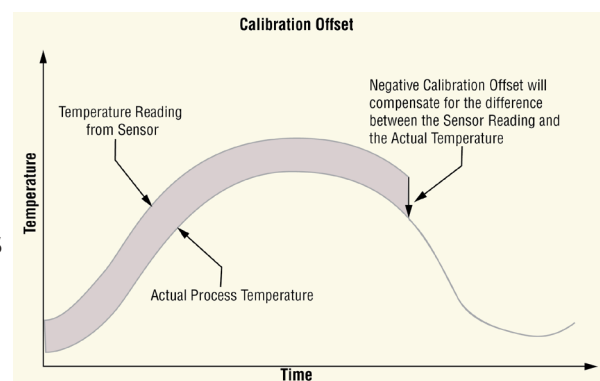

Clear Error

Set this parameter to *Clear* to reset the input error after correcting the condition that caused it.

Options: *Ignore, Clear*

Milliamps

These FBs are found on the canvas of the FB diagram. The number of these FBs that are available depends on the number of flex modules with Universal Inputs installed and configured for milliamps.

The module number shown on the FB is the number of the data logger's slot that houses the flex module with the Universal Input. The Universal Input number indicates the specific input on the flex module.

Signals

Direction	Label	Type	Function
Transmitter	- - - -	Analog	The scaled electrical signal or process value with filter and offset applied

Name

Uniquely identify this FB using up to 20 alphanumeric characters.

Sensor Type

To detect and condition a input current for use with other FBs, set Sensor Type to *Milliamps*.

Units

Set the units for the function's output.

Options:

- *Power*: the output is a percentage with 100% representing full power and 0% representing no power.
- *Process*: the output is in units of measure other than degrees Fahrenheit, degrees Celsius or relative humidity.
- *Relative Humidity*: the output is a measurement of percent relative humidity (%RH).
- *Absolute Temperature*: the output is a temperature on the Celsius or Fahrenheit scale.

Scale Low

Set the electrical signal level at which the Range Low setting is the desired indicated process value. Scale Low and Range Low are the coordinates of a point on the line that relates the electrical signal to the conditioned process value produced by this block. Consult the hardware specifications for the signal range supported by the specific hardware.

Use to set the minimum value of the process range in electrical units.

Range: -100.0 to 1000.0 VDC
-100.0 to 1000.0 mVDC

Scale High

Set the electrical signal level at which the Range High setting is the desired indicated process value. Scale High and Range High are the coordinates of a point on the line that relates the electrical signal to the conditioned process value produced by this block. Consult the hardware specifications for the signal range supported by the specific hardware.

Use to set maximum value of the process range in electrical units.

Range: -100.0 to 1000.0 VDC
-100.0 to 1000.0 mVDC

Range Low

Set the process value to be indicated when the electrical signal is equal to the Scale Low setting. Scale Low and Range Low are the coordinates of a point on the line that relates the electrical signal to the conditioned process value produced by this block.

Use to set the minimum value in process units.

Range: -99,999.000 to 99,999.000°F or units
-55,555 to 55,555°C

Range High

Set the process value to be indicated when the electrical signal is equal to the Scale High setting. Scale High and Range High are the coordinates of a point on the line that relates the electrical signal to the conditioned process value produced by this block.

Use to set the maximum value in process units.

Range: -99,999.000 to 99,999.000°F or units
-55,555 to 55,555°C

Process Error Enable

Set this parameter to enable low scale input error detection and response. Process inputs do not have intrinsic open/short detection. To enable detection of process errors set this parameter to Low.

Options: *Off, Low*

Process Error Low Value

When Process Error Enable is set to Low, set the minimum electrical signal level that is considered a good measurement. If the signal level to the hardware drops below this value, an error will be triggered.

Range: -100.0 to 1000.0 VDC
-100.0 to 1000.0 mVDC

Display Precision

Set how many decimal places are displayed for the process value and associated parameters such as set points.

Options: *Whole, Tenths, Hundredths, Thousandths*

Calibration Offset

Set a value to add to the measured input value to compensate for sensor placement, lead wire resistance or other factors that cause the input to vary from the actual process value.

Range: -99,999.000 to 99,999.000°F or units
-55,555 to 55,555°C

Filter

Set the amount of filtering to apply to the input. Filtering smooths signal fluctuations. Increase the time to increase filtering. Excessive filtering slows the input's response.

Range: 0.0 to 60.0 seconds

Input Error Latching

Set whether an input error persists until it is cleared or clears automatically when the sensor signal returns to a normal level.

Options:

- *Off*: error clears automatically once the input returns to normal.
- *On*: error remains active until the input returns to normal and the error is cleared by the Clear Error parameter.

Clear Error

Set this parameter to *Clear* to reset the input error after correcting the condition that caused it.

Options: *Ignore*, *Clear*

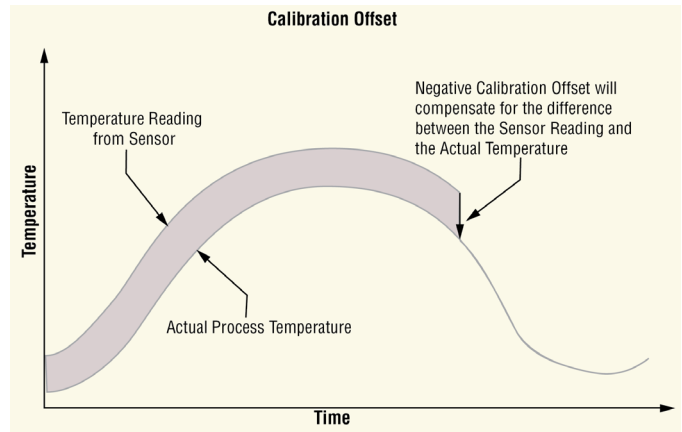

Resistance Temperature Device (RTD) 100 and 1000 Ohm

Use this block to condition a temperature measurement made with an RTD. This FB is found on the canvas of the FB diagram. The number of these FBs that are available depends on the number of flex modules with Universal Inputs installed and configured as an RTD with two or three wires.

The module number shown on the block is the number of the data logger's slot that houses the flex module with the universal input. The Universal Input number indicates the specific input on the flex module.

Signals

Direction	Label	Type	Function
Transmitter	- - - -	Analog	Supplies scaled, absolute temperature \pm the offset as a connection to another FB.

Name

Uniquely identify this FB using up to 20 alphanumeric characters.

Sensor Type

Select the input device.

Options: RTD 100 Ohm, RTD 1000 Ohm

RTD Leads

Set the number of sensor leads connected to the flex module.

Options: 2, 3

Display Precision

Set how many decimal places are displayed for the process value and associated parameters such as set points.

Options: *Whole, Tenths, Hundredths, Thousandths*

Calibration Offset

Set a value to add to the measured input value to compensate for sensor placement, lead wire resistance or other factors that cause the input to vary from the actual process value

Range: -99,999.000 to 99,999.000°F or units
-55,555 to 55,555°C

Filter

Set the amount of filtering to apply to the input. Filtering smooths signal fluctuations. Increase the time to increase filtering. Excessive filtering slows the input's response.

Range: 0.0 to 60.0 second

Input Error Latching

Set whether an input error persists until it is cleared or clears automatically when the sensor signal returns to a normal level.

Options:

- *Off*: error clears automatically once the input returns to normal.
- *On*: error remains active until the input returns to normal and the error is cleared by the Clear Error parameter.

Clear Error

Set this parameter to *Clear* to reset the input error after correcting the condition that caused it.

Options: *Ignore, Clear*

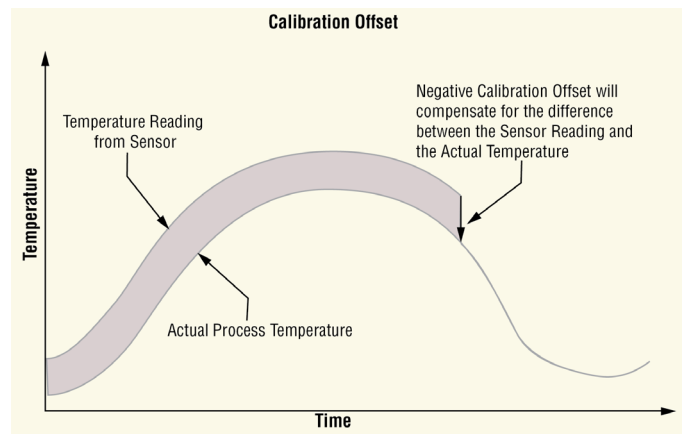

1K Potentiometer

Use this sensor type to measure and scale a resistance input. These FBs are found on the canvas of the FB diagram. The number of these FBs that are available depends on the number of flex modules with universal inputs installed and configured for a potentiometer input.

The module number shown on the block is the number of the data logger's slot that houses the flex module with the universal input. The Universal Input number indicates the specific input on the flex module.

Signals

Direction	Label	Type	Function
Transmitter	- - - -	Analog	Supplies scaled process value \pm the offset as a connection to another FB.

Name

Uniquely identify this FB using up to 20 alphanumeric characters.

Sensor Type

To detect and condition a resistance signal for use with other FBs, set Sensor Type to *Potentiometer*.

Units

Set the units for the function's output.

Options:

- *Power*: the output is a percentage with 100% representing full power and 0% representing no power.
- *Process*: the output is in units of measure other than degrees Fahrenheit, degrees Celsius or relative humidity.
- *Relative Humidity*: the output is a measurement of percent relative humidity (%RH).
- *Absolute Temperature*: the output is a temperature on the Celsius or Fahrenheit scale.

Scale Low

Set the electrical signal level at which the Range Low setting is the desired indicated process value. Scale Low and Range Low are the coordinates of a point on the line that relates the electrical signal to the conditioned process value produced by this block. Consult the hardware specifications for the signal range supported by the specific hardware.

Use to set the minimum value of the process range in electrical units.

Range: -100.0 to 1000.0 VDC
-100.0 to 1000.0 mVDC

Scale High

Set the electrical signal level at which the Range High setting is the desired indicated process value. Scale High and Range High are the coordinates of a point on the line that relates the electrical signal to the conditioned process value produced by this block. Consult the hardware specifications for the signal range supported by the specific hardware.

Use to set maximum value of the process range in electrical units.

Range: -100.0 to 1000.0 VDC
-100.0 to 1000.0 mVDC

Range Low

Set the process value to be indicated when the electrical signal is equal to the Scale Low setting. Scale Low and Range Low are the coordinates of a point on the line that relates the electrical signal to the conditioned process value produced by this block.

Use to set the minimum value in process units.

Range: -99,999.000 to 99,999.000°F or units
-55,555 to 55,555°C

Range High

Set the process value to be indicated when the electrical signal is equal to the Scale High setting. Scale High and Range High are the coordinates of a point on the line that relates the electrical signal to the conditioned process value produced by this block.

Use to set the maximum value in process units.

Range: -99,999.000 to 99,999.000°F or units
-55,555 to 55,555°C

Process Error Enable

Set this parameter to enable low scale input error detection and response. Process inputs do not have intrinsic open/short detection. To enable detection of process errors set this parameter to Low.

Options: *Off, Low*

Process Error Low Value

When Process Error Enable is set to Low, set the minimum electrical signal level that is considered a good measurement. If the signal level to the hardware drops below this value, an error will be triggered.

Range: -100.0 to 1000.0 VDC
-100.0 to 1000.0 mVDC

Display Precision

Set how many decimal places are displayed for the process value and associated parameters such as set points.

Options: *Whole, Tenths, Hundredths, Thousandths*

Calibration Offset

Set a value to add to the measured input value to compensate for sensor placement, lead wire resistance or other factors that cause the input to vary from the actual process value.

Range: -99,999.000 to 99,999.000°F or units
-55,555 to 55,555°C

Filter

Set the amount of filtering to apply to the input. Filtering smooths signal fluctuations. Increase the time to increase filtering. Excessive filtering slows the input's response.

Range: 0.0 to 60.0 seconds

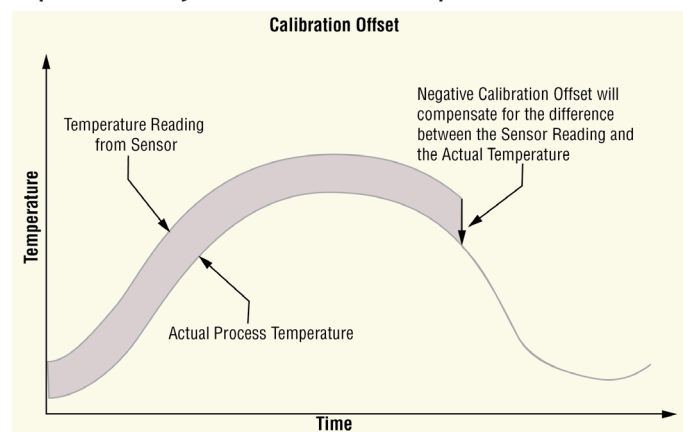

Input Error Latching

Set whether an input error persists until it is cleared or clears automatically when the sensor signal returns to a normal level.

Options:

- *Off*: error clears automatically once the input returns to normal.
- *On*: error remains active until the input returns to normal and the error is cleared by the Clear Error parameter.

Clear Error

Set this parameter to *Clear* to reset the input error after correcting the condition that caused it.

Options: *Ignore*, *Clear*

Universal Input Errors

Error Status	Description
None	No error is detected.
Open	A sensor is broken or disconnected.
Shorted	A sensor has failed or is shorted.
Measurement Error	A measurement error has occurred.
Bad Calibration	The data logger has not been calibrated.
Ambient Error	The ambient temperature is outside of the data logger's operating range.
RTD Error	An RTD sensor error has occurred.
Fail	A measurement failure has occurred.
Not Sourced	An input signal is not connected to a function block's output.
Stale Data	Data sourced from another data logger has become unavailable.

Variable

Use a variable to allow a user to set and modify an analog or digital signal value that is an input to another block. This block is found in the Function Block Diagram editor's Library when working with a data logger that offers the Variable block. The number of these blocks available to be added to the diagram is shown within the parenthesis.

Choose the type of variable with the Data Type parameter. These options for the Data Type parameter are described in detail in the following sections:

Analog: variable holds a user-set, analog value for use as an input to another block.

Digital: variable holds a user-set, digital or Boolean state for use as an input to another block.

Analog

- *Power*: Use this function to integrate a user-set, power level or percentage in to the application. When the Data Type is Analog and Units is Power, the Variable function appears as shown at the left.

- **Process:** Use this function to integrate a user-set, analog value that has units other than degrees C or degrees F or is a pure number in to the application. When the Data Type is Analog and Units is None or Process, the Variable function appears as shown at the left.
- **Relative Humidity:** Use this function to integrate a user-set, relative humidity in to the application. When the Data Type is Analog and Units is Relative Humidity, the Variable function appears as shown at the left.
- **Absolute Temperature:** Use this function to integrate a user-set, absolute temperature in to the application. When the Data Type is Analog and Units is Absolute Temperature, the Variable function appears as shown at the left. See Units below for more information on when to use relative temperature vs. absolute temperature.
- **Relative Temperature:** Use this function to integrate a user-set, relative temperature in to the application. When the Data Type is Analog and Units is Relative Temperature, the Variable function appears as shown at the left. See Units below for more information on when to use relative temperature vs. absolute temperature.

Signals

Direction	Label	Type	Function
Transmitter	- - - -	Analog	The value set by the user with the Analog parameter in the units specified with the Units parameter

Name

Uniquely identify this FB using up to 20 alphanumeric characters.

Data Type

To configure the variable to hold a user-set, analog value, set Data Type to *Analog*.

Units

Set the units of the function's output.

Options:

- **None:** the output is a pure number without units.
- **Power:** the output is a percentage with 100% representing full power, 0% representing no power and, for some uses, -100% representing full cooling.
- **Process:** the output is in units of measure other than degrees Fahrenheit, degrees Celsius or relative humidity.
- **Relative Humidity:** the output is in percent relative humidity (%RH).
- **Absolute Temperature:** the output is a temperature on the Celsius or Fahrenheit scale. For example, 33°F as an absolute temperature is one degree above the freezing point of water. An absolute temperature can be used as a set point or compared with other temperatures to determine which is hotter or colder.
- **Relative Temperature:** the output is a relative number of degrees, not an absolute temperature. For example, the difference between the two measured temperatures, 120°C and 100°C is 20 degrees, but it is not the temperature 20°C. A relative temperature is appropriate for use as a calibration offset or a deviation alarm set point.

Analog

Set the value of the function's output.

Range: -99,999.000 to 99,999.000

Digital

Use this block to integrate a digital (on or off) or Boolean (true or false) state in to the application.

Signals

Direction	Label	Type	Function
Transmitter	- - - -	Digital	The state set by the user with the Digital parameter

Name

Uniquely identify this FB using up to 20 alphanumeric characters.

Data Type

To configure the variable to hold a user-set, digital state or Boolean value, set Data Type to *Digital*.

Digital

Set the state of the function's output.

Options:

- *On*: On or True
- *Off*: Off or False

6

Chapter 6: Appendix

Communications

The D4T data logger is equipped with Modbus® TCP and Standard Commands for Programmable Instruments as embedded protocols.

Introduction to Standard Commands for Programmable Instruments (SCPI)

This protocol was originally designed in the 1960s by Hewlett-Packard using the IEEE 488 standard (8-bit parallel bus) and was created for the primary purpose of allowing computers to talk with programmable instrumentation. SCPI commands are ASCII text strings with a wide array of defined SCPI commands, all of which are not included in this implementation. Although the SCPI protocol can be deployed over multiple physical layers Watlow has implemented this protocol over Ethernet port 502. The available SCPI commands are shown below:

IEEE 488.2 commands

*IDN? Identification Query

Commands for process value measurements

:UNIT:TEMPerature? Read communications temperature units

:UNIT:TEMPerature C Set communications temperature units to C

:UNIT:TEMPerature F Set communications temperature units to F

:UNIT:TEMPerature:DISPlay? Read displayed temperature units

:UNIT:TEMPerature:DISPlay C Set displayed temperature units to C

:UNIT:TEMPerature:DISPlay F Set displayed temperature units to F

Commands to provide access to soft key

:KEY#[:STATe]? Query key state

:KEY#[:STATe] ON Set key state ON

:KEY#[:STATe] OFF Set key state OFF

:KEY#:NAME? Query key name

Introduction to the Modbus Protocol

Gould Modicon, now called AEG Schneider, first created the protocol Referred to as Modbus RTU used in process control systems. Modbus provides the advantage of being extremely reliable in exchanging information, a highly desirable feature for industrial data communications. This protocol works on the principle of packet exchanges. The packet contains the address of the data logger to receive the information, a command field that says what is to be done with the information, and several fields of data. Each D4T parameter has a unique Modbus address and they can be found in the table below.

All Modbus registers are 16-bits and are listed in the following table as relative addresses (actual). Some D4T parameters are contained within 32 bits (IEEE float, signed 32 bit), notice that only one (low order) of the two registers is listed. By default, the low order word contains the two low bytes of the 32-bit parameter. As an example, in the table below find the Universal Input and then take a close look at the first member ([Analog Input Value](#)). Note that it lists register 27586. Because this parameter is a float, it is actually represented by registers 27586 (low order bytes) and 27587 (high order bytes) as stated above. The Modbus specification does not dictate which register should be high or low order therefore, Watlow provides the user the ability to swap this order.

Note:

For the purpose of making an easy transition from the F4 to the D4T data logger using Modbus, a special set of the most commonly used F4 registers were created. Notice that there are two tables of Modbus registers, they are unique sets of registers (not interchangeable) and the user must select one set or the other when implementing using Modbus.

- Map 1 = [D4T registers](#) (default)
- Map 2 = Limited set of [F4 compatible registers](#)

To change the Modbus mapping using the D4T front panel:

1. From any screen, push the **Menu** button
2. Push the **Settings** button and then the **Network** button
3. Select the **Ethernet** communications channel
4. Scroll the screen down to find Data Map and select **1** or **2**.

Enabling Data Logging Using Modbus

To enable data logging when using the Modbus communications protocol:

1. Load Modbus register 19038 "Log Data" with 106 (yes).
2. Write Modbus registers to the data logger.

Or

Manually enable data logging

1. Think about and modify the following Modbus registers if need be:
 - Memory Full Action, Modbus register 42350 [**Stop** or **Overwrite**]
 - File Size Limit, Modbus register 42372 [**20 MB** or 1/4 of the available memory]
 - Log Interval, Modbus register 42388 [0.1, 0.2, 0.5, 1, 2, 5, 10, 15 and 30 seconds, 1, 2, 5, 10, 15, 30 and 60 minutes]
2. Load Modbus register 42386 "Log Action" with 1782 [**start**].
3. Write Modbus registers to the data logger.

Note:

To see a full listing of data log Modbus registers and associated enumerated values, navigate to the table section entitled "[Logging](#)".

Modbus Table Orientation

In the tables that follow, each page will contain a header that describes available parameters and their associated Modbus addresses. Further explanation can be found below. When encountered throughout this document, the word "default" implies as shipped from the factory.

① Parameter Name	② Range	③ Default	④ Data Type and Access (R/W)	Modbus® Relative Address ⑤
---------------------	------------	--------------	---------------------------------------	----------------------------

Parameter Name - identifies the member name within a particular function.

Range - Defines options available for this prompt, i.e., min/max values (numerical), yes/no, etc... (further explanation below).

Default - Values as delivered from the factory.

- r *Data Type and Access (R/W)* - Unsigned 16 bit integer, Signed 32-bit, long, string = ASCII (8 bits per character), float = IEEE 754 32-bit, RW = Readable, Writable
- t *Modbus Relative Address* - Identifies unique parameters addresses using either the Modbus RTU or Modbus TCP protocols (further explanation below).

Range

Within this column notice that on occasion there will be numbers found within parenthesis. These numbers represent the enumerated value for that particular selection. Over Modbus, range selections can be made simply by writing the enumerated value of choice to the desired parameter. As an example, find the Sensor Type under the Universal Input. To turn the sensor off using Modbus, simply write the value of 62 (off) to register 27594 (if in slot 1) and send that value to the data logger.

Parameter Name	Range	Default	Data Type and Access (R/W)	Modbus® Relative Address
Sensor Type	Off (62) Thermocouple (95) Millivolts (56) Volts (104) Milliamps (112) RTD 100 Ohm (113) RTD 1,000 Ohm (114) 1K Potentiometer (155)	Thermocouple	unsigned 16-bit RW	Universal Input 1: Module 1, 27594 Universal Input 1: Module 2, 28034 Universal Input 1: Module 3, 28474 Universal Input 1: Module 4, 28914 Universal Input 1: Module 5, 29354 Universal Input 1: Module 6, 29794 Add 110 for the address of the next input

Modbus Relative Address

Within this column the listed address can also be referred to as the base address. To determine the address of any given member within a particular function see the example below.

To read the third thermocouple value from a Universal Input module (FMHA-RAAA-AAAA, High Density I/O) that is placed in slot 5 of the data logger follow the steps below:

1. Find the Universal Input and locate the [Analog Input Value](#).
2. Identify the slot (module) in which the module resides and its associated base address (base address is displayed for each module/slot).
3. Note offset (red arrow) to the next Modbus address from the base, in this case 110.
4. Multiply the displayed offset by two and add that to the base number $(110 \times 2) + 29346$.

Parameter Name	Range	Default	Data Type and Access (R/W)	Modbus® Relative Address
Universal Input				
Analog Input Value	-99,999 to 99,999		IEEE Float R	Universal Input 1: Module 1, 27586 Universal Input 1: Module 2, 28026 Universal Input 1: Module 3, 28466 Universal Input 1: Module 4, 28906 Universal Input 1: Module 5, 29346 Universal Input 1: Module 6, 29786 Add 110 for the address of the next input

D4T Modbus Registers (Map 1)

Parameter Class and Name	Range	Default	Data Type and Attributes	Modbus Registers
Device Details (See p.16)				
Hardware ID	65535		"signed 32-bit Access=R "	0
Software Release Version	0 To 2147483647		"signed 32-bit Access=R"	4
Software Prototype Version	0 To 2147483647		"signed 32-bit Access=R"	6
Software Build Number	0 To 2147483647		"signed 32-bit Access=R"	8
Serial Number	0 To 2147483647		"signed 32-bit Access=R"	12

Parameter Class and Name	Range	Default	Data Type and Attributes	Modbus Registers
Date of Manufacture	0 To 2147483647		"signed 32-bit Access=R"	14
D4T Part Number	15 To 15		"string Access=R"	16
Device Name	0 To 32	D4T	"string Access=RW"	46
Restore Settings From	"None (61) Factory (31)"	None (61)	"unsigned 16-bit Access = RW"	86
Device Status	"OK (138) Fail (32)"		"unsigned 16-bit Access = R"	90
AC Line Frequency	"50 Hz (3) 60 Hz (4)"	60 Hz (4)	"unsigned 16-bit Access = RW"	94
Display				
Display Units	"F (30) C (15)"	F (30)	"unsigned 16-bit Access = RW"	1328
Alarm (See: p.58)				
Type	"Off (62) Process Alarm (76) Deviation Alarm (24)"	Off (62)	"unsigned 16-bit Access = RW"	"Alarm 1: 1330 Alarm n: 1330+((n-1)* 100)"
Sides	"Both (13) High (37) Low (53)"	Both (13)	"unsigned 16-bit Access = RW"	"Alarm 1: 1332 Alarm n: 1332+((n-1)* 100)"
High Set Point	-99999 To 99999	300.0	"IEEE Float Access=RW"	"Alarm 1: 1334 Alarm n: 1334+((n-1)* 100)"
Low Set Point	-99999 To 99999	32.0	"IEEE Float Access=RW"	"Alarm 1: 1336 Alarm n: 1336+((n-1)* 100)"
Hysteresis	0.001 To 9999	1.0	"IEEE Float Access=RW"	"Alarm 1: 1338 Alarm n: 1338+((n-1)* 100)"
Silencing	"Off (62) On (63)"	Off (62)	"unsigned 16-bit Access = RW"	"Alarm 1: 1340 Alarm n: 1340+((n-1)* 100)"
Latching	"Non-Latching (60) Latching (49)"	Non-Latching (60)	"unsigned 16-bit Access = RW"	"Alarm 1: 1342 Alarm n: 1342+((n-1)* 100)"
Blocking	"Off (62) Startup (88) Set Point (85) Both (13)"	Off (62)	"unsigned 16-bit Access = RW"	"Alarm 1: 1344 Alarm n: 1344+((n-1)* 100)"
Logic	"Close On Alarm (17) Open On Alarm (66)"	Close On Alarm (17)	"unsigned 16-bit Access = RW"	"Alarm 1: 1346 Alarm n: 1346+((n-1)* 100)"
Delay Time	0 To 9999	0	"unsigned 16-bit Access=RW"	"Alarm 1: 1348 Alarm n: 1348+((n-1)* 100)"
Output Value	"On (63) Off (62)"		"unsigned 16-bit Access = R"	"Alarm 1: 1350 Alarm n: 1350+((n-1)* 100)"
Clear Alarm	"Ignore (204) Clear (129)"	Ignore (204)	"unsigned 16-bit Access = RW"	"Alarm 1: 1352 Alarm n: 1352+((n-1)* 100)"

Parameter Class and Name	Range	Default	Data Type and Attributes	Modbus Registers
Silence Alarm	"Ignore (204) Silence Alarms (108)"	Ignore (204)	"unsigned 16-bit Access = RW"	"Alarm 1: 1354 Alarm n: 1354+((n-1)* 100)"
Alarm State	"Startup (88) None (61) Blocked (12) Alarm Low (8) Alarm High (7) Error (28)"		"unsigned 16-bit Access = R"	"Alarm 1: 1356 Alarm n: 1356+((n-1)* 100)"
Alarm Latched	"No (59) Yes (106)"		"unsigned 16-bit Access = R"	"Alarm 1: 1358 Alarm n: 1358+((n-1)* 100)"
Alarm Silenced	"No (59) Yes (106)"		"unsigned 16-bit Access = R"	"Alarm 1: 1360 Alarm n: 1360+((n-1)* 100)"
Alarm Clearable	"No (59) Yes (106)"		"unsigned 16-bit Access = R"	"Alarm 1: 1362 Alarm n: 1362+((n-1)* 100)"
Alarm Working Process Value	-99999 To 99999		"IEEE Float Access=R"	"Alarm 1: 1370 Alarm n: 1370+((n-1)* 100)"
Source Value B	-99999 To 99999		"IEEE Float Access=R "	"Alarm 1: 1378 Alarm n: 1378+((n-1)* 100)"
Source Value C	"On (63) Off (62)"		"unsigned 16-bit Access = R"	"Alarm 1: 1386 Alarm n: 1386+((n-1)* 100)"
Silence Active Level	"High (37) Low (53)"	High (37)	"unsigned 16-bit Access = RW"	"Alarm 1: 1388 Alarm n: 1388+((n-1)* 100)"
Source Value D	"On (63) Off (62)"		"unsigned 16-bit Access = R"	"Alarm 1: 1396 Alarm n: 1396+((n-1)* 100)"
Clear Active Level	"High (37) Low (53)"	High (37)	"unsigned 16-bit Access = RW"	"Alarm 1: 1398 Alarm n: 1398+((n-1)* 100)"
Source Value E	"On (63) Off (62)"		"unsigned 16-bit Access = R"	"Alarm 1: 1406 Alarm n: 1406+((n-1)* 100)"
Off Active Level	"High (37) Low (53)"	High (37)	"unsigned 16-bit Access = RW"	"Alarm 1: 1408 Alarm n: 1408+((n-1)* 100)"
Error	"None (61) Open (65) Shorted (127) Measurement Error (140) Bad Calibration Data (139) Ambient Error (9) RTD Error (141) Fail (32) Math Error (1423) Not Sourced (246) Stale (1617)"		"unsigned 16-bit Access = R"	"Alarm 1: 1414 Alarm n: 1414+((n-1)* 100)"
Display	"Off (62) On (63)"	On (63)	"unsigned 16-bit Access = RW"	"Alarm 1: 1418 Alarm n: 1418+((n-1)* 100)"

Parameter Class and Name	Range	Default	Data Type and Attributes	Modbus Registers
Counter (See: p.71)				
Source Value A	"On (63) Off (62)"		"unsigned 16-bit Access = R "	"Counter 1: 5462 Counter n: 5462+((n-1)* 50)"
Source Value B	"On (63) Off (62)"		"unsigned 16-bit Access = R "	"Counter 1: 5464 Counter n: 5464+((n-1)* 50)"
Function	"Up (1456) Down (1457)"	Up (1456)	"unsigned 16-bit Access = RW"	"Counter 1: 5466 Counter n: 5466+((n-1)* 50)"
Output Value	"On (63) Off (62)"		"unsigned 16-bit Access = R"	"Counter 1: 5468 Counter n: 5468+((n-1)* 50)"
Count Active Level	"High (37) Low (53) Both (13)"	High (37)	"unsigned 16-bit Access = RW"	"Counter 1: 5470 Counter n: 5470+((n-1)* 50)"
Reset Active Level	"High (37) Low (53)"	High (37)	"unsigned 16-bit Access = RW"	"Counter 1: 5472 Counter n: 5472+((n-1)* 50)"
Load Value	0 To 9999	0	"unsigned 16-bit Access=RW"	"Counter 1: 5474 Counter n: 5474+((n-1)* 50)"
Target Value	0 To 9999	9999	"unsigned 16-bit Access=RW"	"Counter 1: 5476 Counter n: 5476+((n-1)* 50)"
Count	0 To 9999		"unsigned 16-bit Access=R"	"Counter 1: 5478 Counter n: 5478+((n-1)* 50)"
Error	"None (61) Open (65) Shorted (127) Measurement Error (140) Bad Calibration Data (139) Ambient Error (9) RTD Error (141) Fail (32) Math Error (1423) Not Sourced (246) Stale (1617)"		"unsigned 16-bit Access = R"	"Counter 1: 5480 Counter n: 5480+((n-1)* 50)"
Latching	"No (59) Yes (106)"	No (59)	"unsigned 16-bit Access = RW"	"Counter 1: 5482 Counter n: 5482+((n-1)* 50)"
Ethernet, Modbus				
Display Units	"F (30) C (15)"	F (30)	"unsigned 16-bit Access = RW"	6730
Modbus TCP Enable	"No (59) Yes (106)"	Yes (106)	"unsigned 16-bit Access = RW"	6734
Modbus Word Order	"High Low (1330) Low High (1331)"	Low High (1331)	"unsigned 16-bit Access = RW"	6736
EtherNet/IP Enable	"No (59) Yes (106)"	Yes (106)	"unsigned 16-bit Access = RW"	6738

Parameter Class and Name	Range	Default	Data Type and Attributes	Modbus Registers
Data Map	" 1 To 2 1=D4T Modbus Register Set 2=F4 Compatible Register Set"	1	"unsigned 8-bit Access=RW"	6740
IP Address Mode	"DHCP (1281) Fixed (1284)"	DHCP (1281)	"unsigned 16-bit Access = RW"	6760
IP Fixed Address Part 1	0 To 255	192	"unsigned 8-bit Access=RW"	6762
IP Fixed Address Part 2	0 To 255	168	"unsigned 8-bit Access=RW"	6764
IP Fixed Address Part 3	0 To 255	0	"unsigned 8-bit Access=RW"	6766
IP Fixed Address Part 4	0 To 255	222	"unsigned 8-bit Access=RW"	6768
IP Fixed Address Part 5	0 To 255	0	"unsigned 8-bit Access=RW"	6770
IP Fixed Address Part 6	0 To 255	0	"unsigned 8-bit Access=RW"	6772
IP Fixed Subnet Part 1	0 To 255	255	"unsigned 8-bit Access=RW"	6774
IP Fixed Subnet Part 2	0 To 255	255	"unsigned 8-bit Access=RW"	6776
IP Fixed Subnet Part 3	0 To 255	255	"unsigned 8-bit Access=RW"	6778
IP Fixed Subnet Part 4	0 To 255	0	"unsigned 8-bit Access=RW"	6780
IP Fixed Subnet Part 5	0 To 255	0	"unsigned 8-bit Access=RW"	6782
IP Fixed Subnet Part 6	0 To 255	0	"unsigned 8-bit Access=RW"	6784
Fixed IP Gateway Part 1	0 To 255	0	"unsigned 8-bit Access=RW"	6786
Fixed IP Gateway Part 2	0 To 255	0	"unsigned 8-bit Access=RW"	6788
Fixed IP Gateway Part 3	0 To 255	0	"unsigned 8-bit Access=RW"	6790
Fixed IP Gateway Part 4	0 To 255	0	"unsigned 8-bit Access=RW"	6792
Fixed IP Gateway Part 5	0 To 255	0	"unsigned 8-bit Access=RW"	6794
Fixed IP Gateway Part 6	0 To 255	0	"unsigned 8-bit Access=RW"	6796
Actual IP Addressing Mode	"None (61) DHCP (1281) Fixed (1284) Fail (32)"		"unsigned 16-bit Access = R"	6798
IP Actual Address Part 1	0 To 255		"unsigned 8-bit Access=R"	6806
IP Actual Address Part 2	0 To 255		"unsigned 8-bit Access=R"	6808
IP Actual Address Part 3	0 To 255		"unsigned 8-bit Access=R"	6810

Parameter Class and Name	Range	Default	Data Type and Attributes	Modbus Registers
IP Actual Address Part 4	0 To 255		"unsigned 8-bit Access=R"	6812
IP Actual Address Part 5	0 To 255		"unsigned 8-bit Access=R"	6814
IP Actual Address Part 6	0 To 255		"unsigned 8-bit Access=R"	6816
MAC Address	0 To 255		"unsigned 8-bit Access=R"	6818
MAC Address	0 To 255		"unsigned 8-bit Access=R"	6820
MAC Address	0 To 255		"unsigned 8-bit Access=R"	6822
MAC Address	0 To 255		"unsigned 8-bit Access=R"	6824
MAC Address	0 To 255		"unsigned 8-bit Access=R"	6826
MAC Address	0 To 255		"unsigned 8-bit Access=R"	6828
Key (See: p.80)				
Function	"Momentary (1714) Toggle (1713) On Pulse (1471)"	Momentary (1714)	"unsigned 16-bit Access = RW"	"Function Key 1: 6840 Function Key n: 6840+((n-1)* 20)"
Time	0 To 99999	1.0	"IEEE Float Access=RW"	"Function Key 1: 6842 Function Key n: 6842+((n-1)* 20)"
Input State	"On (63) Off (62)"		"unsigned 16-bit Access = R"	"Function Key 1: 6844 Function Key n: 6844+((n-1)* 20)"
Key Action	"Down (1457) Up (1456)"	Up (1456)	"unsigned 16-bit Access = RW"	"Function Key 1: 6850 Function Key n: 6850+((n-1)* 20)"
Error	"None (61) Open (65) Shorted (127) Measurement Error (140) Bad Calibration Data (139) Ambient Error (9) RTD Error (141) Fail (32) Math Error (1423) Not Sourced (246) Stale (1617)"		"unsigned 16-bit Access = R"	"Function Key 1: 6852 Function Key n: 6852+((n-1)* 20)"
Logic (See p.88)				
Source Value A	"On (63) Off (62)"		"unsigned 16-bit Access = R "	"Logic 1: 6968 Logic n: 6968+((n-1)* 90)"
Source Value B	"On (63) Off (62)"		"unsigned 16-bit Access = R "	"Logic 1: 6970 Logic n: 6970+((n-1)* 90)"
Source Value C	"On (63) Off (62)"		"unsigned 16-bit Access = R "	"Logic 1: 6972 Logic n: 6972+((n-1)* 90)"

Parameter Class and Name	Range	Default	Data Type and Attributes	Modbus Registers
Source Value D	"On (63) Off (62)"		"unsigned 16-bit Access = R"	"Logic 1: 6974 Logic n: 6974+((n-1)* 90)"
Source Value E	"On (63) Off (62)"		"unsigned 16-bit Access = R"	"Logic 1: 6976 Logic n: 6976+((n-1)* 90)"
Source Value F	"On (63) Off (62)"		"unsigned 16-bit Access = R"	"Logic 1: 6978 Logic n: 6978+((n-1)* 90)"
Source Value G	"On (63) Off (62)"		"unsigned 16-bit Access = R"	"Logic 1: 6980 Logic n: 6980+((n-1)* 90)"
Source Value H	"On (63) Off (62)"		"unsigned 16-bit Access = R"	"Logic 1: 6982 Logic n: 6982+((n-1)* 90)"
Function	"Off (62) And (1426) Nand (1427) Or (1442) Nor (1443) Equal To (1437) Not Equal To (1438) Latch (1444) RS Flip Flop (1693)"	Off (62)	"unsigned 16-bit Access = RW"	"Logic 1: 6984 Logic n: 6984+((n-1)* 90)"
Output Value	"On (63) Off (62)"		"unsigned 16-bit Access = R"	"Logic 1: 6986 Logic n: 6986+((n-1)* 90)"
Error Handling	"True Good (1476) True Bad (1477) False Good (1478) False Bad (1479)"	False Bad (1479)	"unsigned 16-bit Access = RW"	"Logic 1: 6988 Logic n: 6988+((n-1)* 90)"
Error	"None (61) Open (65) Shorted (127) Measurement Error (140) Bad Calibration Data (139) Ambient Error (9) RTD Error (141) Fail (32) Math Error (1423) Not Sourced (246) Stale (1617)"		"unsigned 16-bit Access = R"	"Logic 1: 6990 Logic n: 6990+((n-1)* 90)"
Linearization (See p.81)				
Source Value A			"IEEE Float Access=R"	"Linearization 1: 11606 Linearization n: 11606+((n-1)* 70)"
Function	"Off (62) Interpolated (1482) Stepped (1483)"	Off (62)	"unsigned 16-bit Access = RW"	"Linearization 1: 11608 Linearization n: 11608+((n-1)* 70)"
Offset	-99999 To 99999	0	"IEEE Float Access=RW"	"Linearization 1: 11610 Linearization n: 11610+((n-1)* 70)"
Output Value	-99999 To 99999		"IEEE Float Access=R"	"Linearization 1: 11612 Linearization n: 11612+((n-1)* 70)"

Parameter Class and Name	Range	Default	Data Type and Attributes	Modbus Registers
Input Point 1	-99999 To 99999	0.0	"IEEE Float Access=RW"	"Linearization 1: 11614 Linearization n: 11614+((n-1)* 70)"
Input Point 2	-99999 To 99999	1.0	"IEEE Float Access=RW"	"Linearization 1: 11616 Linearization n: 11616+((n-1)* 70)"
Input Point 3	-99999 To 99999	2.0	"IEEE Float Access=RW"	"Linearization 1: 11618 Linearization n: 11618+((n-1)* 70)"
Input Point 4	-99999 To 99999	3.0	"IEEE Float Access=RW"	"Linearization 1: 11620 Linearization n: 11620+((n-1)* 70)"
Input Point 5	-99999 To 99999	4.0	"IEEE Float Access=RW"	"Linearization 1: 11622 Linearization n: 11622+((n-1)* 70)"
Input Point 6	-99999 To 99999	5.0	"IEEE Float Access=RW"	"Linearization 1: 11624 Linearization n: 11624+((n-1)* 70)"
Input Point 7	-99999 To 99999	6.0	"IEEE Float Access=RW"	"Linearization 1: 11626 Linearization n: 11626+((n-1)* 70)"
Input Point 8	-99999 To 99999	7.0	"IEEE Float Access=RW"	"Linearization 1: 11628 Linearization n: 11628+((n-1)* 70)"
Input Point 9	-99999 To 99999	8.0	"IEEE Float Access=RW"	"Linearization 1: 11630 Linearization n: 11630+((n-1)* 70)"
Input Point 10	-99999 To 99999	9.0	"IEEE Float Access=RW"	"Linearization 1: 11632 Linearization n: 11632+((n-1)* 70)"
Output Point 1	-99999 To 99999	0.0	"IEEE Float Access=RW"	"Linearization 1: 11634 Linearization n: 11634+((n-1)* 70)"
Output Point 2	-99999 To 99999	1.0	"IEEE Float Access=RW"	"Linearization 1: 11636 Linearization n: 11636+((n-1)* 70)"
Output Point 3	-99999 To 99999	2.0	"IEEE Float Access=RW"	"Linearization 1: 11638 Linearization n: 11638+((n-1)* 70)"
Output Point 4	-99999 To 99999	3.0	"IEEE Float Access=RW"	"Linearization 1: 11640 Linearization n: 11640+((n-1)* 70)"
Output Point 5	-99999 To 99999	4.0	"IEEE Float Access=RW"	"Linearization 1: 11642 Linearization n: 11642+((n-1)* 70)"
Output Point 6	-99999 To 99999	5.0	"IEEE Float Access=RW"	"Linearization 1: 11644 Linearization n: 11644+((n-1)* 70)"
Output Point 7	-99999 To 99999	6.0	"IEEE Float Access=RW"	"Linearization 1: 11646 Linearization n: 11646+((n-1)* 70)"
Output Point 8	-99999 To 99999	7.0	"IEEE Float Access=RW"	"Linearization 1: 11648 Linearization n: 11648+((n-1)* 70)"

Parameter Class and Name	Range	Default	Data Type and Attributes	Modbus Registers
Output Point 9	-99999 To 99999	8.0	"IEEE Float Access=RW"	"Linearization 1: 11650 Linearization n: 11650+((n-1)* 70)"
Output Point 10	-99999 To 99999	9.0	"IEEE Float Access=RW"	"Linearization 1: 11652 Linearization n: 11652+((n-1)* 70)"
Error	"None (61) Open (65) Shorted (127) Measurement Error (140) Bad Calibration Data (139) Ambient Error (9) RTD Error (141) Fail (32) Math Error (1423) Not Sourced (246) Stale (1617)"	- - - -	"unsigned 16-bit Access = R"	"Linearization 1: 11654 Linearization n: 11654+((n-1)* 70)"
Units	"Source (1539) None (61) Absolute Temperature (1540) Relative Temperature (1541) Power (73) Process (75) Relative Humidity (1538)"	Source (1539)	"unsigned 16-bit Access = RW"	"Linearization 1: 11656 Linearization n: 11656+((n-1)* 70)"
Math (See: p.96)				
Source Value A	-99999 To 99999	- - - -	"IEEE Float Access=R "	"Math 1: 12190 Math n: 12190+((n-1)* 80)"
Source Value B	-99999 To 99999	- - - -	"IEEE Float Access=R "	"Math 1: 12192 Math n: 12192+((n-1)* 80)"
Source Value C	-99999 To 99999	- - - -	"IEEE Float Access=R "	"Math 1: 12194 Math n: 12194+((n-1)* 80)"
Source Value D	-99999 To 99999	- - - -	"IEEE Float Access=R "	"Math 1: 12196 Math n: 12196+((n-1)* 80)"
Source Value E	"On (63) Off (62)"	- - - -	"unsigned 16-bit Access = R"	"Math 1: 12198 Math n: 12198+((n-1)* 80)"

Parameter Class and Name	Range	Default	Data Type and Attributes	Modbus Registers
Function	"Off (62) Average (1367) Process Scale (1371) Deviation Scale (1372) Switch Over (1370) Differential (1373) Ratio (1374) Add (1375) Multiply (1376) Absolute Difference (1377) Minimum (1378) Maximum (1379) Square Root (1380) Sample and Hold (1381) Pressure to Altitude (1649) Dew Point (1650)"	Off (62)	"unsigned 16-bit Access = RW"	"Math 1: 12200 Math n: 12200+((n-1)* 80)"
Output Value	-99999 To 99999	- - - -	"IEEE Float Access=R"	"Math 1: 12202 Math n: 12202+((n-1)* 80)"
Offset	-99999 To 99999	0	"IEEE Float Access=RW"	"Math 1: 12204 Math n: 12204+((n-1)* 80)"
Scale Low	-99999 To 99999	0.0	"IEEE Float Access=RW"	"Math 1: 12206 Math n: 12206+((n-1)* 80)"
Scale High	-99999 To 99999	1.0	"IEEE Float Access=RW"	"Math 1: 12208 Math n: 12208+((n-1)* 80)"
Range Low	-99999 To 99999	0.0	"IEEE Float Access=RW"	"Math 1: 12210 Math n: 12210+((n-1)* 80)"
Range High	-99999 To 99999	1.0	"IEEE Float Access=RW"	"Math 1: 12212 Math n: 12212+((n-1)* 80)"
Filter	0 To 60	0.0	"IEEE Float Access=RW"	"Math 1: 12214 Math n: 12214+((n-1)* 80)"
Error	"None (61) Open (65) Shorted (127) Measurement Error (140) Bad Calibration Data (139) Ambient Error (9) RTD Error (141) Fail (32) Math Error (1423) Not Sourced (246) Stale (1617)"		"unsigned 16-bit Access = R"	"Math 1: 12216 Math n: 12216+((n-1)* 80)"
Pressure Units	"PSI (1671) mbar (1672) Torr (1673) Pascal (1674) Atmosphere (1675)"	PSI (1671)	"unsigned 16-bit Access = RW"	"Math 1: 12218 Math n: 12218+((n-1)* 80)"
Altitude Units	"Feet (1676) Kilofeet (1677)"	Kilofeet (1677)	"unsigned 16-bit Access = RW"	"Math 1: 12220 Math n: 12220+((n-1)* 80)"

Parameter Class and Name	Range	Default	Data Type and Attributes	Modbus Registers
Units	"Source (1539) None (61) Absolute Temperature (1540) Relative Temperature (1541) Power (73) Process (75) Relative Humidity (1538)"	Source (1539)	"unsigned 16-bit Access = RW"	"Math 1: 12222 Math n: 12222+((n-1)* 80)"
Modbus RTU				
Display Units	"F (30) C (15)"	F (30)	"unsigned 16-bit Access = RW"	14080
Baud Rate	"9600 (188) 19200 (189) 38400 (190)"	9600 (188)	"unsigned 16-bit Access = RW"	14084
Parity	"None (61) Even (191) Odd (192)"	None (61)	"unsigned 16-bit Access = RW"	14086
Modbus Address	1 To 247	1	"unsigned 8-bit Access=RW"	14088
Modbus Word Order	"High Low (1330) Low High (1331)"	Low High (1331)	"unsigned 16-bit Access = RW"	14092
Data Map	" 1 To 2 1=D4T Modbus Register Set 2=F4 Compatible Register Set"	1	"unsigned 8-bit Access=RW"	14094
Process Variable (See: p.110)				
Source Value A			"IEEE Float Access=R "	"Process Variable 1: 14130 Process Variable n: 14130+((n-1)* 70)"
Source Value B			"IEEE Float Access=R "	"Process Variable 1: 14132 Process Variable n: 14132+((n-1)* 70)"
Source Value C			"IEEE Float Access=R "	"Process Variable 1: 14134 Process Variable n: 14134+((n-1)* 70)"
Source Value D			"IEEE Float Access=R "	"Process Variable 1: 14136 Process Variable n: 14136+((n-1)* 70)"
Source Value E	"On (63) Off (62)"		"unsigned 16-bit Access = R"	"Process Variable 1: 14138 Process Variable n: 14138+((n-1)* 70)"

Parameter Class and Name	Range	Default	Data Type and Attributes	Modbus Registers
Function	"Off (62) Sensor Backup (1201) Average (1367) Crossover (1368) Wet Bulb / Dry Bulb (1369) Switch Over (1370) Differential (1373) Ratio (1374) Add (1375) Multiply (1376) Absolute Difference (1377) Minimum (1378) Maximum (1379) Square Root (1380) Vaisala RH Compensation (1648) Pressure to Altitude (1649)"	Off (62)	"unsigned 16-bit Access = RW"	"Process Variable 1: 14140 Process Variable n: 14140+((n-1)* 70)"
Output Value			"IEEE Float Access=R"	"Process Variable 1: 14142 Process Variable n: 14142+((n-1)* 70)"
Offset	-99999 To 99999	0	"IEEE Float Access=RW"	"Process Variable 1: 14144 Process Variable n: 14144+((n-1)* 70)"
Crossover Point	-99999 To 99999	100.0	"IEEE Float Access=RW"	"Process Variable 1: 14146 Process Variable n: 14146+((n-1)* 70)"
Crossover Band	-99999 To 99999	10.0	"IEEE Float Access=RW"	"Process Variable 1: 14148 Process Variable n: 14148+((n-1)* 70)"
Filter	0 To 60	0.0	"IEEE Float Access=RW"	"Process Variable 1: 14150 Process Variable n: 14150+((n-1)* 70)"
Error	"None (61) Open (65) Shorted (127) Measurement Error (140) Bad Calibration Data (139) Ambient Error (9) RTD Error (141) Fail (32) Math Error (1423) Not Sourced (246) Stale (1617)"		"unsigned 16-bit Access = R"	"Process Variable 1: 14152 Process Variable n: 14152+((n-1)* 70)"
Pressure Units	"PSI (1671) mbar (1672) Torr (1673) Pascal (1674) Atmosphere (1675)"	PSI (1671)	"unsigned 16-bit Access = RW"	"Process Variable 1: 14154 Process Variable n: 14154+((n-1)* 70)"

Parameter Class and Name	Range	Default	Data Type and Attributes	Modbus Registers
Altitude Units	"Feet (1676) Kilofeet (1677)"	Kilofeet (1677)	"unsigned 16-bit Access = RW"	"Process Variable 1: 14156 Process Variable n: 14156+((n-1)* 70)"
Barometric Pressure	10 To 16	14.7	"IEEE Float Access=RW"	"Process Variable 1: 14158 Process Variable n: 14158+((n-1)* 70)"
Real Time Clock				
Time of Day	0 To 86399		"unsigned 32-bit Access=R"	14660
Hours	0 To 23		"unsigned 8-bit Access=RW"	14664
Minutes	0 To 59		"unsigned 8-bit Access=RW"	14666
Seconds	0 To 59		"unsigned 8-bit Access=RW"	14668
Month	1 To 12		"unsigned 8-bit Access=RW"	14670
Date	1 To 31		"unsigned 8-bit Access=RW"	14672
Year	2008 To 2100		"unsigned 16-bit Access=RW"	14674
Special Output Function (See: p.122)				
Source Value A			"IEEE Float Access=R "	"Special Output Function 1: 14708 Special Output Function n: 14708+((n-1)* 80)"
Source Value B			"IEEE Float Access=R "	"Special Output Function 1: 14710 Special Output Function n: 14710+((n-1)* 80)"
Function	"Off (62) Compressor Control (1506) Sequencer (1507) Motorized Valve (1508)"	Off (62)	"unsigned 16-bit Access = RW"	"Special Output Function 1: 14712 Special Output Function n: 14712+((n-1)* 80)"
Output Value 1			"IEEE Float Access=R"	"Special Output Function 1: 14714 Special Output Function n: 14714+((n-1)* 80)"
Error	"None (61) Open (65) Shorted (127) Measurement Error (140) Bad Calibration Data (139) Ambient Error (9) RTD Error (141) Fail (32) Math Error (1423) Not Sourced (246) Stale (1617)"		"unsigned 16-bit Access = R"	"Special Output Function 1: 14716 Special Output Function n: 14716+((n-1)* 80)"

Parameter Class and Name	Range	Default	Data Type and Attributes	Modbus Registers
Output Value 2			"IEEE Float Access=R"	"Special Output Function 1: 14718 Special Output Function n: 14718+((n-1)* 80)"
Error	"None (61) Open (65) Shorted (127) Measurement Error (140) Bad Calibration Data (139) Ambient Error (9) RTD Error (141) Fail (32) Math Error (1423) Not Sourced (246) Stale (1617)"		"unsigned 16-bit Access = R"	"Special Output Function 1: 14720 Special Output Function n: 14720+((n-1)* 80)"
Output Value 3			"IEEE Float Access=R"	"Special Output Function 1: 14722 Special Output Function n: 14722+((n-1)* 80)"
Error	"None (61) Open (65) Shorted (127) Measurement Error (140) Bad Calibration Data (139) Ambient Error (9) RTD Error (141) Fail (32) Math Error (1423) Not Sourced (246) Stale (1617)"		"unsigned 16-bit Access = R"	"Special Output Function 1: 14724 Special Output Function n: 14724+((n-1)* 80)"
Output Value 4			"IEEE Float Access=R"	"Special Output Function 1: 14726 Special Output Function n: 14726+((n-1)* 80)"
Error	"None (61) Open (65) Shorted (127) Measurement Error (140) Bad Calibration Data (139) Ambient Error (9) RTD Error (141) Fail (32) Math Error (1423) Not Sourced (246) Stale (1617)"		"unsigned 16-bit Access = R"	"Special Output Function 1: 14728 Special Output Function n: 14728+((n-1)* 80)"
Input A Turn On	-100 To 100	0	"IEEE Float Access=RW"	"Special Output Function 1: 14730 Special Output Function n: 14730+((n-1)* 80)"

Parameter Class and Name	Range	Default	Data Type and Attributes	Modbus Registers
Input A Turn Off	-100 To 100	5	"IEEE Float Access=RW"	"Special Output Function 1: 14732 Special Output Function n: 14732+((n-1)* 80)"
Input B Turn On	-100 To 100	0	"IEEE Float Access=RW"	"Special Output Function 1: 14734 Special Output Function n: 14734+((n-1)* 80)"
Input B Turn Off	-100 To 100	5	"IEEE Float Access=RW"	"Special Output Function 1: 14736 Special Output Function n: 14736+((n-1)* 80)"
Minimum On Time	0 To 9999	20	"unsigned 16-bit Access=RW"	"Special Output Function 1: 14738 Special Output Function n: 14738+((n-1)* 80)"
Minimum Off Time	0 To 9999	20	"unsigned 16-bit Access=RW"	"Special Output Function 1: 14740 Special Output Function n: 14740+((n-1)* 80)"
Valve Travel Time	10 To 9999	120	"unsigned 16-bit Access=RW"	"Special Output Function 1: 14742 Special Output Function n: 14742+((n-1)* 80)"
Dead Band	1 To 100	2	"IEEE Float Access=RW"	"Special Output Function 1: 14744 Special Output Function n: 14744+((n-1)* 80)"
Time Delay	0 To 9999	0	"unsigned 16-bit Access=RW"	"Special Output Function 1: 14746 Special Output Function n: 14746+((n-1)* 80)"
Output Order	"Linear (1509) Progressive (1510)"	Linear (1509)	"unsigned 16-bit Access = RW"	"Special Output Function 1: 14748 Special Output Function n: 14748+((n-1)* 80)"
Output 1 Size	0 To 99999	10	"IEEE Float Access=RW"	"Special Output Function 1: 14750 Special Output Function n: 14750+((n-1)* 80)"
Output 2 Size	0 To 99999	0	"IEEE Float Access=RW"	"Special Output Function 1: 14752 Special Output Function n: 14752+((n-1)* 80)"

Parameter Class and Name	Range	Default	Data Type and Attributes	Modbus Registers
Output 3 Size	0 To 99999	0	"IEEE Float Access=RW"	"Special Output Function 1: 14754 Special Output Function n: 14754+((n-1)* 80)"
Output 4 Size	0 To 99999	0	"IEEE Float Access=RW"	"Special Output Function 1: 14756 Special Output Function n: 14756+((n-1)* 80)"
Value	0 To 100		"IEEE Float Access=R"	"Special Output Function 1: 14758 Special Output Function n: 14758+((n-1)* 80)"
Off Delay	9999	0	"unsigned 16-bit Access=RW"	"Special Output Function 1: 14764 Special Output Function n: 14764+((n-1)* 80)"
Timer (See: p.128)				
Source Value A	"On (63) Off (62)"		"unsigned 16-bit Access = R "	"Timer 1: 15028 Timer n: 15028+((n-1)* 50)"
Source Value B	"On (63) Off (62)"		"unsigned 16-bit Access = R "	"Timer 1: 15030 Timer n: 15030+((n-1)* 50)"
Function	"Off (62) On Pulse (1471) Delay (1472) One Shot (1473) Retentive (1474)"	Off (62)	"unsigned 16-bit Access = RW"	"Timer 1: 15032 Timer n: 15032+((n-1)* 50)"
Output Value	"On (63) Off (62)"		"unsigned 16-bit Access = R"	"Timer 1: 15034 Timer n: 15034+((n-1)* 50)"
Run Active Level	"High (37) Low (53)"	High (37)	"unsigned 16-bit Access = RW"	"Timer 1: 15036 Timer n: 15036+((n-1)* 50)"
Reset Active Level	"High (37) Low (53)"	High (37)	"unsigned 16-bit Access = RW"	"Timer 1: 15038 Timer n: 15038+((n-1)* 50)"
Time	0 To 99999	1.0	"IEEE Float Access=RW"	"Timer 1: 15040 Timer n: 15040+((n-1)* 50)"
Transmitter Active Level	"High (37) Low (53)"	High (37)	"unsigned 16-bit Access = RW"	"Timer 1: 15042 Timer n: 15042+((n-1)* 50)"
Running	"On (63) Off (62)"		"unsigned 16-bit Access = R"	"Timer 1: 15044 Timer n: 15044+((n-1)* 50)"
Elapsed Time			"IEEE Float Access=R"	"Timer 1: 15046 Timer n: 15046+((n-1)* 50)"
Output	"On (63) Off (62)"		"unsigned 16-bit Access = R"	"Timer 1: 15048 Timer n: 15048+((n-1)* 50)"

Parameter Class and Name	Range	Default	Data Type and Attributes	Modbus Registers
Error	"None (61) Open (65) Shorted (127) Measurement Error (140) Bad Calibration Data (139) Ambient Error (9) RTD Error (141) Fail (32) Math Error (1423) Not Sourced (246) Stale (1617)"		"unsigned 16-bit Access = R"	"Timer 1: 15050 Timer n: 15050+((n-1)*50)"
Variable (See: p.146)				
Data Type	"Analog (1215) Digital (1220)"	Analog (1215)	"unsigned 16-bit Access = RW"	"Variable 1: 15816 Variable n: 15816+((n-1)*30)"
Digital	"On (63) Off (62)"	Off (62)	"unsigned 16-bit Access = RW"	"Variable 1: 15818 Variable n: 15818+((n-1)*30)"
Analog	-99999 To 99999	0.0	"IEEE Float Access=RW"	"Variable 1: 15820 Variable n: 15820+((n-1)*30)"
Output Value			"IEEE Float Access=R"	"Variable 1: 15822 Variable n: 15822+((n-1)*30)"
Units	"Absolute Temperature (1540) Relative Temperature (1541) Power (73) Process (75) Relative Humidity (1538) None (61)"	Absolute Temperature (1540)	"unsigned 16-bit Access = RW"	"Variable 1: 15828 Variable n: 15828+((n-1)*30)"
Universal Input (See: p.135)				
Analog Input Value	-99999 To 99999		"IEEE Float Access=R"	"Universal Input 1: Module 1, 27586 Universal Input 1: Module 2, 28026 Universal Input 1: Module 3, 28466 Universal Input 1: Module 4, 28906 Universal Input 1: Module 5, 29346 Universal Input 1: Module 6, 29786 Add 110 for the address of the next input"

Parameter Class and Name	Range	Default	Data Type and Attributes	Modbus Registers
Input Error	"None (61) Open (65) Shorted (127) Measurement Error (140) Bad Calibration Data (139) Ambient Error (9) RTD Error (141) Fail (32)"		"unsigned 16-bit Access = R"	"Universal Input 1: Module 1, 27588 Universal Input 1: Module 2, 28028 Universal Input 1: Module 3, 28468 Universal Input 1: Module 4, 28908 Universal Input 1: Module 5, 29348 Universal Input 1: Module 6, 29788 Add 110 for the address of the next input"
Filter	0 To 60	0.5	"IEEE Float Access=RW"	"Universal Input 1: Module 1, 27590 Universal Input 1: Module 2, 28030 Universal Input 1: Module 3, 28470 Universal Input 1: Module 4, 28910 Universal Input 1: Module 5, 29350 Universal Input 1: Module 6, 29790 Add 110 for the address of the next input"
Filtered Process Value	-99999 To 99999		"IEEE Float Access=R"	"Universal Input 1: Module 1, 27592 Universal Input 1: Module 2, 28032 Universal Input 1: Module 3, 28472 Universal Input 1: Module 4, 28912 Universal Input 1: Module 5, 29352 Universal Input 1: Module 6, 29792 Add 110 for the address of the next input"

Parameter Class and Name	Range	Default	Data Type and Attributes	Modbus Registers
Sensor Type	"Off (62) Thermocouple (95) Millivolts (56) Volts (104) Milliamps (112) RTD 100 Ohm (113) RTD 1000 Ohm (114) 1K Potentiometer (155)"	Thermocouple (95)	"unsigned 16-bit Access = RW"	"Universal Input 1: Module 1, 27594 Universal Input 1: Module 2, 28034 Universal Input 1: Module 3, 28474 Universal Input 1: Module 4, 28914 Universal Input 1: Module 5, 29354 Universal Input 1: Module 6, 29794 Add 110 for the address of the next input"
TC Linearization	"B (11) C (15) D (23) E (26) F (30) J (46) K (48) N (58) R (80) S (84) T (93)"	J (46)	"unsigned 16-bit Access = RW"	"Universal Input 1: Module 1, 27596 Universal Input 1: Module 2, 28036 Universal Input 1: Module 3, 28476 Universal Input 1: Module 4, 28916 Universal Input 1: Module 5, 29356 Universal Input 1: Module 6, 29796 Add 110 for the address of the next input"
RTD Leads	"2 (1) 3 (2)"	2 (1)	"unsigned 16-bit Access = RW"	"Universal Input 1: Module 1, 27598 Universal Input 1: Module 2, 28038 Universal Input 1: Module 3, 28478 Universal Input 1: Module 4, 28918 Universal Input 1: Module 5, 29358 Universal Input 1: Module 6, 29798 Add 110 for the address of the next input"
Scale Low	-100 To 1000	0.0	"IEEE Float Access=RW"	"Universal Input 1: Module 1, 27600 Universal Input 1: Module 2, 28040 Universal Input 1: Module 3, 28480 Universal Input 1: Module 4, 28920 Universal Input 1: Module 5, 29360 Universal Input 1: Module 6, 29800 Add 110 for the address of the next input"

Parameter Class and Name	Range	Default	Data Type and Attributes	Modbus Registers
Scale High	-100 To 1000	20.0	"IEEE Float Access=RW"	"Universal Input 1: Module 1, 27602 Universal Input 1: Module 2, 28042 Universal Input 1: Module 3, 28482 Universal Input 1: Module 4, 28922 Universal Input 1: Module 5, 29362 Universal Input 1: Module 6, 29802 Add 110 for the address of the next input"
Range Low	-99999 To 99999	0.0	"IEEE Float Access=RW"	"Universal Input 1: Module 1, 27604 Universal Input 1: Module 2, 28044 Universal Input 1: Module 3, 28484 Universal Input 1: Module 4, 28924 Universal Input 1: Module 5, 29364 Universal Input 1: Module 6, 29804 Add 110 for the address of the next input"
Range High	-99999 To 99999	9999.0	"IEEE Float Access=RW"	"Universal Input 1: Module 1, 27606 Universal Input 1: Module 2, 28046 Universal Input 1: Module 3, 28486 Universal Input 1: Module 4, 28926 Universal Input 1: Module 5, 29366 Universal Input 1: Module 6, 29806 Add 110 for the address of the next input"
Process Error Enable	"Off (62) Low (53)"	Off (62)	"unsigned 16-bit Access = RW"	"Universal Input 1: Module 1, 27608 Universal Input 1: Module 2, 28048 Universal Input 1: Module 3, 28488 Universal Input 1: Module 4, 28928 Universal Input 1: Module 5, 29368 Universal Input 1: Module 6, 29808 Add 110 for the address of the next input"

Parameter Class and Name	Range	Default	Data Type and Attributes	Modbus Registers
Process Error Low Value	-100 To 1000	0.0	"IEEE Float Access=RW"	"Universal Input 1: Module 1, 27610 Universal Input 1: Module 2, 28050 Universal Input 1: Module 3, 28490 Universal Input 1: Module 4, 28930 Universal Input 1: Module 5, 29370 Universal Input 1: Module 6, 29810 Add 110 for the address of the next input"
Display Precision	"Whole (105) Tenths (94) Hundredths (40) Thousandths (96)"	Whole (105)	"unsigned 16-bit Access = RW"	"Universal Input 1: Module 1, 27612 Universal Input 1: Module 2, 28052 Universal Input 1: Module 3, 28492 Universal Input 1: Module 4, 28932 Universal Input 1: Module 5, 29372 Universal Input 1: Module 6, 29812 Add 110 for the address of the next input"
Units	"Absolute Temperature (1540) Power (73) Process (75) Relative Humidity (1538)"	Process (75)	"unsigned 16-bit Access = RW"	"Universal Input 1: Module 1, 27614 Universal Input 1: Module 2, 28054 Universal Input 1: Module 3, 28494 Universal Input 1: Module 4, 28934 Universal Input 1: Module 5, 29374 Universal Input 1: Module 6, 29814 Add 110 for the address of the next input"
Calibration Offset	-99999 To 99999	0.0	"IEEE Float Access=RW"	"Universal Input 1: Module 1, 27616 Universal Input 1: Module 2, 28056 Universal Input 1: Module 3, 28496 Universal Input 1: Module 4, 28936 Universal Input 1: Module 5, 29376 Universal Input 1: Module 6, 29816 Add 110 for the address of the next input"

Parameter Class and Name	Range	Default	Data Type and Attributes	Modbus Registers
Input Error Latching	"Off (62) On (63)"	Off (62)	"unsigned 16-bit Access = RW"	"Universal Input 1: Module 1, 27618 Universal Input 1: Module 2, 28058 Universal Input 1: Module 3, 28498 Universal Input 1: Module 4, 28938 Universal Input 1: Module 5, 29378 Universal Input 1: Module 6, 29818 Add 110 for the address of the next input"
Clear Error	"Clear (129) Ignore (204)"	Ignore (204)	"unsigned 16-bit Access = RW"	"Universal Input 1: Module 1, 27620 Universal Input 1: Module 2, 28060 Universal Input 1: Module 3, 28500 Universal Input 1: Module 4, 28940 Universal Input 1: Module 5, 29380 Universal Input 1: Module 6, 29820 Add 110 for the address of the next input"
Electrical Measurement	-3.4E+38 To 3.4E+38		"IEEE Float Access=R"	"Universal Input 1: Module 1, 27640 Universal Input 1: Module 2, 28080 Universal Input 1: Module 3, 28520 Universal Input 1: Module 4, 28960 Universal Input 1: Module 5, 29400 Universal Input 1: Module 6, 29840 Add 110 for the address of the next input"
RTD Lead Resistance	-99999 To 99999		"IEEE Float Access=R"	"Universal Input 1: Module 1, 27642 Universal Input 1: Module 2, 28082 Universal Input 1: Module 3, 28522 Universal Input 1: Module 4, 28962 Universal Input 1: Module 5, 29402 Universal Input 1: Module 6, 29842 Add 110 for the address of the next input"

Parameter Class and Name	Range	Default	Data Type and Attributes	Modbus Registers
Measure CJC	"Off (62) On (63)"	On (63)	"unsigned 16-bit Access = RW"	"Universal Input 1: Module 1, 27644 Universal Input 1: Module 2, 28084 Universal Input 1: Module 3, 28524 Universal Input 1: Module 4, 28964 Universal Input 1: Module 5, 29404 Universal Input 1: Module 6, 29844 Add 110 for the address of the next input"
Ambient Temperature	-99999 To 99999		"IEEE Float Access=R"	"Universal Input 1: Module 1, 27646 Universal Input 1: Module 2, 28086 Universal Input 1: Module 3, 28526 Universal Input 1: Module 4, 28966 Universal Input 1: Module 5, 29406 Universal Input 1: Module 6, 29846 Add 110 for the address of the next input"
Ambient Offset	-99999 To 99999	0.0	"IEEE Float Access=RW"	"Universal Input 1: Module 1, 27654 Universal Input 1: Module 2, 28094 Universal Input 1: Module 3, 28534 Universal Input 1: Module 4, 28974 Universal Input 1: Module 5, 29414 Universal Input 1: Module 6, 29854 Add 110 for the address of the next input"
Electrical Input Offset	-99999 To 99999	0.0	"IEEE Float Access=RW"	"Universal Input 1: Module 1, 27656 Universal Input 1: Module 2, 28096 Universal Input 1: Module 3, 28536 Universal Input 1: Module 4, 28976 Universal Input 1: Module 5, 29416 Universal Input 1: Module 6, 29856 Add 110 for the address of the next input"

Parameter Class and Name	Range	Default	Data Type and Attributes	Modbus Registers
Electrical Input Slope	-99999 To 99999	1.0	"IEEE Float Access=RW"	"Universal Input 1: Module 1, 27658 Universal Input 1: Module 2, 28098 Universal Input 1: Module 3, 28538 Universal Input 1: Module 4, 28978 Universal Input 1: Module 5, 29418 Universal Input 1: Module 6, 29858 Add 110 for the address of the next input"
Calibration Slope	-99999 To 99999	1.0	"IEEE Float Access=RW"	"Universal Input 1: Module 1, 27660 Universal Input 1: Module 2, 28100 Universal Input 1: Module 3, 28540 Universal Input 1: Module 4, 28980 Universal Input 1: Module 5, 29420 Universal Input 1: Module 6, 29860 Add 110 for the address of the next input"
Terminate	"2 (1) 3 (2)"		"unsigned 16-bit Access = R"	"Universal Input 1: Module 1, 27680 Universal Input 1: Module 2, 28120 Universal Input 1: Module 3, 28560 Universal Input 1: Module 4, 29000 Universal Input 1: Module 5, 29440 Universal Input 1: Module 6, 29880 Add 110 for the address of the next input"

Parameter Class and Name	Range	Default	Data Type and Attributes	Modbus Registers
Thermistor Input (See: p.187)				
Analog Input Value	-99999 To 99999		"IEEE Float Access=R"	"Thermistor Input 1: Module 1, 30226 Thermistor Input 1: Module 2, 30546 Thermistor Input 1: Module 3, 30866 Thermistor Input 1: Module 4, 31186 Thermistor Input 1: Module 5, 31506 Thermistor Input 1: Module 6, 31826 Add 80 for the address of the next input"
Input Error	"None (61) Open (65) Shorted (127) Measurement Error (140) Bad Calibration Data (139) Ambient Error (9) RTD Error (141) Fail (32)"		"unsigned 16-bit Access = R"	"Thermistor Input 1: Module 1, 30228 Thermistor Input 1: Module 2, 30548 Thermistor Input 1: Module 3, 30868 Thermistor Input 1: Module 4, 31188 Thermistor Input 1: Module 5, 31508 Thermistor Input 1: Module 6, 31828 Add 80 for the address of the next input"
Filter	0 To 60	0.5	"IEEE Float Access=RW"	"Thermistor Input 1: Module 1, 30230 Thermistor Input 1: Module 2, 30550 Thermistor Input 1: Module 3, 30870 Thermistor Input 1: Module 4, 31190 Thermistor Input 1: Module 5, 31510 Thermistor Input 1: Module 6, 31830 Add 80 for the address of the next input"

Parameter Class and Name	Range	Default	Data Type and Attributes	Modbus Registers
Filtered Process Value	-99999 To 99999		"IEEE Float Access=R"	"Thermistor Input 1: Module 1, 30232 Thermistor Input 1: Module 2, 30552 Thermistor Input 1: Module 3, 30872 Thermistor Input 1: Module 4, 31192 Thermistor Input 1: Module 5, 31512 Thermistor Input 1: Module 6, 31832 Add 80 for the address of the next input"
Sensor Type	"Thermistor (229) Off (62)"	Thermistor (229)	"unsigned 16-bit Access = RW"	"Thermistor Input 1: Module 1, 30234 Thermistor Input 1: Module 2, 30554 Thermistor Input 1: Module 3, 30874 Thermistor Input 1: Module 4, 31194 Thermistor Input 1: Module 5, 31514 Thermistor Input 1: Module 6, 31834 Add 80 for the address of the next input"
Resistance Range	"5K (1448) 10K (1360) 20K (1361) 40K (1449)"	40K (1449)	"unsigned 16-bit Access = RW"	"Thermistor Input 1: Module 1, 30236 Thermistor Input 1: Module 2, 30556 Thermistor Input 1: Module 3, 30876 Thermistor Input 1: Module 4, 31196 Thermistor Input 1: Module 5, 31516 Thermistor Input 1: Module 6, 31836 Add 80 for the address of the next input"
Thermistor Curve	"Curve A (1451) Curve B (1452) Curve C (1453) Custom (180)"	Curve A (1451)	"unsigned 16-bit Access = RW"	"Thermistor Input 1: Module 1, 30238 Thermistor Input 1: Module 2, 30558 Thermistor Input 1: Module 3, 30878 Thermistor Input 1: Module 4, 31198 Thermistor Input 1: Module 5, 31518 Thermistor Input 1: Module 6, 31838 Add 80 for the address of the next input"

Parameter Class and Name	Range	Default	Data Type and Attributes	Modbus Registers
Coefficient A	-3.4E+38 To 3.4E+38	1.471388e-3	"IEEE Float Access=RW"	"Thermistor Input 1: Module 1, 30240 Thermistor Input 1: Module 2, 30560 Thermistor Input 1: Module 3, 30880 Thermistor Input 1: Module 4, 31200 Thermistor Input 1: Module 5, 31520 Thermistor Input 1: Module 6, 31840 Add 80 for the address of the next input"
Coefficient B	-3.4E+38 To 3.4E+38	2.376138e-4	"IEEE Float Access=RW"	"Thermistor Input 1: Module 1, 30242 Thermistor Input 1: Module 2, 30562 Thermistor Input 1: Module 3, 30882 Thermistor Input 1: Module 4, 31202 Thermistor Input 1: Module 5, 31522 Thermistor Input 1: Module 6, 31842 Add 80 for the address of the next input"
Coefficient C	-3.4E+38 To 3.4E+38	1.051058e-7	"IEEE Float Access=RW"	"Thermistor Input 1: Module 1, 30244 Thermistor Input 1: Module 2, 30564 Thermistor Input 1: Module 3, 30884 Thermistor Input 1: Module 4, 31204 Thermistor Input 1: Module 5, 31524 Thermistor Input 1: Module 6, 31844 Add 80 for the address of the next input"
Display Precision	"Whole (105) Tenths (94) Hundredths (40) Thousandths (96)"	Whole (105)	"unsigned 16-bit Access = RW"	"Thermistor Input 1: Module 1, 30252 Thermistor Input 1: Module 2, 30572 Thermistor Input 1: Module 3, 30892 Thermistor Input 1: Module 4, 31212 Thermistor Input 1: Module 5, 31532 Thermistor Input 1: Module 6, 31852 Add 80 for the address of the next input"

Parameter Class and Name	Range	Default	Data Type and Attributes	Modbus Registers
Calibration Offset	-99999 To 99999	0.0	"IEEE Float Access=RW"	"Thermistor Input 1: Module 1, 30256 Thermistor Input 1: Module 2, 30576 Thermistor Input 1: Module 3, 30896 Thermistor Input 1: Module 4, 31216 Thermistor Input 1: Module 5, 31536 Thermistor Input 1: Module 6, 31856 Add 80 for the address of the next input"
Input Error Latching	"Off (62) On (63)"	Off (62)	"unsigned 16-bit Access = RW"	"Thermistor Input 1: Module 1, 30258 Thermistor Input 1: Module 2, 30578 Thermistor Input 1: Module 3, 30898 Thermistor Input 1: Module 4, 31218 Thermistor Input 1: Module 5, 31538 Thermistor Input 1: Module 6, 31858 Add 80 for the address of the next input"
Clear Error	"Clear (129) Ignore (204)"	Ignore (204)	"unsigned 16-bit Access = RW"	"Thermistor Input 1: Module 1, 30260 Thermistor Input 1: Module 2, 30580 Thermistor Input 1: Module 3, 30900 Thermistor Input 1: Module 4, 31220 Thermistor Input 1: Module 5, 31540 Thermistor Input 1: Module 6, 31860 Add 80 for the address of the next input"
Electrical Measurement	-3.4E+38 To 3.4E+38		"IEEE Float Access=R"	"Thermistor Input 1: Module 1, 30280 Thermistor Input 1: Module 2, 30600 Thermistor Input 1: Module 3, 30920 Thermistor Input 1: Module 4, 31240 Thermistor Input 1: Module 5, 31560 Thermistor Input 1: Module 6, 31880 Add 80 for the address of the next input"

Parameter Class and Name	Range	Default	Data Type and Attributes	Modbus Registers
RTD Lead Resistance	-99999 To 99999		"IEEE Float Access=R"	"Thermistor Input 1: Module 1, 30282 Thermistor Input 1: Module 2, 30602 Thermistor Input 1: Module 3, 30922 Thermistor Input 1: Module 4, 31242 Thermistor Input 1: Module 5, 31562 Thermistor Input 1: Module 6, 31882 Add 80 for the address of the next input"
Measure CJC	"Off (62) On (63)"	On (63)	"unsigned 16-bit Access = RW"	"Thermistor Input 1: Module 1, 30284 Thermistor Input 1: Module 2, 30604 Thermistor Input 1: Module 3, 30924 Thermistor Input 1: Module 4, 31244 Thermistor Input 1: Module 5, 31564 Thermistor Input 1: Module 6, 31884 Add 80 for the address of the next input"
Ambient Temperature	-99999 To 99999		"IEEE Float Access=R"	"Thermistor Input 1: Module 1, 30286 Thermistor Input 1: Module 2, 30606 Thermistor Input 1: Module 3, 30926 Thermistor Input 1: Module 4, 31246 Thermistor Input 1: Module 5, 31566 Thermistor Input 1: Module 6, 31886 Add 80 for the address of the next input"
Ambient Offset	-99999 To 99999	0.0	"IEEE Float Access=RW"	"Thermistor Input 1: Module 1, 30294 Thermistor Input 1: Module 2, 30614 Thermistor Input 1: Module 3, 30934 Thermistor Input 1: Module 4, 31254 Thermistor Input 1: Module 5, 31574 Thermistor Input 1: Module 6, 31894 Add 80 for the address of the next input"

Parameter Class and Name	Range	Default	Data Type and Attributes	Modbus Registers
Electrical Input Offset	-99999 To 99999	0.0	"IEEE Float Access=RW"	"Thermistor Input 1: Module 1, 30296 Thermistor Input 1: Module 2, 30616 Thermistor Input 1: Module 3, 30936 Thermistor Input 1: Module 4, 31256 Thermistor Input 1: Module 5, 31576 Thermistor Input 1: Module 6, 31896 Add 80 for the address of the next input"
Electrical Input Slope	-99999 To 99999	1.0	"IEEE Float Access=RW"	"Thermistor Input 1: Module 1, 30298 Thermistor Input 1: Module 2, 30618 Thermistor Input 1: Module 3, 30938 Thermistor Input 1: Module 4, 31258 Thermistor Input 1: Module 5, 31578 Thermistor Input 1: Module 6, 31898 Add 80 for the address of the next input"
Calibration Slope	-99999 To 99999	1.0	"IEEE Float Access=RW"	"Thermistor Input 1: Module 1, 30300 Thermistor Input 1: Module 2, 30620 Thermistor Input 1: Module 3, 30940 Thermistor Input 1: Module 4, 31260 Thermistor Input 1: Module 5, 31580 Thermistor Input 1: Module 6, 31900 Add 80 for the address of the next input"

Parameter Class and Name	Range	Default	Data Type and Attributes	Modbus Registers
Analog Output (See: p.65)				
Output Type	"Volts (104) Milliamps (112)"	Volts (104)	"unsigned 16-bit Access = RW"	"Analog Output 1: Module 1, 32566 Analog Output 1: Module 2, 32716 Analog Output 1: Module 3, 32866 Analog Output 1: Module 4, 33016 Analog Output 1: Module 5, 33166 Analog Output 1: Module 6, 33316 Add 50 for the address of the next Analog Ouput"
Function	"Off (62) Analog Input (142) Current (22) Cool Power (161) Heat Power (160) Power (73) Linearization (238) Math (240) Process Value (241) Set Point Closed (242) Set Point Open (243) Special Function Output 1 (1532) Special Function Output 2 (1533) Special Function Output 3 (1534) Special Function Output 4 (1535) Variable (245) Condition (10001) Encoder (1740)"	Off (62)	"unsigned 16-bit Access = RW"	"Analog Output 1: Module 1, 32568 Analog Output 1: Module 2, 32718 Analog Output 1: Module 3, 32868 Analog Output 1: Module 4, 33018 Analog Output 1: Module 5, 33168 Analog Output 1: Module 6, 33318 Add 50 for the address of the next Analog Ouput"
Output Function Instance	1 To 250	1	"unsigned 8-bit Access=RW"	"Analog Output 1: Module 1, 32572 Analog Output 1: Module 2, 32722 Analog Output 1: Module 3, 32872 Analog Output 1: Module 4, 33022 Analog Output 1: Module 5, 33172 Analog Output 1: Module 6, 33322 Add 50 for the address of the next Analog Ouput"

Parameter Class and Name	Range	Default	Data Type and Attributes	Modbus Registers
Electrical Output Offset	-99999 To 99999	0.0	"IEEE Float Access=RW"	"Analog Output 1: Module 1, 32574 Analog Output 1: Module 2, 32724 Analog Output 1: Module 3, 32874 Analog Output 1: Module 4, 33024 Analog Output 1: Module 5, 33174 Analog Output 1: Module 6, 33324 Add 50 for the address of the next Analog Output"
Electrical Output Slope	-99999 To 99999	1.0	"IEEE Float Access=RW"	"Analog Output 1: Module 1, 32576 Analog Output 1: Module 2, 32726 Analog Output 1: Module 3, 32876 Analog Output 1: Module 4, 33026 Analog Output 1: Module 5, 33176 Analog Output 1: Module 6, 33326 Add 50 for the address of the next Analog Output"
Calibration Offset	-99999 To 99999	0.0	"IEEE Float Access=RW"	"Analog Output 1: Module 1, 32578 Analog Output 1: Module 2, 32728 Analog Output 1: Module 3, 32878 Analog Output 1: Module 4, 33028 Analog Output 1: Module 5, 33178 Analog Output 1: Module 6, 33328 Add 50 for the address of the next Analog Output"
Calibration Slope	-99999 To 99999	1.0	"IEEE Float Access=RW"	"Analog Output 1: Module 1, 32580 Analog Output 1: Module 2, 32730 Analog Output 1: Module 3, 32880 Analog Output 1: Module 4, 33030 Analog Output 1: Module 5, 33180 Analog Output 1: Module 6, 33330 Add 50 for the address of the next Analog Output"

Parameter Class and Name	Range	Default	Data Type and Attributes	Modbus Registers
Scale Low	-100 To 100	0.0	"IEEE Float Access=RW"	"Analog Output 1: Module 1, 32582 Analog Output 1: Module 2, 32732 Analog Output 1: Module 3, 32882 Analog Output 1: Module 4, 33032 Analog Output 1: Module 5, 33182 Analog Output 1: Module 6, 33332 Add 50 for the address of the next Analog Output"
Scale High	-100 To 100	10.0	"IEEE Float Access=RW"	"Analog Output 1: Module 1, 32584 Analog Output 1: Module 2, 32734 Analog Output 1: Module 3, 32884 Analog Output 1: Module 4, 33034 Analog Output 1: Module 5, 33184 Analog Output 1: Module 6, 33334 Add 50 for the address of the next Analog Output"
Range Low	-99999 To 99999	0.0	"IEEE Float Access=RW"	"Analog Output 1: Module 1, 32586 Analog Output 1: Module 2, 32736 Analog Output 1: Module 3, 32886 Analog Output 1: Module 4, 33036 Analog Output 1: Module 5, 33186 Analog Output 1: Module 6, 33336 Add 50 for the address of the next Analog Output"
Range High	-99999 To 99999	100.0	"IEEE Float Access=RW"	"Analog Output 1: Module 1, 32588 Analog Output 1: Module 2, 32738 Analog Output 1: Module 3, 32888 Analog Output 1: Module 4, 33038 Analog Output 1: Module 5, 33188 Analog Output 1: Module 6, 33338 Add 50 for the address of the next Analog Output"

Parameter Class and Name	Range	Default	Data Type and Attributes	Modbus Registers
Analog Output Electrical Value			"IEEE Float Access=R"	"Analog Output 1: Module 1, 32596 Analog Output 1: Module 2, 32746 Analog Output 1: Module 3, 32896 Analog Output 1: Module 4, 33046 Analog Output 1: Module 5, 33196 Analog Output 1: Module 6, 33346 Add 50 for the address of the next Analog Output"
Analog Output Control Operation	"Electrical (1276) Counts (1037)"	Electrical (1276)	"unsigned 16-bit Access = RW"	"Analog Output 1: Module 1, 32598 Analog Output 1: Module 2, 32748 Analog Output 1: Module 3, 32898 Analog Output 1: Module 4, 33048 Analog Output 1: Module 5, 33198 Analog Output 1: Module 6, 33348 Add 50 for the address of the next Analog Output"
Source Value A			"IEEE Float Access=R"	"Analog Output 1: Module 1, 32600 Analog Output 1: Module 2, 32750 Analog Output 1: Module 3, 32900 Analog Output 1: Module 4, 33050 Analog Output 1: Module 5, 33200 Analog Output 1: Module 6, 33350 Add 50 for the address of the next Analog Output"
Output Type	"2 (1) 3 (2)"		"unsigned 16-bit Access = R"	"Analog Output 1: Module 1, 32614 Analog Output 1: Module 2, 32764 Analog Output 1: Module 3, 32914 Analog Output 1: Module 4, 33064 Analog Output 1: Module 5, 33214 Analog Output 1: Module 6, 33364 Add 50 for the address of the next Analog Output"

Parameter Class and Name	Range	Default	Data Type and Attributes	Modbus Registers
Discrete Input / Output				
Direction	"Output (68) Input Voltage (193) Input Dry Contact (44)"	Output (68)	"unsigned 16-bit Access = RW"	"Digital I/O 1: Module 1, 33706 Digital I/O 1: Module 2, 33946 Digital I/O 1: Module 3, 34186 Digital I/O 1: Module 4, 34426 Digital I/O 1: Module 5, 34666 Digital I/O 1: Module 6, 34906 Add 40 for the address of the next output"
Time Base Type	"Fixed Time Base (34) Variable Time Base (103)"	Fixed Time Base (34)	"unsigned 16-bit Access = RW"	"Digital I/O 1: Module 1, 33708 Digital I/O 1: Module 2, 33948 Digital I/O 1: Module 3, 34188 Digital I/O 1: Module 4, 34428 Digital I/O 1: Module 5, 34668 Digital I/O 1: Module 6, 34908 Add 40 for the address of the next output"
Fixed Time Base	.1 To 60	1	"IEEE Float Access=RW"	"Digital I/O 1: Module 1, 33710 Digital I/O 1: Module 2, 33950 Digital I/O 1: Module 3, 34190 Digital I/O 1: Module 4, 34430 Digital I/O 1: Module 5, 34670 Digital I/O 1: Module 6, 34910 Add 40 for the address of the next output"

Parameter Class and Name	Range	Default	Data Type and Attributes	Modbus Registers
AC Line Frequency	"50 Hz (3) 60 Hz (4)"		"unsigned 16-bit Access = RW"	"Digital I/O 1: Module 1, 33712 Digital I/O 1: Module 2, 33952 Digital I/O 1: Module 3, 34192 Digital I/O 1: Module 4, 34432 Digital I/O 1: Module 5, 34672 Digital I/O 1: Module 6, 34912 Add 40 for the address of the next output"
Function	"Off (62) Analog Input (142) Alarm (6) Compare (230) Counter (231) Digital I/O (1142) Function Key (1001) Logic (239) Linearization (238) Math (240) Process Value (241) Special Function Output 1 (1532) Special Function Output 2 (1533) Special Function Output 3 (1534) Special Function Output 4 (1535) Timer (244) Variable (245) Condition (10001) Encoder (1740)"	Off (62)	"unsigned 16-bit Access = RW"	"Digital I/O 1: Module 1, 33714 Digital I/O 1: Module 2, 33954 Digital I/O 1: Module 3, 34194 Digital I/O 1: Module 4, 34434 Digital I/O 1: Module 5, 34674 Digital I/O 1: Module 6, 34914 Add 40 for the address of the next output"
Output Function Instance	1 To 250	1	"unsigned 8-bit Access=RW"	"Digital I/O 1: Module 1, 33716 Digital I/O 1: Module 2, 33956 Digital I/O 1: Module 3, 34196 Digital I/O 1: Module 4, 34436 Digital I/O 1: Module 5, 34676 Digital I/O 1: Module 6, 34916 Add 40 for the address of the next output"

Parameter Class and Name	Range	Default	Data Type and Attributes	Modbus Registers
Output State	"On (63) Off (62)"		"unsigned 16-bit Access = R"	"Digital I/O 1: Module 1, 33718 Digital I/O 1: Module 2, 33958 Digital I/O 1: Module 3, 34198 Digital I/O 1: Module 4, 34438 Digital I/O 1: Module 5, 34678 Digital I/O 1: Module 6, 34918 Add 40 for the address of the next output"
Output Power			"IEEE Float Access=R"	"Digital I/O 1: Module 1, 33720 Digital I/O 1: Module 2, 33960 Digital I/O 1: Module 3, 34200 Digital I/O 1: Module 4, 34440 Digital I/O 1: Module 5, 34680 Digital I/O 1: Module 6, 34920 Add 40 for the address of the next output"
Low Power Scale	0 To 100	0.0	"IEEE Float Access=RW"	"Digital I/O 1: Module 1, 33722 Digital I/O 1: Module 2, 33962 Digital I/O 1: Module 3, 34202 Digital I/O 1: Module 4, 34442 Digital I/O 1: Module 5, 34682 Digital I/O 1: Module 6, 34922 Add 40 for the address of the next output"
High Power Scale	0 To 100	100.0	"IEEE Float Access=RW"	"Digital I/O 1: Module 1, 33724 Digital I/O 1: Module 2, 33964 Digital I/O 1: Module 3, 34204 Digital I/O 1: Module 4, 34444 Digital I/O 1: Module 5, 34684 Digital I/O 1: Module 6, 34924 Add 40 for the address of the next output"

Parameter Class and Name	Range	Default	Data Type and Attributes	Modbus Registers
Input State	"On (63) Off (62)"		"unsigned 16-bit Access = R"	"Digital I/O 1: Module 1, 33726 Digital I/O 1: Module 2, 33966 Digital I/O 1: Module 3, 34206 Digital I/O 1: Module 4, 34446 Digital I/O 1: Module 5, 34686 Digital I/O 1: Module 6, 34926 Add 40 for the address of the next output"
Source Value A			"IEEE Float Access=R"	"Digital I/O 1: Module 1, 33730 Digital I/O 1: Module 2, 33970 Digital I/O 1: Module 3, 34210 Digital I/O 1: Module 4, 34450 Digital I/O 1: Module 5, 34690 Digital I/O 1: Module 6, 34930 Add 40 for the address of the next output"
Error	"None (61) Open (65) Shorted (127) Measurement Error (140) Bad Calibration Data (139) Ambient Error (9) RTD Error (141) Fail (32) Math Error (1423) Not Sourced (246) Stale (1617)"		"unsigned 16-bit Access = R"	"Digital I/O 1: Module 1, 33734 Digital I/O 1: Module 2, 33974 Digital I/O 1: Module 3, 34214 Digital I/O 1: Module 4, 34454 Digital I/O 1: Module 5, 34694 Digital I/O 1: Module 6, 34934 Add 40 for the address of the next output"
Error	"None (61) Open (65) Shorted (127) Measurement Error (140) Bad Calibration Data (139) Ambient Error (9) RTD Error (141) Fail (32) Math Error (1423) Not Sourced (246) Stale (1617)"		"unsigned 16-bit Access = R"	"Digital I/O 1: Module 1, 33740 Digital I/O 1: Module 2, 33980 Digital I/O 1: Module 3, 34220 Digital I/O 1: Module 4, 34460 Digital I/O 1: Module 5, 34700 Digital I/O 1: Module 6, 34940 Add 40 for the address of the next output"

Parameter Class and Name	Range	Default	Data Type and Attributes	Modbus Registers
Discrete Output, Solid-State Relay and Switched DC/Open Collector				
Time Base Type	"Fixed Time Base (34) Variable Time Base (103)"	Fixed Time Base (34)	"unsigned 16-bit Access = RW"	"Output 1: Module 1, 35148 Output 1: Module 2, 35308 Output 1: Module 3, 35468 Output 1: Module 4, 35628 Output 1: Module 5, 35788 Output 1: Module 6, 35948 Add 40 for the address of the next output"
Fixed Time Base	.1 To 60	1	"IEEE Float Access=RW"	"Output 1: Module 1, 35150 Output 1: Module 2, 35310 Output 1: Module 3, 35470 Output 1: Module 4, 35630 Output 1: Module 5, 35790 Output 1: Module 6, 35950 Add 40 for the address of the next output"
AC Line Frequency	"50 Hz (3) 60 Hz (4)"		"unsigned 16-bit Access = RW"	"Output 1: Module 1, 35152 Output 1: Module 2, 35312 Output 1: Module 3, 35472 Output 1: Module 4, 35632 Output 1: Module 5, 35792 Output 1: Module 6, 35952 Add 40 for the address of the next output"

Parameter Class and Name	Range	Default	Data Type and Attributes	Modbus Registers
Function	"Off (62) Analog Input (142) Alarm (6) Compare (230) Counter (231) Digital I/O (1142) Function Key (1001) Logic (239) Linearization (238) Math (240) Process Value (241) Special Function Output 1 (1532) Special Function Output 2 (1533) Special Function Output 3 (1534) Special Function Output 4 (1535) Timer (244) Variable (245) Condition (10001) Encoder (1740)"	Off (62)	"unsigned 16-bit Access = RW"	"Output 1: Module 1, 35154 Output 1: Module 2, 35314 Output 1: Module 3, 35474 Output 1: Module 4, 35634 Output 1: Module 5, 35794 Output 1: Module 6, 35954 Add 40 for the address of the next output"
Output Function Instance	1 To 250	1	"unsigned 8-bit Access=RW"	"Output 1: Module 1, 35156 Output 1: Module 2, 35316 Output 1: Module 3, 35476 Output 1: Module 4, 35636 Output 1: Module 5, 35796 Output 1: Module 6, 35956 Add 40 for the address of the next output"
Output State	"On (63) Off (62)"		"unsigned 16-bit Access = R"	"Output 1: Module 1, 35158 Output 1: Module 2, 35318 Output 1: Module 3, 35478 Output 1: Module 4, 35638 Output 1: Module 5, 35798 Output 1: Module 6, 35958 Add 40 for the address of the next output"

Parameter Class and Name	Range	Default	Data Type and Attributes	Modbus Registers
Output Power			"IEEE Float Access=R"	"Output 1: Module 1, 35160 Output 1: Module 2, 35320 Output 1: Module 3, 35480 Output 1: Module 4, 35640 Output 1: Module 5, 35800 Output 1: Module 6, 35960 Add 40 for the address of the next output"
Low Power Scale	0 To 100	0.0	"IEEE Float Access=RW"	"Output 1: Module 1, 35162 Output 1: Module 2, 35322 Output 1: Module 3, 35482 Output 1: Module 4, 35642 Output 1: Module 5, 35802 Output 1: Module 6, 35962 Add 40 for the address of the next output"
High Power Scale	0 To 100	100.0	"IEEE Float Access=RW"	"Output 1: Module 1, 35164 Output 1: Module 2, 35324 Output 1: Module 3, 35484 Output 1: Module 4, 35644 Output 1: Module 5, 35804 Output 1: Module 6, 35964 Add 40 for the address of the next output"
Source Value A			"IEEE Float Access=R"	"Output 1: Module 1, 35170 Output 1: Module 2, 35330 Output 1: Module 3, 35490 Output 1: Module 4, 35650 Output 1: Module 5, 35810 Output 1: Module 6, 35970 Add 40 for the address of the next output"

Parameter Class and Name	Range	Default	Data Type and Attributes	Modbus Registers
Error	"None (61) Open (65) Shorted (127) Measurement Error (140) Bad Calibration Data (139) Ambient Error (9) RTD Error (141) Fail (32) Math Error (1423) Not Sourced (246) Stale (1617)"		"unsigned 16-bit Access = R"	"Output 1: Module 1, 35174 Output 1: Module 2, 35334 Output 1: Module 3, 35494 Output 1: Module 4, 35654 Output 1: Module 5, 35814 Output 1: Module 6, 35974 Add 40 for the address of the next output"
Output Type	"SSR (10034) SSR w/ Shared Common (10035) Switched DC (10033) Switched DC / Open Collector (10032)"		"unsigned 16-bit Access = R"	"Output 1: Module 1, 35184 Output 1: Module 2, 35344 Output 1: Module 3, 35504 Output 1: Module 4, 35664 Output 1: Module 5, 35824 Output 1: Module 6, 35984 Add 40 for the address of the next output"
Discrete Output, Electromechanical Relay				
Time Base Type	Fixed Time Base (34)	Fixed Time Base (34)	"unsigned 16-bit Access = RW"	"Output 1: Module 1, 36588 Output 1: Module 2, 36748 Output 1: Module 3, 36908 Output 1: Module 4, 37068 Output 1: Module 5, 37228 Output 1: Module 6, 37388 Add 40 for the address of the next output"

Parameter Class and Name	Range	Default	Data Type and Attributes	Modbus Registers
Fixed Time Base	5 To 60	20	"IEEE Float Access=RW"	"Output 1: Module 1, 36590 Output 1: Module 2, 36750 Output 1: Module 3, 36910 Output 1: Module 4, 37070 Output 1: Module 5, 37230 Output 1: Module 6, 37390 Add 40 for the address of the next output"
Function	"Off (62) Analog Input (142) Alarm (6) Compare (230) Counter (231) Digital I/O (1142) Function Key (1001) Logic (239) Linearization (238) Math (240) Process Value (241) Special Function Output 1 (1532) Special Function Output 2 (1533) Special Function Output 3 (1534) Special Function Output 4 (1535) Timer (244) Variable (245) Condition (10001) Encoder (1740)	Off (62)	"unsigned 16-bit Access = RW"	"Output 1: Module 1, 36594 Output 1: Module 2, 36754 Output 1: Module 3, 36914 Output 1: Module 4, 37074 Output 1: Module 5, 37234 Output 1: Module 6, 37394 Add 40 for the address of the next output"
Output Function Instance	1 To 250	1	"unsigned 8-bit Access=RW"	"Output 1: Module 1, 36596 Output 1: Module 2, 36756 Output 1: Module 3, 36916 Output 1: Module 4, 37076 Output 1: Module 5, 37236 Output 1: Module 6, 37396 Add 40 for the address of the next output"

Parameter Class and Name	Range	Default	Data Type and Attributes	Modbus Registers
Output State	"On (63) Off (62)"		"unsigned 16-bit Access = R"	"Output 1: Module 1, 36598 Output 1: Module 2, 36758 Output 1: Module 3, 36918 Output 1: Module 4, 37078 Output 1: Module 5, 37238 Output 1: Module 6, 37398 Add 40 for the address of the next output"
Output Power			"IEEE Float Access=R"	"Output 1: Module 1, 36600 Output 1: Module 2, 36760 Output 1: Module 3, 36920 Output 1: Module 4, 37080 Output 1: Module 5, 37240 Output 1: Module 6, 37400 Add 40 for the address of the next output"
Low Power Scale	0 To 100	0.0	"IEEE Float Access=RW"	"Output 1: Module 1, 36602 Output 1: Module 2, 36762 Output 1: Module 3, 36922 Output 1: Module 4, 37082 Output 1: Module 5, 37242 Output 1: Module 6, 37402 Add 40 for the address of the next output"
High Power Scale	0 To 100	100.0	"IEEE Float Access=RW"	"Output 1: Module 1, 36604 Output 1: Module 2, 36764 Output 1: Module 3, 36924 Output 1: Module 4, 37084 Output 1: Module 5, 37244 Output 1: Module 6, 37404 Add 40 for the address of the next output"

Parameter Class and Name	Range	Default	Data Type and Attributes	Modbus Registers
Source Value A			"IEEE Float Access=R"	"Output 1: Module 1, 36610 Output 1: Module 2, 36770 Output 1: Module 3, 36930 Output 1: Module 4, 37090 Output 1: Module 5, 37250 Output 1: Module 6, 37410 Add 40 for the address of the next output"
Error	"None (61) Open (65) Shorted (127) Measurement Error (140) Bad Calibration Data (139) Ambient Error (9) RTD Error (141) Fail (32) Math Error (1423) Not Sourced (246) Stale (1617)"		"unsigned 16-bit Access = R"	"Output 1: Module 1, 36614 Output 1: Module 2, 36774 Output 1: Module 3, 36934 Output 1: Module 4, 37094 Output 1: Module 5, 37254 Output 1: Module 6, 37414 Add 40 for the address of the next output"
Output Type	"Form A Mechanical Relay (10029) Form A Mechanical Relay w/ Shared Common (10030) Form C Mechanical Relay (10028) NO-ARC Relay (10031)"		"unsigned 16-bit Access = R"	"Output 1: Module 1, 36624 Output 1: Module 2, 36784 Output 1: Module 3, 36944 Output 1: Module 4, 37104 Output 1: Module 5, 37264 Output 1: Module 6, 37424 Add 40 for the address of the next output"
Message List				
Message Enable	"No (59) Yes (106)"	No (59)	"unsigned 16-bit Access = RW"	"Message List 1: 37546 Message List n: 37546+((n-1)* 160)"
Message	20	[empty string]	"string Access=RW"	"Message List 1: 37548 Message List n: 37548+((n-1)* 160) Read 10 Registers for 20 Characters"
Logging				
Memory Full Action	"Stop (1638) Overwrite (1639)"	Stop (1638)	"unsigned 16-bit Access = RW"	42350

Parameter Class and Name	Range	Default	Data Type and Attributes	Modbus Registers
Available Logging Memory (MB)	0 To 4294967295		"unsigned 32-bit Access=R"	42352
Available Logging Time (Hours)	0 To 4294967295		"unsigned 32-bit Access=R"	42354
Source Value A	"Off (62) On (63)"		"unsigned 16-bit Access = R"	42362
Logging Status	"Recording (1990) Not Recording (1991)"		"unsigned 16-bit Access = R"	42368
File Size Limit (MB)	1 To 4294967295	0	"unsigned 32-bit Access=RW"	42372
Date Format	"MM/DD/YYYY (1631) DD/MM/YYYY (1632)"	MM/DD/YYYY (1631)	"unsigned 16-bit Access = RW"	42382
Time Format	"12 Hour (1966) 24 Hour (1967)"	12 Hour (1966)	"unsigned 16-bit Access = RW"	42384
Log Action	"None (61) Start (1782) Stop (1638)"		"unsigned 16-bit Access = RW"	42386
Log Interval	"0.1 sec (1971) 0.2 sec (1972) 0.5 sec (1973) 1 sec (1974) 2 sec (1975) 5 sec (1976) 10 sec (1977) 15 sec (1978) 30 sec (1979) 1 min (1980) 2 min (1985) 5 min (1981) 10 min (1986) 15 min (1987) 30 min (1988) 60 min (1989)"	5 min (1981)	"unsigned 16-bit Access = RW"	42388
Log To	"Internal (2057) USB Device (2058)"	Internal (2057)	"unsigned 16-bit Access = RW"	42390
File Type	"Encrypted (2064) CSV (2063) Both (13)"	Encrypted (2064)	"unsigned 16-bit Access = RW"	42392
Create Encrypted	"No (59) Yes (106)"	No (59)	"unsigned 16-bit Access = RW"	42394
Encryption Key	0 To 4294967295	Unit's Serial Number	"unsigned 32-bit Access=RW"	42396
Rediscover Log Points	"No (59) Yes (106)"	No (59)	"unsigned 16-bit Access = RW"	42398

D4T Base Specifications

Line Voltage/Power (Minimum/Maximum Ratings)

- High voltage option: 100 to 240V~ (ac) 50/60Hz $\pm 5\%$
 - Low voltage option: 24 to 28V (~ ac) (\hat{i} dc), +10/-15%, 50/60Hz $\pm 5\%$
 - Power consumption: 23 W, 54VA
-

Environment

- NEMA 4X/IP65 - front panel mount configuration only
 - 0 to 122°F (-18 to 50°C) operating temperature
 - -40 to 185°F (-40 to 85°C) storage temperature
 - 0 to 90% RH, non-condensing
-

Agency Approvals

- UL® Listed to UL 61010 File E185611 QUYYX
 - UL® 508 Reviewed
 - CSA CC.C#14, File 158031
 - AMS 2750 E compliant: Analog input process values. Tip: Maximize field calibration accuracy and uniformity by using advanced F4T features such as Calibration Offset and Linearization Function Blocks. Refer to user manual for details.
 - RoHS by design, China RoHS Level 2, W.E.E.E.
 - CE
 - Windows® Hardware Certification
-

User Interface

- 4.3 inch TFT PCAP color graphic touch screen
 - LED backlife >50K hours
 - 4 keys: Home, Main Menu, Back, Help
 - The following languages are available in the F4T by selecting Main_Menu/Settings/Global/Language: English, German, French, Italian, Spanish, Japanese, Korean and Chinese
-

Inputs and Outputs

- Input sampling: 10Hz
 - Output update: 10Hz
-

Communications

- Ethernet Modbus® TCP
- EIA-232/485 Modbus® RTU
- Isolated communications

Data Logging

- User selectable parameters: Up to a maximum of 128 active parameters depending on configuration
- Logging interval: Programmable increments between 0.1 seconds and 60 minutes if logging to internal memory. Logging directly to USB; 1.0 seconds to 60 minutes
- File types: .CSV for standard data logging or proprietary format for encrypted data log option
- Storage: 80MB internal memory or to USB memory stick
- File transfer: Internal memory to USB host port or to Ethernet Modbus[®] TCP
- Transfer options: On demand by user or user programmable based on when a new data log file record is available. Utilizes TFTP and Samba protocols
- Record: Date and time stamped

Batch Processing with Bar Code Data Entry Via USB Scanner

- Compatible with many bar code types including Code 128, Code 39, Extended Code 39, Data Matrix, Interleaved 2 of 5, ISSN, SISAC, LOGMARS, QR, UCC/EAN-128 (GS1-128, UPC-A & E)
- Compatible with most USB scanner types such as Zebra DS4308, DS2208, LI2208 and LS2208
- USB port provides 500mA max. power supply for bar code scanner/base charging
- Display can show bar code fields up to a maximum length of 48 characters. Characters might wrap to 2 rows after 24 characters
- Program the bar code scanner to add an enter key (carriage return feed) at the end of each bar code data field sent to F4T/D4T. Refer to USB scanner user manual.

Trending

- 4 user programmable charts
- 6 pens available per chart
- View analog sensors and process values

Real Time Clock and Battery Backup

- Accuracy (typical): ± 3 ppm over 5°F (-15°C) to 122°F (50°C)
- Battery type: lithium, field replaceable (Watlow part #: 0830-0858-0000) (recycle properly)
- Typical battery life: 10 years at 77°F (25°C)

Number of Function Blocks by Ordering Option

Function Block	Basic	Set 1	Set 2
Alarm	6	8	14
Compare	None	4	16
Counter	None	4	16
Linearization	4	4	8
Logic	None	12	24
Math	None	12	24
Process Value	4	4	8
Special Output Function (including compressor)	None	2	4
Timer	None	6	16
Variable	4	12	24

Compare

- Greater than, less than, equal, not equal, greater than or equal, less than or equal

Counters

- Counts up or down, loads predetermined value on load signal

Linearization

- Interpolated or stepped

Logic

- And, nand, or, nor, equal, not equal, latch, flip-flop

Math

- Average, process scale, switch over, deviation scale, differential (subtract), ratio (divide), add, multiply, absolute difference, minimum, maximum, square root, sample and hold, pressure-to-altitude and dew point

Process Value

- Sensor backup, average, crossover, wet bulb-dry bulb, switch over, differential (subtract), ratio (divide), add, multiply, absolute difference, minimum, maximum, square root, altitude, Vaisala® relative humidity and pressure-to-altitude

Special Output Function

- Compressor control (cool and/or dehumidify with single compressor), motorized valve, sequencer

Timers

- On pulse, delay, one shot or retentive

Variable

- User value for digital or analog variable

D4T Base Ordering Information

Base includes: Battery Backup, Real-Time Clock, 4.3 inch color graphical touch panel, 2 USB host, USB configuration port, standard bus, wired Ethernet Modbus® TCP. Backwards compatible Modbus for select key SERIES F4D/P/S parameters (see the D4T Setup and Operation User's Guide)

D4T Part Number

Model	Base Type	Application Type	Data Logging & Trend Charts	Power Supply Connector & Voltage, Logo	Function Blocks	Future Options	Documentation, Accent Bar, Replacement Connector & Custom	d Additional Options	Number of Logging Channels & Input Hardware Types	Number of Aux/Alarm outputs, Digital Inputs and Hardware Types
D4	T					AA		5		

Base Type	
T =	Touch Screen

Application Type	
1 =	Standard

Data Logging	
J =	Data logging
K =	Data logging with encrypted files
L =	Data logging with graphical trend chart
M =	Data logging with encrypted files, graphical trend charts and batch processing with bar code data entry.

Power Supply, Connector & Logo			
	Power Supply	Connector	Watlow Logo
1 =	100 to 240Vac	Right angle (standard)	Yes
2 =	100 to 240Vac	Right angle (standard)	No
3 =	100 to 240Vac	Front screw	Yes
4 =	100 to 240Vac	Front screw	No
5 =	24 to 28Vac or Vdc	Right angle (standard)	Yes
6 =	24 to 28Vac or Vdc	Right angle (standard)	No
7 =	24 to 28Vac or Vdc	Front screw	Yes
8 =	24 to 28Vac or Vdc	Front screw	No

Function Blocks			
	Basic Set	Set 1	Set 2
A =	X		
B =		X	
C =			X

Future Options	
AA =	Future Options

Documentation, Accent Bar, Replacement Connector & Custom					
	Documentation	Decorated Brush Aluminium Accent Bar			
	DVD / QSG	Gray	Blue	Red	None
1A =	Yes	X			
1B =	Yes		X		
1C =	Yes			X	
1D =	Yes				X
1E =	No	X			
1F =	No		X		
1G =	No			X	
1H =	No				X
1J =	Replacement connectors only - for the model number entered				
XX =	Contact factory, other custom-firmware, preset parameters, locked code, logo				

Number of Logging Channels and Input Hardware Types	
Universal Input(s) - TC, RTD 2 or 3 wire, 0 to 10Vdc or 0 to 20mA	
U1 =	1 Channel
U2 =	2 Channels
U3 =	3 Channels
U4 =	4 Channels
U5 =	5 Channels
U6 =	6 Channels
Thermistor Input(s)	
T1 =	1 Channel
T2 =	2 Channels
T3 =	3 Channels
T4 =	4 Channels
T5 =	5 Channels
T6 =	6 Channels
Universal Inputs - TC, RTD 2 wire, 0 to 10Vdc or 0 to 20mA	
04 =	4 Channels
08 =	8 Channels
12 =	12 Channels
16 =	16 Channels
20 =	20 Channels
24 =	24 Channels
Thermistor Inputs	
TA =	4 Channels
TB =	8 Channels
TC =	12 Channels
TD =	16 Channels
TE =	20 Channels
TF =	24 Channels
Custom	
XX =	Different channel quantity and combination options. Contact factory for assistance.

Number of Auxiliary/Alarm outputs, Digital inputs and Hardware	
Options below are not available with 6 or 24 channel input modules	
A =	None
Single Output	
C =	1 switched dc/open collector
E =	1 mechanical relay 5A, Form C output
F =	1 universal process/retransmit
Multiple Digital Inputs/Outputs	
D =	6 digital I/O
P =	3 universal process/retransmit outputs
B =	3 mechanical relay 5A, 2 Form C and 1 Form A (Form A shares a common with 1 Form C)
J =	4 mechanical relay 5A, Form A
K =	2 SSRs Form A, 0.5 A
T* =	2 SSRs at 10A
L =	4 SSRs at 2A each, SSRs grouped in 2 pairs with each pair sharing a common
Communications	
M =	Modbus® RTU 232/485
Custom	
X =	Different output quantity and combination options. Contact factory for assistance.
* Option "T" not available with digit 13 & 14, options U5, U6, T5, T6, 20, 24, TE and TF	

Flex Modules and Limit I/O Specifications

1 Universal Input

- Thermocouple, grounded or ungrounded sensors
 - >20MΩ input impedance
- Max. of 2KΩ source resistance
- RTD 2 or 3 wire, platinum, 100Ω and 1000Ω @ 32°F (0°C) calibration to DIN curve (0.00385Ω/Ω/°C)
 - Maximum lead resistance 10Ω
- Process, 0-20mA @ 100Ω ,or 0-10V î(dc) @ 20kΩ input impedance; scalable, 0 - 50mV

Voltage Input Ranges

- Accuracy ±10mV ±1 LSD at standard conditions
- Temperature stability ±100 PPM/°C maximum

Milliamp Input Ranges

- Accuracy ±20µA ±1 LSD at standard conditions
- Temperature stability ±100 PPM/°C maximum

Resolution Input Ranges

- 0 to 10V: 200 µV nominal
- 0 to 20 mA: 0.5 mA nominal

- Potentiometer: 0 to 1,200Ω
- Inverse scaling

Input Type	Max Error @ 25 Deg C	Accuracy Range Low	Accuracy Range High	Units
J	±1.75	0	750	Deg C
K	±2.45	-200	1250	Deg C
T (-200 to 350)	±1.55	-200	350	Deg C
N	±2.25	0	1250	Deg C
E	±2.10	-200	900	Deg C
R	±3.9	0	1450	Deg C
S	±3.9	0	1450	Deg C
B	±2.66	870	1700	Deg C
C	±3.32	0	2315	Deg C
D	±3.32	0	2315	Deg C
F (PTII)	±2.34	0	1343	Deg C
RTD, 100 ohm	±2.00	-200	800	Deg C
RTD, 1000 ohm	±2.00	-200	800	Deg C
mV	±0.05	0	50	mV
Volts	±0.01	0	10	Volts
mAdc	±0.02	2	20	mAmps DC
mAac	±5	-50	50	mAmps AC
Potentiometer, 1K range	±1	0	1000	Ohms

Operating Range		
Input Type	Range Low	Range High
J	-210 °C	1200 °C
K	-270 °C	1371 °C
T	-270 °C	400 °C
N	-270 °C	1300 °C
E	-270 °C	1000 °C
R	-50 °C	1767 °C
S	-50 °C	1767 °C
B	-50 °C	1816 °C
C	0 °C	2315 °C
D	0 °C	2315 °C
F (PTII)	0 °C	1343 °C
RTD (100 ohm)	-200 °C	800 °C
RTD (1000 ohm)	-200 °C	800 °C
mV	-50	50
Volts	0	10
mAdc	0	20
mAac	-50	50
Potentiometer, 1K range	0	1200 ohms
Resistance, 5K range	0	5000 ohms
Resistance, 10K range	0	10000 ohms
Resistance, 20K range	0	20000 ohms
Resistance, 40K range	0	40000 ohms

1 Thermistor Input

Input Type	Max Error @ 25 Deg C	Accuracy Range Low	Accuracy Range High	Units
Thermistor, 5K range	±5	0	5000	Ohms
Thermistor, 10K range	±10	0	10000	Ohms
Thermistor, 20K range	±20	0	20000	Ohms
Thermistor, 40K range	±40	0	40000	Ohms

- 0 to 40KΩ, 0 to 20KΩ, 0 to 10KΩ, 0 to 5KΩ
- 2.252KΩ and 10KΩ base at 77°F (25°C)
- Linearization curves built in
- Third party Thermistor compatibility requirements

Base R @ 25C	Alpha Techniques	Beta THERM	YSI
2.252K	Curve A	2.2K3A	004
10K	Curve A	10K3A	016
10K	Curve C	10K4A	006

1 Digital Input

- Digital input update rate 10Hz
 - **DC voltage**
 - Max. input 36V @ 3mA
 - Min. high state 3V at 0.25mA
 - Max. low state 2V
 - **Dry contact**
 - Min. open resistance 10K Ω
 - Max. closed resistance 50 Ω
 - Max. short circuit 13mA

Switched DC Output

- Switched dc = 22 to 32V_i(dc) @ 30mA per output, 40mA per pair (option CC)

Open Collector Output

- Switched dc/open collector = 30V_i(dc) max. @ 100mA max. current sink

Solid-State Relay Output

- Form A, 1A at 50°F (10°C) to 0.5A at 149°F (65°C), 0.5A at 24V_A (ac) min., 264V_A (ac) max., opto-isolated, without contact suppression

Form A Electromechanical Relay Output

- 5A, 24 to 240V_A (ac) or 30V_i(dc) max., resistive load, 100,000 cycles at rated load, requires a min. load of 20mA at 24V, 125VA pilot duty

Form C Electromechanical Relay Output

- 5A, 24 to 240V_A (ac) or 30V_i(dc) max., resistive load, 100,000 cycles at rated load, requires a min. load of 20mA at 24V, 125VA pilot duty

1 Universal Process/Retransmit Output

- Universal process/retransmit, Output range selectable:
 - 0 to 10V_i(dc) into a min. 4,000 Ω load
 - 0 to 20mA into max. 800 Ω load

Resolution

- dc ranges: 2.5mV nominal resolution
- mA ranges: 5 μ A nominal resolution

Calibration Accuracy

- dc ranges: \pm 15 mV
- mA ranges: \pm 30 μ A

Temperature Stability

- 100 ppm/ $^{\circ}$ C

Flex Module - Mixed I/O Ordering Information

Part Number

	Module ID Type	Future Option		Input Hardware	Output Hardware Options	Future Option		Future Options	Custom Options and Connectors	d Custom Options - Firmware, Overlay, Preset Parameters, Locked Code
FM	M	A	-			A	-	A		

Module Type	
M =	Mixed I/O

Input Hardware	
A =	None
U =	Universal input - T/C, RTD 2- or 3-wire, 0-10VDC, 0-20mA
T =	Thermistor input
C =	Current transformer input

Output Hardware Options		
	Output 1	Output 2
AA =	None	None
AJ =	None	Mechanical relay 5A, Form A
AK =	None	SSR Form A, 0.5A
CA =	Switched dc/open collector	None
CH =	Switched dc/open collector	NO-ARC 12A power control
CC =	Switched dc/open collector	Switched dc
CJ =	Switched dc/open collector	Mechanical relay 5A, Form A
CK =	Switched dc/open collector	SSR Form A, 0.5A
EA =	Mechanical relay 5A, Form C	None
EH =	Mechanical relay 5A, Form C	NO-ARC 12A power control
EC =	Mechanical relay 5A, Form C	Switched dc
EJ =	Mechanical relay 5A, Form C	Mechanical relay 5A, Form A
EK =	Mechanical relay 5A, Form C	SSR Form A, 0.5A
FA =	Universal process/retransmit	None
FC =	Universal process/retransmit	Switched dc
FJ =	Universal process/retransmit	Mechanical relay 5A, Form A
FK =	Universal process/retransmit	SSR Form A, 0.5A
KH =	SSR Form A, 0.5A	NO-ARC 12A power control
KK =	SSR Form A, 0.5A	SR Form A, 0.5A

Custom Options and Connectors	
A =	Right angle screw connector (standard)
F =	Front screw connector

d Custom Options - Firmware, Overlay, Preset Parameters, Locked Code	
AA =	Standard with quick start guide
AB =	Standard without quick start guide
AC =	Replacement connectors hardware only - for the entered model number
XX =	Custom

Flex Modules - High Density I/O Specifications

4 Universal Inputs

- Thermocouple, grounded or ungrounded sensors
- >20MΩ input impedance
- Max. of 2KΩ source resistance
- RTD 2 or 3 wire, platinum, 100Ω and 1000Ω @ 32°F (0°C) calibration to DIN curve (0.00385Ω/Ω/°C)
- Process, 0-20mA @ 100Ω ,or 0-10V î(dc) @ 20kΩ input impedance; scalable, 0 - 50mV

Voltage Input Ranges

- Accuracy ±10mV ±1 LSD at standard conditions
- Temperature stability ±100 PPM/°C maximum

Milliamp Input Ranges

- Accuracy ±20µA ±1 LSD at standard conditions
- Temperature stability ±100 PPM/°C maximum

Resolution Input Ranges

- 0 to 10V: 200 µV nominal
- 0 to 20 mA: 0.5 mA nominal
- Potentiometer: 0 to 1,200Ω
- Inverse scaling

Input Type	Max Error @ 25 Deg C	Accuracy Range Low	Accuracy Range High	Units
J	±1.75	0	750	Deg C
K	±2.45	-200	1250	Deg C
T (-200 to 350)	±1.55	-200	350	Deg C
N	±2.25	0	1250	Deg C
E	±2.10	-200	900	Deg C
R	±3.9	0	1450	Deg C
S	±3.9	0	1450	Deg C
B	±2.66	870	1700	Deg C
C	±3.32	0	2315	Deg C
D	±3.32	0	2315	Deg C
F (PTII)	±2.34	0	1343	Deg C
RTD, 100 ohm	±2.00	-200	800	Deg C
RTD, 1000 ohm	±2.00	-200	800	Deg C
mV	±0.05	0	50	mV
Volts	±0.01	0	10	Volts
mAdc	±0.02	2	20	mAmps DC
mAac	±5	-50	50	mAmps AC
Potentiometer, 1K range	±1	0	1000	Ohms

Operating Range		
Input Type	Range Low	Range High
J	-210 °C	1200 °C
K	-270 °C	1371 °C
T	-270 °C	400 °C
N	-270 °C	1300 °C
E	-270 °C	1000 °C
R	-50 °C	1767 °C
S	-50 °C	1767 °C
B	-50 °C	1816 °C
C	0 °C	2315 °C
D	0 °C	2315 °C
F (PTII)	0 °C	1343 °C
RTD (100 ohm)	-200 °C	800 °C
RTD (1000 ohm)	-200 °C	800 °C
mV	-50	50
Volts	0	10
mAdc	0	20
mAac	-50	50
Potentiometer, 1K range	0	1200
Resistance, 5K range	0	5000
Resistance, 10K range	0	10000
Resistance, 20K range	0	20000
Resistance, 40K range	0	40000

4 Thermistor Inputs

Input Type	Max Error @ 25 Deg C	Accuracy Range Low	Accuracy Range High	Units
Thermistor, 5K range	±5	0	5000	Ohms
Thermistor, 10K range	±10	0	10000	Ohms
Thermistor, 20K range	±20	0	20000	Ohms
Thermistor, 40K range	±40	0	40000	Ohms

- 0 to 40KΩ, 0 to 20KΩ, 0 to 10KΩ, 0 to 5KΩ
- 2.252KΩ and 10KΩ base at 77°F (25°C)
- Linearization curves built in
- Third party Thermistor compatibility requirements

Base R @ 25C	Alpha Techniques	Beta THERM	YSI
2.252K	Curve A	2.2K3A	004
10K	Curve A	10K3A	016
10K	Curve C	10K4A	006

3 Universal Process/Retransmit Outputs

- Universal process/retransmit, Output range selectable:
 - 0 to 10V \hat{I} (dc) into a min. 4,000 Ω load
 - 0 to 20mA into max. 800 Ω load

Resolution

- dc ranges: 2.5mV nominal resolution
- mA ranges: 5 μ A nominal resolution

Calibration Accuracy

- dc ranges: \pm 15 mV
- mA ranges: \pm 30 μ A

Temperature Stability

- 100 ppm/ $^{\circ}$ C

3 Mechanical Relay Outputs

- 2 Form C relays, 1 Form A relay. Form A shares common with 1 Form C relay
- Each relay is rated at 5A, 24 to 240V \hat{A} (ac) or 30V \hat{I} (dc)max., resistive load, 100,000 cycles at rated load. Requires a min. load of 20mA at 24V, 125 VA pilot duty

4 Mechanical Relay Outputs

- Form A, 5A each, 24 to 240V \hat{A} (ac) or 30V \hat{I} (dc)max., resistive load, 100,000 cycles at rated load. Requires a min. load of 20mA at 24V, 125 VA pilot duty

2 Solid-State Relays

- Form A, 10A max. each SSRs combined at 24V \hat{A} (ac) min., 264V \hat{A} (ac) max., opto-isolated, without contact suppression, max. resistive load 10A per output at 240V \hat{A} (ac), max. 20A per card at 122 $^{\circ}$ F (50 $^{\circ}$ C), max.
- 12A per card at 149 $^{\circ}$ F (65 $^{\circ}$ C)

4 Solid-State Relays

- Two pairs of SSRs, each pair shares a common
- Form A, 24V \hat{A} (ac) min., 264V \hat{A} (ac) max., opto-isolated, without contact suppression, resistive load 2A per output at 240V \hat{A} (ac), max. See table for max. current per output

Ambient Temperature	1 Module per Base	2 or More Modules
20 $^{\circ}$ C	2.00A	1.50A
50 $^{\circ}$ C	1.30A	1.00A

6 Digital Input/Output Option - (6 DIO)

- Digital input update rate 10Hz
 - DC voltage
 - Max. input 36V @ 3mA
 - Min. high state 3V at 0.25mA
 - Max. low state 2V
 - Dry contact
 - Min. open resistance 10K Ω
 - Max. closed resistance 50 Ω
 - Max. short circuit 13mA

- Digital output update rate 10Hz
 - Output voltage 24V, current limit, Output 6 = 10mA max., Output 5 = 3 pole DIN-A-MITE® or 24mA max.

Flex Module - High Density Ordering Information

Part Number

	Module ID Type	Future Option		Input and Output Hardware	Future Option		Future Options	Custom Options and Connectors	d Custom Options - Firmware, Overlay, Preset Parameters, Locked Code
FM	H	A	-		AAA	-	A		

Module Type	
H =	High Density I/O

Input and Output Hardware	
R =	4 universal inputs (T/C, RTD 2-wire, 0-10VDC, 0-20mA)
P =	4 thermistor inputs
C =	6 digital I/O
F =	3 universal process/retransmit outputs
B =	3 mechanical relay 5A, 2 Form C and 1 Form A (Form A shares a common with one Form C)
J =	4 mechanical relay 5A, Form A
K =	2 SSRs 10A
L =	4 SSRs at 2A each. SSRs grouped in 2 pairs with each pair sharing a common

Custom Options and Connectors	
A =	Right angle screw connector (standard)
F =	Front screw connector

d Custom Options - Firmware, Overlay, Preset Parameters, Locked Code	
AA =	Standard with quick start guide
AB =	Standard without quick start guide
AC =	Replacement connectors hardware only - for the entered model number
XX =	Custom

Flex Module - Communications Ordering Information

Part Number

	Module ID Type	Future Option		Comm. Option	Future Option		Future Options	Custom Options and Connectors	d Custom Options - Firmware, Overlay, Preset Parameters, Locked Code
FM	C	A	-	2	A	-	A		

Communication Option	
2 =	Modbus® RTU 232/485*

Custom Options and Connectors	
A =	Right angle screw connector (standard)
F =	Front screw connector

d Custom Options - Firmware, Overlay, Preset Parameters, Locked Code	
AA =	Standard with quick start guide
AB =	Standard without quick start guide
AC =	Replacement connectors hardware only - for the entered model number
XX =	Custom

Declaration of Conformity

Series (D or F) 4T



WATLOW Electric Manufacturing Company

ISO 9001 since 1996.

1241 Bundy Blvd.
Winona, MN 55987 USA

Declares that the following products:

Designation: **Series (D or F) 4T ¼ DIN Control**
Model Numbers: F4T X X (1 to 8) – X AA XX X – XXX
D4T X X (1 to 8) – X AA XX 5 – XXX X = any number or letter.
Classification: F4T = Process Controller Base
D4T = Data logger
Both Models rated – Installation Category II,
IP65 or IP40 if flush mount option is used.
Rated Voltage and Frequency: High Voltage 100 to 240 V~ (ac) 50/60 Hz, (D or F) 4TXX(1, 2, 3, 4)
Low Voltage 24 to 28 V~ (ac/dc) 50/60 Hz, (D or F) 4TXX(5, 6, 7, 8)
Rated Power Consumption: Up to 23 Watts with six modules loaded.

Only the front display is considered part of the ultimate enclosure, the unit is considered an open type process control, it requires an ultimate enclosure and at least one **Watlow EZ-ZONE® FM “Flex Module”** to have a useful function. All Flex Modules were tested as part of F4T system for compliance with the following directives.

2014/30/EU Electromagnetic Compatibility Directive

EN 61326-1:2013

Electrical equipment for measurement, control and laboratory use – EMC requirements (Industrial Immunity, Group 1 Class A¹ Emissions).

EN 55011:2016

Electrostatic discharge immunity

IEC 61000-4-2:2008

Radiated, radio-frequency electromagnetic field immunity, 10 V/m 80 MHz to 1 GHz, 3 V/m 1.4 GHz to 2.7 GHz

IEC 61000-4-3:2007 +

A1/2008, A2/2010

IEC 61000-4-4:2012

Electrical fast transient / burst immunity

IEC 61000-4-5:2014

Surge immunity

IEC 61000-4-6:2013 +

Immunity to conducted disturbances induced by radio-frequency fields

Corrigendum 2015

IEC 61000-4-11:2004 +

Voltage dips, short interruptions and voltage variations immunity

Interpretation 2010

EN 61000-3-2:2014

Limits for harmonic current emissions for equipment ≤ 16 Amps per phase

EN 61000-3-3²:2013

Voltage fluctuations and flicker for equipment ≤ 16 Amps per phase

SEMI F47-0812

Specification for semiconductor sag immunity Figure R1-1

¹NOTE: Caution: This equipment is not intended for use in residential environments and may not provide adequate protection to radio reception in such environments.

²NOTE: To comply with flicker requirements cycle time may need to be up to 160 seconds if load current is at 15A, or the maximum source impedance needs to be < 0.13Ω. Unit power of F4T model complies with 61000-3-3 requirements.

2014/35/EU Low-Voltage Directive

EN 61010-1:2010

Safety Requirements of electrical equipment for measurement, control and laboratory use. Part 1: General requirements

Compliant with 2011/65/EU RoHS2 Directive

Per 2012/19/EU W.E.E Directive and 2006-66-EC Battery Directive  Please Recycle Properly.

Joe Millanes

Name of Authorized Representative

Winona, Minnesota, USA

Place of Issue

Directory of Operations

Title of Authorized Representative

October, 2016

Date of Issue

Signature of Authorized Representative

How to Reach Us

Corporate Headquarters

Watlow Electric Manufacturing Company
12001 Lackland Road
St. Louis, MO 63146
Sales: 1-800-WATLOW2
Manufacturing Support: 1-800-4WATLOW
Email: info@watlow.com
Website: www.watlow.com
From outside the USA and Canada:
Tel: +1 (314) 878-4600
Fax: +1 (314) 878-6814

Latin America

Watlow de México S.A. de C.V.
Av. Fundación No. 5
Col. Parques Industriales
Querétaro, Qro. CP-76130
Mexico
Tel: +52 442 217-6235
Fax: +52 442 217-6403

Europe

Watlow Plasmatech GmbH
Brennhoflehan - Kellau 156
431 Kuchl
Austria
Tel: +3 0244 20129
Email: austria@watlow.com
Website: www.watlow.com

Watlow France
Tour d'Asnières.
4 Avenue Laurent Cély
92600 Asnières sur Seine
France
Tél: + 33 (0) 1 41 32 79 70
Télécopie: + 33(0)1 47 33 36 57
Email: info@watlow.fr
Website: www.watlow.com

Watlow GmbH
Postfach 11 65, Lauchwasenstr. 1
D-76709 Kronau
Germany
Tel: +49 (0) 7253 9400-0
Fax: +49 (0) 7253 9400-900
Email: info@watlow.de
Website: www.watlow.com

Watlow Italy S.r.l.
Viale Italia 52/54
20094 Corsico Milano
Italy
Tel: +39 024588841
Fax: +39 0245869954
Email: italyinfo@watlow.com
Website: www.watlow.com

Watlow Ibérica, S.L.U.
C/Marte 12, Posterior, Local 9
E-28850 Torrejón de Ardoz
Madrid - Spain
T. +34 91 675 12 92
F. +34 91 648 73 80
Email: info@watlow.es
Website: www.watlow.com

Watlow Ltd.
Roby Close, Linby Ind. Estate
Linby
NG15 8AA Nottingham
United Kingdom
Email: info@watlow.co.uk
Website: www.watlow.com
From outside The United Kingdom:
Tel: +44 (0) 115 964 0777
Fax: +44 (0) 115 964 0071

Asia and Pacific

Watlow Singapore Pte Ltd.
20 Kian Teck Lane, 4th Floor
Singapore 627854
Tel: +65 6773 9488
Fax: +65 6778 0323
Email: info@watlow.com.sg
Website: www.watlow.com.sg

Watlow Electric Manufacturing Company (Shanghai) Co. Ltd.
Greenland International Plaza Room 1306
275-8 East Guoding Road, Yangpu District
Shanghai 200433
China
Local Phone: 4006 Watlow (4006 928569)
International: +86 21 3381 0188
Fax: +86 21 6106 1423
Email: info-cn@watlow.com
Website: www.watlow.cn

Watlow Thermal Solutions India Pvt., Ltd.
401 Aarohan Plaza, 4th Floor
No. 6-3-678/1 Panjagutta
Hyderabad 500082 Telangana
India
Tel: +91-40-666 12700
Email: infoindia@watlow.com
Website: www.watlow.com

ワトロー・ジャパン株式会社
〒101-0047 東京都千代田区内神田1-14-4
四国ビル別館9階
Tel: 03-3518-6630 Fax: 03-3518-6632
Email: infoj@watlow.com Website: www.watlow.co.jp

Watlow Japan Ltd.
Shikoku Building Annex 9th Floor
1-14-4 Uchikanda, Chiyoda-Ku
Tokyo 101-0047
Japan
Tel: +81-3-3518-6630 Fax: +81-3-3518-6632
Email: infoj@watlow.com Website: www.watlow.co.jp

Watlow Korea Co., Ltd.
#2208, Hyundai KIC Building B, 70 Doosan-ro
Geumcheon-gu, Seoul
Republic of Korea
Tel: +82 (2) 2169-2600 Fax: +82 (2) 2169-2601
Website: www.watlow.co.kr

瓦特龍電機股份有限公司
80143 高雄市前金區七賢二路189號 10樓之一
電話: 07-2885168 傳真: 07-2885568

Watlow Electric Taiwan Corporation
10F-1 No.189 Chi-Shen 2nd Road Kaohsiung 80143
Taiwan
Tel: +886-7-2885168 Fax: +886-7-2885568
Email: ryeh@watlow.com
Website: www.watlow.com

Your Authorized Watlow Distributor

