

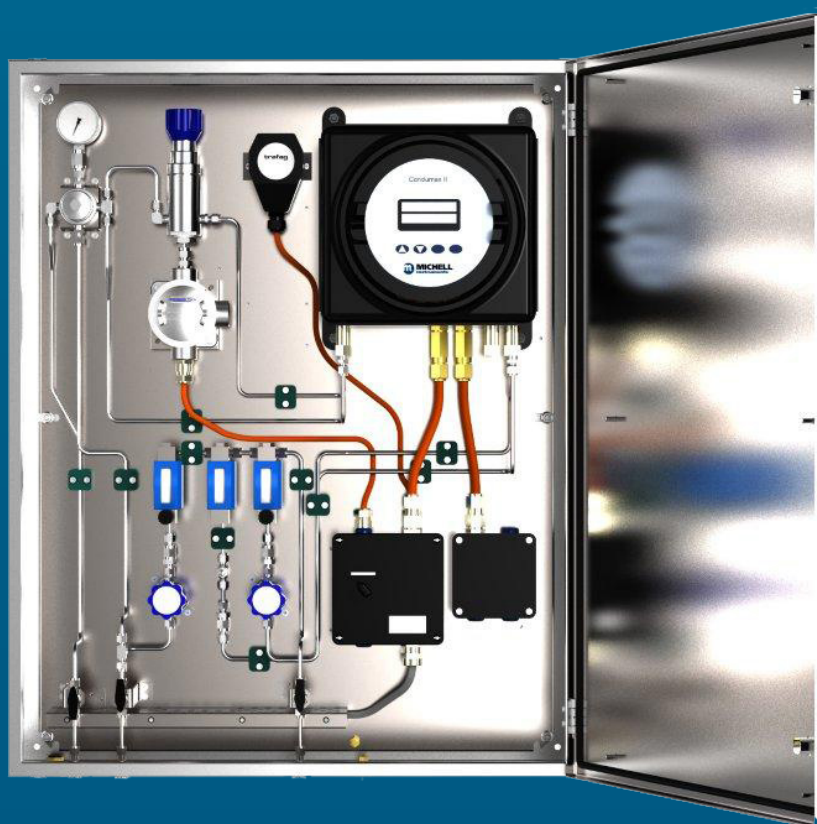

# Condumax II Hydrocarbon Dew-Point Analyzer Sampling System

## Installation, Operation & Maintenance Manual



97304, Issue 5.3  
September 2018

Please fill out the form(s) below for each instrument that has been purchased.

Use this information when contacting Michell Instruments for service purposes.

Instrument	
Code	
Serial Number	
Invoice Date	
Location of Instrument	
Tag No	

Instrument	
Code	
Serial Number	
Invoice Date	
Location of Instrument	
Tag No	

Instrument	
Code	
Serial Number	
Invoice Date	
Location of Instrument	
Tag No	



## Condumax II

For Michell Instruments' contact information please go to  
[www.michell.com](http://www.michell.com)

© 2018 Michell Instruments

This document is the property of Michell Instruments Ltd. and may not be copied or otherwise reproduced, communicated in any way to third parties, nor stored in any Data Processing System without the express written authorization of Michell Instruments Ltd.

---

## Contents

Safety .....	v
Electrical Safety .....	v
Pressure Safety .....	v
Toxic Materials .....	v
Repair and Maintenance .....	v
Safety Conformity .....	v
Abbreviations .....	vi
Warnings .....	vi
1 INTRODUCTION .....	1
1.1 General .....	1
2 INSTALLATION .....	4
2.1 Gas Connections .....	6
2.2 Power Supply Connection .....	6
2.3 Output Wiring Connections .....	7
3 OPERATION .....	8
3.1 System Start-Up Procedure .....	9
3.2 System Shut-Down Procedure .....	11
3.3 Pressure Regulator Temperature Control .....	11
4 OPTIONS .....	13
4.1 Enclosure Heater Temperature Control .....	13
4.2 Enclosure Cooling .....	14
4.3 Trace Heated Sample Line .....	15
5 MEMBRANE AND PARTICULATE FILTER ELEMENT REPLACEMENT .....	16
5.1 Service Intervals .....	16
5.2 Installing the Filter Element and Membrane .....	16

## Figures

<i>Figure 1</i>	<i>Condumax II Sampling System - Indoor Version .....</i>	<i>4</i>
<i>Figure 2</i>	<i>Condumax II Sampling System - Outdoor Version .....</i>	<i>5</i>

## Appendices

Appendix A	Technical Specifications .....	20
Appendix B	Quality, Recycling, Compliance & Warranty Information .....	22
Appendix C	Return Document & Decontamination Declaration .....	24

## **Safety**

The manufacturer has designed this equipment to be safe when operated using the procedures detailed in this manual. The user must not use this equipment for any other purpose than that stated. Do not apply values greater than the maximum value stated.

This manual contains operating and safety instructions, which must be followed to ensure the safe operation and to maintain the equipment in a safe condition. The safety instructions are either warnings or cautions issued to protect the user and the equipment from injury or damage. Use competent personnel using good engineering practice for all procedures in this manual.

## **Electrical Safety**

The instrument is designed to be completely safe when used with options and accessories supplied by the manufacturer for use with the instrument. The input power supply voltage limits are 110 to 120 V AC, 60 Hz or 220 to 240 V AC, 50 Hz.

## **Pressure Safety**

DO NOT permit pressures greater than the safe working pressure to be applied to the instrument. The specified safe working pressure is 100 barg (1450 psig). Refer to Appendix A, Technical Specifications.

## **Toxic Materials**

The use of hazardous materials in the construction of this instrument has been minimized. During normal operation it is not possible for the user to come into contact with any hazardous substance which might be employed in the construction of the instrument. Care should, however, be exercised during maintenance and the disposal of certain parts.

## **Repair and Maintenance**

The instrument must be maintained either by the manufacturer or an accredited service agent. Refer to [www.michell.com](http://www.michell.com) for details of Michell Instruments' worldwide offices contact information.

## **Safety Conformity**

This product meets the essential protection requirements of the relevant EU directives.

## Abbreviations

The following abbreviations are used in this manual:

AC	alternating current
barg	pressure unit (=100 kP or 0.987 atm)
°C	degrees Celsius
°F	degrees Fahrenheit
lbs	pound(s)
kg	kilogram(s)
HCdp	hydrocarbon dew point
NI/min	normal liters per minute
m	meter(s)
mA	milliampere
max	maximum
m <sup>3</sup> /hour	cubic meters per hour
mm	millimeters
%	percentage
psig	pounds per square inch
temp	temperature
V	Volts
W	Watts

## Warnings

The following general warnings listed below are applicable to this instrument. They are repeated in the text in the appropriate locations.



**Where this hazard warning symbol appears in the following sections it is used to indicate areas where potentially hazardous operations need to be carried out.**



**Where this symbol appears in the following sections it is used to indicate areas of potential risk of electric shock.**

## 1 INTRODUCTION

### 1.1 General

The Condumax II Hydrocarbon Dew-Point Analyzer Sampling System is specifically designed for the measurement of hydrocarbon and water dew point in natural gas. The addition of water dew point is optional to factory order. The system is configured with the necessary pressure letdown and flow control required for measurement at pressure before finally venting to an atmospheric or a low pressure flare line system. A fast-loop bypass flow arrangement is included to reduce sample flow response time lag and to enable the filter to be drained automatically of any potential hydrocarbon liquids and hydrates formed. Tube and process connections are available in 6mm or 1/4" OD.

HC dew-point analysis pressure is adjusted by a heated pressure regulator in the range up to 70 barg (1,000 psig) for ATEX/IECEX or 35 barg (500 psig) in the case of CSA certified versions. However, it is typical for measurements to be made at the cricondenthem condition of 27 barg (400 psig), where the highest HC dew-point temperature will be detected on the retrograde phase envelope.

The water dew point (where fitted) is measured at full pipeline pressure, to determine the highest water dew point for the gas sample being analyzed.

The complete Condumax II Hydrocarbon Dew-Point Analyzer Sampling System can be located close to the gas sample take-off point in a potentially explosive environment - designated Zone 1 and Zone 2 hazardous area.

The indoor version Sampling System gas handling components are assembled on a stainless steel plate suitable for wall mounting within a temperature controlled analyzer house.

The outdoor version Sampling System is housed within a stainless steel enclosure (304 or 316) for direct field installation next to the process line (with overall environmental protection to IP66).

The Sampling System must be located in a constant temperature controlled environment of at least +10°C (+18°F) above the highest envisaged dew-point temperature. All sample gas wetted metallic parts are in AISI 316L stainless steel with Viton® soft parts that comply with the NACE standard MR-01-75 (latest edition). Tube fittings are twin ferrule compression type. All gas and cable entries are located in the base of the enclosure.

The sample flow gas handling components are as follows:

- **Gas Inlet Isolation Valve (BV1):**  
Allows user to manually isolate the system from the process sample gas supply line for maintenance or servicing.
- **Coalescing & Membrane Filter (F1):**  
Provides system protection from contamination of liquid carry-over of hydrocarbon / glycol mist particles using membrane filtration.

- **Line Pressure Gauge (PG1):**  
Indicates the sample gas line pressure.
- **HCdp Pressure Regulator (PR1):**  
Allows the user to manually set the sample gas analysis pressure for hydrocarbon dew-point measurement.
- **HC and H<sub>2</sub>O Dew-Point Analyzer (Condumax II):**  
Provides measurement and output of hydrocarbon & water dew point of the sample gas.
- **Non Return Valve (NRV1):**  
Provides system protection from back pressure of vent gas when sample gas is not flowing.
- **HCdp Flow Metering Valve (FV1):**  
Allows the user to manually set the sample gas flow rate across the hydrocarbon dew-point sensor.
- **HCdp Flowmeter (FM1):**  
Provides indication of the sample gas flow rate across the hydrocarbon dew-point sensor.
- **H<sub>2</sub>Odp Letdown Pressure Regulator (PR3) {if fitted}:**  
Provides pressure letdown from line pressure to a lower vent pressure.
- **Non Return Valve (NRV3) {if fitted}:**  
Provides system protection from back pressure of vent gas when sample gas is not flowing.
- **H<sub>2</sub>Odp Flowmeter/Metering Valve (FM3) {if fitted}:**  
Allows the user to manually set and provide indication of the sample gas flowrate across the water dew-point sensor.
- **Gas Outlet Isolation Valve (BV2):**  
Allows the user to manually isolate the system from the gas outlet line for maintenance or servicing.



The bypass flow gas handling components are as follows:

- Bypass Flow Letdown Pressure Regulator (PR2):**  
Provides pressure letdown from sample line pressure to a lower vent pressure.
- Non Return Valve (NRV2):**  
Provides system protection from back pressure of vent gas when sample gas is not flowing.
- Bypass Flowmeter & Valve (FM2):**  
Allows the user to manually set and provide indication of the bypass gas flow rate across the membrane filter.
- Letdown Gas Vent Isolation Valve (BV3):**  
Allows the user to manually letdown the sample gas pressure trapped in the system for maintenance or servicing.

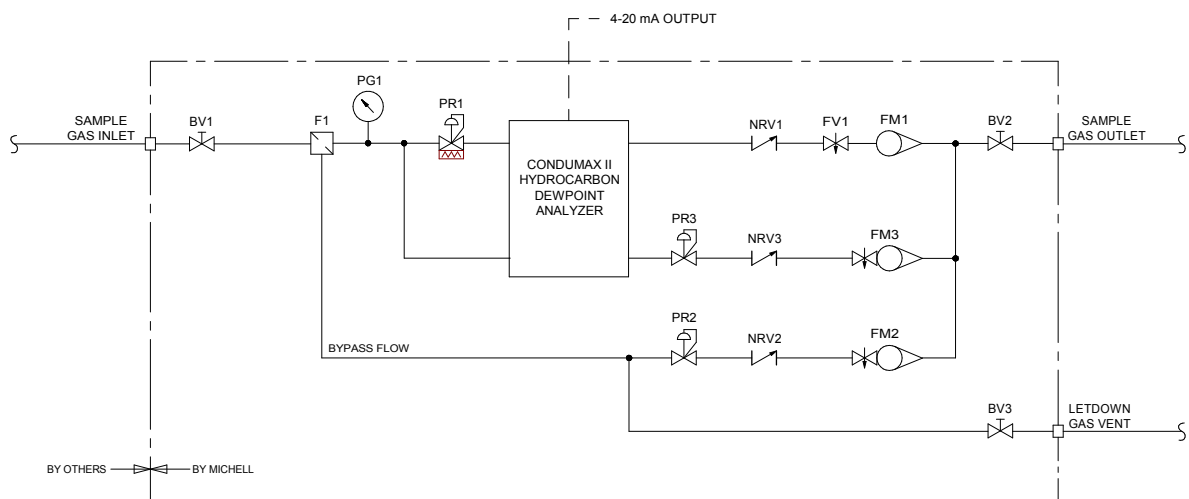

2 INSTALLATION

The Condumax II Hydrocarbon Dew-point Analyzer Sampling System gas handling components are assembled onto a stainless steel mounting plate suitable for wall mounting.

The indoor version Sampling System should be located in a constant temperature controlled environment of at least +10°C (+18°F) above the highest envisaged dewpoint temperature at a point as close to the sample gas take-off point as possible. This will minimize sample line response time lag in a designated IEC Zone 1 and Zone 2 hazardous area and NEC Class 1, Group B (for CSA Version Sampling System).

The outdoor version Sampling System provides environmental ingress protection to IP66

and should be mounted vertically, free of any appreciable vibration, in a permanently shaded position to prevent heating effects through sun radiation. The Sampling System enclosure has thermostatically controlled heating (fixed set point, optional adjustable). Enclosure cooling, using a compressed-air-driven vortex tube and adjustable thermostat, is recommended for installation in hot climates.

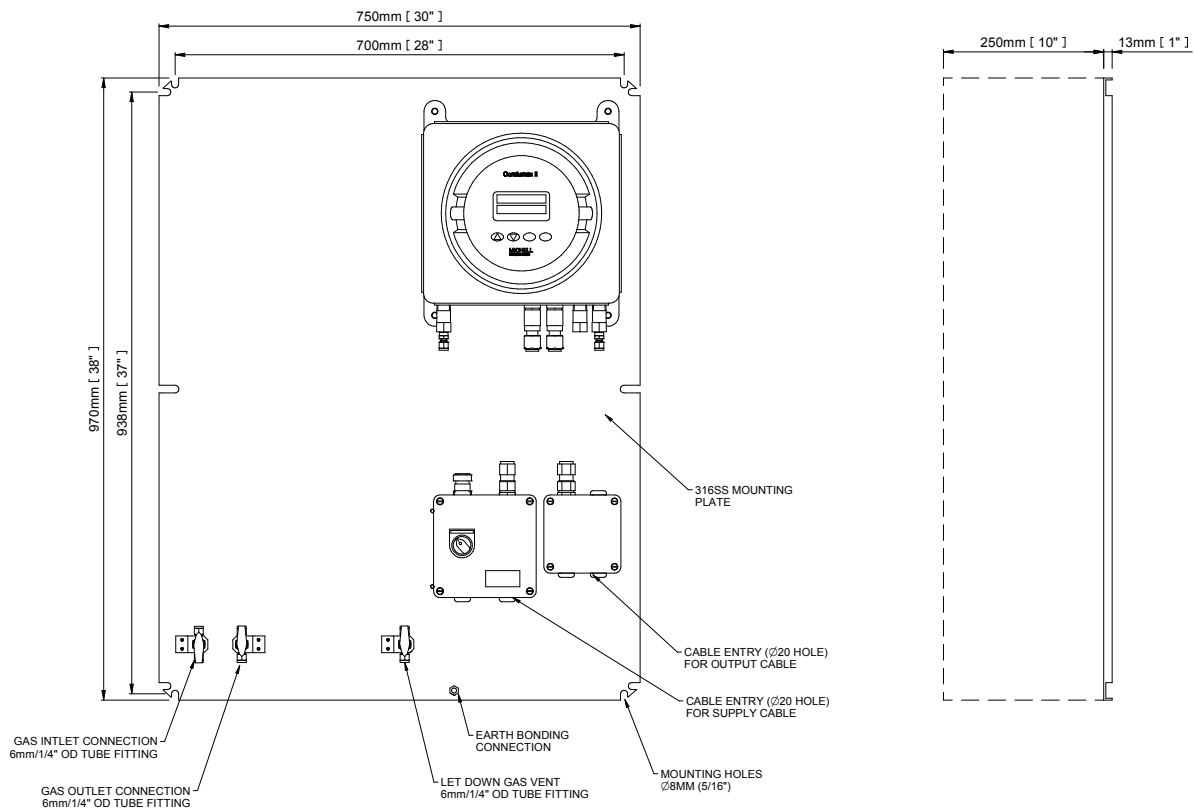

Figure 1 Condumax II Sampling System - Indoor Version

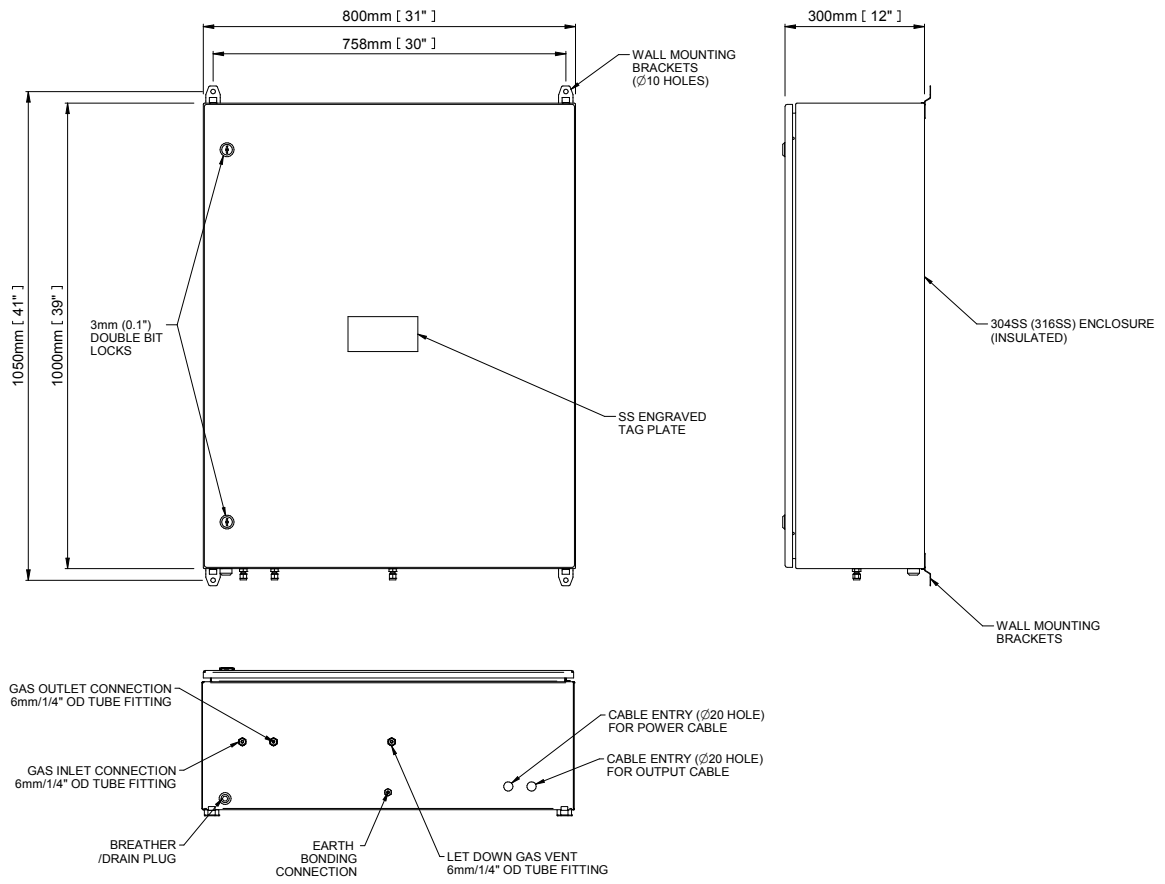

Figure 2 Condumax II Sampling System - Outdoor Version

## 2.1 Gas Connections



**Ensure that the process sample gas supply line is well flushed through to clear any liquids and debris present, prior to connection to the Sampling System.**

Connections are as follows:

### 1. Sample Gas Inlet

6mm OD or 1/4" OD Swagelok® tube fitting  
(100 barg (1450 psig) maximum supply pressure)

### 2. Sample Gas Outlet

6mm OD or 1/4" OD Swagelok® tube fitting  
(Vent to atmosphere/low pressure flare. 7 barg (101 psig) maximum back pressure)

### 3. Letdown Gas Vent

6mm OD or 1/4" OD Swagelok® tube fitting  
(Vent to atmosphere)

**NOTE: All tube fitting connections are made directly onto the isolation ball valves.**

## 2.2 Power Supply Connection

A single-phase AC mains power supply is required to operate the Sampling System.

The factory-set power supply voltage is indicated on a yellow label located on the rear panel. **NOTE: The user cannot change the specified power supply voltage.**

Cable connections are made onto terminals within the Power Circuits junction box. Cable entry into the junction box is provided through an EExe plastic cable gland.

Terminals are marked:

Terminal No.	Power Connection
1	Line Voltage
5	Neutral
	Earth

**NOTE: A ground/earth stud is provided in the base of the enclosure. This must be used to earth bond the Sampling System.**

A power isolator switch is provided on the Power Circuits junction box for local power isolation of the Condumax II Hydrocarbon Dew-Point Analyzer (Main Unit only) for maintenance or servicing. **NOTE: This switch only isolates power to the analyser NOT any other circuits.**

## 2.3 Output Wiring Connections

Two analog 4-20 mA outputs and a Modbus RS485 digital interface are available.

Cable connections are made onto terminals within the Outputs junction box. Cable entry into the junction box is provided through an EExe cable gland.

Terminals are marked:

### HC Dew-Point Version

Terminal No.	Output
1	Modbus RS485 digital comms Earth
2	Modbus RS485 digital comms A
3	Modbus RS485 digital comms B
4	Customer pair screen
5	Pressure measurement current - mA2
6	Pressure measurement current + mA2
7	Customer pair screen
8	Hydrocarbon dew-point measurement current - mA1
9	Hydrocarbon dew-point measurement current +mA1
10	Not used / spare
E	Earthing point

### HC and Water Dew-Point Version

Terminal No.	Output
1	Modbus RS485 digital comms Earth
2	Modbus RS485 digital comms A
3	Modbus RS485 digital comms B
4	Customer pair screen
5	Water dew-point measurement current - mA2
6	Water dew-point measurement current + mA2
7	Customer pair screen
8	Hydrocarbon dew-point measurement current - mA1
9	Hydrocarbon dew-point measurement current +mA1
10	Not used / spare
E	Earthing point

### 3 OPERATION

Operation of the Condumax II Sampling System should be carried out in conjunction with, and referring to, the Condumax II Hydrocarbon Dew-Point Analyzer User's Manual prior to commencing the System Start-Up Procedure (Section 3.1).

Before commencing the start-up procedure it is essential to ensure that the installation conforms to the correct hazardous area and local plant standards.

Before any gas pressure is applied, check that all gas inlet & outlet connections are fully tightened up and that all valves and regulators are in the closed position.

Additionally, for the outdoor version, the heater/thermostat circuit will need to achieve the set-point temperature.



**BEFORE power is applied to the Sampling System check that the Condumax II Power Isolator switch is set to the OFF position.**

Apply power to the Sampling System and allow the pressure regulator temperature to stabilize. This will prevent the possibility of condensation occurring within the gas handling components during start-up.

Check that all cables are according to certificated approved specifications and, as a minimum, are as described below:

Minimum Cable Requirements	
Power Cable	3 core, 0.75mm <sup>2</sup> conductor area (6A)
Communications Cable	For use with 4-20mA only or Modbus only 2 pair individually and overall screened, 0.5mm <sup>2</sup> conductors
Communications Cable	<b>For use with 4-20mA and Modbus</b> 4 pair individually and overall screened, 0.5mm <sup>2</sup> conductors



**There is a mandatory purge procedure stipulated as part of the certification of the Condumax II product. This procedure must be fully carried out prior to any power or signal connections to the Condumax II being energized.**

**This procedure must also be carried out at any time following service or maintenance periods that cause any of the Condumax II or associated gas handling equipment sample lines to be disconnected.**

**It is not necessary to carry out this procedure if, during a shut down period, the sample lines have not been disconnected or if the power or signal connections only have been disconnected.**

**Before commencement of the start-up procedure ensure that all power and signal connections to the Condumax II are fully isolated and if necessary observe the stipulated de-energization period of 45 minutes.**

### 3.1 System Start-Up Procedure

Proceed as follows:

1. Unscrew and remove the Condumax II flameproof enclosure cover after first loosening the hex grub screw.
2. The user interface/display assembly uses two ¼-turn bayonet style fasteners to secure it and are finger operated - clockwise to lock, counter-clockwise to release. Temporarily, the user interface/display once disconnected from the two ¼-turn fasteners, can be re-positioned on the instrument by securing the right-hand fastener in the left-hand fastener position. This will situate the user interface/display assembly in an overhanging position outside of the enclosure, allowing greater access. If there is insufficient space to accommodate the overhanging user interface/display assembly on the left-hand side then it can be fully disconnected from the instrument by disconnecting the ribbon cable connection to the main processor PCB.
3. Locate the solenoid valve and the manual override operating adjuster (brass screw handle) mounted on the base of the solenoid valve body.
4. Adjust the solenoid valve to the **PURGE POSITION** (fully screwed in clockwise) as shown on the label attached to the solenoid valve.
5. Ensure the Letdown Gas Vent Isolation Valve (BV3) is **CLOSED**.
6. **OPEN** the Gas Outlet Isolation Valve (BV2).
7. Slowly **OPEN** the Gas Inlet Isolation Valve (BV1) to allow sample gas to enter the Sampling System.
8. Fully **OPEN** the Bypass Flow Letdown Pressure Regulator (PR2).

9. Adjust the Bypass Flow Flowmeter/Metering Valve (FM2) to indicate a gas flow rate of approximately 0.4m<sup>3</sup>/hour (6.7 NI/min) (full-scale).
10. Slowly **OPEN** the HCdp Pressure Regulator (PR1) to provide a purge flow through the Condumax II (2 full turns).
11. Adjust the HCdp Flow Metering Valve (FV1) to indicate a sample gas flow rate of approximately 0.12m<sup>3</sup>/hour (2 NI/min) (full-scale) on the HCdp Flowmeter (FM1).
12. Fully **OPEN** the H<sub>2</sub>Odp Letdown Pressure Regulator (PR3) {if fitted}.
13. Adjust the H<sub>2</sub>Odp Flowmeter/Metering Valve (FM3) {if fitted} to indicate a sample gas flowrate of approximately 0.2 to 0.3m<sup>3</sup>/hour (3.3 to 5 NI/min) mid to three-quarters full scale).
14. Allow the sample gas to purge the system for a minimum period of 3 minutes.
15. Re-adjust the solenoid valve to the **Normal Operating Position** (fully unscrewed counter-clockwise) as shown on the label attached to the solenoid valve.
16. Re-fit the Condumax II user interface/display assembly and flameproof enclosure cover.
17. After the flameproof enclosure cover has been refitted the Condumax II is ready for power up.
18. Switch on the power to the Condumax II using the Condumax II Power Isolator switch located on the Power Circuits junction box.
19. Re-adjust the HCdp Pressure Regulator (PR1) to set the HCdp gas analysis pressure. Pressure is indicated on the main display of the Condumax II. It is normal practice for an analysis pressure of 391 psig (27 barg) to be set for the analysis of hydrocarbon dew point, as it is the recognized cricondentherm condition (pressure at which the highest hydrocarbon dew-point temperature will exist).

**NOTE: The water dew-point gas analysis pressure is set at full line pressure and has no adjustment.**

20. Re-adjust the hydrocarbon dew-point sample gas flow rate to approximately 0.06m<sup>3</sup>/hour (1 NI/min) using the HCdp Flow Metering Valve (FV1).
21. Re-adjust the water dew-point sample gas flowrate to approximately 0.2m<sup>3</sup>/hour (3.3 NI/min) using the H<sub>2</sub>Odp Flowmeter/Metering Valve (FM3) {if fitted}.
22. Re-adjust the bypass flow rate to approximately 0.4m<sup>3</sup>/hour (6.6 NI/min) using the Bypass Flow Flowmeter/Metering Valve (FM2).
23. Close the cabinet door and allow the temperature to stabilize for at least one hour before monitoring a measurement.

Refer to the Condumax II Hydrocarbon Dew-Point Analyzer User's Manual for further operating instructions.



### 3.2 System Shut-Down Procedure



**There is a mandatory de-energization time period of 45 minutes stipulated in the certification of the Condumax II product. This special condition must be fully carried out prior to removing the cover of the Condumax II flameproof enclosure.**

Proceed as follows:

1. Isolate the Sampling System from the sample gas supply line by **CLOSING** the Gas Inlet Isolation Valve (BV1).
2. Allow a short time for the Sampling System to vent/depressurize before attempting to carry out any work on the system.
3. Depressurize the Sampling System by **CLOSING** the Gas Outlet Isolation Valve (BV2) and **OPENING** the Letdown Gas Vent Isolation Valve (BV3).
4. Ensure the Condumax II Power Isolator switch is in the **OFF** position.
5. After power down a minimum period of 45 minutes must be observed before removing the cover of the Condumax II.

### 3.3 Pressure Regulator Temperature Control



**WARNING**

**This operation will expose electrical parts operating at high voltage. Therefore, isolate the power supply from the Sampling System before making adjustments.**

The heated pressure regulator contains an adjustment for the temperature control set point (factory-set to approximately +40°C (+104°F)). It may need adjustment to increase/decrease the heat requirements to the regulator dependent on the high/low inlet gas pressure. Two types of pressure regulator (marked with label **Pressure Regulator**) can be installed into the Sampling System, depending on the Hazardous Area protection method.

They can be identified by the manufacturer markings:

- |  |                        |
|--|------------------------|
| ATEX/IECEX version adjustable thermostat | Pressure Tech markings |
| CSA version                              | GO HPR-2 markings      |

**ATEX/IECEx Version only - Pressure Tech Regulator**

To adjust the setting, proceed as follows:

1. Unscrew and remove the cover of the terminal box after firstly loosening the hex grub screw.
2. Adjust the heater output by turning a potentiometer, clockwise to increase and anti-clockwise to decrease.
3. Due to the response time of heat transfer and thermal coefficients, the control system will require about 5 to 10 minutes to stabilise. Therefore, it is recommended that the heater is switched on before allowing the media to pass through the regulator.
4. The following percentage turns around the potentiometer equate to an approximate temperature value for the heater cartridges:

10%	+20°C (+68°F)	Recommended setting
25%	+60°C (+140°F)	Setting in exceptional circumstances advised by Michell Instruments, dependent upon application
50%	+100°C (+212°F)	Should not be set
75%	+140°C (+284°F)	
100%	+180°C (+356°F)	

5. Screw back the junction box cover and tighten the hex grub screw.

**CSA Version only - GO HPR-2 Pressure Regulator**

To adjust the setting proceed as follows:

1. Unscrew and remove the cover of the junction box after first loosening the hex grub screw.
2. Adjust the heater output by turning the potentiometer clockwise to increase and anti-clockwise to decrease.
3. The seven markings around the potentiometer equate to an approximate temperature value for the heater of:

1 = +75°F (+24°C)	Recommended setting
2 = +80°F (+27°C)	Other settings may be advised by Michell Instruments, dependent upon application
3 = +85°F (+29°C)	
4 = +95°F (+35°C)	
5 = +110°F (+43°C)	
6 = +130°F (+54°C)	Should not be set
7 = +175°F (+79°C)	

4. Screw back the junction box cover and tighten the hex grub screw.

## 4 OPTIONS

### 4.1 Enclosure Heater Temperature Control

Sampling systems can be fitted with temperature control, to maintain a constant temperature environment of at least 10°C (18°F) above the highest envisaged dew-point temperature, independent of surrounding temperature variations. The temperature control system, consists of a heater controlled by a fixed preset thermostat to provide internal ambient air temperature control of >+15°C (>+59°F) or >+35°C (>+95°F).

The temperature control system can be supplied with a heater controlled by an adjustable set-point thermostat. This achieves internal ambient air temperature control, enabling maintenance of more stable measurement conditions for installations in adverse climates. The adjustable thermostat is only available with ATEX/IECEx sampling systems.



**The thermostat setting should not be increased such that the internal temperature of the Sampling System rises above +60°C (+140°F) which is the maximum permitted ambient temperature (Tamb) of the certified Condumax II.**

#### **ATEX/IECEx Version only – Trafag adjustable thermostat:**

The capillary tube thermostat marked **Enclosure Heater Thermostat** contains an adjustment screw for the temperature control set point (factory-set to approximately +25°C (+77°F)) to maintain an ambient air temperature >+20°C (>+68°F).

To adjust the setting proceed as follows:



**This operation will expose electrical parts operating at high voltage. Therefore, isolate power supply from Sampling System and, if necessary, ascertain that no Explosive Gas Atmosphere is present before making adjustments.**

1. Unscrew and remove the cover of the thermostat box.
2. Turn the adjustment screw pointer, located inside, clockwise to increase and anti-clockwise to decrease the temperature set point.
3. The temperature markings around the adjustment screw pointer equate to the approximate temperature values for the heater of 0 to +60°C (+32 to +140°F).
4. After adjustment is complete replace the cover of the thermostat box.

## 4.2 Enclosure Cooling

A sampling system enclosure cooling kit can be fitted to the stainless steel enclosure. The cooling device is a Vortex tube driven by instrument grade (liquid and particulate-free) compressed air. A fixed thermostat to maintain an internal ambient  $<+40^{\circ}\text{C}$  ( $104^{\circ}\text{F}$ ) or an adjustable thermostat (factory set at approximately  $+35^{\circ}\text{C}$  ( $+95^{\circ}\text{F}$ )) can be selected. The adjustable thermostat is only available with ATEX/IECEX sampling systems. The thermostat controls a solenoid valve permitting the flow of compressed air through the Vortex tube. A manifold (clear plastic pipe) positioned around the internal walls of the enclosure distributes the cooling air throughout.

### **ATEX/IECEX Version only – Trafag adjustable thermostat:**

The capillary tube thermostat marked **Enclosure Cooling Thermostat** contains an adjustment screw for the temperature control set point (factory-set to approximately  $+35^{\circ}\text{C}$  ( $+95^{\circ}\text{F}$ )) to maintain an ambient air temperature  $>+20^{\circ}\text{C}$  ( $>+68^{\circ}\text{F}$ ).

To adjust the setting proceed as follows:



**This operation will expose electrical parts operating at high voltage. Therefore, isolate power supply from Sampling System and, if necessary, ascertain that no explosive gas atmosphere is present before making adjustments.**

1. Unscrew and remove the cover of the thermostat box.
2. Turn the adjustment screw pointer, located inside, clockwise to increase and anti-clockwise to decrease the temperature set point.
3. The temperature markings around the adjustment screw pointer equate to the approximate temperature values for the heater of  $0$  to  $+60^{\circ}\text{C}$  ( $+32$  to  $+140^{\circ}\text{F}$ ).
4. After adjustment is complete replace the cover of the thermostat box.

### 4.3 Trace Heated Sample Line

As an option, a trace heated sample line can be supplied with the Sampling System. This ensures that the sample gas temperature from the process take-off point to the analyzer is maintained at a constant temperature, independent of surrounding temperature variations.

The trace heated tubing bundle consists of ¼" OD 316L stainless steel seamless tube and BSX™ self-regulating heating cable with non-hygroscopic glass fiber insulation and polymer outer jacket.

The self-regulating heat output of BSX™ cable varies in response to the surrounding conditions along the entire length of a circuit. Whenever the heat loss increases (as the ambient temperature drops), the heat output of the cable increases. Conversely when the heat loss decreases (as the ambient temperature rises), the cable reacts by reducing its heat output.

Operation of the trace heated sample line is fully automatic. Once a mains power supply is provided then no further adjustment is required.

The trace heated sample line is connected directly onto the **Gas Inlet Isolation Valve** (via the bulkhead entry seal gland, when fitted to an enclosure) within the Sampling System and the heating cable is terminated onto terminals within the Power Circuits junction box. Cable entry into the junction box is via an ISO M20 thread of an EExe cable gland.

Terminals are marked:	2	Line Voltage	(either conductor – no polarity)
	6	Neutral	(either conductor – no polarity)
	⊥	Earth	(green/yellow conductor)

## 5 MEMBRANE AND PARTICULATE FILTER ELEMENT REPLACEMENT

### 5.1 Service Intervals

The life expectancy of the filter elements is dependent upon operating conditions in each specific application. As a minimum it is recommended that the filter elements be changed every 12 months. If inspection of the removed element shows that it is in poor/good condition after 12 months of operation then the operating period between replacements may be reduced/increased accordingly.

The disposable microfiber filter elements cannot be cleaned as the solids are trapped within the depth of the element not on the surface. Also ensure that all O-rings are changed at regular intervals, preferably at the same time as the filter elements.

### 5.2 Installing the Filter Element and Membrane



#### Warning

**The filter housing is a pressure vessel; it must never be used above its stated maximum allowable working pressure and must be used within its stated temperature range. Ensure that these items are used in well-designed piping systems with suitable indicators to warn users and servicing personnel of the presence of pressure and high temperatures. Wherever possible use pressure limiting or safety devices. Remember that the pressure rating is reduced at high temperatures. Consult Michell Instruments for guidance.**

**It is the responsibility of the user to ensure that the materials of construction of the filter housing, gasket and filter media are suitable for the intended application. During every servicing, a visual inspection must be made of the surfaces of the housing for signs of corrosion, erosion or general wear. The housing must be removed from service if any of these signs are evident as there are no corrosion allowances used in the design of these filters. It is not recommended that these filters be used on unstable fluids.**

The following items have not been taken into account during the design of the filter housing:

1. Static pressure and mass of contents.
2. Traffic, wind and earthquake loading.
3. Reaction forces and moments resulting from mounting.
4. Corrosion, erosion and fatigue.
5. Decomposition of unstable fluids.
6. External fire.

### **Installing the Filter Housing**

As the filter housing is a pressure vessel the system connections and accessory outlets must be leak tight. It is good practice to use a pipe sealant on the fittings prior to connecting to the filter housing ports. This will allow disassembly at a later time, if required. Any sealant such as PTFE tape, paste or other compound may be used if compatible with the filtered media. The torque value of the fittings will depend upon the quality of the fittings and the type of sealant used but should typically be between 40Nm and 75Nm. Ensure the fittings get inspected during servicing and re-tightened if necessary. It is not recommended that heads and bowls from different filter assemblies are swapped.

When installing filter housing and elements care should be taken to ensure the head and bowls are kept as a pair. It is not recommended that heads and bowls from different filter assemblies be swapped.

Wherever possible, installation of filter housings should be made using an appropriate mounting bracket to avoid excessive loads on the piping.

### **Changing the Filter Element**

Ensure there is no pressure in the housing. Remove the bowl, element retainer and filter element.

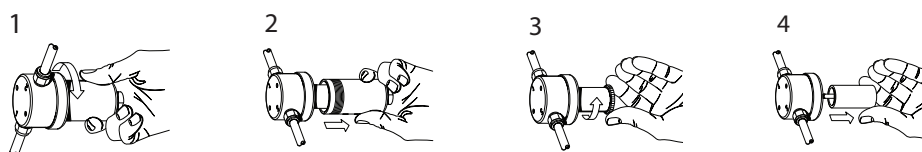

The disposable coalescing filter element is sealed by compression against a flat surface. Gaskets are not required between the filter element and components of the housing. The element is located by guides which fit the inside diameter of the tube at each end. The element is sealed by tightening a threaded element retainer.

Before replacing the housing bowl ensure that the mating threads and sealing faces are clean and damage free. It is recommended that the threads and sealing faces are lubricated with a small amount of silicone grease before assembly. In the case of 'S' type stainless steel housings fitted with a solid PTFE gasket the bowl should be tightened to a torque of between 30Nm and 40Nm.

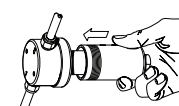

### **Membrane Replacement**

The membrane is held in place by the O-ring. The whole membrane holder unit comes free from the housing leaving the filter housing /body still intact with the process lines with no need to loosen connections. The membrane can then be replaced on a work bench using a round nose pair of tweezers - the old O-ring is removed with the old membrane. The sintered disc should be removed and cleaned or replaced. Drag a new membrane over the sintered disc carefully as not to cause damage, until centralized over the sintered disc and O-ring groove. Place the new O-ring over/around the new membrane and gently push into the O-ring groove. Replace the coalescing filter element where applicable with a new element and screw/locate the whole membrane holder back into the filter housing/body. The inlet is stamped no.1 and the outlet is stamped no.2, the other two ports are drain ports. Both can be used or one drain may be blanked off with a plug.

### **Service Intervals**

A disposable microfiber filter element continues to filter at its original efficiency as long as it is kept in service. The life of the element is determined by the increase in flow resistance caused by trapped solids in the element. The element should be changed when the flow falls below an acceptable level, or the pressure drop becomes too high. In any case the element should be replaced before the pressure drop across it reaches 0.7 bar. The disposable microfiber filter elements cannot be cleaned as the solids are trapped within the depth of the element, not on the surface.

Ensure that gaskets are changed at suitable intervals. The interval time will depend on service and operating conditions, but it should be at least every three months.



# Appendix A

## Technical Specifications

## Appendix A Technical Specifications

<b>General</b>	
Gas Wetted Materials	316L stainless steel with Viton® soft parts
Sample Gas	Hydrocarbon/Natural Gas
Sample Gas Pressure	10 to 100 barg (145 to 1450 psig)
Sample Gas Flow rate	HCdp range = 0.02 to 0.13 m <sup>3</sup> /hour (0.3 to 2.2 NI/min) (nominal setting = 0.06 m <sup>3</sup> /hour (1 NI/min)) H <sub>2</sub> dp range = 0.04 to 0.4 m <sup>3</sup> /hour (0.6 to 6.6 NI/min) (nominal setting = 0.2 m <sup>3</sup> /hour (3.3 NI/min))
Bypass Gas Flow Rate	Range = 0.04 to 0.4 m <sup>3</sup> /hour (0.6 to 6.6 NI/min) (nominal setting = 0.2 m <sup>3</sup> /hour (3.3 NI/min))
Filters	Coalescing & membrane filter
Enclosure	304/316 stainless steel fitted with wall-mounting brackets (Ingress protection rated to IP66)
Sample Gas Connections	¼" or 6mm OD Swagelok® twin ferrule tube fittings
Cable Entries	ø20mm clearance holes in bottom face of enclosure ISO M20 thread in junction box
Power Supply	110 to 120 V AC 60 Hz or 220 to 240 V AC 50 Hz
Power Consumption	400 W max
Operating Temperature	-20 to +60°C (-4 to +140°F) <95%RH (+40°C (+104°F) max continuous operation)
Weight	75Kg (165lbs) max
<b>Optional</b>	
Enclosure Cooling (Optional)	Compressed air via Vortex tube controlled by fixed or adjustable set-point thermostat (adjustable thermostat ATEX/IECEX only). Maximum cooling capacity = 410W @ internal temp of +35°C (+95°F) and external temp of +55°C (+131°F) with maximum air input temp of +40°C (+104°F)
Trace Heated Sample Line (Optional)	¼" OD 316L stainless steel seamless tube and self-regulating heating cable (15 Watt/meter) with non-hygroscopic glass fiber insulation and polymer outer jacket
Enclosure Heating	120 W heater with fixed preset +20°C or +40°C set-point thermostat (Optional: 0 to +60°C (+32 to +140°F) adjustable set-point thermostat available ATEX/IECEX only)

# Appendix B

## Quality, Recycling & Warranty Information

## Appendix B      Quality, Recycling, Compliance & Warranty Information

Michell Instruments is dedicated to complying to all relevant legislation and directives. Full information can be found on our website at:

**[www.michell.com/compliance](http://www.michell.com/compliance)**

This page contains information on the following directives:

- ATEX Directive
- Calibration Facilities
- Conflict Minerals
- FCC Statement
- Manufacturing Quality
- Modern Slavery Statement
- Pressure Equipment Directive
- REACH
- RoHS2
- WEEE2
- Recycling Policy
- Warranty and Returns

This information is also available in PDF format.

# Appendix C

## Return Document & Decontamination Declaration

Appendix C Return Document & Decontamination Declaration

**Decontamination Certificate**

**IMPORTANT NOTE: Please complete this form prior to this instrument, or any components, leaving your site and being returned to us, or, where applicable, prior to any work being carried out by a Michell engineer at your site.**

Instrument			Serial Number	
Warranty Repair?	YES	NO	Original PO #	
Company Name			Contact Name	
Address				
Telephone #			E-mail address	
Reason for Return /Description of Fault:				
Has this equipment been exposed (internally or externally) to any of the following? Please circle (YES/NO) as applicable and provide details below				
Biohazards			YES	NO
Biological agents			YES	NO
Hazardous chemicals			YES	NO
Radioactive substances			YES	NO
Other hazards			YES	NO
Please provide details of any hazardous materials used with this equipment as indicated above (use continuation sheet if necessary)				
Your method of cleaning/decontamination				
Has the equipment been cleaned and decontaminated?			YES	NOT NECESSARY
Michell Instruments will not accept instruments that have been exposed to toxins, radio-activity or bio-hazardous materials. For most applications involving solvents, acidic, basic, flammable or toxic gases a simple purge with dry gas (dew point <-30°C) over 24 hours should be sufficient to decontaminate the unit prior to return. <b>Work will not be carried out on any unit that does not have a completed decontamination declaration.</b>				
<b>Decontamination Declaration</b>				
I declare that the information above is true and complete to the best of my knowledge, and it is safe for Michell personnel to service or repair the returned instrument.				
Name (Print)			Position	
Signature			Date	



**NOTES:**

**NOTES:**





<http://www.michell.com>