

TP-L SERIES

Thermal Imaging Sensor



TP-L series is a compact infrared thermal imaging sensor utilizing a thermopile array detector.

This CHINO developed detector allows the sensor to measure real time temperature.

Ethernet / USB connectivity allows the sensor to communicate with PC running CHINO Imaging Software.



FEATURES

- Easy to Use and Implement
- 2000 pixel Resolution
- Built-In Alarms
- IP65 / NEMA4

MODEL

Low-temp type (-20 to 300°C)

TP-L02□□□N

- Viewable Angle
25 : 25°x 25°
60 : 60°x 60°
- Communications Interface
E : Ethernet
U : USB

High-temp type (100 to 800°C)

TP-L0225EK

- Viewable Angle
25 : 25°x 25°
- Communications Interface
E : Ethernet

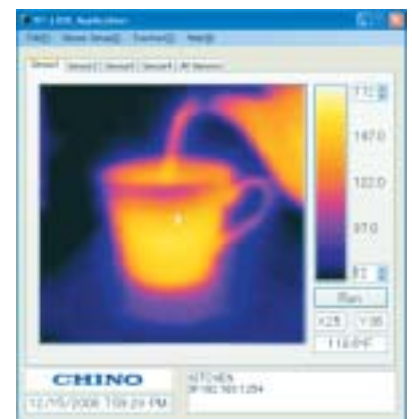
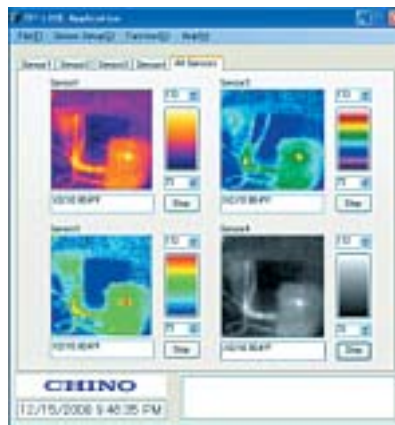

SPECIFICATIONS

Temp Range:	Low-temp type -20 to 300°C High-temp type 100 to 800°C
Resolution:	0.5°C (At black body temperature of 100°C)
Accuracy:	Low-temp type ±2% of reading or ±3°C whichever larger High-temp type ±1% of reading or ±3°C whichever larger (At Ambient temp of 25°C ±2°C)
Detector:	Thermopile array Approx.2000 Pixel
Wavelength:	Center wavelength 10μm
Viewable Angle:	Low-temp type 60°x 60°, 25°x 25° High-temp type 25°x 25°
Radius Resolution:	60°x 60° — 21.8mrad 25°x 25° — 9.1mrad
Frame Speed:	Ethernet — 3Hz (1Hz for alarm output) USB — 0.5Hz
Focus:	Fixed focus
Emissivity:	0.10 to 1.00

Communications Interface:	Ethernet — 10BASE-T/100BASE-TX USB — USB2.0
Alarm:	2 points(Non voltage contact output)
Power Supply:	12 to 24V DC
Power Consumption:	Ethernet — Max 2.5VA (At 12V DC) USB — Max 1VA (At 12V DC)
Inrush Current*1:	Max 1.3A (At 12V DC)
Working Temp:	-10 to 50°C
Working RH:	10 to 80%RH (No dew condensation)
Casing:	Polycarbonate (Color: Black)
Weight:	Approx. 150g (sensor only)
Protection:	IP65 (w/ provided exclusive cable and tripod screw)
Standards:	CE (EN61326 Annex A)



*1 The inrush current should be considered for the selection of power source.

FUNCTIONS

Monitoring mode (with exclusive viewer software)

The temperature data is outputted continuously by a command from the PC.

Capturing mode (without using exclusive viewer software)

The temperature data is outputted row-by-row horizontally by a command from PLC, etc.

CONNECTIVITY

Viewer Software allows you monitor thermal images, measuring temperature and alarms.

Monitoring Mode

Single unit usage

- Single unit can monitor 1 area and has 2 alarm outputs.
- When alarm goes on, the unit stores 1 image to the memory.
- Image saving updates every occurrence of alarm.
- Reading the data from host PC is possible.

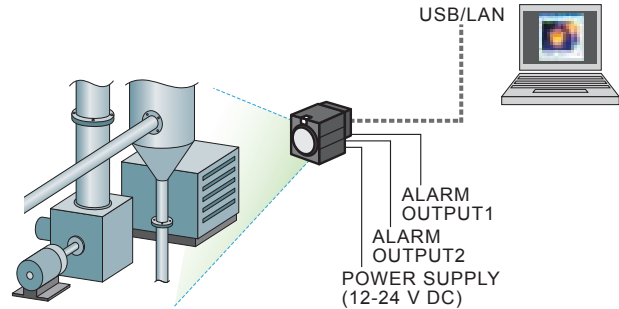

Multiple unit connection (LAN)

- Up to 4 sensors can be connected
- Monitoring and alarm outputs from sensor can be used together.

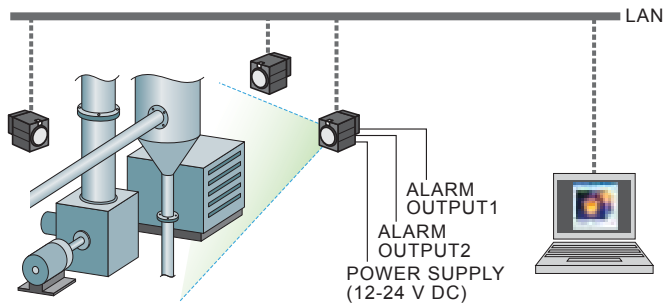

Capturing Mode

PLC connection

- The temperature data is outputted row-by-row horizontally by a command from PLC, etc.

 When the capture mode is used, acquisition of command is required. For the acquisition of command, contact your nearest distributor.

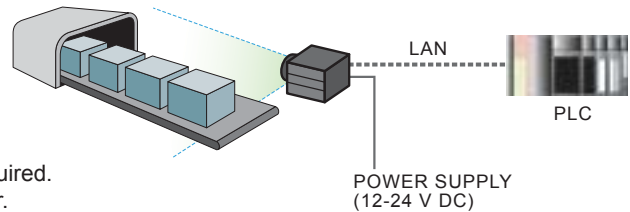

MEASURING SPOT SIZE AND DISTANCE

Viewable Angle 60° x 60°

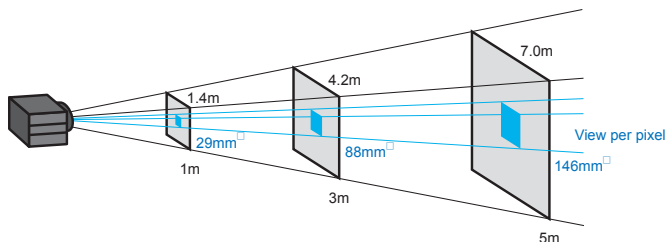

D	1m	3m	5m
Width (m)	1.4	4.2	7.0
Width/Pix (mm)	29	88	146

Viewable Angle 25° x 25°

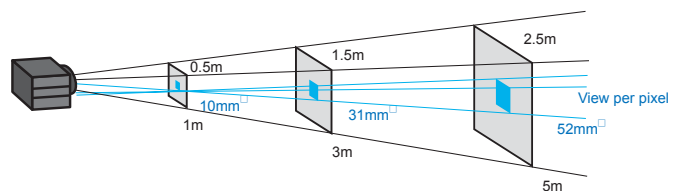

D	1m	3m	5m
Width (m)	0.5	1.5	2.5
Width/Pix (mm)	10	31	52

APPLICATION SOFTWARE

Requirements

- OS : Windows 2000 (SP4 or later)/XP/Vista (Windows XP or later recommended)
* NET Framework 2.0 or later (required)
- Memory : Windows 2000/XP.....1GB recommended (512MB or more)
: Windows Vista.....2GB or more recommended
- CPU : Windows 2000/XP.....1.5GHz or faster recommended
: Windows Vista.....2GHz or faster recommended

* "Microsoft" and "Windows" are either trademarks or registered trademarks of Microsoft Corporation, USA.

* "Intel" and "Pentium" are either trademarks or registered trademarks of Intel Corporation, USA.

Provided application software

Various functions of data storage, image processing, trend graph, alarm settings, etc.

Via LAN up to 4 sensors can be connected to a PC.

Via USB 1 sensor can be connected to a PC.

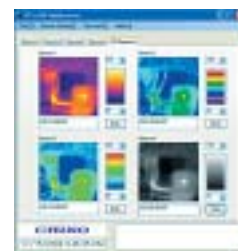

Various settings of sensor

LAN settings / Alarm settings of the sensors / Emissivity setting

Data storage

Image temperature data storage (temperature data/csv for 2000 pixels) / Thermal image screen storage (JPEG)

Image processing

Screen averaging / Spatial smoothing / Median filter / Rotation / Maximum & Minimum values indications

Trend graph

By specifying a graph area, data can be displayed by the trend graph and the graph data can be stored by setting. (Max. 8 areas)

Alarm settings by the application software

By specifying a graph area, alarms can be set. (Max. 8 areas)
Separately from the alarm settings of the sensor, the alarm screening by the application software can be performed. (Max. 8 areas)



Trend graph

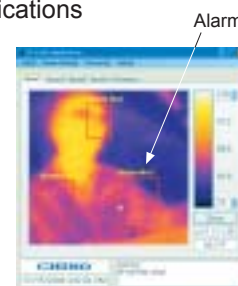

Alarm screening

Multipoint connection software (OPTIONAL)

Email notification at the occurrence of alarm.

Via LAN up to 32 sensors can be connected to a PC

*Ethernet application only



The alarm of the sensor is interlocked with the contact output, but the contact output cannot be activated with the alarm by the application software.

STANDARD CONFIGURATION

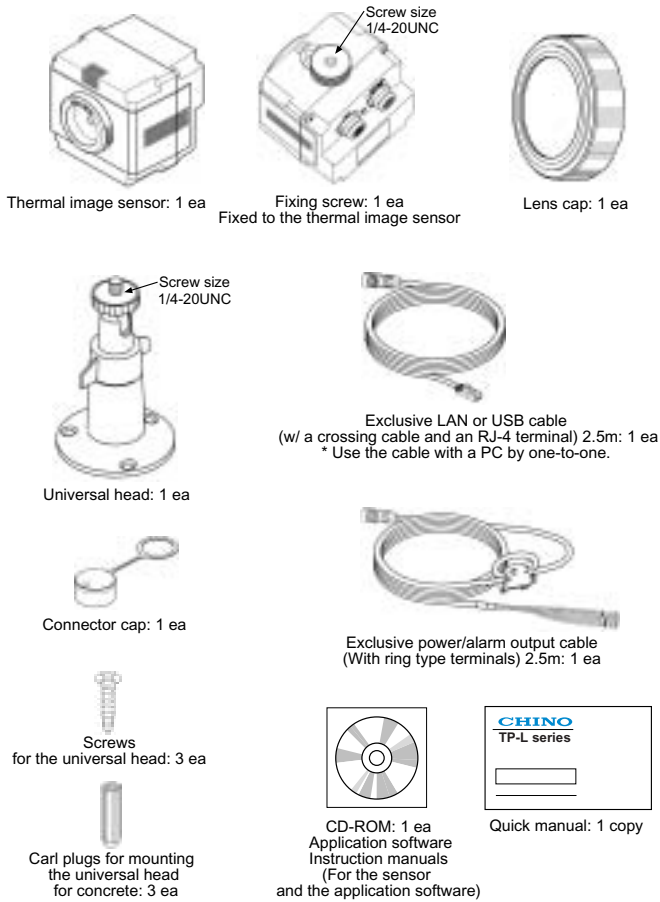

**AIR PURGE CASE (OPTIONAL)
MODEL : TP-ZCC1**

The air purge case is used to disperse dust and fume for keeping the light path.



CONNECTION

Example of contact output circuit

! Use the contact output with a protection element for preventing malfunction.

Alarm 1, In case of AC

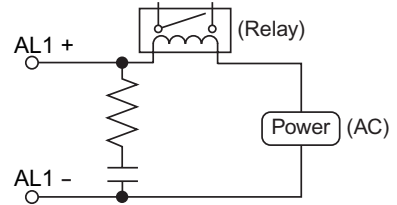

Alarm 1, In case of DC

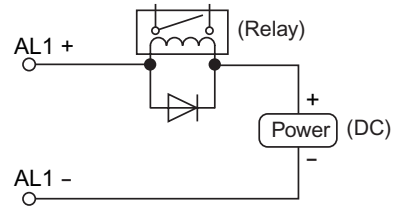

Details of exclusive power/alarm output cable Ring terminal 0.5-3

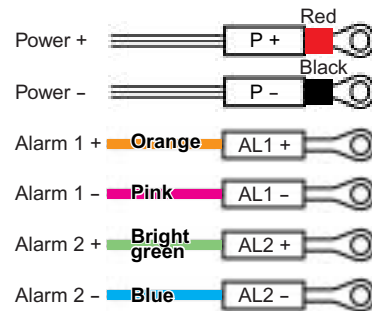

DIMENSIONS

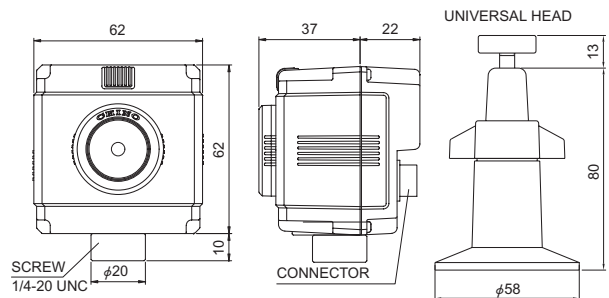

PRECAUTIONS

This product contains an item under export control. Therefore, delivery is subject to necessary export licenses by the Ministry of Economy, Trade and Industry (METI) in Japan. It is strictly regulated to export the product to certain area. In case of retransfer, resale and/ or reexport of the product, prior authorization by the METI is required.

Specifications subject to change without notice. Printed in Japan (I) 2010. 8

CHINO CORPORATION

32-8 KUMANO-CHO, ITABASHI-KU, TOKYO 173-8632
 Telephone : +81-3-3956-2171
 Facsimile : +81-3-3956-0915
 E-mail : inter@chino.co.jp
 Website : http://www.chino.co.jp/